

SmallRig

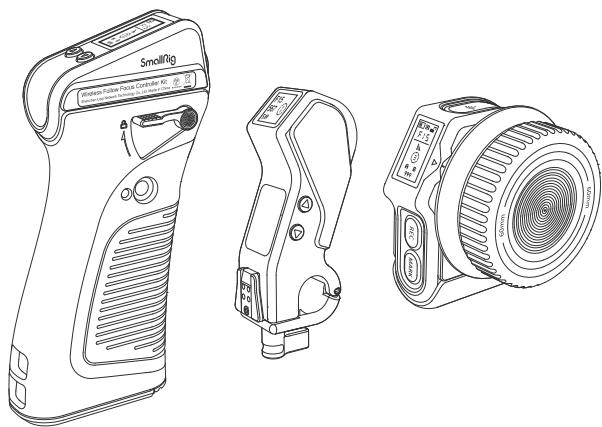

MagicFIZ Wireless Follow Focus System

- User Manual -

In order to ensure user's safety and prevent the product damages caused by any improper use, please carefully read the "Warnings" below and properly keep this User Manual for future reference.

Foreword

Thank you for purchasing SmallRig's product.

Warnings

- Please read this User Manual carefully.
- Do not use the product in water because it is not dust or water proof.
- Do not let the product fall to the ground, be hit or suffer violent impact.
- Never remove the non-detachable lithium battery without permission.
- Since there are some hazardous substances in the battery, please do not discard it. Instead, dispose of the product that is damaged or will never be used according to the waste management measures.
- When the battery is not in use for a long time, please charge and discharge the battery each 6-month, and provide it with approximately 60% of the electric quantity to prolong its use life.



Please do not disassemble the product or change its battery. If you have any question, please contact the seller to apply after-sales service.

Intended Use

- Please read this User Manual carefully, especially the "Warnings".
- Please use or store the product in the environment mentioned herein.
- It will be regarded as an improper use when the users are not correctly follow the user manual or use the product under the specific working condition.

Kits and Accessories

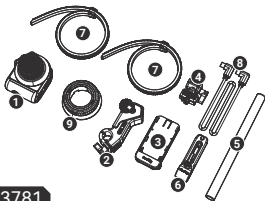

ID: 3781

MagicFIZ Wireless Follow Focus Basic Kit

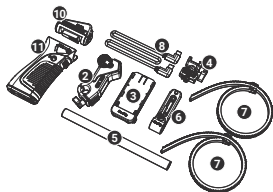

ID: 3782

MagicFIZ Wireless Follow Focus Handgrip Kit

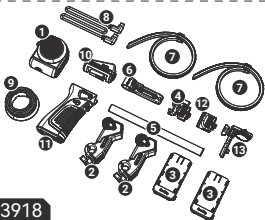

ID: 3918

MagicFIZ Wireless Follow Focus Two Motor Kit

ID: 4091

Follow Focus Marking Disk (Wooden)



ID: 3266

USB-C to D-Tap Cable



ID: 3268

USB-C to DC Cable



In the Box

ID: 3781

1 Wireless Handwheel Controller	× 1
2 Wireless Receiver Motor	× 1
3 Battery Plate	× 1
4 Handgrip Adapter	× 1
5 Φ 15mm Rod	× 1
6 Rod Clamp with NATO Rail	× 1
7 Snap-on Follow Focus Gear Ring	× 2
8 USB-C to USB-C Cable	× 1
9 Follow Focus Marking Disk (Silicone)	× 1
Spanner	× 1
User Manual	× 1
Carrying Bag	× 1

ID: 3782

10 Electronic Controller Module	× 1
2 Wireless Receiver Motor	× 1
11 Wireless Handgrip	× 1
3 Battery Plate	× 1
4 Handgrip Adapter	× 1
5 Φ 15mm Rod	× 1
6 Rod Clamp with NATO Rail	× 1
7 Snap-on Follow Focus Gear Ring	× 2
8 USB-C to USB-C Cable	× 1
Spanner	× 1
User Manual	× 1
Carrying Bag	× 1

ID: 3918

1 Wireless Handwheel Controller	× 1
11 Wireless Handgrip	× 1
10 Electronic Controller Module	× 1
2 Wireless Receiver Motor	× 2
3 Battery Plate	× 2
4 Handgrip Adapter	× 1
12 Shoulder Rig Adapter	× 1
13 Monitor Adapter	× 1
5 Φ 15mm Rod	× 1
6 Rod Clamp with NATO Rail	× 1
7 Snap-on Follow Focus Gear Ring	× 2
8 USB-C to USB-C Cable	× 1
9 Follow Focus Marking Disk (Silicone)	× 1
Spanner	× 1
User Manual	× 1
Carrying Bag	× 1

Product Function Description

1. Wireless Handwheel Controller

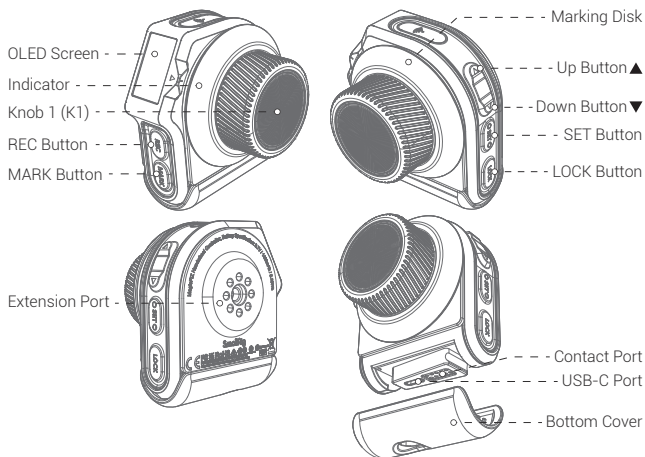

REC Button: 1. REC Recording ON / OFF Function; 2. Machine ON / OFF Function.

MARK Button: 1. A-B Marks; 2. Automatic Lens Calibration.

Up / Down Button: 1. Channel Adjustment; 2. Motor Number Adjustment; 3. Page Up / Page Down.

SET Button: 1. Press and hold the button to enter or exit the current option;

2. Click the button to activate or confirm the current option.

LOCK Button: For preventing misoperation; turn on/off the switch by double click.

Knob 1 (K1): Fine control of Wireless Receiver Motor.

Indicator: Six color display, including red - green - blue - yellow - pink - white.

USB-C Port: Charging and wired communication port.

Contact Port: Charging and communication port.

Extension Port: 1/4"-20 threaded hole.

Marking Disk: Replaceable.

2. Wireless Handgrip

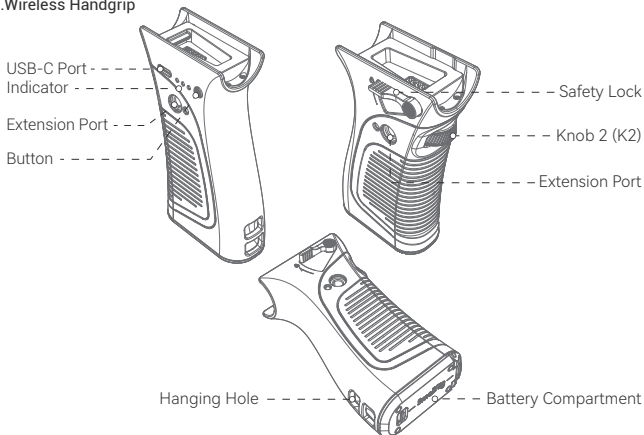

USB-C Port:

1. Charging and discharging; 2. Communication.

Indicator:

Battery level and status display.

Button:

Click to show current battery level.

Safety Lock: For preventing accidental falling off.

Knob2 (K2):

Control Wireless Receiver Motor.

Extension Port:

For connecting with external accessories.

Battery Compartment:

Suitable for LP-E6 battery.

Hanging Hole: For assembling lanyard.

3. Wireless Follow Focus Controller Kit

(Combination of Wireless Handgrip + Electronic Controller Module)

REC Button:

1. REC Recording ON / OFF Function;
2. Machine ON / OFF Function;
3. Confirm.

Up / Down Button:

1. Channel Adjustment;
2. Motor Number Adjustment;
3. Page Up / Page Down.

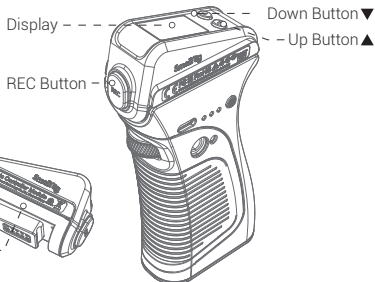

Electronic Controller Module - - - - -

* The Electronic Controller Module can be used only with the Wireless Handgrip.

4. Wireless Receiver Motor

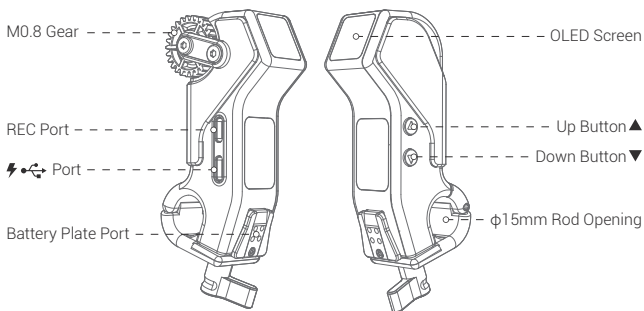

Up / Down Button: 1. Channel Adjustment; 2. Motor Number Adjustment.

REC Port: Connect the camera REC port for wired control.

⚡ Port: Power supply and communication Port.

Battery Plate Port: Used with Battery Plate (ID: 3777), compatible with NP-F batteries.

Instruction of Product Installation and Power Supply

1. Installation Guide for Wireless Receiver Motor

Install the Wireless Receiver Motor on the camera side by use of the included accessories.

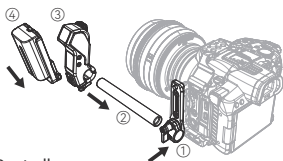

2. Installation Guide for Wireless Handwheel Controller

2.1 Install the Wireless Handwheel Controller on the camera side by use of the Handgrip Adapter via 1/4"-20 threaded hole.

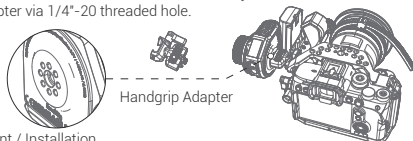

2.2 Marking Disk Replacement / Installation.

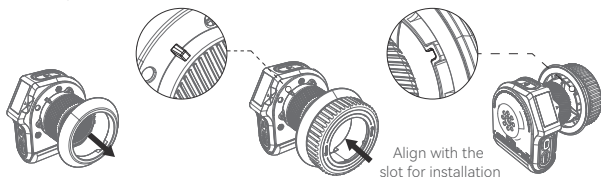

3. Installation Guide for Wireless Handgrip

3.1 Combined Installation of Electronic Controller Module, Wireless Handwheel Controller, and Wireless Handgrip.

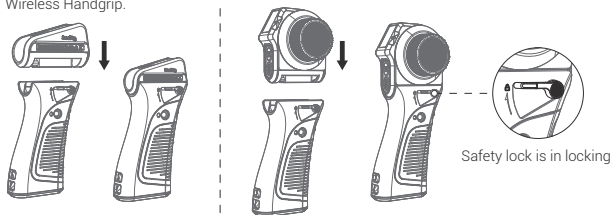

3.2 The Wireless Handgrip is suitable for both left and right hands.



3.3 Installation Guide for Shoulder Rig Adapter, VCT-14 Extension Arm, and ARRI Rosette

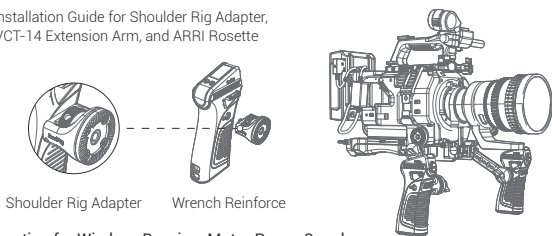

4. Instruction for Wireless Receiver Motor Power Supply

4.1 Use the USB-C to D-Tap Cable (ID: 3266) or USB-C to DC Cable (ID: 3268) to connect the V-mount battery for powering the Wireless Receiver Motor

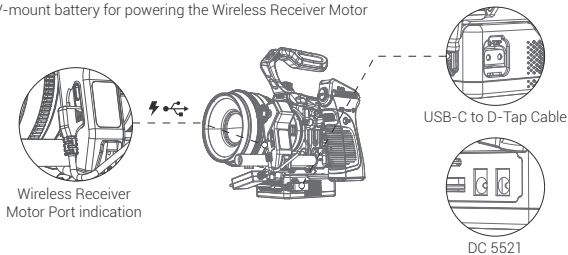

4.2 Use the standard USB-C to USB-C cable to connect the Wireless Handgrip for powering the Wireless Receiver Motor, achieving the cabled control.

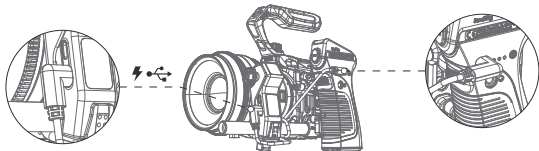

Wireless Receiver Motor
Port indication

Wired control and power
supply of the Wireless Handgrip

4.3 Power the Wireless Receiver Motor through the Battery Plate.

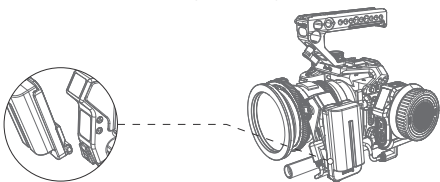

Powered by the Battery Plate
Compatible with NP-F batteries



Wired Control of the
Wireless Handwheel Controller

5. Instruction for REC Wiring

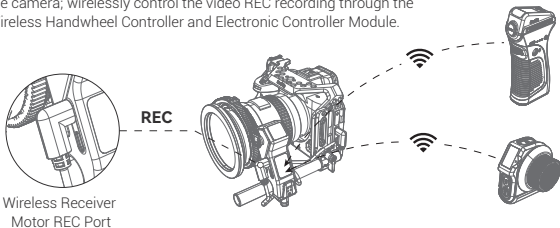
5.1 Connect one end of the control cable with the Wireless Receiver Motor and the other end with the camera; wirelessly control the video REC recording through the Wireless Handwheel Controller and Electronic Controller Module.



Wireless Receiver
Motor REC Port

Sony	FUJIFILM	Panasonic	Z CAM
 ID: 2971	 ID: 2970	 ID: 3325	
A7, A7R, A7S, A7II, A7RII, A7SII, A7SIII, FX3, A7III, A7RIII, A7 IV, A7R IV, A9, A9 II, A5100, A6000, A6100, A6300, A6400, A6500, A6600, RX100 III, RX100IV, RX100V, RX100 VI, RX100 VII	X-T3, X-T4, X-T20, X-T30	S5, S1, S1R, S1H, BS1H, GH4, GH5, GH5S, GH6, G9, G95	E2, M4, S6 BGH1 (Panasonic)

5.2 Directly connect the Wireless Handwheel Controller and Electronic Controller Module with the camera BLE to wirelessly control the REC recording.

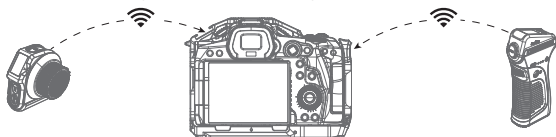

Sony	Canon	Nikon
A7C, A7RIII, A7RIV, A7 IV, FX3, A7SIII, A9, A9 II, RX100 VII, DSC-RX100M7, A6100, A6400, A6600, ZV1, ZV-E10	EOS 90D, EOS M6 Mark II, EOS M50, EOS R, EOS R5, EOS RP, G7X Mark III	Z50

Interface Instruction

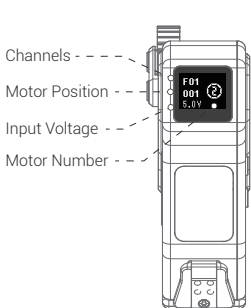

Instruction of Motor Interface

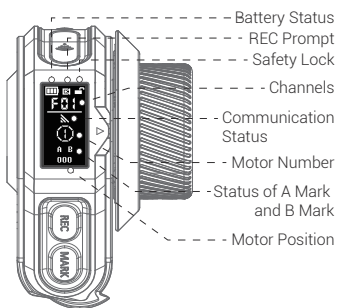

Instruction for Wireless Handwheel Controller Interface (single control)

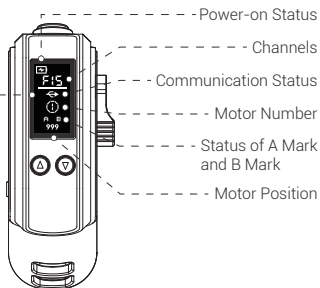
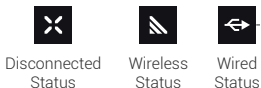

Instruction for Electronic Controller Module Interface

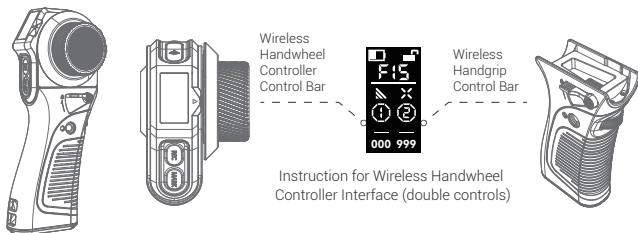

Basic Operation

1. ON / OFF Operation

Press and hold the UP / DOWN button to turn on the machine; press both buttons simultaneously to turn off the machine.

Press and hold the **REC** button to turn ON / OFF the machine.

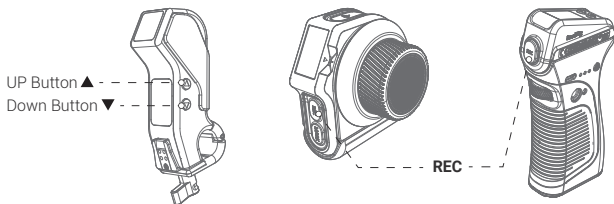

2. Channel Adjustment

Double click ▲ / ▼ of the Wireless Receiver Motor / Wireless Handwheel Controller / Electronic Controller Module to select the channel.



3. Motor Number Adjustment

Wireless Receiver Motor: Press and hold ▲ to activate the motor number; click ▲ / ▼ to adjust the number; press and hold ▲ to exit.

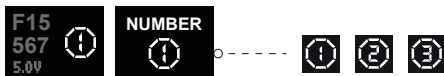

Wireless Handwheel Controller Single-Display Mode: Click SET "SET" to activate the motor number; click ▲/▼ to adjust the number; press and hold SET "SET" to exit.

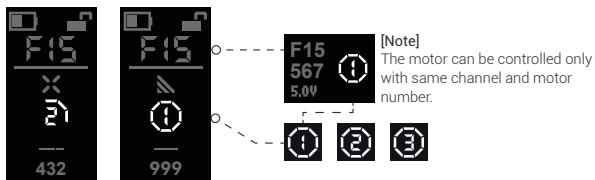

Wireless Handwheel Controller Double-Display Mode: Click SET "SET" to activate the motor number and switch the control; click ▲/▼ to adjust the number; press and hold "SET" to exit.

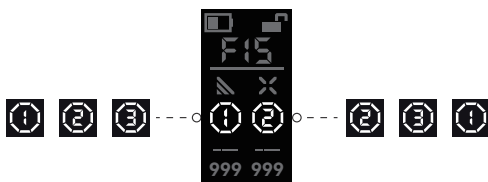

Electronic Controller Module Handgrip Mode: Press and hold ▲ to activate the motor number; click ▲/▼ to adjust the number; press and hold ▲ to exit.



4. Lens Calibration (automatic / manual)

Method 1-1: Automatic lens calibration with the Wireless Handwheel Controller

Press and hold MARK "MARK" to start the calibration; click ▲/▼ to adjust the motor number.

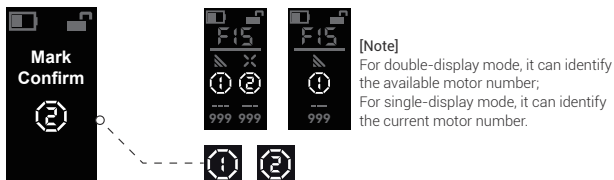

Method 1-2: Manual lens calibration with the Wireless Handwheel Controller

The automatic lens calibration lasts for over 20s, or click MARK "MARK" to switch to manual mode automatically, Click MARK "MARK" to confirm starting point and ending point.

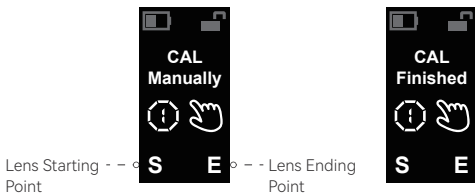

Method 2: Automatic lens calibration with Wireless Receiver Motor

Press and hold ▼ to calibrate the lens automatically; click ▼ to confirm starting point and ending point.



5. A-B Marks Setting

Wireless Handwheel Controller: Click MARK "MARK", the dotted line jumps; then click A Mark and B Mark for a customized limits; click again to cancel the A-B Marks.



[Note]

For double display mode, click "MARK" and then click "SET" to switch between the Wireless Handwheel Controller and Wireless Handgrip.

Electronic Controller Module: Click ▲/▼ simultaneously and click REC "REC" to set A Mark and B Mark; click ▲/▼ simultaneously to cancel the A-B Marks.

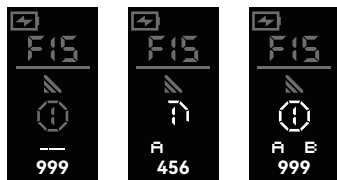

6. Reset Calibration

It is required to reset and calibrate the Wireless Handwheel Controller and Wireless Handgrip when:

1. The knob is turned to the end point and the motor is reversed rapidly.
2. The knob is turned to the end point and the non "000" or "999" position information is shown.

Wireless Handwheel Controller:
Press and hold **SET**,
Select K1-CAL for calibration.

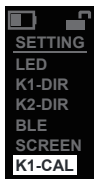

Click **SET** to enter

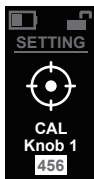

Turn the knob (K1)
to the end point



Click **SET** to complete the
calibration, so that "000"
or "999" will be shown.

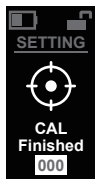

Wireless Handwheel Controller:
Press and hold **SET**,
Select K2-CAL for calibration.

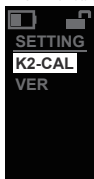

Click **SET** to enter

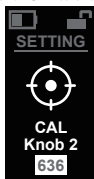

Turn the knob (K2)
to the end point



Click **SET** to complete the
calibration, so that "000"
or "999" will be shown.

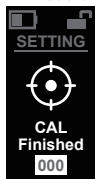

Electronic Controller Module: Press
and hold ▲ / ▼ simultaneously,
select K2-CAL for calibration.

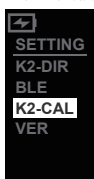

Click **REC** to enter

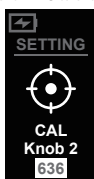

Turn the knob (K2)
to the end point



Click **REC** to complete the
calibration, so that "000"
or "999" will be shown.

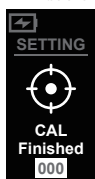

7. BLE Connection

Camera Setting: BLE Setting → BLE Function → On Status → Click to Match.

7.1 Wireless Handwheel Controller BLE Setting:

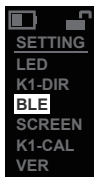

Press and hold **SET** to enter / exit
the menu, click ▲ / ▼ to turn
pages, click **SET** to enter options



Click **SET**
to start BLE
scanning



Scanning connection is
successful, and camera
confirms the matching



Click ▲ / ▼
to turn off BLE

7.2 Electronic Controller Module BLE Setting:

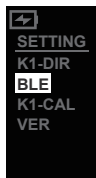

Press and hold ▲+▼ simultaneously to enter / exit the menu, click ▲/▼ to turn pages, click **REC** button to enter options.

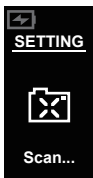

Click **REC** button to start BLE scanning

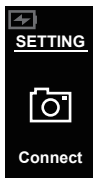

Scanning connection is successful, and camera confirms matching



Click ▲/▼ to turn off BLE

8. Other Operations

- ① **LED:** The indicator shows RED → GREEN → BLUE → YELLOW → PINK → WHITE → OFF.
- ② **K1-DIR:** Positive and negative rotation switching of the motor controlled by the Wireless Handwheel Controller.
- ③ **SCREEN:** Screen inversion display.
- ④ **VER:** Version information.

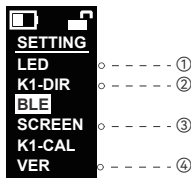

Specifications

Wireless Handwheel Controller		Screen Size	OLED 0.96"
		Battery Specification	3.7V / 1400mAh / 5.18Wh
		Full Battery Life	20h (without light display status)
		Input Voltage	5V ~ 12V
		Operating Current	Approximate 0.14A
		Channels	F00 ~ F15: 16 in total, 3 motor numbers
		Maximum Transmission Distance	≤100m (Ideal Conditions)
		Communication Frequency	2.4000 ~ 2.4835GHz

Wireless Follow Focus Controller Kit		Screen Size	OLED 0.96"
		Applicable Battery Types	LP-E6 / LP-E6N
		Input Voltage	5V ~ 16.8V
		Full Charge Duration	Approximate 1h30min
		Output Power	5V≐2A 9V≐2A
		Full Battery Life	Approximate 40h
		Loading Range	≤6kg
		Side Power Display	20% - Red Light, 60% - Green Light, 100% - Green Light

Wireless Receiver Motor		Screen Size	OLED 0.52"
		Peak Torque	0.5N.m
		Input Voltage	5V ~ 16.8V
		Maximum Transmission Distance	≤100m (Ideal Conditions)
		Communication Frequency	2.4000 ~ 2.4835GHz
		Input Voltage of External Battery	7.4V ~ 8.2V
		Compatible Rods	Standard Φ 15mm Rod

For more methods, please scan the code for details.



QR code of the Wireless Follow Focus System



QR code of the Wireless Follow Focus product lines

FCC Compliance Statement

This device complies with Part 15 of the FCC Rules. Operation is subject to the following two conditions:

- (1) This device may not cause harmful interference.
- (2) This device must accept any interference received, including interference that may cause undesired operation.

[Warning]

Changes or modifications not expressly approved by the party responsible for compliance could void the user's authority to operate the equipment.

[Note]

This equipment has been tested and found to comply with the limits for a Class B digital device, pursuant to Part 15 of the FCC Rules. These limits are designed to provide reasonable protection against harmful interference in a residential installation. This equipment generates, uses and can radiate radio frequency energy, if not installed and used in accordance with the instructions, may cause harmful interference to radio communications. However, there is no guarantee that interference will not occur in a particular installation. If this equipment does cause harmful interference to radio or television reception, which can be determined by turning the equipment off and on, the user is encouraged to try reorient or relocate the receiving antenna.

Increase the separation between the equipment and receiver.

Connect the equipment to an outlet in a different circuit than the receiver is connected to. Consult the dealer or an experienced radio / TV technician for help.

RF Warning Statement

This device has been evaluated to meet general RF exposure requirements. The device can be used in portable exposure condition without restriction.

FCC ID: 2AZWI-3262LEQI

FCC ID: 2AZWI-3263LEQI

FCC ID: 2AZWI-3917LEQI

ISED Statement

English: This device contains licence-exempt transmitter(s)/receiver(s) that comply with Innovation, Science and Economic Development Canada's licence-exempt RSS(s). Operation is subject to the following two conditions:

(1) This device may not cause interference.

(2) This device must accept any interference, including interference that may cause undesired operation of the device.

The digital apparatus complies with Canadian CAN ICES-3 (B)/NMB-3(B).

French: Cet appareil contient des émetteurs/récepteurs exempts de licence qui sont conformes aux RSS exemptés de licence d'Innovation, Sciences et Développement économique Canada.

L'exploitation est soumise aux deux conditions suivantes :

(1) Cet appareil ne doit pas provoquer d'interférences.

(2) Cet appareil doit accepter toute interférence, y compris les interférences susceptibles de provoquer un fonctionnement indésirable de l'appareil.

L'appareil numérique du ciem conforme canadien peut - 3 (b) / nmb - 3 (b). This device meets the exemption from the routine evaluation limits in section 2.5 of RSS 102 and compliance with RSS 102 RF exposure, users can obtain Canadian information on RF exposure and compliance.

cet appareil est conforme à l'exemption des limites d'évaluation courante dans la section 2.5 du cnr - 102 et conformité avec rss 102 de l'exposition aux rf, les utilisateurs peuvent obtenir des données canadiennes sur l'exposition aux champs rf et la conformité.

This equipment complies with Canada radiation exposure limits set forth for an uncontrolled environment.

Cet équipement est conforme aux limites d'exposition aux rayonnements du Canada établies pour un environnement non contrôlé.

RF Exposure

The device has been evaluated to meet general RF exposure requirement. The device can be used in portable exposure condition without restriction.

L'appareil a été évalué pour répondre aux exigences générales d'exposition aux radiofréquences.

L'appareil peut être utilisé en condition d'exposition portable sans restriction.

IC: 27649-3262LEQI

IC: 27649-3263LEQI

IC: 27649-3917LEQI



RoHS



® 219-229196



株式会社成洋



® 219-229197

FCC ID: 2AZWI-3262LEQI

IC: 27649-3262LEQI



® 219-229201

FCC ID: 2AZWI-3263LEQI

IC: 27649-3263LEQI

FCC ID: 2AZWI-3917LEQI

IC: 27649-3917LEQI

Guarantee Card

Serial No.	
Item Name	
Purchase Date	
User Name	
Mobile	
Address	
Receipt	

Service Warranty

Please keep your original receipt and guarantee card. Be sure the dealer has written on it the date of purchase and SN of the product. These are required for warranty service.

After-sale warranty terms

1. 7 Days DOA Return Policy: Within 7 days from the date of the package receipt, return or replacement can be done if the item received is malfunctioning or physical damaged (not caused by human abused), return shipping cost will be on SmallRig's charge.
2. 1-Year Warranty: Within 1-year from the date of the package receipt, defective product which is not caused by human abused is eligible to get repair / replacement for free; defective product which is caused by human abused, repair / replacement will be charged based on the damage level.

This warranty does not cover:

1. Defect caused by users' violation of the "Warnings" and "Intended Use".
2. The product identification or SN label is removed or defaced in any way.
3. The product is serviced or repaired by any one other than our company or the service agency authorized by our company.

The product has been covered by the liability insurance of PICC Property and Casualty Co., Ltd.

Manufacturer: Shenzhen Leqi Network Technology Co., Ltd.

www.smallrig.com

Add: Rooms 103, 501 and 601, Building 5, Fenghe Industrial Park,
Nos. 1301-50 Guanguang Road, Longhua District, Shenzhen,
Guangdong, China.

Made in China