

# Bissell®



## SPINWAVE® R5 ROBOTIC VACUUM | MODELS 3552N, 3475N

Docking and Charging Your Robot .....	2	Mop Mode.....	5
Connecting to the App.....	2	Cleaning the Brush Roll.....	7
Before You Clean.....	3	Replacing the Edge Cleaning Brush.....	8
Mapping .....	3	Cleaning the Sensors.....	8
Scheduled Cleaning.....	3	Storing Your Robot.....	8
Dry Vacuum Mode.....	3	Troubleshooting.....	8

### What's In The Box?



Robot with Dry Tank



Mop Tank with Mop Pads



Docking Station



Docking Tray



Power Adapter



Cleaning Tool  
(attached to dry tank)



Trial  
Formula

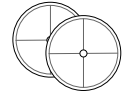

Extra Mop Pads



Replacement  
Filters  
(select models)



Replacement  
Edge Cleaning  
Brush (select models)

### Product View

1. Tank Release Button
2. Power Switch
3. Mop Pads
4. Bumper
5. Play/Pause Button
6. Home Button

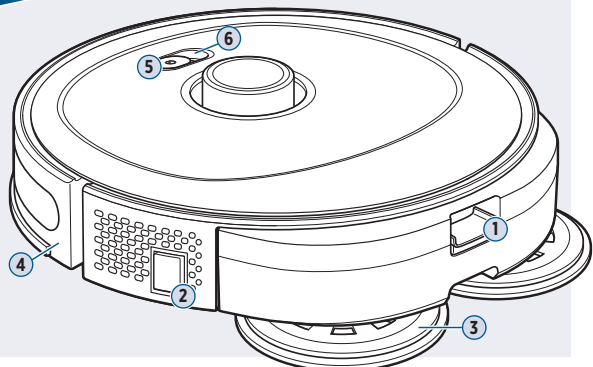

## Docking and Charging Your Robot

**Note:** The dock and tray must be installed on a hard surface. The robot's soft surface sensors prevent it from cleaning carpets and area rugs in mop mode. Be sure the device is near your WiFi router and the robot is fully charged or in the dock during the pairing process.

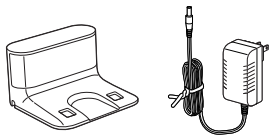
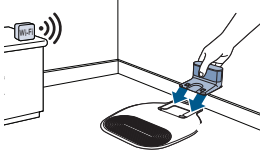
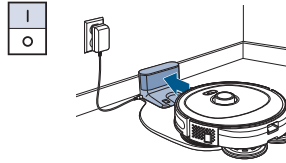
		
<p><b>1.</b> Remove bottom cover of charging base and plug in power adapter. Excess cord can be wrapped inside the dock. Replace cover and plug into the wall outlet.</p>	<p><b>2.</b> Place the tray against a wall and tip to slide the dock into the tray.</p>	<p><b>3.</b> Turn robot ON and place on the dock. The first charge will take 5-6 hours.</p>

## Connecting to the App

Download the BISSELL Connect App to customize your clean. Create cleaning zones or keep out zones, schedule cleanings, view the robot's cleaning path, track the cleaning history, view notifications, troubleshoot and more.

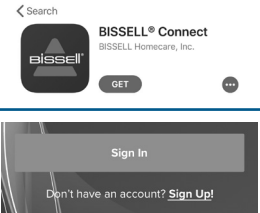
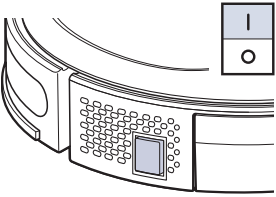
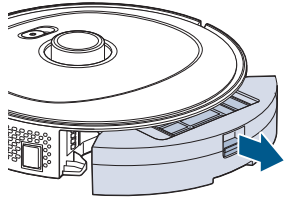
		
<p><b>1.</b> Download the BISSELL Connect App from the App Store or Google Play.</p> <p>Open the app and sign in or create a new login.</p>	<p><b>2.</b> Make sure you're near your WiFi router before turning the robot ON (I).</p> <p>From the app, select "Have a BISSELL Connected Product? Connect it now." Choose "SpinWave R5" from the menu.</p>	<p><b>3.</b> Remove the dirt bin and turn the robot over to access the setup QR code.</p>

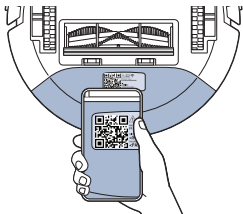
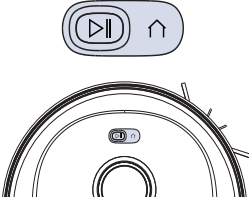
	
<p><b>4.</b> Scan the QR code and follow the instructions in the app to pair.</p>	<p><b>5.</b> To pair your robot, press and hold the play + home buttons for 3 seconds.</p>

## Before You Clean

- Pick up loose toys, cords, clothing, or other objects that may interfere with your robot.
- Secure or move fragile items as your robot may push lighter objects across the floor.

## Mapping

Your robot will create a virtual map of your home to allow customized cleaning options. Open the BISSELL Connect App and press start. The robot will begin mapping and cleaning at the same time. Your robot will clean a room in sections starting with the perimeter of that section and filling in with a structured pattern.

**Note:** If the robot is moved to an area outside of the originally mapped area, it will see this as a new space and restart the mapping process. This will delete the original map and any zones previously created.

### Tips for Mapping

- Perform mapping in dry vacuum mode to ensure the robot maps all floor types.
- Open doors and remove barriers to allow the robot to map freely.
- After mapping, use the app to customize your clean. Create virtual “go” or “no-go” zones, and create virtual walls on the map.

## Scheduled Cleaning

Download the **BISSELL Connect App** to set up automatic features.

You can designate a day and time for your robot to run automatically using the app. Once the robot is connected and a map has been created, go to the Schedule tab and follow the on-screen prompts.

## Dry Vacuum Mode

### Manual Cleaning

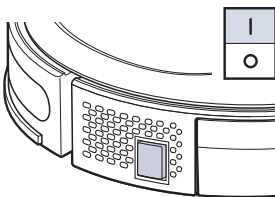
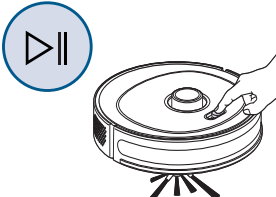
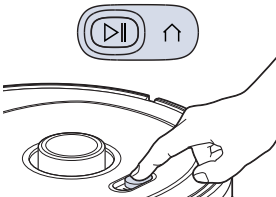
		
<p><b>1.</b> Turn the robot ON (I).</p>	<p><b>2.</b> Start the robot with the app, or by pressing the play/pause button.</p>	<p><b>3.</b> When the robot is finished cleaning, it will automatically return to the dock. If you want it to return to the dock sooner, press the play/pause button, then press the home button.</p>



## Spot Mode

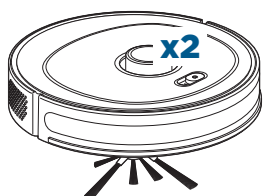

**1.** Place the robot in the center of the area you want to clean.

To start cleaning, press the play/pause button twice or select "Spot" mode in the app.

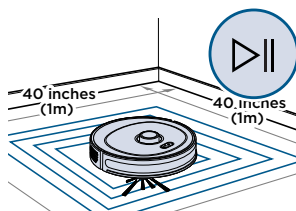

**2.** The robot will clean in a square pattern covering an area approximately 40" x 40" for about 5 minutes. The robot will beep when it's finished and return to the dock.

## Maintaining the Dirt Bin

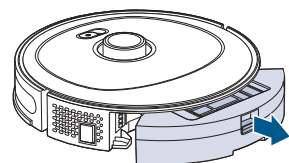

**1.** Turn the power switch OFF. Press the button on top of the dirt bin and pull to remove.

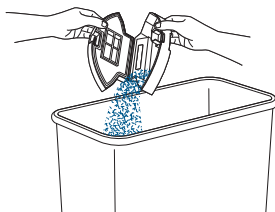

**2.** Open dirt bin by pulling both sides apart. Empty the debris into a trash can.

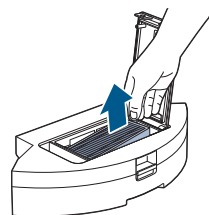

**3.** Lift the top cover of the tank and pull out the filter.

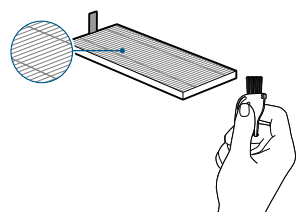

**4.** Use the cleaning tool to brush the filter. **Do not wash.**

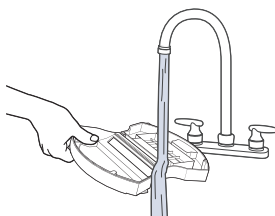

**5.** With filter removed, rinse the dirt bin with tap water. Ensure dirt bin is completely dry before reinstalling. **Do not machine wash the dirt bin.**

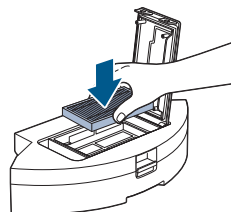

**6.** Once clean, reinstall the filter, close and push back into the machine.

# Mop Mode

▶ More of a video person? Open up the **BISSELL Connect App** for how-to videos.

## Filling Your Mop Tank

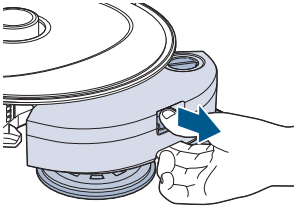
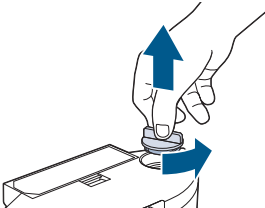
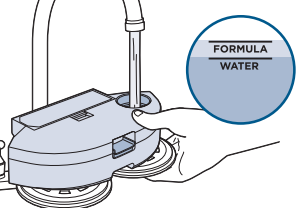
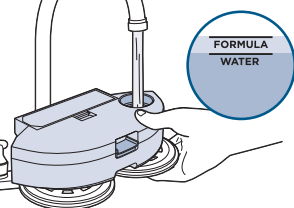
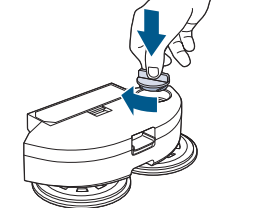
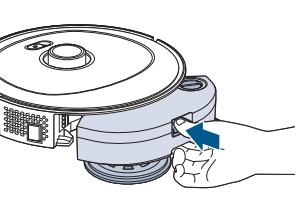
		
<p><b>1.</b> Turn the power switch OFF. Press the button on top of the tank and pull to remove.</p>	<p><b>2.</b> Twist to unlock the tank cap and pull up to remove.</p>	<p><b>3.</b> Add water to the “Water” fill line first.</p>
		
<p><b>4.</b> Add BISSELL formula to the “Formula” fill line second.</p>	<p><b>5.</b> Twist the cap back into place.</p>	<p><b>6.</b> Reinstall the tank and make sure it clicks into place. <b>Note:</b> Hold the tank level to avoid leaking.</p>

## Manual Cleaning

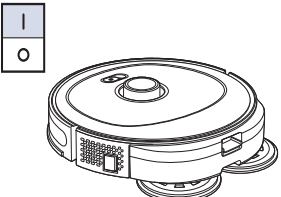
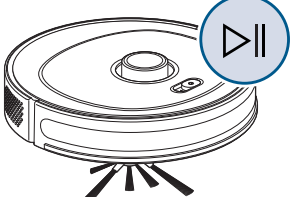
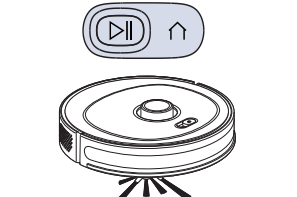

		
<p><b>7.</b> Turn the robot ON.</p>	<p><b>8.</b> Start the robot automatically with the app, or manually by pressing the play/pause button.</p>	<p><b>9.</b> When the robot is finished cleaning, it will return to the dock. If you want it to return to the dock sooner, press the play/pause button, then press home.</p>

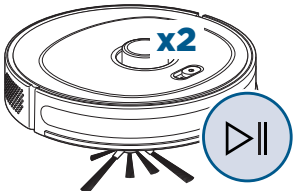
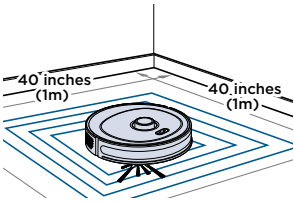
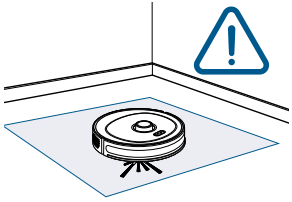

## Spot Mode

		
<p><b>1.</b> Place the robot in the center of the area you want to clean. To start cleaning, press the play/pause button twice or select "Spot" mode in the BISSELL Connect App.</p>	<p><b>2.</b> The robot will clean in a square pattern covering an area approximately 40" x 40" for about 5 minutes. It will beep when finished and return to the dock.</p>	<p><b>3.</b> Use caution when walking through the area as the floor may be slippery. Allow to remain wet for 5 minutes.</p>

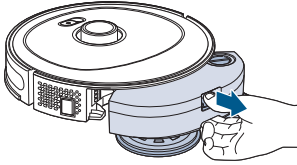
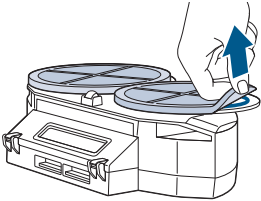
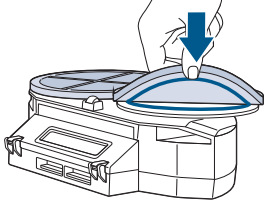
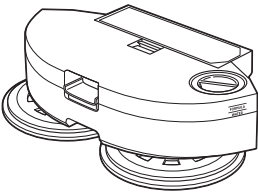
## Maintaining the Mop Pads and Debris Trap

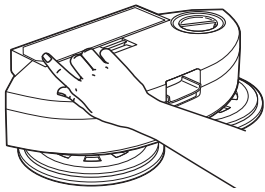
		
<p><b>4.</b> Turn the power switch OFF. Press the button on top of the mop tank and pull to remove. Place tank upside down on a soft surface.</p>	<p><b>5.</b> Firmly pull up on the mop pads to remove. Replace mop pads if damaged. Machine wash separately in warm water.</p>	<p><b>6.</b> To reattach, use the middle hole on the pads to align with the driver.</p>
		
<p><b>7.</b> Empty the dirt bin after each use.</p>	<p><b>8.</b> Push the tab on the top of the mop tank to open and empty dirt tank.</p>	<p><b>9.</b> Lift up on the filter cover on top of the tank and remove the filter. Brush off dust and debris from the filter.</p>

## Cleaning the Brush Roll

👉 Check out the **BISSELL Connect App** for tips and videos on maintenance.

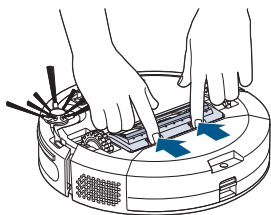

**1.** Turn the power switch OFF. Pinch the tabs on the brush guard inward and pull to remove. Lift to remove the brush roll.

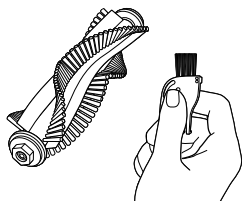

**2.** Clean the brush roll with the cleaning tool. Remove the endcaps from the brushroll by pulling apart to thoroughly clean.

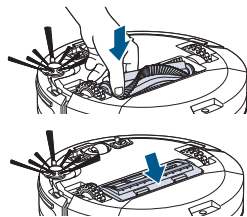

**3.** Reinstall the brush roll and brush guard.

## Replacing the Edge Cleaning Brush

The edge cleaning brush needs to be occasionally cleaned to work more effectively.

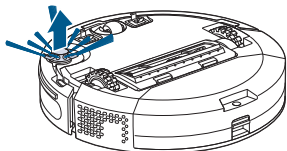

**1.** Pull up on the base of the brush.

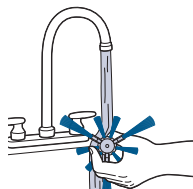

**2.** Rinse or soak in water. Let dry completely before reinstalling.

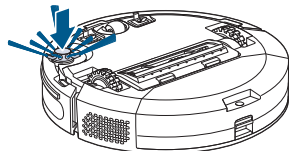

**3.** Push the brush onto the holder until it snaps into place.

## Cleaning the Sensors

After repeated use, debris can accumulate on the sensors of the robot and impact its performance.

Turn the power switch OFF and wipe the sensors with a cloth to remove any debris.

### Sensors and Contacts

1. Cliff Sensors
2. Charging Contact Points
3. Soft Surface Avoidance Sensor

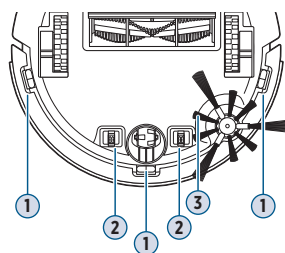

## Storing Your Robot

Store your robotic vacuum cleaner safely indoors where it is unlikely to be damaged. Store with clean, dry mop pads. Any solution remaining in the mop tank should be emptied prior to storage.

## Troubleshooting

For a comprehensive walkthrough of your product and support tips and videos, visit [support.BISSELL.com](https://support.BISSELL.com).

## NOTICE

- To reduce the risk of a leaking condition, do not store machine where freezing may occur. Damage to internal components may result.
- Disconnecting the battery will destroy the appliance and invalidate the warranty.



# Bissell®



## SPINWAVE® R5

### SAUGROBOTER | MODELLE 3552N, 3475N

Andocken und Aufladen Ihres Saugroboters.....10	Wischmodus.....13
Mit der App verbinden.....10	Reinigen der Bürstenrolle.....15
Vor der Reinigung.....11	Austausch der Kantenreinigungsbürsten.....15
Zuordnung.....11	Reinigung der Sensoren.....16
Geplante Reinigung.....11	Aufbewahren Ihres Saugroboters.....16
Trockensaugmodus.....11	Fehlerbehebung.....16

### Was ist im Lieferumfang enthalten?



Saugroboter mit Trockentank



Wischtank mit Mopp-Pads



Dockingstation

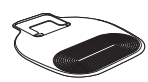

Docking-Aufbewahrungsschale



Netzteil



Reinigungswerkzeug (am Trockentank befestigt)



Probefläschchen Reinigungslösung

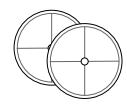

Zusätzliche Wischpads



Ersatzfilter (ausgewählte Modelle)



Ersatzkantenreinigungsbürste (ausgewählte Modelle)

### Produktübersicht

1. Tankfreigabetaste
2. Netzschalter
3. Mopp-Pads
4. Stoßleiste
5. EIN/Pause-Taste
6. Home-Taste

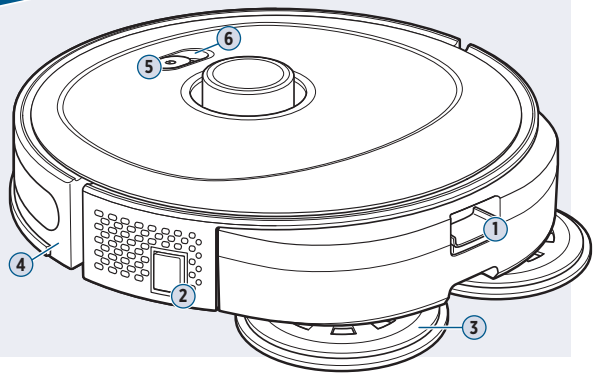

## Aufladen und Anlegen Ihres Saugroboters

**Hinweis:** Die Dockingstation und die Aufbewahrungsschale müssen auf einer harten Oberfläche aufgestellt werden. Die im Saugroboter installierten Sensoren für weiche Oberflächen verhindern, dass im Wischmodus auch Teppiche und Vorleger gereinigt werden. Stellen Sie sicher, dass sich das Gerät in der Nähe Ihres WLAN-Routers befindet und der Saugroboter während des Kopplungsvorgangs vollständig aufgeladen ist oder sich im Dock befindet.

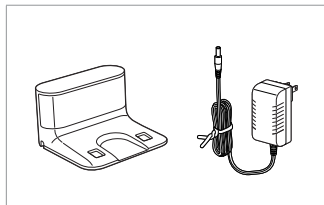

**1.** Entfernen Sie die untere Abdeckung der Ladestation und stecken Sie den Netzadapter ein. Überschüssiges Kabel kann in das Dock eingewickelt werden. Setzen Sie die Abdeckung wieder ein und stecken Sie sie in die Wandsteckdose.

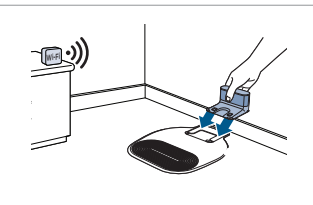

**2.** Schieben Sie die Aufbewahrungsschale gegen eine Wand und heben Sie sie schräg an, um die Dockingstation in die Aufbewahrungsschale zu schieben.

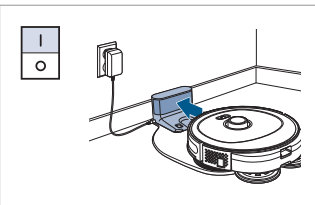

**3.** Schalten Sie den Roboter EIN und stellen Sie ihn auf die Dockingstation. Die erste Aufladung dauert 5-6 Stunden.

## Mit der App verbinden

Laden Sie die BISSELL-Connect-App herunter, um Ihre Reinigung anzupassen. Erstellen Sie Reinigungs- oder Sperrzonen, erstellen Sie Reinigungspläne, sehen Sie sich den Reinigungspfad des Saugroboters an, verfolgen Sie die Reinigungshistorie, sehen Sie sich Benachrichtigungen an, beheben Sie Fehler und vieles mehr.

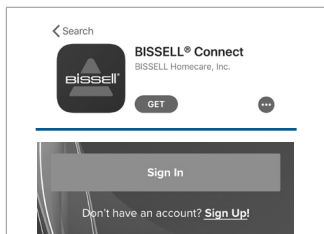

**1.** Laden Sie die BISSELL-Connect-App vom App Store oder von Google Play herunter.

Öffnen Sie die App und melden Sie sich an oder führen Sie eine neue Registrierung durch.

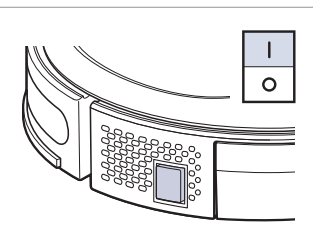

**2.** Stellen Sie sicher, dass Sie sich in der Nähe Ihres WLAN-Routers befinden, bevor Sie den Saugroboter auf EIN (I) schalten.

Wählen Sie in der App „Haben Sie ein BISSELL-Connect-Produkt? Stellen Sie jetzt die Verbindung her.“ Wählen Sie „SpinWave R5“ aus dem Menü.

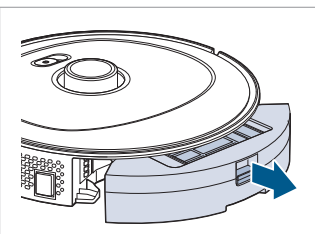

**3.** Entfernen Sie den Schmutzbehälter und drehen Sie den Saugroboter um, damit Sie zur Einrichtung auf den QR-Code zugreifen können.

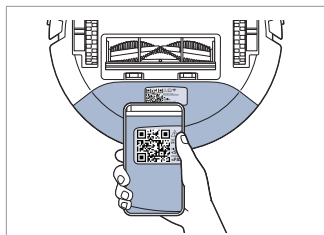

**4.** Scannen Sie den QR-Code und folgen Sie den Anweisungen in der App zum Kopplern.

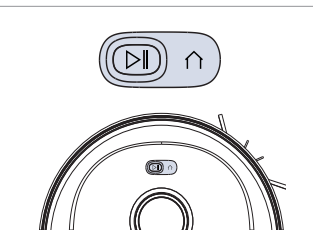

**5.** Um Ihren Saugroboter zu koppeln, halten Sie die Tasten „EIN“ und „Home“ gleichzeitig 3 Sekunden lang gedrückt.

## Vor der Reinigung

- Heben Sie verstreute Spielzeuge, Kabel, Kleidung oder andere Gegenstände vom Boden auf, die Ihren Saugroboter behindern könnten.
- Sichern oder entfernen Sie zerbrechliche Dinge, da Ihr Saugroboter leichtere Gegenstände über den Boden schieben kann.

## Zuordnung

Ihr Saugroboter erstellt eine virtuelle Karte Ihres Hauses, um individuelle Reinigungsoptionen zu ermöglichen. Öffnen Sie die BISSELL-Connect-App und drücken Sie „Start“. Der Saugroboter beginnt gleichzeitig mit der Zuordnung und Reinigung. Ihr Roboter reinigt einen Raum abschnittsweise, indem er mit dem Rand dieses Abschnitts beginnt und ihn nach einem strukturierten Muster bearbeitet.

**Hinweis:** Wenn der Saugroboter in einen Bereich außerhalb des ursprünglich zugeordneten Bereichs platziert wird, wird er diesen als neuen Bereich betrachten und den Zuordnungsprozess neu starten. Dadurch werden die ursprüngliche Karte und alle zuvor erstellten Zonen gelöscht.

### Tipps für die Zuordnung

- Führen Sie die Zuordnung im Trockensaugmodus durch, um sicherzustellen, dass der Saugroboter alle Bodentypen zuordnet.
- Öffnen Sie Türen und entfernen Sie Hindernisse, damit der Roboter den Raum mühelos zuordnen kann.
- Verwenden Sie nach der Zuordnung die App, um Ihre Reinigung nach Wunsch anzupassen. Erstellen Sie virtuelle „Go“- und „No-Go“-Zonen und erstellen Sie virtuelle Wände auf der Karte.

## Geplante Reinigung

 Laden Sie die **BISSELL-Connect-App** herunter, um automatische Funktionen einzurichten.

Sie können über die App einen Tag und eine Uhrzeit für den automatischen Betrieb Ihres Roboters festlegen. Sobald der Saugroboter angeschlossen und eine Karte erstellt wurde, gehen Sie auf die Registerkarte „Schedule“ und folgen Sie den Anweisungen auf dem Bildschirm.

## Trockensaugmodus

### Manuelle Reinigung

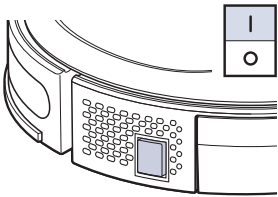
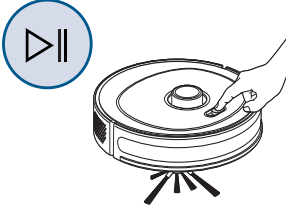
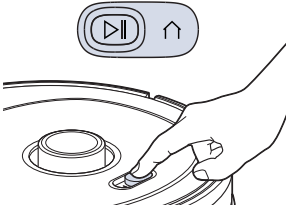
		
<p><b>1.</b> Schalten Sie den Saugroboter EIN (I).</p>	<p><b>2.</b> Starten Sie den Saugroboter mit der App oder durch Drücken der EIN/Pause-Taste am Gerät ein.</p>	<p><b>3.</b> Wenn der Saugroboter die Reinigung abgeschlossen hat, kehrt er automatisch zum Dock zurück. Wenn Sie möchten, dass er früher zum Dock zurückkehrt, drücken Sie die EIN/Pause-Taste und dann die Home-Taste.</p>



## Spot-Modus

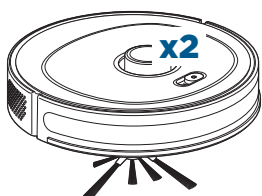

**1.** Platzieren Sie den Saugroboter in die Mitte des Bereichs, den Sie reinigen möchten.

Um mit der Reinigung zu beginnen, drücken Sie die EIN/Pause-Taste zweimal oder wählen Sie in der App den „Spot“-Modus.

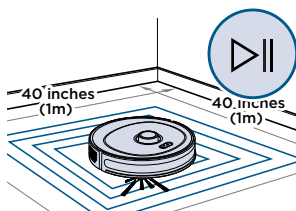

**2.** Der Saugroboter reinigt ungefähr 5 Minuten lang in einem quadratischen Muster einen etwa Quadratmeter großen Bereich. Der Saugroboter gibt einen Signalton ab, wenn er fertig ist, und kehrt zum Dock zurück.

## Instandhalten des Schmutzbehälters

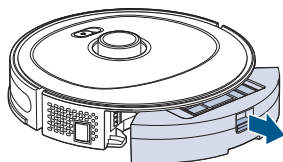

**1.** Schalten Sie den Netzschalter auf AUS. Drücken Sie die Taste auf der Oberseite des Schmutzbehälters und ziehen Sie den Behälter heraus.

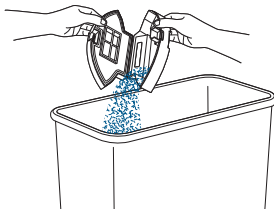

**2.** Öffnen Sie den Schmutzbehälter, indem Sie beide Seiten auseinanderziehen. Leeren Sie den Schmutz in einen Abfalleimer.

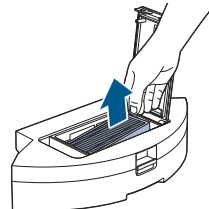

**3.** Heben Sie die obere Abdeckung des Tanks an und ziehen Sie den Filter heraus.

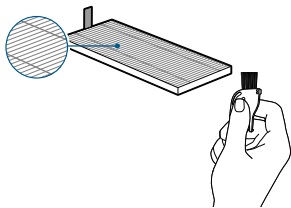

**4.** Verwenden Sie das Reinigungswerkzeug, um den Filter abzubürsten. **Nicht waschen.**

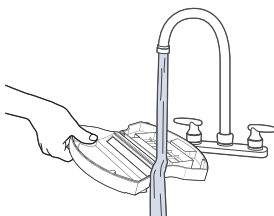

**5.** Nehmen Sie den Filter ab und spülen Sie den Schmutzbehälter mit Leitungswasser ab. Stellen Sie sicher, dass der Schmutzbehälter vollständig trocken ist, bevor Sie ihn wieder einsetzen. **Reinigen Sie den Schmutzbehälter nicht in der Spülmaschine.**

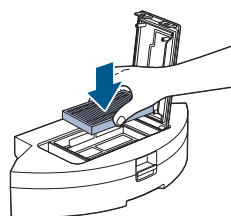

**6.** Nach der Reinigung den Filter wieder einsetzen, schließen und wieder in das Gerät drücken.

# Wischmodus

▶ Sind Sie eher ein Video-Gucker? Öffnen Sie die **BISSELL-Connect-App** und schauen Sie sich die Anleitungsvideos an.

## Auffüllen Ihres Wischtanks

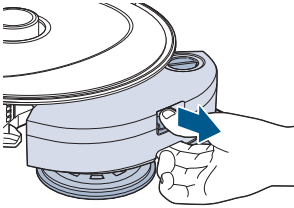
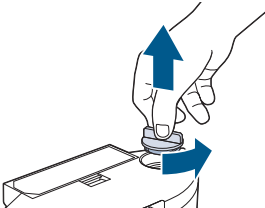
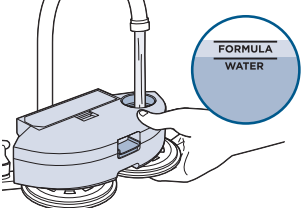
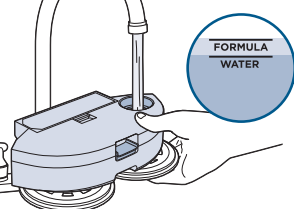
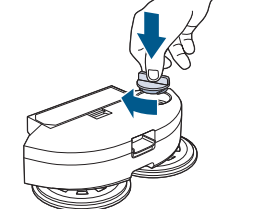
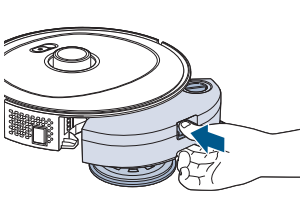
		
<p><b>1.</b> Schalten Sie den Netzschalter auf AUS. Drücken Sie die Taste oben auf dem Tank und ziehen Sie den Tank heraus.</p>	<p><b>2.</b> Drehen Sie die Tankkappe, um sie zu lösen, und ziehen Sie die Kappe nach oben heraus.</p>	<p><b>3.</b> Füllen Sie zuerst Wasser bis zur Füllstandsmarkierung für Wasser hinzu.</p>
		
<p><b>4.</b> Fügen Sie dann die BISSELL-Reinigungslösung bis zur zweiten Füllstandsmarkierung für Reinigungslösung hinzu.</p>	<p><b>5.</b> Drehen Sie die Kappe wieder in Position.</p>	<p><b>6.</b> Setzen Sie den Tank wieder ein und stellen Sie sicher, dass er einrastet. <b>Hinweis:</b> Achten Sie auf den Füllstand, um ein Auslaufen zu vermeiden.</p>

## Manuelle Reinigung

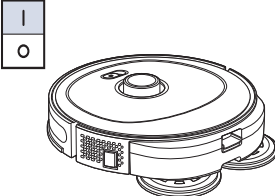
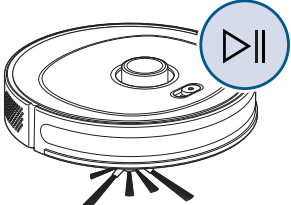
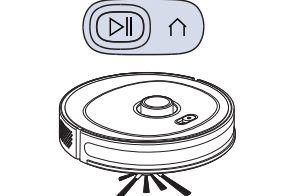
		
<p><b>1.</b> Schalten Sie den Saugroboter EIN.</p>	<p><b>2.</b> Starten Sie den Saugroboter automatisch mit der App oder manuell durch Drücken der EIN/Pause-Taste ein.</p>	<p><b>3.</b> Wenn der Saugroboter die Reinigung abgeschlossen hat, kehrt er zum Dock zurück. Wenn Sie möchten, dass er früher zum Dock zurückkehrt, drücken Sie die EIN/Pause-Taste und dann die Home-Taste.</p>

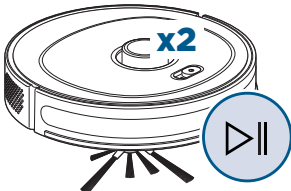
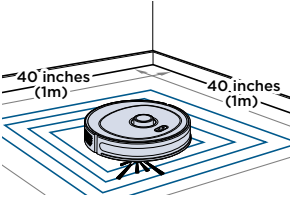
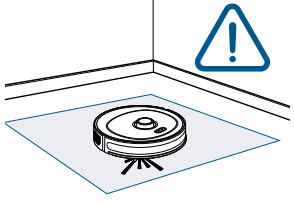

Spot-Modus

		
<p><b>1.</b> Platzieren Sie den Saugroboter in die Mitte des Bereichs, den Sie reinigen möchten. Um mit der Reinigung zu beginnen, drücken Sie die EIN/Pause-Taste zweimal oder wählen Sie in der BISSELL-Connect-App den „Spot“-Modus.</p>	<p><b>2.</b> Der Saugroboter reinigt ungefähr 5 Minuten lang in einem quadratischen Muster einen etwa einen Quadratmeter großen Bereich. Er gibt einen Signalton ab, wenn er fertig ist, und kehrt zum Dock zurück.</p>	<p><b>3.</b> Seien Sie vorsichtig, wenn Sie durch den Bereich gehen, da der Boden rutschig sein kann. Lassen Sie die Feuchtigkeit 5 Minuten lang einwirken.</p>

Instandhaltung der Wischpads und des Schmutzfängers

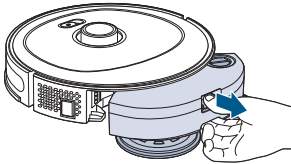
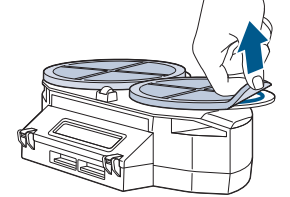
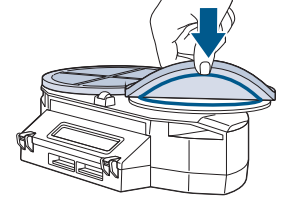
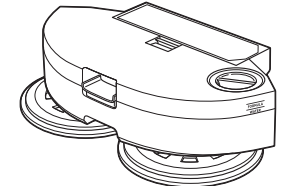
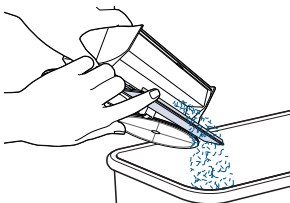
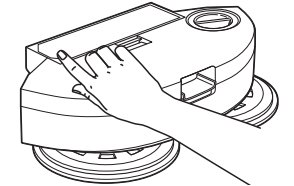
		
<p><b>1.</b> Schalten Sie den Netzschalter auf AUS. Drücken Sie die Taste oben auf dem Wischtank und ziehen Sie den Tank heraus. Legen Sie den Tank kopfstehend auf eine weiche Oberfläche.</p>	<p><b>2.</b> Ziehen Sie die Wischpads kräftig nach oben, um sie abzunehmen. Ersetzen Sie die Wischpads, wenn sie beschädigt sind. Separat in warmem Wasser in der Maschine waschen.</p>	<p><b>3.</b> Zum Wiederanbringen richten Sie das mittlere Loch der Pads mit den Antriebselementen aus.</p>
		
<p><b>4.</b> Leeren Sie den Schmutzbehälter nach jedem Gebrauch.</p>	<p><b>5.</b> Drücken Sie die Lasche oben auf dem Wischtank, um den Schmutztank zu öffnen und zu leeren.</p>	<p><b>6.</b> Heben Sie die Filterabdeckung auf der Oberseite des Tanks an und entfernen Sie den Filter. Bürsten Sie Staub und Schmutz vom Filter ab.</p>

## Reinigen der Bürstenrolle

Tipps und Videos zur Wartung finden Sie in der **BISSELL-Connect-App**.

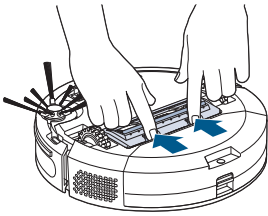

**1.** Schalten Sie den Netzschalter auf AUS. Zum Abnehmen Laschen am Bürstenschutz nach innen drücken und ziehen. Zum Abnehmen der Bürstenrolle anheben.

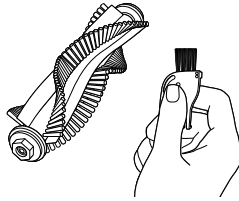

**2.** Säubern Sie die Bürstenrolle mit dem Reinigungswerkzeug. Entfernen Sie die Endkappen von der Bürstenrolle, indem Sie sie auseinanderziehen, um sie gründlich zu reinigen.

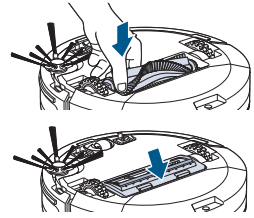

**3.** Setzen Sie die Bürstenrolle und den Bürstenschutz wieder ein.

## Austausch der Kantenreinigungsbürsten

Die Kantenreinigungsbürste muss gelegentlich gereinigt werden, um effektiver arbeiten zu können.

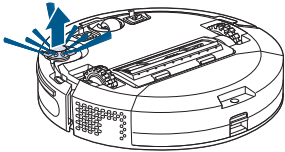

**1.** Bürstenbasis hochziehen.

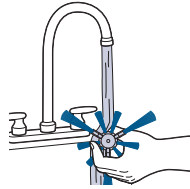

**2.** Mit Wasser abspülen oder einweichen. Bürste vollständig trocknen lassen, bevor Sie sie wieder einsetzen.

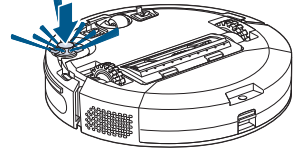

**3.** Schieben Sie die Bürste auf den Halter, bis sie einrastet.

## Reinigung der Sensoren

Nach mehrmaligem Gebrauch kann sich Schmutz auf den Sensoren des Saugroboters ansammeln und seine Leistung beeinträchtigen.

Schalten Sie den Netzschalter auf AUS und wischen Sie die Sensoren mit einem Tuch ab, um Verschmutzungen zu entfernen.

### Sensoren und Kontakte

1. Flächenrand-Sensoren
2. Ladekontaktstellen
3. Sensor zur Vermeidung von weichen Oberflächen

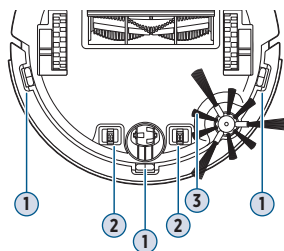

## Aufbewahren Ihres Saugroboters

Bewahren Sie Ihren Saugroboter sicher in der Wohnung auf, wo Beschädigungen unwahrscheinlich sind. Mit sauberen, trockenen Wischpads lagern. Sämtliche im Wischtank verbleibende Reinigungslösung muss vor der Lagerung entleert werden.

## Fehlerbehebung

Umfassende Informationen zu Ihrem Produkt sowie Tipps und Videos zu Ihrer Unterstützung finden Sie unter [support.BISSELL.com](http://support.BISSELL.com).

## HINWEIS

- Bewahren Sie das Gerät nicht an Orten auf, an denen Frostgefahr besteht, um das Risiko von Undichtigkeiten zu verringern. Schäden an den inneren Bauteilen können die Folge sein.
- Wenn Sie den Akku trennen, wird das Gerät zerstört und die Garantie ungültig.





# Bissell®

## SPINWAVE® R5

### ROBOT ASPIRADOR | MODELOS 3552N, 3475N

Acoplamiento y carga de tu robot .....18	Modo de fregado.....21
Conexión a la aplicación .....18	Limpeza del cepillo rodillo .....23
Antes de limpiar .....19	Sustitución del cepillo de limpieza de bordes.....23
Mapeo.....19	Limpeza de los sensores .....24
Limpeza programada.....19	Almacenamiento de tu robot.....24
Modo de aspiración en seco.....19	Solución de problemas .....24

### Contenido de la caja



Robot con depósito seco



Depósito de fregado con almohadillas



Estación de carga



Bandeja de acoplamiento



Adaptador de corriente



Herramienta de limpieza (acoplada al depósito seco)



Fórmula de prueba

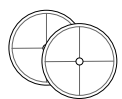

Almohadillas de fregado adicionales



Filtros de repuesto (modelos seleccionados)



Cepillo de limpieza de bordes de repuesto (modelos seleccionados)

### Vista del producto

1. Botón de liberación del depósito
2. Interruptor de alimentación
3. Almohadillas de fregado
4. Defensa
5. Botón «Play/Pause»
6. Botón «Home»

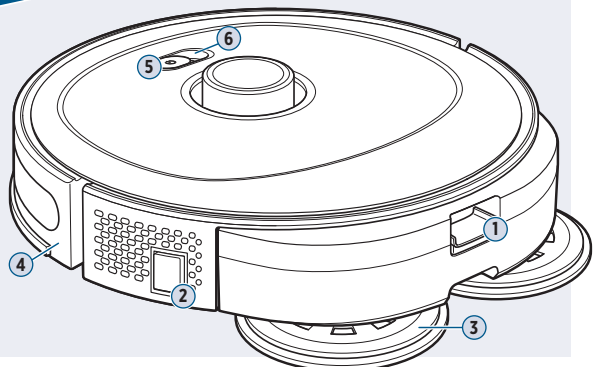

## Acoplamiento y carga de tu robot

**Nota:** La base y la bandeja deben instalarse en una superficie dura. Los sensores de superficie blanda del robot evitan que limpie moquetas y alfombras en el modo de fregado. Asegúrate de que el dispositivo esté cerca del rúter wifi y que el robot esté totalmente cargado o en la base durante el proceso de emparejamiento.

		
<p><b>1.</b> Retira la tapa inferior de la base de carga y enchufa el adaptador de corriente. El cable sobrante se puede guardar dentro de la base. Vuelve a colocar la tapa y enchufa el cable a la toma de corriente de la pared.</p>	<p><b>2.</b> Coloca la bandeja contra la pared e inclínala para deslizar la base en la bandeja.</p>	<p><b>3.</b> Enciende el robot y colócalo en la base. La primera carga durará de 5 a 6 horas.</p>

## Conexión a la aplicación

Descarga la aplicación BISSELL Connect para personalizar tu limpieza. Crea zonas de limpieza o evita zonas, programa las limpiezas, mira la ruta de limpieza del robot, realiza un seguimiento del historial de limpieza, mira las notificaciones y resuelve problemas, entre otras cosas.

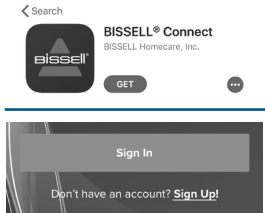
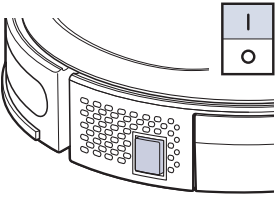
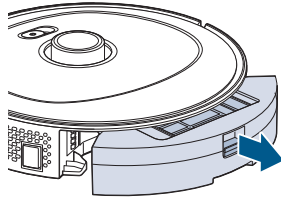
		
<p><b>1.</b> Descarga la aplicación BISSELL de la App Store o Google Play. Abre la aplicación, inicia sesión o regístrate.</p>	<p><b>2.</b> Asegúrate de estar cerca del rúter wifi antes de encender el robot (1). En la aplicación, selecciona «¿Tienes un producto BISSELL conectado? Conéctalo ahora». Selecciona «SpinWave R5» en el menú.</p>	<p><b>3.</b> Retira el depósito de suciedad y da la vuelta al robot para acceder al código QR de configuración.</p>

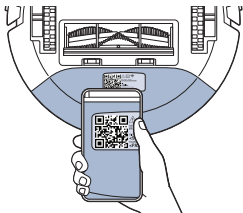
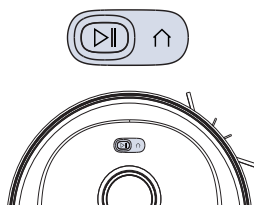
	
<p><b>4.</b> Escanea el código de QR y sigue las instrucciones de la aplicación para emparejarlo.</p>	<p><b>5.</b> Para emparejar tu robot, mantén presionados los botones «play» y «home» durante 3 segundos.</p>

## Antes de limpiar

- Recoge juguetes, cordones, ropa u otros objetos sueltos que puedan interferir con tu robot.
- Asegura o mueve los objetos frágiles, ya que tu robot puede arrastrar los objetos más ligeros por el suelo.

## Mapeo

Tu robot creará un mapa virtual de tu hogar para permitir opciones de limpieza personalizadas. Abre la aplicación BISSELL Connect y pulsa Iniciar. El robot comenzará a mapear y limpiar al mismo tiempo. Tu robot limpiará la habitación por secciones empezando por el perímetro de cada sección y completándola con un patrón estructurado.

**Nota:** Si el robot se desplaza fuera de la zona originalmente mapeada, lo considerará un espacio nuevo y reiniciará el proceso de mapeo. Esto eliminará el mapa original y cualquier zona creada anteriormente.

### Consejos para el mapeo

- Realiza el mapeo en el modo de aspirador en seco para asegurarte de que el robot trace mapas de todo tipo de suelos.
- Abre las puertas y retira las barreras para que el robot pueda realizar el mapeo libremente.
- Tras el proceso de mapeo, utiliza la aplicación para personalizar la limpieza. Puedes crear zonas virtuales «Ir» o «No ir» y también paredes virtuales en el mapa.

## Limpieza programada

Descarga la **aplicación BISSELL Connect** para configurar las funciones automáticas.

Puedes designar un día y una hora para que tu robot se ponga en marcha automáticamente mediante la aplicación. Una vez que el robot esté conectado y se haya creado un mapa, ve a la pestaña Programación y sigue las instrucciones que aparecerán en la pantalla.

## Modo de aspiración en seco

### Limpieza manual

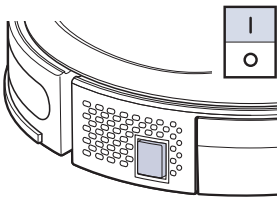
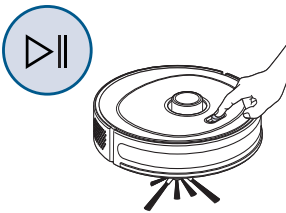
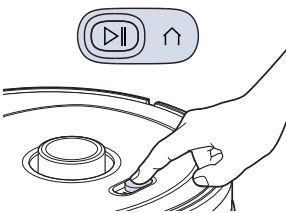
		
<p><b>1.</b> Enciende el robot (I).</p>	<p><b>2.</b> Pon en marcha el robot con la aplicación o pulsando el botón «play/pause».</p>	<p><b>3.</b> Cuando el robot haya terminado de limpiar, regresará automáticamente a la base. Si quieres que vuelva a la base antes, pulsa el botón de «play/pause» y, a continuación, el botón «home».</p>

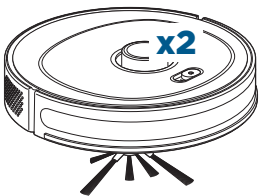
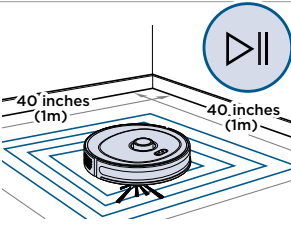

## Modo Spot

	
<p><b>1.</b> Coloca el robot en el centro de la zona que deseas limpiar.</p> <p>Para iniciar la limpieza, pulsa el botón «play/pause» dos veces o selecciona el modo «Spot» en la aplicación.</p>	<p><b>2.</b> El robot limpiará siguiendo un patrón cuadrado que cubrirá una zona de aproximadamente 1 metro cuadrado durante unos 5 minutos. El robot emitirá un pitido cuando haya terminado y regresará a la base.</p>

## Mantenimiento del depósito de suciedad

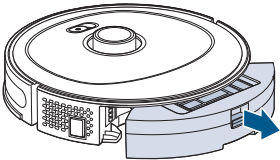
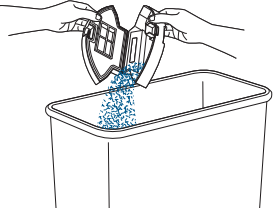
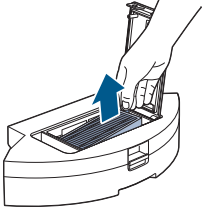
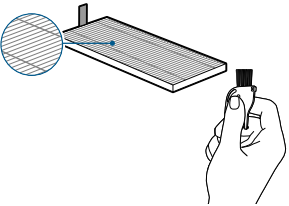
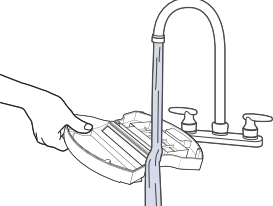
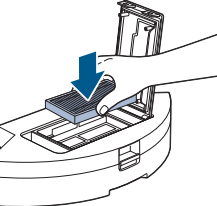
		
<p><b>1.</b> Pon el interruptor en posición de apagado. Pulsa el botón en la parte superior del depósito de suciedad y tira de él para retirarlo.</p>	<p><b>2.</b> Abre el depósito de suciedad tirando de ambos lados para separarlos. Vacía los residuos en un cubo de basura.</p>	<p><b>3.</b> Levanta la tapa superior del depósito y extrae el filtro.</p>
		
<p><b>4.</b> Utiliza la herramienta de limpieza para cepillar el filtro. <b>No lo laves.</b></p>	<p><b>5.</b> Con el filtro quitado, enjuaga el depósito de suciedad con agua del grifo. Asegúrate de que el depósito de suciedad esté completamente seco antes de volver a instalarlo. <b>No laves el depósito de suciedad en el lavavajillas.</b></p>	<p><b>6.</b> Una vez limpio, vuelve a instalar el filtro, cierra el conjunto y vuelve a colocarlo en el aparato ejerciendo presión.</p>



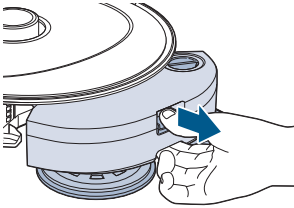
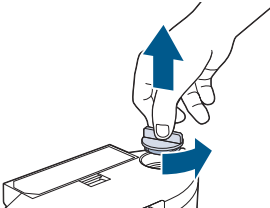
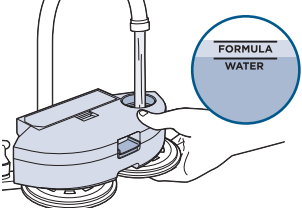
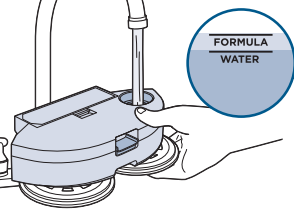
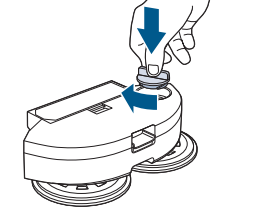
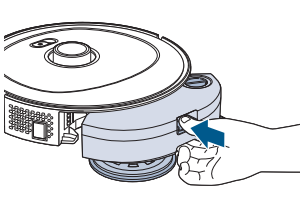

## Modo de fregado

▶ ¿Eres más de vídeos? Abre la **aplicación BISSELL Connect** para ver vídeos explicativos.

### Llenado del depósito de fregado

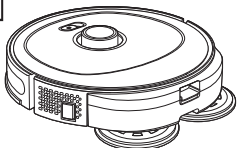
		
<p><b>1.</b> Pon el interruptor en posición de apagado. Pulsa el botón en la parte superior del depósito y tira para retirarlo.</p>	<p><b>2.</b> Gira la tapa del depósito para desbloquearla y tira hacia arriba para retirarla.</p>	<p><b>3.</b> Añade agua hasta la primera marca de llenado de «Water».</p>
		
<p><b>4.</b> Añade la fórmula BISSELL hasta la segunda marca de llenado de «Fórmula».</p>	<p><b>5.</b> Gira la tapa para volver a colocarla en su sitio.</p>	<p><b>6.</b> Vuelve a instalar el depósito en su sitio y asegúrate de que se escuche un clic.</p> <p><b>Nota:</b> No excedas el nivel de llenado del depósito para evitar fugas.</p>

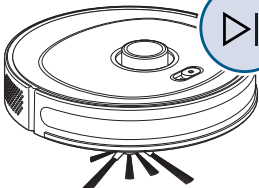
### Limpieza manual

 	 	 
<p><b>1.</b> Enciende el robot.</p>	<p><b>2.</b> Pon en marcha el robot automáticamente con la aplicación, o manualmente pulsando el botón «play/pause».</p>	<p><b>3.</b> Cuando el robot haya terminado de limpiar, regresará a la base. Si quieres que vuelva a la base antes, pulsa el botón de «play/pause» y, a continuación, pulsa «home».</p>

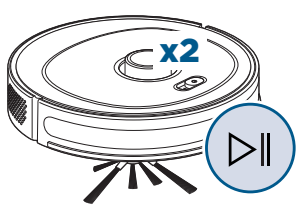
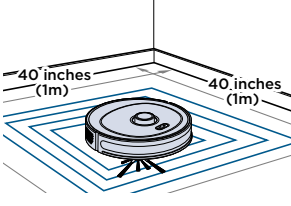
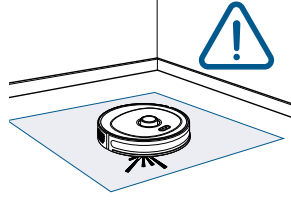

## Modo Spot

		
<p><b>1.</b> Coloca el robot en el centro de la zona que deseas limpiar. Para iniciar la limpieza, pulsa el botón «play/pause» dos veces o selecciona el modo «Spot» en la aplicación BISSELL Connect.</p>	<p><b>2.</b> El robot limpiará siguiendo un patrón cuadrado que cubrirá una zona de aproximadamente 1 metro cuadrado durante unos 5 minutos. Emitirá un pitido cuando haya terminado y regresará a la base.</p>	<p><b>3.</b> Ten cuidado al pasar por la zona, ya que el suelo puede estar resbaladizo. Deja que permanezca húmedo durante 5 minutos.</p>

## Mantenimiento de las almohadillas y del recogedor de residuos

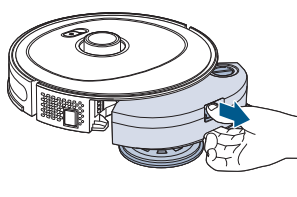
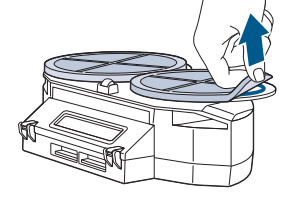
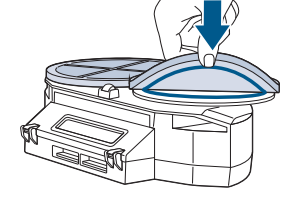
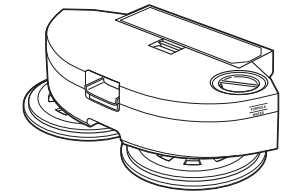
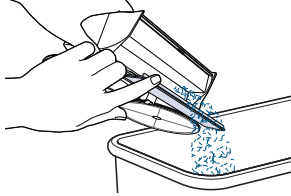
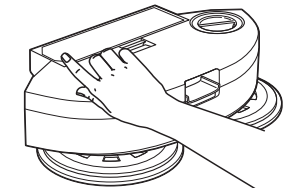
		
<p><b>1.</b> Pon el interruptor en posición de apagado. Pulsa el botón en la parte superior del depósito de fregado y tira para retirarlo. Coloca el depósito del revés sobre una superficie suave.</p>	<p><b>2.</b> Tira firmemente de las almohadillas de fregado para retirarlas. Sustituye las almohadillas de fregado si están deterioradas. Lávalas a máquina por separado con agua caliente.</p>	<p><b>3.</b> Para volver a acoplarlas, utiliza el orificio medio de las almohadillas para alinearlas con el controlador.</p>
		
<p><b>4.</b> Vacía el depósito de suciedad después de cada uso.</p>	<p><b>5.</b> Presiona la lengüeta en la parte superior del depósito de fregado para abrir y vaciar el depósito de suciedad.</p>	<p><b>6.</b> Levanta la tapa del filtro en la parte superior del depósito y extrae el filtro. Elimina el polvo y la suciedad del filtro con un cepillo.</p>

## Limpeza del cepillo rodillo

➤ Consulta la **aplicación BISSELL Connect** para obtener consejos y ver videos sobre el mantenimiento.

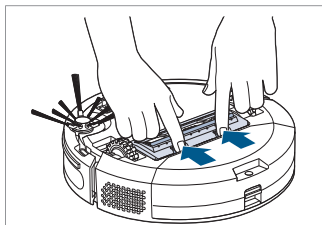

**1.** Pon el interruptor en posición de apagado. Aprieta las pestañas del protector del cepillo hacia adentro y tira para retirarlo. Tira hacia arriba para extraer el cepillo rodillo.

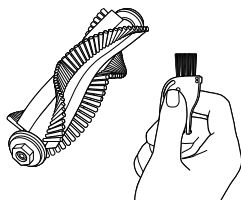

**2.** Limpia el cepillo rodillo con la herramienta de limpieza. Retira las tapas de los extremos del cepillo rodillo tirando de ellas para limpiarlas a fondo.

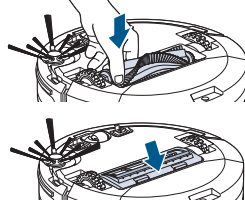

**3.** Vuelve a colocar el cepillo rodillo y el protector del cepillo.

## Sustitución del cepillo de limpieza de bordes

Los cepillos de limpieza de bordes deben limpiarse de vez en cuando para que funcionen de forma más eficaz.

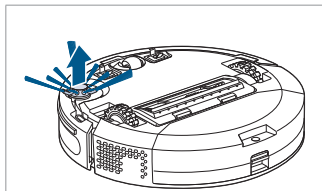

**1.** Tira hacia arriba en la base del cepillo.

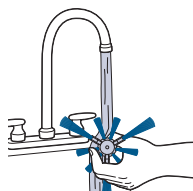

**2.** Enjuágalo o sumérgelo en agua. Deja que se seque por completo antes de volver a instalarlo.

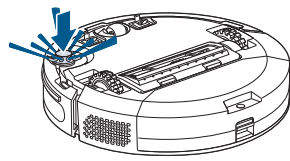

**3.** Presiona el cepillo sobre el soporte hasta que encaje en su sitio.

## Limpeza de los sensores

Después del uso repetido, los residuos pueden acumularse en los sensores del robot y afectar a su rendimiento.

Pon el interruptor en posición de apagado y limpia los sensores con un paño para eliminar la suciedad.

### Sensores y contactos

1. Sensores de desnivel
2. Puntos de contacto de carga
3. Sensor para evitar superficies blandas

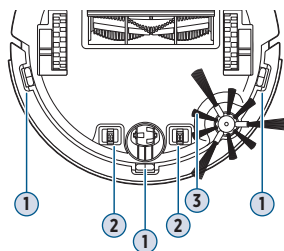

## Almacenamiento de tu robot

Guarda tu robot aspirador de forma segura en el interior, donde es poco probable que se dañe. Guárdalo con las almohadillas de fregado limpias y secas. La solución restante en el depósito de fregado debe vaciarse antes de guardar el robot.

## Solución de problemas

Si deseas conocer tu producto en profundidad y obtener consejos y vídeos de soporte, visita [support.BISSELL.com](https://support.BISSELL.com).

### AVISO

- Para reducir el riesgo de fugas, no guardes el aparato donde pueda congelarse. Pueden producirse daños en los componentes internos.
- La desconexión de la batería estropeará el aparato y anulará la garantía.



# BISSELL®



## SPINWAVE® R5

### ROBOT ASPIRATEUR | MODÈLES 3552N, 3475N

Amarrage et chargement de votre robot ..... 26	Nettoyage du rouleau-brosse ..... 31
Connexion à l'application ..... 26	Remplacement des brosses de nettoyage des bords ..... 31
Avant de nettoyer ..... 27	Nettoyage des capteurs ..... 32
Cartographie ..... 27	Rangement de votre robot ..... 32
Nettoyage programmé ..... 27	Dépannage ..... 32
Mode aspiration à sec ..... 27	
Mode serpillière ..... 29	

### Contenu de la boîte



Robot avec réservoir sec



Réservoir de serpillière avec coussinets de serpillière



Station d'accueil



Plateau d'accueil



Adaptateur secteur



Outil de nettoyage (fixés au réservoir sec)



Formule en format échantillon

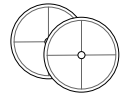

Coussinets de serpillière supplémentaires



Filtres de rechange (certains modèles)



Brosse de nettoyage de bords de rechange (certains modèles)

### Vue du produit

1. Bouton de libération du réservoir
2. Interrupteur
3. Coussinets de serpillière
4. Pare-chocs
5. Bouton play/pause
6. Bouton accueil

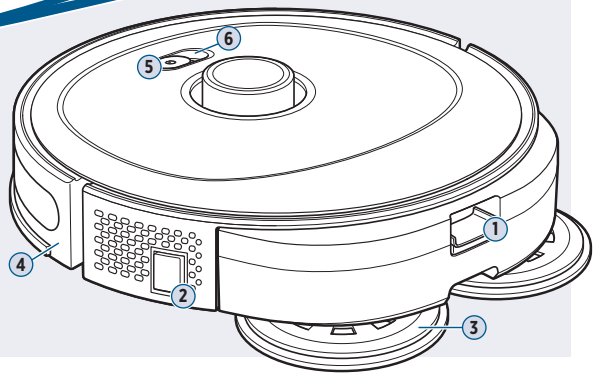

## Amarrage et chargement de votre robot

**Remarque :** la station d'accueil et le plateau doivent être installés sur une surface dure. Les capteurs de surface souple du robot l'empêchent de nettoyer les moquettes et les tapis en mode serpillère. Assurez-vous que l'appareil se trouve à proximité de votre routeur Wi-Fi et que le robot est complètement chargé ou sur la station d'accueil pendant le processus d'appairage.

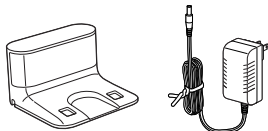

**1.** Retirez le couvercle inférieur de la base de chargement et branchez l'adaptateur secteur. La longueur du câble en excès peut être enroulée à l'intérieur de la station d'accueil. Remettez le couvercle en place et branchez dans la prise murale.

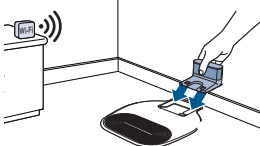

**2.** Placez le plateau contre un mur et faites glisser la station d'accueil dans le plateau.

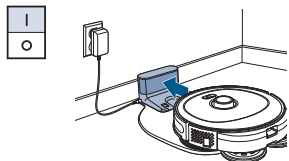

**3.** Allumez le robot et placez-le sur la station d'accueil. La première charge prendra entre 5 et 6 heures.

## Connexion à l'application

Téléchargez l'application BISSELL Connect pour personnaliser votre nettoyage. Créez des zones de nettoyage ou des zones d'exclusion, planifiez des nettoyages, affichez le parcours de nettoyage du robot, suivez l'historique de nettoyage, affichez les notifications, dépannez et bien plus encore.

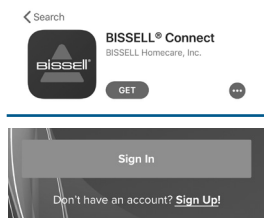

**1.** Téléchargez l'application BISSELL Connect depuis l'App Store ou Google Play.

Ouvrez l'application et connectez-vous ou créez une nouvelle connexion.

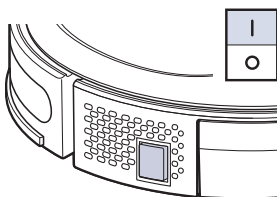

**2.** Assurez-vous d'être à proximité de votre routeur Wi-Fi avant d'allumer le robot (I).

Dans l'application, sélectionnez « Avez-vous un produit connecté BISSELL ? Connectez-le maintenant. » Sélectionnez « SpinWave R5 » dans le menu.

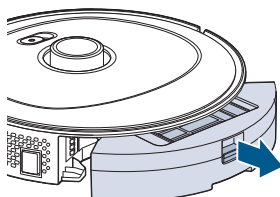

**3.** Retirez le bac à poussière et retournez le robot pour accéder au code de configuration QR.

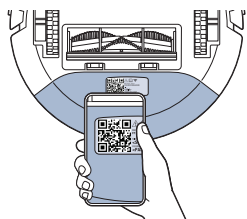

**4.** Scannez le code QR et suivez les instructions de l'application pour l'appairer.

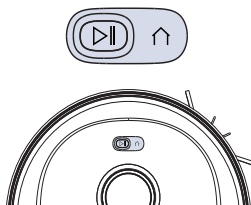

**5.** Pour appairer votre robot, appuyez sur les boutons Play + Accueil et maintenez-les enfoncés pendant 3 secondes.

## Avant de nettoyer

- Rangez les jouets, les cordons, les vêtements ou autres objets qui pourraient gêner votre robot.
- Sécurisez ou déplacez les objets fragiles car votre robot peut pousser des objets plus légers sur le sol.

## Cartographie

Votre robot créera une carte virtuelle de votre maison afin de vous proposer des options de nettoyage personnalisées. Ouvrez l'application BISSELL Connect et appuyez sur Démarrer. Le robot commencera à cartographier et à nettoyer en même temps. Votre robot nettoiera une pièce par sections en commençant par le périmètre de cette section et en remplissant cette section avec un motif structuré.

**Remarque :** Si le robot est déplacé vers une zone en dehors de la zone cartographiée initialement, il considèrera la zone comme un nouvel espace et redémarrera le processus de cartographie. Cela supprimera la carte d'origine et toutes les zones précédemment créées.

### Conseils pour la cartographie

- Effectuez la cartographie en mode aspiration sèche pour vous assurer que le robot cartographie tous les types de sol.
- Ouvrez les portes et enlevez les barrières pour permettre au robot de cartographier librement.
- Une fois le processus de cartographie terminé, utilisez l'application pour personnaliser votre nettoyage. Créez des zones virtuelles « autorisé » ou « non-autorisé », et créez des murs virtuels sur la carte.

## Nettoyage programmé

📲 Téléchargez l'**application BISSELL Connect** pour configurer des fonctionnalités automatiques.

Vous pouvez désigner un jour et une heure pour que votre robot fonctionne automatiquement à l'aide de l'application. Une fois que le robot est connecté et qu'une carte a été créée, allez dans l'onglet Planifier et suivez les instructions à l'écran.

## Mode aspiration à sec

### Nettoyage manuel

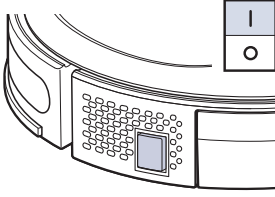
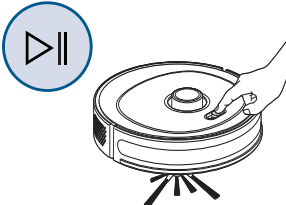
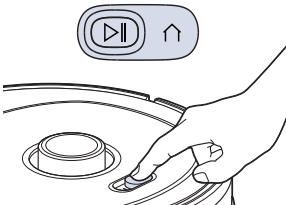
		
<p><b>1.</b> Allumez le robot (1).</p>	<p><b>2.</b> Démarrez le robot avec l'application ou en appuyant sur le bouton play/pause.</p>	<p><b>3.</b> Une fois que le robot a terminé le nettoyage, il retourne automatiquement à la station d'accueil. Si vous souhaitez qu'il retourne à la station d'accueil plus tôt, appuyez sur le bouton play/pause, puis appuyez sur le bouton Accueil.</p>

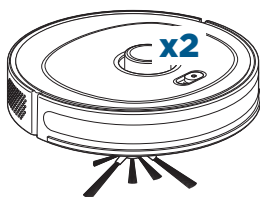
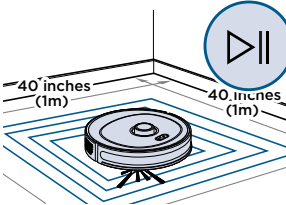

## Mode Spot

	
<p><b>1.</b> Placez le robot au centre de la zone que vous souhaitez nettoyer.</p> <p>Pour commencer le nettoyage, appuyez deux fois sur le bouton play/pause ou sélectionnez le mode « Spot » dans l'application.</p>	<p><b>2.</b> Le robot nettoiera dans un motif carré couvrant une zone d'environ 102 x 102 cm pendant environ 5 minutes. Le robot émet un bip lorsqu'il a terminé et retourne à la station d'accueil.</p>

## Entretien du bac à poussière

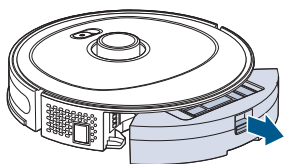
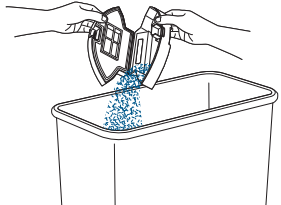
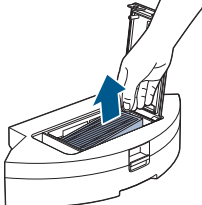
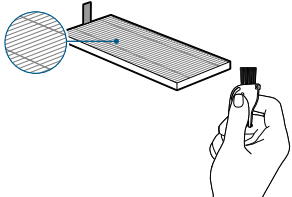
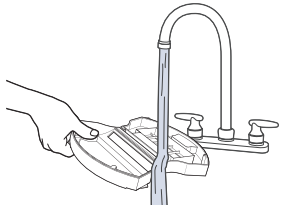
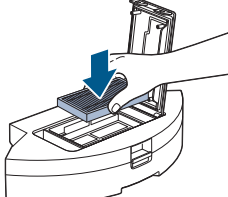
		
<p><b>1.</b> Placer l'interrupteur en position OFF. Appuyez sur le bouton sur le dessus du bac à poussière et tirez pour le retirer.</p>	<p><b>2.</b> Ouvrez le bac à poussière en tirant sur les deux côtés. Videz les débris dans une poubelle.</p>	<p><b>3.</b> Soulevez le couvercle supérieur du réservoir et retirez le filtre.</p>
		
<p><b>4.</b> Utilisez l'outil de nettoyage pour brosser le filtre. <b>Ne pas le laver.</b></p>	<p><b>5.</b> Une fois le filtre retiré, rincez le bac à poussière sous l'eau du robinet. Assurez-vous que le bac à poussière est complètement sec avant de le réinstaller. <b>Ne lavez pas le bac à poussière en machine.</b></p>	<p><b>6.</b> Une fois propres, réinstallez le filtre, fermez et poussez-le dans l'appareil.</p>

## Mode serpillière

▶ Vous voulez voir une vidéo ? Ouvrez l'**application** BISSELL Connect pour des vidéos pratiques.

### Remplir votre réservoir de serpillière

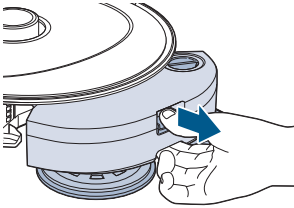
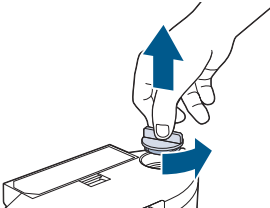
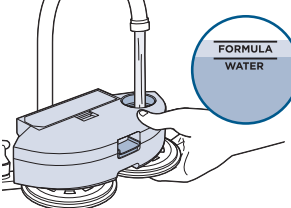
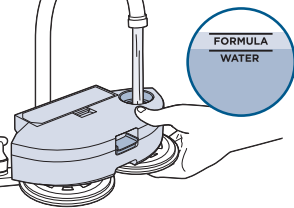
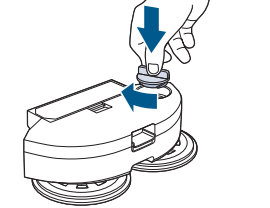
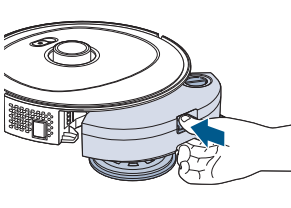
		
<p><b>1.</b> Placer l'interrupteur en position OFF. Appuyez sur le bouton situé sur le dessus du réservoir et tirez pour le retirer.</p>	<p><b>2.</b> Tournez pour déverrouiller le capuchon du réservoir et tirez pour le retirer.</p>	<p><b>3.</b> Ajoutez dans un premier temps de l'eau jusqu'à la ligne de remplissage « eau ».</p>
		
<p><b>4.</b> Puis ajoutez la formule BISSELL à la ligne de remplissage « formule ».</p>	<p><b>5.</b> Remettez le capuchon en place.</p>	<p><b>6.</b> Réinstallez le réservoir et assurez-vous qu'il est bien inséré. <b>Remarque :</b> maintenez le niveau du réservoir pour éviter toute fuite.</p>

### Nettoyage manuel

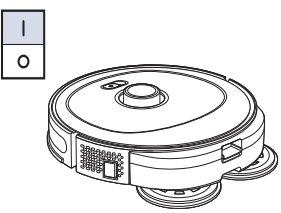
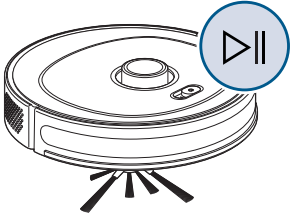
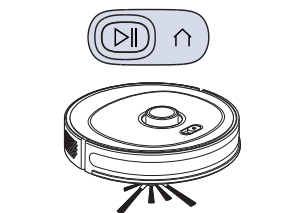

		
<p><b>1.</b> Allumez le robot.</p>	<p><b>2.</b> Démarrez le robot automatiquement avec l'application ou manuellement en appuyant sur le bouton play/pause.</p>	<p><b>3.</b> Une fois que le robot a terminé le nettoyage, il retourne à la station d'accueil. Si vous souhaitez qu'il retourne à la station d'accueil plus tôt, appuyez sur le bouton play/pause, puis appuyez sur le bouton Accueil.</p>

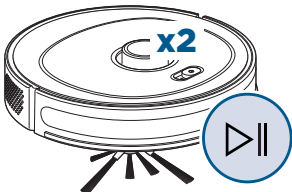
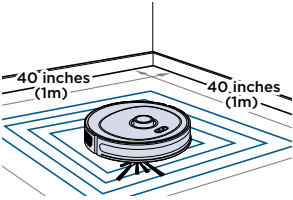
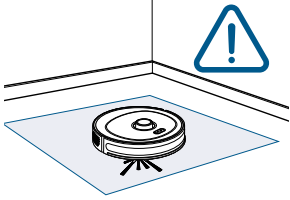

## Mode Spot

		
<p><b>1.</b> Placez le robot au centre de la zone que vous souhaitez nettoyer. Pour commencer le nettoyage, appuyez deux fois sur le bouton play/pause ou sélectionnez le mode «Spot» dans l'application BISSELL Connect.</p>	<p><b>2.</b> Le robot nettoiera dans un motif carré couvrant une zone d'environ 102 x 102 cm pendant environ 5 minutes. Le robot émet un bip lorsqu'il a terminé et retourne à la station d'accueil.</p>	<p><b>3.</b> Faites preuve de prudence en marchant dans la zone car le sol peut être glissant. Laissez agir pendant 5 minutes.</p>

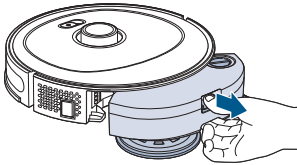
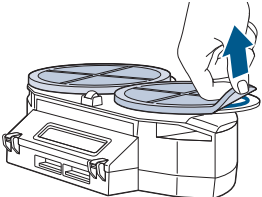
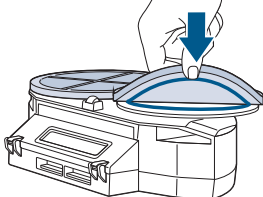
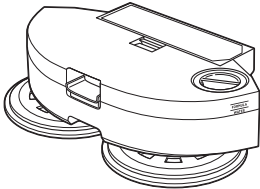
## Entretien des coussinets de serpillère et du piège à débris

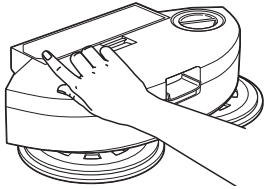
		
<p><b>1.</b> Placer l'interrupteur en position OFF. Appuyez sur le bouton situé au-dessus du réservoir de la serpillère et tirez pour l'enlever. Placez le réservoir à l'envers sur une surface souple.</p>	<p><b>2.</b> Tirez fermement sur les lingettes pour les retirer. Remplacez les coussinets de serpillère s'ils sont abîmés. Lavez-les en machine séparément dans de l'eau tiède.</p>	<p><b>3.</b> Pour les refixer, utilisez le trou du milieu situé sur les lingettes pour vous aligner avec le pied moteur.</p>
		
<p><b>4.</b> Videz le bac à poussière après chaque utilisation.</p>	<p><b>5.</b> Poussez la languette sur le dessus du réservoir de la serpillère pour ouvrir et vider le réservoir de poussières.</p>	<p><b>6.</b> Soulevez le couvercle du filtre sur le dessus du réservoir et retirez le filtre. Enlevez la poussière et les débris du filtre.</p>

## Nettoyage du rouleau-brosse

Consultez l'application **BISSELL Connect** pour des conseils et des vidéos sur l'entretien.

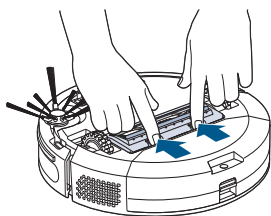

**1.** Placer l'interrupteur en position OFF. Appuyez sur les languettes de la protection de la brosse vers l'intérieur et tirez dessus pour retirer la protection. Soulevez pour retirer le rouleau-brosse.

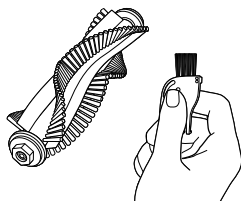

**2.** Nettoyez le rouleau-brosse avec l'outil de nettoyage. Retirez les extrémités du rouleau-brosse en les tirant pour les nettoyer soigneusement.

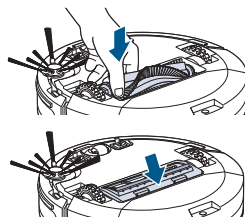

**3.** Réinstallez le rouleau-brosse et la protection.

## Remplacement des brosses de nettoyage des bords

La brosse de nettoyage des bords doit être nettoyée de temps en temps pour fonctionner plus efficacement.

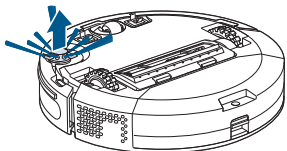

**1.** Tirez sur la base de la brosse.

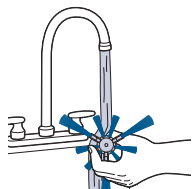

**2.** Rincez ou plongez dans l'eau. Laissez sécher complètement avant de la réinstaller.

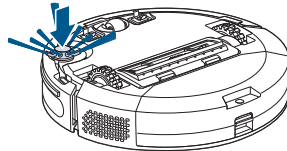

**3.** Poussez la brosse sur le support jusqu'à ce qu'elle s'enclenche.

## Nettoyage des capteurs

Après une utilisation répétée, les débris peuvent s'accumuler sur les capteurs du robot et affecter ses performances.

Éteignez l'appareil et essuyez les capteurs avec un chiffon pour enlever tout débris.

### Capteurs et contacts

1. Capteurs de déclivité
2. Points de contact de chargement
3. Capteur d'évitement de surface souple

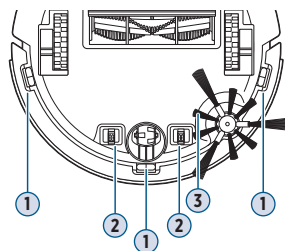

## Rangement de votre robot

Rangez votre aspirateur robot en toute sécurité à l'intérieur, là où il est peu probable qu'il soit endommagé. Rangez avec des coussinets de serpillière propres et secs. Toute solution restante dans le réservoir de la serpillière doit être vidée avant de ranger l'appareil.

## Dépannage

Pour une présentation complète de votre produit et des conseils et vidéos d'assistance, consultez la page **support**.  
**BISSELL.com**.

### AVIS

- Pour réduire le risque de fuite, ne rangez pas l'appareil dans un endroit présentant un risque de gel. Des composants internes pourraient être endommagés.
- La déconnexion de la batterie détruira l'appareil et annulera la garantie.





# BISSELL®

## SPINWAVE® R5 ASPIRAPOLVERE ROBOTICO | MODELLI 3552N, 3475N

Aggancio e carica del robot .....	34	Pulizia della spazzola rotante .....	39
Connessione all'App .....	34	Sostituzione della spazzola per la pulizia dei bordi .....	39
Prima di avviare la pulizia .....	35	Pulizia dei sensori .....	40
Mappatura .....	35	Conservazione del robot .....	40
Pulizia programmata .....	35	Risoluzione dei problemi .....	40
Modalità aspirazione a secco .....	35		
Modalità Mop .....	37		

### Cosa contiene la confezione?



Robot con serbatoio per aspirazione a secco



Serbatoio Mop con cuscinetti Mop



Docking Station



Vassoio di aggancio



Adattatore di alimentazione



Strumento di pulizia (collegato al serbatoio per aspirazione a secco)



Soluzione detergente in formato di prova

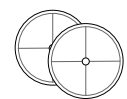

Cuscinetti Mop aggiuntivi



Filtri di ricambio (modelli selezionati)



Spazzola di ricambio per la pulizia dei bordi (modelli selezionati)

### Vista del prodotto

1. Pulsante di rilascio del serbatoio
2. Interruttore di accensione
3. Cuscinetti Mop
4. Paraurti
5. Pulsante di accensione/pausa
6. Pulsante Home

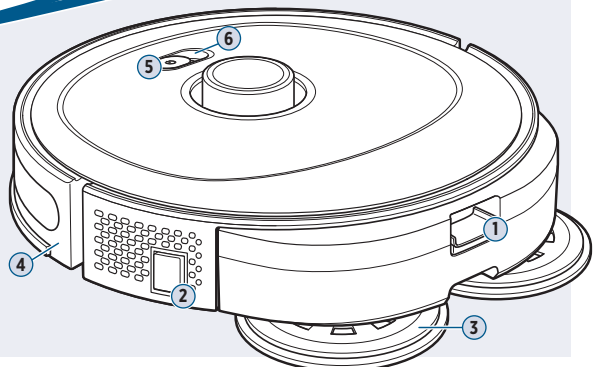

## Aggiaccio e carica del robot

**Nota:** il dock e il vassoio devono essere installati su una superficie dura. I sensori del robot per le superfici morbide impediscono di pulire moquette e tappeti in modalità Mop. Assicurarsi che durante il processo di associazione il dispositivo sia vicino al router Wi-Fi e che il robot sia completamente carico o nel dock.

		
<p><b>1.</b> Rimuovere il coperchio inferiore della base di ricarica e collegare l'adattatore di alimentazione. Il cavo in eccesso può essere avvolto all'interno del dock. Riposizionare il coperchio e inserire la spina nella presa a muro.</p>	<p><b>2.</b> Posizionare il vassoio contro una parete e inclinare per far scorrere il dock nel vassoio.</p>	<p><b>3.</b> Accendere il robot e posizionarlo sul dock. La prima ricarica richiederà 5-6 ore.</p>

## Connessione all'App

Scaricare l'App BISSELL Connect per personalizzare la pulizia. Con l'app è possibile creare zone da pulire e zone da ignorare, programmare le pulizie, visualizzare il percorso di pulizia del robot, monitorare la cronologia delle pulizie, visualizzare le notifiche, risolvere i problemi e altro ancora.

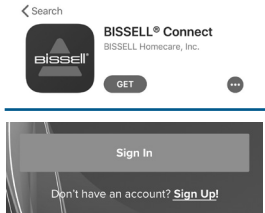
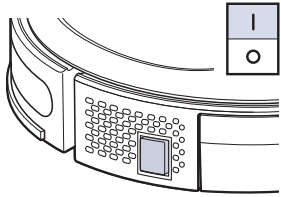
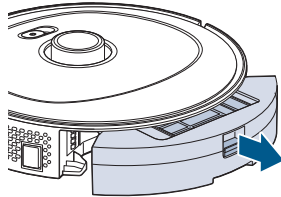
		
<p><b>1.</b> Scaricare l'App BISSELL Connect dall'App Store o da Google Play. Aprire l'app e accedere o creare un nuovo login.</p>	<p><b>2.</b> Assicurarsi di essere vicino al router WiFi prima di accendere il robot (1). Dall'app, selezionare "Hai un prodotto BISSELL Connected? Collegalo ora". Dal menu, scegliere "SpinWave R5".</p>	<p><b>3.</b> Rimuovere il contenitore dello sporco e capovolgere il robot per accedere al codice QR di configurazione.</p>

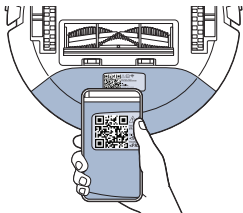
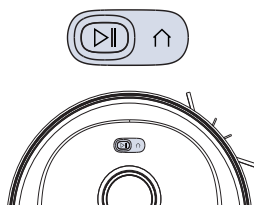
	
<p><b>4.</b> Scansionare il codice QR e seguire le istruzioni nell'app per completare l'associazione.</p>	<p><b>5.</b> Per associare il robot, tenere premuti i pulsanti di accensione + Home per 3 secondi.</p>

## Prima di avviare la pulizia

- Raccogliere giochi, cavi, vestiti o altri oggetti sparsi che potrebbero interferire con il robot.
- Fissare o spostare gli oggetti fragili, poiché il robot potrebbe trascinare sul pavimento quelli più leggeri.

## Mappatura

Il robot creerà una mappa virtuale della casa per consentire opzioni di pulizia personalizzate. Aprire l'App BISSELL Connect e premere Start. Il robot avvierà la mappatura e la pulizia contemporaneamente. Il robot pulirà le stanze in sezioni, partendo dal perimetro di una sezione e riempiendone l'area seguendo uno schema strutturato.

**Nota:** se spostato in un'area esterna a quella originariamente mappata, il robot percepirà la nuova area come un nuovo spazio e riavvierà il processo di mappatura. Questa operazione eliminerà la mappa originale e qualsiasi zona creata in precedenza.

### Suggerimenti per la mappatura

- Eseguire la mappatura in modalità aspirazione a secco per assicurarsi che il robot mappi tutti i tipi di pavimento.
- Aprire le porte e rimuovere gli ostacoli per consentire al robot di mappare liberamente.
- Dopo la mappatura, usare l'app per personalizzare la pulizia. Suddividere virtualmente lo spazio in zone da pulire o da ignorare e creare pareti virtuali sulla mappa.

## Pulizia programmata

📱 Scaricare l'**App BISSELL Connect** per impostare le funzioni automatiche.

È possibile stabilire un giorno e un'ora in cui il robot si avvierà automaticamente utilizzando l'app. Una volta collegato il robot e creata una mappa, accedere alla scheda Programma e seguire le istruzioni sullo schermo.

## Modalità aspirazione a secco

### Pulizia manuale

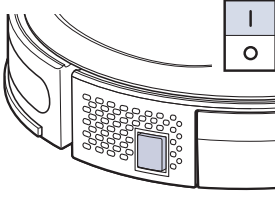
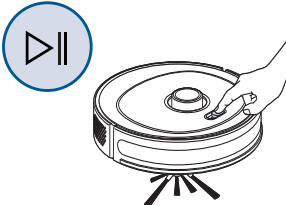
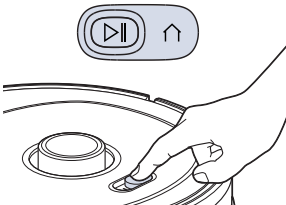
		
<p><b>1.</b> Accendere il robot (I).</p>	<p><b>2.</b> Avviare il robot con l'app o premendo il pulsante di accensione/pausa.</p>	<p><b>3.</b> Al termine della pulizia, il robot tornerà automaticamente al dock. Se si desidera che il robot torni al dock prima, premere il pulsante di accensione/pausa, quindi premere il pulsante Home.</p>

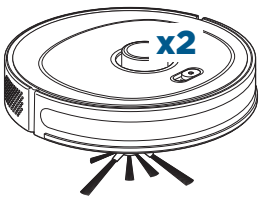
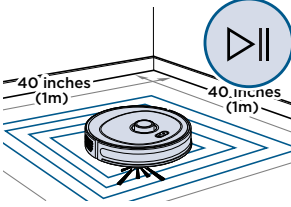

## Modalità Spot

	
<p><b>1.</b> Posizionare il robot al centro dell'area che si desidera pulire.</p> <p>Per avviare la pulizia, premere due volte il pulsante di accensione/pausa oppure selezionare la modalità "Spot" nell'app.</p>	<p><b>2.</b> Il robot pulirà un quadrato approssimativamente di 1 metro x 1 metro per circa 5 minuti. Il robot emetterà un bip al termine e tornerà al dock.</p>

## Manutenzione del contenitore dello sporco

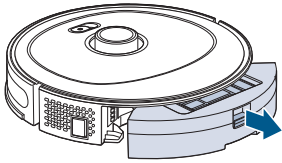
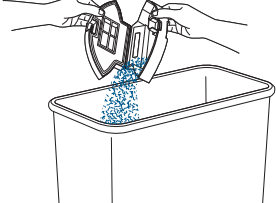
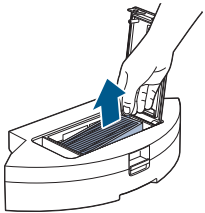
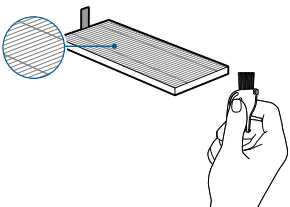
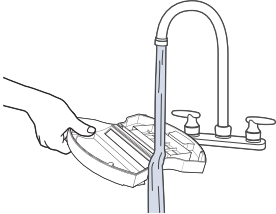
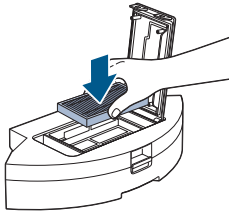
		
<p><b>1.</b> Spegnerne l'interruttore di alimentazione. Premere il pulsante sulla parte superiore del contenitore dello sporco e tirare per rimuoverlo.</p>	<p><b>2.</b> Aprire il contenitore dello sporco tirando entrambi i lati. Svuotare lo sporco in un contenitore della spazzatura.</p>	<p><b>3.</b> Sollevare il coperchio superiore del serbatoio ed estrarre il filtro.</p>
		
<p><b>4.</b> Utilizzare lo strumento di pulizia per spazzolare il filtro. <b>Non lavare.</b></p>	<p><b>5.</b> Dopo aver rimosso il filtro, risciacquare il contenitore dello sporco con acqua corrente. Assicurarsi che il contenitore dello sporco sia completamente asciutto prima di reinserirlo. <b>Non lavare in lavastoviglie il contenitore dello sporco.</b></p>	<p><b>6.</b> Una volta pulito, reinstallare il filtro, chiudere e spingere all'interno dell'apparecchio.</p>

## Modalità Mop

▶ Meglio un video? Aprire l'App **BISSELL Connect** per i video tutorial.

### Riempimento del serbatoio Mop

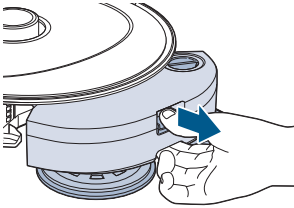
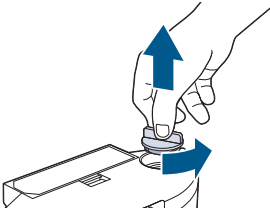
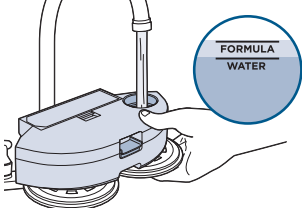
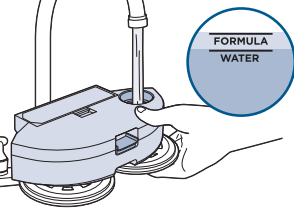
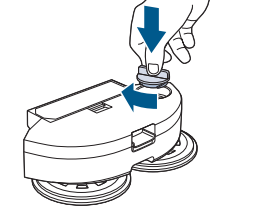
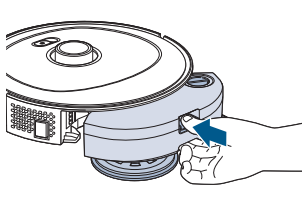
		
<p><b>1.</b> Spegnerne l'interruttore di alimentazione. Premere il pulsante sulla parte superiore del serbatoio e tirare per estrarlo.</p>	<p><b>2.</b> Ruotare per sbloccare il tappo del serbatoio e tirare verso l'alto per rimuoverlo.</p>	<p><b>3.</b> Aggiungere acqua fino alla linea di riempimento corrispondente ("Water").</p>
		
<p><b>4.</b> Aggiungere un detergente BISSELL fino alla linea di riempimento corrispondente ("Formula").</p>	<p><b>5.</b> Ruotare di nuovo il tappo in posizione.</p>	<p><b>6.</b> Reinstallare il serbatoio e assicurarsi che scatti in posizione. <b>Nota:</b> mantenere il livello del serbatoio per evitare fuoriuscite.</p>

### Pulizia manuale

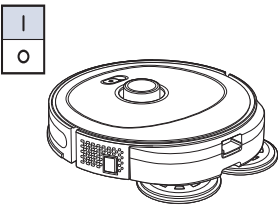
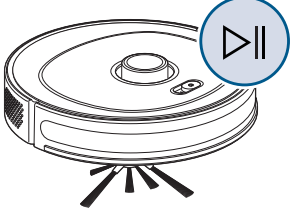
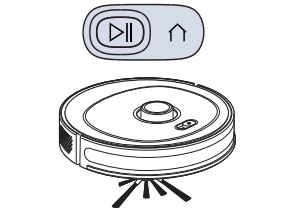

		
<p><b>1.</b> Accendere il robot.</p>	<p><b>2.</b> Avviare il robot automaticamente con l'app o manualmente premendo il pulsante di accensione/pausa.</p>	<p><b>3.</b> Al termine della pulizia, il robot tornerà al dock. Se si desidera che il robot torni al dock prima, premere il pulsante di accensione/pausa, quindi premere il pulsante Home.</p>

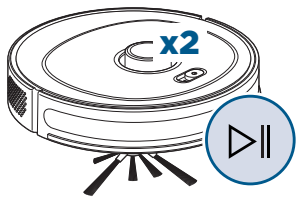
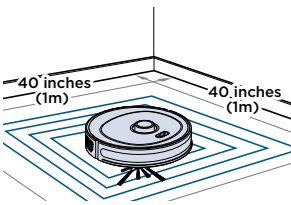
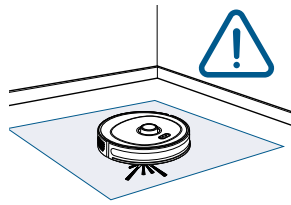

## Modalità Spot

		
<p><b>1.</b> Posizionare il robot al centro dell'area che si desidera pulire. Per avviare la pulizia, premere due volte il pulsante di accensione/pausa o selezionare la modalità "Spot" sull'App BISSELL Connect.</p>	<p><b>2.</b> Il robot pulirà un quadrato approssimativo di 1 metro x 1 metro per circa 5 minuti. Al termine dell'operazione emetterà un bip e tornerà al dock.</p>	<p><b>3.</b> Prestare attenzione quando si cammina nell'area, in quanto il pavimento potrebbe essere scivoloso. Lasciare che il pavimento rimanga umido per 5 minuti.</p>

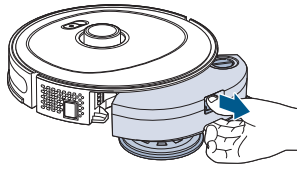
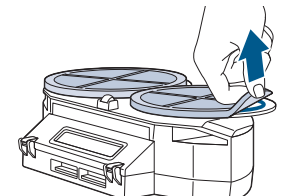
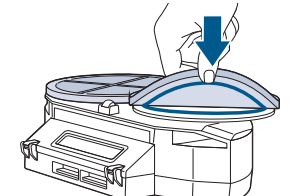
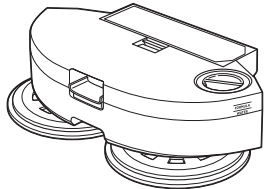
## Manutenzione dei cuscinetti Mop e della trappola dei detriti

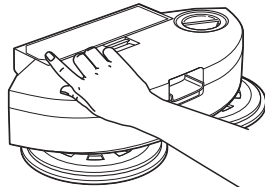
		
<p><b>1.</b> Spegnerne l'interruttore di alimentazione. Premere il pulsante sulla parte superiore del serbatoio Mop e tirare per estrarlo. Posizionare il serbatoio capovolto su una superficie morbida.</p>	<p><b>2.</b> Tirare saldamente verso l'alto i panni per rimuoverli. Sostituire i panni se danneggiati. Lavare separatamente in lavatrice con acqua calda.</p>	<p><b>3.</b> Per riagganciare, utilizzare il foro centrale sui cuscinetti per allinearli alla guida.</p>
		
<p><b>4.</b> Svotare il contenitore dello sporco dopo ogni utilizzo.</p>	<p><b>5.</b> Spingere la linguetta sulla parte superiore del serbatoio Mop per aprire e svotare il contenitore dello sporco.</p>	<p><b>6.</b> Sollevare il coperchio del filtro sulla parte superiore del serbatoio e rimuovere il filtro. Rimuovere polvere e residui dal filtro.</p>

## Pulizia della spazzola rotante

↖ Consultare l'App **BISSELL Connect** per suggerimenti e video sulla manutenzione.

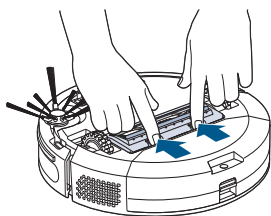

**1.** Spegnerne l'interruttore di alimentazione. Stringere le linguette sulla protezione della spazzola verso l'interno e tirare per rimuoverla. Sollevare per rimuovere la spazzola rotante.

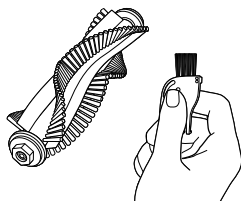

**2.** Pulire la spazzola rotante con l'apposito accessorio di pulizia. Per una pulizia approfondita, rimuovere i tappi alle estremità della spazzola rotante tirandoli.

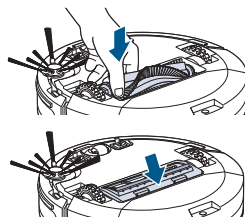

**3.** Reinstallare la spazzola rotante e la protezione della spazzola.

## Sostituzione della spazzola per la pulizia dei bordi

Per un funzionamento ottimale, le spazzole per la pulizia dei bordi devono essere pulite di tanto in tanto.

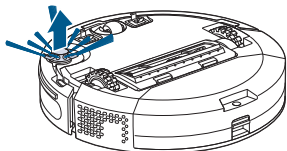

**1.** Tirare verso l'alto la base della spazzola.

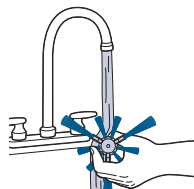

**2.** Sciacquare o immergere in acqua. Lasciare asciugare completamente prima di reinstallare.

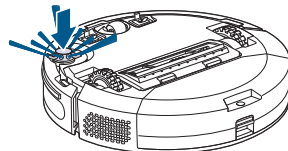

**3.** Spingere la spazzola sul supporto finché non scatta in posizione.

## Pulizia dei sensori

Dopo usi ripetuti, sui sensori del robot possono accumularsi detriti e le prestazioni possono risentirne.

Spegnerne l'interruttore di accensione e pulire i sensori con un panno per rimuovere eventuali detriti.

### Sensori e contatti

1. Sensori anticaduta
2. Punti di contatto per la ricarica
3. Sensore di riconoscimento delle superfici morbide

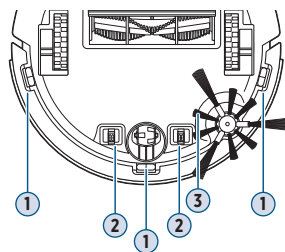

## Conservazione del robot

Riporre l'aspirapolvere robotico in sicurezza, in ambienti interni e al riparo da eventuali danni. Riporre con i cuscinetti Mop puliti e asciutti. Prima di riporre l'apparecchio, è necessario svuotare eventuali residui di detergente dal serbatoio Mop.

## Risoluzione dei problemi

Per una panoramica completa del prodotto, con suggerimenti e video di supporto, visitare il sito [support.BISSELL.com](http://support.BISSELL.com).

## AVVISO

- Per ridurre il rischio di fuoriuscite, non riporre la macchina in luoghi soggetti a gelo. I componenti interni potrebbero subire danni.
- Lo scollegamento della batteria distruggerà l'apparecchio e renderà nulla la garanzia.



# Bissell®



## SPINWAVE® R5 ROBOTSTOFZUIGER | MODELLEN 3552N, 3475N

Uw robot aankoppelen en opladen.....	42	Dweilmodus.....	45
Verbinding maken met de app.....	42	De rolborstel reinigen.....	47
Voorafgaand aan de reiniging.....	43	De randreinigingsborstel vervangen.....	47
In kaart brengen.....	43	De sensoren reinigen.....	48
Geplande reiniging.....	43	Uw robot opbergen.....	48
Modus droog stofzuigen.....	43	Probleemoplossing.....	48

### Inhoud

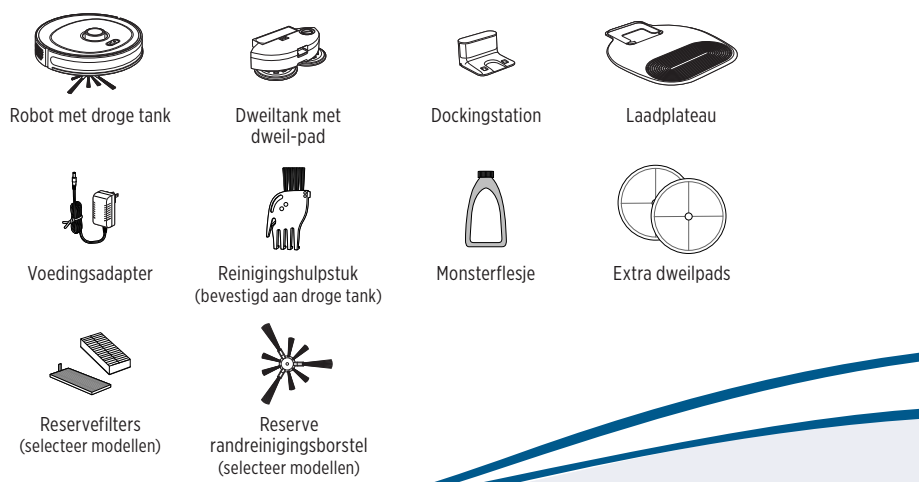

### Productoverzicht

1. Tankontgrendelingsknop
2. Aan/uit-schakelaar
3. Dweilpads
4. Bumper
5. Start/Pauze-knop
6. Home-knop

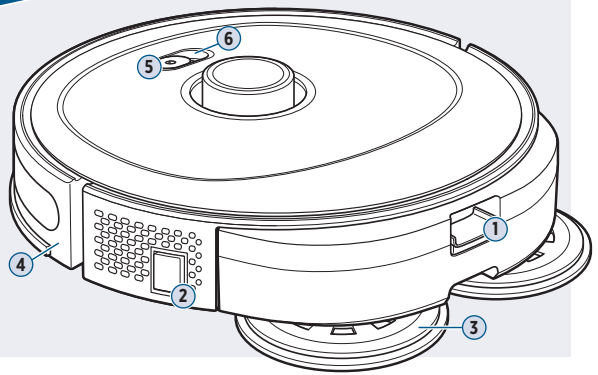

## Uw robot aankoppelen en opladen

**Let op:** het dockingstation en het laadplateau moeten op een harde ondergrond worden geïnstalleerd. De robotsensoren voor zachte oppervlakken voorkomen dat tapijten en vloerkleden in de dweilmodus worden gereinigd. Zorg ervoor dat het apparaat in de buurt van uw wifi-router staat en de robot tijdens de koppelprocedure volledig is opgeladen of in het dockingstation staat.

		
<p><b>1.</b> Verwijder de onderkant van het dockingstation en sluit de voedingsadapter aan. Overtollig snoer kan in het dockingstation worden gewikkeld. Plaats het deksel terug en steek de stekker in het stopcontact.</p>	<p><b>2.</b> Plaats het laadplateau tegen een muur en duw het dockingstation in het laadplateau.</p>	<p><b>3.</b> Schakel de robot in en plaats hem op het dockingstation. De eerste oplaadbeurt duurt 5 tot 6 uur.</p>

## Verbinding maken met de app

Download de BISSELL Connect-app om de reiniging op maat aan te passen. Maak reinigingszones aan of sluit zones uit, plan schoonmaakbeurten, bekijk het reinigingspad van de robot, volg de reinigingsgeschiedenis, bekijk meldingen, los problemen op en meer.

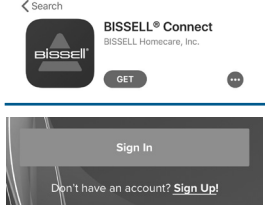
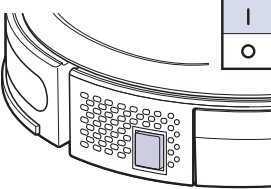
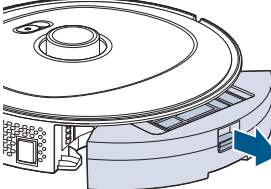
		
<p><b>1.</b> Download de BISSELL Connect-app uit de App Store of Google Play.</p> <p>Open de app en log in of maak een nieuwe account aan.</p>	<p><b>2.</b> Zorg ervoor dat u zich in de buurt van uw wifi-router bevindt voordat u de robot inschakelt (I).</p> <p>Selecteer in de app 'Hebt u een BISSELL Connect Product? Maak er nu verbinding mee.' Kies 'SpinWave R5' in het menu.</p>	<p><b>3.</b> Verwijder het vuilreservoir en draai de robot om toegang te krijgen tot de QR-code voor het instellen.</p>

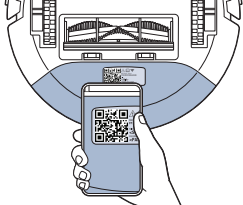
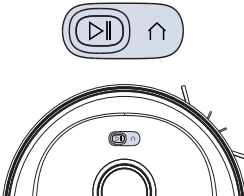
	
<p><b>4.</b> Scan de QR-code en volg de instructies in de app om te koppelen.</p>	<p><b>5.</b> Om de robot in de koppelmodus te zetten, drukt u gedurende 3 seconden op de start + home-knop.</p>

## Voorafgaand aan de reiniging

- Raap rondslingerend speelgoed, koorden, kleding of andere voorwerpen op die uw robot kunnen hinderen.
- Zet fragiele voorwerpen vast of zet ze ergens anders, want uw robot kan lichtere voorwerpen over de vloer slepen.

## In kaart brengen

Uw robot maakt een virtuele kaart van uw huis om aangepaste reinigingsopties mogelijk te maken. Open de BISSELL Connect-app en druk op start. De robot begint met het in kaart brengen en reinigen. Uw robot maakt een kamer in delen schoon, beginnend met de omtrek van het desbetreffende deel, dat met een gestructureerd patroon wordt ingevuld.

**Let op:** als de robot naar een gebied buiten het oorspronkelijk in kaart gebrachte gebied wordt verplaatst, zal hij dit als een nieuwe ruimte zien en het kaartproces opnieuw starten. Hiermee worden de originele kaart en alle eerder gemaakte zones verwijderd.

### Tips voor het in kaart brengen

- Laat de robot in de modus droog stofzuigen ruimtes in kaart brengen, zodat hij alle vloertypes in kaart brengt.
- Open deuren en verwijder obstakels zodat de robot zich vrij kan verplaatsen.
- Gebruik nadat alles in kaart is gebracht de app om de reiniging op maat aan te passen. Creëer virtuele "go" of "no-go" zones en creëer virtuele muren op de kaart.

## Geplande reiniging

Download de **BISSELL Connect App** om automatische functies in te stellen.

Met de app kunt u een dag en tijdstip instellen waarop de robot automatisch moet werken. Zodra de robot is verbonden en een kaart is gemaakt, gaat u naar het tabblad Planning en volgt u de aanwijzingen op het scherm.

## Modus droog stofzuigen

### Handmatige reiniging

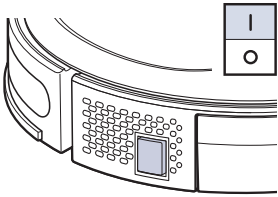
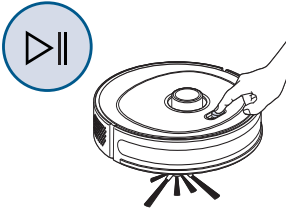
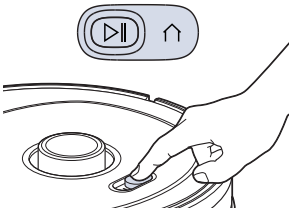
		
<p><b>1.</b> Schakel de robot in (I).</p>	<p><b>2.</b> Start de robot met de app of druk op de start/pauze-knop</p>	<p><b>3.</b> Wanneer de robot klaar is met reinigen, keert hij automatisch terug naar het dockingstation. Als u wilt dat hij eerder naar het dockingstation terugkeert, druk dan op de start/pauzeknop en vervolgens op de home-knop.</p>



## Spot-modus

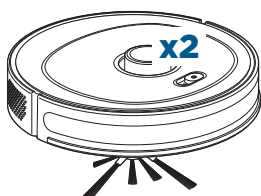

**1.** Plaats de robot in het midden van het gebied dat u wilt reinigen.

Om te beginnen met reinigen, drukt u tweemaal op de start/pauzeknop of selecteert u de 'Spot'-modus in de app.

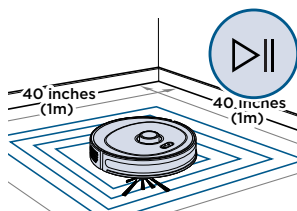

**2.** De robot zal ongeveer 5 minuten lang in een vierkant patroon een gebied van ongeveer 1m x 1m reinigen. De robot piept wanneer hij klaar is en keert terug naar het dockingstation.

## Het vuilreservoir onderhouden

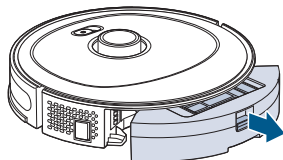

**1.** Zet de stroomschakelaar uit. Duw de knop boven op het vuilreservoir in en trek het reservoir eruit.

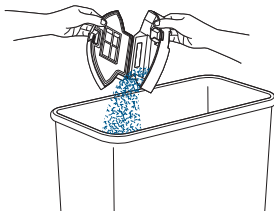

**2.** Open de filterklep door beide zijden uit elkaar te trekken. Verwijder het vuil uit het vuilreservoir.

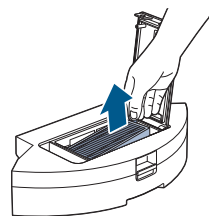

**3.** Verwijder de bovenklep van de tank op en trek de filter eruit.

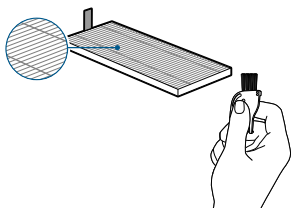

**4.** Gebruik het schoonmaakgereedschap om de filter schoon te borstelen. **Was de filter niet uit.**

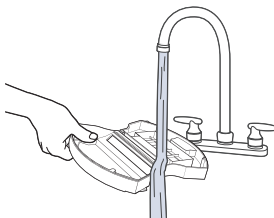

**5.** Spoel het vuilreservoir af met kraanwater als de filter is verwijderd. Zorg ervoor dat het vuilreservoir helemaal droog is voordat u het terugplaatst. **Maak het vuilreservoir niet schoon in de vaatwasser.**

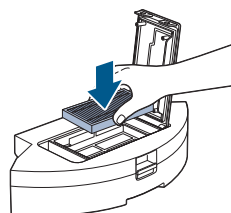

**6.** Plaats de filter na het schoonmaken terug, sluit het vuilreservoir en plaats het terug in het apparaat.

## Dweilmodus

▶ Liever een video? Open de **BISSELL Connect-app** voor instructievideo's.

### De dweiltank vullen

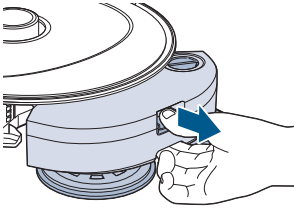
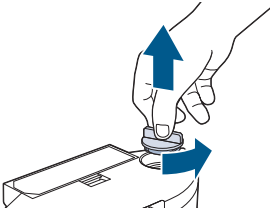
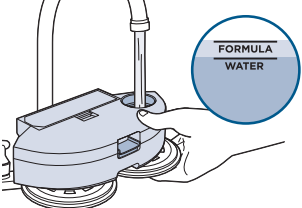
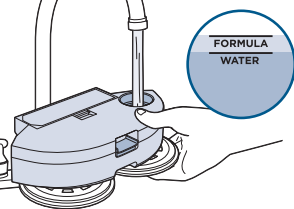
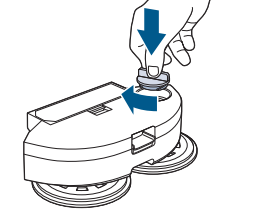
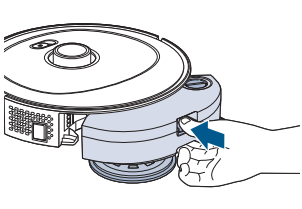
		
<p><b>1.</b> Zet de stroomschakelaar uit. Druk op de knop boven op de tank en trek om de tank te verwijderen.</p>	<p><b>2.</b> Draai om de tankdop te ontgrendelen en trek omhoog om te verwijderen.</p>	<p><b>3.</b> Voeg eerst water toe tot aan de vullijn 'Water'.</p>
		
<p><b>4.</b> Vul bij met een schoonmaakmiddel van BISSELL tot aan de vulstreep 'schoonmaakmiddel'.</p>	<p><b>5.</b> Draai de dop van de dweiltank weer vast.</p>	<p><b>6.</b> Plaats de tank terug en zorg ervoor dat deze op zijn plaats klikt. <b>Let op:</b> houd de tank recht om lekken te voorkomen.</p>

### Handmatige reiniging

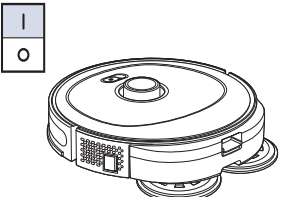
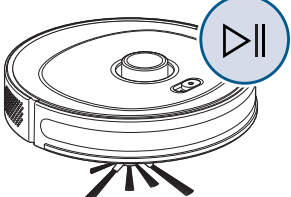
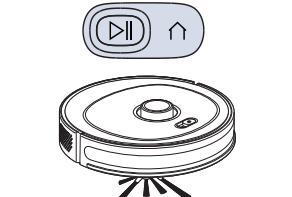
		
<p><b>1.</b> Schakel de robot in.</p>	<p><b>2.</b> Start de robot automatisch met de app of handmatig met een druk op de start/pauze-knop.</p>	<p><b>3.</b> Wanneer de robot klaar is met reinigen, keert hij terug naar het dockingstation. Als u wilt dat hij eerder naar het dockingstation terugkeert, druk dan op de start/pauzeknop en vervolgens op de home-knop.</p>

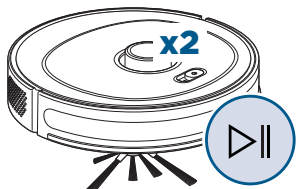
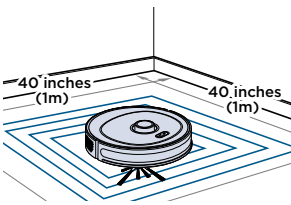
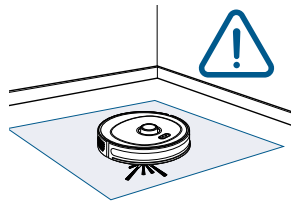

## Spot-modus

		
<p><b>1.</b> Plaats de robot in het midden van het gebied dat u wilt reinigen. Om te beginnen met reinigen, drukt u tweemaal op de start/pauzeknop of selecteert u de Spot-modus in de BISSELL Connect-app.</p>	<p><b>2.</b> De robot zal ongeveer 5 minuten lang in een vierkant patroon een gebied van ongeveer 1m x 1m reinigen. Hij piept wanneer hij klaar is en keert terug naar het dockingstation.</p>	<p><b>3.</b> Wees voorzichtig wanneer u door het gebied loopt, want de vloer kan glad zijn. Laat 5 minuten nat blijven</p>

## De dweilpads en vuilopvanger onderhouden

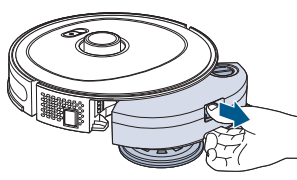
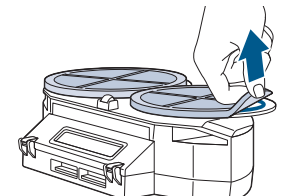
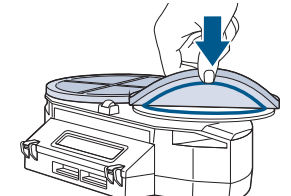
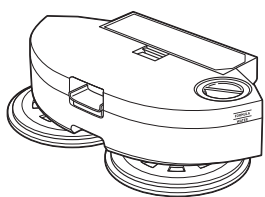
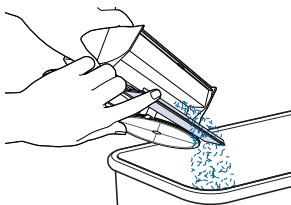
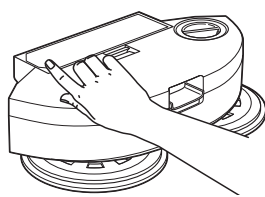
		
<p><b>1.</b> Zet de stroomschakelaar uit. Druk op de knop boven op de dweiltank en trek om de tank te verwijderen. Plaats de tank ondersteboven op een zacht oppervlak.</p>	<p><b>2.</b> Trek de dweilpads stevig omhoog om ze van de dweilpadhouders af te halen. Vervang dweilpads als ze beschadigd zijn. Was ze apart in de wasmachine op een warme temperatuur.</p>	<p><b>3.</b> Gebruik het middelste gat op de pads om ze uit te lijnen met de houder.</p>
		
<p><b>4.</b> Leeg het vuilreservoir na elk gebruik.</p>	<p><b>5.</b> Druk op het lipje aan de bovenzijde van de dweiltank om het vuilreservoir te openen en leeg te maken.</p>	<p><b>6.</b> Til het filterdeksel bovenop de tank op en verwijder de filter. Borstel het stof en vuil van de filter.</p>

## De rolborstel reinigen

➔ Bekijk de **BISSELL Connect-app** voor tips en video's over onderhoud.

		
<p><b>1.</b> Zet de stroomschakelaar uit. Duw de lipjes op de borstelkap naar binnen en trek eraan om de borstelkap te verwijderen. Til op om de rolborstel te verwijderen.</p>	<p><b>2.</b> Reinig de rolborstel met het schoonmaakgereedschap. Verwijder de eindkappen van de borstelrol door ze uit elkaar te trekken voor u ze grondig schoonmaakt.</p>	<p><b>3.</b> Plaats de rolborstel en de borstelbeschermer terug.</p>

## De randreinigingsborstel vervangen

Af en toe moeten de randreinigingsborstels worden schoongemaakt zodat ze weer effectief functioneren.

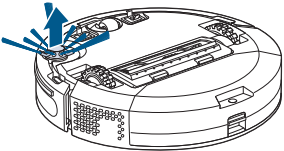
		
<p><b>1.</b> Trek de onderkant van de borstel omhoog.</p>	<p><b>2.</b> Afspoelen of weken in water. Laat volledig drogen voordat u hem terugplaatst.</p>	<p><b>3.</b> Druk de borstelop de houder tot deze op zijn plaats klikt.</p>

## De sensoren reinigen

Na herhaald gebruik kan het vuil zich ophopen op de sensoren van de robot. Daardoor kan de prestatie van de robot beïnvloed worden.

Zet de stroomschakelaar uit en veeg de sensoren schoon met een doek om eventueel vuil te verwijderen.

### Sensoren en contacten

1. Afgrondsensoren
2. Contactpunten voor opladen
3. Sensor voor het vermijden van zachte oppervlakken

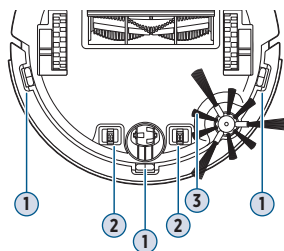

## Uw robot opbergen

Bewaar uw robotstofzuiger veilig binnen op een plek waar de kans klein is dat hij beschadigd raakt. Berg de robot op met schone, droge dweilpads. Eventuele reinigingsoplossing die nog in de dweiltank zit, moet worden uitgegoten voordat u de robot opbergt.

## Probleemoplossing

Bezoek [support.BISSELL.com](https://support.BISSELL.com) voor een uitgebreid overzicht van uw product en ondersteuningstips en video's.

## LET OP

- Bewaar het apparaat niet op een plek waar het kan vriezen en vermijd zo het risico op lekkages. Dit zou de interne onderdelen kunnen beschadigen.
- Als u de batterij loskoppelt, gaat het apparaat kapot en vervalt de garantie.



# BISSELL®



## SPINWAVE® R5

### ASPIRADOR ROBÓTICO | MODELOS 3552N, 3475N

Colocar o robô na estação de carregamento e carregar o robô.....	50	Modo mopa.....	53
Ligar à aplicação.....	50	Limpar o rolo da escova.....	55
Antes de limpar.....	51	Substituir a escova de limpeza de extremidades.....	55
Mapeamento.....	51	Limpar os sensores.....	56
Limpeza programada.....	51	Guardar o robô.....	56
Modo Aspiração a seco.....	51	Resolução de problemas.....	56

### Conteúdo da caixa!



Robô com depósito seco



Depósito de mopa com panos de mopa



Estação de carregamento



Bandeja de carregamento



Adaptador de corrente



Ferramenta de limpeza (anexada ao depósito seco)



Fórmula de teste

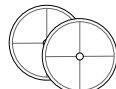

Panos de mopa adicionais



Filtros sobresselentes (modelos selecionados)



Escova de limpeza de cantos sobresselente (modelos selecionados)

### Visualização do produto

1. Botão de liberação de depósito
2. Interruptor de alimentação
3. Panos de mopa
4. Para-choques
5. Botão Play/Pause (Ligar/Pausa)
6. Botão Home (Início)

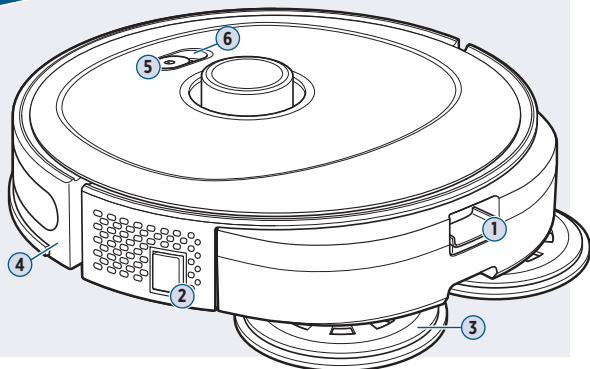

## Colocar o robô na estação de carregamento e carregar o robô

**Nota:** a estação e a bandeja devem ser instaladas numa superfície dura. Os sensores de superfície macia do robô impedem-no de limpar alcatifas e tapetes no modo Mop (mopa). Certifique-se de que o dispositivo está perto do router de Wi-Fi e que o robô está totalmente carregado ou na base durante o processo de emparelhamento.

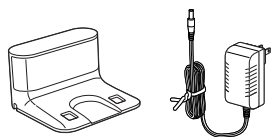

**1.** Remova a tampa inferior da base de carregamento e ligue o adaptador de corrente. O excesso de cabo pode ser enrolado dentro da base. Recoloque a tampa e ligue-a à tomada de parede.

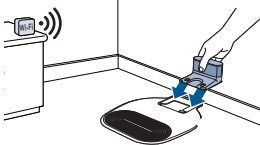

**2.** Coloque a bandeja contra uma parede e a ponta para fazer deslizar a base para dentro da bandeja.

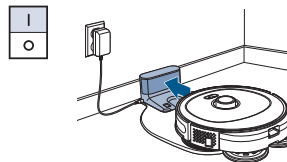

**3.** Ligue o robô e coloque-o na estação. O primeiro carregamento demorará entre 5 a 6 horas.

## Ligar à aplicação

Transfira a aplicação BISSELL Connect para personalizar a sua limpeza. Crie zonas de limpeza ou zonas proibidas, agende limpezas, visualize o caminho de limpeza do robô, acompanhe o histórico de limpeza, visualize notificações, solucione problemas e muito mais.

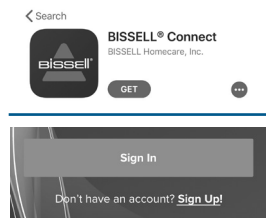

**1.** Transfira a aplicação BISSELL Connect a partir da App Store ou da Google Play.

Abra a aplicação e inicie sessão ou crie uma nova conta.

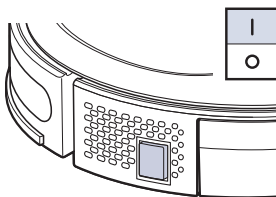

**2.** Certifique-se de que está perto do router de Wi-Fi antes de ligar (ON) o robô (I).

Na aplicação, selecione "Tem um produto BISSELL com ligação? Estabeleça a ligação agora." Escolha "SpinWave R5" no menu.

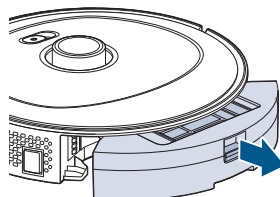

**3.** Remova o depósito de sujidade e vire o robô para aceder ao código QR de configuração.

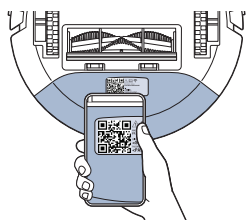

**4.** Leia o código QR e siga as instruções na aplicação para emparelhar.

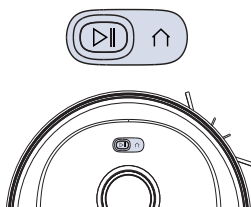

**5.** Para emparelhar o robô, prima e mantenha pressionados os botões play + home durante 3 segundos.

## Antes de limpar

- Apanhe brinquedos soltos, cordões, vestuário ou outros objetos que possam interferir com o robô.
- Prenda ou mova os objetos frágeis, pois o robô pode empurrar objetos mais leves ao longo do chão.

## Mapeamento

O robô criará um mapa virtual da sua casa para permitir opções de limpeza personalizadas. Abra a aplicação BISSELL Connect e prima Iniciar. O robô começará a mapear e a limpar simultaneamente. O robô irá limpar um quarto em secções, começando com o perímetro dessa secção, e preenchendo um padrão estruturado.

**Nota:** se o robô for movido para uma zona fora da área mapeada originalmente, tal será visto como um novo espaço e reiniciará o processo de mapeamento. Esta ação irá eliminar o mapa original e quaisquer zonas previamente criadas.

### Dicas para mapeamento

- Realize o mapeamento no modo de aspiração a seco para garantir que o robô mapeia todos os tipos de pavimentos.
- Abra as portas e remova as barreiras para permitir que o robô mapeie livremente.
- Após o mapeamento, utilize a aplicação para personalizar a limpeza. Crie zonas virtuais de "go" (ir) ou "no-go" (não ir) e crie paredes virtuais no mapa.

## Limpeza programada

Transfira a **aplicação BISSELL Connect** para configurar as funcionalidades automáticas.

Pode designar um dia e uma hora para o seu robô funcionar automaticamente utilizando a aplicação. Quando o robô estiver ligado e tiver sido criado um mapa, aceda ao separador Calendarização e siga as instruções no ecrã.

## Modo Aspiração a seco

### Limpeza manual

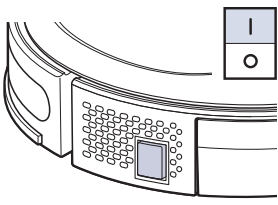
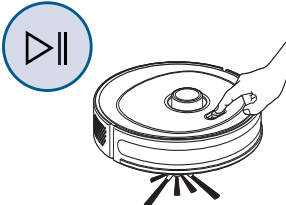
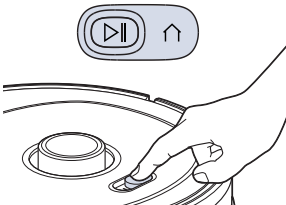
		
<p><b>1.</b> Ligue o robô (ON) (I).</p>	<p><b>2.</b> Inicie o robô através da aplicação ou premindo o botão Play/Pause (Ligar/Pausa).</p>	<p><b>3.</b> Ao terminar a limpeza, o robô regressa automaticamente à estação de carregamento. Se desejar que este regresso à base seja mais cedo, prima o botão Play/Pause (Ligar/Pausa) e, em seguida, prima o botão Home (Início).</p>

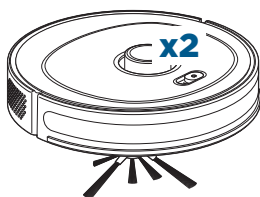
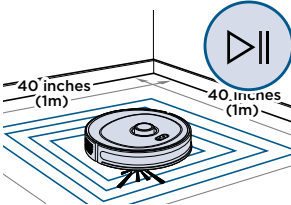

## Modo Spot

	
<p><b>1.</b> Coloque o robô no centro da área que pretende limpar.</p> <p>Para iniciar a limpeza, pressione o botão Play/Pause (Ligar/Pausa) duas vezes ou selecione o modo "Spot" na aplicação.</p>	<p><b>2.</b> O robô irá limpar num padrão quadrado que cobre uma área de aproximadamente 40" x 40" durante cerca de 5 minutos. O robô emitirá um "bip" após terminar e regressar à estação.</p>

## Manutenção do depósito de sujidade

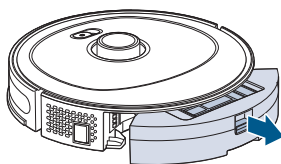
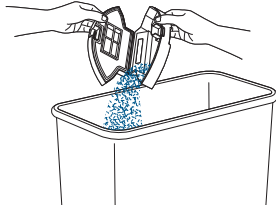
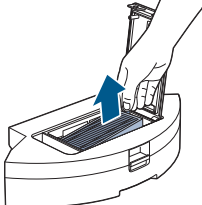
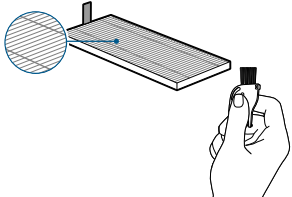
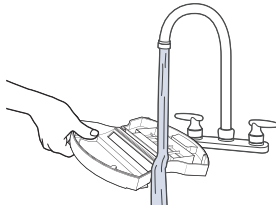
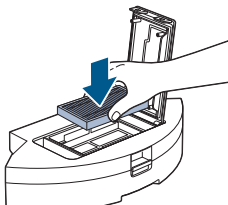
		
<p><b>1.</b> Desligue o interruptor (OFF) de alimentação. Prima o botão na parte superior do depósito de sujidade e puxe para retirar.</p>	<p><b>2.</b> Abra o depósito de sujidade, separando ambos os lados. Despeje os detritos para um caixote do lixo.</p>	<p><b>3.</b> Levante a tampa superior do depósito e puxe o filtro para fora.</p>
		
<p><b>4.</b> Utilize a ferramenta de limpeza para escovar o filtro. <b>Não lave.</b></p>	<p><b>5.</b> Depois de retirar o filtro, lave o depósito de sujidade com água da torneira. Antes de voltar a colocar o depósito de sujidade, certifique-se de que este está completamente seco. <b>Não lave o depósito de sujidade na máquina.</b></p>	<p><b>6.</b> Depois de limpar, volte a instalar o filtro, feche e encaixe-o novamente na máquina.</p>

## Modo mopa

▶ Gosta mais de vídeos? Abra a **aplicação BISSELL Connect** para ver vídeos de instruções.

### Encher o depósito da mopa

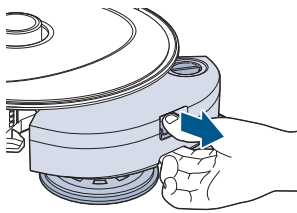
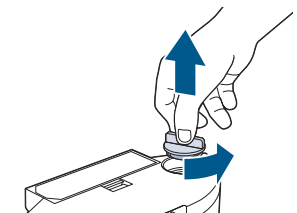
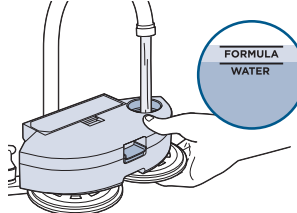
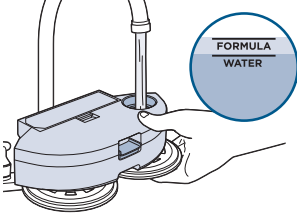
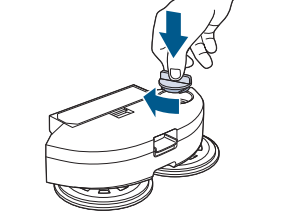
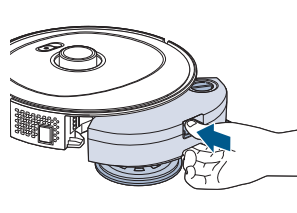
		
<p><b>1.</b> Desligue o interruptor (OFF) de alimentação. Pressione o botão na parte superior do depósito e puxe para retirar.</p>	<p><b>2.</b> Rode para destrancar a tampa do depósito e puxe para cima para retirar.</p>	<p><b>3.</b> Primeiro, adicione água até chegar ao nível da linha de preenchimento "Água".</p>
		
<p><b>4.</b> A seguir, adicione a fórmula BISSELL até ao nível da linha de preenchimento "Fórmula".</p>	<p><b>5.</b> Volte a colocar a tampa no lugar.</p>	<p><b>6.</b> Volte a instalar o depósito e certifique-se de que ouve um clique. <b>Nota:</b> respeite o nível do depósito para evitar fugas.</p>

### Limpeza manual

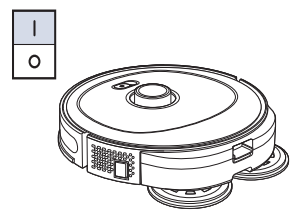
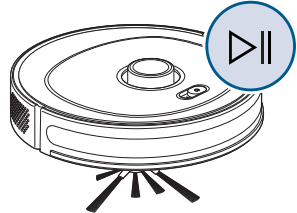
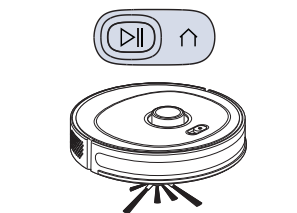

		
<p><b>1.</b> Ligue o robô (ON).</p>	<p><b>2.</b> Inicie o robô automaticamente, através da aplicação, ou manualmente premindo o botão Play/Pause (Ligar/Pausa).</p>	<p><b>3.</b> Ao terminar a limpeza, o robô irá regressar à estação de carregamento. Se desejar que este regresso à base mais cedo, prima o botão Play/Pause (Ligar/Pausa) e, em seguida, prima o botão Home (Início).</p>

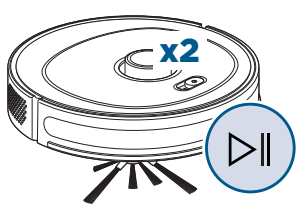
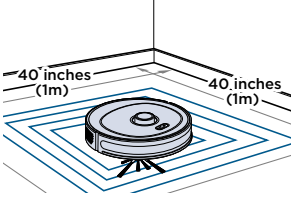
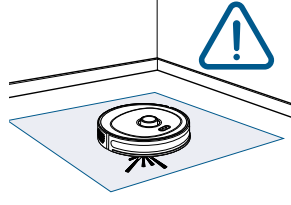

## Modo Spot

		
<p><b>1.</b> Coloque o robô no centro da área que pretende limpar. Para iniciar a limpeza, pressione o botão play/pause (ligar/pausa) duas vezes ou selecione o modo "Spot" na aplicação BISSELL Connect.</p>	<p><b>2.</b> O robô irá limpar num padrão quadrado que cobre uma área de aproximadamente 40" x 40" durante cerca de 5 minutos. Emitirá um "bip" após terminar e regressar à estação.</p>	<p><b>3.</b> Tenha cuidado ao andar pela área, pois o chão poderá estar escorregadio. Deixe o produto atuar no pavimento durante 5 minutos.</p>

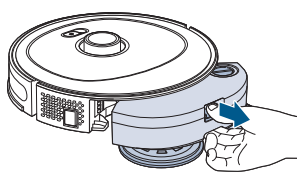
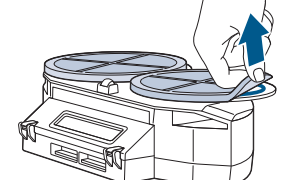
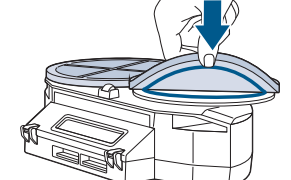
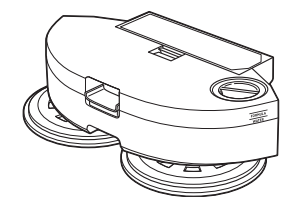
## Manutenção dos panos de mopa e do reservatório de detritos

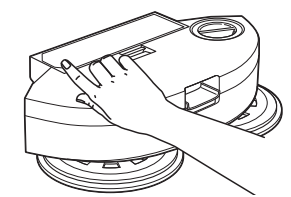
		
<p><b>1.</b> Desligue o interruptor (OFF) de alimentação. Prima o botão na parte superior do depósito de mopa e puxe para retirar. Coloque o depósito de cabeça para baixo numa superfície macia.</p>	<p><b>2.</b> Puxe firmemente os panos de mopa para retirá-los. Substitua os panos de mopa se estiverem danificados. Lave separadamente em água morna.</p>	<p><b>3.</b> Para voltar a fixar, utilize o orifício médio nos panos para alinhar com o ponto de fixação.</p>
		
<p><b>4.</b> Esvazie o depósito de sujidade após cada utilização.</p>	<p><b>5.</b> Empurre a aba na parte superior do depósito da mopa para abrir e esvaziar o depósito de sujidade.</p>	<p><b>6.</b> Levante a tampa do filtro na parte superior do depósito e retire o filtro. Remova a poeira e os detritos do filtro.</p>

## Limpar o rolo da escova

↖ Consulte a **aplicação BISSELL Connect** para obter sugestões e vídeos sobre manutenção.

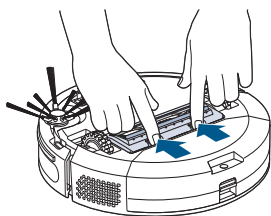

**1.** Desligue o interruptor (OFF) de alimentação. Aperte as abas na proteção da escova e puxe para retirar. Eleve para retirar o rolo de escova.

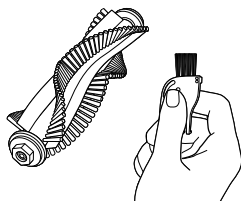

**2.** Limpe o rolo de escova com a ferramenta de limpeza. Retire as tampas terminais do rolo de escova, separando-as para limpar minuciosamente.

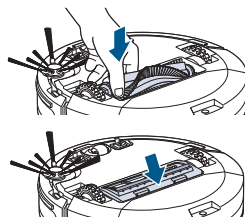

**3.** Volte a montar o rolo de escova e a proteção da escova.

## Substituir a escova de limpeza de extremidades

A escova de limpeza de extremidades tem de ser limpa para funcionar de forma mais eficaz.

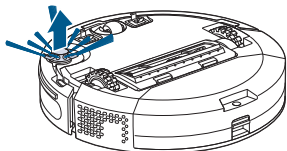

**1.** Puxe para cima na base da escova.

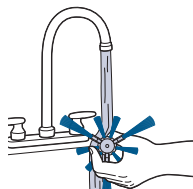

**2.** Enxague ou demolhe em água. Deixe secar completamente antes de voltar a instalar.

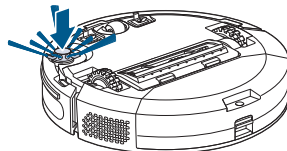

**3.** Empurre a escovasobre o suporte até que encaixe no lugar.

## Limpar os sensores

Após uma utilização repetida, os detritos podem acumular-se nos sensores do robô e afetar o respetivo desempenho.

Desligue o interruptor de alimentação e limpe os sensores com um pano para remover quaisquer detritos.

### Sensores e contactos

1. Sensores de queda
2. Carregar pontos de contacto
3. Sensor de desvio de superfície macia

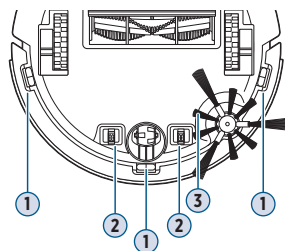

## Guardar o robô

Guarde o aspirador robô em segurança dentro de casa, onde não possa sofrer danos. Guarde-o com panos de mopa limpos e secos. Qualquer solução restante no depósito da mopa deve ser esvaziada antes do armazenamento.

## Resolução de problemas

Para obter informações detalhadas sobre o seu produto e vídeos e sugestões de assistência, visite [support.BISSELL.com](http://support.BISSELL.com).

### AVISO

- Para reduzir o risco de fugas, não armazene a máquina onde possa ocorrer congelamento. Tal pode resultar em danos nos componentes internos.
- Desligar a bateria irá destruir o aparelho e invalidar a garantia.

