

# PHILIPS

## 6805 / 6855 series Quick Start Guide

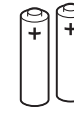
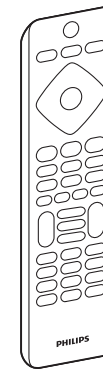
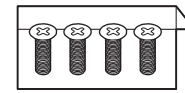
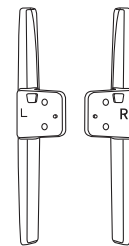
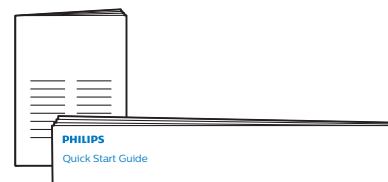
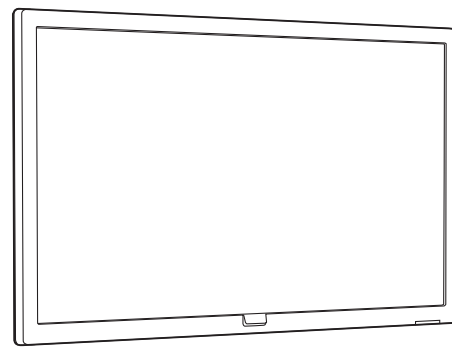

(EU)

(UK)

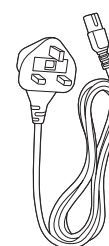
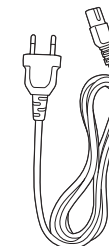

A

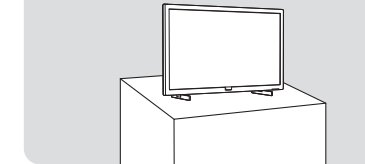

B

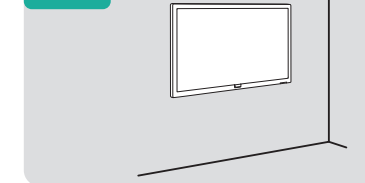

A

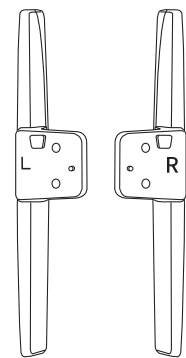
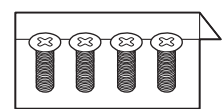
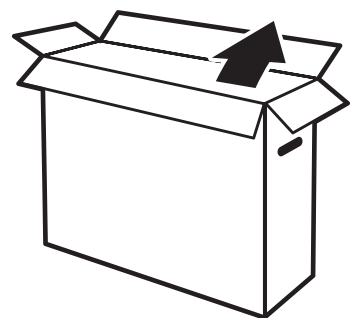

1

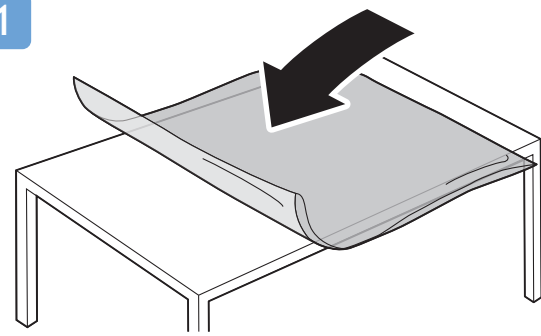

2

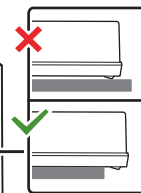
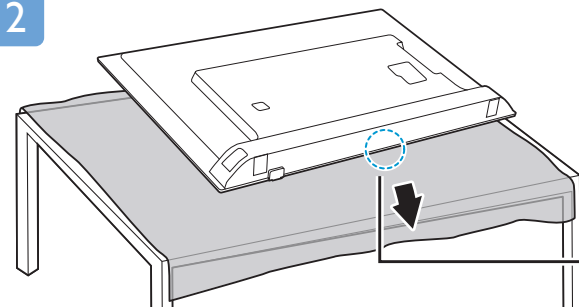

3

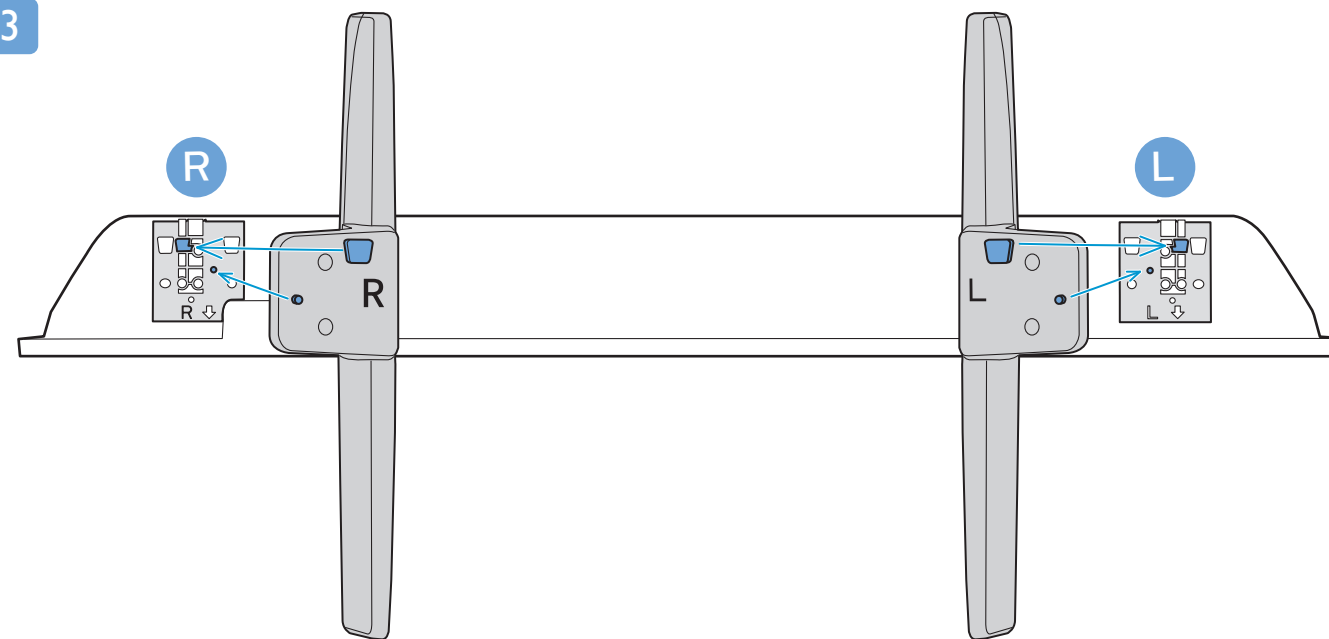

5

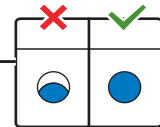
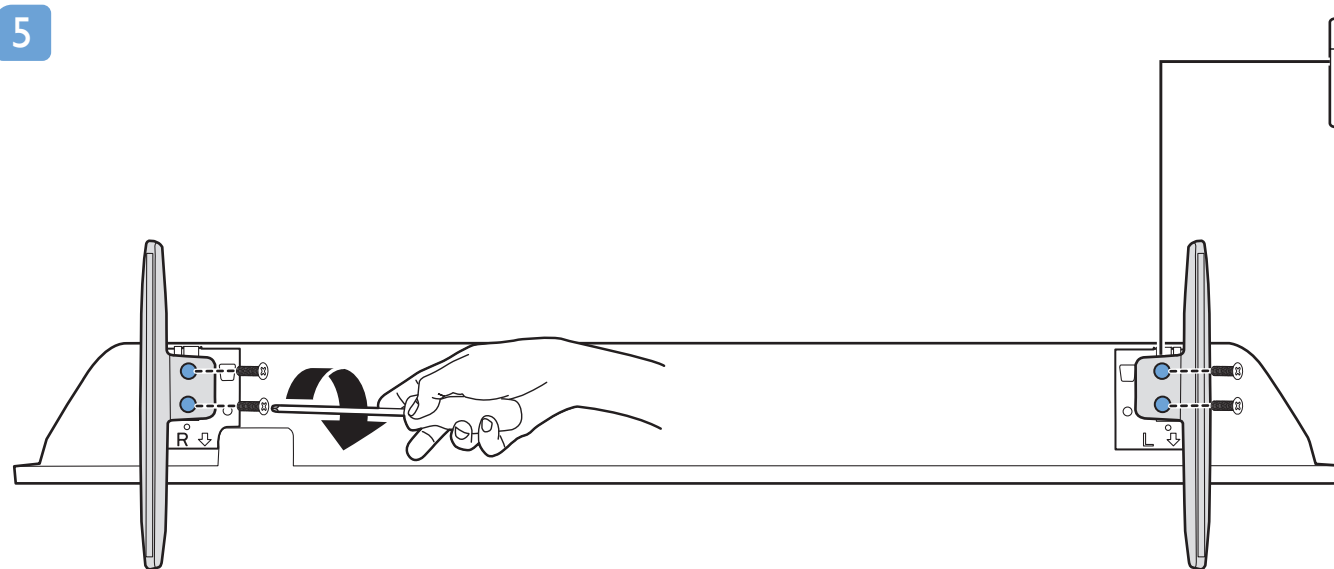

9

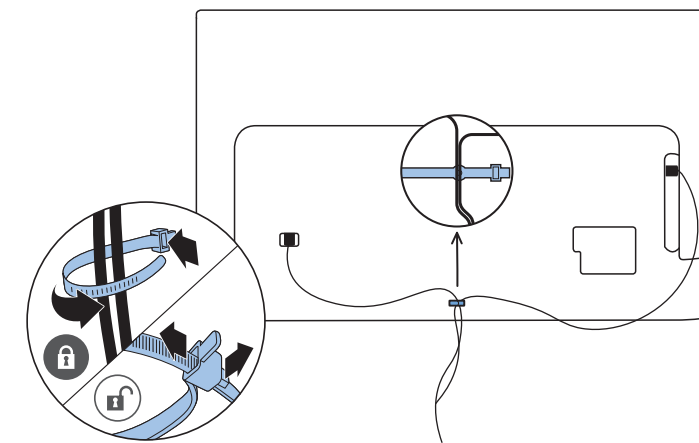
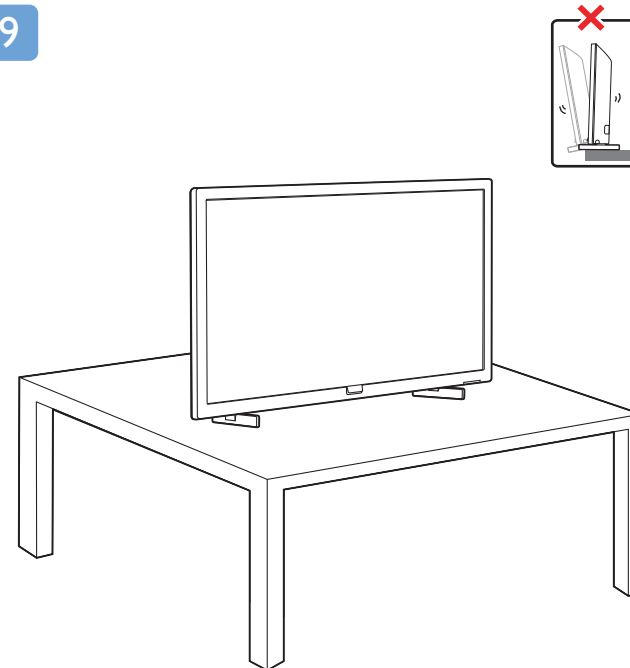



**English** Read the safety instructions.  
**Български** Прочетете инструкциите за безопасност.  
**Čeština** Přečtěte si bezpečnostní pokyny.  
**Hrvatski** Pročitajte sigurnosne upute.  
**Dansk** Læs sikkerhedsforskrifterne.  
**Deutsch** Lesen Sie die Sicherheitshinweise.  
**Ελληνικά** Διαβάστε τις οδηγίες ασφαλείας.  
**Eesti** Lugege ohutusõudeid.  
**Español** Lea las instrucciones de seguridad.

**Français** Lisez les consignes de sécurité.  
**Italiano** Leggere le istruzioni di sicurezza.  
**Қазақша** Қорғаныстық нұсқаулар.  
**Latviešu** Izlasiet drošības norādījumus.  
**Lietuvių** Perskaitykite saugos instrukcijas.  
**Magyar** Olvassa el a biztonságási utasításokat.  
**Nederlands** Lees de veiligheidsvoorschriften.  
**Norsk** Les sikkerhetsforskriften.  
**PolSKI** Zapoznaj się z instrukcjami bezpieczeństwa.

**Português** Leia as instruções de segurança.  
**Română** Citiți instrucțiunile de siguranță.  
**Русский** Читайте инструкции по технике безопасности.  
**Srpski** Pročitajte bezbednosna uputstva.  
**Slovenščina** Preberite varnostna navodila.  
**Slovenský** Prečítajte si bezpečnostné pokyny.  
**Suomi** Lue turvaohjeet.  
**Svenska** Läs säkerhetsinstruktionerna.  
**ภาษาไทย** โปรดอ่านคำแนะนำด้านความปลอดภัย

**Türkçe** Güvenlik talimatlarını okuyun.  
**Українська** Читайте інструкції з техніки безпеки.  
**العربية** قراءة تعليمات السلامة.  
**עברית** קראו את הוראות הבטיחות



Register your product and get support at [www.philips.com/TVsupport](http://www.philips.com/TVsupport)

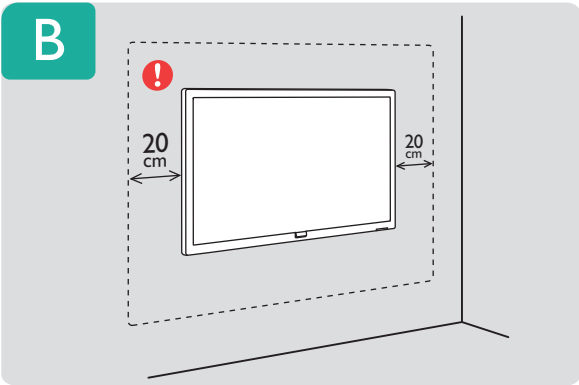

**VESA (x,y)**



32" 100 mm M6 (L: 12 mm-16 mm)

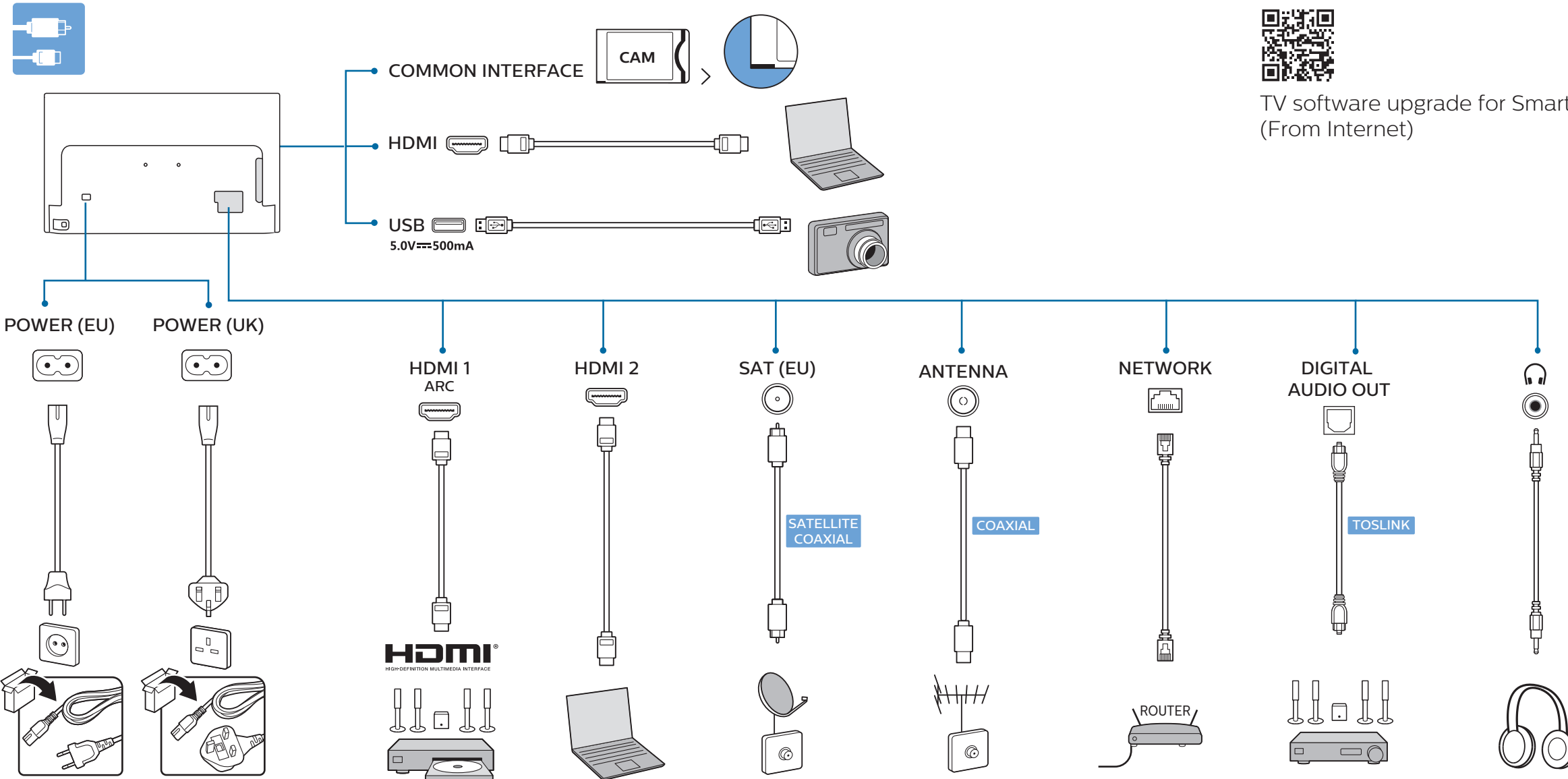
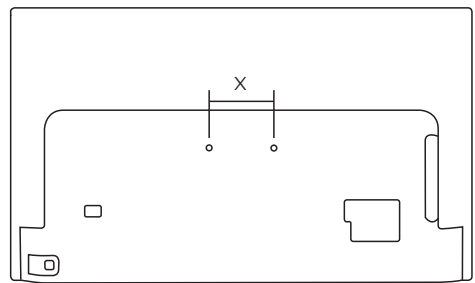
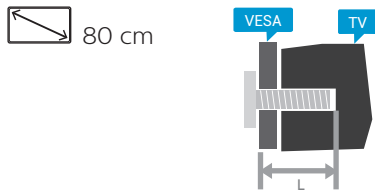

TV software upgrade for Smart TV- (From Internet)



2x AAA R03 1.5V

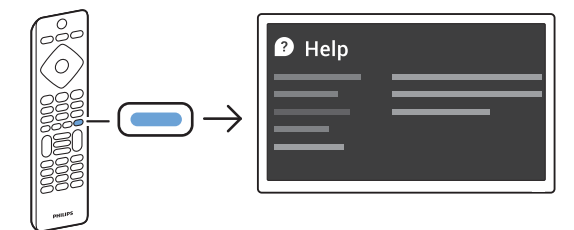
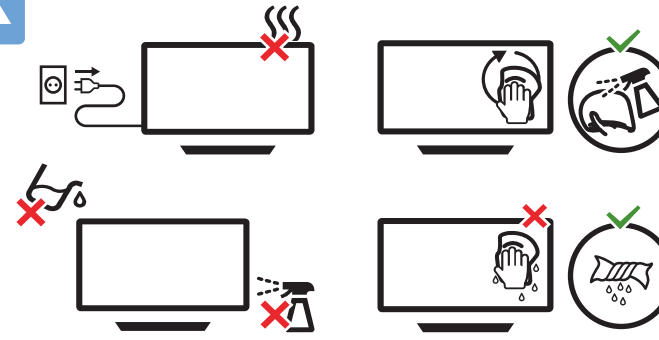
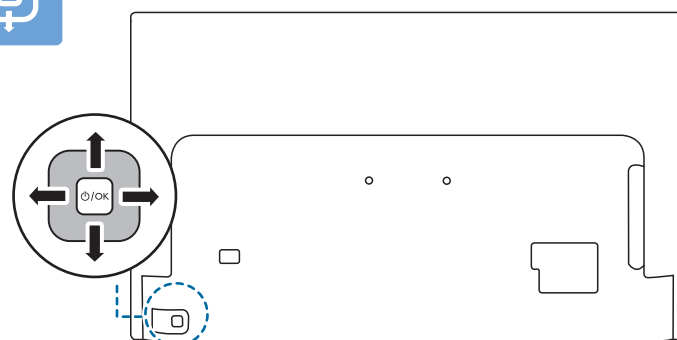
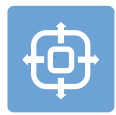
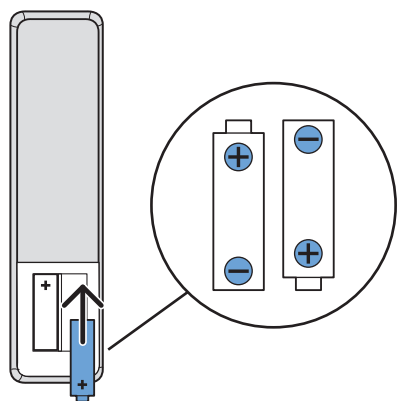

All registered and unregistered trademarks are property of their respective owners. Specifications are subject to change without notice. Philips and the Philips' shield emblem are trademarks of Koninklijke Philips N.V. and are used under license from Koninklijke Philips N.V. 2020 © TP Vision Europe B.V. All rights reserved. philips.com