

# Liquid Freezer III 420

Multikompatibler All-in-One CPU-Wasserkühler



## Allgemeine Spezifikationen

Kompatibilität	Intel® LGA1700   AMD® AM5, AM4
PI   NNPI	374   339
Wärmeleitpaste	MX-6 (0,8g)
Garantie	6 Jahre
Betriebsumgebungstemperatur	0-40°C
Gewicht	2235 g
All-In-One-Anschluss	4-Pin-PWM-Buchse

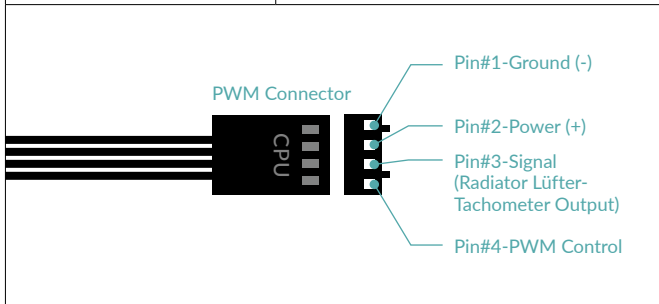

Geteilter Anschluss	3x 4-Pin-PWM-Buchse
---------------------	---------------------

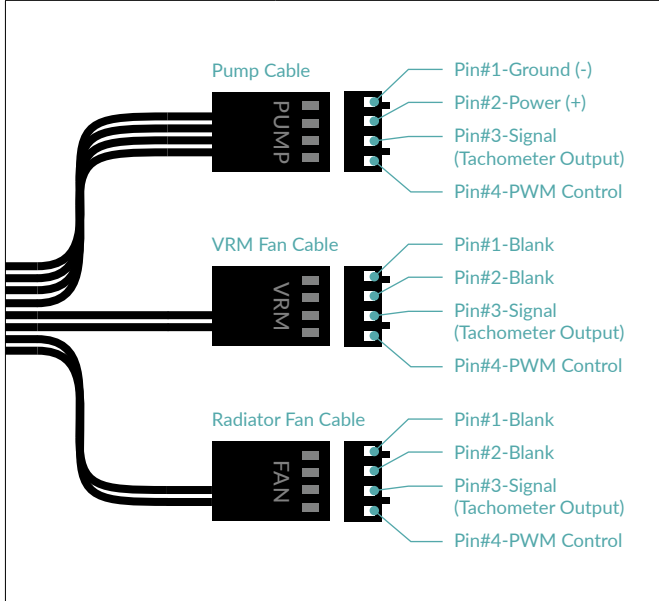

Pumpe	800-2800 rpm (PWM-gesteuert)
Strom   Spannung	0,35 A   12 V DC
Cold Plate	Kupfer, Micro-Skived-Fins
Schlauchlänge	450 mm
Schlauchdurchmesser	Äußerer: 12,4 mm   Innerer: 6,0 mm

<b>Radiator</b>	
Material	Aluminium
Abmessungen	458 (L) x 138 (B) x 38 (H) mm
<b>VRM-Modul</b>	
VRM-Lüfter	400-2500 rpm (PWM-gesteuert)
Strom   Spannung	0,05 A   12 V DC

## Radiatorlüfter-Spezifikationen

Allgemein	3x P14 PWM
Geschwindigkeit	200-1700 rpm
Luftstrom	72,80 cfm   123,76 m³/h
Statischer Druck	2,40 mmH₂O
Lager	Hydrodynamisches Gleitlager
Strom   Spannung	0,12 A   12 V DC
Kabellänge	40 mm
Anschluss	4-Pin-PWM-Buchse

## Versandinformationen - LF III 420 (Black)

Box Abmessungen	447 (L) x 328 (B) x 158 (H) mm
Brutto Gewicht	2900 g
SKU	ACFRE00137A
EAN	4895213704496
UPC	840033402262

# Liquid Freezer III 420

Multikompatibler All-in-One CPU-Wasserkühler

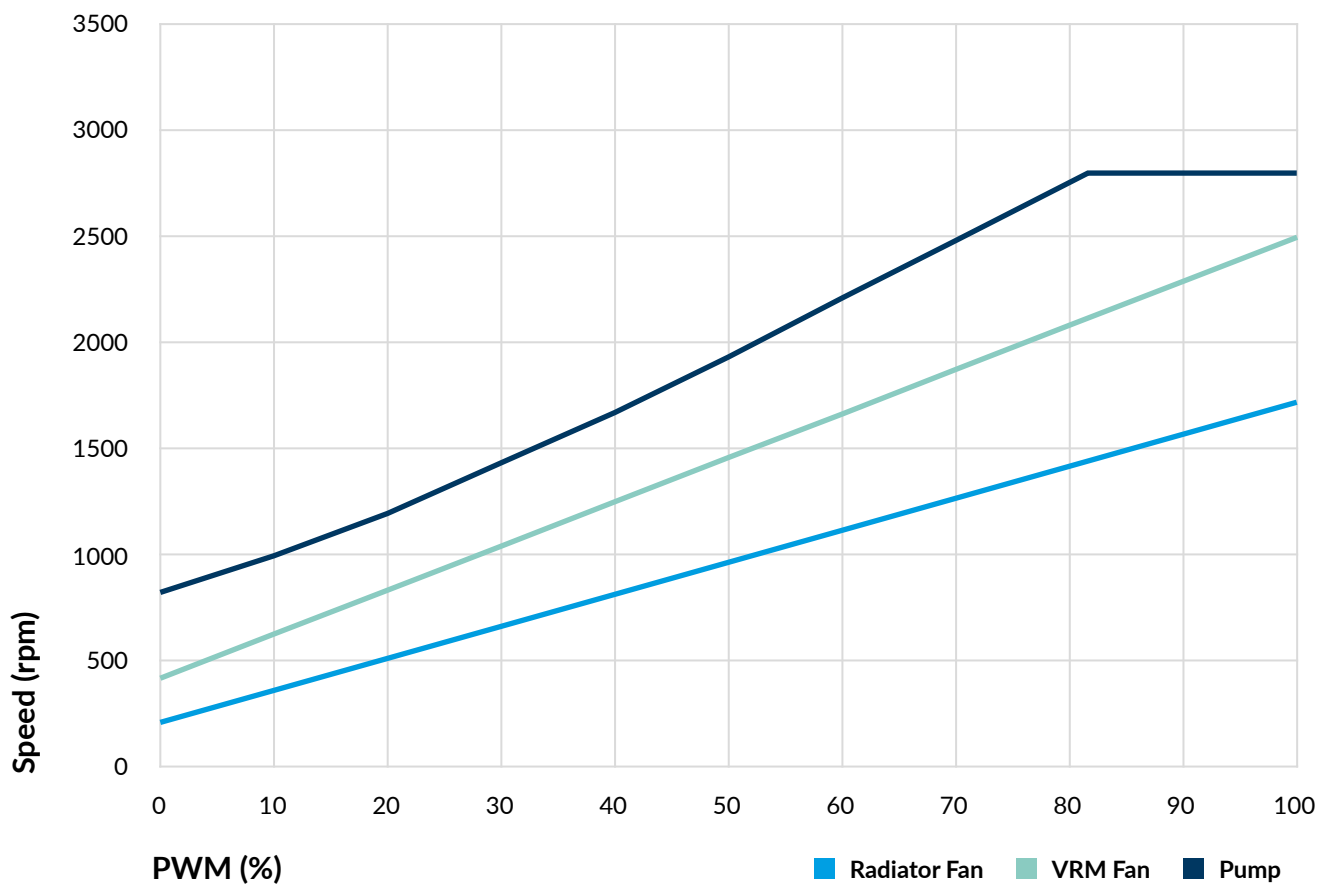

# Liquid Freezer III 420

Multikompatibler All-in-One CPU-Wasserkühler

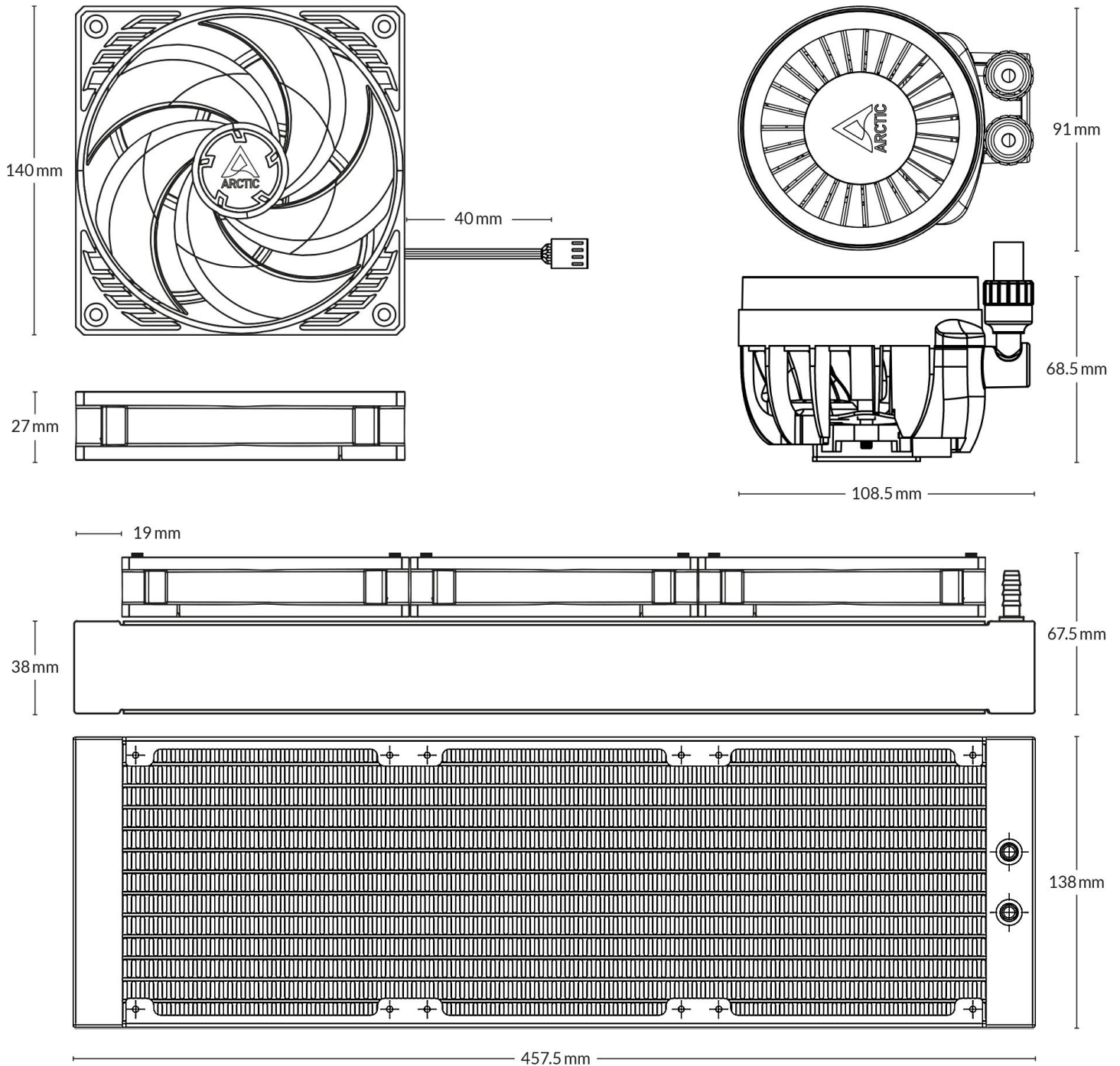

Alle Materialien sind mit den RoHS-Anforderungen kompatibel.

WEITERE INFORMATIONEN



ANLEITUNGEN

