

**WISeNET**

# **VIDEOCAMERA DI RETE**

## Guida Rapida

QND-8010R/8020R/8030R/8080R

QNV-8010R/8020R/8030R/8080R

QNO-8010R/8020R/8030R/8080R

**CE**

## COMPONENTE

In base al Paese di residenza, gli accessori potrebbero variare.

- QND-8010R/8020R/8030R/8080R

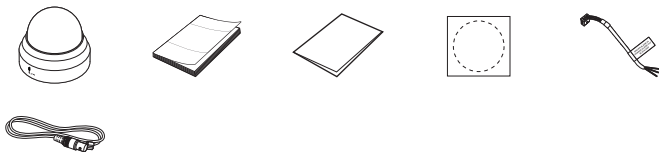

- Non incluso : Scheda SD

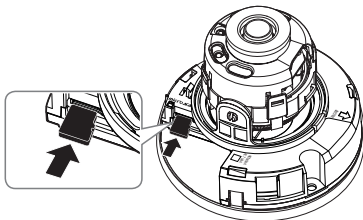

# INSTALLAZIONE

---

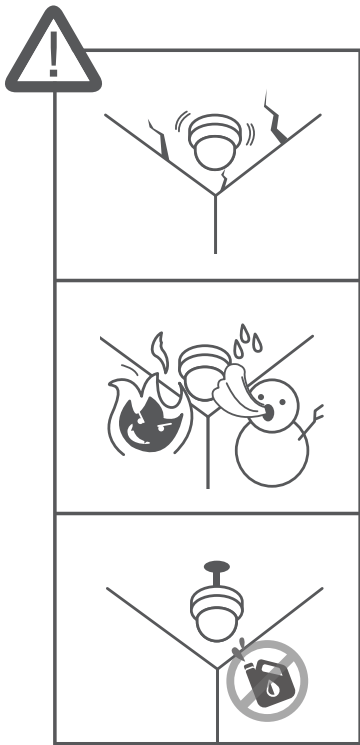

## INSTALLAZIONE

---

1

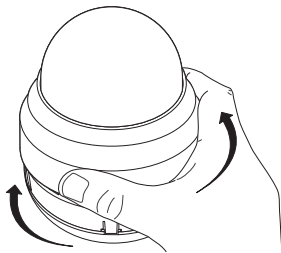

2

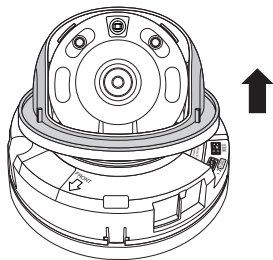

4

# INSTALLAZIONE

---

3

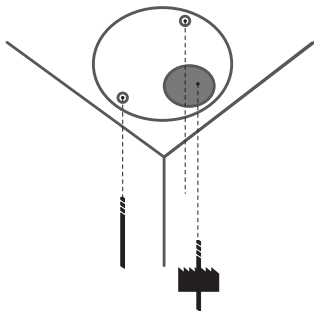

4

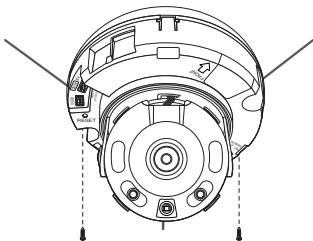

5

## INSTALLAZIONE

---

5

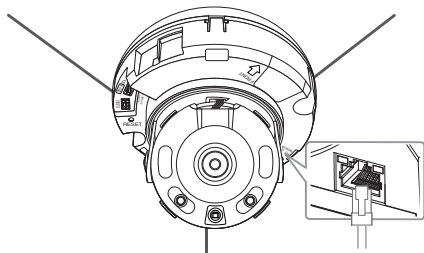

6



## INSTALLAZIONE



7

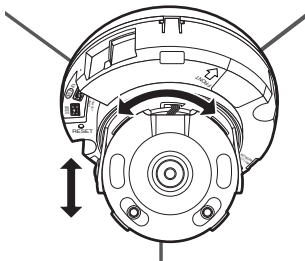

7

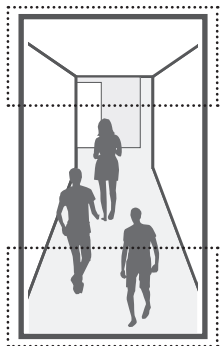
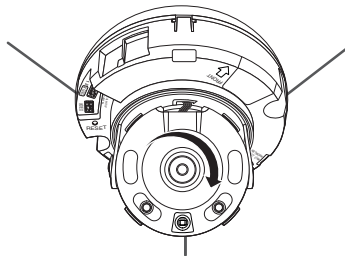



9

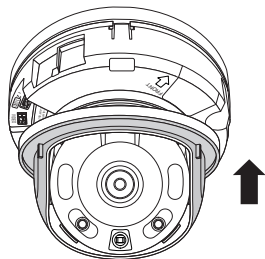

10

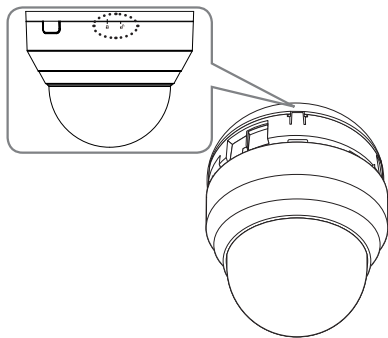

9

## COMPONENTE

In base al Paese di residenza, gli accessori potrebbero variare.

- QNO-8010R/8020R/8030R/8080R

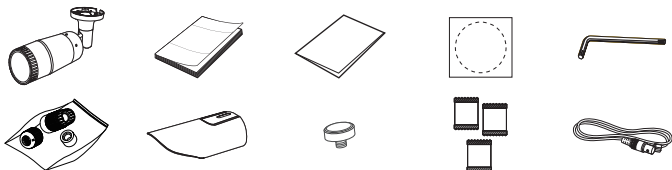

- Non incluso : Scheda SD

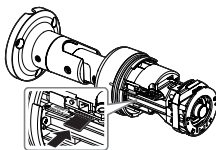

<QNO-8010R/8020R/8030R>

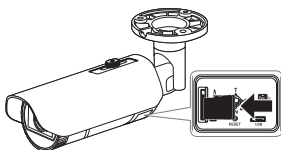

<QNO-8080R>

# INSTALLAZIONE

---

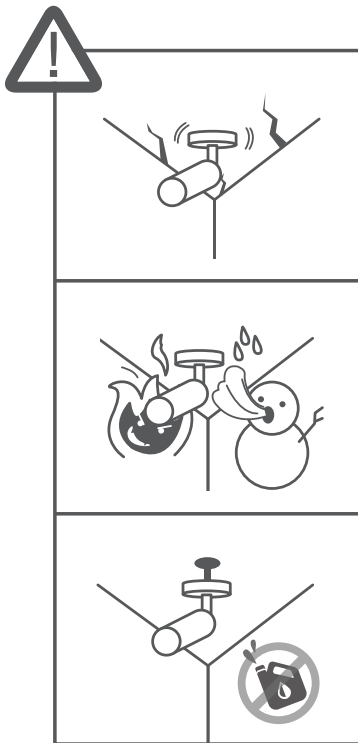

# INSTALLAZIONE

---

1

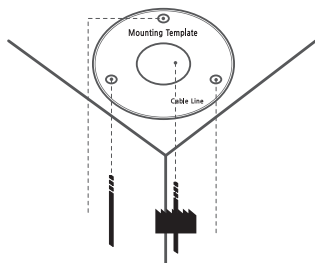

2

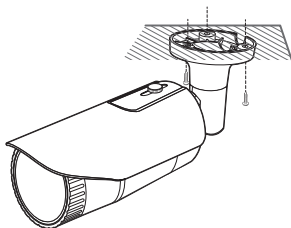

# INSTALLAZIONE

---

3

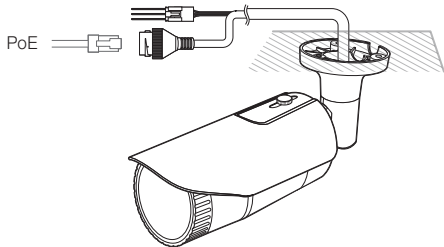

4



## INSTALLAZIONE

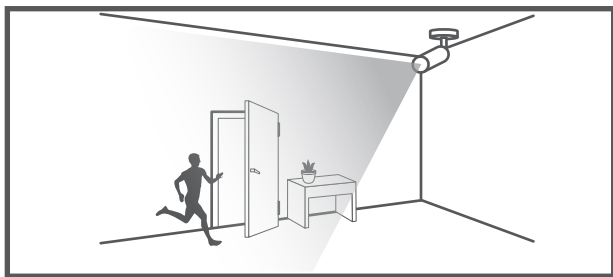

5

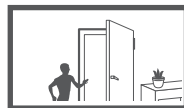
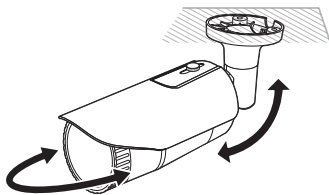

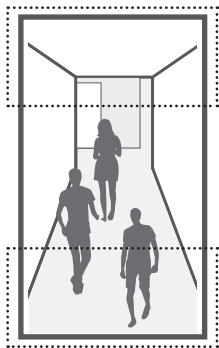
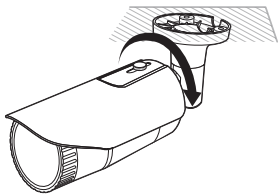

## COMPONENTE

In base al Paese di residenza, gli accessori potrebbero variare.

- QNV-8010R/8020R/8030R/8080R



- Non incluso : Scheda SD

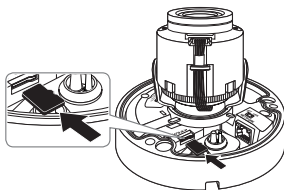



# INSTALLAZIONE

---

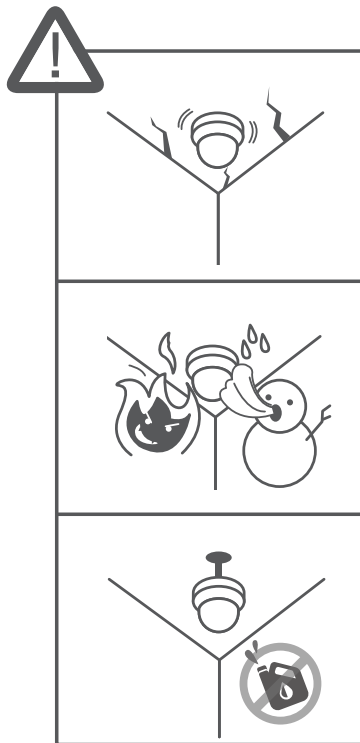

## INSTALLAZIONE

---

1

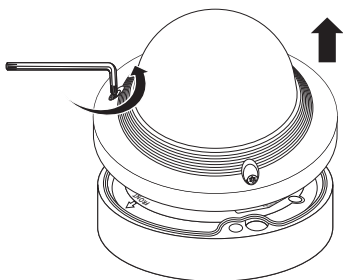

2

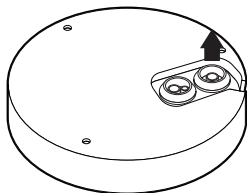

## INSTALLAZIONE

3

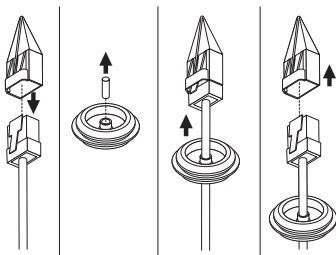

4

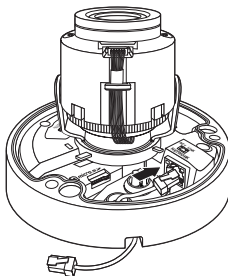

## INSTALLAZIONE

---

5

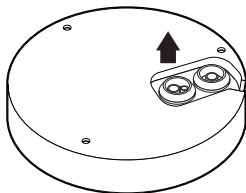

6

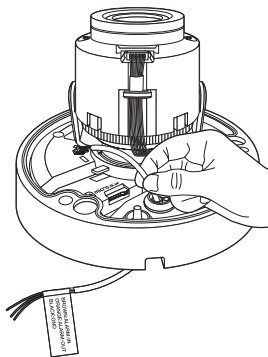

# INSTALLAZIONE

7

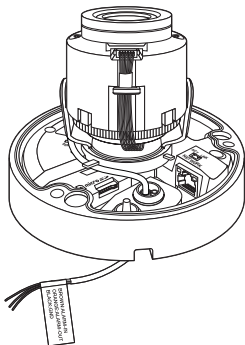

8

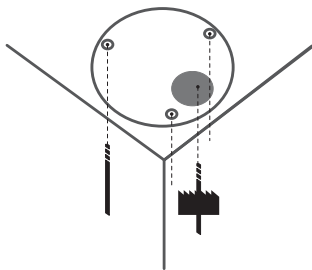

9

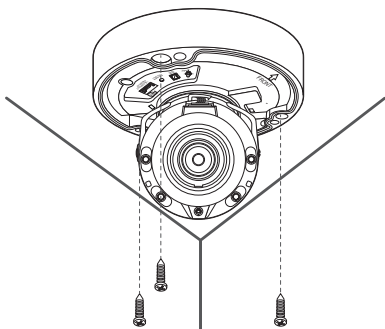

10

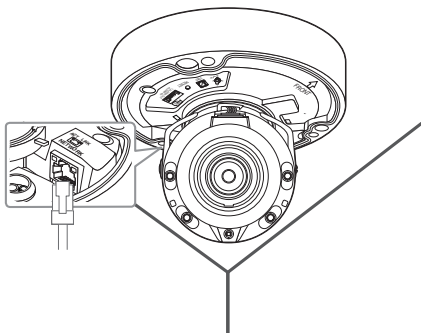

# INSTALLAZIONE

11

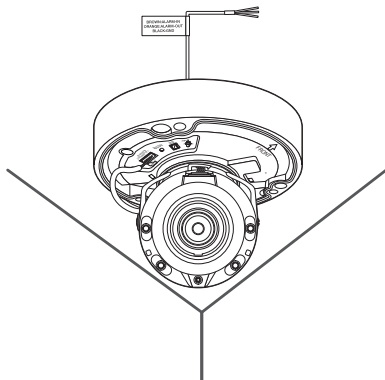

12



## INSTALLAZIONE



13

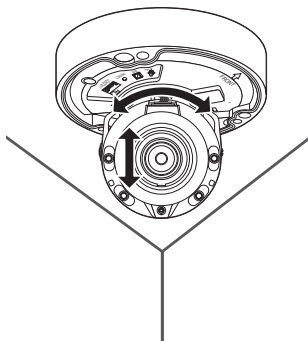



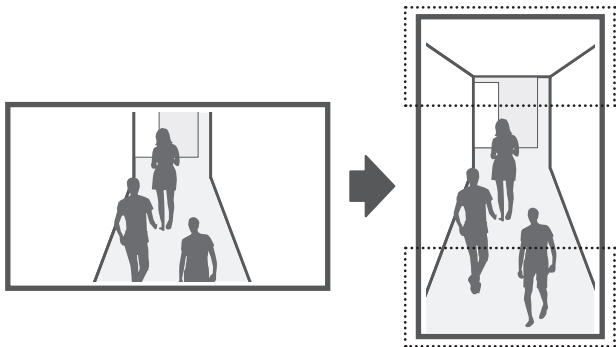
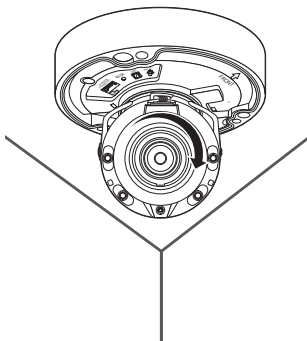

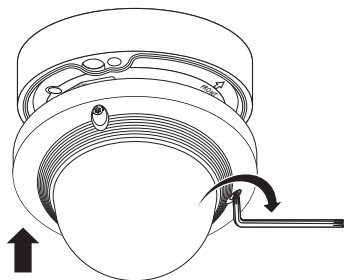

# INSTALLAZIONE

---

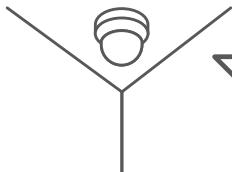
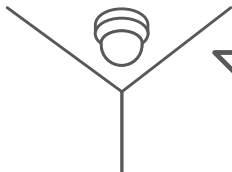

## CONFIGURAZIONE DELLA PASSWORD

Quando si effettua l'accesso al prodotto per la prima volta, è necessario registrare la password di accesso.

Quando appare la finestra per la "**Modifica della password**", immettere la nuova password.

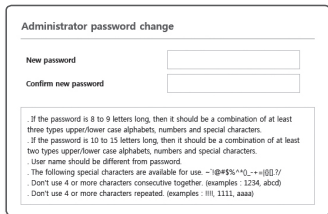

Administrator password change

New password

Confirm new password

.If the password is 8 to 9 letters long, then it should be a combination of at least three types: upper/lower case alphabets, numbers and special characters.  
.If the password is 10 to 15 letters long, then it should be a combination of at least two types upper/lower case alphabets, numbers and special characters.  
.User name should be different from password.  
.The following special characters are available for use: ~!@#%&^\*()\_+=[{}|?/.  
.Don't use 4 or more characters consecutive together. (examples: 1234, abcd)  
.Don't use 4 or more characters repeated. (examples: !!!!!, aaaaa)



- Per una nuova password da 8 a 9 cifre, è necessario usare almeno 3 dei seguenti elementi: lettere maiuscole/minuscole, numeri e caratteri speciali. Per una password da 10 a 15 cifre, è necessario utilizzare almeno 2 degli elementi precedentemente elencati.
  - Caratteri speciali permessi :  
~!@#%&^\*()\_+=[{}|?/
- Per ottenere un maggiore livello di sicurezza, non è raccomandabile usare ripetutamente gli stessi caratteri oppure lettere consecutive nella tastiera.
- Se la password è stata smarrita, è possibile premere il pulsante **[RESET]** per ripristinare il prodotto. Di conseguenza, non è consigliabile usare un promemoria per ricordare la propria password o memorizzarla semplicemente.

## ACCESSO

Ogni volta che si accede alla telecamera, appare la finestra di login.

Inserire l'ID utente e la password per accedere alla telecamera.

- 1 Inserire "**admin**" nella casella <**User Name**>.
- 2 Immettere la password nel campo di inserimento per la <**Password**>.
- 3 Fare clic su **[OK]**.



La tutela dell'ambiente è molto importante per Hanwha Techwin, che ne tiene conto in ogni fase della fabbricazione dei suoi prodotti ed è alla ricerca costante di nuove soluzioni per fornire al cliente prodotti sempre più rispettosi dell'ambiente.

Il marchio Eco rappresenta la dedizione di Hanwha Techwin nel creare prodotti nel rispetto dell'ambiente e indica che il prodotto soddisfa la Direttiva EU RoHS.



#### **Corretto smaltimento del prodotto** (rifiuti elettrici ed elettronici)

(Applicabile nell'Unione Europea e in altri paesi europei con sistema di raccolta differenziata)

Il marchio riportato sul prodotto, sugli accessori o sulla documentazione indica che il prodotto e i relativi accessori elettronici (quali caricabatterie, cuffia e cavo USB) non devono essere smaltiti con altri rifiuti domestici al termine del ciclo di vita. Per evitare eventuali danni all'ambiente o alla salute causati dall'inopportuno smaltimento dei rifiuti, si invita l'utente a separare il prodotto e i suddetti accessori da altri tipi di rifiuti e di riciclarli in maniera responsabile per favorire il riutilizzo sostenibile delle risorse materiali.

Gli utenti domestici sono invitati a contattare il rivenditore presso il quale è stato acquistato il prodotto o l'ufficio locale preposto per tutte le informazioni relative alla raccolta differenziata e al riciclaggio per questo tipo di materiali.

Gli utenti aziendali sono invitati a contattare il proprio fornitore e verificare i termini e le condizioni del contratto di acquisto. Questo prodotto e i relativi accessori elettronici non devono essere smaltiti unitamente ad altri rifiuti commerciali.



#### **Corretto smaltimento delle batterie del prodotto**

(Applicabile nei paesi dell'Unione Europea e in altri paesi europei con sistemi di conferimento differenziato delle batterie.)

Il marchio riportato sulla batteria o sulla sua documentazione o confezione indica che le batterie di questo prodotto non devono essere smaltite con altri rifiuti domestici al termine del ciclo di vita. Dove raffigurati, i simboli chimici Hg, Cd o Pb indicano che la batteria contiene mercurio, cadmio o piombo in quantità superiori ai livelli di riferimento della direttiva UE 2006/66. Se le batterie non vengono smaltite correttamente, queste sostanze possono causare danni alla salute umana o all'ambiente.

Per proteggere le risorse naturali e favorire il riutilizzo dei materiali, separare le batterie dagli altri tipi di rifiuti e riciclarle utilizzando il sistema di conferimento gratuito previsto nella propria area di residenza.

---

**Head Office**

6, Pangyo-ro 319 beon-gil, Bundang-gu, Seongnam-si,  
Gyeonggi-do, 463-400 Rep. of KOREA  
Tel : +82.70.7147.8753 Fax : +82.31.8018.3740  
<http://hanwha-security.com>

---

**Hanwha Techwin America**

500 Frank W. Burr Blvd. Suite 43 Teaneck, NJ 07666  
Toll Free : +1.877.213.1222 Direct : +1.201.325.6920  
Fax : +1.201.373.0124  
[www.hanwhasecurity.com](http://www.hanwhasecurity.com)

---

**Hanwha Techwin Europe**

Heriot House, Heriot Road, Chertsey, Surrey, KT16 9DT, United Kingdom  
Tel : +44.1932.57.8100 Fax : +44.1932.57.8101  
[www.hanwha-security.eu](http://www.hanwha-security.eu)

---

**Hanwha Techwin(Tianjin) Co.Ltd**

No.11, Weiliu Rd., Micro-Electronic Industrial Park, Jingang Road Tianjin 300385, China  
Tel : +86.22.2388.7788  
[www.hanwha-security.cn](http://www.hanwha-security.cn)

---

**Hanwha Techwin Middle East FZE**

JAFZA View 18, 20th floor, office 2001, 2002, 2003, Downtown Jebel Ali,  
Dubai, United Arab Emirates  
<http://hanwha-security.com>

---