

WISeNET

NETZWERKKAMERA

Kurzanleitung

QND-7012R/7022R/7032R/7082R

QNV-6014R/7012R/7022R/7032R/6084R/7082R

QNO-6014R/7012R/7022R/7032R/6084R/7082R



COMPONENT

Da in jedem Vertriebsland die Zubehörteile nicht die gleichen sind.

- QND-7012R/7022R/7032R/7082R



- Nicht eingeschlossen: Micro SD-Karte

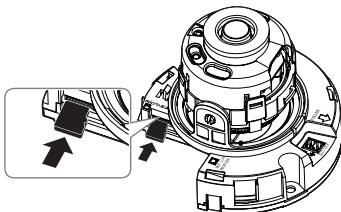

INSTALLATION

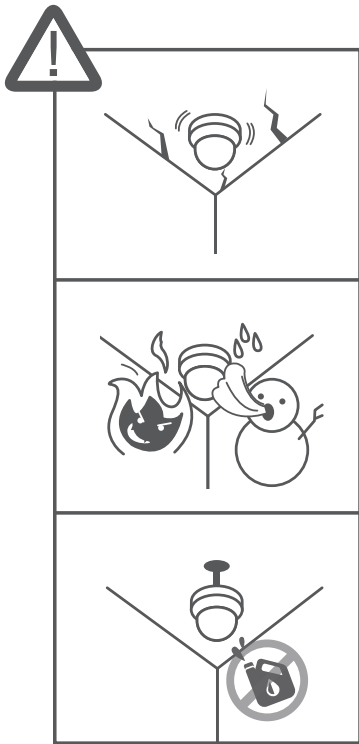

INSTALLATION

1

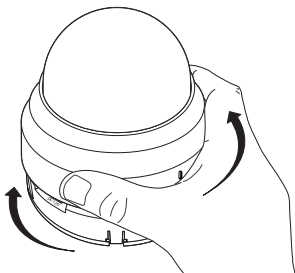

2

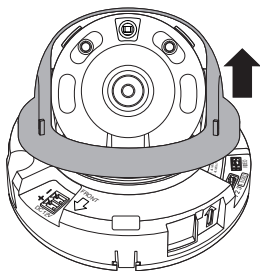

INSTALLATION

3

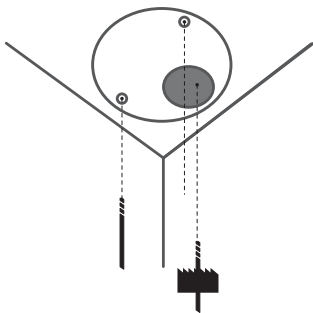

4

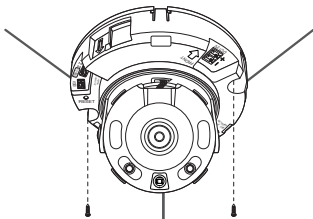

5

INSTALLATION

5

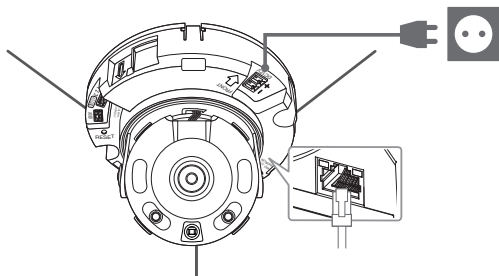

6



INSTALLATION

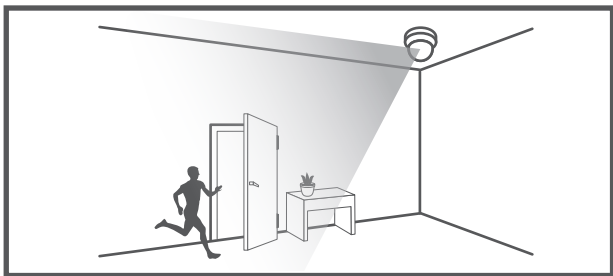

7

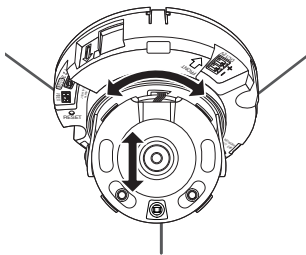
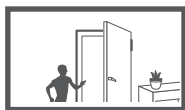

7

INSTALLATION

8

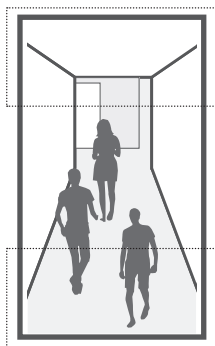
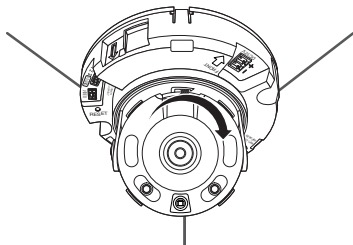

INSTALLATION

9

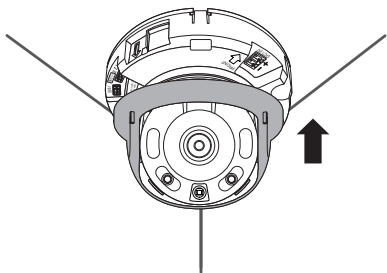

10

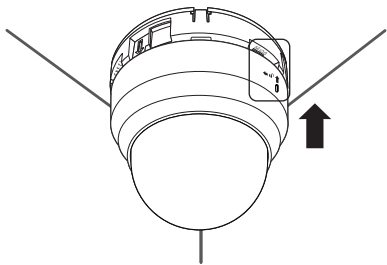

9

COMPONENT

Da in jedem Vertriebsland die Zubehörteile nicht die gleichen sind.

- QNO-6014R/7012R/7022R/7032R/6084R/7082R



- Nicht eingeschlossen: Micro SD-Karte

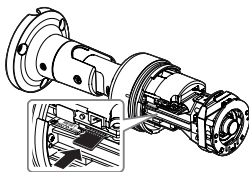

INSTALLATION

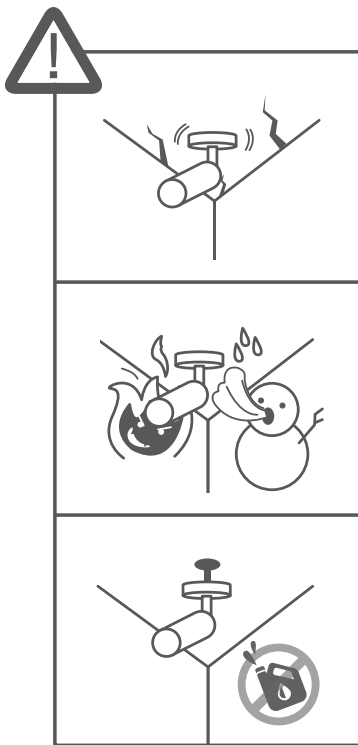

INSTALLATION

1

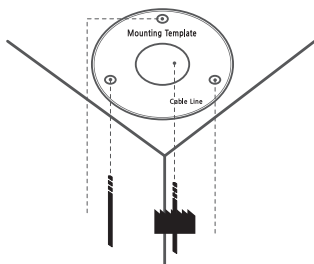

2

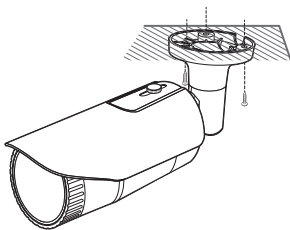

INSTALLATION

3

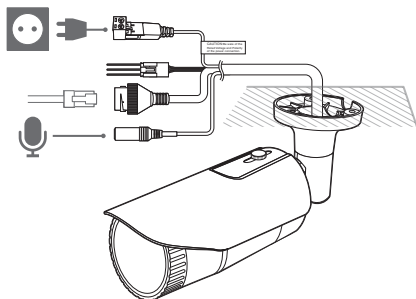

4



INSTALLATION

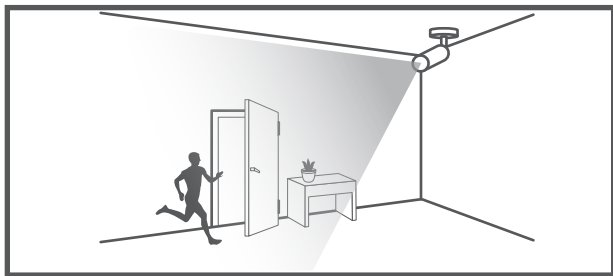

5

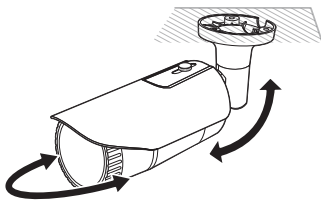

INSTALLATION

6

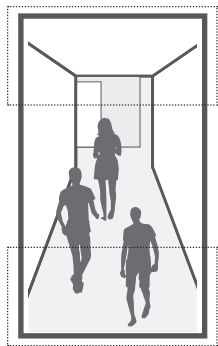
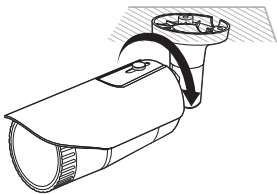

COMPONENT

Da in jedem Vertriebsland die Zubehörteile nicht die gleichen sind.

- QNV-6014R/7012R/7022R/7032R/6084R/7082R

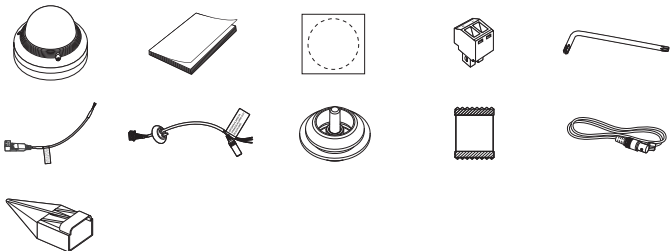

- Nicht eingeschlossen: Micro SD-Karte

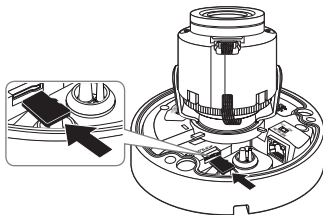

INSTALLATION

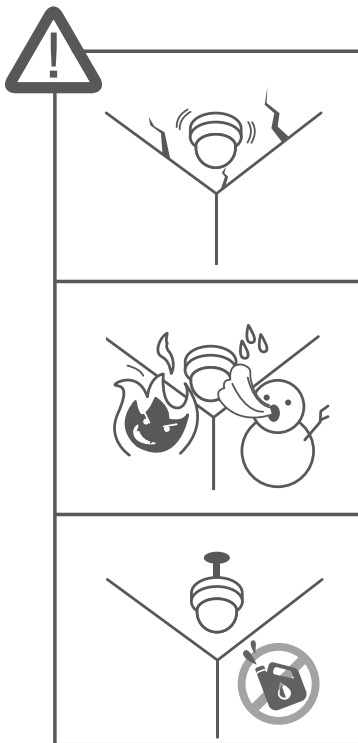

INSTALLATION

1

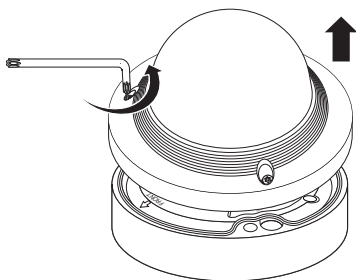

2

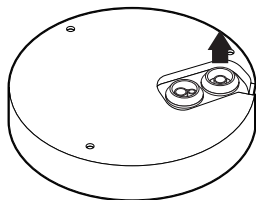

INSTALLATION

3

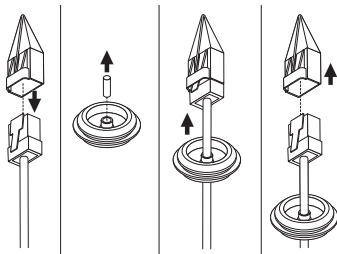

4

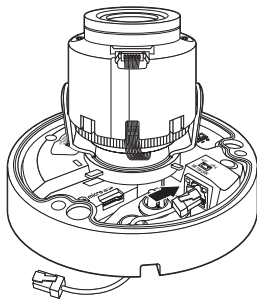

INSTALLATION

5

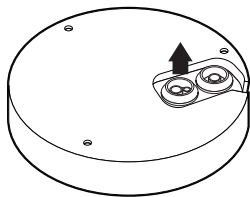

6

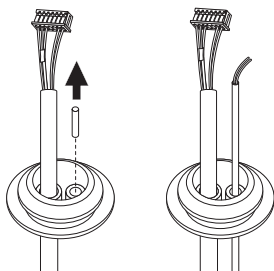

INSTALLATION

7

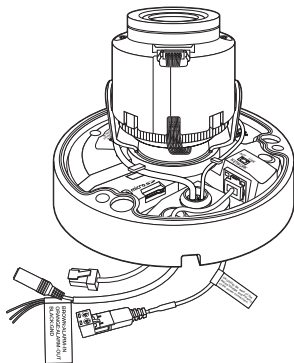

8

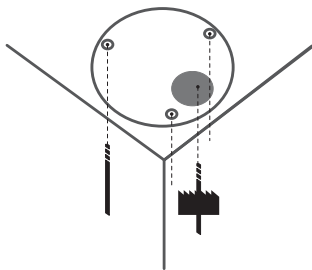

INSTALLATION

9

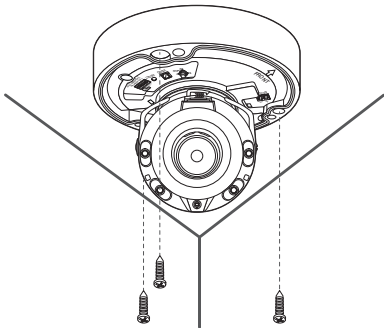

10

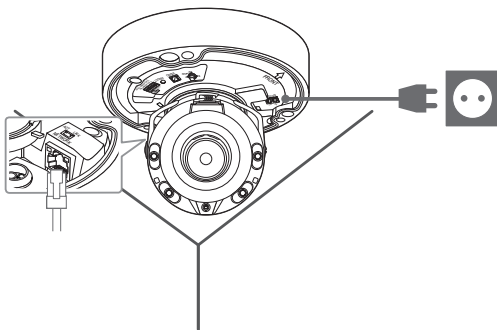

INSTALLATION

11

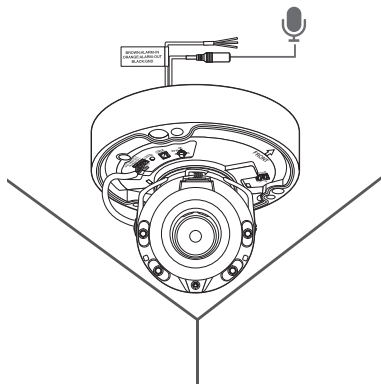

12



INSTALLATION



13

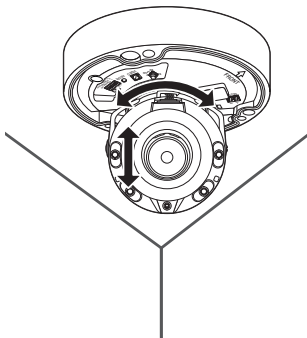

INSTALLATION

14

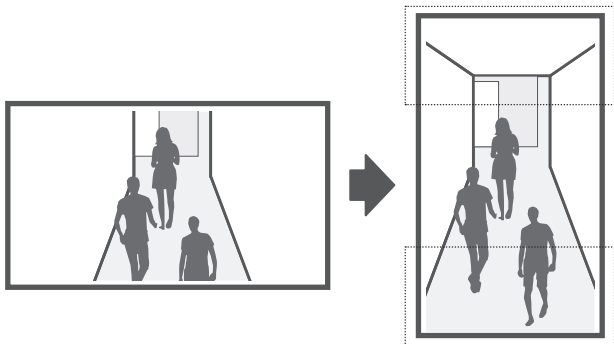
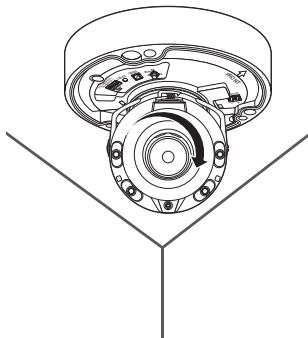

15

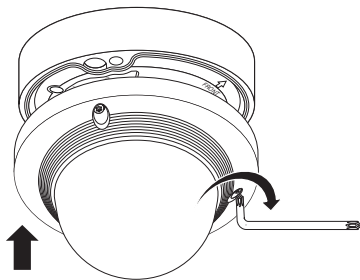

PASSWORTEINSTELLUNG

Beim ersten Zugriff auf das Produkt, müssen Sie das Anmelde-Passwort registrieren.

Administrator password change

New password

Confirm new password

- If the password is 8 to 9 characters long, then it must include a combination of at least 3 of the following character types: alphabet letters with uppercase or lowercase, numbers, and special characters
- If the password is longer than 10 characters, then it must include a combination of at least 2 of the following character types: alphabet letters with uppercase or lowercase, numbers, and special characters.
- User name may not be used as password
- The following special characters can be used: ~!@#%&^*()_-+=|{}[]?/
- You may not use more than 4 consecutive characters. (example: 1234, abcd, etc.)
- You may not use the same character 4 or more times consecutively. (example: 1111, aaaa, etc.)



- Für ein neues Passwort mit 8 bis 9 Ziffern müssen Sie mindestens drei der Folgenden verwenden: Groß-/Kleinbuchstaben, Zahlen und Sonderzeichen. Für ein Passwort mit 10 bis 15 Ziffern müssen Sie mindestens zwei dieser Zeichentypen verwenden.
 - Zulässige Sonderzeichen sind. :
~!@#%&^*()_-+=|{}[]?/
- Zur erhöhten Sicherheit wird empfohlen, nicht die gleichen Zeichen oder aufeinanderfolgende Eingaben der Tastatur zu wiederholen.
- Falls Sie Ihr Passwort vergessen haben, können Sie die Schaltfläche **[RESET]** drücken und das Produkt initialisieren. Verwenden Sie ein Memo-Pad oder merken Sie sich Ihr Passwort

ANMELDEN

Immer, wenn Sie auf die Kamera zugreifen, wird das Anmeldefenster angezeigt.

Geben Sie den Benutzernamen und das Passwort ein, um auf die Kamera zuzugreifen.

- 1 Geben Sie „admin“ in das <User Name> Eingabefeld ein.
- 2 Geben Sie das Passwort in dem Eingabefeld <Password> ein.
- 3 Klicken Sie auf **[Sign in]**.



Harwha Techwin cares for the environment at all product manufacturing stages, and is taking measures to provide customers with more environmentally friendly products.

The Eco mark represents Harwha Techwin's devotion to creating environmentally friendly products, and indicates that the product satisfies the EU RoHS Directive.



Correct Disposal of This Product (Waste Electrical & Electronic Equipment)

(Applicable in the European Union and other European countries with separate collection systems)

This marking on the product, accessories or literature indicates that the product and its electronic accessories (e.g. charger, headset, USB cable) should not be disposed of with other household waste at the end of their working life. To prevent possible harm to the environment or human health from uncontrolled waste disposal, please separate these items from other types of waste and recycle them responsibly to promote the sustainable reuse of material resources.

Household users should contact either the retailer where they purchased this product, or their local government office, for details of where and how they can take these items for environmentally safe recycling.

Business users should contact their supplier and check the terms and conditions of the purchase contract. This product and its electronic accessories should not be mixed with other commercial wastes for disposal.



Correct disposal of batteries in this product

(Applicable in the European Union and other European countries with separate battery return systems.)

This marking on the battery, manual or packaging indicates that the batteries in this product should not be disposed of with other household waste at the end of their working life. Where marked, the chemical symbols Hg, Cd or Pb indicate that the battery contains mercury, cadmium or lead above the reference levels in EC Directive 2006/66. If batteries are not properly disposed of, these substances can cause harm to human health or the environment.

To protect natural resources and to promote material reuse, please separate batteries from other types of waste and recycle them through your local, free battery return system.



Подлежит использованию по назначению
в нормальных условиях
Срок службы : 7 лет.

Türkiye Distribütörü

EDS Elektronik Destek Sanayi ve Ticaret Ltd. Şti.

Meclis Mah. Teraziler Cad. Hayran Sk. (Eskisi Kılıç Sk.) No: 4 Sancaktepe / İstanbul / Türkiye

Tel +90.216.313.25.15 Faks +90.216.528.45.98

Koyuncu Elektronik Bilgi İşlem Sistemleri San. ve Dış. Tic. A.Ş.

Emek Mah. Ordu Cad. No:18 Sancaktepe / İstanbul / Türkiye

Tel +90.216.528.88.88 Faks +90.216.313.18.18

NFS Teknoloji ve Otomasyon Sistemleri San. Ve Tic. Ltd. Şti.

Cumhuriyet Mah Şair M.Akif Ersoy Sk. No:36 Üsküdar / İstanbul / Türkiye

Tel +90.216.505.82.28 Faks +90.216.505.82.29

Sensonet Teknoloji Elekt. ve Biliş. Hiz. San. ve Tic. Ltd. Şti.

Ramazanoğlu Mah. Transtek Cad. No: 2 Pendik / İstanbul / Türkiye

Tel +90.216.999.49.49 Faks +90.212.381.61.02

ENTES ELEKTRONİK CİHAZLAR İMALAT VE TİC. A.Ş.

Dudullu Org.San.Bölg. 1. Cad. No:23 34776 Ümraniye - İstanbul / Türkiye

Tel +90.216.313.01.10 Faks +90.216.314.16.15

Cihazın Ticaret Bakanlığınca önerilen ortalama ömrü

Cihazın EEE yönetmeliklerine uygun olduğuna benzer beyan

한화테크윈(주)

경기도 성남시 분당구 판교로 319번길 6 (삼평동 701)

영업 TEL 070-7147-8771~9 A/S 및 기술문의 1588-5772

부산영업소 TEL 051-796-3216

대구영업소 TEL 053-742-3098

광주영업소 TEL 062-941-9559

대전영업소 TEL 042-489-9840

www.hanwha-security.com

Head Office

6, Pangyo-ro 319 beon-gil, Bundang-gu, Seongnam-si,

Gyeonggi-do, 463-400 Rep. of KOREA

Tel : +82.70.7147.8753 Fax : +82.31.8018.3740

www.hanwha-security.com

Hanwha Techwin America

500 Frank W. Burr Blvd. Suite 43 Teaneck, NJ 07666

Toll Free : +1.877.213.1222 Direct : +1.201.325.6920

Fax : +1.201.373.0124

www.hanwhasecurity.com

Hanwha Techwin Europe

Heriot House, Heriot Road, Chertsey, Surrey, KT16 9DT, United Kingdom

Tel : +44.1372.235663 Fax : +44.1932.57.8101

www.hanwha-security.eu

Hanwha Techwin(Tianjin) Co.Ltd

Room 3F2C302, microelectronics investment service center, no.1 qianxuesen road,

microelectronics industrial park, Tianjin economic and technological development area, China

联系电话(免费客服热线) : 800.818.1212 / 400.690.6677

www.hanwha-security.cn

Hanwha Techwin Middle East FZE

JAFZA View 18, 20th floor, office 2001, 2002, 2003, Downtown Jebel Ali,

Dubai, United Arab Emirates

www.hanwha-security.com

Hanwha Techwin Vietnam Hanoi Office

28th Floor, Handico Building, Pham Hung Street, Me Tri ward, Nam Tu Liem District, Hanoi City, Vietnam

Tel : +84.91.982.40.88

www.hanwha-security.com

