





CONTENTS

Safety Precautions and Instructions	5
System Description	5
Unpacking and Inspection	6
Rigging, Lifting and Moving Large Units	6
Meter Location, Orientation and Applications	8
Temperature Ranges	8
Remote Amplifier Outdoor Location	8
Pipelines and Fluid Flow	8
Meter Orientation	9
Vertical Placement	9
Horizontal Placement	9
Straight Pipe Requirements	9
Pipe Reducer Requirements	10
Chemical Injection Applications	10
Partially-Filled Pipe Situations	11
Meter Gaskets and Grounding	12
Meter/Pipeline Connection Gaskets	12
Meter Grounding	12
Recommended Installation with Grounding Rings	12
Amplifier Mounting Configuration Options	13
Meter Mount Configuration	13
Remote Mount Configuration	13
Submersible Option	13
Wiring	13
Wiring Safety	13
Opening the M2000 Meter Cover	13
Power Connections	14
External Disconnect	14
AC Power Wiring	14
Remote Mount Installation	14

Mount Bracket to Amplifier	14
Wiring Configuration	14
Wiring for Remote Configuration	15
Empty Pipe Detection Considerations	15
Configuring Input/Output (I/O)	16
Analog Output Wiring Diagram	17
Digital Output Wiring Diagrams	18
Digital Input Wiring Diagram	18
Programming the M2000 Meter	19
Displays	19
Menu Selection Display	19
Numeric Entry Display	19
Function Buttons	20
Security	22
Setting the Administration PIN	22
Setting the Service PIN	22
Setting the User PIN	22
Entering Your Personal Identification Number (PIN)	23
Setting Up the M2000 Meter with Quick Setup	24
Quick Reference	26
Using the M2000 Meter Main Menu Programming Options	27
Encoder Protocol Interface	47
Store / Restore Feature	49
Data Logging Feature	49
Maintenance	50
Cleaning the Flow Tube and Electrode	50
Replacing the Fuse	50
Replacing the Circuit Board	50
Troubleshooting	51
Specifications	54

SAFETY PRECAUTIONS AND INSTRUCTIONS

Some procedures in this manual require special safety considerations. In such cases, the text is emphasized with the following symbols:

Symbol	Explanation
 WARNING	Warning indicates the potential for severe personal injury, death or substantial property damage. Comply with the instructions and proceed with care.
 CAUTION	Caution indicates the potential for minor personal injury or property damage. Comply with the instructions and proceed with care.

SYSTEM DESCRIPTION

The Badger Meter M-Series® model M2000 electromagnetic flow meter is intended for fluid metering in most industries including water, wastewater, food and beverage, pharmaceutical and chemical.

The basic components of an electromagnetic flow meter are:

- The **detector**, which includes the flow tube, isolating liner and measuring electrodes.
- The **amplifier**, which is the electronic device responsible for the signal processing, flow calculation, display and output signals.

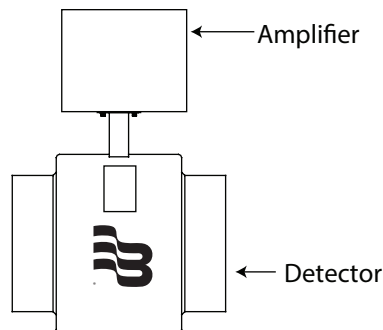

Figure 1: Amplifier and detector

The construction materials of the wetted parts (liner and electrodes) should be appropriate for the specifications on the intended type of service. We recommend that you review all of the compatibilities consistent with the specifications.

Each meter is factory tested and calibrated. A calibration certificate is included with each meter.

UNPACKING AND INSPECTION

Follow these guidelines when unpacking the M-Series equipment.

- If a shipping container shows any sign of damage, have the shipper present when you unpack the meter.
- Follow all unpacking, lifting and moving instructions associated with the shipping container.
- Open the container and remove all packing materials. Store the shipping container and packing materials in the event the unit needs to be shipped for service.
- Verify that the shipment matches the packing list and your order form.
- Inspect the meter for any signs of shipping damage, scratches, or loose or broken parts.

NOTE: If the unit was damaged in transit, it is your responsibility to request an inspection report from the carrier within 48 hours. You must then file a claim with the carrier and contact Badger Meter for appropriate repairs or replacement.

- All detectors with polytetrafluoroethylene (PTFE) liners are shipped with a liner protector on each end to maintain proper form of the PTFE material during shipping and storage.

NOTE: Do not remove the liner protectors until you are ready to install.

- Storage: If the meter is to be stored, place it in its original container in a dry, sheltered location. Storage temperature ranges are: -40...160° F (-40...70° C).

Rigging, Lifting and Moving Large Units

CAUTION

WHEN RIGGING, LIFTING OR MOVING LARGE UNITS, FOLLOW THESE GUIDELINES:

- DO NOT lift or move a meter by its amplifier, junction box or cables.
- Use a crane rigged with soft straps to lift and move meters with flow tubes that are between two inches and eight inches (50 mm and 200 mm). Place the straps around the detector body, between the flanges, on each side of the detector.
- Use the lifting lugs when lifting meter flow tubes that are 10 inches (250 mm) in diameter or larger.

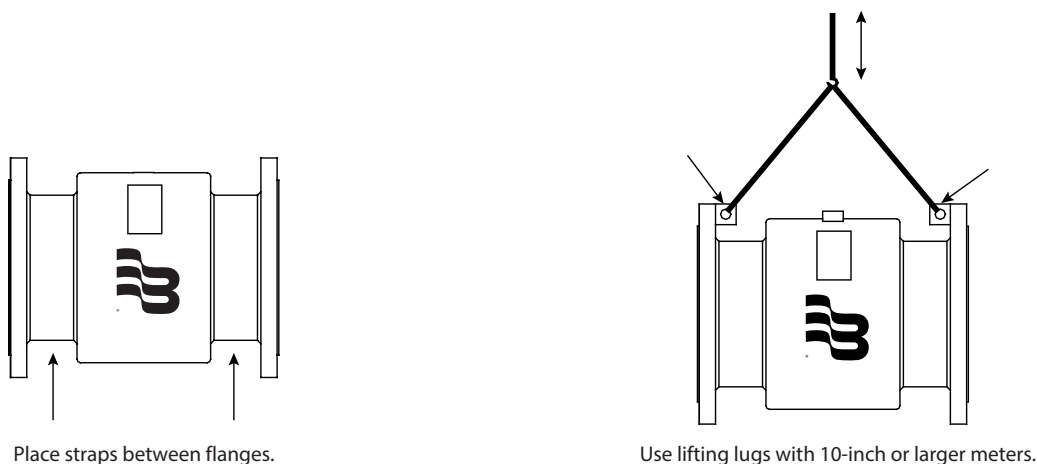

Figure 2: Rigging large units

- Use the sling-rigged method to lift large detectors into a vertical position while they are still crated. Use this method to position large detectors vertically into pipelines.

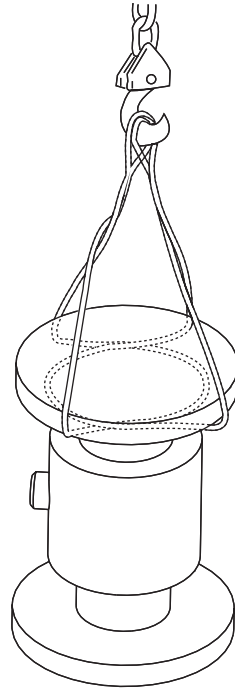
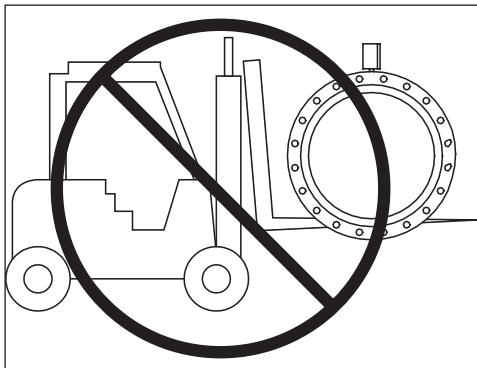
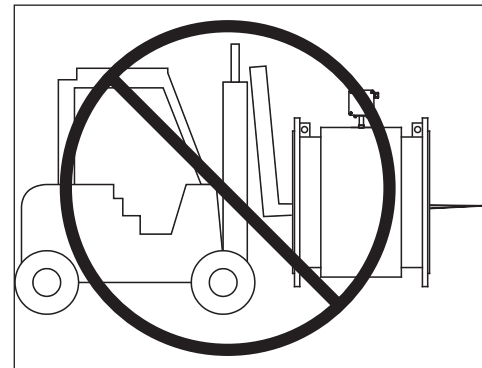

Figure 3: Sling-Rigged lifting methods

- Do not lift a detector with a forklift by positioning the detector body on the forks, with the flanges extending beyond the lift. This could dent the housing or damage the internal coil assemblies.
- Never place forklift forks, rigging chains, straps, slings, hooks or other lifting devices inside or through the detector's flow tube to hoist the unit. This could damage the isolating liner.



Do not lift detector with forklift.



Do not lift or rig lifting devices through detector.

Figure 4: Lifting and rigging cautions

METER LOCATION, ORIENTATION AND APPLICATIONS

Gasket and grounding requirements must be considered when determining the meter location, orientation and application. See "Meter Gaskets and Grounding" on page 12. The M2000 meter provides two amplifier mounting options: a meter mount option and a remote mount option.

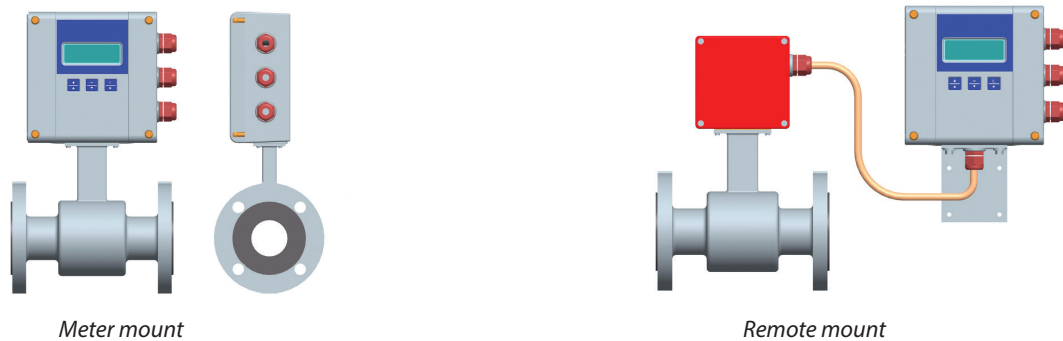

Figure 5: Amplifier mounting options

Temperature Ranges

CAUTION

TO PREVENT DAMAGE TO THE METER, STRICTLY OBSERVE THE AMPLIFIER'S AND DETECTOR'S MAXIMUM TEMPERATURE RANGES.

- In regions with extremely high ambient temperatures, protect the detector.
- In cases where fluid temperature exceeds 212° F (100° C), use the remote version.

Amplifier	Ambient temperature		- 4...140° F (-20...60° C)
Detector	Fluid temperature	PTFE / PFA	- 40...302° F (- 40...150° C)
		Hard rubber	32...176° F (0...80° C)

Remote Amplifier Outdoor Location

The amplifier can be installed and operated outdoors. However, it must be protected from the elements, as follows:

- The ambient environment/temperature rating for the unit is -4...140° F (-20...60° C).
- If an indoor location is within 500 feet (152 meters) of the detector, consider increasing the cable length and mounting the amplifier indoors.
- At minimum, fabricate a roof or shield over and/or around the amplifier to protect the LCD screen from direct sunlight.

Pipelines and Fluid Flow

Take the following precautions during installation:

- Do not install the meter on pipes with extreme vibrations. If pipes are vibrating, secure the piping with appropriate pipe supports in front of and behind the meter. If vibrations cannot be restrained, mount the amplifier in a remote location.
- Do not install the detector close to pipeline valves, fittings or impediments that can cause flow disturbances.
- For detectors with PTFE liners, do not install the detector on suction sides of pumps.
- Do not install the detector on outlet sides of piston or diaphragm pumps. Pulsating flow can affect meter performance.
- Avoid installing the detector near equipment that produces electrical interference such as electric motors, transformers, variable frequency, and power cables.
- Verify that both ends of the signal cables are securely fastened.
- Place power cables and signal cables in separate conduits.
- Place the meter where there is enough access for installation and maintenance tasks.

Meter Orientation

Mag meters can operate accurately in any pipeline orientation and can measure volumetric flow in forward and reverse directions as long as the pipe is completely full.

NOTE: A "Forward Flow" direction arrow is printed on the detector label.

Vertical Placement

Mag meters perform best when placed vertically, with liquid flowing upward and meter electrodes in a closed, full pipe.

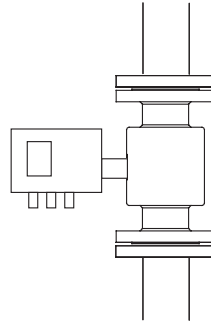

Figure 6: Vertical placement

Vertical placement allows the pipe to remain completely full, even in low flow, low pressure applications, and it prevents solids build-up, sediment deposit and accumulation on the liner and electrodes.

NOTE: Carefully observe the "Forward Flow" label on the meter body and install the meter accordingly. When installed vertically, rotate amplifier so that cable glands are facing down.

Horizontal Placement

M2000 meters are equipped with an *Empty Pipe Detection* feature. If an electrode mounted in the pipe is not covered by fluid for five seconds, the meter will display an Empty Pipe Detection condition. The meter will send out an error message and stop measuring flow. When the electrode is again covered with fluid, the error message disappears and the meter will begin measuring.

When installing the meter on a horizontal pipe, mount the detector to the pipe with the flow-measuring electrode axis in a horizontal plane (three and nine o'clock). This placement helps prevent solids build-up, sediment deposit and accumulation on the electrodes.

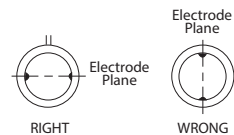

Figure 7: Horizontal placement

Straight Pipe Requirements

Sufficient straight-pipe runs are required at the detector inlet and outlet for optimum meter accuracy and performance. An equivalent of 3...7 diameters of straight pipe is required on the inlet (upstream) side to provide a stable flow profile. Two diameters are required on the outlet (downstream) side.

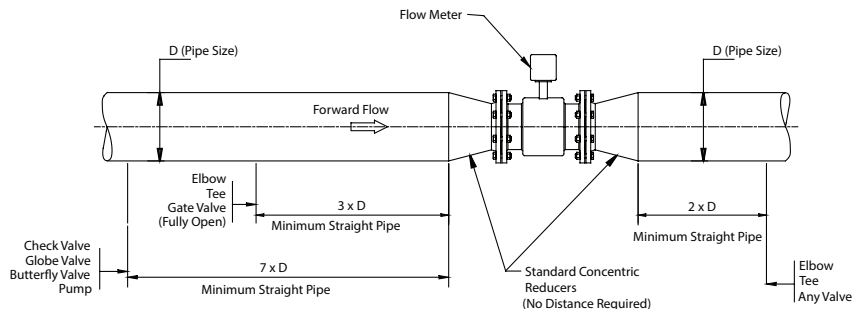

Figure 8: Minimum straight pipe requirements

Pipe Reducer Requirements

With pipe reducers, a smaller meter can be mounted in larger pipelines. This arrangement may increase low-flow accuracy. There are no special requirements for standard, concentric, pipe reducers.

Custom fabricated pipe reducers must have an approximate slope angle of 15 degrees to minimize flow disturbances and excessive loss of head. If this is not possible, install the custom pipe reducers as if they were fittings and install the required amount of straight pipe.

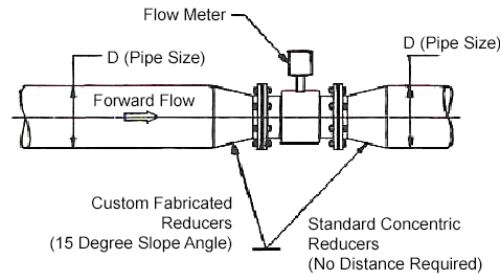

Figure 9: Pipe reducer requirements

Chemical Injection Applications

For water line applications with a chemical injection point, install the meter upstream of the injection point. This eliminates any meter performance issues.

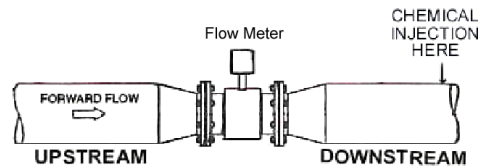

Figure 10: Chemical injection point downstream of meter

If a meter must be installed downstream of a chemical injection connection, the distance between the flange and the injection point should be between 50 and 100 feet (15 and 30 meters). The distance must be long enough to allow the water/chemical solution to reach the meter in a complete, homogeneous mixture. If the injection point is too close, the meter senses the two conductivities for each liquid. This will likely result in inaccurate measurements. The injection method—spaced bursts, continuous stream of drips or liquid or gas—can also affect downstream readings by the meter.

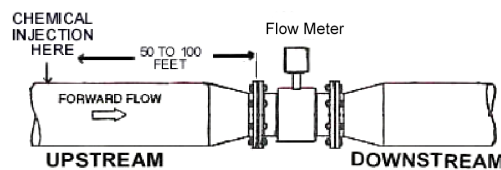

Figure 11: Chemical injection point upstream of meter

Sometimes, due to circumstances, it is difficult to specify the exact downstream placement distances. Contact Badger Meter Technical Support to review your application if necessary.

Partially-Filled Pipe Situations

In some locations, the process pipe may be momentarily only partially filled. Examples include: lack of back pressure, insufficient line pressure and gravity flow applications.

To eliminate these situations:

- Do not install the meter at the highest point of the pipeline.
- Do not install the meter in a vertical, downward flow section of pipe.
- Always position the ON/OFF valves on the downstream side of the meter.

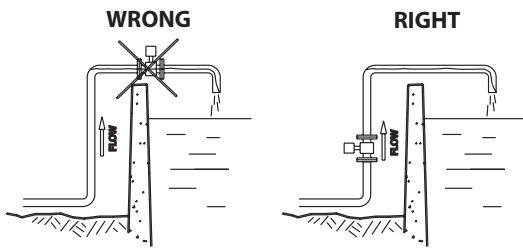
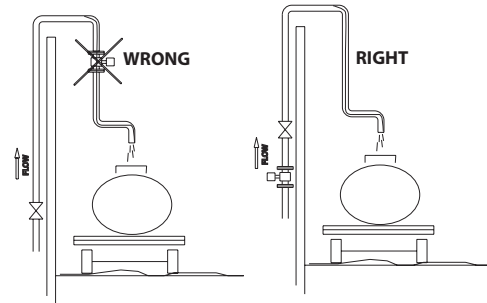

Figure 12: Incorrect meter placement



Do not install in a vertical, downward position.

Position "On/Off" valves on downstream side.

Figure 13: Position valves on downstream side

To minimize the possibility of partially-full pipe flows in horizontal, gravity or low pressure applications, create a pipe arrangement that ensures the detector remains full of liquid at all times.

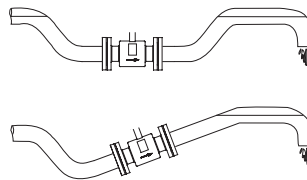

Figure 14: Pipe positioned to keep water in detector

METER GASKETS AND GROUNDING

Gaskets and grounding are required for proper mag meter installation.

IMPORTANT

If you received grounding rings with your meter, install them. Electromagnetic meters require a good ground for proper operation. Grounding rings also help protect the edge of the liner from debris that may flow from the pipe.

Meter/Pipeline Connection Gaskets

IMPORTANT

It is essential that the mag meter amplifier's input ground (zero voltage reference) be electrically connected to the liquid media and to a good, solid earth ground reference.

You must install gaskets (not provided) between the detector's isolating liner, grounding rings and the pipeline flange to provide a proper and secure hydraulic seal. Use gaskets that are compatible with the fluid. Center each gasket on the flange to avoid flow restrictions or turbulence in the line.

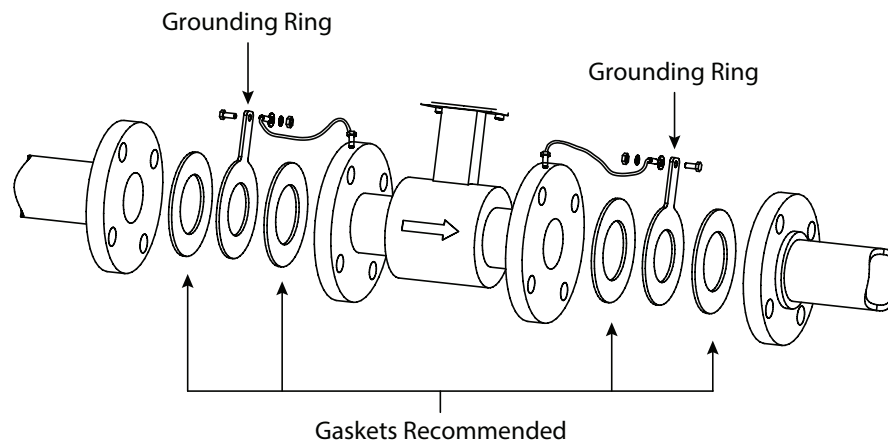

Figure 15: Meter/pipeline connection gaskets and grounding rings

During installation, do not use graphite or any electrically conductive sealing compound to hold the gaskets. This could compromise the accuracy of the measuring signal.

If you are using a grounding ring in the detector/pipeline connection, place the ring between two gaskets. (See "Recommended Installation with Grounding Rings".)

Meter Grounding

Process pipeline material can be either electrically conductive (metal) or not electrically conductive (made of or lined with PVC, fiberglass or concrete).

Recommended Installation with Grounding Rings

IMPORTANT

Badger Meter recommends the installation of a pair of grounding rings between the mating flanges at both ends of the meter. See Figure 15.

Connect the grounding straps to both of the grounding rings and to a good, solid earth ground. Grounding rings are available in stainless steel. If your fluid is too aggressive for stainless steel, order a meter with the optional grounding electrode in a material compatible with the fluid.

AMPLIFIER MOUNTING CONFIGURATION OPTIONS

There are two configuration options for mounting the amplifier. There are many options to accommodate a variety of meter-placement and environmental conditions.

Meter Mount Configuration

The meter mount configuration has the amplifier mounted directly on the detector. This compact, self-contained configuration minimizes installation wiring.

Remote Mount Configuration

The remote mount configuration places the amplifier at a location away from the fluid flow and detector. This is necessary in situations where process fluid temperature or the environment exceeds amplifier ratings.

The detector and amplifier are connected by wires, run through conduit, between junction boxes on the detector and the amplifier. The distance between the detector junction box and amplifier junction box can be up to 500 feet (152 meters). A remote mounting bracket is supplied.

Submersible Option

If you are installing the meter in a vault, you should order the remote amplifier option. You must not install the amplifier inside a vault. We also recommend ordering the remote meter package with the submersible option (NEMA 6P). This will eliminate any potential problems resulting from humidity or temporary flooding in the vault.

NOTE: The National Electronics Manufacturer's Association (NEMA) 6P enclosures are constructed for indoor or outdoor use to provide protection against access to hazardous parts; to provide a degree of protection against ingress of solid foreign objects and water (hose directed water and the entry of water during prolonged submersion at a limited depth); that provide an additional level of protection against corrosion and that will be undamaged by the external formation of ice on the enclosure.

WIRING

Wiring Safety

⚠ WARNING

AT INSTALLATION, BE SURE TO COMPLY WITH THE FOLLOWING REQUIREMENTS:

- Disconnect power to the unit before attempting any connection or service to the unit.
- Do not bundle or route signal lines with power lines.
- Keep all lines as short as possible.
- Use twisted pair shielded wire for all output wiring.
- Observe all applicable, local electrical codes.

Opening the M2000 Meter Cover

The M2000 amplifier's design lets you open the cover without completely removing it.

⚠ WARNING

COVER IS ATTACHED WITH DISPLAY RIBBON CABLE.

To open the cover you will need a blade screwdriver.

Follow these steps:

1. Disconnect power to the unit.
2. Completely remove the two screws from either the left or the right side of the amplifier.

3. Loosen each of the remaining screws so that the round head of the screw clears the top edge of the cover.
4. Lift and pivot the cover into the open position.



Figure 16: Open cover

Power Connections

External Disconnect

⚠ CAUTION

- Install an external disconnect switch or circuit breaker that meets local standards.
- Position the M2000 meter in an accessible location.
- Position and identify the disconnect device so as to provide safe and easy operation.
- Label the disconnect device as being for the mag meter.

AC Power Wiring

For the AC power connections, use three wire-sheathed cable with an overall cable diameter of 0.2...0.45 inch (5...12 mm). For signal output, use 18...22 gauge (0.25...0.75 mm²) shielded wire. Overall cable diameter between 0.12...0.35 inch (3...9 mm).

⚠ CAUTION

TO PREVENT ACCIDENTS, CONNECT MAIN POWER ONLY AFTER ALL OTHER WIRING HAS BEEN COMPLETED.

The amplifier is a microprocessor device. It is important that the power supply be as “clean” as possible. Avoid using power lines that feed heavy loads: pumps, motors, etc. If dedicated lines are not available, a filtering or isolation system may be required.

Power wiring is the same for meter mount and remote mount amplifiers.

Remote Mount Installation

If you are installing the M2000 amplifier in a remote location, review the procedures in this section.

Mount Bracket to Amplifier

1. Align bracket-mounting holes with amplifier mounting holes.
2. Attach bracket to amplifier with supplied screws. Torque screws to 80 inch pounds.

Wiring Configuration

Wiring between the detector and the M2000 amplifier comes complete from the factory. If your installation requires the use of conduit, we recommend that you follow these steps when wiring the detector to the amplifier.

1. Remove the junction box lid. Carefully remove the wires connected to the terminal blocks that run to the M2000 amplifier. See the chart below for a reference of wire color to terminal connection.
2. Run cable through the conduit from the amplifier location while retaining the wiring of the cable to the amplifier, as supplied.

3. Complete conduit assembly on both ends and rewire the cable into the junction box as it was previously wired.

Wiring for Remote Configuration

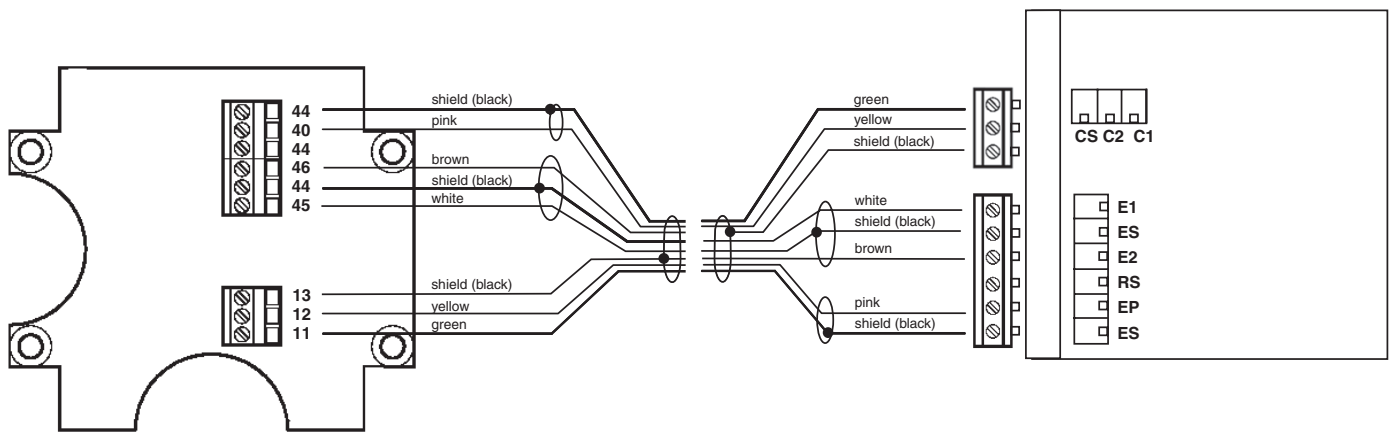

Figure 17: Wiring for remote configuration

Remote style M2000 amplifier models can be ordered with standard cables measuring 15, 30, 50, 100 and 150 feet. In addition, cables up to 500 feet are available.

Junction Box			Amplifier
Connection No.	Description	Wire Color	Connection
11	Coil	Green	C1
12	Coil	Yellow	C2
13	Main Shield	Black (Red Ferrule)	CS
45	Electrode	White	E1
44*	Electrode Shield	Black	ES
46	Electrode	Brown	E2
40	Empty Pipe	Pink	EP
44*	Empty Pipe Shield	Black	ES

*Connections with the No. 44 are lying on the same potential.

Empty Pipe Detection Considerations

Take into account the following cable length and conductivity requirements, if you will be using empty pipe detection.

Cable Length (Feet)	Minimum Conductivity Required (µS/cm)
0*	5
100	20
500	100

* Meter Mount

CONFIGURING INPUT/OUTPUT (I/O)

This section describes wiring the following M2000 meter inputs/outputs:

- Analog output
- Digital input
- Digital outputs
- Communication

Once the sensor and the amplifier have been wired, wire any inputs and outputs to the M2000 amplifier.

Do not connect the main power connection until you have made all other wiring connections. Follow all of the safety precautions and local code to prevent electrical shock and damage to the electronic components.

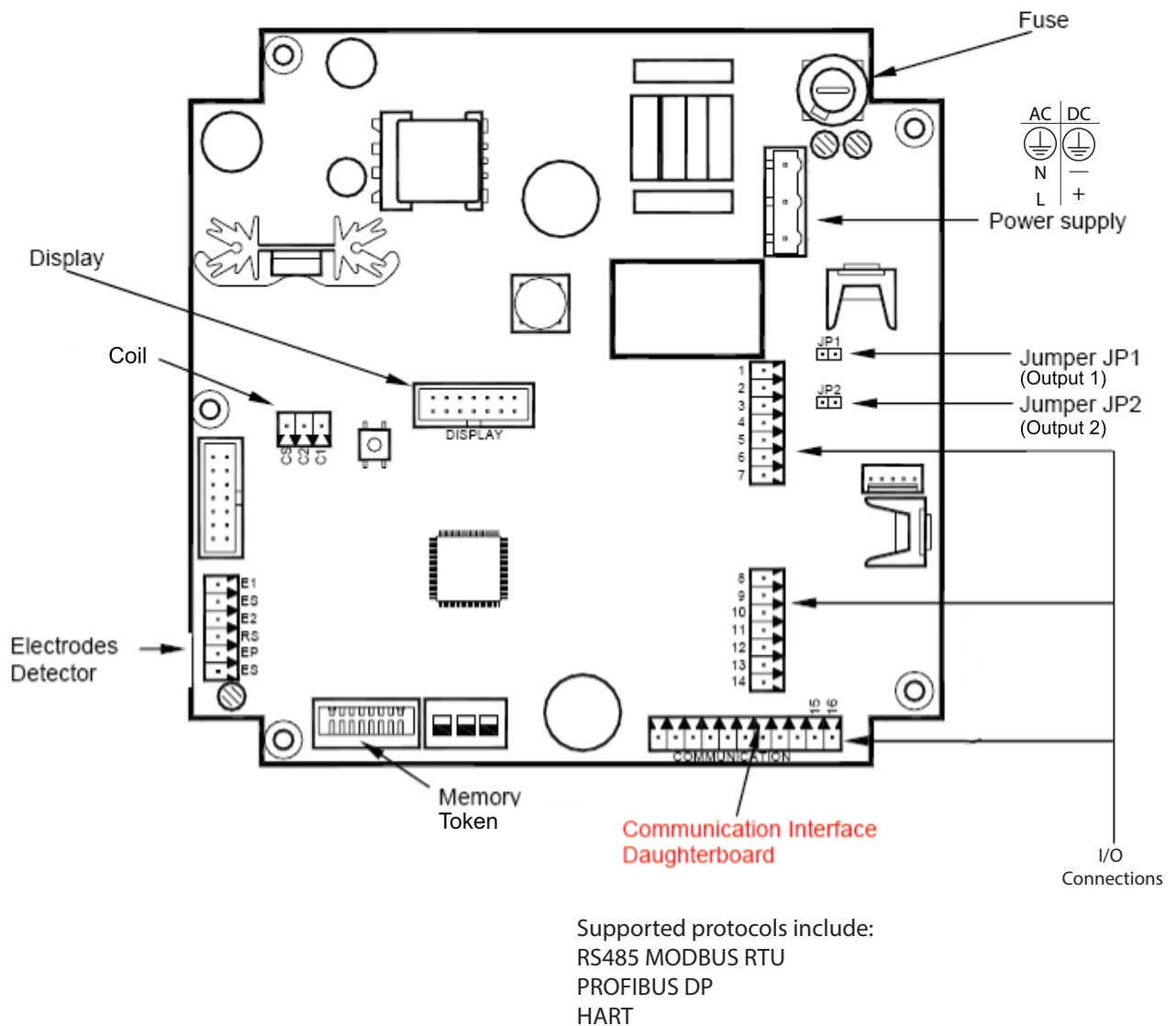

Figure 18: Configuring input/output

Input/Output	Description	Terminal
Analog Output	0...20 mA Resistive Load < 800 ohms 4...20 mA Resistive Load < 800 ohms 0...10 mA Resistive Load < 800 ohms 2...10 mA Resistive Load < 800 ohms	16 (+) 15 (-)
Digital Output 1	Passive max. 30V DC, 100 mA Active 24V DC, 50 mA (set Jumper JP1) Max. Frequency 10 kHz	1 (+) and 2 (-)
Digital Output 2	Passive max. 30V DC, 100 mA Active 24V DC, 50 mA (set Jumper JP2) Max. Frequency 10 kHz	3 (+) and 4 (-)
Digital Output 3	Passive Max 30V DC, 100 mA, 10 kHz Solid State Relay 48V AC, 500 mA, 1 kHz * Software configurable	10 (+) and 9 (-) 10 (+) and 11 (-)
Digital Output 4	Passive Max 30V DC, 100 mA, 10 kHz Solid State Relay 48V AC, 500 mA, 1 kHz * Software configurable	13 (+) and 12 (-) 13 (+) and 14 (-)
Digital Input	5...30V DC	8 (+) and 9 (-)
Communications (Port A)	RS232, configurable, MODBUS RTU, Remote Menu, or Primo 3.1 Emulation.	7 GND 6 Rx 5 Tx

Analog Output Wiring Diagram

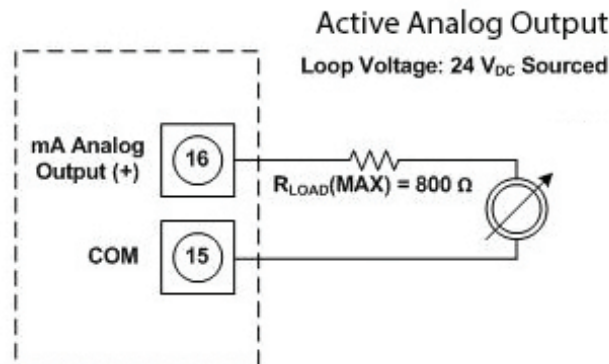

Figure 19: Analog output wiring diagram

Digital Output Wiring Diagrams

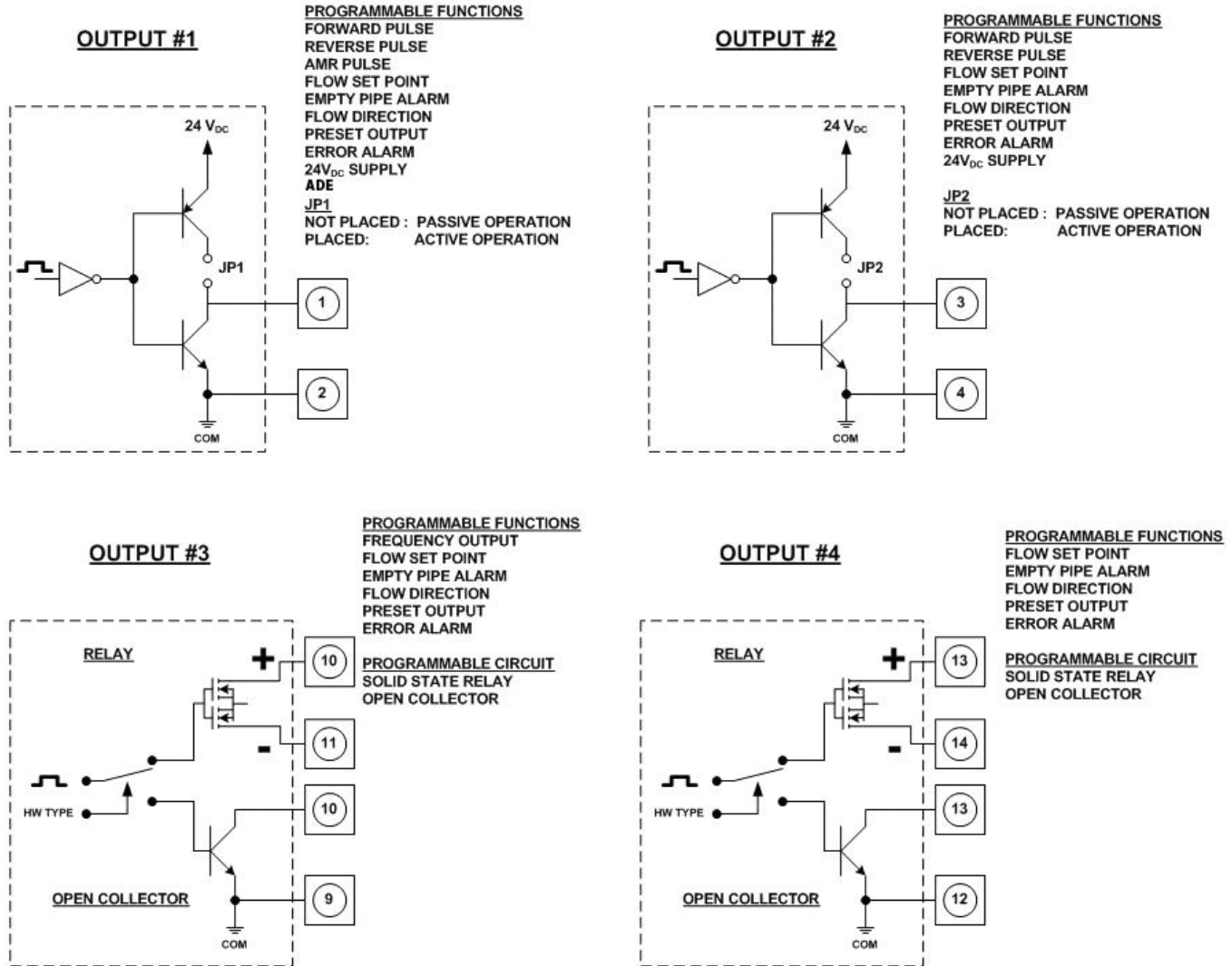

Figure 20: Digital output wiring diagrams

Digital Input Wiring Diagram

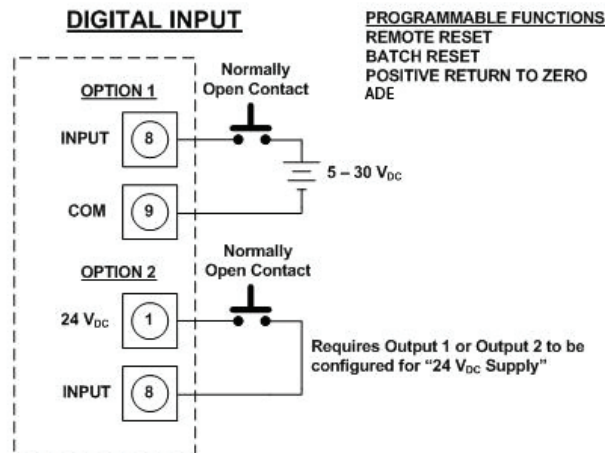

Figure 21: Digital input wiring diagram

PROGRAMMING THE M2000 METER

The M2000 amplifier comes pre-programmed from the factory. Typically, you will not need to do any additional programming. However, to take advantage of special features, you can program the meter for your specific needs. If you will be programming the meter, familiarize yourself with the M2000 meter's Function Buttons and follow the procedures outlined below.

Displays

There are two types of displays on the M2000 meter:

- Menu Selection
- Numeric Entry

Menu Selection Display

Menu selection displays will appear in the following format:

```

DISPLAY TITLE
>Menu Selection 1
  Menu Selection 2
DIRECTIONS LINE
  
```

Display format

```

START MENU
>Exit this Menu
  Main Menu
MORE: ↑,↓      ENTER:>
  
```

Example menu

Figure 22: Menu selection displays

The top line shows the title of the display screen. Below that are two visible menu selections. The bottom line provides directions for user input.

Typically, a menu contains more options than will fit in the two menu selection lines. Press the [↑] and [↓] buttons to scroll the display text up and down one line at a time. When the arrow is pointed to your desired menu option, press [E] to select the item and open its display.

Numeric Entry Display

Numeric entry displays will appear in the following format:

```

DISPLAY TITLE
  Description Line
  Numeric Value
DIRECTIONS LINE
  
```

Display format

```

LOW FLOW CUTOFF
% of      300.000 GPM
          2.00%
CHG: +, -      NEXT:E
  
```

Example numeric entry display

Figure 23: Numeric entry displays

The top line shows the title of the display screen. The second line is a description of the value. The third line shows the current value. The bottom line provides directions for user input.

NOTE: The bottom line of a numeric-value display provides prompts regarding the function of each button. The [+] or [-] button will change the value of the numeral. The [E] button will move the cursor one digit to the right. When the cursor is at the final, right-most digit, pressing [E] will reposition the cursor at the left-most digit. The bottom line display will change to reflect the new function of the [E] button. Press [E] to save the current entry. Press [+] to edit the current entry.

```

LOW FLOW CUTOFF
% of      300.000 GPM
          3.00%
EDIT:+      SAVE:E
  
```

Figure 24: Title, value description, current value, directions to user

Details on how to change and set numeric values are described in "Function Buttons" on page 20.

Function Buttons

All M2000 meter programming is accomplished using the three function buttons located on the front of the amplifier:



Figure 25: Function buttons

NOTE: Throughout this manual, the buttons will be referred to as: [↑] or [+] and [↓] or [-], depending on the context. The "Enter" button will be referred to as [E].



Consider the [+ | ↑] button as the "next step" or "scroll text up" button. During programming, pressing this button will go to the next menu selection, or increment a numeral.

Example 1: The illustration below shows the M2000 meter's *Main Menu*. The selection arrow is pointing to the Exit this Menu selection.

To scroll up to the menu's next selection, press [↑] once. The menu text scrolls up to the next menu selection, *Main Menu*.



Figure 26: Scroll up

Example 2: Some procedures require you to enter a numeric value. The [+] button is used to increment the selected numeral. The illustration below shows the *Low Flow Cutoff* parameter display. Notice the cursor under the 2 in the ones' place. In this case, press [+] once to increment the numeral to the value of 3.00%.



Figure 27: Enter a numeric value



Consider the Down Arrow [- | ↓] button as the "previous step" button. During a procedure, pressing this button will go to the menu's previous selection or decrement a numeral.

Example 1: The illustration below shows the M2000 meter's *Main Menu*. The selection arrow is pointing to the Meter Setup selection. To scroll the text down to the menu's previous selection, Exit this Menu (which is not visible on the display), press [↓] once.



Figure 28: Go to previous step

Example 2: For procedures that require you to enter a numeric value, the [-] button is used to decrement the selected numeral. The illustration below shows the *Low Flow Cutoff* parameter display. Notice the cursor under the 3 in the ones' place. In this case, press the [-] once to decrement the numeral to the value of 2.00 %.

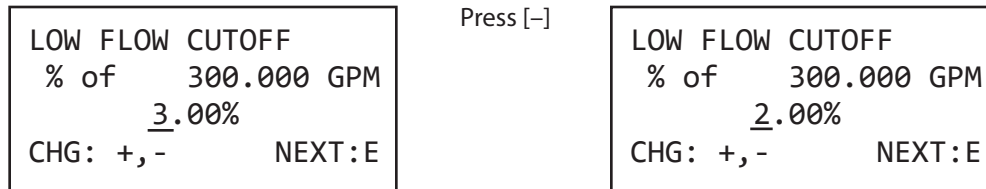

Figure 29: Decrease a value



The [E] button functions as an "Enter" button, or "cursor right" button.

Example 1: The illustration below shows the M2000 meter's *Main Menu*. The selection arrow is pointing to the Meter Setup selection. Press [E] to select Meter Setup, and open the *Meter Setup* display.

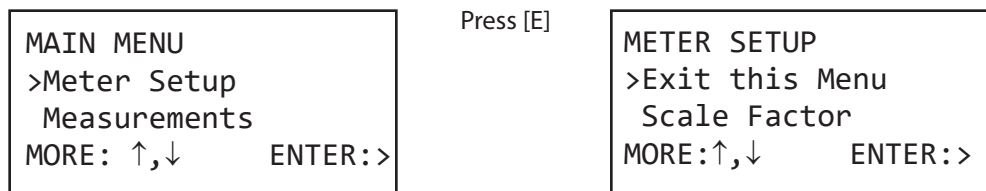

Figure 30: Go to meter setup

In cases where you are entering a numeric value, the [E] button does not function as the "Enter" button, but rather, will move the cursor to the right. When the cursor is at the right-most position, the [E] will now serve as the Enter key.

Example 2: The illustration below shows the *Low Flow Cutoff* display. The cursor is under the 3 in the ones' place. In this case, press [E] to move the cursor to the right one digit.



Figure 31: Move the cursor to the right

SECURITY

The M2000 meter's security feature gives you the option to restrict access to the meter by way of a five-digit Personal Identification Number (PIN). The system administrator can set up a single PIN for each of the three levels of access:

- **Administration** – allows access to all M2000 meter menu configuration screens.
- **Service** – allows access to service-level and user-level menu configuration screens.
- **User** – allows access only to user-level menu configuration screens.

Not all levels of access need to be set. If no PINs are set up, any M2000 meter user will have access to all functions.

NOTE: The security settings will also apply to remote access. All remote writes to the meter will be blocked unless the user is remotely logged in.

Setting the Administration PIN

Users logged in with the Administration PIN have access to all M2000 meter menu configuration screens.

To set the administrator's PIN, follow these steps from the *Advanced* menu:

1. Select **Security** to view the *Security* menu.
2. Select **Set Admin PIN** to view the *Admin PIN* display.
3. Set the five-digit PIN number to the desired value.
4. Press **[E]** to save the PIN and to return to the *Security* menu.

Setting the Service PIN

Users logged in with the Service PIN have access to service level menu configuration screens. Service users will not have access to administrative screens.

NOTE: In order to set a service-level PIN, you must first set up an administration PIN.

To set the service PIN, follow these steps from the *Advanced* menu:

1. Select **Security** to view the *Security* menu.
2. Select **Set Service PIN** to view the *Service PIN* display.
3. Set the five-digit PIN number to the desired value.
4. Press **[E]** to save the PIN and to return to the *Security* menu.

Setting the User PIN

Users logged in with this User PIN have access to user-level procedures. Users will not have access to administrative or service screens.

NOTE: In order to set a user-level PIN, you must first set up an administration PIN and a service PIN.

To set the user's PIN, follow these steps from the *Advanced* menu:

1. Select **Security** to view the *Security* menu.
2. Select **Set User PIN** to view the *User PIN* display.
3. Set the five-digit PIN number to the desired value.
4. Press **[E]** to save the PIN and to return to the *Security* menu.

Entering Your Personal Identification Number (PIN)

If your system has been set up with PIN security, you need to enter a PIN to access programming functions. There are three access levels, each with its own unique PIN: User, Service and Administration. Your system administrator will provide you with the appropriate PIN.

NOTE: All PINs are factory set to 00000. At this setting, you will not be required to enter a PIN. If the system administrator has not set the PIN, pressing [E] from the *Start Screen* opens the *Main Menu*.

If you forget or misplace your PIN, call Badger Meter Customer Service to get a master password. When you call, have the security code that appears in the upper right corner of the *PIN Request* display.

Follow these steps to enter your PIN in the M2000 meter:

1. At the *Main Menu*, press [E]. The *PIN Request* display opens.

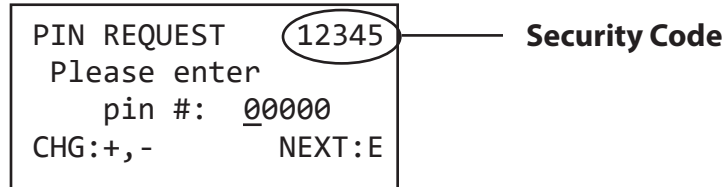

Figure 32: PIN request

2. Press [+] to increment the numeral.
3. Press [E] to move the cursor to the next digit.
4. Repeat the steps to set each of the five digits to match your PIN.
5. Press [E]. If you entered a valid PIN, the *Main Menu* opens indicating your level of access.

If you entered the wrong PIN, you will see the following display:



Figure 33: Wrong PIN entered

- Press [E] to return to the *PIN Request* display.
- Repeat Steps 1 through 5.

NOTE: Be sure to log off when you have completed work with the M2000 meter. Otherwise, there will be a five-minute delay between your last activity and the time when the M2000 meter will automatically log you off.

SETTING UP THE M2000 METER WITH QUICK SETUP

The M2000 meter provides you with a Quick Setup utility that allows you to set or change your Flow Units, Totalizer Units, Full Scale Flow and Low Flow Cutoff settings. To open the Quick Setup, select **Quick Setup** from the *Start Menu*.

Quick Setup																																													
<p>Flow Unit [GPM]</p>	<p>Flow Unit lets you set the unit of measure for the flow rate and full scale flow. To change the Flow Unit value, follow these steps from the <i>Quick Setup</i> menu.</p> <ol style="list-style-type: none"> 1. Select Flow Unit to view the <i>Flow Unit</i> display. 2. Press [↑] or [↓] to position the arrow next to one of the following Flow Units: <table border="1" style="width: 100%; border-collapse: collapse;"> <thead> <tr> <th style="text-align: center;">Code</th> <th style="text-align: center;">Flow Unit</th> <th style="text-align: center;">Code</th> <th style="text-align: center;">Flow Unit</th> </tr> </thead> <tbody> <tr> <td style="text-align: center;">LPS</td> <td>Liters/Second</td> <td style="text-align: center;">GPM</td> <td>Gallons/Minute</td> </tr> <tr> <td style="text-align: center;">LPM</td> <td>Liters/Minute</td> <td style="text-align: center;">GPH</td> <td>Gallons/Hour</td> </tr> <tr> <td style="text-align: center;">LPH</td> <td>Liters/Hour</td> <td style="text-align: center;">MGD</td> <td>Mega Gallons/Day</td> </tr> <tr> <td style="text-align: center;">M³S</td> <td>Cubic Meters/Second</td> <td style="text-align: center;">IGS</td> <td>UKG/Second</td> </tr> <tr> <td style="text-align: center;">M³M</td> <td>Cubic Meters/Minute</td> <td style="text-align: center;">IGM</td> <td>UKG/Minute</td> </tr> <tr> <td style="text-align: center;">M³H</td> <td>Cubic Meters/Hour</td> <td style="text-align: center;">IGH</td> <td>UKG/Hour</td> </tr> <tr> <td style="text-align: center;">F³S</td> <td>Cubic Feet/Second</td> <td style="text-align: center;">LbM</td> <td>Pounds/Minute</td> </tr> <tr> <td style="text-align: center;">F³M</td> <td>Cubic Feet/Minute</td> <td style="text-align: center;">OPM</td> <td>Ounces/Minute</td> </tr> <tr> <td style="text-align: center;">F³H</td> <td>Cubic Feet/Hour</td> <td style="text-align: center;">BPM</td> <td>Barrels/Minute</td> </tr> <tr> <td style="text-align: center;">GPS</td> <td>Gallons/Second</td> <td></td> <td></td> </tr> </tbody> </table> <ol style="list-style-type: none"> 3. Press [E] to save the Flow Units setting. 	Code	Flow Unit	Code	Flow Unit	LPS	Liters/Second	GPM	Gallons/Minute	LPM	Liters/Minute	GPH	Gallons/Hour	LPH	Liters/Hour	MGD	Mega Gallons/Day	M ³ S	Cubic Meters/Second	IGS	UKG/Second	M ³ M	Cubic Meters/Minute	IGM	UKG/Minute	M ³ H	Cubic Meters/Hour	IGH	UKG/Hour	F ³ S	Cubic Feet/Second	LbM	Pounds/Minute	F ³ M	Cubic Feet/Minute	OPM	Ounces/Minute	F ³ H	Cubic Feet/Hour	BPM	Barrels/Minute	GPS	Gallons/Second		
Code	Flow Unit	Code	Flow Unit																																										
LPS	Liters/Second	GPM	Gallons/Minute																																										
LPM	Liters/Minute	GPH	Gallons/Hour																																										
LPH	Liters/Hour	MGD	Mega Gallons/Day																																										
M ³ S	Cubic Meters/Second	IGS	UKG/Second																																										
M ³ M	Cubic Meters/Minute	IGM	UKG/Minute																																										
M ³ H	Cubic Meters/Hour	IGH	UKG/Hour																																										
F ³ S	Cubic Feet/Second	LbM	Pounds/Minute																																										
F ³ M	Cubic Feet/Minute	OPM	Ounces/Minute																																										
F ³ H	Cubic Feet/Hour	BPM	Barrels/Minute																																										
GPS	Gallons/Second																																												
<p>Totalizer Unit [USG]</p>	<p>Totalizer Unit establishes the units of measure for the totalizers. To change the Totalizer Unit value, follow these steps from the <i>Totalizer Unit</i> display.</p> <ol style="list-style-type: none"> 1. Press [↑] or [↓] to position the arrow next to one of the following Totalizer Units: <table border="1" style="width: 100%; border-collapse: collapse;"> <thead> <tr> <th style="text-align: center;">Code</th> <th style="text-align: center;">Totalizer Unit</th> <th style="text-align: center;">Code</th> <th style="text-align: center;">Totalizer Unit</th> </tr> </thead> <tbody> <tr> <td style="text-align: center;">L</td> <td>Liter</td> <td style="text-align: center;">UKG</td> <td>Imperial Gallon</td> </tr> <tr> <td style="text-align: center;">HL</td> <td>Hectoliter</td> <td style="text-align: center;">Lb</td> <td>Pound</td> </tr> <tr> <td style="text-align: center;">M³</td> <td>Cubic Meter</td> <td style="text-align: center;">Oz</td> <td>Fluid Ounce</td> </tr> <tr> <td style="text-align: center;">CFt</td> <td>Cubic Feet</td> <td style="text-align: center;">Aft</td> <td>Acre Feet</td> </tr> <tr> <td style="text-align: center;">USG</td> <td>U.S. Gallon</td> <td style="text-align: center;">BBL</td> <td>Barrel</td> </tr> <tr> <td style="text-align: center;">MG</td> <td>Mega Gallon</td> <td></td> <td></td> </tr> </tbody> </table> <ol style="list-style-type: none"> 2. Press [E] to save the Totalizer Units setting. 	Code	Totalizer Unit	Code	Totalizer Unit	L	Liter	UKG	Imperial Gallon	HL	Hectoliter	Lb	Pound	M ³	Cubic Meter	Oz	Fluid Ounce	CFt	Cubic Feet	Aft	Acre Feet	USG	U.S. Gallon	BBL	Barrel	MG	Mega Gallon																		
Code	Totalizer Unit	Code	Totalizer Unit																																										
L	Liter	UKG	Imperial Gallon																																										
HL	Hectoliter	Lb	Pound																																										
M ³	Cubic Meter	Oz	Fluid Ounce																																										
CFt	Cubic Feet	Aft	Acre Feet																																										
USG	U.S. Gallon	BBL	Barrel																																										
MG	Mega Gallon																																												

Quick Setup	
Full Scale Flow	<p>Full Scale Flow sets the maximum flow the system is expected to measure. This parameter has influence on other system parameters. These parameters include:</p> <ul style="list-style-type: none"> • Frequency Output – Full scale frequency is observed at full scale flow • Low Flow Cutoff – Changes to full scale flow affect the measuring cut-off threshold of the meter • Alarm Outputs – Changes to full scale flow adjusts the thresholds for generating set point alarms • Pulse Outputs – Changes to full scale flow adjusts the pulse frequency and duty cycle • Analog Outputs – Changes to full scale flow adjusts the interpretation of the analog output signal <p>Change the full scale flow based on the meter size and the application's requirements. Verify that the full scale flow falls within the meter's suggested flow range limits. In terms of flow velocity, the meter's limits are from 0.1 to 39.4 feet/second.</p> <p>The full scale flow is valid for both flow directions.</p> <p>NOTE: If the flow rate exceeds the full scale setting, an error message indicates that the configured full scale range has been exceeded. However, the meter will continue to measure. This will affect the latency of the pulse outputs and possibly cause overflow. Furthermore, the analog output may also be placed in alarm mode.</p> <p>To set or change the Full Scale Flow, follow these steps from the <i>Quick Setup</i> menu:</p> <ol style="list-style-type: none"> 1. Select Full Scale Flow to view the <i>Full Scale Flow</i> display. 2. Set the full scale flow value to the desired setting. 3. Press [E] to save the full scale flow value and return to the <i>Measurements</i> menu.
Low Flow Cutoff	<p>Low Flow Cutoff defines the threshold at which flow measurement will be forced to zero. The cutoff value can be set from 0% to 10% of the full scale flow. Increasing this threshold will help prevent false readings during "no flow" conditions possibly caused by pipe vibration or inherent system noise.</p> <p>To change Low Flow Cutoff, follow these steps from the <i>Low Flow Cutoff</i> display.</p> <ol style="list-style-type: none"> 1. Set the Low Flow Cutoff value to the desired setting, between 0% and 10%. 2. Press [E] to save the value.

QUICK REFERENCE

Main Menu	→ Meter Setup	→ Scale Factor
		→ Empty Pipe Detect
		→ Power Line Freq
		→ Excitation Freq
		→ Pipe Diameter
		→ Detector Factor
		→ Detector Offset
	→ Measurements	→ Velocity Unit
		→ Flow Unit
		→ Totalizer Unit
		→ Full Scale Flow
		→ Low Flow Cutoff
		→ Flow Direction
		→ Damping Factor
	→ Inputs/Outputs	→ Analog Output
		→ Digital Input
		→ Digital Output 1
		→ Digital Output 2
		→ Digital Output 3
		→ Digital Output 4
		→ Flow Simulation
	→ Clear Totals	→ TN
		→ T+
		→ T-
		→ PS
		→ Tpwroff
	→ Communications	→ Port A Settings
		→ Port B Settings
		→ Diagnostics
	→ Advanced	→ Data Logger
		→ Token Copy
		→ Encoder Protocol
		→ Totalizer Dials
		→ Totalizer Resolution
		→ Backlight Control
		→ Analog Calibrate
		→ Software Filter
		→ Empty Pipe Cal.
		→ Security
	→ Info/Help	→ Error Counts
		→ Power Up Counter
		→ Power Off Totalizer
		→ Version Info
		→ Serial Number
		→ Meter Tag Name
		→ Daughterboard Info
		→ Polarization Volt
		→ Restore Defaults
	→ Language Select	→ English
		→ Espanol

USING THE M2000 METER MAIN MENU PROGRAMMING OPTIONS

The following M2000 meter programming options are available from the *Main Menu*:

- *Meter Setup*
- *Measurements*
- *Inputs/Outputs*
- *Clear Totals*
- *Communications*
- *Advanced*
- *Info/Help*
- *Language Select*

In the section that follows, the applicable security level for each menu option is indicated as follows:



Administrative



Service





User





Options that can be set at *Quick Setup* are indicated with:











The factory default values are shown, enclosed in brackets.



NOTE: Options that are listed [Factory Set] should not be changed without specific directions from authorized Badger Meter personnel.



Meter Setup	
<p>Scale Factor [0.0%]</p> 	<p>Changing the scale factor lets you adjust the meter's accuracy without disturbing factory-set parameters. You can tune the meter to meet changing application requirements. For example, if the meter is under registering by 0.5 percent then set the scale factor to +0.5%. If the meter is over registering by 0.5 percent then set the scale factor to -0.5%.</p> <p>To set the Scale Factor, follow these steps from the <i>Meter Setup</i> menu:</p> <ol style="list-style-type: none"> 1. Select Scale Factor, to open the <i>Scale Factor</i> display. 2. Set the Scale Factor value to the desired setting. 3. Press [E], to save the new value and return to the <i>Meter Setup</i> menu.
<p>Empty Pipe Detect [Off]</p> 	<p>When set to On, Empty Pipe Detect indicates to the outputs and the display that the meter is not completely filled. When set to Off, empty pipe detect is disabled.</p> <p>Enabling empty pipe detect requires a one-time calibration. Calibration is described in the <i>Advanced</i> menu section under Empty Pipe Cal.</p> <p>To set Empty Pipe Detect, follow these steps from the <i>Meter Setup</i> menu:</p> <ol style="list-style-type: none"> 1. Select Empty Pipe Detect to view the <i>Empty Pipe Detect</i> display. 2. Position the arrow next to On or Off. 3. Press [E] to save the Empty Pipe Detect On or Off and return to the <i>Meter Setup</i> menu.
<p>Power Line Freq [60 Hz]</p> 	<p>Power Line Freq provides measuring immunity to industrial noise from a power supply feed.</p> <p>To set Power Line Frequency, follow these steps from the <i>Meter Setup</i> menu:</p> <ol style="list-style-type: none"> 1. Select Power Line Freq to view the <i>Power Line Frequency</i> display. 2. Position the arrow next to 50 Hz or 60 Hz. 3. Press [E] to save the power line frequency and return to the <i>Meter Setup</i> menu.





Meter Setup											
<p>Excitation Freq [Factory Set]</p> 	<p>The Excitation Freq parameter is set at the factory. You can change Excitation Freq to configure the DC excitation of the coils. Supported frequencies are dependent on the configured power line frequency:</p> <table border="1" style="margin-left: auto; margin-right: auto;"> <thead> <tr> <th style="text-align: center;">50 Hz</th> <th style="text-align: center;">60 Hz</th> </tr> </thead> <tbody> <tr> <td style="text-align: center;">1 Hz</td> <td style="text-align: center;">1 Hz</td> </tr> <tr> <td style="text-align: center;">3.125 Hz</td> <td style="text-align: center;">3.75 Hz</td> </tr> <tr> <td style="text-align: center;">6.25 Hz</td> <td style="text-align: center;">7.5 Hz</td> </tr> <tr> <td style="text-align: center;">12.5 Hz</td> <td style="text-align: center;">15 Hz</td> </tr> </tbody> </table> <p>To change Excitation Frequency, follow these steps from the <i>Meter Setup</i> menu:</p> <ol style="list-style-type: none"> 1. Select Excitation Freq to view the <i>Excitation Frequency</i> display. 2. Position the arrow next the desired frequency. 3. Press [E] to save the excitation frequency and return to the <i>Meter Setup</i> menu. 	50 Hz	60 Hz	1 Hz	1 Hz	3.125 Hz	3.75 Hz	6.25 Hz	7.5 Hz	12.5 Hz	15 Hz
50 Hz	60 Hz										
1 Hz	1 Hz										
3.125 Hz	3.75 Hz										
6.25 Hz	7.5 Hz										
12.5 Hz	15 Hz										
<p>Pipe Diameter [Factory Set]</p> 	<p>The Pipe Diameter parameter is set at the factory. In the event the amplifier is replaced, verify that the pipe diameter matches the installed pipe size.</p> <p>To change Pipe Diameter, follow these steps from the <i>Meter Setup</i> menu:</p> <ol style="list-style-type: none"> 1. Select Pipe Diameter to open the <i>Pipe Diameter</i> display. 2. Position the arrow next to one of the pipe diameters. 3. Press [E] to save the pipe diameter and return to the <i>Meter Setup</i> menu. 										
<p>Detector Factor [Factory Set]</p> 	<p>The Detector Factor parameter is set at the factory. This factor compensates for accuracy error as a result of the installed detector. If accuracy adjustment of the meter is required, see the Scale Factor parameter.</p> <p>In the event the amplifier is replaced, this parameter must be reprogrammed with the original detector factor.</p>										
<p>Detector Offset [Factory Set]</p> 	<p>The Detector Offset parameter is set at the factory. This parameter compensates for accuracy error as a result of the installed detector. If accuracy adjustment of the meter is required, see the Scale Factor parameter.</p>										



Measurements																																													
<p>Velocity Unit [ft/sec]</p> 	<p>Velocity Unit lets you set the velocity to meters/sec or feet/sec.</p> <p>To set Velocity Unit, follow these steps from the <i>Measurements</i> menu:</p> <ol style="list-style-type: none"> 1. Select Velocity Unit. 2. Position the arrow next to meters/sec or feet/sec. 3. Press [E] to save the Velocity Unit and return to the <i>Measurements</i> menu. 																																												
<p>Flow Units [GPM]</p> 	<p>Flow Units lets you set the unit of measure for the flow rate and full scale flow. Changing the flow units parameter readjusts the full scale flow parameter. For example, changing from gpm to gps would change the full scale flow from 60 gpm to 1 gps.</p> <p>To change the Flow Unit, follow these steps from the <i>Measurements</i> menu:</p> <ol style="list-style-type: none"> 1. Select Flow Units to view the <i>Flow Units</i> display. 2. Position the arrow next to one of the following flow unit options: <table border="1" style="width: 100%; border-collapse: collapse;"> <thead> <tr> <th>Code</th> <th>Flow Unit</th> <th>Code</th> <th>Flow Unit</th> </tr> </thead> <tbody> <tr> <td>LPS</td> <td>Liters/Second</td> <td>GPM</td> <td>Gallons/Minute</td> </tr> <tr> <td>LPM</td> <td>Liters/Minute</td> <td>GPH</td> <td>Gallons/Hour</td> </tr> <tr> <td>LPH</td> <td>Liters/Hour</td> <td>MGD</td> <td>Mega Gallons/Day</td> </tr> <tr> <td>M³S</td> <td>Cubic Meters/Second</td> <td>IGS</td> <td>UKG/Second</td> </tr> <tr> <td>M³M</td> <td>Cubic Meters/Minute</td> <td>IGM</td> <td>UKG/Minute</td> </tr> <tr> <td>M³H</td> <td>Cubic Meters/Hour</td> <td>IGH</td> <td>UKG/Hour</td> </tr> <tr> <td>F³S</td> <td>Cubic Feet/Second</td> <td>MID</td> <td>Mega UKG/Day</td> </tr> <tr> <td>F³M</td> <td>Cubic Feet/Minute</td> <td>LbM</td> <td>Pounds/Minute</td> </tr> <tr> <td>F³H</td> <td>Cubic Feet/Hour</td> <td>OPM</td> <td>Ounces/Minute</td> </tr> <tr> <td>GPS</td> <td>Gallons/Second</td> <td>BPM</td> <td>Barrels/Minute</td> </tr> </tbody> </table> <ol style="list-style-type: none"> 3. Press [E] to save the flow units and return to the <i>Measurements</i> menu. 	Code	Flow Unit	Code	Flow Unit	LPS	Liters/Second	GPM	Gallons/Minute	LPM	Liters/Minute	GPH	Gallons/Hour	LPH	Liters/Hour	MGD	Mega Gallons/Day	M ³ S	Cubic Meters/Second	IGS	UKG/Second	M ³ M	Cubic Meters/Minute	IGM	UKG/Minute	M ³ H	Cubic Meters/Hour	IGH	UKG/Hour	F ³ S	Cubic Feet/Second	MID	Mega UKG/Day	F ³ M	Cubic Feet/Minute	LbM	Pounds/Minute	F ³ H	Cubic Feet/Hour	OPM	Ounces/Minute	GPS	Gallons/Second	BPM	Barrels/Minute
Code	Flow Unit	Code	Flow Unit																																										
LPS	Liters/Second	GPM	Gallons/Minute																																										
LPM	Liters/Minute	GPH	Gallons/Hour																																										
LPH	Liters/Hour	MGD	Mega Gallons/Day																																										
M ³ S	Cubic Meters/Second	IGS	UKG/Second																																										
M ³ M	Cubic Meters/Minute	IGM	UKG/Minute																																										
M ³ H	Cubic Meters/Hour	IGH	UKG/Hour																																										
F ³ S	Cubic Feet/Second	MID	Mega UKG/Day																																										
F ³ M	Cubic Feet/Minute	LbM	Pounds/Minute																																										
F ³ H	Cubic Feet/Hour	OPM	Ounces/Minute																																										
GPS	Gallons/Second	BPM	Barrels/Minute																																										
<p>Totalizer Unit [USG]</p> 	<p>The Totalizer Unit parameter establishes the units of measure for the totalizers.</p> <p>To change the Totalizer Unit value, follow these steps from the <i>Measurements</i> menu:</p> <ol style="list-style-type: none"> 1. Select Totalizer Unit to view the <i>Totalizer Unit</i> display. 2. Position the arrow next to one of the following totalizer units: <table border="1" style="width: 100%; border-collapse: collapse;"> <thead> <tr> <th>Code</th> <th>Totalizer Unit</th> <th>Code</th> <th>Totalizer Unit</th> </tr> </thead> <tbody> <tr> <td>L</td> <td>Liters</td> <td>MIG</td> <td>Mega Imperial Gallons</td> </tr> <tr> <td>HL</td> <td>Hectoliters</td> <td>Lb</td> <td>Pounds</td> </tr> <tr> <td>M³</td> <td>Cubic Meters</td> <td>Oz</td> <td>Fluid Ounces</td> </tr> <tr> <td>CFt</td> <td>Cubic Feet</td> <td>Aft</td> <td>Acre Feet</td> </tr> <tr> <td>USG</td> <td>U.S. Gallons</td> <td>BBL</td> <td>Barrels</td> </tr> <tr> <td>MG</td> <td>Mega Gallons</td> <td>SFD</td> <td>Second Foot Day</td> </tr> <tr> <td>UKG</td> <td>Imperial Gallons</td> <td></td> <td></td> </tr> </tbody> </table> <ol style="list-style-type: none"> 3. Press [E] to save the totalizer unit and return to the <i>Measurements</i> menu. 	Code	Totalizer Unit	Code	Totalizer Unit	L	Liters	MIG	Mega Imperial Gallons	HL	Hectoliters	Lb	Pounds	M ³	Cubic Meters	Oz	Fluid Ounces	CFt	Cubic Feet	Aft	Acre Feet	USG	U.S. Gallons	BBL	Barrels	MG	Mega Gallons	SFD	Second Foot Day	UKG	Imperial Gallons														
Code	Totalizer Unit	Code	Totalizer Unit																																										
L	Liters	MIG	Mega Imperial Gallons																																										
HL	Hectoliters	Lb	Pounds																																										
M ³	Cubic Meters	Oz	Fluid Ounces																																										
CFt	Cubic Feet	Aft	Acre Feet																																										
USG	U.S. Gallons	BBL	Barrels																																										
MG	Mega Gallons	SFD	Second Foot Day																																										
UKG	Imperial Gallons																																												



Measurements	
<p>Full Scale Flow [Factory Set]</p>  	<p>The Full Scale Flow parameter sets the maximum flow the system is expected to measure. This parameter has influence on other system parameters. These parameters include:</p> <ul style="list-style-type: none"> • Frequency Output – Full scale frequency is observed at full scale flow • Low Flow Cutoff – Changes to full scale flow affect the measuring cut-off threshold of the meter • Alarm Outputs – Changes to full scale flow adjusts the thresholds for generating set point alarms • Pulse Outputs – Changes to full scale flow adjusts the pulse frequency and duty cycle • Analog Outputs – Changes to full scale flow adjusts the interpretation of the analog output signal <p>Change the full scale flow based on the meter size and the application's requirements. Verify that the full scale flow falls within the meter's suggested flow range limits. In terms of flow velocity, the meter's limits are from 0.1...39.4 feet/second.</p> <p>The full scale flow is valid for both flow directions.</p> <p>NOTE: If the flow rate exceeds the full scale setting, an error message indicates that the configured full scale range has been exceeded. However, the meter will continue to measure. This will affect the latency of the pulse outputs and possibly cause overflow. Furthermore, the analog output may also be placed in alarm mode.</p> <p>To change the Full Scale Flow, follow these steps from the <i>Measurements</i> menu:</p> <ol style="list-style-type: none"> 1. Select Full Scale Flow to view the <i>Full Scale Flow</i> display. 2. Set the full scale flow value to the desired setting. 3. Press [E] to save the full scale flow value and return to the <i>Measurements</i> menu.
<p>Low Flow Cutoff [0.2%]</p>  	<p>Low flow cutoff defines the threshold at which flow measurement will be forced to zero. The cutoff value can be set from 0% to 10% of the full scale flow. Increasing this threshold will help prevent false readings during "no flow" conditions possibly caused by pipe vibration or inherent system noise.</p> <p>To change the Low Flow Cutoff value, follow these steps from the <i>Measurements</i> menu:</p> <ol style="list-style-type: none"> 1. Select Low Flow Cutoff to view the <i>Low Flow Cutoff</i> display. 2. Set the low flow cutoff value to the desired setting. 3. Press [E] to save the new low flow cutoff value.
<p>Flow Direction [Bi-Directional]</p> 	<p>Flow Direction lets you set the meter to measure forward flow only (uni-directional) or both forward and reverse flow (bi-directional).</p> <p>Uni-Directional</p> <p>Flow is totalized in only one direction. The flow direction is indicated by the arrow printed on the detector label. Uni-directional measurements on the main display screen include:</p> <ul style="list-style-type: none"> • T1: Registers forward flow, resettable by menu or MODBUS RTU • T2: Registers forward flow, resettable by menu, MODBUS RTU, or digital input configured for Remote Reset <p>Bi-Directional</p> <p>Flow is totalized in both directions. Bi-directional measurements on the main display screen include:</p> <ul style="list-style-type: none"> • T+: Registers forward flow, resettable by menu or MODBUS RTU • T-: Registers reverse flow, resettable by menu or MODBUS RTU • TN: Registers total flow, T+ – T-, resettable by menu or MODBUS RTU <p>To change the flow direction follow these steps from the <i>Measurements</i> menu.</p> <ol style="list-style-type: none"> 1. Select Flow Direction to view the <i>Flow Direction</i> display. 2. Select Uni-Directional or Bi-Directional. 3. Press [E] to save the flow direction and return to the <i>Measurements</i> menu.





Measurements		
<p>Damping Factor [No Damping]</p> 		<p>The damping factor establishes the stability of the measured flow rate. If back and forth oscillations of the flow rate are observed during normal flow conditions, increase this value incrementally until the flow rate stabilizes. This parameter has no affect on the totalizers.</p> <p>To change the Damping Factor value, follow these steps from the <i>Measurements</i> menu.</p> <ol style="list-style-type: none"> 1. Select Damping Factor to view the <i>Damping Factor</i> display. 2. Select one of the following damping factors: <ul style="list-style-type: none"> 1 Second 10 Seconds 2 Seconds 20 Seconds 3 Seconds 30 Seconds 4 Seconds No Dampening 5 Seconds 3. Press [E] to save the damping factor and return to the <i>Measurements</i> menu.
Inputs/Outputs		
<p>Analog Output</p>	<p>Range [4 to 20 mA]</p> 	<p>The Analog Output parameter establishes the range of the analog output signal. To change Analog Output range, follow these steps from the <i>Inputs/Outputs</i> menu:</p> <ol style="list-style-type: none"> 1. Select Analog Output to view the <i>Analog Output</i> display. 2. Select one of the following options: <ul style="list-style-type: none"> • 4 to 20 mA • 0 to 20 mA • 2 to 10 mA • 0 to 10 mA 3. Press [E] to save the analog output and return to the <i>Inputs/Outputs</i> menu:
	<p>Alarm Mode [OFF]</p> 	<p>This parameter configures the behavior of the analog output during alarm conditions. Three options exist for this parameter: OFF, LOW, and HIGH.</p> <p>OFF: Analog signal is based on flow rate and always within the configured range</p> <p>LOW: During alarm conditions, the analog signal will be 2 mA less than the configured lower range</p> <p>HIGH: During alarm conditions, the analog signal will be 2 mA more than the configured upper range</p> <p>For example, if the analog range is 4 to 20 mA and the alarm mode is set to HIGH, then during a full scale flow alarm condition, the analog output current will be 22 mA.</p> <p>To change the analog output alarm mode, follow these steps from the <i>Inputs/Outputs</i> menu:</p> <ol style="list-style-type: none"> 1. Select Alarm Mode to view the <i>Alarm Mode</i> display. 2. Select one of the following options: <ul style="list-style-type: none"> • OFF • LOW • HIGH 3. Press [E] to save the alarm mode and return to the <i>Inputs/Outputs</i> menu.

Inputs/Outputs		
Digital Input	<p>Digital Input lets you configure the functional operation of the digital input. The following functions are supported:</p> <ul style="list-style-type: none"> • Remote Reset – Clears totalizer T2 (uni-directional) • Batch Reset – Resets batch totalizer PS to preset amount and clears T2 (uni-directional) • Pos Zero Return – Forces flow rate to zero (does not totalize) • ADE – Input configured for ADE operation. See "<i>Encoder Protocol Interface</i>" on page 47. <p>To change Digital Input, follow these steps from the <i>Inputs/Outputs</i> menu:</p> <ol style="list-style-type: none"> 1. Select Digital Input to view the <i>Digital Input</i> display. 2. Select the desired function. 3. Press [E] to save the digital input and return to the <i>Inputs/Outputs</i> menu. 	
Digital Output	<p>Pulses/Unit [1]</p> 	<p>The Pulses/Unit parameter lets you set how many pulses per unit of measure will be transmitted to remote applications. For example, assuming the unit of measure is gallons:</p> <ul style="list-style-type: none"> • Setting the Pulses/Unit to 1 will transmit 1 pulse every gallon • Setting the Pulses/Unit to 0.01 will transmit 1 pulse every 100 gallons <p>You must configure pulses/unit if the function of the selected output is to be forward, reverse or AMR pulse.</p> <p>This parameter must be considered with the Pulse Width and Full Scale Flow parameters. The maximum pulse frequency is 10 kHz. The frequency is correlated with the flow rate. Violation of output frequency limits will generate a configuration error.</p> <p>To change the pulses/unit, follow these steps from the <i>Inputs/Outputs</i> menu:</p> <ol style="list-style-type: none"> 1. Select Digital Output 1 or 2 and press [E] to open the <i>Digital Output</i> menu. 2. From the <i>Digital Output</i> menu select Pulses/Unit, and press [E] to open the <i>Pulses/Unit</i> display. 3. Enter the pulses/unit value. Press [E] to save the new parameter and return to the <i>Digital Output</i> menu.
	<p>Pulse Width [0 ms]</p> 	<p>The Pulse Width parameter establishes the On duration of the transmitted pulse. The configurable range is from 0 to 1000 ms.</p> <ul style="list-style-type: none"> • Non-zero pulse width configuration – the Off duration of the transmitted pulse is dependent on flow rate. The Off duration is to be at least the configured On duration. At full scale flow, the On duration equals the Off duration. The maximum configurable output frequency is limited to 500 Hz. • 0 ms pulse width configuration – the duty cycle of the transmitted pulse is at 50 percent allowing for a maximum configurable output frequency of 10 kHz. <p>This parameter must be considered with the Pulses/Unit and Full Scale Flow parameters. The maximum pulse frequency is 10 kHz. The frequency is correlated with the flow rate. Violation of output frequency limits will generate a configuration error.</p> <p>To change the pulse width, follow these steps from the <i>Inputs/Outputs</i> menu:</p> <ol style="list-style-type: none"> 1. Select Digital Output 1 or 2 and press [E] to open the <i>Digital Output</i> menu. 2. From the <i>Digital Output</i> menu select Pulse Width, and press [E] to open the <i>Pulse Width</i> display. 3. Enter the pulse width value. Press [E] to save the new parameter and return to the <i>Digital Output</i> menu.





Inputs/Outputs		
Digital Output (continued)	Full Scale Frequency [3: 1000 Hz] 	The Full Scale Frequency parameter establishes the full scale flow output frequency when the flow rate equals the configured full scale flow. To change the Full Scale Frequency, follow these steps from the <i>Inputs/Outputs</i> main menu: <ol style="list-style-type: none"> 1. Select Digital Output 1, 2, or 3 and press [E] to open the <i>Digital Output</i> menu. 2. From the <i>Digital Output</i> menu select Full Scale Frequency, and press [E] to open the <i>Full Scale Frequency</i> display. 3. Set the full scale frequency value to the desired setting. 4. Press [E] to save the new parameter and return to the <i>Digital Output</i> menu.
	Preset Amount [0.0] 	Preset amount lets you set the reset value for the associated PS totalizer when the digital input is set to Batch Reset. To change the preset amount, follow these steps from the <i>Inputs/Outputs</i> menu: <ol style="list-style-type: none"> 1. Select Digital Output 1, 2, 3 or 4 and press [E] to open the <i>Digital Output</i> menu. 2. From the <i>Digital Output</i> menu select Preset Amount, and press [E] to open the <i>Preset Amount</i> display. 3. Enter the preset amount value. Press [E] to save the new parameter and return to the <i>Digital Output</i> menu. <p>NOTE: You can only set one Preset Amount. If you set the Preset Amount for Digital Output 1, it will be the same for 2, 3 and 4.</p>
	Set Point Min. [0%] 	This parameter establishes, as a percentage of full scale flow, the threshold at which the output alarm will be activated. Flow rates below the threshold will activate the output alarm. To change the set point minimum, follow these steps from the <i>Inputs/Outputs</i> menu: <ol style="list-style-type: none"> 1. Select Digital Output 1, 2, 3 or 4 and press [E] to open the <i>Digital Output</i> menu. 2. From the <i>Digital Output</i> menu select Set Point Min., and press [E] to open the <i>Set Point Min.</i> display. 3. Enter the set point minimum value. Press [E] to save the new parameter and return to the <i>Digital Output</i> menu.
	Set Point Max. [100%] 	This parameter establishes, as a percentage of full scale flow, the threshold at which the output alarm will be activated. Flow rates above the threshold will activate the output alarm. To change the maximum set point, follow these steps from the <i>Inputs/Outputs</i> menu: <ol style="list-style-type: none"> 1. Select Digital Output 1, 2, 3 or 4 and press [E] to open the <i>Digital Output</i> menu. 2. From the <i>Digital Output</i> menu select Set Point Max. and press [E] to open the <i>Set Point Max.</i> display. 3. Enter the set point maximum value and press [E] to save the new parameter and return to the <i>Digital Output</i> menu.





Inputs/Outputs		
Digital Output (continued)	<p>Output Type</p> <p>[1: Normally Open] [2: Normally Open] [3: Normally Open] [4: Normally Closed]</p> <p></p>	<p>The Output Type parameter lets you set the output switch to normally open or normally closed. If normally open is selected, the output switch is open (no current) when the output is inactive, and closed (current flows) when the output is active.</p> <p>If normally closed is selected, the output switch is closed (current flows) when the output is inactive, and open (no current) when the output is active.</p> <p>To change the Output Type, follow these steps from the <i>Inputs/Outputs</i> main menu:</p> <ol style="list-style-type: none"> 1. Select Digital Output 1, 2, 3 or 4 and press [E] to open the <i>Digital Output</i> menu. 2. From the <i>Digital Output</i> menu, select Output Type and press [E] to open the <i>Output Type</i> display. 3. Select Normally Open or Normally Closed. 4. Press [E] to save the new parameter and return to the <i>Digital Output</i> menu.
	<p>Hardware Type</p> <p>[3: Open Collector] [4: Open Collector]</p> <p></p>	<p>The Hardware Type parameter lets you select the type of hardware used to drive the output signal: either open collector or solid-state relay.</p> <p>To change the Hardware Type, follow these steps from the <i>Inputs/Outputs</i> main menu:</p> <ol style="list-style-type: none"> 1. Select Digital Output 3 or 4 and press [E] to open the <i>Digital Output</i> menu. 2. From the <i>Digital Output</i> menu select Hardware Type, and press [E] to open the <i>Hardware Type</i> display. 3. Select Open Collector or Relay. 4. Press [E] to save the new parameter and return to the <i>Digital Output</i> menu.

Inputs/Outputs		
Digital Output (continued)	Select Function [1: Forward Pulse] [2: Reverse Pulse] [3: Frequency Pulse] [4: Error Alarm] 	<p>Select Function lets you configure the functional operation of the associated output. The following operations are supported:</p> <ul style="list-style-type: none"> • Frequency Output – Generates pulses correlated to the absolute value of the flow rate. • Forward Pulse – Generates pulses during forward flow conditions. • Reverse Pulse – Generates pulses during reverse flow conditions. • AMR (50 ms Pulse) • Flow Set Point – Provides indication when flow rate exceeds thresholds defined by flow set points. • Empty Pipe Alarm – Provides indication when pipe is empty. • Flow Direction – Provides indication on current flow direction (Inactive = Reverse or No Flow, Active = Forward). • Preset Output – Provides indication when preset batch amount has been realized. • Error Alarm – Provides indication when meter has error condition. Error conditions include, empty pipe error, full scale flow error, and detector error. • Totalizer Alarm – Sends alarm when either a rollover error or warning has occurred. • 24V DC Supply – Provides constant 24 volts on output (forces output type to normally open). • ADE – Provides meter information in digital format. See "<i>Encoder Protocol Interface</i>" on page 47. <p>To change the Function Select, follow these steps from the <i>Inputs/Outputs</i> main menu:</p> <ol style="list-style-type: none"> 1. Select Digital Output 1, 2, 3 or 4 and press [E] to open the <i>Digital Output</i> menu. 2. From the <i>Digital Output</i> menu choose Select Function, and press [E] to open the <i>Select Function</i> display. 3. Select the desired function. 4. Press [E] to save and return to the <i>Digital Output</i> menu.
Flow Simulation [Off] 	<p>Flow Simulation provides output simulation based on a percentage of the full scale flow. Simulation will not accumulate the totalizers. The range of simulation includes –100% to 100% of the full scale flow.</p> <p>The Flow Simulation Parameter lets you set the range of simulation in 10% increments.</p> <p>To change the Flow Simulation, follow these steps from the <i>Inputs/Outputs</i> menu:</p> <ol style="list-style-type: none"> 1. Select Flow Simulation to view the <i>Flow Simulation</i> display. 2. Click [+] to increment the percentage by 10, or click [–] to decrement the percentage by 10. 3. Press [E] to save the displayed setting and return to the <i>Inputs/Outputs</i> menu. 	





Clear Totals	
TN 	The bi-directional net totalizer, when reset, clears both the forward and the reverse flow totalizers (T+ and T-). This is reset within the menu manager or through remote communications. Clearing TN also clears the associated rollover counter.
T+ 	The bi-directional forward flow totalizer is reset within the menu manager or through remote communications. Clearing T+ also clears the associated rollover counter.
T- 	The bi-directional reverse flow totalizer is reset within the menu manager or through remote communications. Clearing T- also clears the associated rollover counter.
PS 	The batch totalizer is reset to the configured preset amount value. It is reset within the menu manager, remote communications or through a properly-configured digital input (function = batch reset).
Tpwroff 	The totalizer accumulating meter time without external power is reset with the menu manager or through remote communications.





Communication		
Port A Settings	Interface [MODBUS RTU] 	<p>The Interface parameter lets you configure how the RS232 communication port will be used.</p> <ul style="list-style-type: none"> • MODBUS RTU • Remote menu (RDI – Remote Display Interface) • Primo 3.x • Flow Diagnostic – After every flow measurement, provides data out of the communication port primarily for diagnosing flow measurement issues. • Disable port <p>The remote menu interface will check for display updates once a second. If a change is detected, the display contents will be transmitted in ASCII format over the RS232 communication port. The remote menu interface also allows for menu navigation and control of the meter as if using the external push-buttons. Keyboard control characters such as <UP>, <DWN>, and <ENTER> are supported to navigate the menus.</p> <p>The Primo 3.x interface will emulate the legacy Primo 3.x Protocol. This protocol will transmit an ASCII string in the following format every 500 ms: “RATE;0.0000; GPM; TOT1;150.0000; USG ; TOT2;150.0000; USG ;” – For Unidirectional Mode “RATE;0.0000; GPM; TOT+;10.0000; USG ; TOT-;50.0000; USG ;” – For Bidirectional Mode</p> <p>To change the Interface follow these steps from the <i>Port A Settings</i> menu:</p> <ol style="list-style-type: none"> 1. Select Interface to view the <i>Interface</i> display. 2. Select the desired interface. 3. Press [E] to save and return to the <i>Port A Settings</i> menu.

Communication		
Port A Settings (continued)	Port Address [1] 	<p>This parameter establishes the MODBUS RTU address. MODBUS RTU requests will only be processed if the configured port address of the meter matches the request address found in the MODBUS RTU packet. The range of addresses supported by MODBUS RTU is 1...247. MODBUS RTU request packets with an address of 0 imply the packet is to be treated as a broadcast packet.</p> <p>To change the port address, follow these steps from the <i>Port A Settings</i> menu:</p> <ol style="list-style-type: none"> 1. Select Port Address to view the <i>Port Address</i> display. 2. Select the desired port address (1...247). 3. Press [E] to save the option and to return to the <i>Port A Settings</i> menu.
	Baud Rate [9600] 	<p>The following Baud Rates are supported</p> <ul style="list-style-type: none"> • 9600 • 19200 • 38400 <p>To change the baud rate, follow these steps from the <i>Port A Settings</i> menu:</p> <ol style="list-style-type: none"> 1. Select Baud Rate to view the <i>Baud Rate</i> display. 2. Select one of the following baud rates: 9600, 19200 or 38400. 3. Press [E] to save the option and to return to the <i>Port A Settings</i> menu.
	Data Bits [8 bits] 	<p>The following data bits are supported:</p> <ul style="list-style-type: none"> • 8 bits • 7 bits • 5 bits <p>To change the data bits, follow these steps from the <i>Port A Settings</i> menu:</p> <ol style="list-style-type: none"> 1. Select Data Bits to view the <i>Data Bits</i> display. 2. Select one of the following: 8 Bits, 7 Bits or 5 Bits. 3. Press [E] to save the option and to return to the <i>Port A Settings</i> menu.
	Parity [Even] 	<p>The following Parities are supported:</p> <ul style="list-style-type: none"> • Even • Odd • None <p>To change the parity, follow these steps from the <i>Port A Settings</i> menu:</p> <ol style="list-style-type: none"> 1. Select Parity to view the <i>Parity</i> display. 2. Select one of the following: None, Even or Odd. 3. Press [E] to save the option and to return to the <i>Port A Settings</i> menu.
	Stop Bits [1 Stop Bit] 	<p>The following stop bits are supported:</p> <ul style="list-style-type: none"> • 1 Stop Bit • 2 Stop Bits <p>To change the stop bits, follow these steps from the <i>Port A Settings</i> menu:</p> <ol style="list-style-type: none"> 1. Select Stop Bits to view the <i>Stop Bits</i> display. 2. Select one of the following: 1 Stop Bit, or 2 Stop Bits. 3. Press [E] to save the option and to return to the <i>Port A Settings</i> menu.

Communication															
Port B Settings	<p>NOTE: The parameters for <i>Port B</i> are the same as for <i>Port A</i>, with the exception of the additional <i>External Port Address</i> detailed below.</p>														
	<p>Port Address [1] </p> <p>An additional communication port, known as <i>Port B</i>, is used to offer enhanced communications with the meter. This port is located on the 11-pin terminal of the PCB. Enhanced protocols like Hart, Profibus DP or Modbus RTU over RS485 are available. In addition, this communication port has similar configurable properties as port A. Refer to the following user manuals for additional information regarding the enhanced communication capabilities of the M2000 meter.</p> <ul style="list-style-type: none"> • HART® communication protocol. • PROFIBUS DP communication protocol. • MODBUS RTU communication protocol. 														
	<p>External Port Address [1] </p> <p>For PROFIBUS® use only. This parameter allows configuration of the PROFIBUS DP daughterboard address.</p>														
Diagnostics	<p>Port A Counters [0] </p> <p>Port counters are used for diagnostics when configured for MODBUS RTU. These counters are only cleared on power up.</p> <table border="1" style="width: 100%; border-collapse: collapse;"> <thead> <tr> <th style="text-align: left;">Counter</th> <th style="text-align: left;">Description</th> </tr> </thead> <tbody> <tr> <td>Pkts Processed</td> <td>Number of packets processed by meter.</td> </tr> <tr> <td>Broadcast Pkts</td> <td>Number of broadcast packets (address = 0) processed by meter.</td> </tr> <tr> <td>CRC Errors</td> <td>Number of received packets with CRC error; packet is discarded.</td> </tr> <tr> <td>Pkts Rcvd</td> <td>Number of packets received with an address of the configured port address.</td> </tr> <tr> <td>Pkts Sent</td> <td>Number of packets transmitted in response to a received packet.</td> </tr> <tr> <td>Parity Errors</td> <td>Number of characters with parity errors (<i>i.e.</i>, received character has a mismatch between the number of 1s and its parity bit); packet is discarded.</td> </tr> </tbody> </table>	Counter	Description	Pkts Processed	Number of packets processed by meter.	Broadcast Pkts	Number of broadcast packets (address = 0) processed by meter.	CRC Errors	Number of received packets with CRC error; packet is discarded.	Pkts Rcvd	Number of packets received with an address of the configured port address.	Pkts Sent	Number of packets transmitted in response to a received packet.	Parity Errors	Number of characters with parity errors (<i>i.e.</i> , received character has a mismatch between the number of 1s and its parity bit); packet is discarded.
	Counter	Description													
	Pkts Processed	Number of packets processed by meter.													
	Broadcast Pkts	Number of broadcast packets (address = 0) processed by meter.													
	CRC Errors	Number of received packets with CRC error; packet is discarded.													
	Pkts Rcvd	Number of packets received with an address of the configured port address.													
	Pkts Sent	Number of packets transmitted in response to a received packet.													
	Parity Errors	Number of characters with parity errors (<i>i.e.</i> , received character has a mismatch between the number of 1s and its parity bit); packet is discarded.													
<p>Port B Counters [0] </p> <table border="1" style="width: 100%; border-collapse: collapse;"> <tbody> <tr> <td>Framing Errors</td> <td>Number of characters with framing errors (<i>i.e.</i> missing stop bit is not found – indicates that synchronization with the start bit has been lost and that the character is improperly framed); packet is discarded.</td> </tr> <tr> <td>Overrun Errors</td> <td>Number of characters received that were not processed due to degradation of system performance.</td> </tr> <tr> <td>Break Detects</td> <td>Number of detections that transmission line is locked (<i>i.e.</i>, receive line is low for 10-bit transmissions following a missing stop bit).</td> </tr> </tbody> </table>	Framing Errors	Number of characters with framing errors (<i>i.e.</i> missing stop bit is not found – indicates that synchronization with the start bit has been lost and that the character is improperly framed); packet is discarded.	Overrun Errors	Number of characters received that were not processed due to degradation of system performance.	Break Detects	Number of detections that transmission line is locked (<i>i.e.</i> , receive line is low for 10-bit transmissions following a missing stop bit).									
Framing Errors	Number of characters with framing errors (<i>i.e.</i> missing stop bit is not found – indicates that synchronization with the start bit has been lost and that the character is improperly framed); packet is discarded.														
Overrun Errors	Number of characters received that were not processed due to degradation of system performance.														
Break Detects	Number of detections that transmission line is locked (<i>i.e.</i> , receive line is low for 10-bit transmissions following a missing stop bit).														

Advanced																																																																																					
Data Logger	<p>The Data Logger feature requires firmware version 1.10 or later. Reference Badger Meter P/N 67354-003 to obtain a firmware upgrade kit. See the <i>M-Series M2000 Data Logging</i> user manual, available at www.badgermeter.com, for details on this feature.</p> <p>The Data Logging feature records three types of events to a memory token:</p> <ul style="list-style-type: none"> • Totalizer/error events • Configuration change events • Startup events (power up, power down or reset events) 																																																																																				
Token Copy	<ul style="list-style-type: none"> • Configuration • Store to Token • Restore to Token <p>See the <i>M-Series M2000 Store/Restore</i> user manual, available at www.badgermeter.com, for details on using the Token Copy features.</p>																																																																																				
Encoder Protocol	<p>Protocol Type</p> <p>The Protocol Type enables the encoder interface. Selecting V1 or V2 will automatically configure the Digital Input and Digital Output #1 for encoder operation. Manually configuring the input and output for encoder operation is not allowed and will result in an on-screen error.</p> <p>See "<i>Encoder Protocol Interface</i>" on page 47 for further details.</p> <p>V1 – Standard encoder protocol V2 – Enhanced encoder protocol, provides additional digital information Disabled – disables and removes encoder configuration</p>																																																																																				
Totalizer Dials	<p>Dial Type</p> <p>Select 4...10 dials</p>																																																																																				
Totalizer Resolution [Off] 	<p>The Totalizer Resolution establishes the number of units of measure that have to accumulate before the display totalizers are updated. This is also known as setting the number of "dead" zeroes in the display totalizer. For example:</p> <table border="1" style="width: 100%; border-collapse: collapse; text-align: center;"> <thead> <tr> <th colspan="6">Totalizer Resolution less than 1</th> </tr> <tr> <th>Totalizer Resolution</th> <th colspan="5">Example</th> </tr> </thead> <tbody> <tr> <td>OFF</td> <td>0.00000 USG</td> <td>0.00012 USG</td> <td>0.00123 USG</td> <td>0.01234 USG</td> <td>0.12345 USG</td> </tr> <tr> <td>0.0001</td> <td>0.0000 USG</td> <td>0.0001 USG</td> <td>0.0012 USG</td> <td>0.0123 USG</td> <td>0.1234 USG</td> </tr> <tr> <td>0.001</td> <td>0.000 USG</td> <td>0.000 USG</td> <td>0.001 USG</td> <td>0.012 USG</td> <td>0.123 USG</td> </tr> <tr> <td>0.01</td> <td>0.00 USG</td> <td>0.00 USG</td> <td>0.00 USG</td> <td>0.01 USG</td> <td>0.12 USG</td> </tr> <tr> <td>0.1</td> <td>0.0 USG</td> <td>0.0 USG</td> <td>0.0 USG</td> <td>0.0 USG</td> <td>0.1 USG</td> </tr> </tbody> </table> <table border="1" style="width: 100%; border-collapse: collapse; text-align: center;"> <thead> <tr> <th colspan="6">Totalizer Resolution greater than or equal to 1</th> </tr> <tr> <th>Totalizer Resolution</th> <th colspan="5">Example</th> </tr> </thead> <tbody> <tr> <td>OFF</td> <td>0.00000 USG</td> <td>1.23456 USG</td> <td>12.34567 USG</td> <td>123.4567 USG</td> <td>1234.567 USG</td> </tr> <tr> <td>1</td> <td>0 USG</td> <td>1 USG</td> <td>12 USG</td> <td>123 USG</td> <td>1234 USG</td> </tr> <tr> <td>10</td> <td>0 USG</td> <td>0 USG</td> <td>10 USG</td> <td>120 USG</td> <td>1230 USG</td> </tr> <tr> <td>100</td> <td>0 USG</td> <td>0 USG</td> <td>0 USG</td> <td>100 USG</td> <td>1200 USG</td> </tr> <tr> <td>1000</td> <td>0 USG</td> <td>0 USG</td> <td>0 USG</td> <td>0 USG</td> <td>1000 USG</td> </tr> </tbody> </table> <p>To change the Totalizer Resolution, follow these steps from the <i>Advanced</i> menu:</p> <ol style="list-style-type: none"> 1. Select Totalizer Resolution to view the <i>Totalizer Resolution</i> display. 2. Select the desired resolution. 3. Press [E] to save the option and to return to the <i>Advanced</i> menu. 	Totalizer Resolution less than 1						Totalizer Resolution	Example					OFF	0.00000 USG	0.00012 USG	0.00123 USG	0.01234 USG	0.12345 USG	0.0001	0.0000 USG	0.0001 USG	0.0012 USG	0.0123 USG	0.1234 USG	0.001	0.000 USG	0.000 USG	0.001 USG	0.012 USG	0.123 USG	0.01	0.00 USG	0.00 USG	0.00 USG	0.01 USG	0.12 USG	0.1	0.0 USG	0.0 USG	0.0 USG	0.0 USG	0.1 USG	Totalizer Resolution greater than or equal to 1						Totalizer Resolution	Example					OFF	0.00000 USG	1.23456 USG	12.34567 USG	123.4567 USG	1234.567 USG	1	0 USG	1 USG	12 USG	123 USG	1234 USG	10	0 USG	0 USG	10 USG	120 USG	1230 USG	100	0 USG	0 USG	0 USG	100 USG	1200 USG	1000	0 USG	0 USG	0 USG	0 USG	1000 USG
Totalizer Resolution less than 1																																																																																					
Totalizer Resolution	Example																																																																																				
OFF	0.00000 USG	0.00012 USG	0.00123 USG	0.01234 USG	0.12345 USG																																																																																
0.0001	0.0000 USG	0.0001 USG	0.0012 USG	0.0123 USG	0.1234 USG																																																																																
0.001	0.000 USG	0.000 USG	0.001 USG	0.012 USG	0.123 USG																																																																																
0.01	0.00 USG	0.00 USG	0.00 USG	0.01 USG	0.12 USG																																																																																
0.1	0.0 USG	0.0 USG	0.0 USG	0.0 USG	0.1 USG																																																																																
Totalizer Resolution greater than or equal to 1																																																																																					
Totalizer Resolution	Example																																																																																				
OFF	0.00000 USG	1.23456 USG	12.34567 USG	123.4567 USG	1234.567 USG																																																																																
1	0 USG	1 USG	12 USG	123 USG	1234 USG																																																																																
10	0 USG	0 USG	10 USG	120 USG	1230 USG																																																																																
100	0 USG	0 USG	0 USG	100 USG	1200 USG																																																																																
1000	0 USG	0 USG	0 USG	0 USG	1000 USG																																																																																

Advanced		
Backlight Control [Timed Off] 	<p>You can set the meter's backlight to: Always On, Always Off and Timed Off.</p> <p>When set to Timed Off, the backlight will automatically turn off after one minute of inactivity (no buttons pressed). Pressing any button will turn the backlight on, but will not immediately navigate the menu.</p> <p>To change the backlight control, follow these steps from the <i>Advanced</i> menu:</p> <ol style="list-style-type: none"> 1. Select Backlight Control to view the <i>Backlight Control</i> display. 2. Select the desired option. 3. Press [E] to save the option and to return to the <i>Advanced</i> menu. 	
Analog Calibrate [Zero Scale: 0 mA] [Full Scale: 0 mA] 	Custom Settings [Zero Scale: 0 mA] [Full Scale: 0 mA] 	<p>To set the analog calibration custom settings, follow these steps from the <i>Advanced</i> menu:</p> <ol style="list-style-type: none"> 1. Select Analog Calibrate to view the <i>Analog Calibrate</i> menu. 2. Select Custom Settings to view the <i>Custom Settings</i> display. 3. Select one of the following: <ul style="list-style-type: none"> • Offset 4 mA • Offset 20 mA 4. Configure desired offset. 5. Press [E] to save the option and to return to the <i>Custom Settings</i> menu. 6. Press [E] to return to the <i>Analog Calibrate</i> menu.
	Factory Settings [Factory Set] 	<p>To change the analog calibration factory settings, follow these steps from the <i>Advanced</i> menu:</p> <ol style="list-style-type: none"> 1. Select Analog Calibrate to view the <i>Analog Calibrate</i> menu. 2. Select Factory Settings to view the <i>Factory Settings</i> display. 3. Select one of the following: <ul style="list-style-type: none"> • Calibration Point A • Calibration Point B 4. Set the calibration point to the measured output current. 5. Press [E] to save the option and to return to the <i>Factory Settings</i> menu. 6. Press [E] to return to the <i>Analog Calibrate</i> menu.
Software Filter MDN-Filter	Description	<p>This software filter operates as a Median filter. This filter is very responsive and can be used to help stabilize flow measurements. This filter is enabled by selecting a non-zero filter size. Supported filter sizes are:</p> <ul style="list-style-type: none"> • S0 - Size 0 • S5 - Size 5 • S7 - Size 7 • S9 - Size 9 <p>The filter technique will use the median value of the last Sx samples used for determining flow measurement.</p>

Advanced		
Software Filter ACC-Filter	Description	The software filter operates as an acceleration filter. This filter, when configured properly, allows for filtering of fast changes in fluid flow. Generally, this filter is used in applications having highly conductive fluids. This filter is intended to help provide smoothing of the analog output and display fluctuations.
	Activation [Off] 	The Activation parameter setting enables or disables the software acceleration filter. To change the Activation setting, follow these steps from the <i>Advanced</i> menu: <ol style="list-style-type: none">1. Select Activation from the <i>Advanced</i> menu.2. Select a setting.3. Press [E] to save the option and to return to the <i>Advanced</i> menu.
	Filter Delay [1] 	The Filter Delay parameter lets you set the amount of time that the flow will be held constant once the filter is activated. The filter is activated by an acceleration component of the fluid exceeding the configured limit. To change the Filter Delay follow these steps from the <i>Advanced</i> menu: <ol style="list-style-type: none">1. Select Filter Delay, from the <i>Advanced</i> menu.2. Enter the setting.3. Press [E] to save the option and to return to the <i>Advanced</i> menu.
	Acceleration Factor [1] 	The Acceleration Factor parameter lets you set the maximum acceleration for a given pipe diameter and is dependent on the excitation frequency. The maximum fluid velocity is 12 m/s. The following equation defines the maximum fluid acceleration: $\text{Acceleration(MAX)} = \text{Acceleration Factor} * 12 \text{ m/s} * \text{Pipe Area} * \text{Excitation Frequency} / 1.5$ If the realized fluid acceleration exceeds the configured maximum acceleration, fluid flow will be held constant for the time set at the Filter Delay parameter. To change the Acceleration Factor setting, follow these steps from the <i>Advanced</i> menu: <ol style="list-style-type: none">1. Select Acceleration Factor from the <i>Advanced</i> menu.2. Enter the setting.3. Press [E] to save the option and to return to the <i>Advanced</i> menu.
	Constant Flow [150 M ³ /Sec ²] 	During normal flow conditions, there is always a non-zero acceleration component. For example, if acceleration of the flow activates the filter, the meter will assume constant flow for the duration of the filter delay time unless the flow returns within limits. Properly configured, this parameter will help offset excessive impacts of the filter delay. The Constant Flow parameter lets you set the acceleration limit for constant flow. To change the Constant Flow setting, follow these steps from the <i>Advanced</i> menu: <ol style="list-style-type: none">1. Select Constant Flow from the <i>Advanced</i> menu.2. Enter the setting.3. Press [E] to save the option and to return to the <i>Advanced</i> menu.

Advanced		
Software Filter ACC-Filter (continued)	Peak Detect [0 M ³ /Sec ²] 	<p>Peak Detect offers a diagnostic view of the acceleration components observed during flow conditions. This parameter records the “high water mark” of the measured accelerations component. This value will help to properly configure the Acceleration Factor parameter. Generally, you will set the acceleration factor at about 75% of the Peak Detect measurement.</p> <p>To reset the Peak Detect setting, follow these steps from the <i>Advanced</i> menu:</p> <ol style="list-style-type: none"> 1. Select Peak Detect from the <i>Advanced</i> menu. 2. Press [+] to reset. 3. Press [E] to return to the <i>Advanced</i> menu.
Software Filter ZFS-Filter	Description	<p>This software filter operates as a zero-flow stability filter. Filter options are:</p> <ul style="list-style-type: none"> • Volume USG • Time • Status (shows Volume and Time)
Software Filter IIR-Filter	Description	This software filter operates as an infinite impulse response filter, used to help suppress erratic flow measurements. Contact Badger Meter Technical Support.
	Activation	ON/OFF
	Coefficient Min	Numeric entry
	Coefficient Max	Numeric entry
	Coefficient Status	Numeric entry
	Sensitivity	Numeric entry
	Hysteresis	m/s

Advanced**Empty Pipe Cal.**

[Default]



Fluid conductivity impacts the performance of empty pipe measurements. If you require empty pipe detection, you should perform this empty pipe calibration procedure.

Before starting the empty pipe calibration, verify that empty pipe detection is enabled. Also, run both the empty pipe and the full pipe calibration procedures.

Calibrating an Empty Pipe

Before calibrating an empty pipe, verify that the pipe is empty.

To calibrate with an empty pipe, follow these steps from the *Advanced* menu:

1. Select **Empty Pipe Cal** to view the *Calibration* menus.
2. Select **Cal. Empty Pipe** to view the *Empty Pipe Calibrate* menu.
3. To enable calibration, place the cursor on the calibration enable line and press **[E]**.

```
EMPTY PIPE CALIBRATE
Volts = 3.00
>Cal [ON]      E=OFF
Exit with Save
```

4. Wait 30 seconds for voltage measurement to stabilize.
5. To save the setting, place the cursor on **Exit with Save** and press **[E]**.

Calibrating a Full Pipe



Before calibrating a full pipe, verify that the pipe is full.





To calibrate with a full pipe, follow these steps from the *Advanced* menu:

1. Select **Empty Pipe Cal** to view the *Calibration* menus.
2. Select **Cal. Full Pipe** to view the *Full Pipe Calibrate* menu.
3. Enable calibration by placing the cursor on the calibration enable line and press **[E]**.

```
FULL PIPE CALIBRATE
Volts = 1.515
>Cal [OFF]     E=ON
Exit with Save
```

4. Wait 30 seconds for voltage measurement to stabilize.
5. To save the setting, place the cursor on **Exit with Save** and press **[E]**.

Advanced		
Security	Set Admin PIN [00000] 	Users logged in with this PIN will have access to all M2000 meter procedures. To set the administrator's PIN, follow these steps from the <i>Advanced</i> Menu: <ol style="list-style-type: none"> 1. Select Security to view the <i>Security</i> menu. 2. Select Set Admin PIN to view the <i>Admin PIN</i> display. 3. Set the five-digit PIN number to the desired value. 4. Press [E] to save the PIN and to return to the <i>Security</i> menu.
	Set Service PIN [00000] 	Users logged in with this PIN will have access to all service level and user-level procedures. Service users will not have access to administrative procedures. To set the service PIN, follow these steps from the <i>Advanced</i> Menu: <ol style="list-style-type: none"> 1. Select Security to view the <i>Security</i> menu. 2. Select Set Service PIN to view the <i>Service PIN</i> display. 3. Set the five-digit PIN number to the desired value. 4. Press [E] to save the PIN and to return to the <i>Security</i> menu.
	Set User PIN [00000] 	Users logged in with this PIN will have access to user-level procedures. User at this level will not have access to administrative or service procedures. To set the user's PIN, follow these steps from the <i>Advanced</i> Menu: <ol style="list-style-type: none"> 1. Select Security to view the <i>Security</i> menu. 2. Select Set User PIN to view the <i>User PIN</i> display. 3. Set the five-digit PIN number to the desired value. 4. Press [E] to save the PIN and to return to the <i>Security</i> menu.

Info/Help		
Error Counts [0] 	Description	This menu provides a diagnostic view of the meter's performance. Below are several system diagnostic counters and their definitions. Use discretion when interpreting these counters. These values could be altered during system setup or when using the verification device. We suggest that you reset these counters before you start monitoring your system and look for conditions possibly affecting performance.
	Detector	The number of times an invalid detector condition has been observed.
	Empty Pipe	The number of times an empty pipe condition has been observed by the meter.
	Full Scale	The number of times the flow has exceeded the full scale flow setting.
	Totalizer	The number of times the totalizers have exceeded limits of the meter.
	Pulse Sync.	The number of times the pulse outputs have fallen out of synchronization.
	ADC Interrupt	The number of times an analog input measurement has been missed.
	ADC Range	The number of times the analog input measurement range has been exceeded.
	System Error	A diagnostic system message indicating the reason for a system reset.
	System Resets	The number of times the meter has been reset.
	System Reset ID	Diagnostic information about a system reset as a result of expired internal timers.
Token Errors	Indicates the number of parameter copies from a memory token that failed to be copied to the meter.	
Checksum	For MID meters. If a data corruption to the meter memory occurs, this "counter" indicates the memory region that is corrupted.	
PowerUp Counter [Not applicable] 	The number of times that the unit has been powered on.	
Power Off Totalizer [Not applicable] 	The length of time that the unit has been without power.	
Version Info [Not applicable] 	The current software version.	
Serial Number [Not applicable] 	The manufacturing serial number in the format YYMM####. Where YYMM indicates year and month of manufacturing and #### indicates the sequence number.	
Meter Tag Name	For PROFIBUS – This parameter is only programmable over external PROFIBUS communications.	
Daughterboard Information	Describes current version of attached daughterboard. NOTE: RS485 daughterboard is not recognized because it is a pass-through device rather than an intelligent protocol converter like Hart-to-MODBUS.	
Polarization Voltage	Diagnostic voltage to help determine if the meter or application is performing optimally.	

Info/Help	
Restore Defaults [Not applicable] 	Restores all non-calibrated parameters to the factory defaults.

Language Select	
Language Select [English] 	The M2000 meter supports one alternate language along with English. This alternate language choice is set at the factory. The options are: Spanish, German, Czech or French. To select the language, follow these steps from the Language Select menu : <ol style="list-style-type: none">1. Select English or the Alternate Language.2. Press [E] to save the selection.

ENCODER PROTOCOL INTERFACE

This feature requires firmware version 1.10 or later. Reference Badger Meter P/N 67354-003 to obtain a firmware upgrade kit. Enabling the meter as an encoder requires three settings, all within the advanced menu, to be configured.

- Totalizer Resolution – Selects the resolution of the display totalizer.
- Protocol Type – Selects the type of information to be transmitted to the encoder.
- Dial Type – Enables encoder and selects the number of significant totalizer digits to transmit.

Changing the protocol type will automatically configure the necessary digital inputs/outputs. Manually changing the digital inputs/outputs within the *Input/Outputs* menu is not allowed. Below is a wiring diagram for connecting an encoder to the meter.

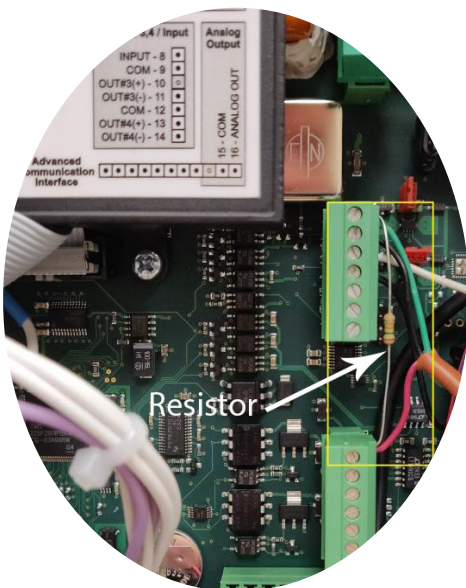

Encoder Connections

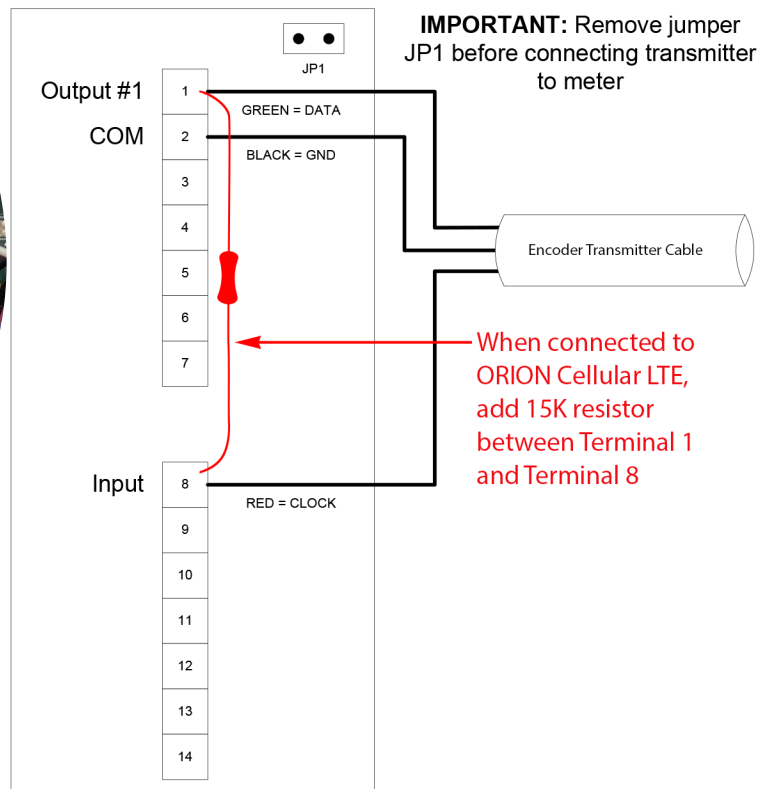

Figure 34: Encoder interface

NOTE: When connected to an ORION Cellular LTE endpoint, add a 15K resistor to the M2000 meter terminal block between terminal 1 (green wire) and terminal 8 (red wire) as shown to correct any potential meter reading issues. The resistor is indicated by an arrow in the photo and shown in red in the drawing. Resistors, manufactured by Yageo, P/N MFR-25FBF52-15K, are available at these online electronic component distributors: digkey.com and mouser.com.

The following table demonstrates how the totalizers are displayed under various configurations of the Totalizer Resolution (that is, resolution) and Dial Type. The non-shaded digits are transmitted as defined by the dial type.

For example, if the dial type is 4-dial and the resolution is 10000 then an arbitrary totalizer value of 99999999 is displayed on the meter as 99990000 and 9999 is transmitted to the receiving application. In this configuration it will take 10000 units (i.e. USG) before the display totalizer is updated to a new value. For this example the display totalizer will rollover to 00000000.

Dial Type	Totalizer Resolution	Display Digits											
		1	2	3	4	5	6	7	8	9	0		
4 dial	10000			1	2	3	4	0	0	0	0		
	1000				1	2	3	4	0	0	0		
	100					1	2	3	4	0	0		
	10						1	2	3	4	0		
	1							1	2	3	4		
	0.1							1	2	3	.	4	
	0.01							1	2	.	3	4	
	0.001							1	.	2	3	4	
0.0001					0	0	1	2	3	4			
5 dial	10000		1	2	3	4	5	0	0	0	0		
	1000			1	2	3	4	5	0	0	0		
	100				1	2	3	4	5	0	0		
	10					1	2	3	4	5	0		
	1						1	2	3	4	5		
	0.1						1	2	3	4	.	5	
	0.01						1	2	3	.	4	5	
	0.001						1	2	.	3	4	5	
0.0001						1	.	2	3	4	5		
6 dial	10000	1	2	3	4	5	6	0	0	0	0		
	1000		1	2	3	4	5	6	0	0	0		
	100			1	2	3	4	5	6	0	0		
	10				1	2	3	4	5	6	0		
	1					1	2	3	4	5	6		
	0.1						1	2	3	4	.	6	
	0.01						1	2	3	4	.	5	6
	0.001						1	2	3	.	4	5	6
0.0001						1	2	.	3	4	5	6	
7 dial	10000	Not Applicable – Not enough display digits											
	1000	1	2	3	4	5	6	7	0	0	0		
	100		1	2	3	4	5	6	7	0	0		
	10			1	2	3	4	5	6	7	0		
	1				1	2	3	4	5	6	7		
	0.1				1	2	3	4	5	6	.	7	
	0.01				1	2	3	4	5	.	6	7	
	0.001				1	2	3	4	.	5	6	7	
0.0001				1	2	3	.	4	5	6	7		
8 dial	10000	Not Applicable – Not enough display digits											
	1000	Not Applicable – Not enough display digits											
	100	1	2	3	4	5	6	7	8	0	0		
	10		1	2	3	4	5	6	7	8	0		
	1			1	2	3	4	5	6	7	8		
	0.1			1	2	3	4	5	6	7	.	8	
	0.01			1	2	3	4	5	6	.	7	8	
	0.001			1	2	3	4	5	.	6	7	8	
0.0001			1	2	3	4	.	5	6	7	8		

Dial Type	Totalizer Resolution	Display Digits									
		1	2	3	4	5	6	7	8	9	0
9 dial	10000	Not Applicable– Not enough display digits									
	1000	Not Applicable– Not enough display digits									
	100	Not Applicable– Not enough display digits									
	10	1	2	3	4	5	6	7	8	9	0
	1		1	2	3	4	5	6	7	8	9
	0.1	1	2	3	4	5	6	7	8	.	9
	0.01	1	2	3	4	5	6	7	.	8	9
	0.001	1	2	3	4	5	6	.	7	8	9
0.0001	1	2	3	4	5	.	6	7	8	9	
10 dial*	10000	Not Applicable– Not enough display digits									
	1000	Not Applicable– Not enough display digits									
	100	Not Applicable– Not enough display digits									
	10	Not Applicable– Not enough display digits									
	1	1	2	3	4	5	6	7	8	9	0
	0.1	1	2	3	4	5	6	7	8	9	.0
	0.01	1	2	3	4	5	6	7	8	.9	0
	0.001	1	2	3	4	5	6	7	.8	9	0
	0.0001	1	2	3	4	5	6	.7	8	9	0

*10 dial reading is not supported by the encoder protocol. When the meter is configured, the display settings for number of dials and resolution are based on what the encoder protocol can support. For example, if the encoder output is enabled (V1 or V2) and you try to select 10 dials, the display will show an error dialog since this is an invalid configuration for the encoder. If the encoder output is not enabled, a selection of up to 10 digits is available.

It is important to understand that the totalizers are represented in a manner equivalent to an actual encoder. For example, 1 USG on a 4 dial will be transmitted/displayed as “0001”. If in bidirectional mode, –1 USG will be transmitted/displayed as “9999”.

The protocol type has two options:

- V1 – meter provides single totalizer, Tn (bi-directional) or T1 (uni-directional)
- V2 – meter provides extended information (For ORION Cellular, ORION Fixed Network (SE) or ORION Migratable (ME))

The additional information provided by protocol type V2 is only accessible for specific models of the encoder (i.e. ORION SE or ORION ME). The additional information of protocol type V2 includes, status information of the meter, meter identification, a second totalizer reading (T+ or T2), relative flow rate (0...100%), and flow direction.

STORE / RESTORE FEATURE

The Store/Restore feature is intended to save installation costs and reduce installation time. This feature is also intended to protect meter configuration and assure the operator that the meter is properly configured. Over time and handling of the meter, the meter configuration could change. The Store/Restore feature allows the meter to be quickly set to the operator's original configuration. Refer to the *M2000 Store/Restore* user manual for details on this feature.

DATA LOGGING FEATURE

The Data Logging feature records three types of events to a memory token:

- Totalizer/error events
- Configuration change events
- Startup events (power up, power down or reset events)

Each type of event is recorded into three separate files stored on the memory token. These files are extracted using the provided flow meter tool software over the RS232 communication link. Refer to the *M2000 Data Logging* user manual for details on this feature.

MAINTENANCE

Mandatory, routine or scheduled maintenance should not be required for the M2000 meter electronics or flow tube after proper installation.

However, some instances may require personnel to perform the following:

- Flow tube and electrode cleaning
- Fuse replacement
- Circuit board replacement

⚠ WARNING

- **DISCONNECT MAIN POWER TO THE UNIT BEFORE ATTEMPTING ANY DEVICE MAINTENANCE OR CLEANING.**
- **DO NOT CLEAN COMPONENTS INSIDE THE AMPLIFIER OR JUNCTION BOX.**

Cleaning the Flow Tube and Electrode

At times flow tube, electrodes, amplifier/junction box housings and the amplifier window may need periodic cleaning, depending on process fluid properties, fluid flow rate and surrounding environment.

Clean the flow tube and electrodes by following the material handling and cleaning procedures documented in Material Safety Data Sheet (MSDS) guidelines for the product(s) that were in contact with the flow tube and electrodes.

Should flow tube and/or electrode cleaning become necessary:

1. Disconnect detector from pipeline.
2. Clean electrodes according to MSDS guidelines.
3. Reconnect detector to pipeline.

Replacing the Fuse

⚠ WARNING

DISCONNECT MAIN POWER TO THE UNIT BEFORE ATTEMPTING ANY DEVICE MAINTENANCE. RISK OF ELECTRICAL SHOCK. REPLACE THE FUSE ONLY WITH 250V AC, 2 AMP, SLOW BLOW (5 X 20 MM). AUTHORIZED PERSONNEL MUST REPLACE FUSES.

Replacing the Circuit Board

Refer to the *M-Series M2000 Interchangeability Procedure Application Brief* for information on replacing circuit boards.

TROUBLESHOOTING

The M2000 meter is designed for many years of optimal performance. However, should it malfunction, there are certain things that we recommend you check before contacting our Technical Support department or your local Badger Meter Representative.

NOTE: If the fluid measured has a high concentration of conductive solids, deposits may accumulate on the internal liner walls and electrodes. These deposits will cause a reduction of the measuring output. Thus, Badger Meter recommends that you remove the meter and inspect the liner and electrodes after six months. If deposits are found, remove them with a soft brush. Repeat inspection process every six months or until an appropriate inspection cycle can be established for the specific application.

NOTE: Other general conditions include:

Description	Possible Cause	Recommended Action
Rollover warning	A rollover warning occurs when the display totalizer can no longer represent the current value within the totalizer. A rollover warning is dependent on the number of dials, resolution and the unit of measure.	To clear rollover error, do one of the following: <ul style="list-style-type: none"> • Increase number of dials • Reduce resolution or • Clear totalizers
Flow is present but display is "0"	Digital input is holding flow. Disconnected signal cable. Detector mounted opposite of the main flow direction (see arrow on the nameplate). Coil or electrode cables exchanged. Improper low flow cutoff or full scale flow.	Check signal cable. Turn detector by 180° or switch terminal E1 and E2 or reprogram to bidirectional mode. Check cable connections for cross wiring. Verify digital input configuration. Replace configuration defaults.
Inaccurate measuring	Improper calibration. Wrong calibration parameter. Pipe not fully filled, or air in pipe. Invalid fluid conductivity. Invalid fluid mixture.	Restore calibration defaults. Check the parameters (detector factor and size) according to supplied data sheet. Check if meter is completely filled with fluid. Purge line to eliminate air bubbles.
No display	No power. Incorrect power. Bad wiring connections. Blown fuse.	Apply power. Check power value. Replace fuse (2 amp, 250V AC, slow blow 5 x 20 mm). Check display ribbon cable.
Flow rate value known to be wrong	Detector factor. Deposits on electrodes and/or liner. Incorrect pipe size programmed.	Check value on label. Check and remove deposits. Check size if necessary.
Flow rate indication unstable	Cable issue. Grounding issue. Partially full pipe. Air in pipe. Amplifier location – outside electrical. Invalid fluid conductivity.	Make sure cable is shielded and not vibrating. Make sure meter is properly grounded to a good earth ground. Make sure pipe is full of fluid. Make sure fluid does not contain air bubbles. Make sure amplifier is not too close to sources of electrical interference.
BEACON displays multiple estimated flow occurrences for meters connected to ORION Cellular LTE endpoints.	ORION Cellular LTE endpoints require additional resistance.	Add a 15K resistor to the M2000 meter terminal block. See "Encoder Protocol Interface" on page 47 for complete details.

Menu Manager Configuration Errors		
Error	Description	Recommended Action
100	ADE: Configuration of the ADE interface is invalid.	<p>This error is displayed when an invalid modification to either of the following menu parameters is detected: Protocol Type, Dial Type, Totalizer Resolution, Digital Input Function Type or Digital Output Function Type.</p> <ol style="list-style-type: none"> 1. Configuring the M2000 meter as an ADE interface has the following limitations, Protocol Type V1 is only allowed if number of dials is less than 8. 2. The resolution of the totalizers (i.e. Totalizer Resolution) must be set to something other than OFF. 3. For 8 dial configuration, a resolution of 10000 and 1000 are not supported. There are not enough display digits to accommodate 8 dials and greater than 100 units of resolution. 4. For 7 dial configuration, a resolution of 10000 is not supported. There are not enough display digits to accommodate 7 dials and greater than 1000 units of resolution.
101	ADE: Enabling/Disabling ADE operation is invalid	<p>This error is observed when Digital input or output function is manually selected for ADE operation. Enabling or Disabling ADE operation can only be accomplished by setting the ADE protocol type.</p>
110	Output 1/2: Pulse Output Configuration Error	<p>This error is observed when improperly configuring either the full scale flow, pulse per unit, pulse width or digital output function type for pulse output operation. Preparing these parameters for pulse output operation (i.e. forward or reverse) has limitations that are monitored by the menu manager. This error can indicate the following configuration violations:</p> <ol style="list-style-type: none"> 1. Pulse Frequency exceeds limits at full scale flow 2. Pulse duty cycle is less than 50% at full scale flow (i.e. pulse on time > pulse off time) 3. AMR Pulse Frequency exceeds limit at full scale flow <p>The pulse frequency limit is 10 kHz when the pulse width is 0 (i.e. 50% duty cycle). The pulse frequency limit is $1 / (2 * \text{Pulse Width})$ when the pulse width is non-zero in order to achieve a 50% duty cycle. For AMR operation, the frequency limit is 3 HZ.</p> <p>Follow these steps for configuring meter for pulse output operation:</p> <ol style="list-style-type: none"> 1. Set PPU to zero for both output 1 and 2 2. If necessary, set full scale flow appropriately for application 3. Set PW as required by equipment receiving pulse transmissions from meter. Observe frequency limits for non-zero pulse widths. 4. Determine the desired pulse frequency at a typical flow rate (i.e. 1000 HZ @ 250 GPM) 5. Calculate ratio of typical flow rate to full scale flow: ratio = typical flow rate / full scale flow (i.e. 250 GPM / 500 GPM = 0.5) 6. Calculate flow rate conversion factor: For GPM, conversion factor = 1/60, for GPH, conversion factor = 1/3600, for GPS, conversion factor = 1 7. Calculate PPU: $\text{PPU} = (\text{Desired pulse frequency at typical flow rate} / \text{ratio}) / [\text{Full Scale Flow} * (\text{conversion factor})]$ = $(1000 / 0.5) / [500 * (1/60)]$ = 240 Pulse / Gallon 8. If an error is received consider reducing value of full scale flow and ensuring desired pulse frequency is within limits. Then redo steps 4-7 <p>If not using the pulse outputs, set the pulses per unit to zero to allow for re-configuration of the full scale flow. If it is required to use the pulse outputs, re-evaluate the pulse output configuration. Consider recording and clearing totalizers following pulse output configuration"</p>
120	Display: Totalizer Conversion Error – Totalizer cannot be properly converted for display	<p>This error is observed while trying to change the totalizer units. Limits of display will prevent improper configuration of the volume unit dependent on current totalizer values. Consider recording and cleaning totalizers prior to changing totalizer.</p>
121	Output 1/2: Pulse Output Configuration Error	<p>This error is observed when changing the totalizer units of measure. This error implies the pulse configuration exceeds limits (see error 110). Please note the pulses per unit is not automatically updated on volume unit re-configuration. The pulses per unit should be manually changed to accommodate the desired units of measure. It may be necessary to set the pulses per unit to zero then change to the desired totalizer units.</p>
140	Output 3: Configuration Error – Full scale frequency exceeds limits of relay (1000 Hz)	<p>Reduce full scale frequency setting of output when hardware is configured for relay operation.</p>
150	Output 3: Configuration Error – Full scale frequency exceeds limits (10 kHz)	<p>Reduce full scale frequency setting of output when hardware is configured for open collector operation.</p>
170	Output 1/2: Output Type Configuration Error	<p>This error is observed when the function type is 24V DC and the output type is changed from Normally Open to Normally Closed. It is required for 24V DC output operation that the output type be Normally Open.</p>

Menu Manager Configuration Errors		
Error	Description	Recommended Action
171	Output 1/2: Output Type Configuration Error	This error is observed when the function type is ADE and the output type is changed from Normally Open to Normally Closed. It is required for ADE operation that the output type be Normally Open.
190	Full Scale Flow: Entered Value exceeds limits	Value entered exceeds the absolute maximum flow the meter supports. Reduce the value for this parameter or consider increasing pipe diameter.

Display Error / Status Messages		
Error Message	Possible Cause	Recommended Action
Err: Detector	No detector connection with amplifier.	Check detector and cable connections in accordance with this manual.
	Connection between amplifier and detector	Contact Technical Support.
	Supply voltage too low.	Contact Technical Support.
	Grounded coils in meter.	Contact Technical Support.
	Water in detector.	Contact Technical Support.
Err: Empty pipe	Pipe may not be full.	Make sure all trapped air is out of system. If fluid or fluid conductivity recalibrate the parameter.
Err: Full scale	Actual flow rate is exceeding programmed flow.	Reduce flow rate or increase the programmed full scale value by more than 5%.
Err: AD-Range	AD-Converter is exceeding signal limits.	Check the grounding scheme of the meter installation. See grounding section in this manual. Verify pipe is not empty.
Err: AD-INT	Initialization of AD-Converter unsuccessful.	Contact Technical Support.
Err: Rollover	Rollover counters have exceeded limit.	Clear all totalizers.
Err: Rollover Status	Totalizer rollover has occurred.	Reload totalizer then clear all totalizers.
Err: Simulation	I/O simulator is enabled.	Disable simulator in I/O menu.

SPECIFICATIONS

Flow Range	0.10...39.4 ft/s (0.03...12 m/s)						
Accuracy	± 0.20% of rate ± 1 mm/s						
Repeatability	± 0.1%						
Power Supply	AC Power Supply: 85...265V AC; Typical Power: 20V A or 15W; Maximum Power: 26V A or 20W Optional DC Power Supply: 10...36V DC; Typical Power: 10W; Maximum Power: 14W						
Analog Output	4...20 mA, 0...20 mA, 0...10 mA, 2...10 mA (programmable and scalable) Voltage sourced 24V DC isolated. Maximum loop resistance < 800 ohms.						
Digital Output	Four total, configurable 24V DC sourcing active output (up to 2), 100 mA total, 50 mA each; sinking open collector output (up to four), 30V DC max, 100 mA each; AC solid-state relay (up to 2), 48V AC, 500 mA max						
Digital Input	Max 30V DC (programmable – positive zero return, external totalizer reset or preset batch start)						
Frequency Output	Scalable up to 10 kHz, open collector up to 1 kHz, solid-state relay						
Misc Output	High/low flow alarm (0...100% of flow), error alarm, empty pipe alarm, flow direction, preset batch alarm, 24V DC supply, ADE						
Communication	RS232 Modbus RTU; RS485 Modbus RTU, HART, Profibus DP require separate daughterboards						
Pulse Width	Scalable up to 10 kHz, passive open collector up to 10 kHz, active switched 24V DC. Up to two outputs (forward and reverse). Pulse width programmable from 1...1000 ms or 50% duty cycle.						
Processing	32-bit DSP						
Empty Pipe Detection	Field tunable for optimum performance based on specific application						
Excitation Frequency	1 Hz, 3.75 Hz, 7.5 Hz or 15 Hz (factory optimized to pipe diameter)						
Noise Dampening	Programmable 0...30 seconds						
Low Flow Cut-Off	Programmable 0...10% of maximum flow						
Galvanic Separation	250V						
Fluid Conductivity	Minimum 5.0 µS/cm (minimum 20 µS/cm for demineralized water)						
Fluid Temperature	With Remote Amplifier: PFA, PTFE & Halar 302° F (150° C) With Meter-Mounted Amplifier: Rubber 178° F, (80° C), PFA, PTFE & Halar 212° F (100° C)						
Ambient Temperature	- 4...140° F (-20...60° C)						
Relative Humidity	Up to 90 percent non-condensing						
Flow Direction	Unidirectional or bidirectional two separate totalizers (programmable)						
Totalization	Programmable/resettable						
Units of Measure	Ounce, pound, liter, US gallon, imperial gallon, barrel, hectoliter, mega gallon, cubic meter, cubic feet, acre feet						
Display	4 x 20 character display with backlight						
Programming	Three-button, external manual or remote						
Amplifier Housing	Cast aluminum, powder-coated paint						
Detector Housing	Standard: Carbon steel welded; Optional: 316 or 304 stainless steel						
Pipe Spool Material	316 stainless steel						
Flanges	Standard: ANSI B16.5 Class 150 RF forged carbon steel; Optional: 300 lb forged carbon steel, 316 or 304 stainless steel						
Pressure Rating	Line sizes up through 24 in: In accordance with ASME B16.5 Class 150 or Flange Rating Class 300 Line sizes greater than 24 in. and through 72 in: AWWA C-207 Class D or Class E Flange Rating						
Liner Material	PFA up to 3/8 in., PTFE 1/2...24 in., soft and hard rubber from 1...54 in., Halar® from 14...40 in.						
Electrode Materials	Standard: Hastelloy C22; Optional: 316 stainless steel, gold/platinum plated, tantalum, platinum/rhodium						
Mounting	Meter mount or remote wall mount (bracket supplied)						
Locations	Indoor and outdoor						
Meter Enclosure Classification	Standard: NEMA 4X (IP66); Optional: Submersible NEMA 6P (IP67), remote amplifier required						
Junction Box Enclosure Protection	For remote amplifier option: powder-coated die-cast aluminum, NEMA 4 (IP66)						
Cable Entries	1/2 in. NPT cord grip (3)						
Optional Stainless Steel Grounding Rings	<table border="0"> <thead> <tr> <th>Meter Size</th> <th>Thickness (of one ring)</th> </tr> </thead> <tbody> <tr> <td>Up through 10 in.</td> <td>0.135 in.</td> </tr> <tr> <td>12...78 in.</td> <td>0.187 in.</td> </tr> </tbody> </table>	Meter Size	Thickness (of one ring)	Up through 10 in.	0.135 in.	12...78 in.	0.187 in.
Meter Size	Thickness (of one ring)						
Up through 10 in.	0.135 in.						
12...78 in.	0.187 in.						
NSF Listed	Models with hard rubber liner, 4 in. size and larger; PTFE liner, all sizes						
Token Features	Data Logging (Blue token); Store/Restore (Red token); Firmware Upgrade (Black token)						

INTENTIONAL BLANK PAGE

Control. Manage. Optimize.

M-Series is registered trademark of Badger Meter, Inc. Other trademarks appearing in this document are the property of their respective entities. Due to continuous research, product improvements and enhancements, Badger Meter reserves the right to change product or system specifications without notice, except to the extent an outstanding contractual obligation exists. © 2019 Badger Meter, Inc. All rights reserved.

www.badgermeter.com

The Americas | Badger Meter | 4545 West Brown Deer Rd | PO Box 245036 | Milwaukee, WI 53224-9536 | 800-876-3837 | 414-355-0400
México | Badger Meter de las Americas, S.A. de C.V. | Pedro Luis Ogazón N°32 | Esq. Angelina N°24 | Colonia Guadalupe Inn | CP 01050 | México, DF | México | +52-55-5662-0882
Europe, Eastern Europe Branch Office (for Poland, Latvia, Lithuania, Estonia, Ukraine, Belarus) | Badger Meter Europe | ul. Korfantego 6 | 44-193 Knurów | Poland | +48-32-236-8787
Europe, Middle East and Africa | Badger Meter Europa GmbH | Nurtlinger Str 76 | 72639 Neuffen | Germany | +49-7025-9208-0
Europe, Middle East Branch Office | Badger Meter Europe | PO Box 341442 | Dubai Silicon Oasis, Head Quarter Building, Wing C, Office #C209 | Dubai / UAE | +971-4-371 2503
Slovakia | Badger Meter Slovakia s.r.o. | Racianska 109/B | 831 02 Bratislava, Slovakia | +421-2-44 63 83 01
Asia Pacific | Badger Meter | 80 Marine Parade Rd | 19-07 Parkway Parade | Singapore 449269 | +65-63464836
Switzerland | Badger Meter Swiss AG | Mittelholzerstrasse 8 | 3006 Bern | Switzerland | +41-31-932 01 11