

DS-2DE2A404IW-DE3(S6)
4 MP 4× IR PTZ Network Camera

Hikvision DS-2DE2A404IW-DE3(S6) 4 MP 4× IR PTZ Network Camera can be widely used in indoor scenes, such as corridor, office, factory, convenience store, and restaurant.

- High quality imaging with 4 MP resolution
- Excellent low-light performance via powered-by-DarkFighter technology
- Clear imaging against strong back lighting due to 120 dB WDR technology
- Pan and tilt ability enables camera to monitor zones of interest
- 4x optical zoom allows for closer viewing of subjects in expansive areas
- Up to 20m IR range ensures safety at night
- Water and dust resistant (IP66) and vandal proof (IK10)

▪ Specification

Camera	
Image Sensor	1/2.8" Progressive Scan CMOS
Max. Resolution	2560 × 1440
Min. Illumination	Color: 0.005 Lux @ (F1.5, AGC ON), B/W: 0.001 Lux @ (F1.5, AGC ON), 0 Lux with IR
Shutter Speed	1/1 s to 1/30,000 s
Day & Night	IR cut filter
Zoom	4x optical, 16x digital
Slow Shutter	Yes
Lens	
Focal Length	2.8 to 12 mm
FOV	Horizontal FOV 96.796° to 31.68°, vertical FOV 51.16° to 17.798°, diagonal FOV 115.13° to 36.32°
Focus	Auto, semi-auto, manual
Aperture	Max. F1.5
Zoom Speed	Approx. 2 s
Illuminator	
Supplement Light Type	IR
Supplement Light Range	IR Distance: up to 20 m
Smart Supplement Light	Yes
IR Wavelength	850 nm
PTZ	
Movement Range (Pan)	0° to 355°
Movement Range (Tilt)	0° to 90°
Pan Speed	Pan speed: configurable from 0.1° to 100°/s; preset speed: 100°/s
Tilt Speed	Tilt speed: configurable from 0.1° to 100°/s, preset speed 100°/s
Proportional Pan	Yes
Presets	300
Preset Freezing	Yes
Park Action	Preset
3D Positioning	Yes
PTZ Status Display	Yes
Scheduled Task	Preset, dome reboot, dome adjust
Power-off Memory	Yes
Video	
Main Stream	50 Hz: 25 fps (2560 × 1440, 1920 × 1080, 1280 × 960, 1280 × 720); 60 Hz: 30 fps (2560 × 1440, 1920 × 1080, 1280 × 960, 1280 × 720)
Sub-Stream	50 Hz: 25 fps (704 × 576, 640 × 480, 352 × 288); 60 Hz: 30 fps (704 × 480, 640 × 480, 352 × 240)
Third Stream	50 Hz: 25 fps (704 × 576, 640 × 480, 352 × 288); 60 Hz: 30 fps (704 × 480, 640 × 480, 352 × 240)
Video Compression	Main stream: H.265+/H.265/H.264+/H.264 Sub-stream: H.265/H.264/MJPEG Third stream: H.265/H.264/MJPEG
H.264 Type	Baseline Profile/Main Profile/High Profile
H.265 Type	Main profile

Scalable Video Coding (SVC)	H.264 and H.265 encoding
Region of Interest (ROI)	8 fixed regions for each stream
Audio	
Audio Compression	G.711alaw/G.711ulaw/G.722.1/G.726/MP2L2/PCM/AAC
Audio Bit Rate	64Kbps(G.711)/16Kbps(G.722.1)/16Kbps(G.726)/32-192Kbps(MP2L2)/32Kbps(PCM)/16-64Kbps(AAC)
Audio Sampling Rate	AAC: 16 kHz, 32 kHz, 48 kHz; MP2L2: 16 kHz, 32 kHz, 48 kHz; PCM: 8 kHz, 16 kHz, 32 kHz, 64 kHz
Environment Noise Filtering	Yes
Network	
Protocols	IPv4/IPv6, HTTP, HTTPS, 802.1x, Qos, FTP, SMTP, UPnP, SNMP, DNS, DDNS, NTP, RTSP, RTCP, RTP, TCP/IP, UDP, IGMP, ICMP, DHCP, PPPoE, Bonjour
Simultaneous Live View	Up to 20 channels
API	Open Network Video Interface (Version 18.12, Profile S, Profile G, Profile T), ISAPI, SDK, ISUP
User/Host	Up to 32 users; 3 user levels: administrator, operator, and user
Security	Password protection, complicated password, HTTPS encryption, 802.1X authentication (EAP-TLS, EAP-LEAP, EAP-MD5), watermark, IP address filter, basic and digest authentication for HTTP/HTTPS, control timeout settings, security audit log, TLS 1.2, host authentication (MAC address)
Network Storage	NAS (NFS, SMB/CIFS), auto network replenishment (ANR)
Client	iVMS-4200, HikCentral Pro, Hik-Connect
Web Browser	IE 10-11, Chrome 57+, Firefox 52+, Safari 11+
Image	
Image Parameters Switch	Yes
Image Settings	Saturation, brightness, contrast, sharpness, gain, and white balance adjustable by client software or web browser
Day/Night Switch	Day, Night, Auto, Schedule
Wide Dynamic Range (WDR)	120 dB
SNR	> 52dB
Defog	Digital Defog
Image Enhancement	BLC, HLC, 3D DNR
Privacy Mask	24 programmable polygon privacy masks, mask color or mosaic configurable
Regional Focus	Yes
Regional Exposure	Yes
Interface	
Ethernet Interface	1 RJ45 10M/100M self-adaptive Ethernet port
On-board Storage	Built-in memory card slot, support microSD/SDHC/SDXC card, up to 256 GB
Built-in Microphone	1 built-in microphone, picking up sounds in the radius up to 5 meters
Audio	1 input (line in), max. input amplitude: 2-2.4 vpp, input impedance: 1 K Ω \pm 10%; 1 output (line out), line level, output impedance: 600 Ω
Reset	Yes
Power Output	12 VDC, max. 60 mA
Event	
Basic Event	Motion detection, video tampering alarm, exception

Smart Event	Face detection, line crossing detection, intrusion detection, region entrance detection, region exiting detection, unattended baggage detection, object removal detection, audio exception detection
Linkage	Upload to FTP/NAS/memory card, notify surveillance center, send email, trigger recording, and PTZ actions (such as preset)
General	
Power	12 VDC, Max. 9.2 W; PoE (802.3af)
Dimension	∅ 130.7 mm ×101.7 mm (∅ 5.15" × 4.00")
Weight	Approx. 530 g (1.17 lb.)
Operating Condition	-20 °C to 60 °C (-4 °F to 140 °F). Humidity 90% or less (non-condensing)
General Function	Mirror, password protection
Approval	
Protection	IP66 (IEC 60529-2013), IK10, TVS 4000V lightning protection, surge protection and voltage transient protection

▪ DORI

The DORI (detect, observe, recognize, identify) distance gives the general idea of the camera ability to distinguish persons or objects within its field of view.

It is calculated based on the camera sensor specification and the criteria given by EN 62676-4:2015.

DORI	Detect	Observe	Recognize	Identify
Definition	25 px/m	63 px/m	125 px/m	250 px/m
Distance (Tele)	180 m (590.6 ft)	71.4 m (234.3 ft)	36 m (118.1 ft)	18 m (59.1 ft)

▪ Available Model





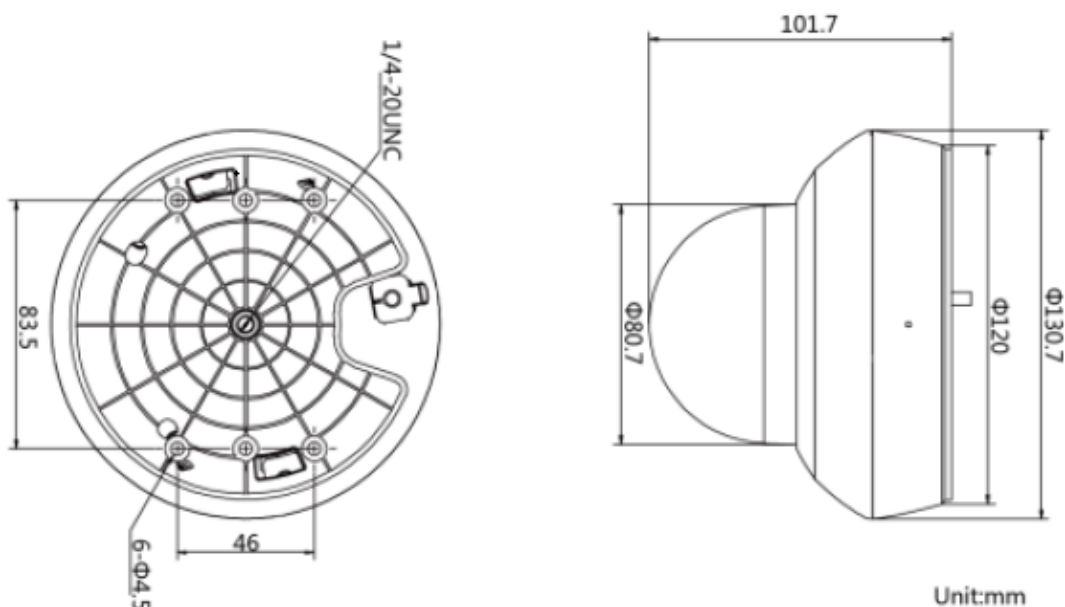



DS-2DE2A404IW-DE3(C0)(S6)(C)

▪ Dimension

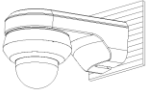

▪ Accessory

▪ Optional

DS-1294ZJ-PT Wall mount	DS-1299ZJ Pendant Mount	DS-1297ZJ Pendant Mount	DS-1297ZJ-ES Pendant Mount	DS-1297ZJ-M Pendant Mount
				
				

See Far, Go Further



www.hikvision.com
support@hikvision.com

