



Technical Specification



SwipBox[®] Infinity – range overview

SwipBox Infinity
IN180-14

SwipBox Infinity
IN180-16

SwipBox Infinity
IN180-20

SwipBox Infinity
IN180-22

SwipBox Infinity
IN180-32

SwipBox® Infinity range

Measurements (same for all models)

Infinity parcel locker - indoor

Outer dimensions

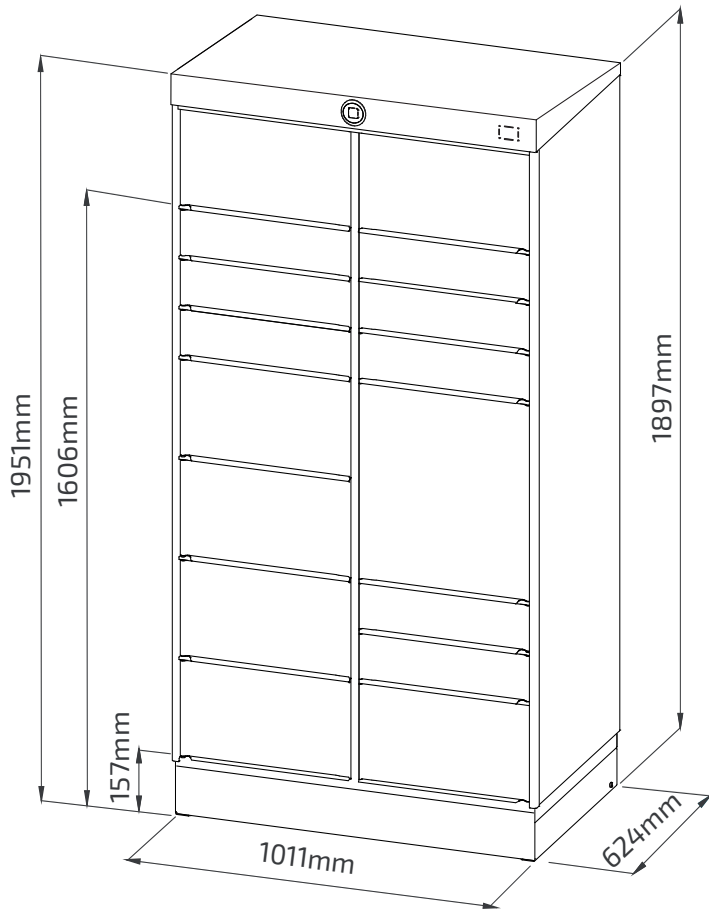

Infinity parcel locker - outdoor

Outer dimensions

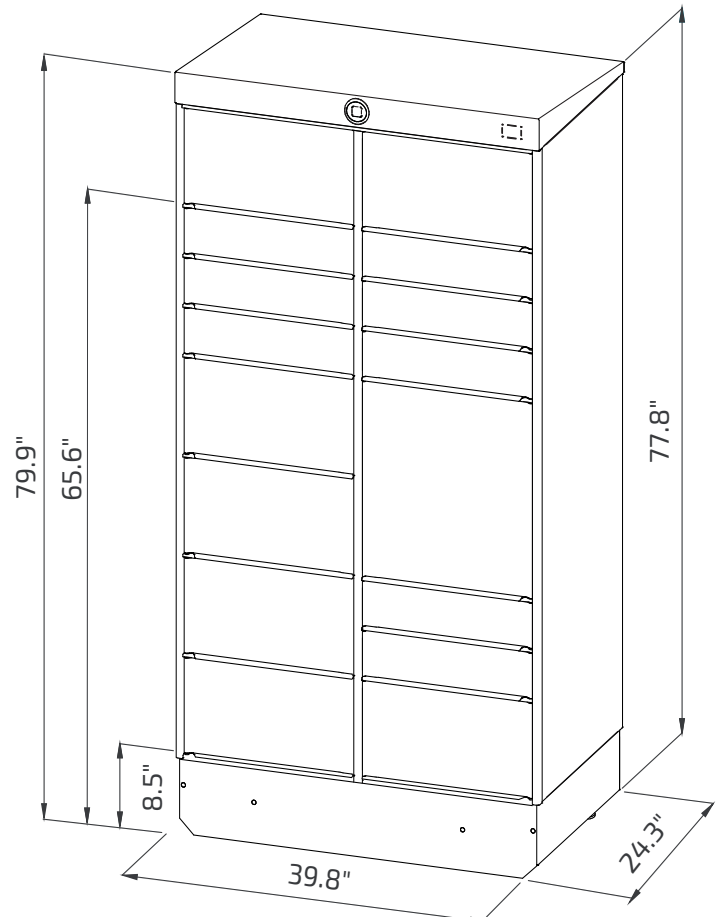

IN180 - 14 Outdoor
14 compartments

IN180 - 16 Outdoor
16 compartments

IN180 - 20 Outdoor
20 compartments

IN180 - 22 Outdoor
22 compartments

IN180 - 32 Outdoor
32 compartments

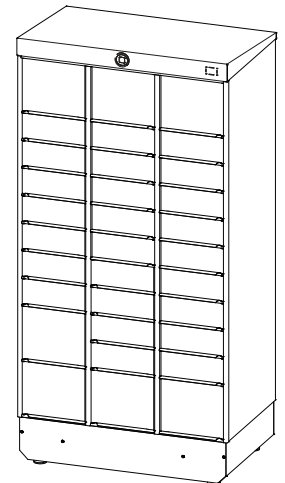
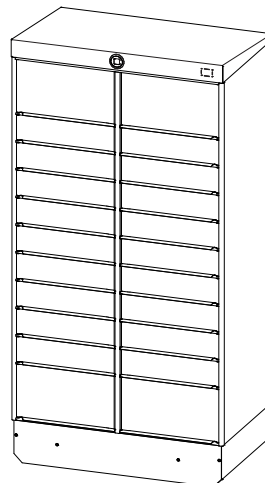
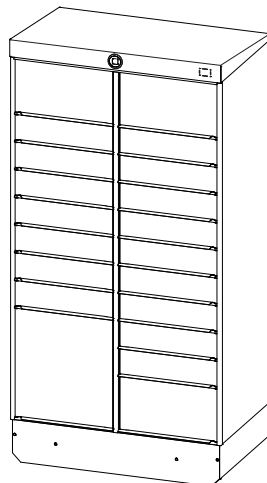
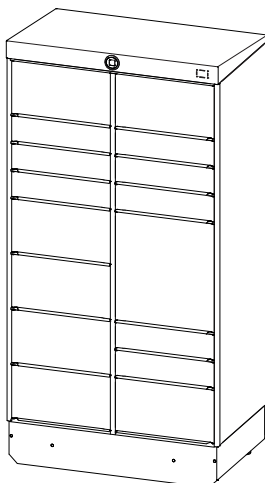
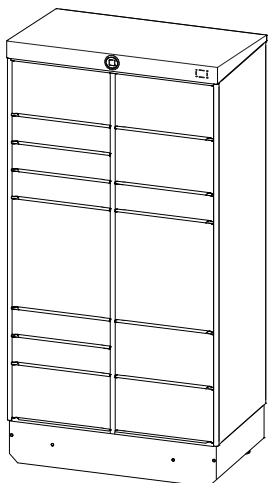

Infinity models and compartments sizes*

	Small (HxWxD) 110x440x590mm	Medium (HxWxD) 240x440x590mm	Large (HxWxD) 500x440x590mm
14 compartments	6	6	2
16 compartments	8	7	1
20 compartments	16	3	1
22 compartments	18	4	-

	Small slim (HxWxD) 110x270x590mm	Medium slim (HxWxD) 240x270x590mm
32 compartments**	25	7

*There should always be at least 1cm free space on either side of the parcel

**NOTE REGARDING CENTRE COMPARTMENTS: The top six open from the left, the bottom five open from the right

Infinity models and weight

	Indoor (kg)	Outdoor (kg)
14 + 16 compartments	130	300
20 + 22 compartments	160	330
32 compartments	196	366

Data

	SwipBox Infinity
Power input	Battery operated. Min. lifespan of 10 years
Bluetooth® communication range	3m from the parcel locker
Storage/transport temp.	-20°C to +50°C
Operating temp.	-20°C to +50°C
Operating humidity max.	95% (non-condensing)
Max. weight on shelf	32kg
Paint	Powder coating
Material	Aluminium



SwipBox International A/S
Ellegaardvej 7
DK-6400 Sønderborg

international@swipbox.com
www.swipbox.com