

marko™ **heating**



Electric Fireplace Heater

Model No.: MHT-FPKNB

(YH-20-2)

This product is only suitable for well-insulated spaces or occasional use.

Read these instructions thoroughly before use and keep for future reference.

User Manual

Electric Fireplace Heaters

Model	Voltage	Frequency	Power
MHT-FPKNB	220-240V~	50Hz	1800-2000W

Features of the product:

This is an emulational flame electric fireplace. The theory of the product is to use a fan to flow the hot air heated by the heating elements in order to achieve the effect of indoor heating.

Scope of delivery

Immediately after unpacking please check that the delivery is complete and all product parts are in good condition.

- 1 Electric heater
- 1 User manual
- 4 Legs
- 12 Screws

Security Advice





1. The product cannot be used outdoors.
2. Any item covered or blocked the fireplace vent in any way is prohibited , or the fireplace will be dangerous caused by overheating.
3. Furniture, curtains or flammable materials should ensure that 1 meter away from the fireplace.
4. Cut off the power immediately if there is something wrong.
5. Please turn off the power if it is not used in a long time.
6. Please do not put the power cord on the front of the fireplace.
7. Although the machine has reached safety standards, we do not recommend that it is used on multi-use carpet or carpet Long Hair.
8. Dispose of the package carefully. Plastic packaging material may cause environmental pollution.
9. The product must be connected to the ground.
10. The fireplace must be used under the AC voltage rating.
11.  **WARNING:** In order to avoid overheating, do not cover the heater
12. The heater must not be located immediately below a socketoutlet.
13. Do not use this heater in the immediate surroundings of a bath, a shower or a swimming pool.
14. This appliance can be used by children aged from 8 years and above and persons with reduced physical, sensory or mental capabilities or lack of experience and knowledge if they have been given supervision or instruction concerning use of the appliance in a safe way and understand the hazards involved. Children shall not play with the appliance. Cleaning and user maintenance shall not be made by children without supervision.
15. In order to avoid a hazard due to inadvertent resetting of the thermal cutout, this appliance must not be supplied

through an external switching device, such as a timer, or connected to a circuit that is regularly switched on and off by the utility.

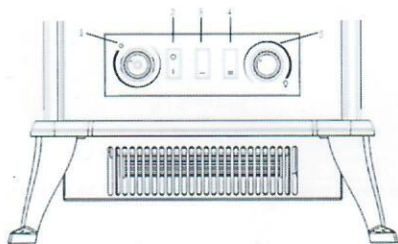
16. If the supply cord is damaged, it must be replaced the manufacture or its service agent or a similarly qualified person must place it in order to avoid a hazard.
17. **WARNING:** This heater is not equipped with a device to control the room temperature. Do not use this heater in small rooms when they are occupied by persons not capable of leaving the room on their own, unless constant supervision is provided.
18. Children of less than 3 years should be kept away unless continuously supervised. Children aged from 3 years and less than 8 years shall only switch on/off the appliance provided that it has been placed or installed in its intended normal position and they have been given supervision or instruction concerning use of the appliance in safe way and understand the hazards involved. Children aged from 3 years and less than 8 years shall not plug in, regulate and clean the appliance or perform user maintenance.
19. **CAUTION** – Some parts of this product can become very hot and cause burns. Particular attention has to be given where children and vulnerable people are present.

Location of Controls



1. Thermostat control knob (**TEMPERATURE SETTING**)- Adjust to maintain room temperature
2. Flame switch - Switches flame effect and power on/off
3. Heating setting: please press “  ” for 1000W
4. Heating setting : please press “  ” and “  ” at the same time for 2000W (can not operate without first press “  ”)
5. Flame dimmer control - Adjust to set flame intensity

Assembly Instructions

Lay stove upside down on a padded surface with the underside accessible. Attach leg to stove by inserting the tab on the top of the leg into the corresponding slot on the bottom of the stove. Insert screws into predrilled holes and tighten securely. Repeat with remaining three legs.

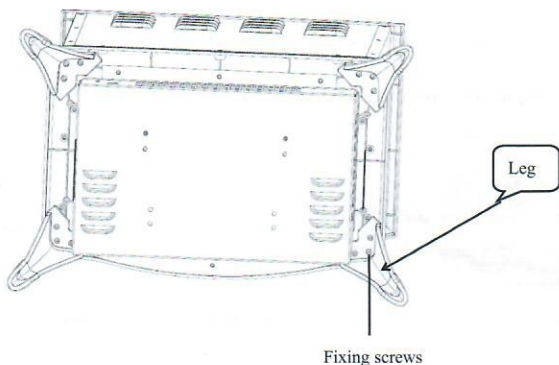

Automatic Cut-off

A cut-off switch is fitted to the heating element to prevent damage due to overheating. If it cuts-off due to an obstruction in the airflow, the heater must be allowed to cool for 5 minutes and the obstruction must be removed before restarting.

Operating your heater

Once the stove has been properly assembled and connected to a electrical outlet, it is ready to operate:

Open control panel door, by the knob of front of stove.

1. Thermostat control knob:

To adjust the temperature to your individual requirements, turn the thermostat dial (#1) to the right (clockwise) to increase the desired temperature, or to the left (counter-clockwise) to decrease desired temperature. This thermostat control dial can one or both of the (# 3 & 4) switches are in the "on" position.

2. I Heat Switch

For low heat function - Press I switch while the FAN and (# 2) switches are in the "on" position for low heat.

3. II Heat Switch

For high heat function - Press II switch while the switch (#3) is in the "on" position for high heat.

4. Flame Effect:

Press Flame effect switch (#2) to the "on" position for flame effect. This function can be used without heat .

5. Flame Dimmer Control:

Turn the dimmer dial (#5) clockwise or counter-clockwise to get the desired flame intensity. The dimmer switch can only be used when the **Flame effect** switch is in the "on" position.

NOTE:

Heat functions will **NOT** operate unless the fan switch (#3) is in the "on" position.

Overheating safe device

If the heater stops working, turn the heater off and inspect the blockage of inlet or outlet. **Disconnect the plug and wait at least 10 minutes** for the protection system to reset before attempting to restart the heater. If the safe device still

switches the heater off and makes the heater fail to operate, take the heater to your nearest service center for examination or repair.

Attention: before restarting the heater, **the plug must be disconnected for at least 10 minutes**

Cleaning

1. Always disconnect the appliance from the main supply before cleaning.
2. Clean the outside of the heater by wiping with a damp or dry cloth.
3. Do not use petroleum, any other detergent or chemical solvent to clean the heater.
4. When the heater is not used for a long time, it should be protected from dust and stored in a clean dry place.

Disposal



Environmental Protection

Waste electrical production should not be disposed of with household waste. Please recycle where facilities exist. Check with your Local Authority or retailer for recycling advice.

Product Fiche:

Model identifier(s):					
Item	Symbol	Value	Unit	Item	Unit
Heat output			Type of heat input, for electric storage local space heaters only (select one)		
Nominal heat output	P _{nom}	1,8-2,0	kW	manual heat charge control, with integrated thermostat	[NO]
Minimum heat output (indicative)	P _{min}	N/A	kW	manual heat charge control with room and/or outdoor temperature feedback	[NO]
Maximum continuous heat output	P _{max,c}	N/A	kW	electronic heat charge control with room and/or outdoor temperature feedback	[NO]
Auxiliary electricity consumption			Fan assisted heat output		
At nominal heat output	el _{max}	N/A	kW	Type of heat output/room temperature control (select one)	
At minimum heat output	el _{min}	N/A	kW	single stage heat output and no room temperature control	[NO]
In standby mode	el _{sb}	N/A	kW	Two or more manual stages, no room temperature control	[NO]
				with mechanic thermostat room temperature control	[YES]
				with electronic room temperature control	[NO]
				electronic room temperature control plus day timer	[NO]
				electronic room temperature control plus week timer	[NO]
			Other control options (multiple selections possible)		
				room temperature control, with presence detection	[NO]
				room temperature control, with open window detection	[NO]
				with distance control option	[NO]
				with adaptive start control	[NO]
				with working time limitation	[NO]
				with black bulb sensor	[NO]