



NUEVO / NUPB33-XX

SPECIFICATION

- Universal T-Box rough-in
- Pressure balanced valve 21L/min [5.5 gpm] @60psi
- Diverter valve 3 functions (shared zones)
- Service check/stop valves
- 1/2" NPT female connections
- Limited lifetime warranty

PRODUCTS No.

NUPB33-XX	Complete valve (Rough & trims)
R-30	Universal T-Box rough in
F-NUPB33-XX	Trim

FINISHES AVAILABLE

- Refer to the catalog for available finishes

CERTIFICATION

- ASME 112.18.1 / CSA B125.1



For more information about the product or before proceeding to any installation please consult the guide.
Products covered by a limited lifetime warranty against all manufacturing defects.

SPÉCIFICATION

- Brut T-Box universel
- Valve pression équilibrée 21L/min [5.5 gpm] @60psi
- Valve déviatrice 3 fonctions (zones partagées)
- Connexions femelles 1/2po NPT
- Valves de service
- Garantie à vie limitée

No. PRODUITS

NUPB33-XX	Valve complète (Brut & Garnitures)
R-30	Brut de valve universel
F-NUPB33-XX	Garnitures

FINIS DISPONIBLE

Se référer au catalogue pour les finis disponible

CERTIFICATION

- ASME 112.18.1 / CSA B125.1



Pour plus d'information sur le produit ou avant de procéder à toute installation veuillez consulter le guide.
Produits couverts par une garantie à vie limitée contre tout défaut de fabrication.

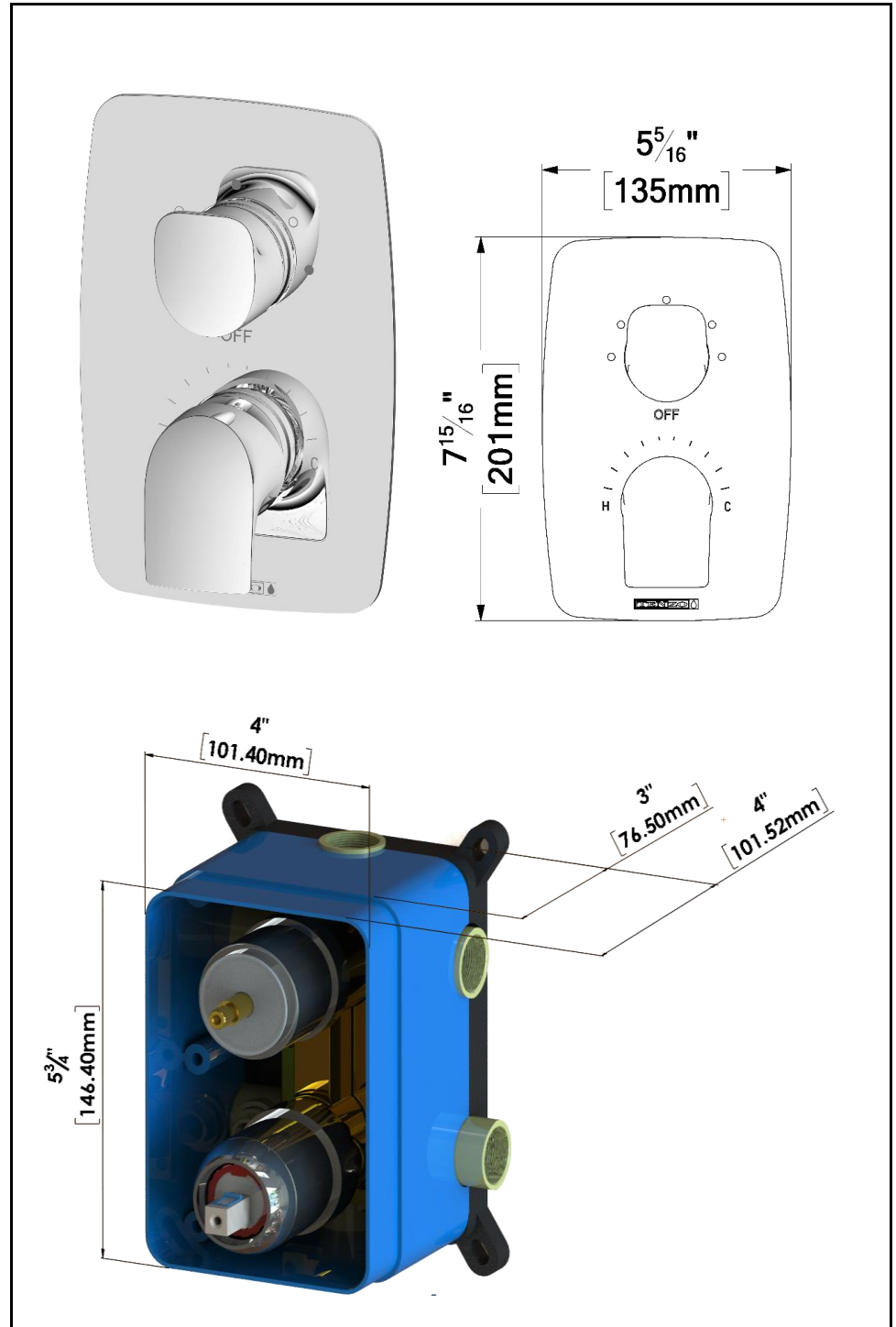

The product may vary slightly from its dimension and appearance.
Les dimensions et l'aspect du produit peuvent varier légèrement de l'illustration



CSH-12-S-XX

SPECIFICATION

- Recessed stainless steel shower head
- EasyClips installation system
- Dimensions: 30cm x 30cm [12x12in]
- Thickness: 2mm
- 121 Anti-limestone silicone nozzle
- Inlet 1/2in female
- Flow rate: 7.6 L/min [2.0 gpm] @60psi
- Limited lifetime warranty

FINISHES AVAILABLE

- Refer to the catalog for available finishes

CERTIFICATION

- ASME 112.118.1 / CSA B125.1



For more information about the product or before proceeding to any installation please consult the guide.
 Products covered by a limited lifetime warranty against all manufacturing defects.

SPÉCIFICATION

- Tête de douche en acier inoxydable encastrée
- Installation rapide EasyClips
- Dimensions: 30cm x 30cm [12x12po]
- Épaisseur: 2mm
- 121 buses en silicone anti-calcaire
- Débit: 7.6 L/min [2.0 gpm] @60psi
- Garantie à vie limitée

FINIS DISPONIBLE

Se référer au catalogue pour les finis disponible

CERTIFICATION

- ASME 112.118.1 / CSA B125.1



Pour plus d'information sur le produit ou avant de procéder à toute installation veuillez consulter le guide.
 Produits couverts par une garantie à vie limitée contre tout défaut de fabrication.

Installation *EasyClips*

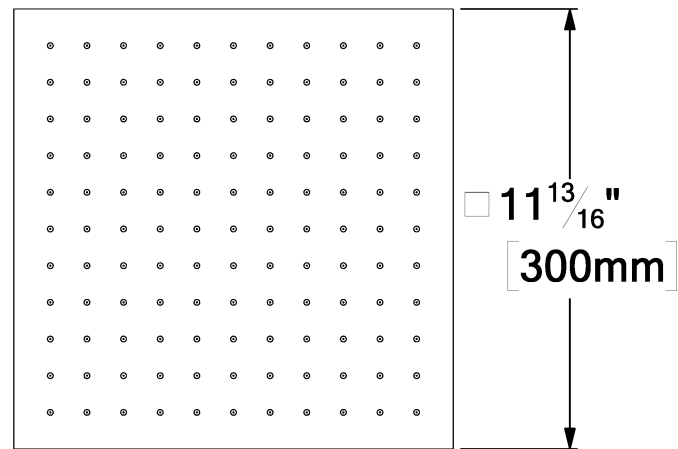
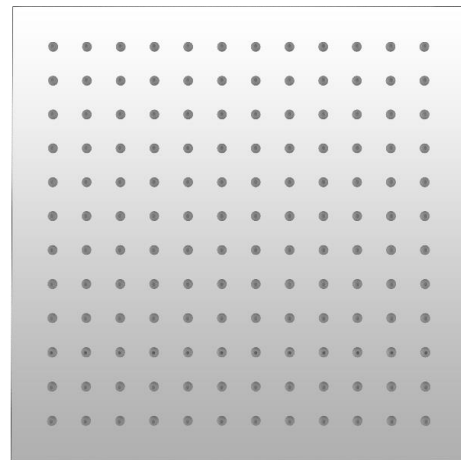
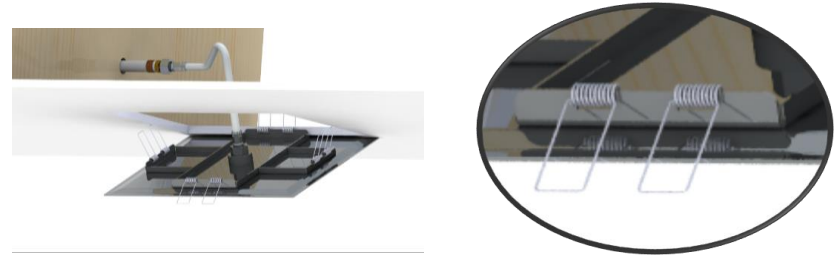

The product may vary slightly from its dimension and appearance.
 Les dimensions et l'aspect du produit peuvent varier légèrement de l'illustration



KRD-3218-XX / KRD-32187-XX

SPECIFICATION

- Sliding bar kit
- Elbow (option)
- Limited lifetime warranty

KRD-3218-XX	* KRD-32187-XX	Description
RD-32-XX	RD-32-XX	Sliding Bar
HS-218-XX	HS-218-XX	Hand shower
SSHE-150-XX	SSHE-150-XX	Hose
N/A	HC-307-XX	Elbow (Option)

FINISHES AVAILABLE

- Refer to the catalog for available finishes

CERTIFICATION

- ASME 112.118.1 / CSA B125.1



For more information about the product or before proceeding to any installation please consult the guide.
 Products covered by a limited lifetime warranty against all manufacturing defects.

SPÉCIFICATION

- Ensemble de rail de douche
- Coude en option
- Garantie à vie limitée

KRD-3218-XX	* KRD-32187-XX	Description
RD-32-XX	RD-32-XX	Rail de douche
HS-218-XX	HS-218-XX	Douchette
SSHE-150-XX	SSHE-150-XX	Boyau
N/A	HC-307-XX	Coude (Option)

FINIS DISPONIBLE

- Se référer au catalogue pour les finis disponible

CERTIFICATION

- ASME 112.118.1 / CSA B125.1



Pour plus d'information sur le produit ou avant de procéder à toute installation veuillez consulter le guide.
 Produits couverts par une garantie à vie limitée contre tout défaut de fabrication.

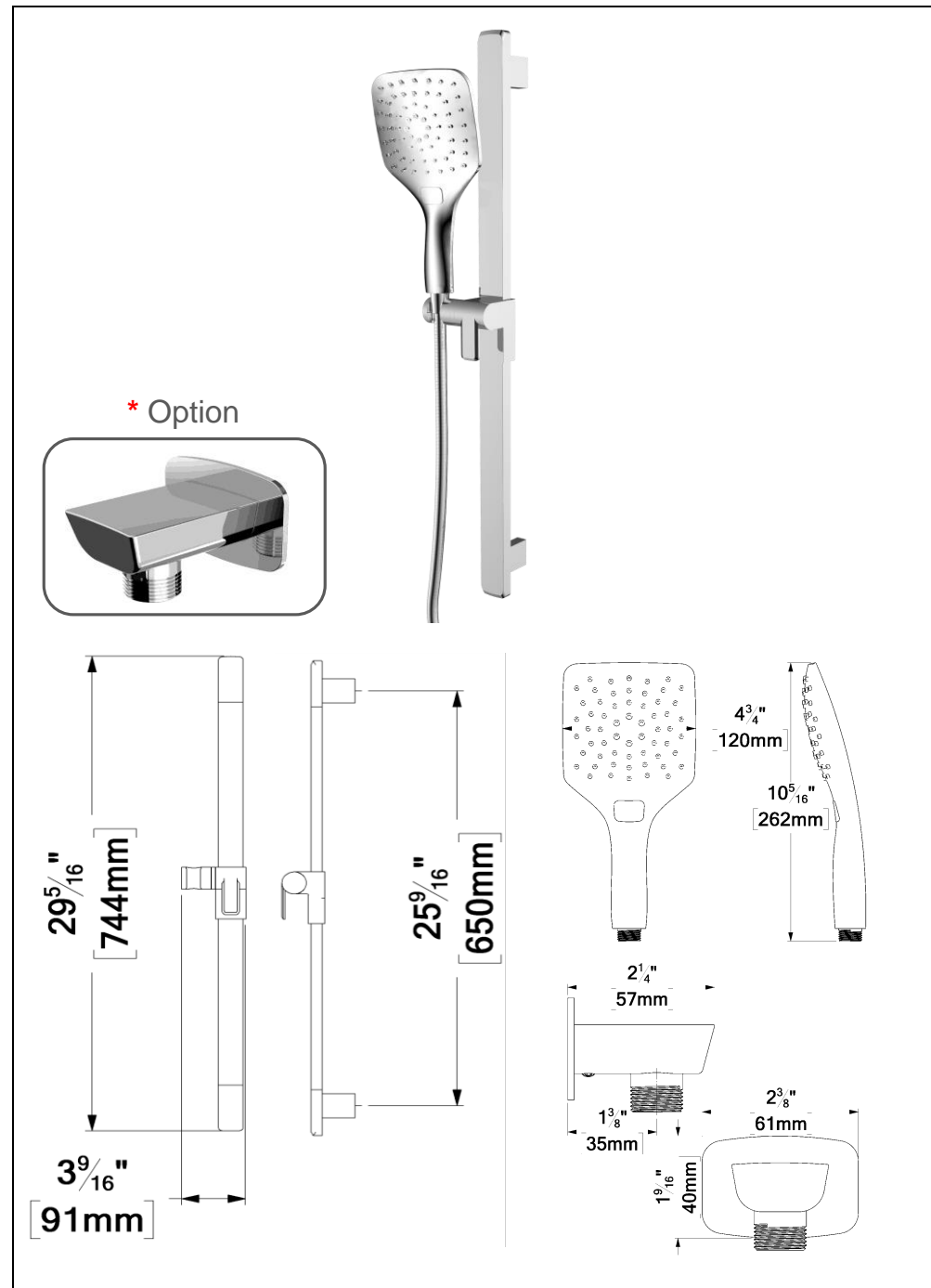

The product may vary slightly from its dimension and appearance.
 Les dimensions et l'aspect du produit peuvent varier légèrement de l'illustration



BS-307-XX

SPECIFICATION

- Spout
- Made of solid brass
- Slip-fit installation
- Flow rate: 25L/min [6.6 gpm] @60psi
- Inlet 1/2in male NPT
- Limited lifetime warranty

FINISHES AVAILABLE

- Refer to the catalog for available finishes

CERTIFICATION

- ASME 112.118.1 / CSA B125.1



For more information about the product or before proceeding to any installation please consult the guide.

Products covered by a limited lifetime warranty against all manufacturing defects.

SPÉCIFICATION

- Bec de bain
- Fabriqué en laiton massif
- Installation Slip-fit
- Débit: 25L/min [6.6 gpm] @60psi
- Connexion 1/2" mâle NPT

FINIS DISPONIBLE

Se référer au catalogue pour les finis disponible

CERTIFICATION

ASME 112.118.1 / CSA B125.1



Pour plus d'information sur le produit ou avant de procéder à toute installation veuillez consulter le guide.

Produits couverts par une garantie à vie limitée contre tout défaut de fabrication.

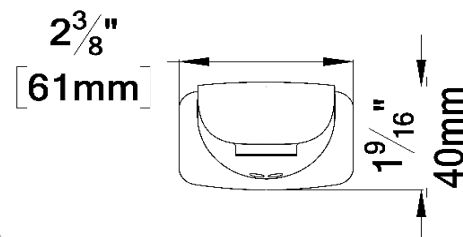
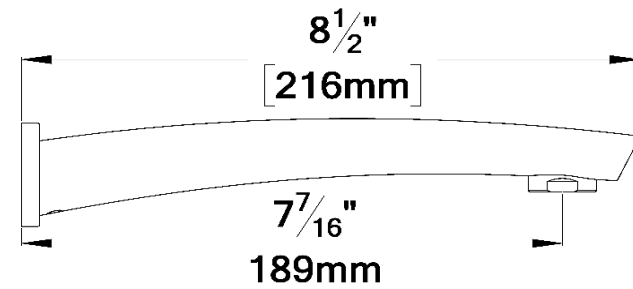

Slip-Fit



The product may vary slightly from its dimension and appearance.
Les dimensions et l'aspect du produit peuvent varier légèrement de l'illustration