

Night systems,
innovation and a wide
range of proposals
for the contemporary
walk-in closet.

7 Storage systems

10 Cover, 40 Cover freestanding

71 Walk-in closets

74 Dress bold, 100 Zenit, 128 Abacus

La cabina armadio contemporanea: una tipologia d'arredo particolare, in cui le esigenze compositive si sommano all'importanza del dettaglio e delle soluzioni per l'organizzazione dello spazio. Un tema da sempre al centro del progetto di Giuseppe Bavuso, per la ricerca di una sintesi ancora più esclusiva fra architettura e sistemi componibili. Il risultato è una collezione composta da cinque sistemi evoluti, differenti nella logica progettuale, ma accomunati da un'eccezionale versatilità, per garantire la massima possibilità di personalizzazione funzionale ed estetica.

Der moderne Kleiderschrank: ein besonderer Einrichtungs-vorschlag, charakterisiert von der Vereinigung des Details mit exklusiven Lösungen, fuer die Organisation des Raumes geeignet. Exklusive Suche nach einer Synthese zwischen Architektur und modularen Systemen ist der Schwerpunkt des Projektes von Giuseppe Bavuso. Das Ergebnis ist eine Sammlung von fünf fortgeschrittenen Systemen, die ganz anders in dem Projekt aber aehnlich bei der außergewöhnlichen Vielseitigkeit sind um maximale Funktionalitaet und ästhetische Personalisierung zu gewährleisten.

Le dressing contemporaine: un meuble remarquable, dans lequel les exigences de composition augmentent l'importance des détails et des solutions pour l'organisation de l'espace. Un thème toujours au centre de la conception de Giuseppe Bavuso, dans la recherche d'une synthèse encore plus exclusive entre l'architecture et les systèmes modulaires. Le résultat est une collection de cinq systèmes avancés, différents dans la logique de conception, mais unis par une polyvalence exceptionnelle, afin de garantir la possibilité maximale de personnalisation esthétique et fonctionnelle.

El vestidor contemporaneo: un tipo particular de mueble, al cual los requisitos compositivos se añaden a la importancia de los detalles y de las soluciones para la organización del espacio. Un tema desde siempre en el centro del diseño de Giuseppe Bavuso, para la búsqueda de una síntesis aún más exclusiva entre la arquitectura y los sistemas modulares. El resultado es una colección compuesta de cinco sistemas avanzados, diferentes en la lógica de diseño, pero unidos por una versatilidad excepcional, para garantizar la posibilidad de personalización máxima funcional y estética.

Contemporary walk-in closet: unique system combining fundamental requirements, care for details and space arrangement solutions. Giuseppe Bavuso has always been focused on this project, aiming at the most exclusive synthesis of architecture and modular systems. The result is a collection made up of five fully-developed systems, with different design approach, but sharing great flexibility to obtain highest aesthetic and functional customization, technology and design, thus meeting any project.

Storage systems

10 Cover, 36 Cover freestanding



Design Giuseppe Bavuso

Cover

Closing system equipped with single glazed doors in glass or porcelain. The core of the Cover project are the uprights, fixed to the ceiling and to the floor, which collect the invisible hinges of the doors and the exclusive integrated internal led lighting system. Shelves, clothes hangers, trays and drawers are fixed to the uprights with a joint system, without visible screws, which allows a free and easily adjustment over the time.

Sistema di chiusura attrezzato con ante battenti monofronte in vetro o grès. Fulcro del progetto Cover sono i montanti, fissati a soffitto e a pavimento, che raccolgono i cardini invisibili delle ante e l'esclusivo sistema integrato di illuminazione interna a led. Mensole, aste portabiti, vassoi e cassettiere vengono fissati ai montanti con un sistema ad incastro, senza viti a vista, che consente una disposizione libera e modificabile nel tempo con estrema facilità.

Fluegeltuer-Einbausystem mit Frontfüllungen aus Glas oder Grès. Schwerpunkt dieses Möbel-systems ist die, zwischen Decke und Boden verspannte Träger-konstruktion, welche die nicht sichtbaren Scharniere der Türen und die integrierte Led Innen-beleuchtung aufnimmt. Ablageböden, Kleiderstangen, Auszüge und hängende Schubladenelemente werden von hinten in die Träger eingehängt. Durch dieses, kann man mit Flexibilitaet die Position den Zubehoeren aendern.

Système modulaire équipé de portes vitrées simples en verre ou en grès. Le cœur du projet Cover sont les montants fixés au plafond et au sol, qui comprennent les charnières invisibles des portes et l'exclusif éclairage intérieur led intégré. Les étagères, les tiges porte manteaux, les étagères extractibles et les blocs tiroirs sont fixés aux montants avec un système de verrouillage, sans vis visibles, ce qui permet un montage libre et modifiable dans le temps avec une extrême facilité.

Sistema de cierre equipado con hojas batientes monofaciales en cristal o grès. El núcleo del proyecto Cover son los montantes, fijados al techo y al suelo, que recogen las bisagras invisibles de las puertas y el exclusivo sistema integrado de iluminación led interna. Estantes, barras de colgar, bandejas y cajoneras se fijan a los montantes con un sistema de enganche, sin tornillos visibles, que permite una disposición libre y modificable en el tiempo con extrema facilidad.

Struttura *Structure*: 14 brown
 Ante in vetro *Glass doors*: 103 grigio ardesia opaco
 Accessori interni *Internal equipment*: 25 melaminico larice carbone
 Vassoi estraibili *Pull-out trays*: 153 similpelle castoro



Il similpelle, disponibile nelle varianti argilla e castoro, è vero cuoio naturale, ricavato da un processo di riutilizzo pre-consumer che non va ad incidere ulteriormente sulle risorse. Finiture frutto di un approccio ecosostenibile concreto e di tecnologie esclusive, che coinvolgono vista e tatto per creare soluzioni contraddistinte da un feeling naturale contemporaneo.

The synthetic leather, available in the argilla and castoro finishings, is real natural leather, made from a process of pre-consumer re-use which is not further affecting natural resources. These finishings are the result of a concrete eco-friendly approach and unique technologies, involving sight and touch, thus creating solutions characterized by a contemporary natural feeling.

Kunstleder, verfügar in der Ausführung argilla und castoro, ist echtes natürliches Leder welches aus einem Prozess der Wiederverwertung entsteht, ohne die natürlichen Ressourcen zu belasten. Oberflächen die aufgrund eines konkret ökosensiblen und technisch exklusiven Ansatzes entstanden sind und das Sehen und den Tastsinn einbeziehen, um einen zeitlos natürlichen Eindruck zu vermitteln.

Le simili-cuir, disponible en couleur argilla et castoro, est vrai cuir naturel, produit à partir d'un processus de réutilisation pré-consommation qui n'affecte pas les ressources. Les finitions sont le résultat d'une approche ecosostenibile et de technologies concrètes et uniques, impliquant la vue et le toucher pour créer des solutions caractérisées par un sentiment naturel contemporain.

El simil cuero, disponible en las variantes argilla y castoro, es un cuero natural, que se obtiene por un proceso de re-uso pre-consumidor que no va a afectar a los recursos. Estos acabados son el resultado de un enfoque sustentable y de tecnologías exclusivas, que unen vista y tacto para crear soluciones que se caracterizan por un feeling natural contemporáneo.



Ripiani estraibili *Pull out trays*: 14 brown e 153 similpelle castoro
Contenitori *Organizer*: 15 noce
Porta orologi, vaschetta concava, vaschetta con fessure
Watch holder, concave box and box with jewels slots: 153 similpelle castoro

Le ante Cover sono realizzate in vetro singolo temperato di spessore 4 mm, disponibili in tutti i vetri temperati di sicurezza: trasparenti, riflettenti, acidati, specchio e laccati opachi, lucidi e reflex nei 74 colori Ecolorsystem, in alternativa la versione in gres, disponibile in due varianti di colore crema e moka, per un effetto naturale e materico. La maniglia in metallo pressofuso, integrata nell'anta, è uno degli elementi di caratterizzazione estetica del progetto Cover. Il sistema prevede anche mensole in vetro con ring in alluminio, che offrono l'ulteriore possibilità di top rivestito in similpelle castoro.

The Cover doors are made of 4 mm thick single tempered glass, available in all safety tempered glass: transparent, reflective, etched, mirror and mat, glossy and reflex lacquered in the 74 Ecolorsystem colors, and as second option in porcelain, available in two colors crema and moka, for a natural and material effect. The dye casting metal handle, integrated into the door, is one of the main aesthetic element of the Cover project. The system is also available with glass shelves with aluminium ring, providing an additional possibility to be covered with castoro synthetic leather.

Die Türen sind aus 4 mm dickem gehärteten Glas, erhältlich in allen Sicherheitsglasarten: transparent, reflektierend, geätzt, Spiegel- und mat, glänzend und Reflex lackiert in den 74 Ecolorsystem Farben, alternativ such in der Gres Version, verfügbar in zwei Creme- und Moka-Farben, für einen natürlichen und stofflichen Effekt. Der Druckguss-Griff der in die Tür integriert ist, ist eines der ästhetischen Charaktereigenschaften des Programms Cover. Das System sieht auch Glasböden mit Alu-Umrandung vor, die mit Castoro Leder Abdeckung ausgestattet werden können.

Les portes Cover sont en verre trempé simple de 4 mm d'épaisseur, disponible dans tous les verres trempés de sécurité: transparent, réfléchissant, acidé, miroir et laqué mat, brillant et reflex dans les 74 couleurs Ecolorsystem, ou en version céramique, disponible en deux couleurs Crema et Moka, pour un effet naturel et matériel. La poignée en métal moulé, intégrée dans la porte, est un élément de caractérisation esthétique du projet Cover. Le système comprend également des étagères en verre avec structure en aluminium, qui sur demande peuvent être recouverts par un plateau en simili-cuir finition castoro.

Las puertas Cover están hechas de solo cristal templado de 4 mm de grosor, disponible en todos los cristales templados de seguridad: transparentes, reflectantes, acidados, espejo y lacados mate, brillante y reflex en los 74 colores Ecolorsystem, en alternativa la versión en gres, disponible en dos colores Crema y Moka, para un efecto natural y material. La manilla en metal inyectado, integrada en la puerta, es una de los elementos de caracterización estética del proyecto Cover. El sistema prevé también estantes en cristal con aro en aluminio, que ofrecen la posibilidad del top revestido en simil cuerocastoro.

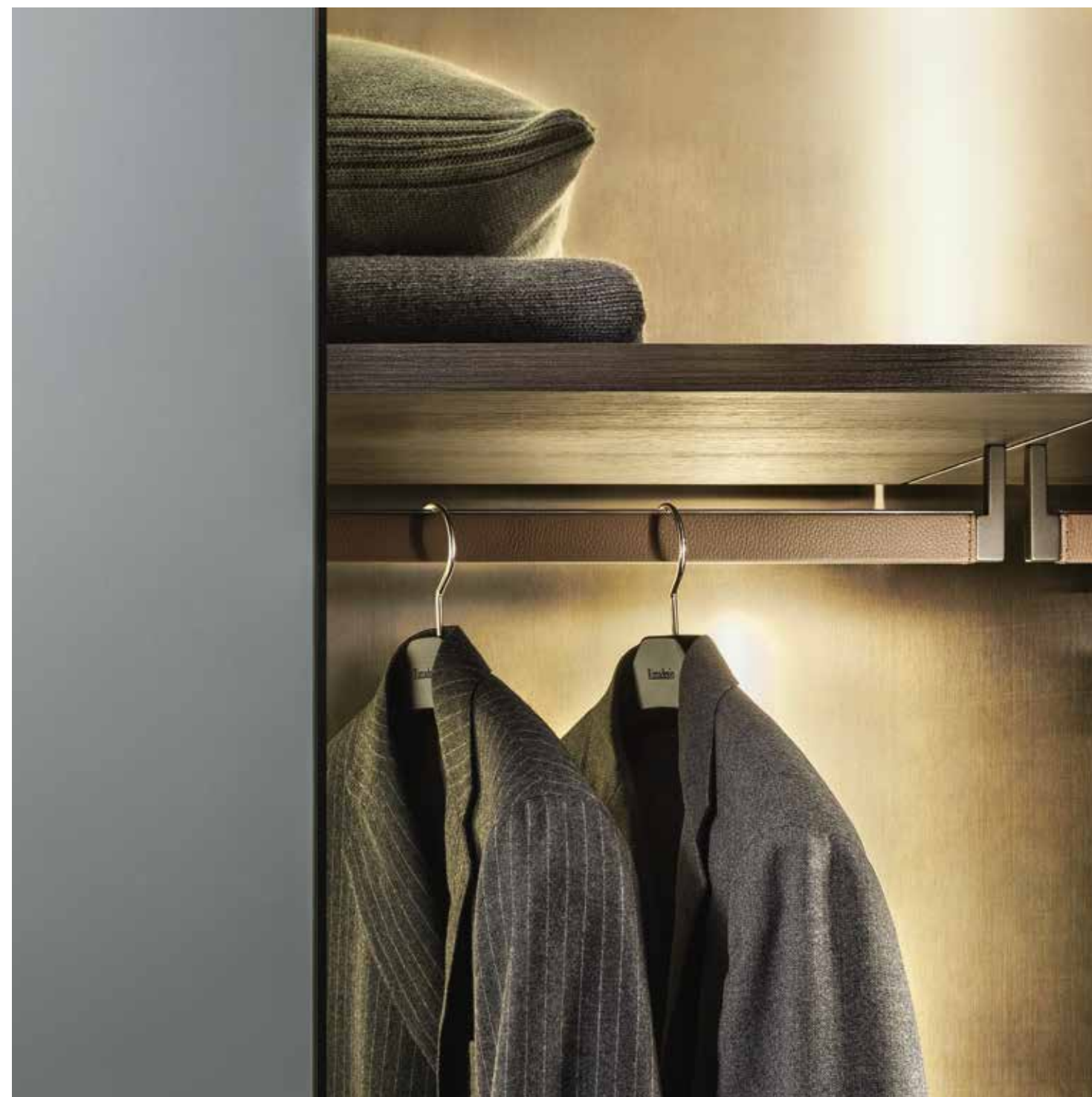

Mensola Shelf: 25 melaminico larice carbone
Asta portabiti Cloth hangers: 153 similpelle castoro
Struttura Structure: 14 brown
Ante in vetro Glass doors: 103 grigio ardesia opaco



Perfettamente ingegnerizzato per essere montato senza viti a vista, il sistema Cover consente di realizzare cabine armadio e nicchie attrezzate in piena continuità con gli ambienti, senza soglia a pavimento. Pensato per integrarsi perfettamente nelle nicchie e nei vani grazie alla realizzazione sempre su misura, Cover è definito dall'idea di trasformare le ante nell'unico elemento strutturale dell'armadio, a cui l'attrezzatura si aggancia liberamente, senza alcuna necessità di intervenire sulle pareti.

Perfectly engineered to be fitted without visible screws, the Cover system allows to create walk-in wardrobes and equipped niches without threshold on the floor. Cover is designed to perfectly fit niches and spaces, and is defined by the idea of making doors the only structural element of the cabinet. The internal equipment is fixed to this structural element, without any further wall fixing.

Perfekt entwickelt, um ohne Schrauben montiert zu werden, ermöglicht das System Cover begehbaren Kleiderschränken und Nischen ohne Schwelle auf dem Boden zu gestalten. Cover Kennzeichen sind die Türen als Strukturelement des Schrank, wobei die verschiedene Elemente stufenlos befestigt werden und die Rück frei bleibt.

Parfaitement conçu pour être assemblé sans vis visibles, le système Cover permet de réaliser des cabines dressing et niches équipées, complètement intégrées aux espaces sans seuil au sol. Conçu pour s'adapter parfaitement dans les niches et les ouvertures grâce à la réalisation toujours sur mesure, le projet Cover transforme les portes dans le seul élément structurel du placard, auquel fixer tous les accessoires à l'intérieur, sans qu'il soit nécessaire d'intervenir sur les murs.

Perfectamente diseñado para ser montado sin tornillos a la vista, el sistema Cover permite realizar vestidores y nichos equipados en plena continuidad con los ambientes, sin elementos en el suelo. Diseñado para integrarse perfectamente a los nichos y los huecos gracias a su realización siempre a medida, Cover está definido con la idea de transformar las puertas en el único elemento estructural del armario, y sirven de soporte al equipamiento interior, sin ninguna necesidad de intervenir en las paredes.





Cover è un sistema di ante battenti monofronte in vetro o gres che possono essere utilizzate per chiudere gli ambienti dedicati alle cabine armadio o, in alternativa, per trasformare le nicchie in veri e propri armadi a muro. Le ante con apertura battente, con struttura in estruso di alluminio, vetro singolo o gres spessore 4 mm, sono dotate di maniglie in pressofusione di zama con nottolino fisso o con serratura e chiave.

Cover is a single-sided glass or porcelain hinged door system, that can be used to close area dedicated to the walk-in closets or, alternatively, to transform niches into real wardrobes. The 4 mm thick doors glass or porcelain with hinged opening, with extruded aluminum structure, are equipped with handles in die-casting aluminium with fixed revolving nut or with lock and key.

Fluegeltuer-Einbausystem mit Frontfüllungen aus Glas oder Keramik, die ermöglichen Ankleide Raumligeiten zu begrenzen oder Nische als eingebaute Schrankraumen zu verwenden.

Fluegeltuer mit strangepresster Aluminium Struktur und 4 mm Glas oder Grès Scheibe, zusammen mit integrierter Druckguss-Griff mit Verriegelung oder Schluessel.

Cover est un système de porte battante uniface en verre ou grès, qui peut être utilisé pour fermer des espaces dressings ou pour transformer les niches en vrais placards. Les portes battantes, avec structure en aluminium extrudé, en verre ou grès de 4 mm d'épaisseur, sont équipées de poignées en aluminium moulé sous pression avec verrou fixe ou avec serrure et clé.

Cover es un sistema de puertas batientes mono frontal de vidrio o gres que pueden ser utilizadas para cerrar los entornos dedicados a los vestidores o, alternativamente, para transformar los nichos en armarios a pared reales. Las puertas con apertura batiente, con estructura de aluminio extruido, vidrio o gres de 4 mm de espesor, están equipadas con manillas en inyección de zamak con condena fija o con cerradura y llave.



L'attrezzatura completa del sistema Cover prevede basamenti, mensole, aste portabiti, ripiani estraibili e cassettiere. Tutti gli elementi vengono fissati ai montanti con un sistema ad incastro, senza viti a vista, e la disposizione può essere modificata e variata nel tempo con estrema facilità.

Cover system accessories include floor bases, shelves, cloth-hanger rods, pull out shelves and drawer units. All the elements are fixed directly to the uprights, without visible screws, and the layout can be modified any time in an easy way.

Die Ausstattung des Systems Cover bietet Basisboden, Fachboden, Kleiderstange ausziehbare Fachboden und Schubladenelemente an. Alle Elemente sind an den Pfosten befestigt mit einem Verbindungssystem ohne sichtbare Schrauben und die Verstellung kann im Laufe der Zeit leicht verändert werden.

L'équipement complet du système Cover comprend bases au sol, étagères, tiges porte-manteaux, étagères extractibles et bloc tiroirs. Tous les éléments sont fixés aux montants avec un système à encastrement sans vis visibles et la disposition peut être facilement modifiée ensuite.

El equipo completo del sistema Cover proporciona soportes, estantes, barras colgantes, estantes extraíbles y cajoneras. Todos los elementos se fijan a los montantes con un sistema a encaje, sin tornillos a vista, y la disposición se puede modificar y variar en el tiempo con facilidad extrema.



Concezione progettuale
Design concept



Il progetto Cover rinnova la concezione progettuale della nicchia o dell'armadio a muro, trasformando le ante nell'unico elemento strutturale necessario a cui agganciare l'attrezzatura interna. Come tutti i sistemi Rimadesio, Cover è dotato di una serie di accorgimenti esclusivi, come i montanti muniti di un esclusivo sistema di regolazione invisibile in tre direzioni, che consente una perfetta messa in bolla delle ante, anche con composizioni di grandi dimensioni. L'attrezzatura completa del sistema Cover prevede basamenti, mensole, aste portabiti, ripiani estraibili e cassettiere. Tutti gli elementi vengono fissati ai montanti con un sistema ad incastro, senza viti a vista, e la disposizione può essere modificata e variata nel tempo con estrema facilità.

The Cover project renews the design concept of the niche or wardrobe, transforming the doors in the one and only structural element, necessary to fix the internal equipment. As all Rimadesio systems, Cover presents some exclusive features, such as the uprights equipped with a three direction invisible adjustment system, that allows a perfect leveling of the doors, even with compositions of large dimensions. Cover system accessories include floor bases, shelves, cloth-hanger rods, pull out shelves and drawer units. All the elements are fixed directly to the uprights, without visible screws, and the layout can be modified any time in an easy way.

Das Projekt erneuert das Konzept der Nische oder den Schrankraum. Die Türen sind die einzige strukturelle Elemente wo wird die Innenaustattung fixiert. Wie alle Rimadesio Systeme hat Cover eine exklusive System mit Pfosten, die eine perfekte Nivellierung der Türen erlaubt, auch mit großen Kompositionen. Die Ausstattung des Systems Cover bietet Basisboden, Fachboden, Kleiderstange ausziehbar, Fachboden und Schubladenelemente an. Alle Elemente sind an den Pfosten befestigt mit einem Verbindungssystem ohne sichtbare Schrauben und die Verstellung kann im Laufe der Zeit leicht verändert werden.

Le projet Cover renouvelle la conception d'équiper une niche ou un placard en transformant les portes dans le seul élément structurel nécessaire auquel fixer tous les accessoires à l'intérieur. Comme tous les autres systèmes Rimadesio, Cover est doté d'une série de détails exclusifs, comme les montants, équipés d'un système invisible exclusif de réglage en trois directions, qui permet une parfaite mise à niveau des portes, même avec des grandes compositions. L'équipement complet du système Cover comprend bases au sol, étagères, tiges porte-manteaux, étagères extractibles et bloc tiroirs. Tous les éléments sont fixés aux montants avec un système à encastrement sans vis visibles et la disposition peut être facilement modifiée ensuite.

El proyecto Cover renueva la concepción de proyecto de los espacios pequeños o del armario contra pared, transformando las hojas en el único elemento estructural necesario a los cuales enganchar el equipo interior. Como todos los sistemas Rimadesio, Cover está dotado de una serie de recursos exclusivos, como los montantes que tienen un exclusivo sistema de regulación invisible en tres direcciones, que permiten una perfecta nivelación de las hojas, también en composiciones de grandes dimensiones. El equipo completo del sistema Cover proporciona soportes, estantes extraíbles y cajoneras. Todos los elementos se fijan a los montantes con un sistema a encaje, sin tornillos a vista, y la disposición se puede modificar y variar en el tiempo con facilidad extrema.

Caratteristiche tecniche esclusive
Exclusive technical features

Elementi strutturali
Structural elements

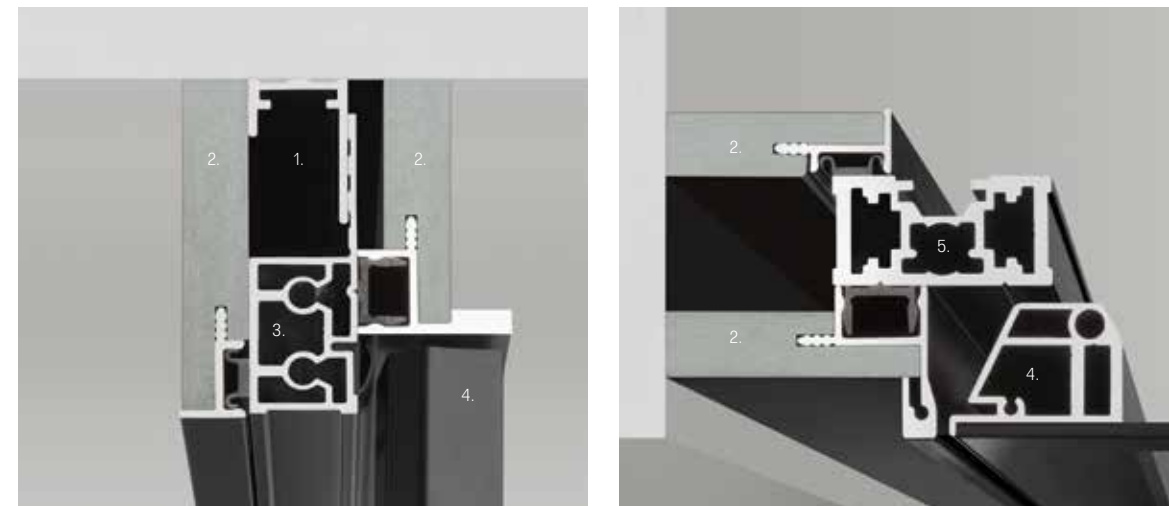

1. Profilo di aggiustaggio a soffitto in estruso di alluminio. Consente la perfetta messa in bolla del traverso e di compensare gli eventuali dislivelli del soffitto. / Ceiling adjusting profile in extruded aluminium. It allows a perfect leveling of the runner and to compensate any possible unevenness of the ceiling.
2. Fasce di aggiustaggio con profilo di supporto in estruso di alluminio e fascia di compensazione in mdf laccato adattabile al vano. Esclusivo sistema di aggancio a scomparsa in nylon. / Fillers with supporting profile in extruded aluminium and adjustment perfectly adaptable to the opening. Unique concealed nylon fixing system.
3. Traverso strutturale in estruso di alluminio, dotato di magneti di chiusura, pistoncino idraulico e guarnizione di battuta in pvc per un movimento di chiusura ammortizzato. / Structural crosspiece in extruded aluminium, equipped with closing magnets, hydraulic piston and perimeteric joint in pvc, which allows a soft and silent closing.
4. Pannello porta, struttura in estruso di alluminio e vetro singolo frontale temperato oppure gres spessore 4 mm. Guarnizione di chiusura in pvc. / Panel door with extruded aluminium structure and single tempered front glass or porcelain thickness 4 mm. Closing joint in silicone rubber.
5. Montante strutturale in estruso di alluminio, accessoriabile con illuminazione a led opzionale. Cerniera incassata con chiusura magnetica e con regolazione micrometrica dell'altezza del pannello. / Extruded aluminium structural upright, which can be equipped with optional led lighting system. Patented recess hinges with magnetic closing which allow a micrometric adjusting of the panel door.

Sistema di fissaggio degli accessori
Accessories fixing system



Tutti gli accessori vengono fissati ai montanti con un sistema ad incastro, senza viti a vista, e la disposizione può essere modificata e variata nel tempo con estrema facilità. All the elements are fixed directly to the uprights, without visible screws, and the layout can be modified any time in an easy way.

Maniglie
Handles



1. 2013 maniglia in pressofusione di zama incassata a filo struttura. / Die-casting aluminium handle.
2. 2014F / 2014C maniglia in pressofusione di zama con serratura e chiave. Die-casting aluminium handle with lock and key.

Tipologie compositive
Different compositions

Ante battenti
Hinged doors

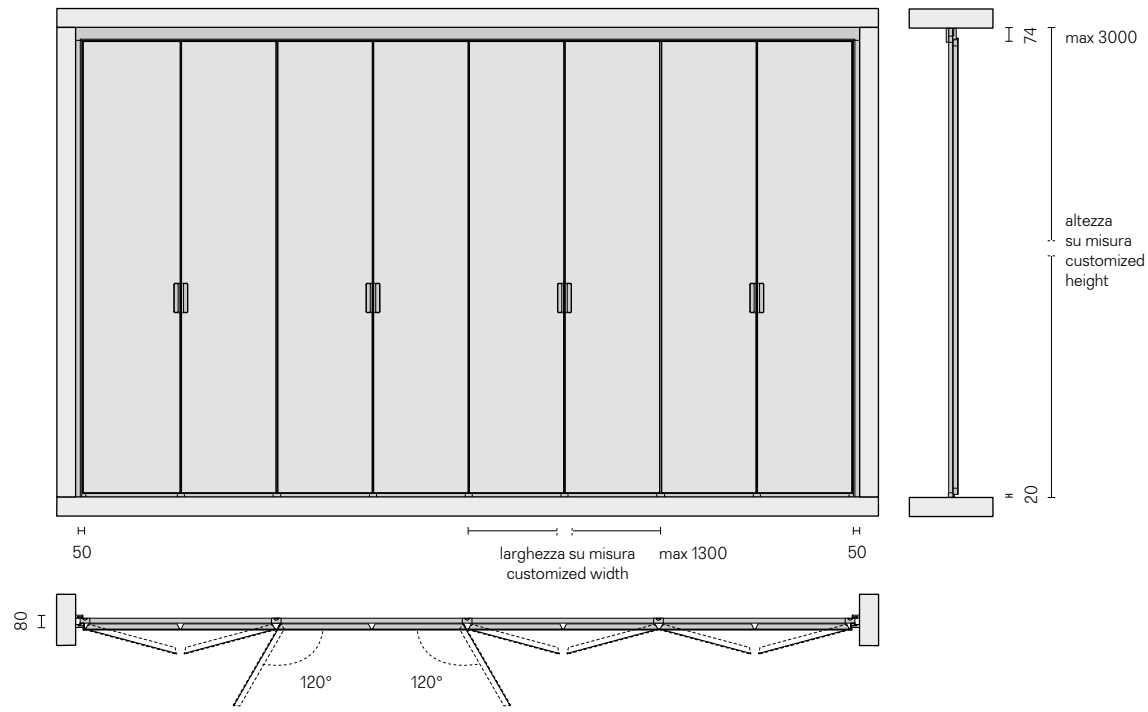

Ante battenti con attrezzatura interna
Hinged doors with internal equipment

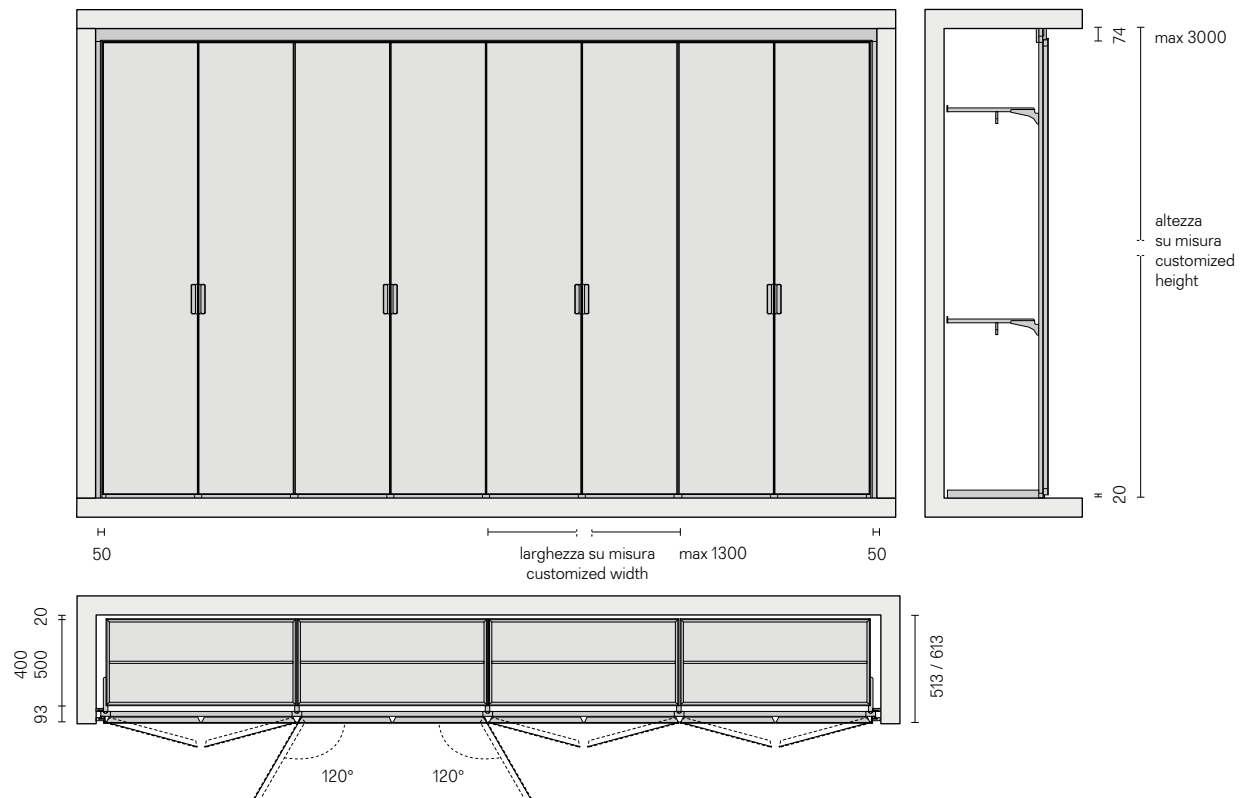

Possibilità di utilizzo
Possible compositions

Composizione a muro
Wall composition

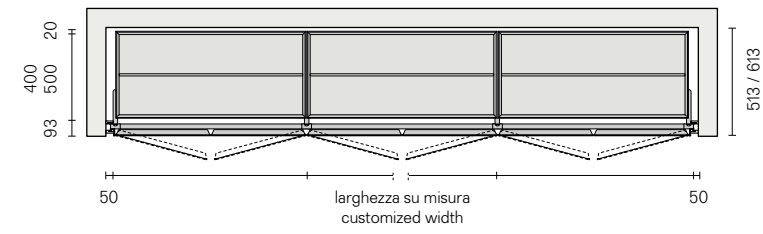

Composizione lineare con fianchi finali
Linear composition with terminal panels

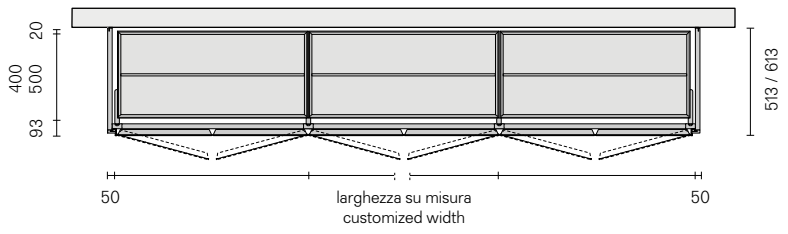

Composizione ad angolo
Corner composition

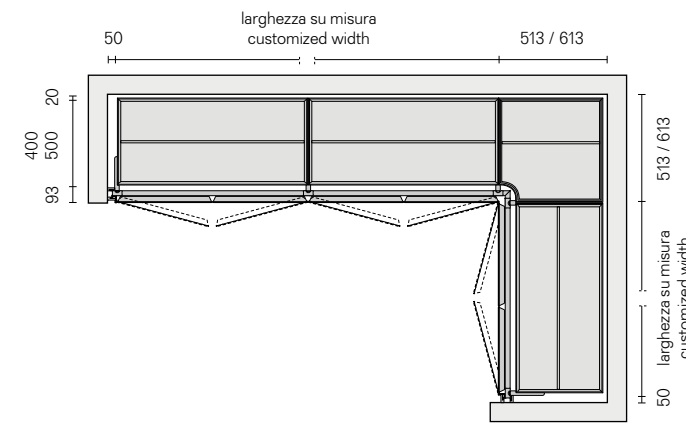

Composizione ad angolo esterno
Composition with external corner

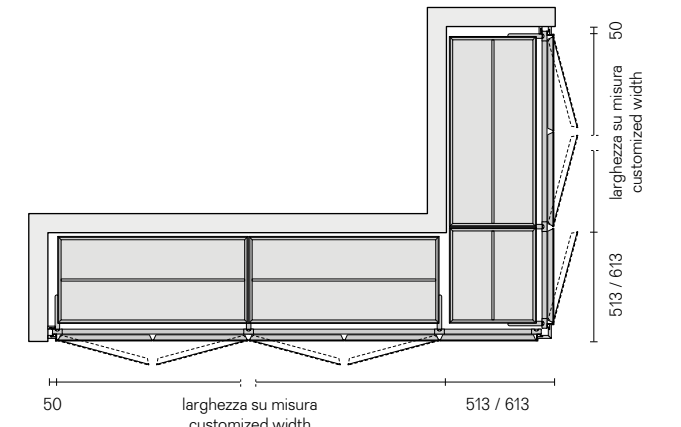

Composizione a C
C-shaped composition

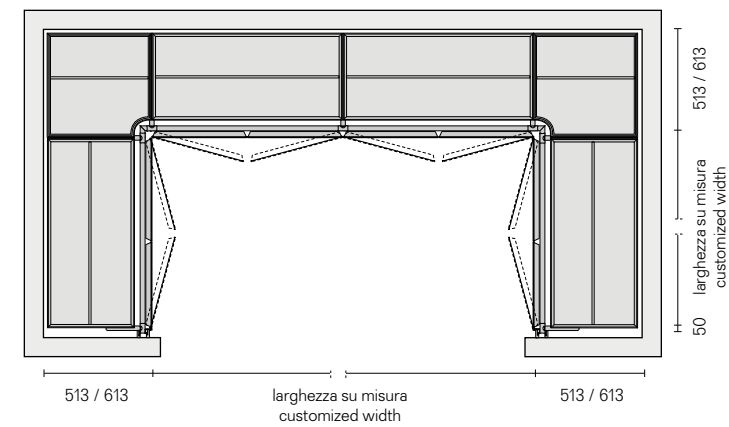

Nicchia attrezzata
Equipped niche

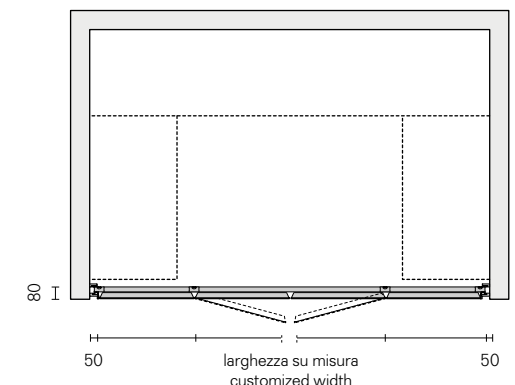

Modularità e componenti
Modularity structure and components

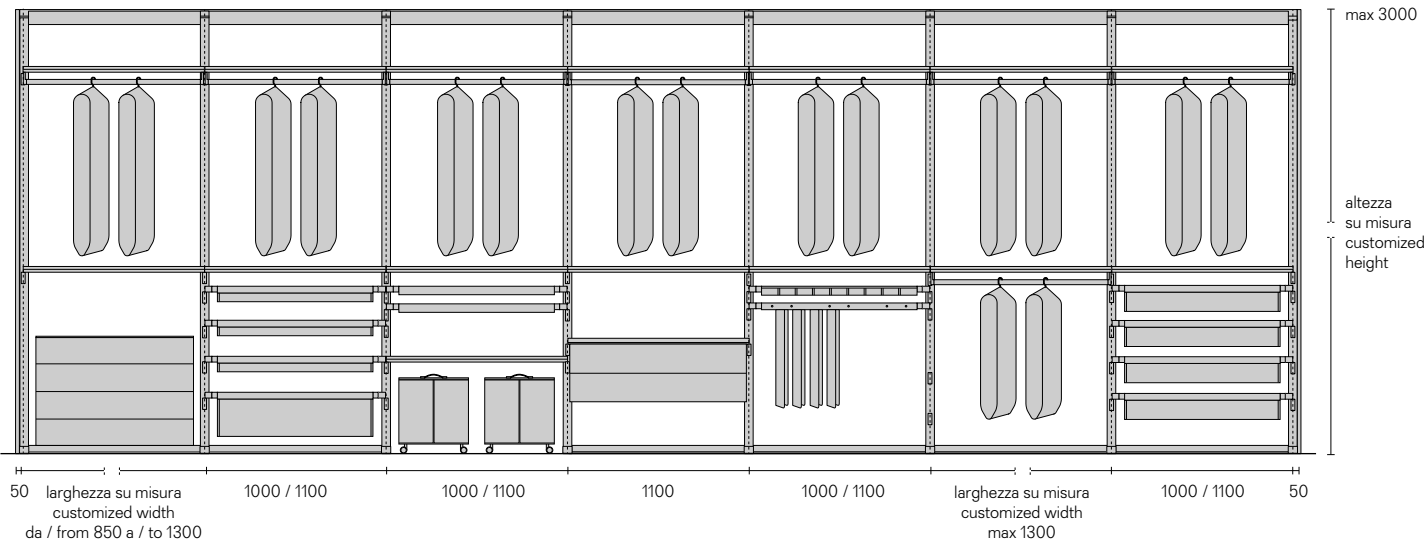

Anta battente con struttura in estruso d'alluminio, vetro temperato o gres spessore 4 mm. Chiusura con chiave opzionale / Hinged panel door with extruded aluminium structure and tempered glass or gres front thickness 4 mm. Key lock on request

Fianco finale in legno laccato Terminal panel in lacquered wood

Montante strutturale in estruso di alluminio con illuminazione led opzionale. Profilo di aggiustaggio a soffitto e traverso strutturale / Structural upright in extruded aluminium, also available with an internal led lighting system. Ceiling adjusting profile and structural crosspiece

Fasce di aggiustaggio laterali e superiori, anteriori e posteriori / Lateral and upper, front and back fillers

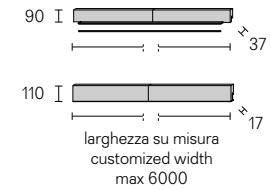
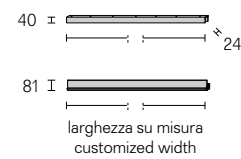
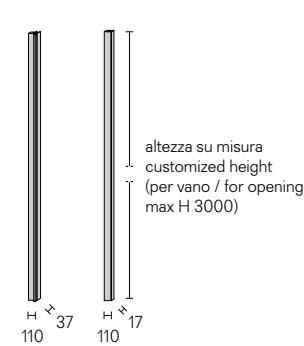
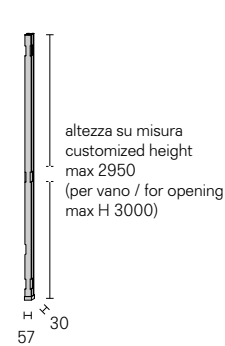
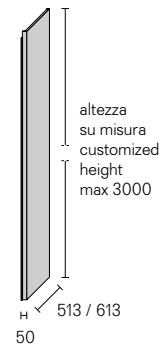
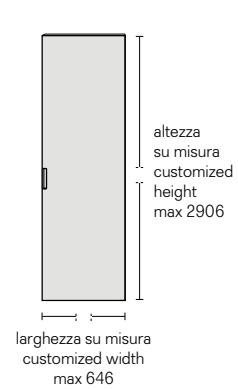

Accessori
Accessories

Ripiano estraibile con vaschetta in similpelle / Pull out shelf with tray in synthetic leather finishing

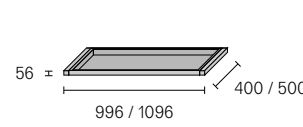

Contenitore in essenza di noce Walnut veneered organizer

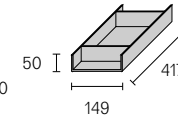

Separatore doppio Organizer with double partition

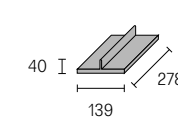

Porta orologi / Watch holder

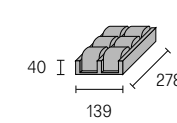

Vaschetta concava e vaschetta con fessure / Concave box and box with jewels slot

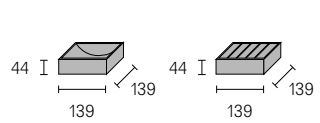

Ripiano estraibile con portapantaloni e vani per cinture in similpelle / Pull out shelf with trousers rack and belts tray in synthetic leather finishing

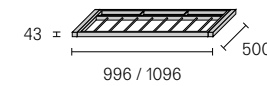

Ripiano estraibile portacravatte in similpelle / Pull out shelf with tie rack in synthetic leather finishing

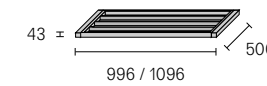

Ripiano estraibile portascarpe in similpelle / Pull out shelf with shoe rack in synthetic leather finishing

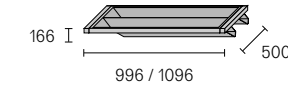

Ripiano estraibile con organizer in similpelle / Pull out shelf with organizer tray in synthetic leather finishing

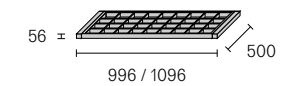

Cesto basso estraibile in similpelle / Pull out small tray in synthetic leather finishing

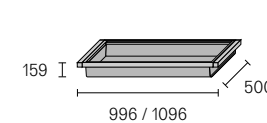

Cesto alto estraibile in similpelle / Pull out big tray in synthetic leather finishing

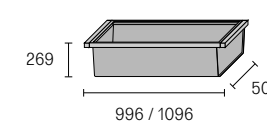

Asta portabiti per mensola con rivestimento opzionale in similpelle / Cloth hanger for shelf with optional cover in synthetic leather

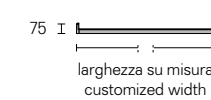

Cesta e vassoio in similpelle / Synthetic leather box and tray

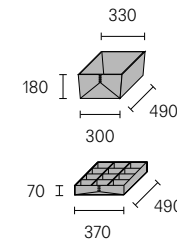

Contenitore su ruote in similpelle / Cabinets on wheels in synthetic leather finishing

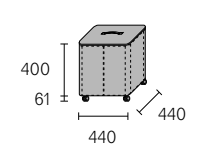

Basamento in legno laccato o in melaminico / Floor base in lacquered wood or melamine

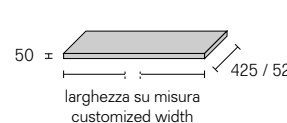

Mensola in melaminico con profilo posteriore in alluminio Melamine shelf with rear aluminium profile

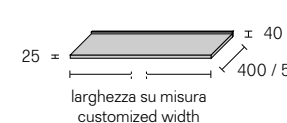

Mensola in vetro con ring in alluminio e top opzionale in similpelle / Glass shelf with aluminium ring and optional top in synthetic leather finishing

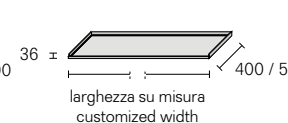

Cassettiera sospesa in legno laccato o melaminico, top in specchio grigio. Top opzionale in similpelle / Suspended drawer unit in lacquered wood or melamine, top in gray mirror. Optional top in synthetic leather

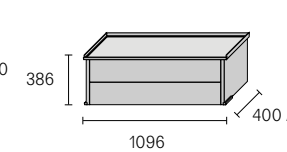

Cassettiera per basamento, o su ruote, in melaminico larice carbone con tre cassetti Drawer unit, or on wheels, in melamine coal larch with three drawers

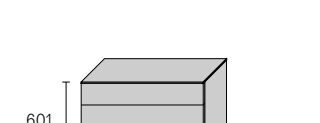
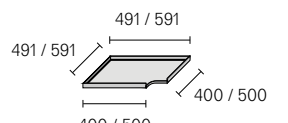
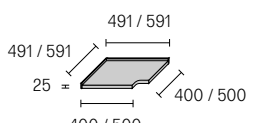
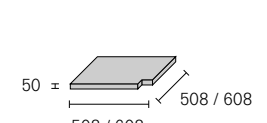
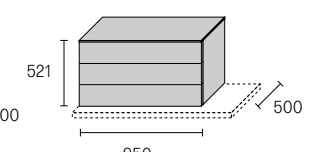

Cassettiera per basamento, o su ruote, in vetro laccato o in melaminico con quattro cassetti / Drawer unit, on wheels in lacquered glass or in melamine with four drawers

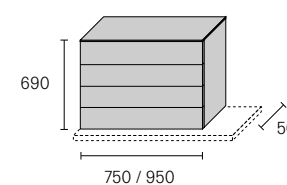

Top opzionale in melaminico larice carbone con fondo rivestito in similpelle, per cassettera su basamento o su ruote / Optional top in coal larch melamine with bottom part covered with synthetic leather, for drawer units on base or on wheels

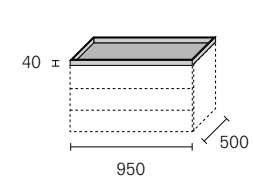
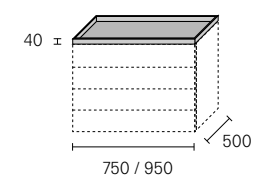
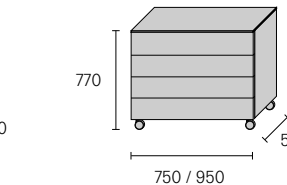

Accessori interni
Internal equipment



1.



2.

1. Mensole in melaminico larice carbone / Coal larch shelf
2. Portacravatte in cuoio rigenerato castoro / Tie rack shelf in castoro synthetic leather finishing
3. Contenitori su ruote in similpelle castoro / Baskets on wheels in castoro synthetic leather finishing
4. Portapantaloni con vani porta cinture in similpelle castoro / Trousers rack with belts tray in castoro synthetic leather finishing
5. Portascarpe in similpelle castoro / Shoe rack in castoro synthetic leather finishing
6. Cassettiera per basamento in melaminico larice carbone / Drawer units on floor base in coal larch melamine



3.



4.



5.



6.



1.



2.

1. Mensola in vetro dotata di ring in alluminio brown e rivestito in similpelle castoro / Glass shelf provided with a brown aluminium ring and covered with regenerated castoro leather
2. Organizer in similpelle castoro / Organizer tray in castoro regenerated leather finishing
3. Cesto basso in similpelle castoro / Small tray castoro synthetic leather finishing
4. Cesto alto in similpelle castoro / Big tray castoro synthetic leather finishing
5. Vaschetta in similpelle castoro / Tray in castoro synthetic leather finishing
6. Cassettiera sospesa in larice carbone con top in similpelle castoro / Suspended drawer unit in coal larch and top in similpelle castoro synthetic leather finishing



3.



4.



5.



6.

Possibilità estetiche
Aesthetical options

Alluminio nero
Black aluminium



1. Montante strutturale in alluminio nero. / Black aluminium structural upright.
2. Guarnizione in pvc nero. / Black pvc joint.
3. Anta battente con struttura in alluminio nero, guarnizione in pvc nero. / Hinged door with black aluminium structure, black pvc joint.
4. Fasce di aggiustaggio in mdf laccato nero. / Black lacquered mdf fillers.

Alluminio brown, piombo, bronzo
Brown, piombo, bronzo aluminium



1. Montante strutturale in alluminio brown, piombo o bronzo. / Structural upright in aluminium brown, piombo or bronzo.
2. Guarnizione in pvc nero. / Black pvc joint.
3. Anta battente con struttura in alluminio brown, piombo o bronzo, guarnizione in pvc nero. / Hinged door with brown, piombo or bronzo aluminium structure, black pvc joint.
4. Fasce di aggiustaggio in mdf laccato brown, piombo o bronzo. / Filler in brown, piombo, or bronzo mdf.

Alluminio anodizzato e platino
Anodized aluminium and platino



1. Montante strutturale in alluminio anodizzato o platino. / Anodized aluminium or platino structural upright.
2. Guarnizione in pvc grigio. / Grey pvc joint.
3. Anta battente con struttura in alluminio anodizzato o platino, guarnizione in pvc grigio. / Hinged door with anodized aluminium or platino structure, grey pvc joint.
4. Fasce di aggiustaggio in mdf laccato alluminio o platino. / Aluminium or platino lacquered mdf fillers.

Laccato Ecolsystem 34 colori
34 colors Ecolsystem lacquered



1. Montante strutturale in alluminio anodizzato, nero, brown, piombo, bronzo o platino. / Structural upright in anodized aluminium, black, brown, piombo, bronzo or platino.
2. Guarnizione in pvc grigio o nero. / Grey or black pvc joint.
3. Anta battente con struttura in alluminio anodizzato, nero, brown, piombo, bronzo o platino. Guarnizione in pvc grigio o nero. / Hinged door in anodized aluminium, black, brown, piombo, bronzo or platino structure. Grey or black pvc joint.
4. Fasce di aggiustaggio in mdf laccato nei 34 colori Ecolsystem e bianco latte. / Mdf fillers lacquered in 34 Ecolsystem colours and bianco latte.

**Finiture
Finishings**

Struttura
Structure

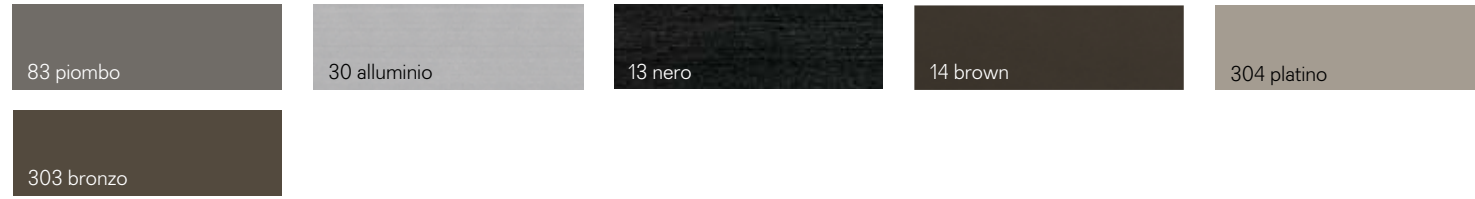

Fascia di aggiustaggio e fianco finale
Filler and side panel



Basamento
Floor base

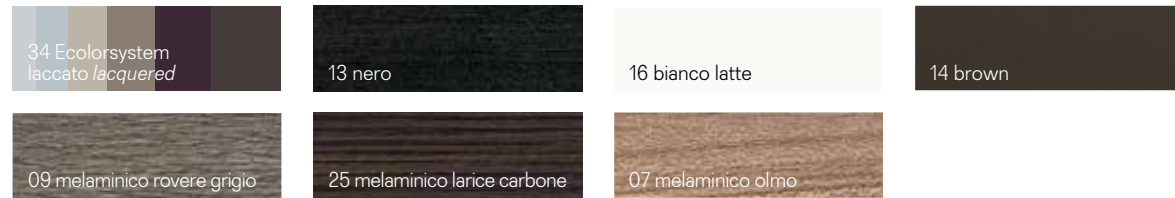

Cassettiera
Drawer unit

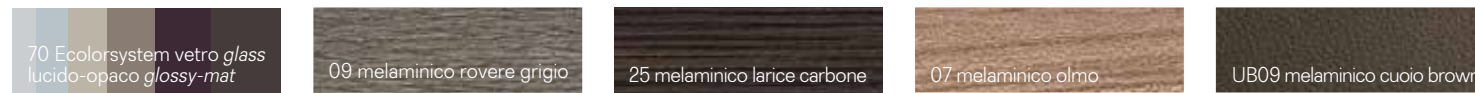

Interno cassettera
Internal drawer unit

Cassettiera sospesa
Suspended drawer unit

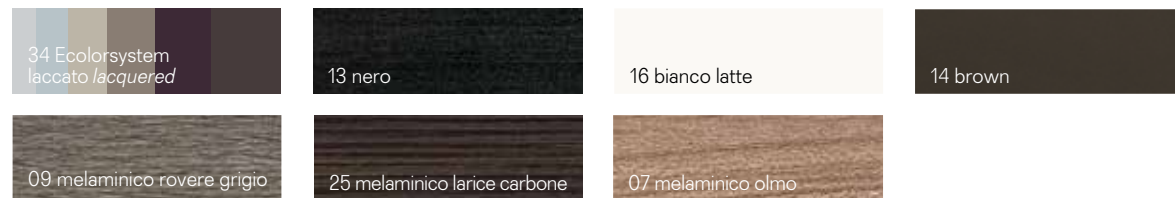

Mensole
Glass Shelf

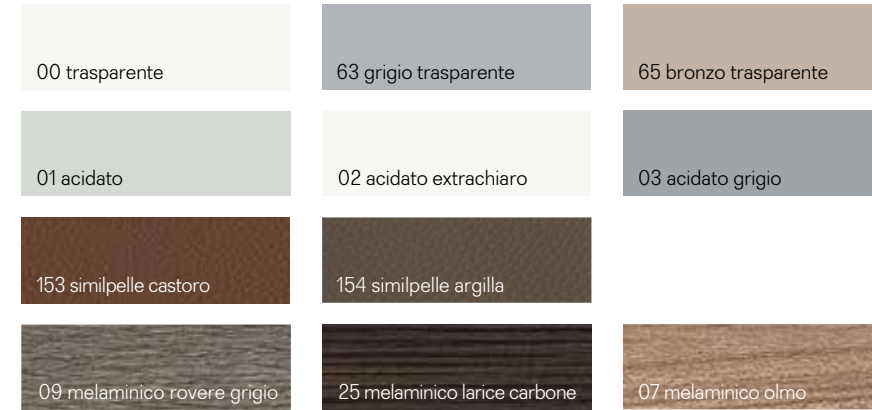

Anta
Door

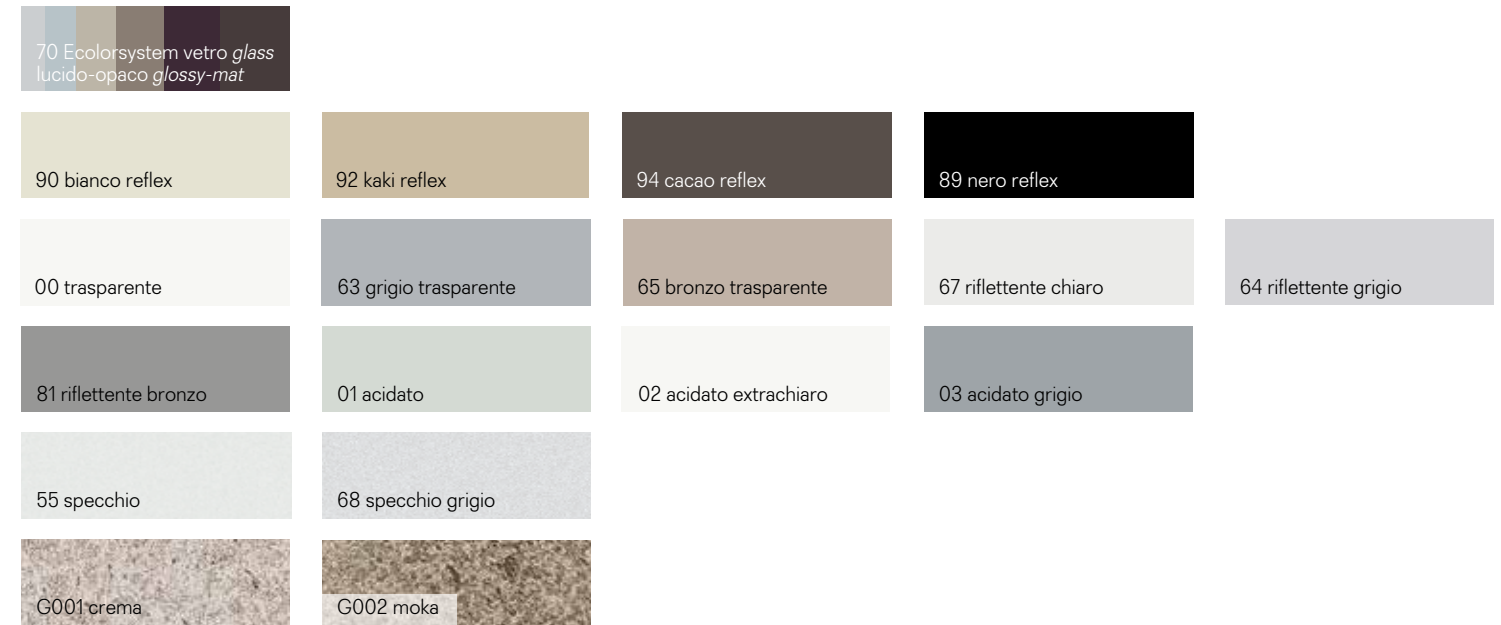

Ripiano estraibile e rivestimento asta portabiti
Pull out shelf and cloth hanger bar





Design Giuseppe Bavuso

Cover freestanding

Cover freestanding is the self-supporting version of the Cover system, therefore equipped with side panels and back panels, thus creating linear or corner compositions, always custom made. The perfect finish of the back panels and the inside of the doors make Cover freestanding an ideal system also for niche solutions, complete with integrated through way. The internal equipments are fixed directly to the uprights, without visible screws, which allows a free and easily adjustment over the time.

Cover freestanding è la versione autoportante del sistema Cover, dotato quindi di fianchi laterali e pannelli schienali per consentire la definizione di composizioni lineari o con angoli, sempre a misura. La perfetta finitura degli schienali e dell'interno delle ante rendono Cover freestanding un sistema ideale anche per soluzioni interparete, completo di passaggi integrati per accedere a cabine armadio o ambienti di servizio. Le attrezzature interne vengono fissate ai montanti con un sistema ad incastro, senza viti a vista, che consente una disposizione libera e modificabile nel tempo con estrema facilità.

Cover freestanding ist die selbsttragende Version des Cover Systems, das daher mit Seitenteilen und Rückwänden ausgestattet ist, um lineare oder eckige Kompositionen auf Maß zu definieren. Das perfekte Finish der Rückenlehnen und der Türinnenseiten macht Cover freestanding zu einem idealen System auch für Zwischenwandlösungen mit integrierten Durchgängen. Die inneren Befestigungen sind an den Pfosten mit einem Verriegelungssystem ohne sichtbare Schrauben befestigt, was eine freie und leicht modifizierbare Anordnung im Laufe der Zeit ermöglicht.

Cover freestanding est la version autoportante du système Cover, donc équipée avec des panneaux latéraux et de fond, pour créer des compositions linéaires ou en angle, toujours sur mesure. La finition parfaite des panneaux de fond et l'intérieur des portes permettent à Cover freestanding de devenir un système idéal aussi pour des solutions de séparation, complètes avec des passages intégrés. Les équipements internes sont fixés aux montants avec un système de verrouillage, sans vis apparentes, ce qui permet une disposition libre et facilement modifiable dans le temps.

Cover freestanding es la versión autoportante del sistema Cover, equipada por lo tanto de paneles laterales y paneles traseros para permitir la definición de composiciones lineales o en ángulo, siempre a medida. El perfecto acabado de los paneles traseros y del interior de las puertas hacen de Cover freestanding un sistema ideal también para soluciones entre paredes, completo de hueco de pasos para acceder a vestidores o áreas de servicio. Los elementos accesorios internos se fijan a los montantes con un sistema de enganche, sin tornillos visibles, que permite una disposición libre y modificable en el tiempo con extrema facilidad.

Struttura Structure: 83 piombo
Vetro Glass: 63 grigio trasparente
Basamento e top Floor base and top: 09 melaminico rovere grigio
Accessori estraibili Pull out accessories: 154 argilla



In alluminio e vetro, completamente autoportante, Cover freestanding rappresenta la naturale evoluzione del sistema Cover. Liberamente componibile e adattabile agli spazi con la massima precisione grazie al servizio su misura, Cover freestanding rappresenta un concentrato di innovazione tecnologica e funzionale, una soluzione evoluta alle esigenze progettuali degli spazi contemporanei. L'organizzazione dello spazio interno è risolto con una serie di componenti e soluzioni che associano essenzialità del design, massima praticità e ricercatezza.

In aluminium and glass, totally self-supporting, Cover freestanding represents the natural evolution of the Cover system. Completely modular and adaptable to spaces with a maximum precision, thanks to its customization, Cover freestanding is a concentrate of technological and functional innovation, a solution evolved to the needs of the contemporary spaces. The organization of the interior space is achieved through different accessories and possible solutions, combining essential design, maximum practicality and refinement.

Aus Aluminium und Glas, vollständig selbsttragende, Cover freestanding stellt die natürliche Entwicklung des Systems Cover dar. Frei modular und immer nach Mass passt sich Cover massgenau an jeden Raum, dank der maßgeschneiderten Service, mit der Verbindung der technologischen Innovation und Funktionalität, um Lösungen fuer jeden modernen Wohnbereich anzubieten. Die Organisation des Innenraums ist mit einem ausreichenden Wahl von Zubehoeren geloest mit der Verbindung von wesentlichen Design, maximale Funktionalität und Finesse.

En aluminium et verre, entièrement auto-portante, Cover freestanding représente l'évolution naturelle du système Cover. Librement modulables et adaptables aux différents espaces avec une précision maximale grâce au sur mesure, Cover freestanding représente une concentration de l'innovation technologique et fonctionnelle, une solution sophistiquée pour les exigences de conception des espaces contemporains. L'organisation de l'espace intérieur est résolu avec un ensemble d'accessoires et de solutions, qui combinent le design essentiel, une forte fonctionnalité et style recherché.

Aluminio y vidrio, Cover freestanding es totalmente auto-portante y representa la natural evolución del sistema Cover. Libremente componible y adaptable a los espacios con la máxima precisión gracias al servicio de personalización a medida, Cover freestanding es un concentrado de la innovación tecnológica y funcional, una solución evolucionada para necesidades de proyecto de los espacios contemporáneos. La organización del espacio interior se resuelve con un conjunto de componentes y soluciones que combinan un diseño esencial a la máxima practicidad y sofisticación.



Struttura Structure: 83 piombo
Vetro Glass: 63 grigio trasparente
Basamento e top Floor base and top: 09 melaminico rovere grigio
Mensole Shelves: 63 grigio trasparente
Accessori estraibili Pull out accessories: 154 similpelle argilla



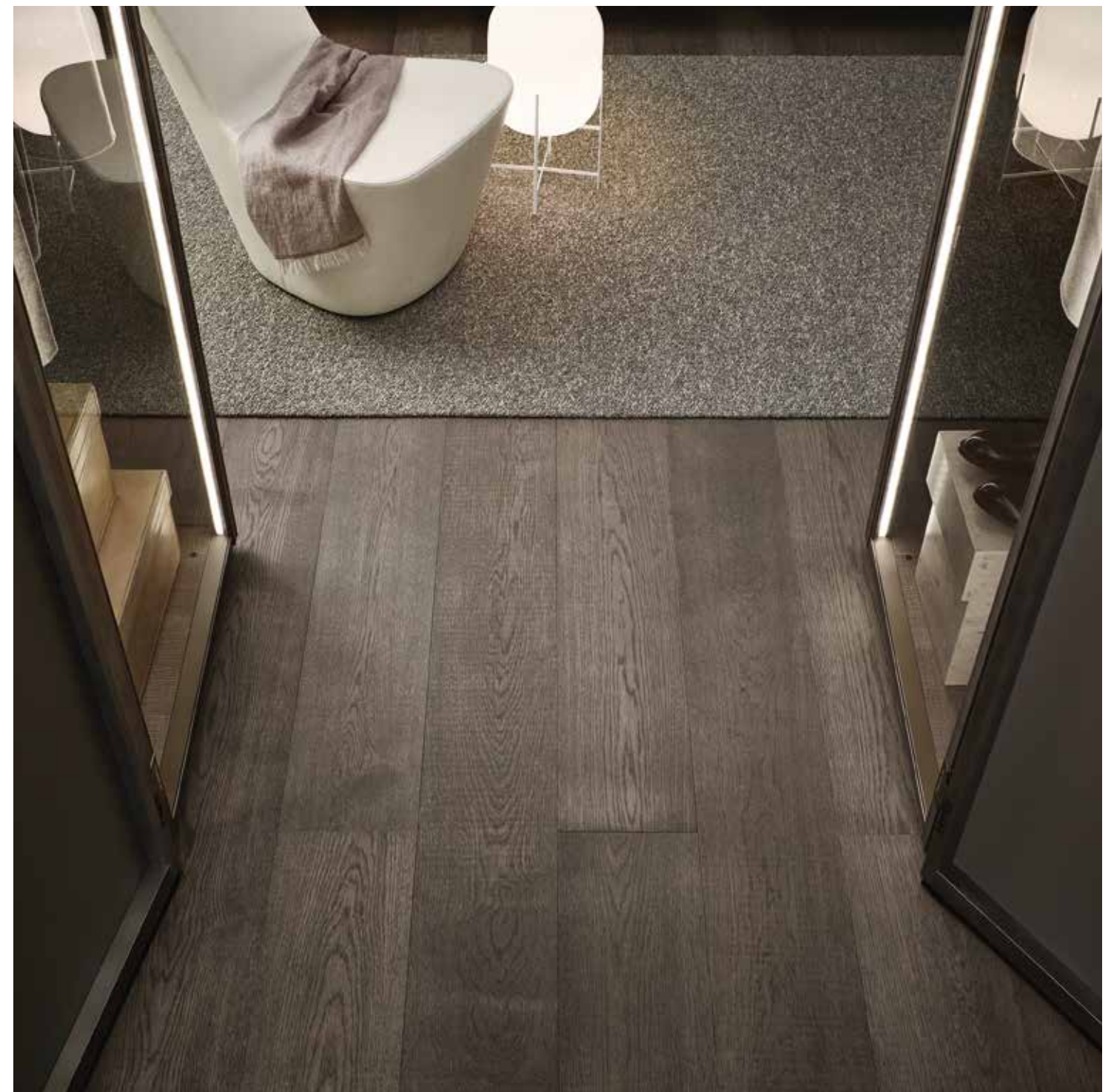

Un sistema armadio di ultima generazione, nel quale tutti i componenti, dalle ante agli accessori, dalla struttura ai complementi, sono realizzati su misura grazie a un sistema di produzione "custom-made". La tecnologia utilizzata permette di creare una composizione caratterizzata da un vano di passaggio dedicato, che consente di accedere alla cabina armadio vera e propria transitando attraverso la quinta architettonica che rappresenta il fronte principale sulla zona notte.

A storage system of the latest generation, in which all components are custom made, from the doors to the accessories, from the structure to complements. The advanced technology allows to create a composition with a passageway, with direct access to the real walk-in closet, through the architectural backdrop, which is the main front of the night area.

Ein modernes Schrankssystem, welches Komponenten, von Tueren bis zu Zubehoeren, von der Struktur bis zu Komplementen, in Sondermasse produziert werden, danke zu einem "custom-made" Verarbeitungssystem. Cover freestanding Technologie erlaubt Oeffnungspassage umzubauen, wie eine architektonische Kulisse, durch die kann man direkt auf den Schlafbereich eintreten.

Un système armoire de nouvelle génération, dans lequel tous les composants, des portes aux accessoires, de la structure aux compléments, sont toujours réalisés "sur mesure". La technologie avancée permet de créer une composition caractérisée par un passage, qui donne accès au dressing, à travers la toile architecturale, qui est le front principal sur la zone nuit.

Un sistema de armario de ultima generación, en el que todos los componentes, de las puertas a los accesorios, de la estructura a los accesorios, están realizados a medida gracias a un sistema de producción "custom-made". La tecnología permite crear una composición caracterizada por un hueco de paso dedicado, que facilita el acceso al vestidor a través del marco arquitectónico que representa el frente principal de la zona de noche.



Struttura *Structure*: 83 piombo
 Ante *Doors*: 104 grigio ombra opaco
 Fianchi intermedi di passaggio e schienale *Side panels for passage opening and back panels*: 63 grigio trasparente
 Basamento, top e mensole *Floor base, top and shelves*: 09 melaminico rovere grigio
 Mensole *Shelves*: 09 melaminico rovere grigio
 Accessori *Accessories*: 154 similpelle argilla

La cassetiera sospesa a due cassetti è ancorata esclusivamente ai montanti strutturali delle ante. Il piano superiore è realizzato con un profilo continuo in alluminio, realizzato con la tecnologia esclusiva "folding" nel quale si inserisce il top per un'estrema pulizia formale. I cassetti sono dotati di guide push ad estrazione totale di ultima generazione per una perfetta funzionalità.

The suspended drawer unit with two drawers is only fixed to the uprights of the doors. The upper top is made of a continuous aluminium profile, created with the exclusive "folding" technology, in which the top is inserted with extremely clean design. The drawers are equipped with push opening and total extraction runners of the latest generation for a perfect functionality.

Abgehaengtes Schubladenelement ist direkt zu strukturellen Pfosten den Tueren verbindet. Die Abdeckungsplatte besteht aus einem Profil aus Aluminium, realisiert dank zur "Folding" Verarbeitung, die erlaeubt eine extreme formliche Sauberkeit. Schubladen sind mit push-Voellaufzuegen ausgestattet um eine perfekte Funktionalitaet zu erreichen.

Le bloc tiroir suspendu avec deux tiroirs n'est fixé qu'aux montants des portes. Le plateau supérieur est constitué d'un profil continu en aluminium, réalisé avec la technologie exclusive "folding", dans lequel le plateau est fixé avec un résultat extrêmement propre. Les tiroirs sont équipés avec des guides avec ouverture à pression et avec extraction totale de la dernière génération pour une fonctionnalité parfaite.

La cajónera colgante a dos cajones está anclada exclusivamente a los montantes estructurales de las puertas. La planta superior está realizada con un perfil continuo en aluminio, creado con la tecnología exclusiva "folding" en la que se inserta el top para una limpieza estética extrema. Los cajones están equipados con guías push a extracción total de última generación para la funcionalidad perfecta.





Un sistema dalla componibilità infinita. L'evoluta tecnologia costruttiva declinata in 20 profili specifici in alluminio estruso e da un infinito numero di accessori e di giunzioni meccaniche, permette di soddisfare qualsiasi esigenza progettuale: dalla "teca" freestanding trasparente, alla composizione ad angolo, dall'interparete con vano di passaggio, alla composizione in nicchia. Senza dimenticare l'assoluta personalizzazione dello spazio interno.

I montanti anteriori e posteriori sono dotati di sistema di illuminazione a led integrato opzionale, controllato da una centralina elettronica.

A system with infinite modularity. The advanced construction technology declined in 20 specific profiles of extruded aluminium and an infinite number of accessories and mechanical joints, allow to meet any project requirements: from the freestanding transparent "cabinet" to the corner composition, to the composition with a passage or in niche. Not to mention the absolute personalization of the interior space. Front and back uprights are provided with optional integrated led lighting system, managed from an electrical junction box.

Modularität ohne Ende. Die entwickelte strukturelle Technologie, die besteht aus 20 verschiedenen bestimmten extrudierten Profilen aus Aluminium, unendlichen Zubehören und mechanischen Gelenken, erlaubt jede einzelne Planungsmöglichkeit zu erfüllen: vom transparentem freestanding "Schaukasten" bis zu eckigen Anlagen, Kompositionen zwischen Wänden und auf einer Nische, ohne die Personalisierung der Räume zu vergessen. Frontale und hinteres Pfosten mit optionaler, integrierter Led Beleuchtung, die durch Elektro Speiseleistung kontrolliert wird.

Un système avec une modularité infinie. La technologie de production avancée, avec 20 profils spécifiques en extrusion d'aluminium et un nombre infini d'accessoires et de joints mécaniques, peut satisfaire toutes les exigences du projet: de la "composition" freestanding totalement transparente, à celle en angle, à la composition avec un passage, à celle dans une niche. Sans oublier la personnalisation absolue de l'espace intérieur. Les montants antérieurs et arrières sont équipés avec un système d'éclairage led optionnel et intégré, commandé par une unité électronique de commande.

Un sistema de modularidad infinita. La avanzada tecnología de construcción declinada en 20 perfiles específicos de aluminio extruido y un número infinito de accesorios y juntas mecánicas, permite poder satisfacer cualquier requisito del proyecto: de la "vitrina" freestanding transparente a la composición angular de la versión entre paredes con hueco de paso, a la composición en luz. Por no hablar de la personalización absoluta del espacio interior. Los montantes delanteros y traseros están equipados con sistema de iluminación opcional led integrado, controlado por una unidad electrónica de control.

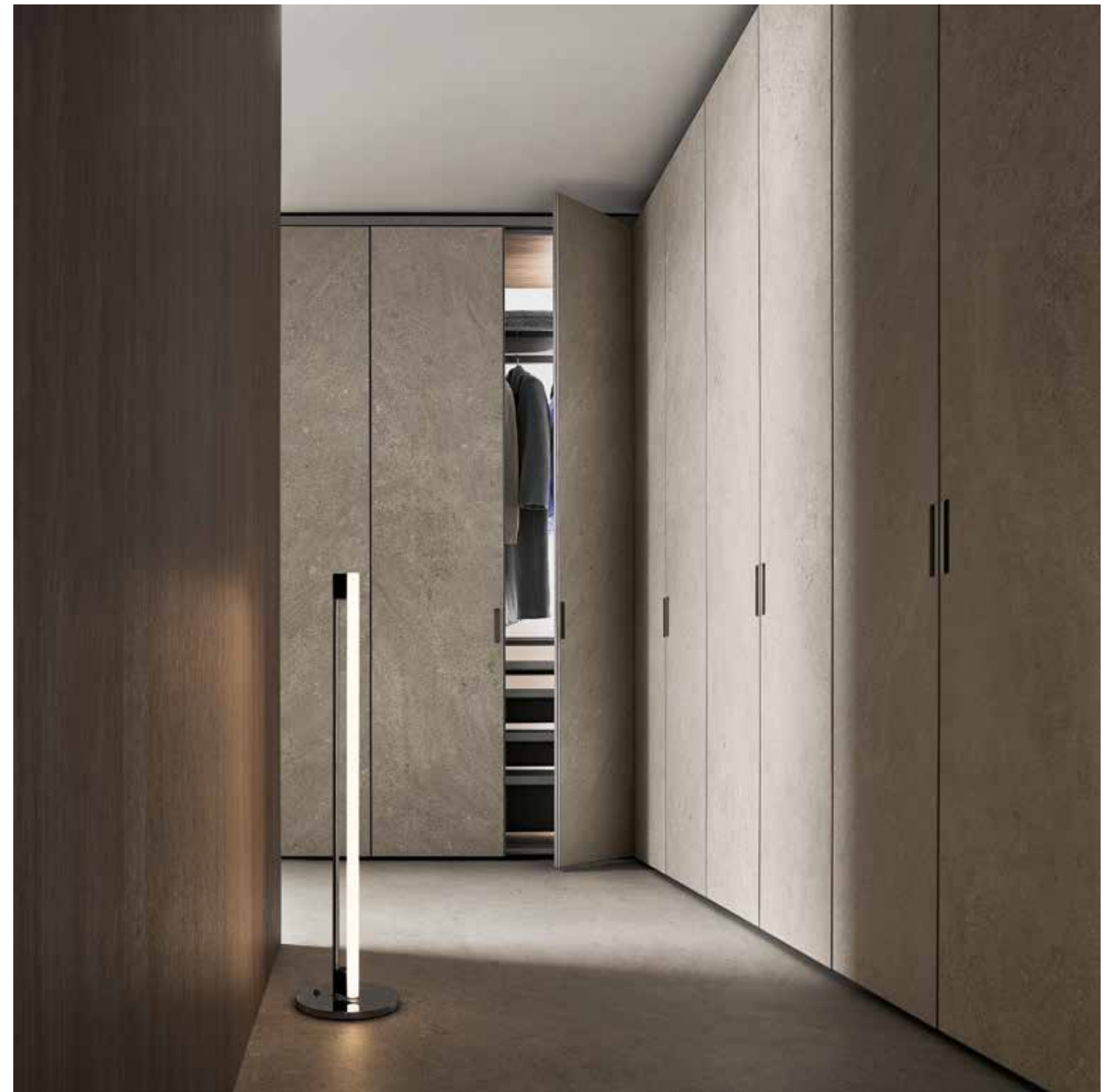

Completamente autoportante, Cover freestanding rappresenta la naturale evoluzione del sistema Cover. Liberamente componibile e adattabile agli spazi con la massima precisione grazie al servizio su misura, Cover freestanding rappresenta un concentrato di innovazione tecnologica e funzionale, una soluzione evoluta alle esigenze progettuali degli spazi contemporanei. L'organizzazione dello spazio interno è risolto con una serie di componenti e soluzioni che associano essenzialità del design, massima praticità e ricercatezza.

Totally self-supporting, Cover freestanding represents the natural evolution of the Cover system. Completely modular and adaptable to spaces with a maximum precision, thanks to its customization, Cover freestanding is a concentrate of technological and functional innovation, a solution evolved to the needs of the contemporary spaces. The organization of the interior space is achieved through different accessories and possible solutions, combining essential design, maximum practicality and refinement.

Vollständig selbsttragende, Cover freestanding stellt die natürliche Entwicklung des Systems Cover dar. Frei modular und immer nach Mass passt sich Cover massgenau an jeden Raum, dank der maßgeschneiderten Service, mit der Verbindung der technologischen Innovation und Funktionalität, um Lösungen fuer jeden modernen Wohnbereich anzubieten. Die Organisation des Innenraums ist mit einem ausreichenden Wahl von Zubehoeren geloeset mit der Verbindung von wesentlichen Design, maximale Funktionalität und Finesse.

Entièrement auto-portante, Cover freestanding représente l'évolution naturelle du système Cover. Librement modulables et adaptables aux différents espaces avec une précision maximale grâce au sur mesure, Cover freestanding représente une concentration de l'innovation technologique et fonctionnelle, une solution sophistiquée pour les exigences de conception des espaces contemporains. L'organisation de l'espace intérieur est résolu avec un ensemble d'accessoires et de solutions, qui combinent le design essentiel, une forte fonctionnalité et style recherché.

Cover freestanding es totalmente autoportante y representa la natural evolución del sistema Cover. Libremente componible y adaptable a los espacios con la máxima precisión gracias al servicio de personalización a medida, Cover freestanding es un concentrado de la innovación tecnológica y funcional, una solución evolucionada para necesidades de proyecto de los espacios contemporáneos. La organización del espacio interior se resuelve con un conjunto de componentes y soluciones que combinan un diseño esencial a la máxima practicidad y sofisticación.



Le finiture ricercate, i colori di tendenza, la perfezione degli accessori: Cover freestanding è un progetto coordinato a 360° nel quale ogni elemento della composizione concorre alla definizione di un insieme omogeneo, raffinato, elegante. La struttura in alluminio è disponibile in sei finiture (alluminio, nero, brown, piombo, platino e bronzo), le ante in vetro temperato nelle 70 tonalità lucide e opache della gamma Ecolorsystem, nei 4 vetri reflex e in tutti i vetri trasparenti, acidati, riflettenti, e specchio oltre alle due finiture gres crema e moka, per un totale di 87 finiture.

The sophisticated finishes, the trendy colors, the perfection of accessories: Cover freestanding is a coordinated project at 360°, in which each element of the composition contributes to define a homogeneous, refined, elegant system. The aluminum structure is available in six finishes (aluminum, black, brown, piombo, platino and bronzo), the tempered glass doors in the 70 glossy and mat colours of the Ecolorsystem range, in the 4 reflex glasses, in all transparent, etched glasses, reflective and mirror glasses, in addition to the two finishes crema and moka porcelain, for a total of 87 finishes.

Gewählte Ausführungen, trendige Farben und Perfektion den Zubehöeren: Cover freestanding ist einer Projekt auf 360°, welchen Elementen bauen eine homogene, elegante und raffinierte Gesamtheit um. Die Struktur aus Aluminium ist in sechs Ausführungen verfügbar (Alluminio, nero, brown, piombo, platino und bronzo). Flügeltuer sind in 70 Ecolorsystem matt, hochglanz, 4 reflex und allen transparenten, satinierten und verspiegelten Glassausführungen verfügbar, ausser Gres Crema und Moka, um insgesamt 87 verfügbaren Ausführungen anbieten zu koennen.

Les finitions sophistiquées, les couleurs de tendance, la perfection des accessoires: Cover freestanding est un projet coordonné à 360°, dans lequel chaque élément de la composition contribue à la définition d'un ensemble homogène, raffiné et élégant. La structure en aluminium est disponible en six finitions (aluminium, noir, brown, piombo, platino et bronzo), les portes en verre trempé dans 70 teintes brillantes et mates de la gamme Ecolorsystem, dans les 4 verres réflex, dans tous les verres transparents, acidés, réfléchissant et miroir, en plus des deux finitions grès crème et moka, pour un total de 87 finitions.

Los acabados sofisticados, los colores de moda, la perfección de los accesorios: Cover freestanding es un proyecto coordinado a 360° en el que cada elemento de la composición contribuye a la definición de un conjunto homogéneo, refinado, elegante. La estructura de aluminio está disponible en seis acabados (aluminio, negro, brown, piombo, platino y bronzo), las puertas de vidrio templado en los 70 tonos brillantes y mate de la gama Ecolorsystem, en los 4 vidrios reflex, en todos los cristales transparentes, acidados, reflectantes y espejo, además de los dos acabados Gres crema y Moka, por un total de 87 acabados.



Struttura Structure: 304 platino
Schienali Back panels: 02 acidato extrachiaro
Top, basamento Floor base and top: 07 melaminico olmo
Mensole e accessori estraibili Shelves and pull out accessories: 154 similpelle argilla

Concezione progettuale
The design concept



Le alte prestazioni di Cover freestanding nascono da una struttura in alluminio tecnologicamente innovativa. I montanti, su cui si regolano le ante ospitano l'illuminazione a led. Il sistema prevede la versione freestanding, con lato posteriore e fianchi completamente rifiniti, oppure la versione interparete, con fasce di aggiustaggio opzionali superiori e laterali, per chiudere gli eventuali fuori squadra delle pareti. Le ante battenti sono dotate di chiusura magnetica e maniglie incassate a filo, con un'esclusiva serratura opzionale frutto di un progetto innovativo dedicato. Il basamento e il top sono realizzati sempre in melaminico, disponibile in finitura larice carbone, rovere grigio e olmo.

The high performances of Cover freestanding comes from a technological advanced aluminium structure. The uprights, on which the doors are adjusted, conceal the led lighting. The system provides the freestanding version, with sides and back panels completely well finished, or the version between the walls, with optional adjusting fillers for both sides and top, to close eventual differences in the wall. The hinged doors are equipped with magnetic closing device. The handles are recessed, with an optional exclusive lock, result of a dedicated innovative project. The floor base and the top are always in melamine, available in coal larch, gray oak and elm finishing.

Der hohe Leistungsumfang des Cover Freestanding ergibt sich aus einer technologisch innovativen Aluminiumstruktur. Die Stände, auf dem die Platten angepasst werden, verfügen über eine Led-Beleuchtung. Das System sieht die Version freestanding mit vollständig geschlossenen Rückseiten und Seiten vor. Alternativ gibt es die Ausführung "interparete", mit optionaler obiger und seitlicher Einstellung der Wände. Die Drehtüren haben ein magnetischen Schliessmechanismus und eingelassene Griffe. Optionell ist das Schloss. Basisboden und Abdeckplatte sind immer in Melamin Kohlaerche, Eiche grau oder Ulme.

Les hautes performances de Cover freestanding proviennent d'une structure en aluminium technologiquement innovante. L'éclairage led peut être installé sur les montants, qui régulent les portes. Le système est disponible en version freestanding avec l'arrière et les côtés complètement finis, ou en version entre murs avec fileurs lateraux et supérieurs optionnels, pour fermer les différences d'épaisseur de parois. Les portes battantes sont équipées avec fermeture magnétique et les poignées encastrées à fleur avec une serrure en option, résultat d'un projet exclusive innovant dédié. La base au sol et le top sont toujours en mélamine, disponible en finition mélèze carbon, chêne gris et orme.

El alto rendimiento de Cover freestanding surgen de una estructura en aluminio tecnológicamente innovadora. Los montantes en los cuales se ajustan las puertas acomodan una iluminación por leds. El sistema prevé la versión freestanding, con parte trasera y paneles laterales completamente acabados, o la versión interpared, con bandas de ajuste opcionales superiores y laterales, para cerrar cualquier descuadre de las paredes. Las puertas batientes están dotadas de un cierre magnético y manetas empotradas a ras, con una exclusiva cerradura opcional resultado de un proyecto innovador dedicado. La base y el top se hacen siempre en melamina, están disponibles en acabado alerce carbón, roble gris y olmo.

Caratteristiche tecniche esclusive
Exclusive technical features

Sistema di fissaggio degli accessori
Accessories fixing system



Tutti gli accessori vengono fissati ai montanti con un sistema ad incastro, senza viti a vista, e la disposizione può essere modificata e variata nel tempo con estrema facilità. All the elements are fixed directly to the uprights, without visible screws, and the layout can be modified any time in an easy way.

Maniglie
Handles

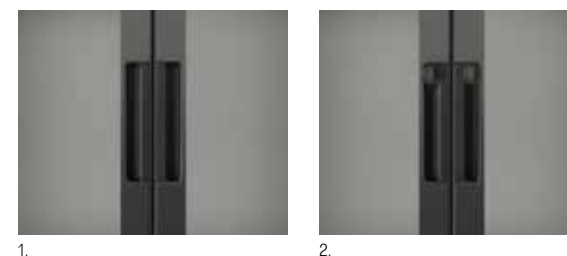

1. 2013 maniglia in pressofusione di zama incassata a filo struttura. / Die-casting aluminium handle.
2. 2014F / 2014C maniglia in pressofusione di zama con serratura e chiave. Die-casting aluminium handle with lock and key.

Tipologie compositive
Different compositions

Centro stanza
Middle room

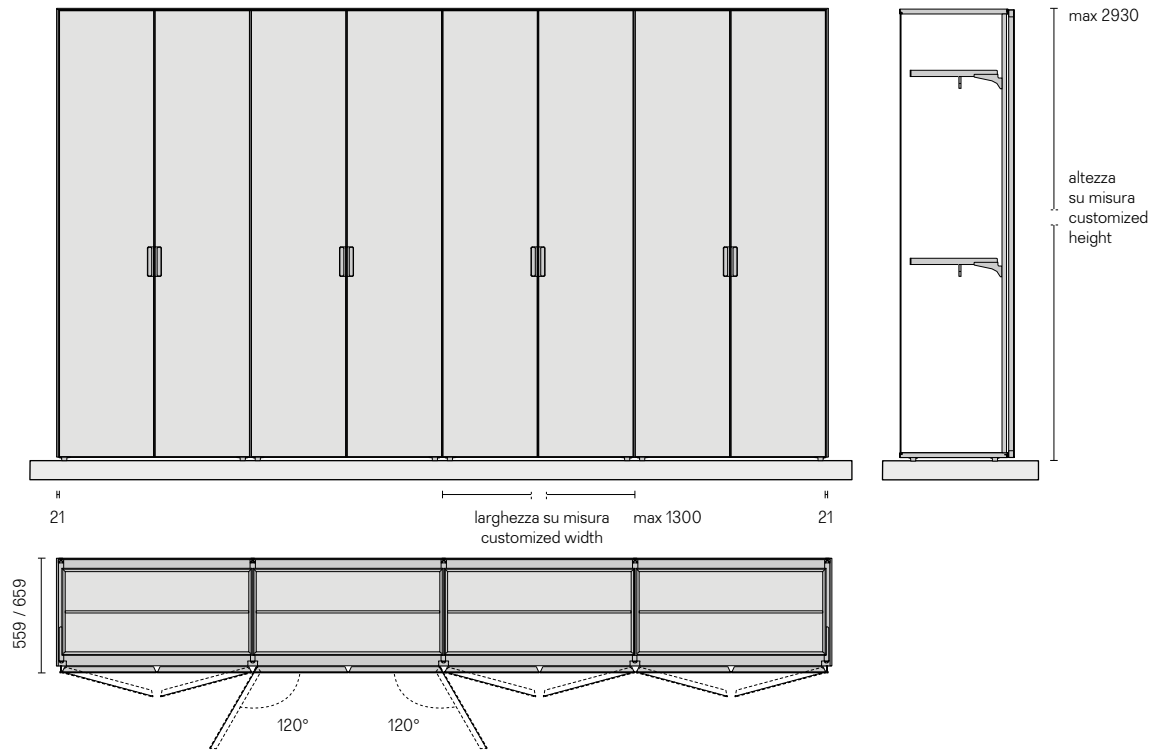

Interparete
Niche

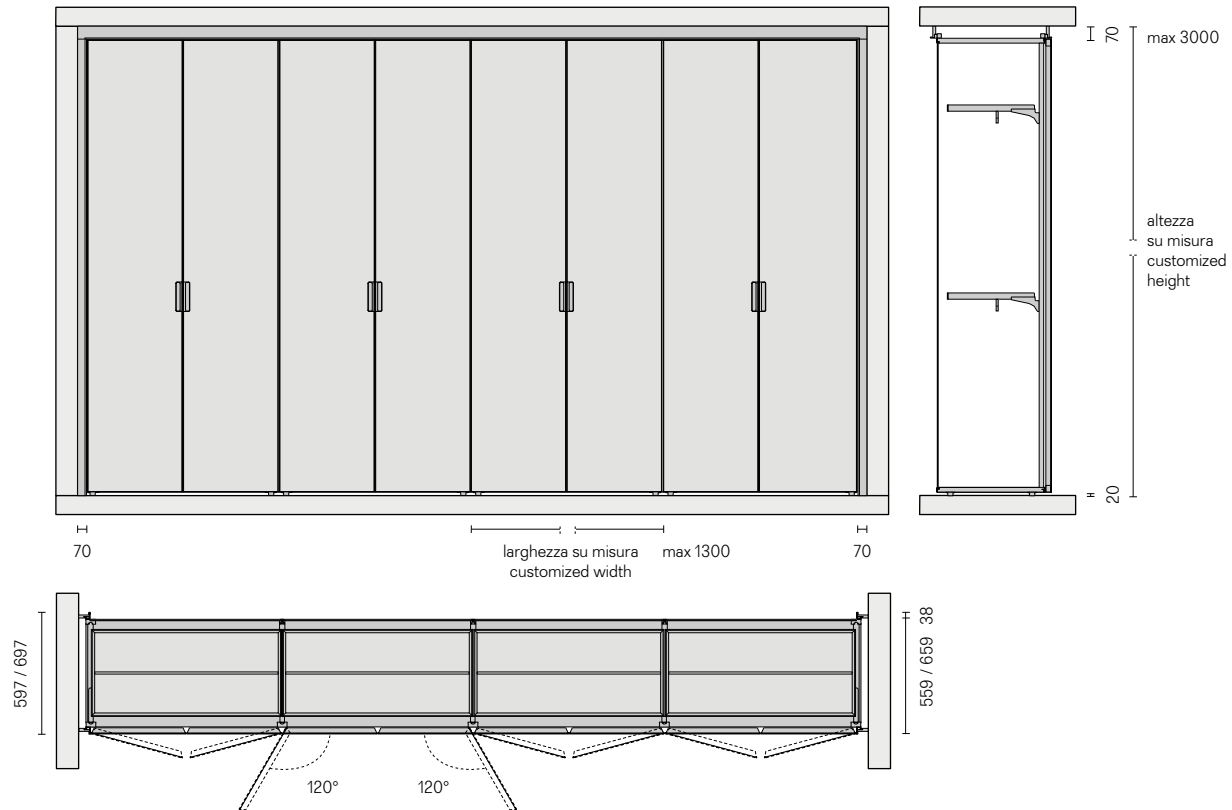

Possibilità di utilizzo
Possible compositions

Composizione centro stanza
Freestanding composition

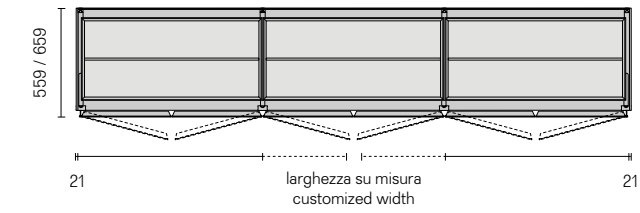

Composizione interparete
Composition next to the wall

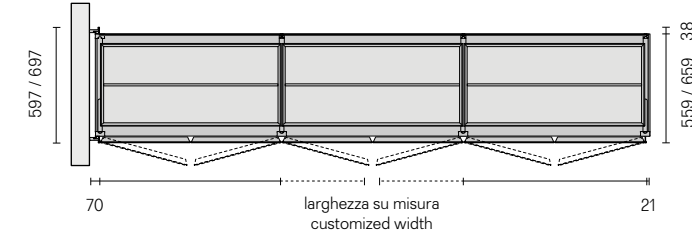

Composizione interparete con vano di passaggio
Niche composition with through-way

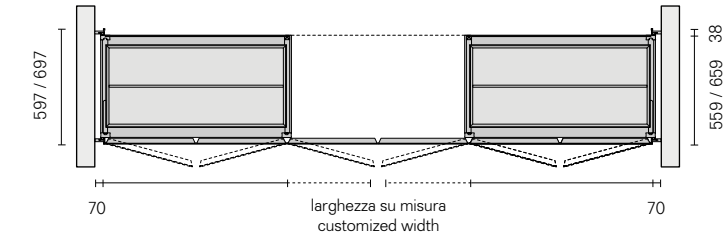

Composizione interparete con vano di passaggio e ante contrapposte
Niche composition with through-way and counterposed doors

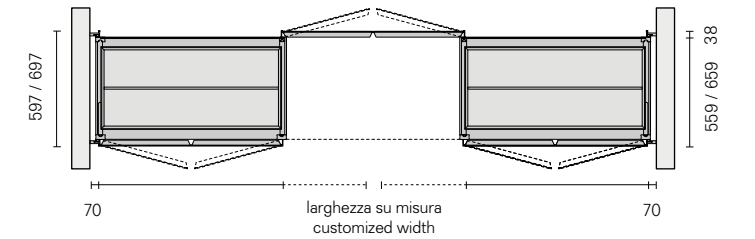

Composizione interparete con vano di passaggio laterale
Composition in niche with side through-way

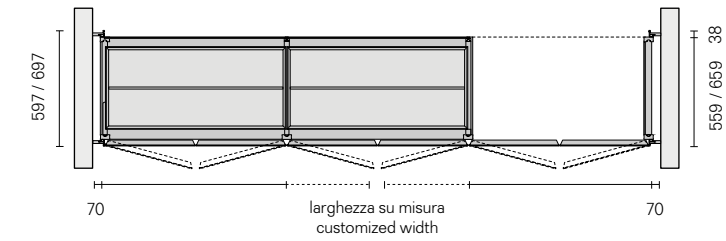

Composizione interparete con vano di passaggio laterale e ante contrapposte
Composition in niche with through-way and counterposed doors

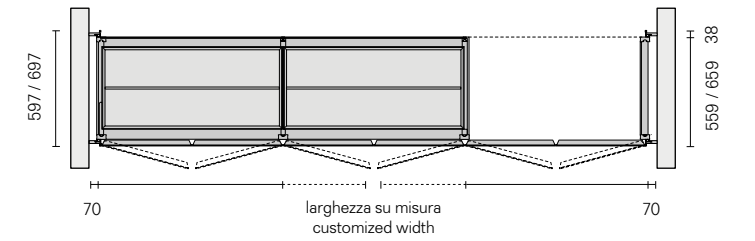

Composizione ad angolo
Corner composition

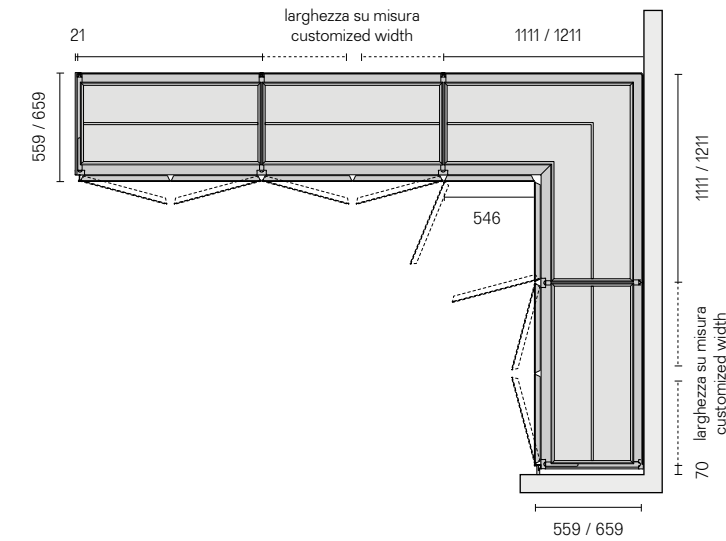

Composizione a c
C shaped composition

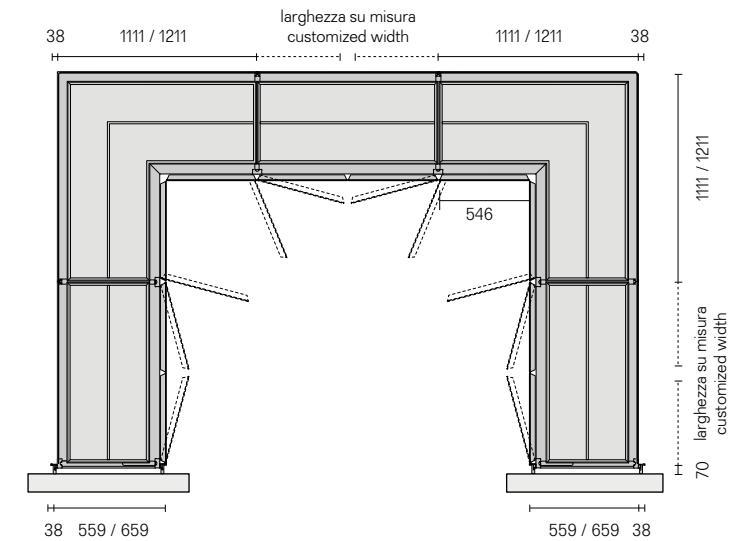

Modularità e componenti
Modular structure and components

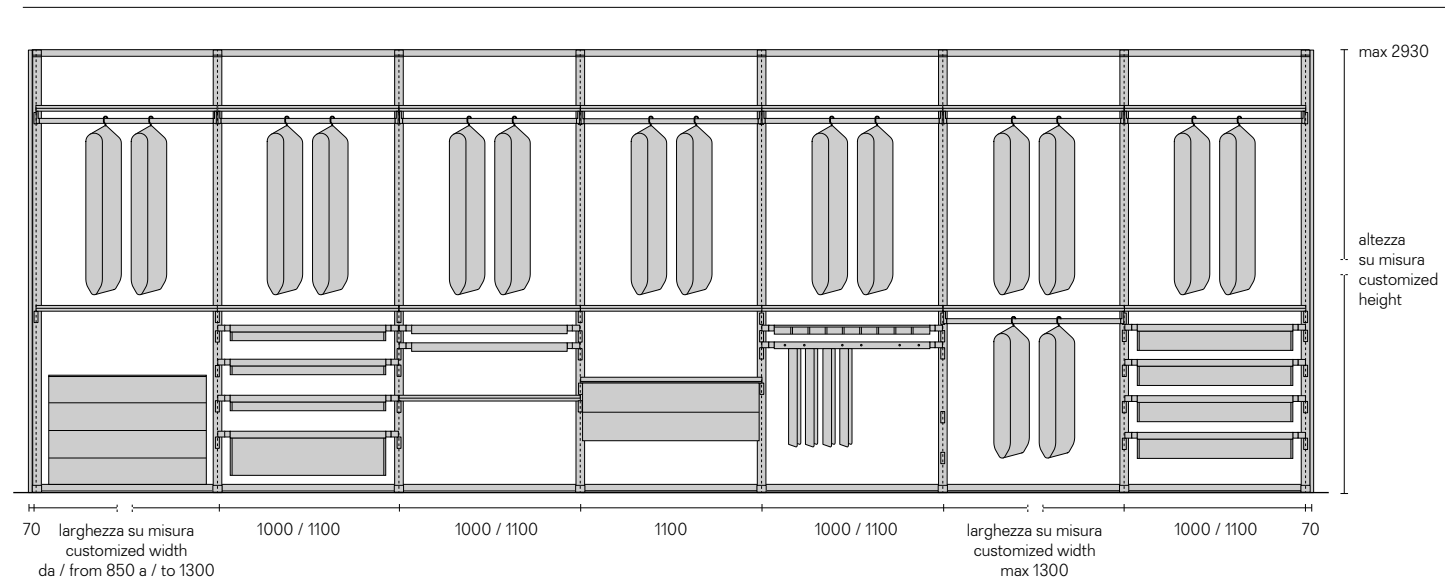

Anta battente con struttura in estruso d'alluminio, vetro singolo frontale temperato o gres spessore 4 mm. Chiusura con chiave opzionale / Panel door with hinged opening, structure in extruded aluminium, single tempered glass or gres front thickness 4 mm. Key lock on request

Fianco finale sp 48 mm, fianco intermedio sp 53 mm e fianco di passaggio sp 53 mm. Illuminazione a led opzionale anteriore e posteriore / Closing side panel thickness 48 mm, intermediate side panel thickness 53 mm and side panel for through-way thickness 53 mm. Optional front and rear led lighting system

Basamento e top in melaminico / Floor base and top in melamine

Schienale in vetro temperato spessore 6 mm, disponibile nei vetri laccati, trasparenti e satinati / Back panel in tempered glass thickness 6 mm, available in lacquered, transparent and satinated glass

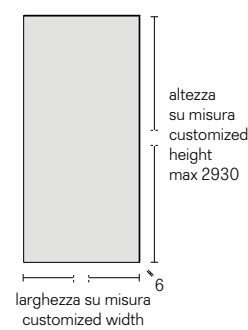
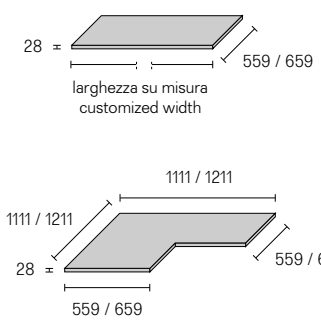
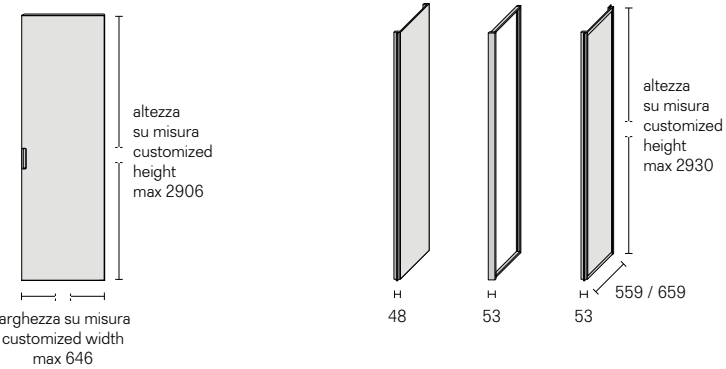

Componenti
Components

Ripiano estraibile con vaschetta in similpelle / Pull out shelf with tray in synthetic leather finishing

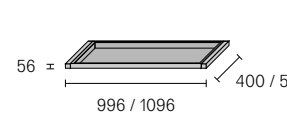

Contenitore in essenza di noce / Walnut veneered organizer

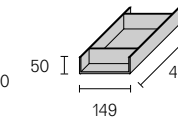

Separatore doppio / Organizer with double partition

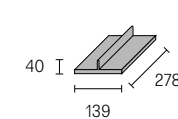

Porta orologi / Watch holder

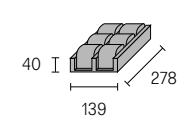

Vaschetta concava e vaschetta con fessure / Concave box and box with jewels slots

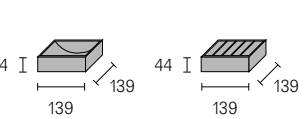

Ripiano estraibile con portapantaloni e vani per cinture in similpelle / Pull out shelf with trousers rack and belts tray in synthetic leather finishing

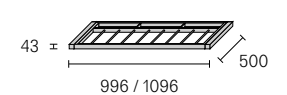

Ripiano estraibile portacravatte in similpelle / Pull out shelf with tie rack in synthetic leather finishing

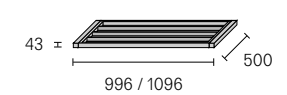

Ripiano estraibile portascarpe in similpelle / Pull out shelf with shoe rack in synthetic leather finishing

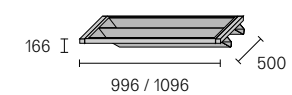

Ripiano estraibile con organizer in similpelle / Pull out shelf with organizer tray in synthetic leather finishing

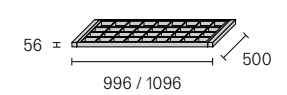

Cesto basso estraibile in similpelle / Pull out small tray in synthetic leather finishing

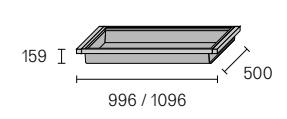

Cesto alto estraibile in similpelle / Pull out big tray in synthetic leather finishing

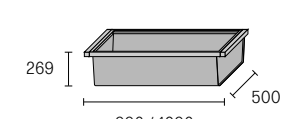

Cesta e vassoio in similpelle / Synthetic leather box and tray

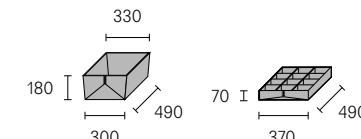

Mensola in melaminico con profilo posteriore in alluminio / Melamine shelf with rear aluminium profile

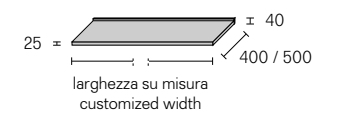

Mensola in vetro con ring in alluminio e top opzionale in similpelle / Glass shelf with aluminium ring and optional top in synthetic leather finishing

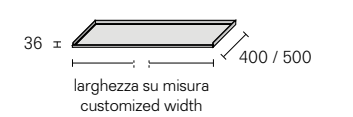

Asta portabiti per mensola e sottotop con rivestimento opzionale in similpelle / Cloth hanger for shelf and undertop with optional cover in synthetic leather

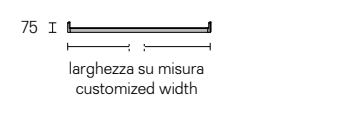

Fasce di aggiustaggio laterali e superiori, anteriori e posteriori / Lateral and upper, front and back fillers

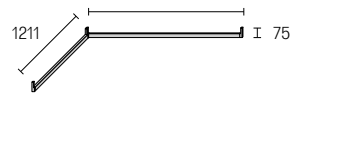
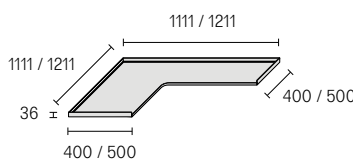
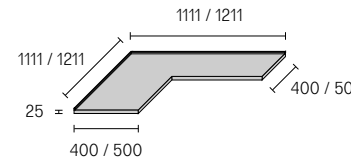
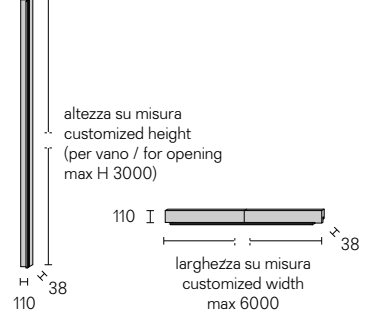

Cassettiera sospesa in legno laccato o melaminico, top in specchio grigio / Top opzionale in similpelle. / Suspended drawer unit in lacquered wood or melamine, top in gray mirror. Optional top in synthetic leather

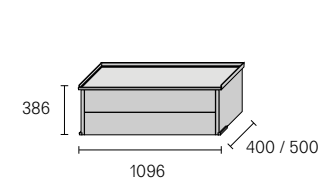

Cassettiera per basamento. In melaminico con tre cassetti, in vetro laccato o in melaminico con quattro cassetti / Drawer unit on floor base. In melamine with three drawers, in lacquered glass or in melamine with four drawers

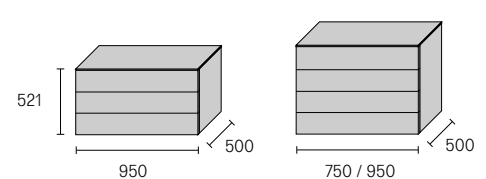

Top opzionale in melaminico larice carbone con fondo rivestito in similpelle, per cassetteria su basamento / Optional top in coal larch melamine with bottom part covered with synthetic leather, for drawer units on floor base

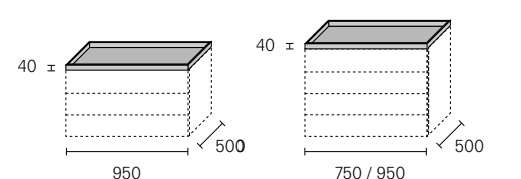

Finiture
Finishings

Struttura e accessori
Structure and accessories

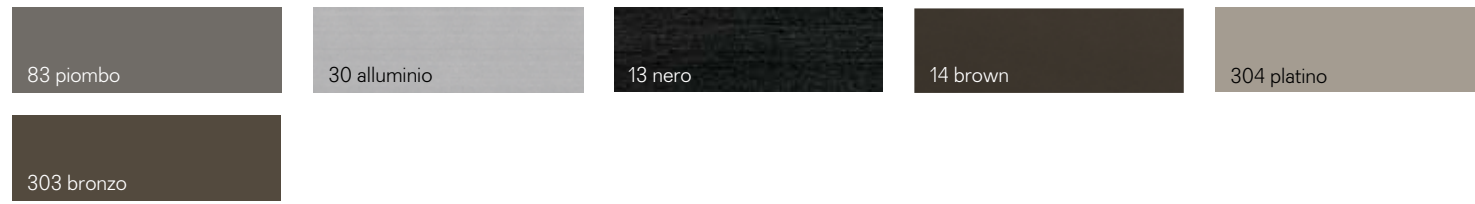

Fascia di aggiustaggio
Filler



Basamento e top
Floor base and top



Ripiano estraibile e rivestimento asta portabiti
Pull out shelf and cloth hanger bar



Fianco e schienale
Side and back panel



Cassettiera
Drawer unit

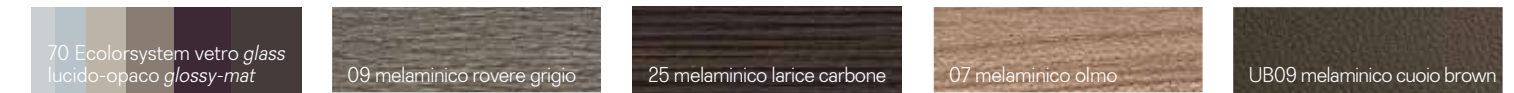

Interno cassettiera
Internal drawer unit

Cassettiera sospesa
Suspended drawer unit



Mensola
Shelf



Anta
Door



Walk-in closets

74 Dress bold, 100 Zenit, 128 Abacus



Design Giuseppe Bavuso

Dress bold

Dress bold is a system that creates highly personalized walk-in closets with the option of customized compositions for linear, corner and C-shaped solutions. Two aesthetic possibilities: with visible uprights or with back panels available in glossy or mat glass, fabric, wood, mirror and provided with optional upper led lighting. The accessories, which can be freely placed along the wall upright by means of a patented expansion fixing system that requires no holes, include: shelves and floor bases, cloth hangers, cloth lift, drawer units, trouser racks and pull out trays.

Dress bold è un sistema per creare cabine armadio personalizzabili al massimo grado, con possibilità di composizioni su misura in soluzioni lineari, ad angolo e a C. Due le possibilità estetiche: con i montanti a vista o con pannelli a parete, disponibili in vetro laccato lucido o opaco, tessuto, legno, specchio, e dotati di illuminazione a led superiore opzionale. Gli accessori, liberamente posizionabili lungo il montante a parete, grazie al sistema brevettato di fissaggio ad espansione senza fori, comprendono: mensole e basamenti, aste portabiti, appendiabiti inclinabile, cassettiere, portapantaloni e vassoi estraibili.

Das System Dress bold wurde für Schrankzimmer mit maximaler individueller Gestaltbarkeit entwickelt und bietet maßgeschneiderte Kombinationsmöglichkeiten für Reihen-, Eck- oder C-Anordnung. Hier sind zwei Gestaltungsmöglichkeiten gezeigt: entweder mit sichtbaren Pfosten oder mit Wandpaneelen, erhältlich in glänzendem oder mattem Glas, aus Holz, aus Spiegel und optional mit oberer Led-Beleuchtung. Das umfangreiche Zubehör lässt sich dank eines patentierten Spreizbefestigungssystems ohne Bohrungen beliebig am Wandträger anbringen und besteht aus: Regalböden und Sockelelementen, Kleiderstangen, Kleiderlift, Schubladen, Hosenhaltern und Ablageflächen in ausziehbarer Ausführung.

Dress bold est un système pour créer des dressings personnalisables avec une possibilité de compositions sur mesure en solutions linéaires, d'angle ou en forme de C. Les deux possibilités esthétiques: avec montants visibles ou avec des panneaux de fond, disponibles en verre laqué brillant ou mat, tissu, bois, miroir, et équipés avec système d'éclairage led supérieur optionel. Les accessoires, positionnables librement sur le montant au mur, grâce au système breveté de fixation à expansion sans trous, comprennent: étagères et bases au sol, barres penderies, porte-manteaux inclinable, blocs tiroirs, porte-pantalons et plateaux extractible.

Dress bold es un sistema para crear vestidores personalizables de alto nivel, con posibilidad de efectuar composiciones a medida mediante soluciones lineares, angulares y en forma de C. Ambas posibilidades estéticas: con montantes visibles o con paneles de pared, disponibles en vidrio lacado brillante o mate, tejido, madera, espejo, y equipada con iluminación Led superior opcional. Los accesorios, que pueden colocarse libremente a lo largo del montante de pared, gracias al sistema patentado de fijación por expansión sin orificios, incluyen: estantes y bases, barras de colgar, barra de colgar reclinable, cajoneras, portapantalones y bandejas extraíbles.

Struttura Structure: 303 bronzo
 Schienali in tessuto Fabric back panels: T042 ruggine
 Basamento, ripiani e contenitori
 Floor base, shelves and cabinets: 07 melanimico olmo
 Aste portabiti e ripiani portascarpe
 Clothes hanging bars and shoe rack shelves: 153 similpelle castoro
 Ripiani e pannelli a parete con sistema di illuminazione led integrato
 Shelves and back panels with integrated led lighting system

Nella foto In this photo
 Pannelli scorrevoli
 Sliding doors: Velaria



Struttura Structure: 303 bronzo
 Schienali in tessuto Back panels fabric: T042 ruggine
 Basamento, ripiani e contenitori
 Floor base, shelves and cabinets: 07 melanimico olmo
 Aste portabiti e ripiani portascarpe
 Clothes hanging bars and shoe rack shelves: 153 similpelle castoro
 Ripiani e pannelli a parete con sistema di illuminazione led integrato
 Shelves and back panels with integrated led lightning system

Nella foto In this photo
 Pannelli scorrevoli Sliding doors: Velaria
 Settimanale Drawer unit: Self Bold
 Tavolino Coffee table: Planet
 Porta Door: Moon





Un progetto in continua evoluzione, uno spazio che si rivela nei suoi dettagli più caratteristici grazie anche al sistema di illuminazione in grado di esaltare ogni particolare, di dare forma alle superfici, di impreziosire le texture più ricercate. In Dress bold la luce gioca un ruolo fondamentale grazie a un sistema versatile e flessibile nel tempo. Il montante in alluminio è stato completamente riprogettato e dotato di una barra elettrificata che permette di alimentare i ripiani in legno tamburato, dotati di illuminazione led.

An evolving project, a space showing its most characteristic details thanks to the lighting system, thus able to improve every detail, to give shape to surfaces, to enhance the most refined textures. With Dress bold light plays an important role, thanks to a versatile and flexible system over the time. The aluminium upright has been completely redesigned and equipped with an electric bar, allowing the wiring of the wooden honeycomb shelves, equipped with led lighting.

Ein Projekt auf staendiger Entwicklung, Raeume, die sich durch charakteristischeren Details ausdruecken, danke zu dem Beleuchtung System auch, das jede Einzelheit erhoeht, Forme zu Oberflaechen gibt und prezioese Texture bereichert. Bei Dress bold das Licht spielt eine wichtige Rolle, danke zu einem im Zeitraum flexibelem und vielseitigem System. Pfosten aus Aluminium wuerde neu entwuerft und ausgestattet mit einer elektrischen Balken, die Holzwaben Tablare mit integrierter Led Beleuchtung versorgen.

Un projet en évolution, un espace qui se révèle dans ses détails les plus caractéristiques, grâce au système d'éclairage, qui permet d'amplifier chaque détail, de donner forme aux surfaces, d'enrichir les textures les plus recherchés. Dans le système Dress bold la lumière joue un rôle fondamental, grâce à un système polyvalent et flexible dans le temps. Le montant en aluminium a été complètement redessiné et équipé d'une barre électrique, qui permet l'alimentation des étagères en nid d'abeille, équipées d'un éclairage led.

Un proyecto en continua evolución, un espacio que se revela en sus detalles mas característicos gracias al sistema de iluminación capaz de exaltar cada detalle, dar forma a las superficies, embellecer las texturas más buscadas. En Dress bold la luz juega un papel fundamental gracias a un sistema versátil y flexible en el tiempo. El montante en aluminio ha sido completamente rediseñado y equipado con una barra eléctrica que permite alimentar los estantes con paneles en madera contrachapada, equipadas con iluminación led.



Un livello di illuminazione ideale, una personalizzazione dell'intensità luminosa e delle qualità della luce grazie all'utilizzo di sorgenti a led che possono essere posizionate sotto il basamento a terra, sotto la mensola e sotto i ripiani portascarpe, oppure nella parte superiore dello schienale con struttura in alluminio, disponibile in tessuto, legno, vetro laccato e specchio. Il ripiano portascarpe inclinato è dotato di un innesto rapido ed invisibile, senza viti né giunzioni a vista per una pulizia estetica assoluta.

An ideal level of lighting, a customized light intensity and light quality, thanks to the use of led sources, which can be positioned under the floor base, the shelf and the shoe shelves, or in the upper part of the back panel with aluminium frame, available in fabric, wood, lacquered glass and mirror. The sloping shoe shelf is equipped with a fast and invisible fixing device, without visible screws or joints for an extreme clean aesthetic.

Ein optimales Beleuchtung Niveau, Personalisierung der Lichtintensität und Qualität, dankte zu Led Energiequellen, die entweder unten Bodenbasis, Fachboden, Schuetraeger sich positionieren koennen, oder bei obener Seite der Rueckwand, die aus Stoffe, Holz, lackiertem Glas oder Spiegel erhaltbar ist. Der gekippter Schuetraeger ist mit rapider und unsiehbbarer Einrueckung ausgestattet, ohne siehbaren Schrauben, um eine absolute aesthetische Sauberkeit zu erreichen.

Un niveau idéal d'illumination, une personnalisation de l'intensité lumineuse et de la qualité de la lumière, grâce à l'utilisation de sources à led, qui peuvent être placés sous la base au sol, sous l'étagère et sous l'étagère porte chaussure, soit dans la partie supérieure du panneau de fond avec structure en aluminium, disponible en tissu, bois, verre laqué et miroir. L'étagère porte chaussure incliné est disponible avec une fixation rapide et invisible, sans vis ni joints visibles pour une esthétique propre.

Un nivel de iluminación ideal, una personalización de intensidad luminosa y de las calidades de la luz gracias a la utilización de fuentes de led que pueden ser colocadas debajo de la base en el suelo, debajo de estante y por debajo de los zapateros, o en la parte superior de la trasera con estructura en aluminio, disponible en tejido, madera, vidrio lacado y espejo. El estante zapatero inclinado está equipado con un injerto rápido y invisible, sin tornillos y sin juntas a la vista para una limpieza estética absoluta.



Struttura Structure: 83 piombo
Schienali tessuto Fabric back panels: T019 papiro
Ripiani portascarpe e basamento
Shoe rack shelves and floor base: 83 piombo
Rivestimento Covering: 154 similpelle argilla
Illuminazione led nella parte inferiore Lower led lighting





Struttura *Structure*: 14 brown
 Schienale in vetro *Glass back panel*: 99 caffè opaco
 Ripiani e basamenti *Shelves and floor bases*:
 25 melanimico larice carbone

Dress bold ➤



Struttura *Structure*: 14 brown
 Schienale in vetro *Glass back panel*: 99 caffè opaco
 Ripiani e basamenti *Shelves and floor bases*:
 25 melanimico larice carbone
 Accessori *Accessories*: 153 similpelle castoro

Walk-in closets

Dress bold ➤

Modularità Modular structure

Versione con montante a parete
Version with wall uprights

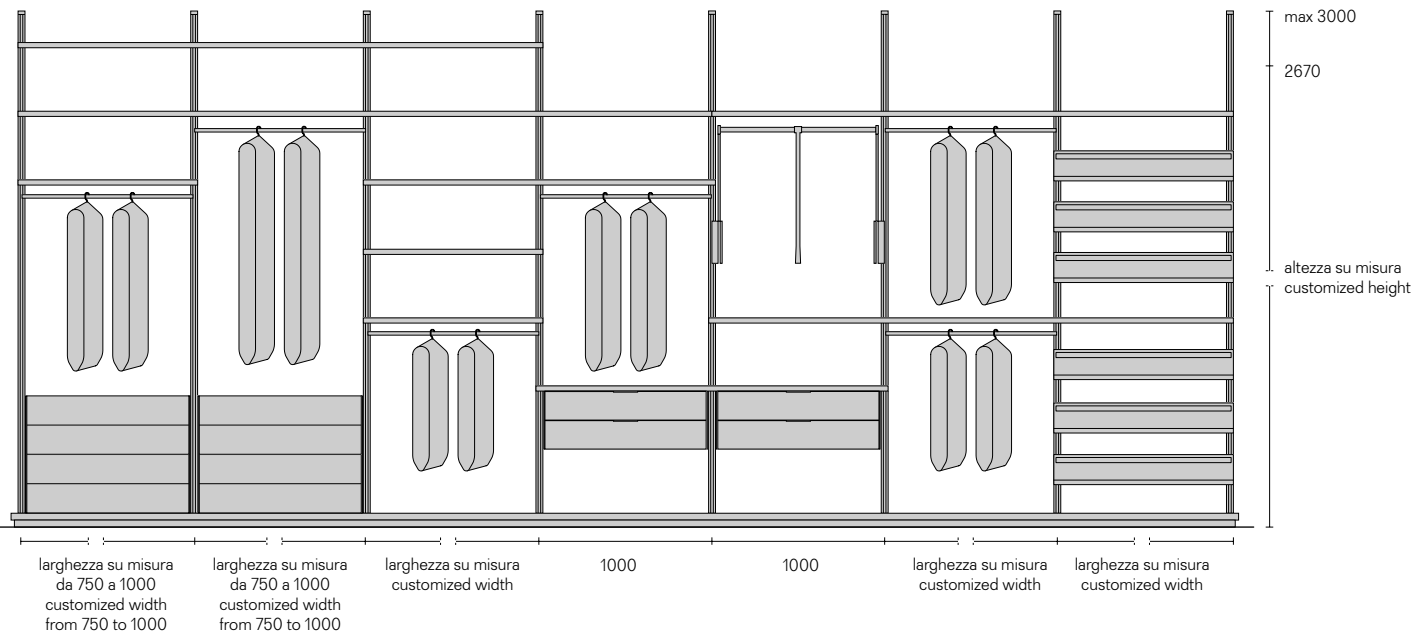

Versione con montante a parete e schienali in tessuto, melaminico, vetro laccato e specchio
Version with wall uprights and back panels in fabric, melamine, lacquered glass and mirror

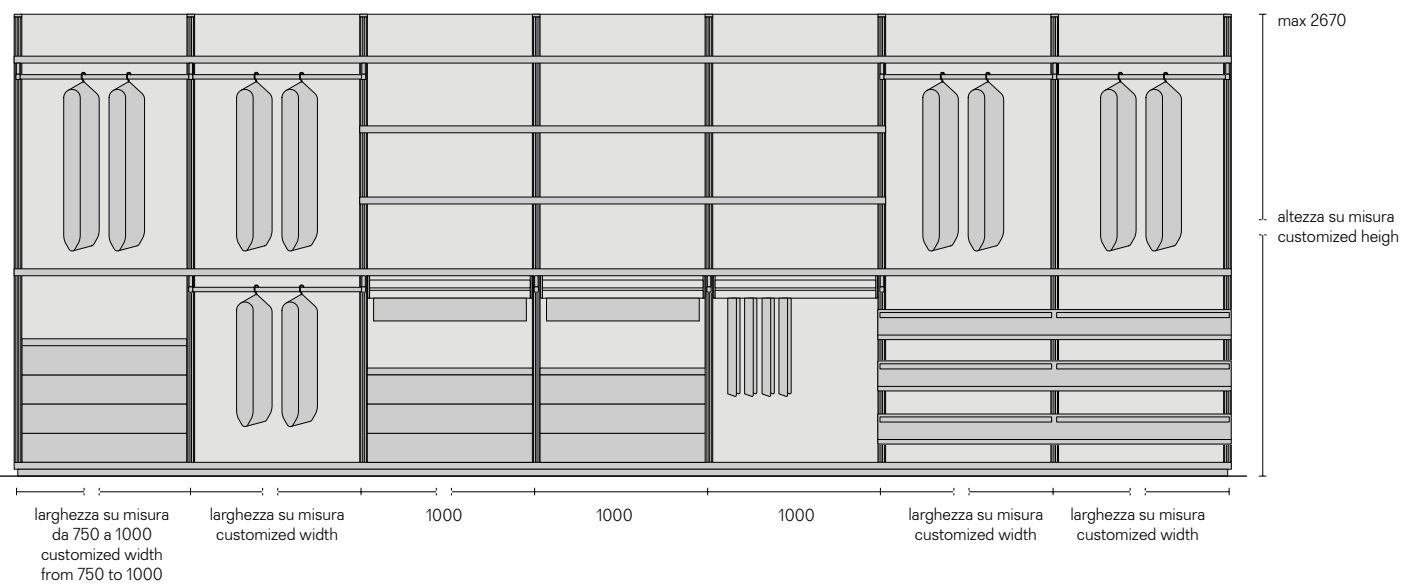

Descrizione tecnica Technical description

Un sistema per creare cabine armadio personalizzabili, con possibilità di composizioni su misura in soluzioni lineari, ad angolo e a C. Due le possibilità estetiche: con i montanti a vista o con pannelli a parete, disponibili in vetro laccato, specchio, melaminico e tessuto. Gli accessori sono liberamente posizionabili lungo il montante a parete, grazie al sistema brevettato di fissaggio ad espansione senza fori.

A system which allows to personalize walk-in closets with custom-made linear, as well as corner and C-shaped compositions. Two aesthetical possibilities are available: with visible uprights or with wall back panels, available in lacquered glass, wood and in fabric. The accessories can be freely positioned on the wall upright, thanks to the patented expansion fixing system, without holes.

Das System erlaubt, persönliche Schrankräume mit lineare sowohl als Ecke Loesungen, immer nach Mass, zugestalten. Zwei sind die vefuegbare aesthetische Moeglichkeiten: mit sichtbaren Wandpfosten oder mit Wandpaneelen, aus lackiertem Glas, Holz und mit Stoff. Die Zubehoeren koennen frei auf den Pfosten mit dem patentierten Spreizmechanismus ohne Loecher gestellt werden.

Dress bold est le système pour personnaliser au mieux les dressings avec des compositions linéaires ou à angle, toujours sur mesure. Deux sont les possibilités esthétiques: avec les montants à vue ou avec les panneaux murales de fond, disponibles en verre laqué, bois et tissu. Les accessoires sont librement positionnables sur le montant mural grâce au système breveté de fixation à expansion sans trous.

Dress bold es un sistema para realizar vestidores personalizable al máximo grado, con la posibilidad de composiciones a medida en soluciones lineales, angulares y a C. Las posibilidades estéticas son dos: con montantes a vista o con paneles a pared, disponibles en cristal lacado, en madera y tejido. Los accesorios son libremente posicionables en los montantes a pared, gracias al sistema patentado de fijación a expansión sin agujeros.

Le tipologie estetiche Aesthetical typologies

Schienale in tessuto
Back panel in fabric



1.

Schienale in melaminico
Back panel in melamine



2.

Schienale in vetro laccato lucido o opaco
Back panel in glossy or mat lacquered glass



3.

Montanti a parete senza schienale
Wall uprights without panels



4.

Composizioni estetiche
Aesthetical compositions



1.



2.



3.

- Schienale in tessuto T018 tabacco, struttura alluminio brown, ripiano in melaminico larice carbone / Back panels in T018 tabacco fabric, brown aluminium structure, shelves in coal larch melamine
- Schienale e ripiano in melaminico larice carbone, struttura alluminio brown / Back panel and shelves in coal larch melamine, brown aluminium structure

- Schienale in vetro laccato lucido caffè, struttura alluminio brown, ripiano in melaminico larice carbone / Back panel in caffè glossy lacquered glass, brown aluminium structure, shelves in coal larch melamine
- Montanti a parete in alluminio brown, ripiano in melaminico larice carbone, senza schienale / Wall uprights in brown aluminium, shelves in coal larch melamine, without back panel

- Struttura in tessuto Lux T044 acciaio, struttura alluminio 14 brown, ripiano in melaminico 25 larice carbone, frontali in vetro 99 caffè opaco, ceste in cuoio 154 argilla / Back panels in T044 acciaio Lux fabric, 14 brown aluminium structure, shelves in melamine 25 larice carbone, glass front in 99 caffè mat trays in 154 argilla leather
- Struttura in 303 bronzo, schienali in tessuto lux T052 segale, ripiani in 07 olmo, ceste alte in 153 castoro leather, frontali in 136 bronzo opaco / Structure in 303 bronzo, back panels in T052 segale Lux fabric, shelves in 07 olmo, big trays in 153 castoro leather, fronts in glass 136 bronzo opaco
- Struttura in 83 piombo, schienali in tessuto lux T051 salvia, ripiani in 09 rovere grigio, ceste alte in 154 cuoio argilla, frontali in 127 piombo opaco / Structure in 83 piombo, back panels in T051 salvia lux fabric, shelves in 09 rovere grigio, big trays in 154 argilla leather, glass fronts in 127 piombo opaco

Dettagli tecnici esclusivi
Exclusive technical details



1.



2.



3.

1. Particolare del pannello a parete in tessuto papiro con sistema di illuminazione a led nel lato superiore, ripiano in melaminico rovere grigio con illuminazione a led integrata. Montante e reggimensola in alluminio piombo, asta portabiti rivestita in similpelle argilla / Detail of back panel in papiro fabric with upper led lighting system, grey oak melamine shelf with integrated led lighting. Upright and shelf holder in piombo lacquered aluminium, cloth-hanger rod covered with regenerated argilla leather
2. Basamento in similpelle argilla, profilo perimetrale e zoccolo in alluminio piombo. Illuminazione a led opzionale / Floor base in regenerated leather with extruded aluminium back and perimeter profile. Optional led lighting
3. Ripiano portascarpe in similpelle argilla, profilo perimetrale e posteriore in alluminio piombo. Tondini di appoggio in acciaio inox. Illuminazione a led opzionale / Shoe rack in regenerated leather with extruded aluminium back and perimeter profile. Optional led lighting

Descrizione tecnica
Technical description

Il sistema Dress bold è caratterizzato dai mensoloni continui in melaminico con struttura in legno tamburato da 40 mm e dai basamenti con telaio continuo in alluminio.

Dress bold system is characterized by one-running melamine shelves with honeycomb wooden structure 40 mm thick and floor-bases with continuous aluminium frame.

Charakteristische Merkmale der Kollektion Dress bold sind die 40 mm starken, durchgehenden, melaminbeschichteten Fachboden in Wabenstruktur und die Basisboden mit durchgehendem Rahmen aus Aluminium.

Le système Dress bold est caractérisé par des étagères de mélamine continues avec structure en bois en nid d'abeille de 40 mm et des bases au sol avec cadre en aluminium continu.

El sistema Dress bold se caracteriza por los estantes en melamina continuos con estructura en alveolar de 40 mm de espesor y por las bases con marco en aluminio continuo.

Componenti
Components

Montante a parete. Profilo elettrificato opzionale per cablaggio ripiani e basamenti / Wall upright. Optional electrified upright for shelves and floor base wiring

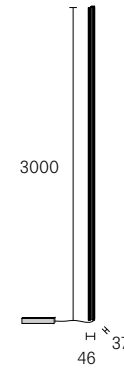

Pannello in melaminico o in tessuto / Melamine or fabric panel

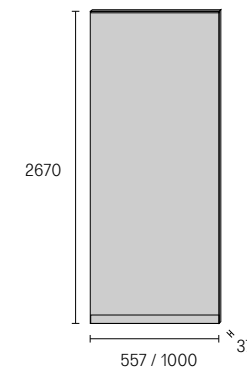

Pannello in vetro laccato o specchio / Panel in lacquered glass or mirror

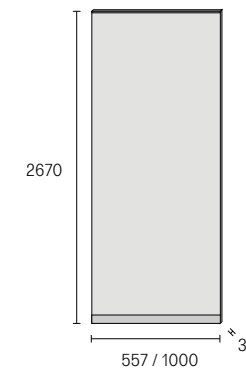

Illuminazione a led superiore per pannello, 3200° Kelvin (luce calda) / Upper led lighting system for glass back panel, 3200° Kelvin (warm light)

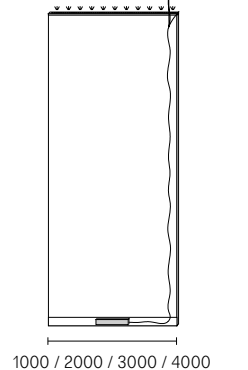

Ripiano in similpelle, profilo perimetrale in estruso di alluminio. Illuminazione a led opzionale / Shelf in synthetic leather with extruded aluminium perimeter profile. Optional led lighting

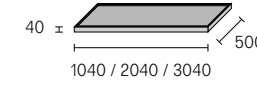

Ripiano in melaminico. Illuminazione a led opzionale / Shelf in melamine. Optional led lighting

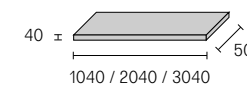

Reggimensola, reggiasta e asta portabiti in alluminio con rivestimento opzionale in similpelle / Supporting shelf, cloth hanger in aluminium with optional covering in synthetic leather

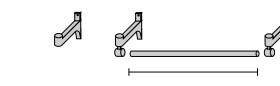

Basamento in similpelle, profilo perimetrale e zoccolo in estruso di alluminio. Illuminazione a led opzionale / Floor base in synthetic leather with extruded aluminium back and perimeter profile. Optional led lighting

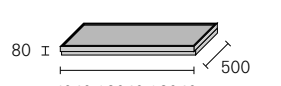

Basamento in melaminico con zoccolo in alluminio estruso. Illuminazione a led opzionale / Base on feet melamine floor with structure in aluminium. Optional led lighting

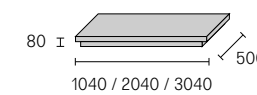

Ripiano portascarpe in similpelle, profilo perimetrale e posteriore in estruso di alluminio. Tondini di appoggio in acciaio inox. Illuminazione a led opzionale / Shoe rack in synthetic leather with extruded aluminium back and perimeter profile. Optional led lighting

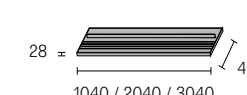

Ripiano portascarpe in melaminico. Illuminazione a led opzionale / Melamine shoe rack. Optional led lighting

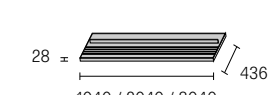

Illuminazione a led 3200° Kelvin (luce calda) per ripiani, basamenti e ripiani portascarpe / Led lighting system, 3200° Kelvin (warm light), for shelves, floor bases and shoe rack

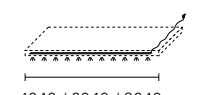

Reggimensola inclinato per ripiano portascarpe / Inclined shelf holder for shoe rack

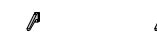

Componenti interni
Internal equipment



1.



2.

1. Ripiano con organizer e cesto basso estraibili con frontali in vetro e rivestimento in similpelle / Pull out shelf with organizer and small tray with glass fronts and covered with synthetic leather
2. Ripiano e portapantaloni estraibili con frontali in vetro e rivestimento in similpelle / Pull out shelf and trousers rack with glass fronts and covered with synthetic leather



3.



4.

3. Appendiabiti inclinabile telescopico / Telescopic cloth lift
4. Ripiano in vetro e portapantaloni estraibili / Pull out glass shelf and trousers rack

Componenti interni
Internal equipment

Cassettiera per basamento e su ruote in melaminico con quattro cassetti / Drawer unit on floor base and on wheels in melamine with four drawers

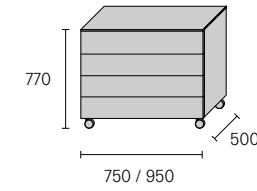
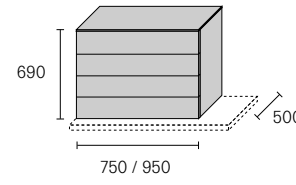

Cassettiera per basamento e su ruote in melaminico larice carbone con tre cassetti / Drawer unit on floor base and on wheels in coal larch melamine with three drawers

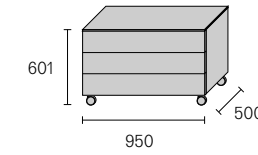
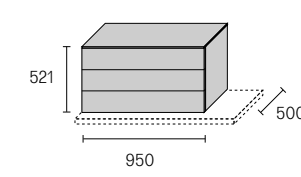

Top opzionale in melaminico larice carbone con fondo rivestito in similpelle, per cassettera su basamento o su ruote / Optional top in coal larch melamine with bottom part covered with synthetic leather, for drawer units on floor base or on wheels

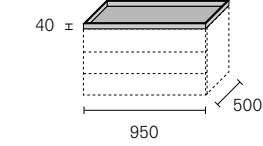
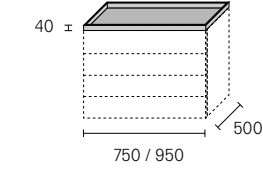

Cassettiera sospesa in melaminico / Suspended drawer unit in melamine

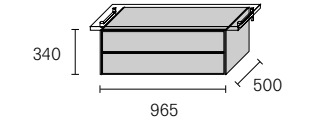

Ripiano con organizer e cesto basso estraibili con frontali in vetro e rivestimento in similpelle / Pull out shelf with organizer and small tray with glass fronts and covered with synthetic leather

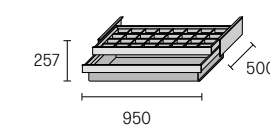

Ripiano con organizer e cesto alto estraibili con frontali in vetro e rivestimento in similpelle / Pull out shelf with organizer and big tray with glass fronts and covered with synthetic leather

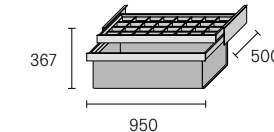

Ripiano e cesto basso estraibili con frontali in vetro e rivestimento in similpelle / Pull out shelf and small tray with glass fronts and covered with synthetic leather

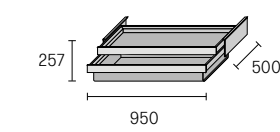

Ripiano e cesto alto estraibili con frontali in vetro e rivestimento in similpelle / Pull out shelf and big tray with glass fronts and covered with synthetic leather

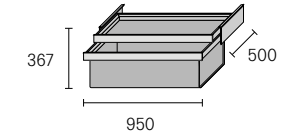

Ripiano con organizer e portapantaloni estraibili con frontali in vetro e rivestimento in similpelle / Pull out shelf with organizer and trousers rack with glass fronts and covered with synthetic leather

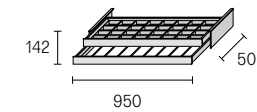

Ripiano e portapantaloni estraibili con frontali in vetro e rivestimento in similpelle / Pull out shelf and trousers rack with glass fronts and covered with synthetic leather

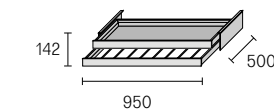

Ripiano in vetro e portapantaloni in alluminio estraibili / Pull out glass shelf and aluminium trousers rack

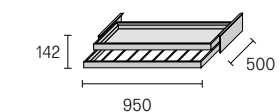

Appendiabiti inclinabile telescopico / Telescopic cloth lift

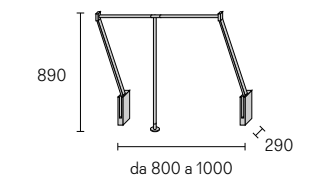

Ingombri tecnici
Technical encumbrances

Composizione lineare
Linear composition

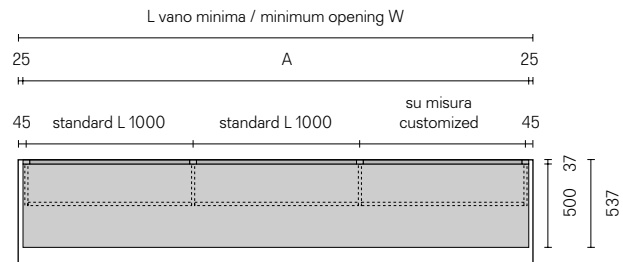

Calcolo della lunghezza della mensola A
L mensola = L vano minima - 50 mm
Calculation of the length of the shelf A
shelf W = minimum opening W - 50 mm

Composizione ad angolo
Corner composition

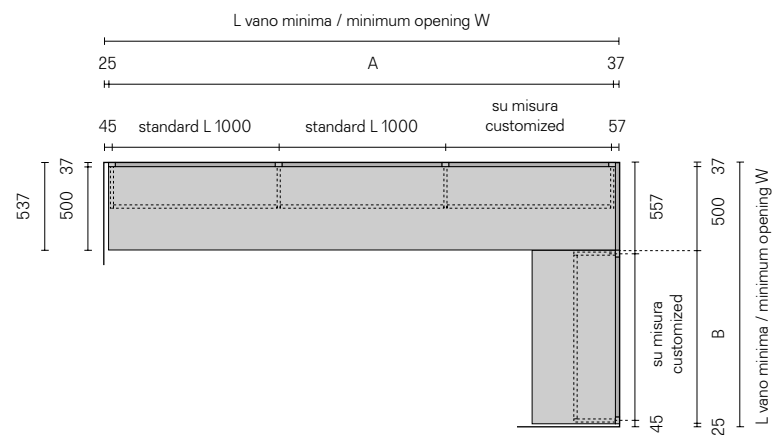

Calcolo della lunghezza della mensola A
L mensola = L vano minima - 62 mm
Calcolo della lunghezza della mensola B
L mensola = L vano minima - 562 mm
Calculation of the length of the shelf A
shelf W = minimum opening W - 62 mm
Calculation of the length of the shelf B
shelf W = minimum opening W - 562 mm

Composizione a C
C-shaped composition

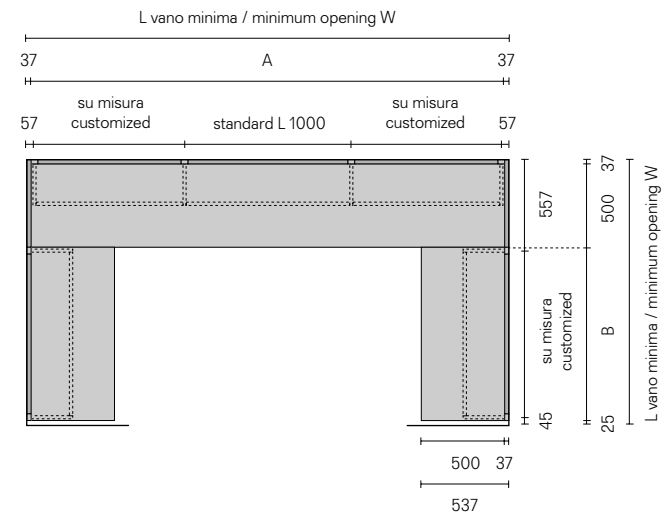

Calcolo della lunghezza della mensola A
L mensola = L vano minima - 74 mm
Calcolo della lunghezza della mensola B
L mensola = L vano minima - 562 mm
Calculation of the length of the shelf A
shelf W = minimum opening W - 74 mm
Calculation of the length of the shelf B
shelf W = minimum opening W - 562 mm

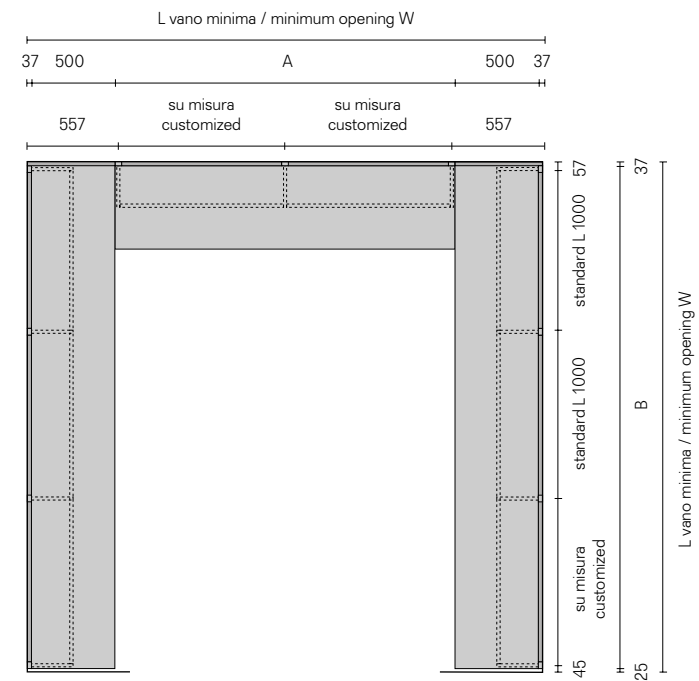

Calcolo della lunghezza della mensola A
L mensola = L vano minima - 1074 mm
Calcolo della lunghezza della mensola B
L mensola = L vano minima - 62 mm
Calculation of the length of the shelf A
shelf W = minimum opening W - 1074 mm
Calculation of the length of the shelf B
shelf W = minimum opening W - 62 mm

Finiture
Finishings

Struttura e accessori
Structure and accessories



Schienale in vetro
Glass back panel

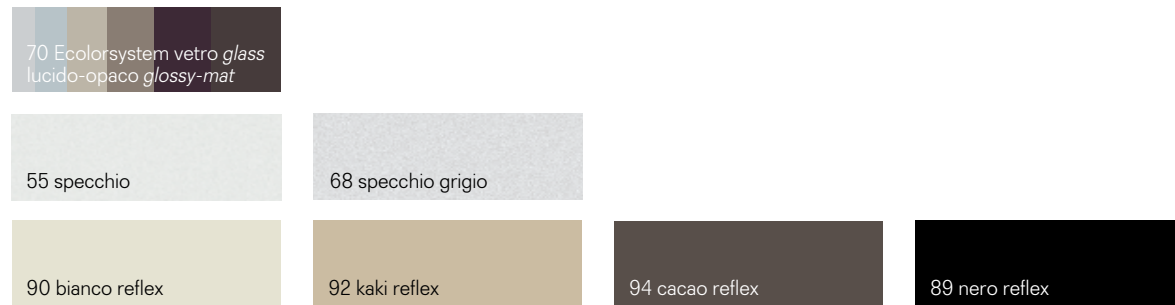

Schienale in legno
Wooden back panel

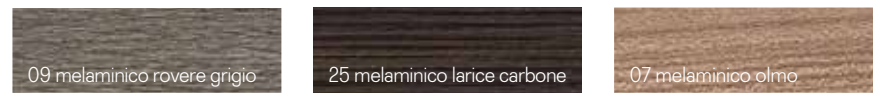

Schienale in tessuto
Fabric back panel

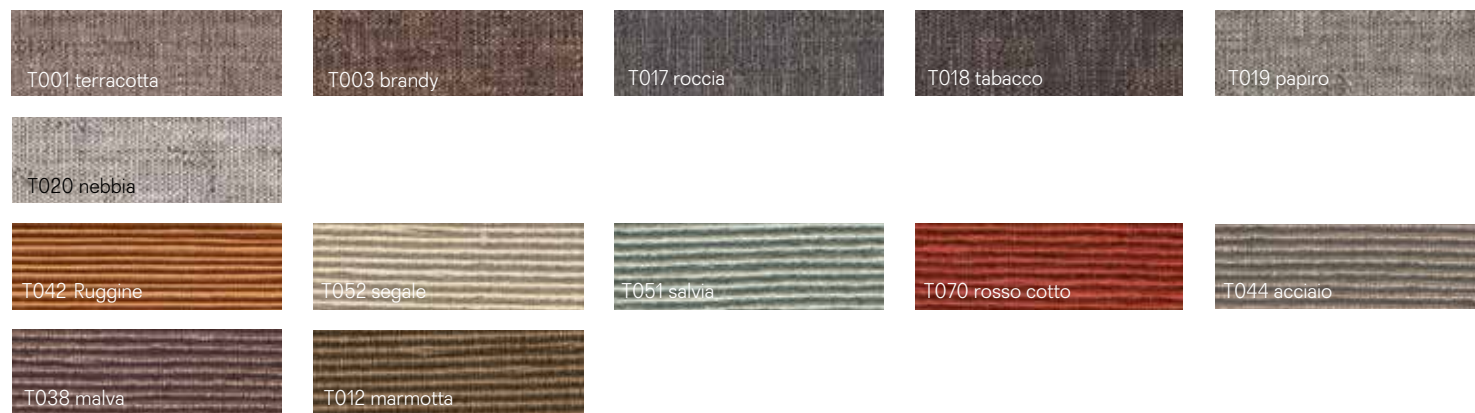

Basamento, ripiano, cassettera e ripiano portascarpe
Floor base, shelf, drawer unit and shoe rack

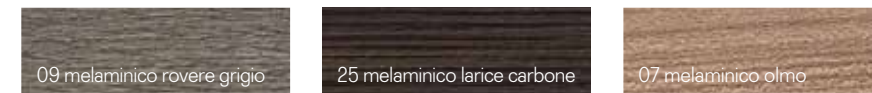

Interno cassettera
Internal drawer unit



Vassoio estraibile porta pantaloni e porta cravatte
Pull out shelf and cloth hanger bar



Asta portabiti, ripiano e accessori estraibili
Cloth hanger bar, pull out shelf and accessories





Design Giuseppe Bavuso

Zenit

The walk-in closet defined by lightness and compositional versatility. The uprights, always custom made in height from floor to ceiling, allow a free positioning of the accessories, both in number and height. The finishings available provide two aesthetic possibilities: a version with glass shelves and drawer units in mat or glossy lacquered glass to discover the great variety of the exclusive 70 Ecoloursystem colours, and, as an alternative, the version with accessories in melamine coal larch, grey oak or elm.

La cabina armadio all'insegna della leggerezza e della versatilità compositiva. I montanti, sempre su misura da terra a soffitto, permettono una libera disposizione delle attrezzature, nel numero e all'altezza desiderata. Le finiture previste invitano a due possibili interpretazioni estetiche: la versione con ripiani in vetro e cassettiere in vetro laccato lucido e opaco che permette di esplorare l'eccezionale varietà dei 70 colori esclusivi Ecoloursystem e, in alternativa, la versione con attrezzatura in melaminico larice carbone, rovere grigio o olmo.

Der begehbare Kleiderschrank definiert sich durch Leichtigkeit und kompositorische Vielseitigkeit. Die vertikalen Pfosten, werden immer auf Maß in der Höhe vom Boden bis zur Decke gefertigt und erlauben eine freie Platzierung des Zubehören, sowohl in der gewünschten Anzahl als auch Höhe. Für das Zubehör stehen Varianten mit Glasregalen und Schubladeneinheiten aus mattem oder glänzend lackiertem Glas in den 70 exklusiven Farben unserer Ecoloursystems zur Verfügung und alternativ auch Versionen in unseren drei Melamin Ausführungen Kohllärche, Eiche grau und Ulme.

Le dressing est défini par la légèreté et la polyvalence de la composition. Les montants toujours sur mesure en hauteur, fixés du sol au plafond, permettent une disposition libre de l'équipement, dans le nombre et à la hauteur désirées. Les finitions disponibles offrent deux possibilités esthétiques: une version avec des étagères en verre et les tiroirs en verre laqué mat ou brillant pour découvrir la grande variété des 70 couleurs exclusives Ecoloursystem, et, comme alternative, la version avec des accessoires en mélamine mélèze carbon, chêne gris ou orme.

El vestidor definido por la ligereza y la versatilidad compositiva. Los montantes, siempre hechos a medida en altura de suelo a techo, permita una colocación libre de los accesorios, tanto en número como en altura. Los acabados disponibles ofrecen dos posibilidades estéticas: una versión con estantes de vidrio y cajoneras en mate o cristal laccado brillante para descubrir la gran variedad de los exclusivos 70 colores Ecoloursystem, y, como alternativa, la versión con accesorios en melamina alerce carbón, gris roble y olmo.

Struttura *Structure*: 13 nero
Ripiani *Shelves*: 63 grigio trasparente
Cassettiere in vetro *Glass drawers*: 102 nero opaco
Cesti *Baskets*: 154 similpelle argilla

Nella foto *In this photo*
Tavolino *Coffee table*: Planet
Pannelli scorrevoli *Sliding doors*: Stripe

Un nuovo valore architettonico per la cabina armadio: con la proposta monocoloro nero, il sistema Zenit diventa un elemento stilistico di grande caratterizzazione degli ambienti. Ogni elemento del sistema è liberamente posizionabile, nel numero desiderato e all'altezza desiderata.

A new architectural value for the walk-in closet: with the black monochromatic proposal, the system Zenit becomes a stylistic element of big characterization of the habitats. A versatile system where each element can be freely positioned in the desired number and at the desired height.

Ein Schrankzimmer mit architektonischem Wert: In der Ausführung einfarbig schwarz wird das System Zenit zu einem wirkungsvollen innenarchitektonischen Gestaltungselement. Jedes element ist frei sowie in Menge als auch in Höhe einsetzbar.

Une nouvelle valeur architecturale pour le dressing: avec la proposition mono couleur noir, le système Zenit devient un élément de style de grande personnalité, qui caractérise particulièrement les ambiances. Chaque élément peut être positionné en toute liberté selon la quantité et la hauteur désirées.

Un nuevo valor arquitectónico para el vestidor: con la propuesta en acabado negro, el sistema Zenit llega a ser un elemento estilístico de grande caracterización de los ambientes. Cada elemento del sistema es libremente posicionable, en el número y a la altura que se desea.









La cabina armadio Zenit amplia le proprie potenzialità progettuali con l'introduzione delle nuove attrezzature in similpelle castoro o argilla. La gamma degli accessori, che come tutti gli elementi compositivi di Zenit consentono un libero posizionamento, comprende: barra portabiti, ripiani estraibili con organizer o vaschetta, cesti alti e bassi, portapantaloni, portacravatte e portascarpe.

Zenit walk-in closet widens its design potential with new accessories in regenerated castor or argilla leather. The range of accessories, which allow a free positioning, like all the other elements for Zenit, includes: cloth hangers, pull out shelves with organizer or trays, big or small trays, trousers racks, tie racks and shoe racks.

Zenit Ankleide erweitert Planungsmöglichkeiten, dankte zur Einführung der neuen Zubehöre aus Kunstleder castoro oder argilla. Die komplette Bandbreite der neuen Ausstattung kann, wie die bestehende Ausstattung, frei positioniert werden. Es besteht aus: Kleiderstangen, Auszugsböden, Organizer, Wannen, niedrige und hohe Körbe, Hose, Krawatte und Schuhregale.

Le dressing Zenit permet aussi de faire de compositions avec un nouvel équipement en simili-cuir castoro ou argilla. La gamme d'accessoires, qui, comme tous les éléments de la composition de Zenit permettent un positionnement libre, comprend: les tiges, plateaux amovibles avec organizer ou vide poches, conteneurs hauts et bas, porte-pantalons, porte-cravates et porte-chaussures.

El vestidor Zenit amplia sus capacidades de diseño con la introducción de los nuevos equipos en simil cuero castoro o argilla. La gama de accesorios, que al igual que todos los elementos compositivos de Zenit permiten un posicionamiento libre, incluye: barras de colgar, estantes extraíbles con organizadores o bandejas, cestas altas y bajas, pantaloneros, corbateros y zapateros.



Struttura Structure: 14 brown
Ripiani Shelves : 25 melaminico larice carbone
Contenitore Organizer: 15 noce
Separatore doppio, porta orologi, vaschetta concava, vaschetta con fessure in 153 similpelle castoro Double partition, watch holder, concave box and box with jewels slots available in eco-leather castoro



Flessibile, perché in grado di adattarsi a qualsiasi esigenza di spazio, versatile, perché grazie a materiali ricercati e finiture sofisticate consente una massima personalizzazione estetica, elegante, per i preziosi abbinamenti tra materiali e superfici diverse che contribuiscono ad esaltarne l'eccellenza: Zenit è la massima espressione della cabina armadio attrezzata.

Flexible, because adaptable to any space requirement, versatile, because, thanks to its refined materials and sophisticated finishings, it allows for a maximum aesthetic personalization, elegant, for the precious combinations of different materials and surfaces, thus helping to enhance the excellence: Zenit the ultimate expression of equipped walk in wardrobe.

Zenit ist die optimale Ausdruck der ausgestatten Ankleide: Flexibel, weil sie zu jedem Raumsnotwendigkeit anpassen kann, vielseitige, danke zu ausgekluegelten Ausfuehrungen, die eine maximale Personalisierung erlauben, elegante, wegen wertvollen Kombinationen neben verschiedenen Materialien und Oberflaechen, die Exzellenz des Systems unterzeichnen.

Flexible, car il peut s'adapter à toutes les exigences de l'espace, polyvalent, parce que grâce à des matériaux raffinés et finitions sophistiquées permet une esthétique de personnalisation maximale, élégant, pour les combinaisons de valeur de différents matériaux et surfaces, qui contribuent à renforcer l'excellence: Zenit la meilleure expression du dressing équipé.

Flexible, ya que es capaz de adaptarse a cualquier necesidad de espacio, versátil, ya que gracias a los materiales refinados y los acabados sofisticados permite la máxima personalización estética, elegante, para las combinaciones de valor de diferentes materiales y superficies que ayudan a potenciar la excelencia: Zenit es la máxima expresión del vestidor equipado.







Rimadesio presta da sempre un'attenzione particolare alla ricerca di nuove cromie e superfici materiche. Un'attenzione che si riflette anche nella garanzia di soluzioni sempre coordinate tra interno ed esterno dei contenitori, tra le finiture dei componenti metallici e in similpelle, le essenze lignee e le laccature dei vetri.

Rimadesio has always paid particular attention to the search for new colors and material surfaces. This attention also comes out in the commitment of offering solutions that increasingly match the inside and the outside of the cabinets, the finishings of the metal and synthetic leather components, the woods and the lacquering of the glass.

Rimadesio hat immer auf neue Farben und Material Oberflaeche aufgemerkt. Aufmerksamkeit, die sich durch koordinierten Farbskombinationen zwischen Innen und Aussen, Metallen und Leder, Holz und lackierten Glaesern ausgedrueckt hat.

Rimadesio a toujours prêté une attention particulière à la recherche de nouvelles couleurs et surfaces de matériaux. Une attention qui se reflète également dans la garantie de solutions toujours coordonnées entre l'intérieur et l'extérieur des meubles, entre les finitions des composants métalliques et dans le simili-cuir, les bois et le laquage du verre.

Rimadesio siempre ha prestado una especial atención a la búsqueda de nuevos cromias y superficies de materiales. Una atención que también se refleja en la garantía de soluciones siempre coordinadas entre el interior y el exterior de los contenedores, entre los acabados de los componentes metálicos y en el simil cuero, las esencias de madera y el lacado del vidrio.



Modularità
Modular structure

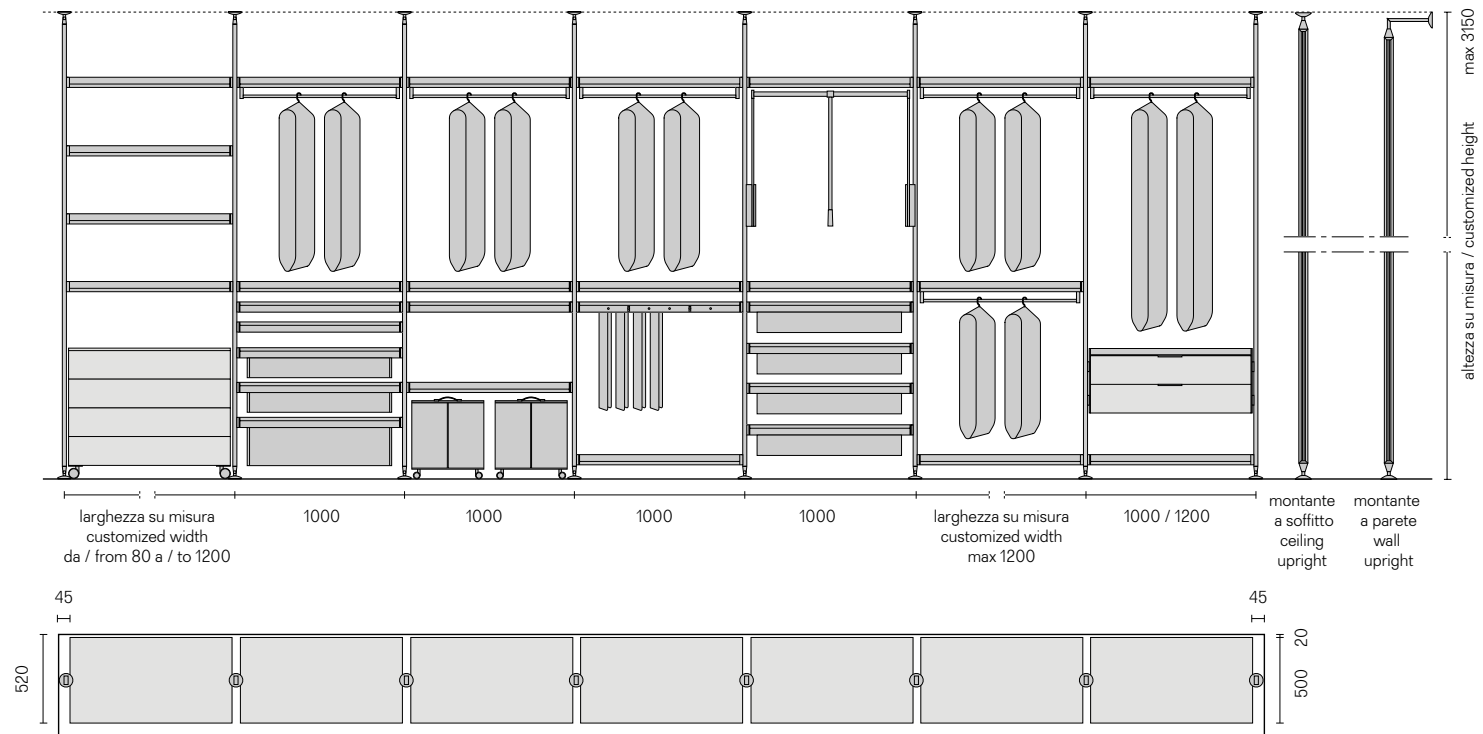

Le composizioni Zenit vengono sempre realizzate su misura in altezza, con possibilità di montanti a parete o a soffitto. Le mensole e le barre portabiti sono disponibili in tre larghezze, con inoltre la possibilità di riduzione a misura. Tutti gli altri componenti sono disponibili solo nella larghezza indicata.

Zenit compositions are always custom-made in height, with wall or ceiling uprights. Shelves and cloth hangers are available with three widths, with the possibility to reduce them. All the other elements are available only with the indicated width.

Zenit Anlage sind immer nach Mass in Hoehe, mit Wand oder Decke-Pfosten hergestellt. Fachboeden und Kleiderstange sind mit drei Breiten verfuegbar. Es is auch moeglich sie nach Mass zu kuerzen. Die andere Zubehoeren sind nur mit der angegebenen Breite verfuegbar.

Les compositions Zenit sont toujours sur mesure en hauteur, avec les montants à fixation murale ou au plafond. Les étagères et les tiges porte-manteaux sont disponibles en trois largeurs avec la possibilité de les réduire sur mesure. Tous les autres accessoires sont disponibles seulement dans la dimension indiquée.

Las composiciones Zenit están siempre realizadas a medida en altura, con posibilidad de montantes a pared o a techo. Los estantes y las barras de colgar están disponibles en tres anchuras, con la posibilidad de reducción a medida. Los otros accesorios están disponibles sólo en la anchura indicada.



1. Il montante a parete in acciaio / Wall upright in steel.
2. Mensola con ring perimetrale in estruso d'alluminio anodizzato / Shelf with perimetrical ring in extruded aluminium
3. Aggancio a baionetta tra mensola e staffa di sostegno in pressofusione / Bayonet fixing between the shelf and the die casting support
4. Montante strutturale in estruso d'alluminio anodizzato / Structural upright in extruded aluminium
5. Staffa di sostegno con fissaggio ad espansione brevettato per permette di riposizionare gli accessori / Support with expansion fixing system which allows to adjust the position of the accessories

Ingombri tecnici
Technical encumbrances

Composizione lineare
Linear composition

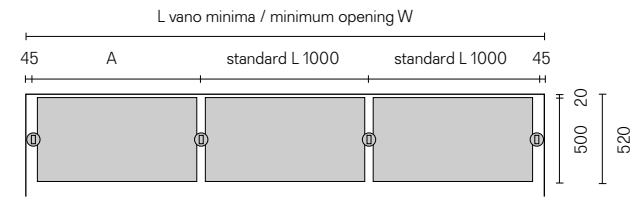

Calcolo della lunghezza della mensola A
L mensola = L vano minima - 1000 - 1000 - 90 mm
Calculation of the length of the shelf A
shelf W = minimum opening W - 1000 - 1000 - 90 mm

Composizione ad angolo
Corner composition

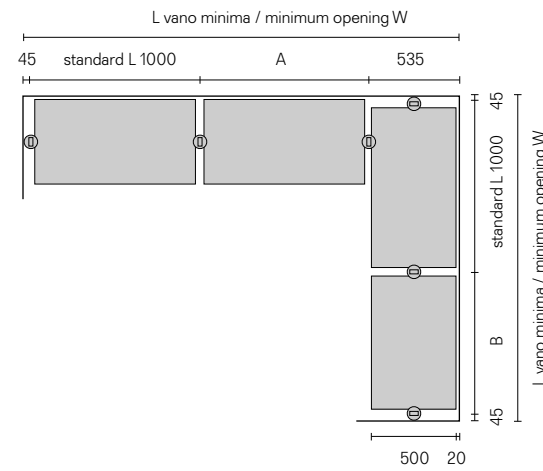

Calcolo della lunghezza della mensola A
L mensola = L vano minima - 580 - 1000 mm
Calcolo della lunghezza della mensola B
L mensola = L vano minima - 1000 - 90 mm
Calculation of the length of the shelf A
shelf W = minimum opening W - 580 - 1000 mm
Calculation of the length of the shelf B
shelf W = minimum opening W - 1000 - 90 mm

Composizione a C
C-shaped composition

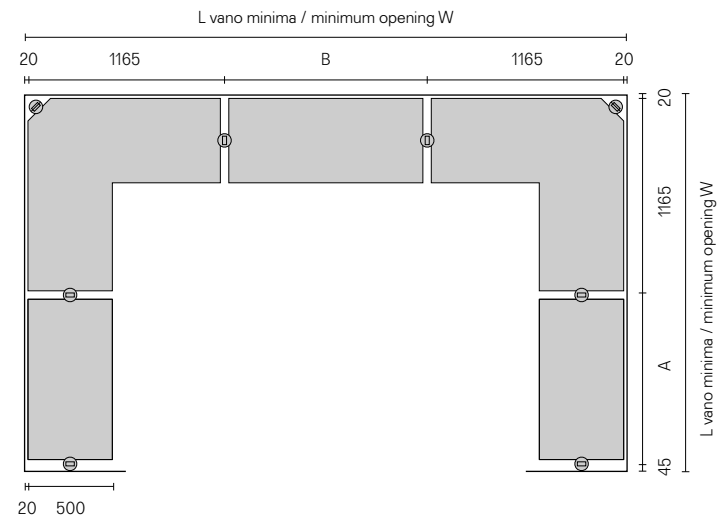

Calcolo della lunghezza della mensola A
L mensola = L vano minima - 65 - 1165 mm
Calcolo della lunghezza della mensola B
L mensola = L vano minima - 40 - 1165 - 1165 mm
Calculation of the length of the shelf A
shelf W = minimum opening W - 65 - 1165 mm
Calculation of the length of the shelf B
shelf W = minimum opening W - 40 - 1165 - 1165 mm

Ripiani estraibili in similpelle
Pull out shelf in synthetic leather finishing



1.



2.

1. Ripiano estraibile portacravatte / Pull out shelf with tie rack
2. Ripiano estraibile con organizer / Pull out shelf with organizer tray
3. Ripiano estraibile portascarpe / Pull out shelf with shoe rack
4. Ripiano estraibile con portapantaloni e vani per cinture / Pull out shelf with trousers rack and belts tray



3.



4.

Accessori
Accessories

Mensola in vetro temperato o melaminico con ring in alluminio, disponibile anche con barra portabiti inferiore con rivestimento in cuoio opzionale / Tempered glass or melamine shelf with aluminium ring. Available also with lower cloth hanger, with optional leather covering

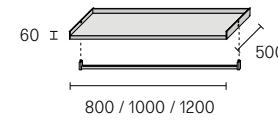

Mensola angolare in vetro temperato o melaminico con ring in alluminio, disponibile anche con barra portabiti inferiore con rivestimento in cuoio opzionale / Tempered glass or melamine corner shelf with aluminium ring, available also with integrated cloth stand rod with optional leather covering

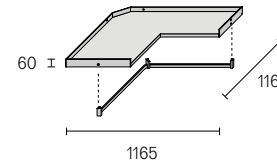

Barra portabiti singola e singola angolare con rivestimento in cuoio opzionale / Single and corner single cloth hanger with optional leather covering

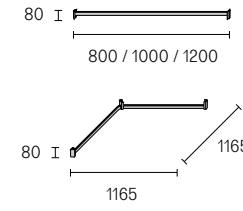

Appendiabiti inclinabile telescopico / Telescopic cloth lift

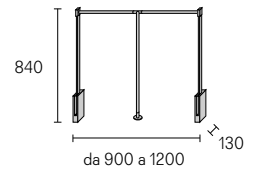

Cassettiera sospesa in melaminico o in vetro laccato e temperato con ring in alluminio / Suspended melamine or lacquered and tempered glass drawer unit with aluminium ring

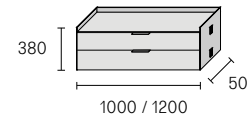

Cassettiera su ruote in vetro laccato o in melaminico con quattro cassetti / Drawer unit on wheels in lacquered glass or in melamine with four drawers

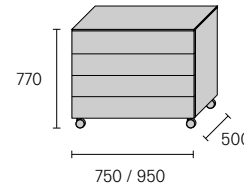

Cassettiera su ruote in melaminico larice carbone con tre cassetti / Drawer unit on wheels in coal larch melamine with three drawers

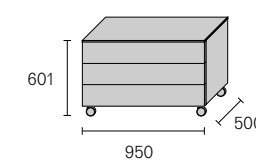

Top opzionale in melaminico larice carbone con fondo rivestito in similpelle, per cassettera su ruote / Coal larch melamine optional top with bottom part covered with synthetic leather, for drawer units on wheels

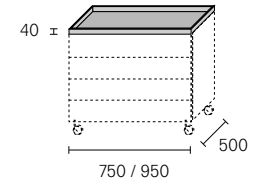

Ripiano estraibile con organizer in similpelle / Pull out shelf with organizer tray in synthetic leather finishing

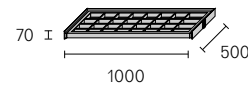

Cesti basso e alto estraibili in similpelle / Pull out small and big trays in synthetic leather finishing

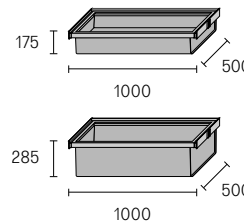

Contenitore su ruote in similpelle, interno in tessuto nero / Cabinets on wheels in synthetic leather finishing, black fabric inside

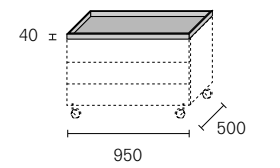
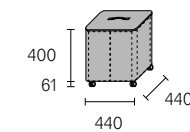

Ripiano estraibile con portapantaloni e vani per cinture in similpelle / Pull out shelf with trousers rack and belts tray in synthetic leather finishing

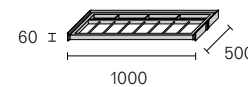

Ripiano estraibile portacravatte in similpelle / Pull out shelf with tie rack in synthetic leather finishing

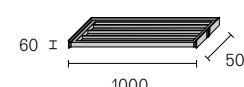

Ripiano estraibile portascarpe in similpelle / Pull out shelf with shoe rack in synthetic leather finishing

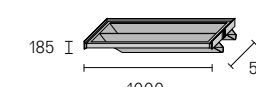

Cesta e vassoio in similpelle / Synthetic leather box and tray

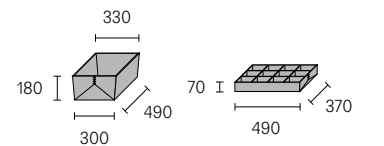

Ripiano estraibile con vaschetta in similpelle / Pull out shelf with tray in synthetic leather finishing

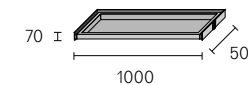

Contenitore in essenza di noce / Walnut veneered organizer

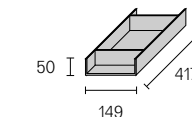

Separatore doppio / Organizer with double partition

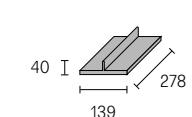

Porta orologi / Watch holder

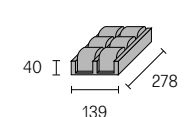

Vaschetta concava e vaschetta con fessure / Box with jewels slots and concave box

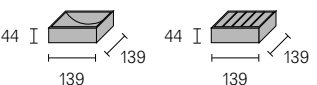

Finiture Finishings

Struttura e accessori
Structure and accessories

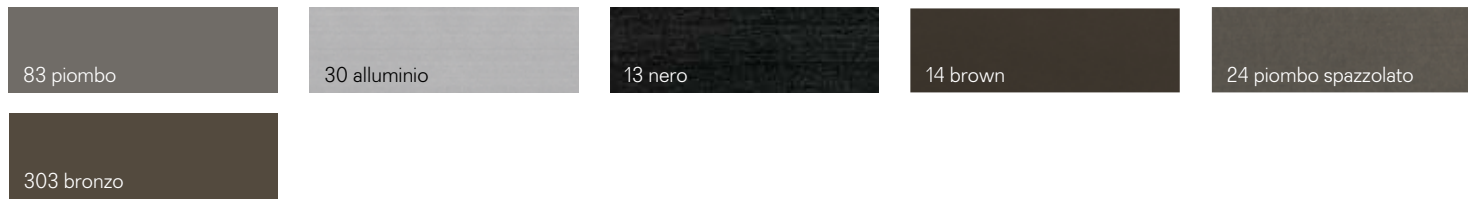

Mensola, cassettera sospesa e su ruote in melaminico
Melamine shelf and drawer unit, either suspended and on wheels



Mensola in vetro
Glass shelf

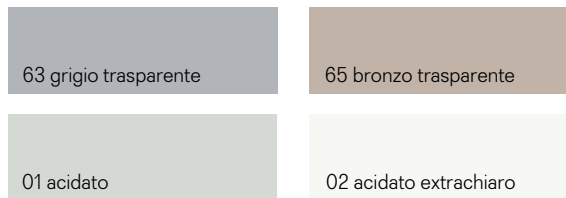

Cassettera sospesa e su ruote in vetro
Glass drawer unit, either suspended and on wheels



Interno cassettera
Internal drawer unit



Top cassettera opzionale
Optional drawer unit top



Ripiano estraibile e rivestimento asta portabiti
Pull out shelf and cloth hanger bar



Appendiabiti inclinabile
Clothes lift

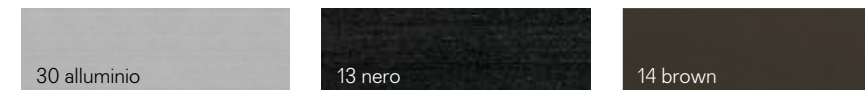



Design Giuseppe Bavuso

Abacus

With Abacus, the walk in closet becomes a room in lacquered glass, where extremely thin and rigorous geometric horizontal elements are placed. A project that is interpreted with a minimal style, coherent in every detail, starting from the accessories and the cabinets to organize the space, up to the led lighting system placed in the lower part of the shelves and integrated in the top part of the panels.

Con Abacus, la cabina armadio diventa una stanza di vetro laccato, in cui si innestano elementi orizzontali di minimo spessore e dal massimo rigore geometrico. Un progetto interpretato con uno stile minimale e coerente in ogni dettaglio, dagli accessori e i contenitori per l'organizzazione dello spazio armadio, al sistema di illuminazione a led presente nella parte inferiore delle mensole attrezzate e integrato alla sommità dei pannelli a parete.

Danke zu Abacus, kann man die Ankleide als einer Raum aus lackiertem Glas konzipieren, wo minimale, horizontale Elementen mit hoeher geometrischen Strenge sich integrieren. Einer minimaler und in jeden Details kohaerenter Projekt, von Zubehoeren und Container, die Innenraum aufstatten, bis zum LED Beleuchtung System bei Tablaren und Spitze den Paneelen.

Avec Abacus, le dressing devient une salle de verre laquée, avec des éléments horizontaux d'épaisseur minimale et de rigueur géométrique maximale. Un projet interprété avec un style minimal et cohérent dans les petits détails, des accessoires et des conteneurs pour l'organisation de l'espace nuit, au système d'éclairage à led, présent dans la partie inférieure des étagères et intégré en haut des panneaux de fond muraux.

Con Abacus, el vestidor se convierte en una estancia de vidrio lacado, en la que se insertan elementos horizontales de mínimo grosor y máximo rigor geométrico. Un proyecto realizado con un estilo mínimo y consistente en cada detalle, de los accesorios y contenedores para la organización del espacio armario, el sistema de iluminación LED en la parte inferior de los estantes e integrado a la parte superior de los paneles de pared.

Struttura *Structure*: 16 bianco latte
Pannelli e cassettiere *Back panels and drawer units*: 108 bianco latte opaco
Ripiani *Shelves*: 16 bianco latte
Aste portabiti *Clothes hanger*: acciaio inox
Interno cassetti *Internal drawers*: UB09 melaminico cuoio brown

Nella foto *In this photo*
Porta scorrevole
Sliding door: Graphis Plus



Fra tecnologia e suggestione, nuove valenze stilistiche per gli ambienti dedicati all'ordine personale. Il sistema Abacus porta l'estetica del vetro Rimadesio verso nuove possibilità di interpretazione: la cabina armadio diventa una stanza di vetro laccato, in cui si innestano elementi orizzontali di minimo spessore e dal massimo rigore geometrico. Un progetto che anche dal punto di vista illuminotecnico è in grado di coniugare funzionalità e mood, grazie al sistema di illuminazione integrato nella parte superiore dei pannelli a muro, che si affianca alle lampade a led delle mensole.

Between technology and suggestiveness, new stylistic values for environments dedicated to personal space. The Abacus system takes Rimadesio's glass aesthetic towards new possibilities of interpretation: the walk-in wardrobe becomes a room of lacquered glass wherein extremely thin and rigorously geometric horizontal elements are placed. A design that is capable of combining functionality and mood from a lighting point of view, thanks to the built-in lighting system on the upper part of the wall panels, and the led lights on the shelves.

Zwischen Technologie und Anregung, neue stylistische Werte für personale Umgebungen. Das Abacus-System bringt die Ästhetik des Glases Rimadesio hin zu neuen Interpretationsmöglichkeiten: der Schrank wird zu einem Raum aus lackiertem Glas, wo horizontalen Elemente der Mindestdicke und geometrische Strenge das Heim gestalten. Ein Projekt, dass aus der Sicht Beleuchtung, die Fähigkeit hat, Funktion und Stimmung zu kombinieren, dank zu der oberen Beleuchtung, in den Wandpaneelen integriert, und der Led Beleuchtung der Fachboden.

Entre technologie et suggestion, nouvelles propositions stylistiques pour les ambiances dédiées au rangement. Nouvelles interprétations de l'esthétique du verre Rimadesio avec le système Abacus: le dressing devient une vraie pièce de verre laqué avec le mariage d'éléments horizontaux d'épaisseur très réduit avec un rigueur géométrique important. Un projet, que même sous un point de vue de l'éclairage, permet de marier fonctionnalité et humeur, grâce au système d'éclairage intégré dans la partie supérieure des panneaux au mur en plus de lampes led des étagères.

Entre tecnología y sugestión, nuevos valores estilísticos para los ambientes dedicados a los entornos personales. El sistema Abacus lleva la estética del cristal Rimadesio hacia nuevas posibilidades de interpretación: el vestidor se convierte en una habitación de cristal lacado, donde se mezclan elementos horizontales de espesor mínimo y del máximo rigor geométrico. Un proyecto que también desde el punto de vista de iluminación técnica tiene la capacidad de combinar funcionalidad y el estado de ánimo, gracias al sistema de iluminación integrado en la parte superior de los paneles a pared, que se adjunta a las lámparas led de los estantes.





Una cabina armadio che diventa sistema per arredare spazi di lavoro o commerciali come negozi o showroom: Abacus è una soluzione in continua evoluzione nella quale gli accessori e i materiali sofisticati ed eleganti, come l'esclusivo similpelle argilla, assicurano eleganza e flessibilità in qualsiasi contesto.

A walk in wardrobe becoming a system to decorate workspaces or commercial shops and showrooms: Abacus is a always evolving solution, in which the accessories and the sophisticated and elegant materials, such as the exclusive synthetic leather argilla, provide for elegance and flexibility in any context.

Ein Ankleidessystem, das Einrichtungssystem fuer Geschaefte oder Showroom sein kann: Abacus ist eine Loesung auf staendiger Entwicklung, wo exklusiven, ausgekluegelten und eleganten Zubehoeren und Materialien, wie regenerierter Leder argilla, Eleganz und Flexibilitaet in jeder Situation versichern.

Le dressing qui devient un système pour le projet des espaces de travail ou des magasins commerciaux ou des showroom: Abacus est une solution en évolution constante, dans laquelle les accessoires et les matériaux sophistiqués et élégants, tels que le simili-cuir argilla, offrent élégance et flexibilité dans tout le contexte.

Un vestidor que se convierte en el sistema para amueblar espacios de trabajo o comerciales tales como tiendas y exposiciones: Abacus es una solución en continua evolución en la que los accesorios y los materiales sofisticados y elegantes, como el exclusivo simil cuero argilla, proporcionan elegancia y flexibilidad en cualquier contexto.

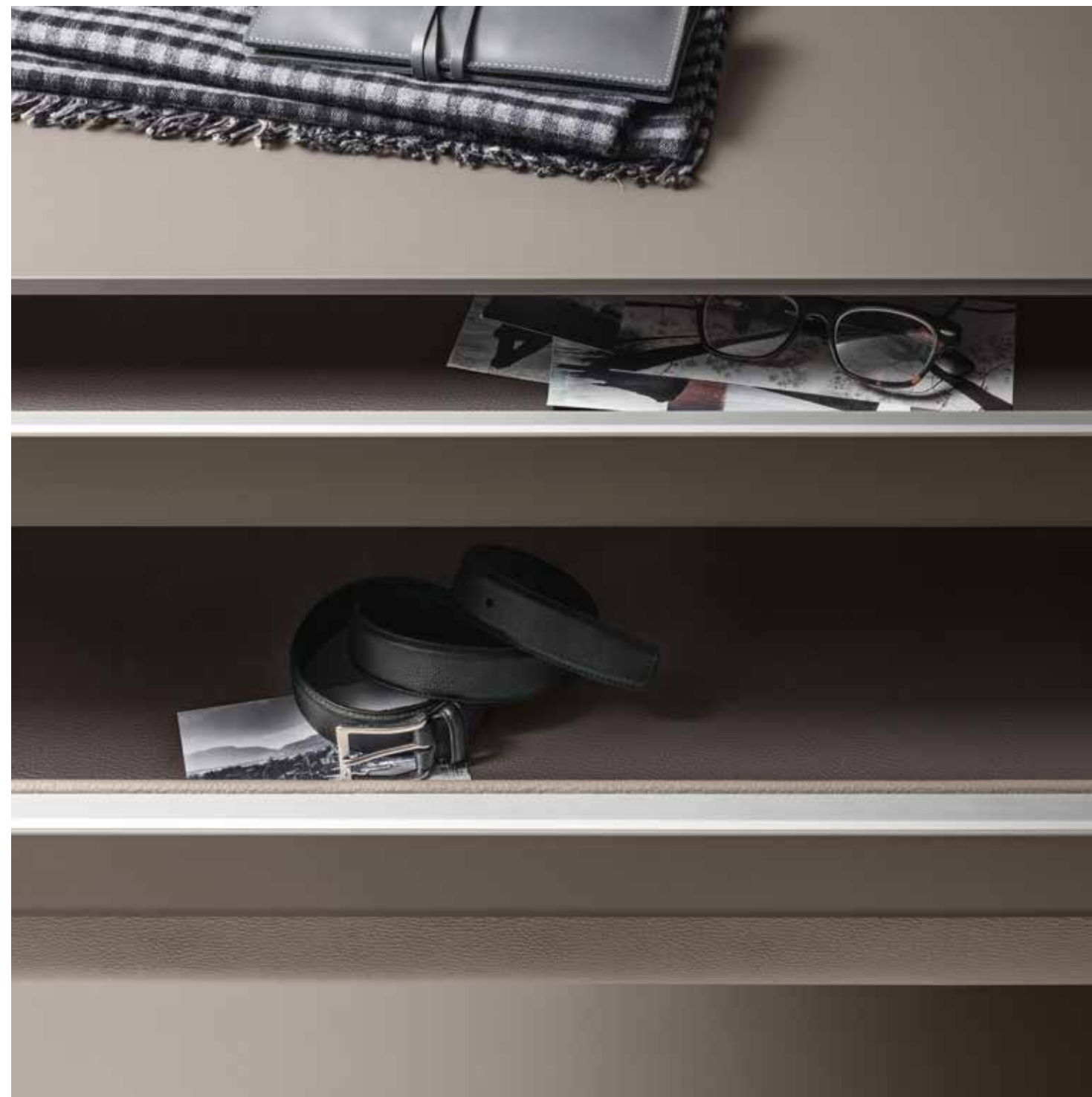

Modularità Modular structure

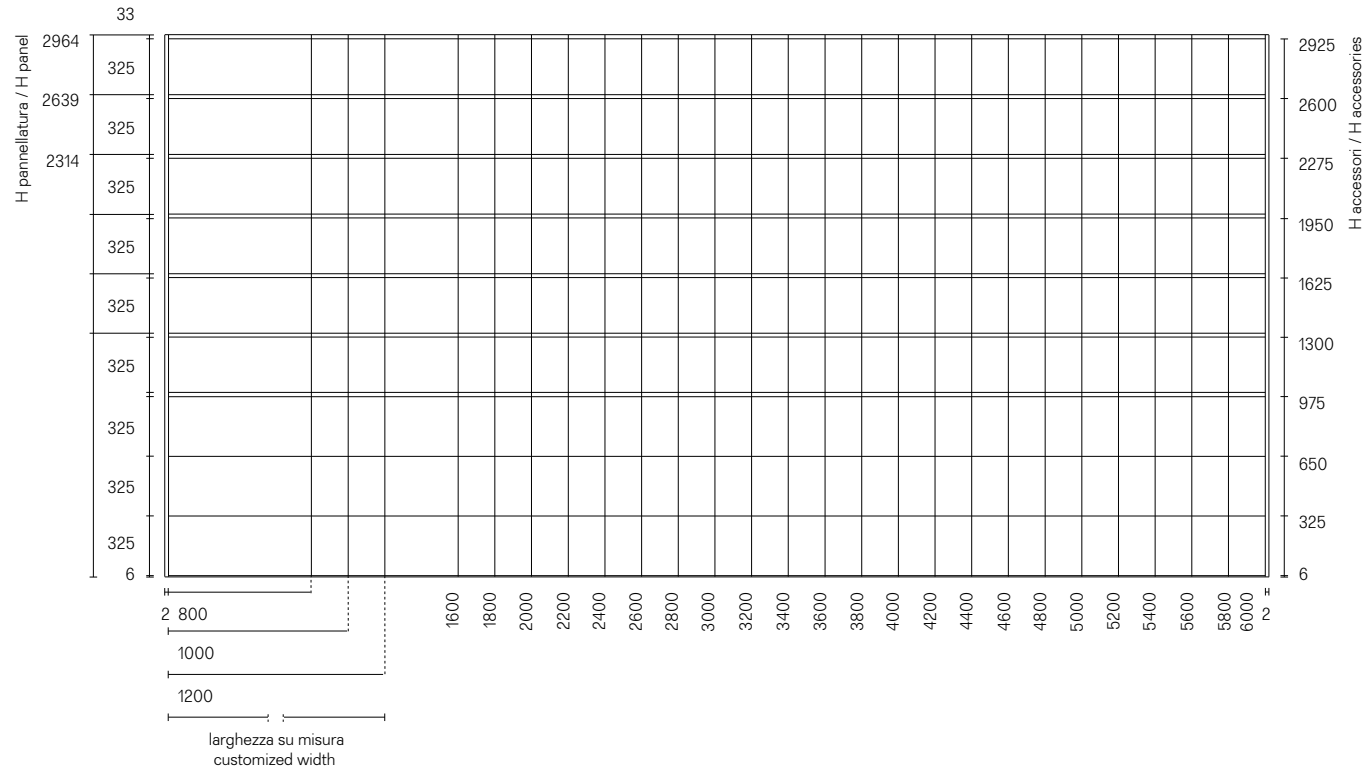

Descrizione tecnica Technical description

La modularità del sistema Abacus si basa su pannelli a parete in vetro laccato disponibili in quattro larghezze e tre altezze. È inoltre previsto il taglio a misura in larghezza. Uno schema dimensionale che assicura la massima libertà progettuale, per consentire di inserire le composizioni in ogni tipo di spazio.

The modularity of the Abacus system is based on the wall panels in lacquered glass, available in four widths and three different heights. The custom-size cut is also provided. A dimensional plan that ensures the maximum flexibility, in order to allow to use the compositions in every type of space.

Die Modularität des Abacus Systems basiert auf lackierten Glasplatten in vier Breiten und drei Höhen. Es ist auch für den Zuschnitt in der Breite zur Verfügung gestellt. Ein dimensionales Schema, das maximale Designfreiheit gewährleistet, um zu ermöglichen, die Zusammensetzung in jeder Art von Raum zu verwirklichen.

La modularité du système Abacus est basée sur des panneaux à mur en verre laqué disponibles en quatre largeurs et trois hauteurs. Il est également prévu la découpe sur mesure en largeur. Un schéma dimensionnel qui assure un maximum de liberté de conception, afin de permettre d'insérer les compositions dans tout type d'espace.

La modularidad del sistema Abacus se base en paneles a pared en cristal lacado disponibles en cuatro anchos y tres alturas. Además está previsto el corte a medida en ancho. Un esquema dimensional que asegura la máxima libertad de diseño, para permitir colocar las composiciones en todo tipo de espacio.

Finiture Finishes



Particolare del pannello a parete in vetro laccato opaco tortora con sistema di illuminazione a led nel lato superiore, ripiano laccato opaco tortora con lampada led incassata nello spessore. Asta portabiti in acciaio inox spazzolato rivestita in similpelle argilla / Detail of back-panel in tortora mat lacquered glass with upper led lighting system, tortora lacquered shelf with Led lamp recessed into the thickness. Cloth hanger rod in brushed stainless steel covered with regenerated argilla leather

Ingombri tecnici Technical encumbrances

Composizione lineare Linear composition

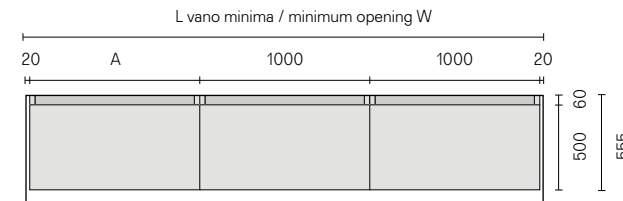

Calcolo della lunghezza della mensola e del pannello A
L mensola / L pannello = L vano minima - 1000 - 1000 - 40 mm

Calculation of the length of the shelf and of the panel A
shelf W / panel W = minimum opening - 1000 - 1000 - 40 mm

Composizione ad angolo Corner composition

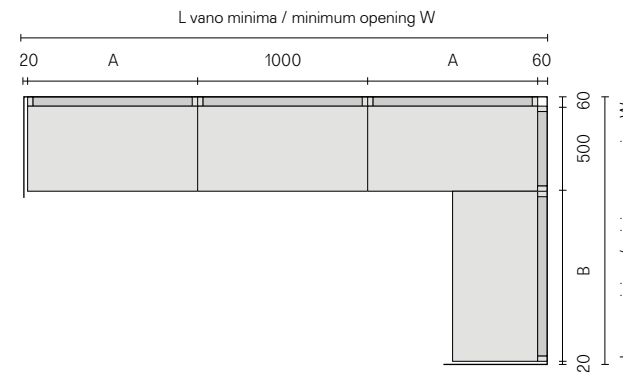

Calcolo della lunghezza della mensola e del pannello A
L mensola / pannello = L vano minima - 1000 - 1000 - 75 mm
Calcolo della lunghezza della mensola e del pannello B
L mensola / pannello = L vano minima - 575 mm

Calculation of the length of the shelf and of the panel A
shelf W / panel W = minimum opening W - 1000 - 1000 - 75 mm
Calculation of the length of the shelf and of the panel B
shelf W / panel W = minimum opening W - 575 mm

Composizione a C C-shaped composition

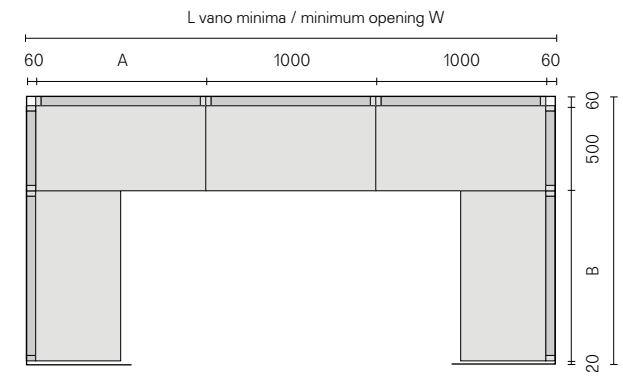

Calcolo della lunghezza della mensola e del pannello A
L mensola / L pannello = L vano minima - 1000 - 1000 - 120 mm
Calcolo della lunghezza della mensola e del pannello B
L mensola / pannello = L vano minima - 580 mm

Calculation of the length of the shelf A and of the panel
shelf W / = minimum opening W - 1000 - 1000 - 120 mm
Calculation of the length of the shelf B and of the panel
shelf W / panel W = minimum opening W - 580 mm

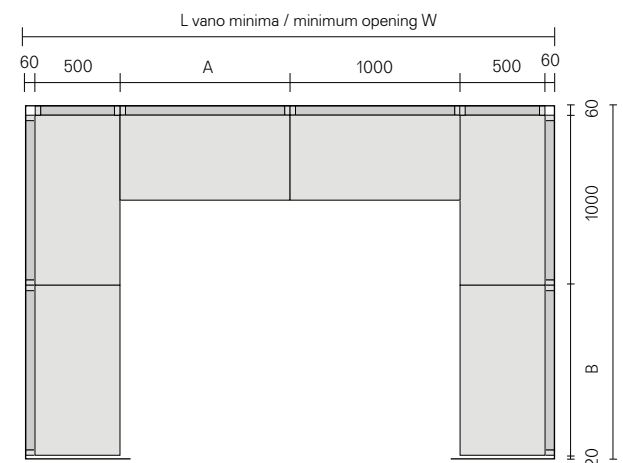

Calcolo della lunghezza della mensola e del pannello A
L mensola / pannello = L vano minima - 1000 - 560 - 560 mm
Calcolo della lunghezza della mensola e del pannello B
L mensola / pannello = L vano minima - 1000 - 80 mm

Calculation of the length of the shelf and of the panel A
shelf W / panel W = minimum opening W - 1000 - 560 - 560 mm
Calculation of the length of the shelf and of the panel B
shelf W / panel W = minimum opening W - 1000 - 80 mm

Walk-in closets

Abacus

Componenti
Components



1.

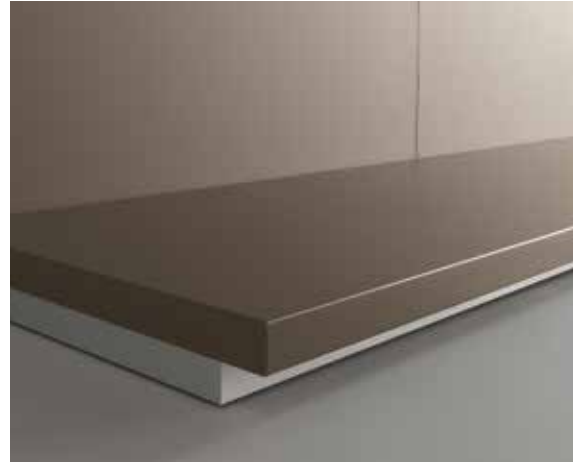

2.

1. Cassettiera sospesa in vetro laccato temperato con cassetto push a estrazione totale / Suspended chest of drawers in tempered lacquered glass with push drawers fitted with fully extractable runners
2. Basamento in legno laccato con zoccolino continuo in alluminio. / Floor base in lacquered wood with running aluminium skirting.
3. Ripiano con organizer e cesto basso estraibili con frontali in vetro e rivestimento in similpelle / Pull out shelf with organizer and small tray with glass fronts and covered with synthetic leather
4. Ripiano e portapantaloni estraibili con frontali in vetro e rivestimento in similpelle / Pull out shelf and trousers rack with glass fronts and covered with synthetic leather



3.



4.

Componenti
Components

Pannello in vetro laccato e temperato, struttura in estruso di alluminio anodizzato. Profilo laterale in alluminio laccato
Panel in lacquered and tempered glass, structure in extruded anodized aluminium. Lacquered aluminium side profile

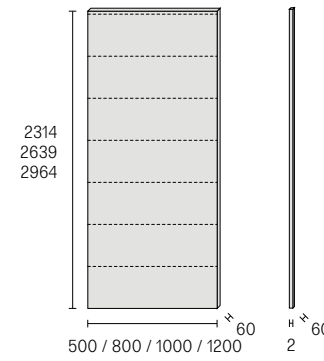

Ripiano laccato e stratificato in MDF rivestito da una doppia lastra di alluminio. Illuminazione a led opzionale
Multilayer lacquered shelf in MDF, covered by a double aluminium sheet. Optional led lighting

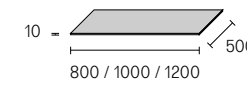

Lampada a led per ripiano laccato.
Led spotlight for lacquered shelves.



Asta portabiti per ripiano, in alluminio o in acciaio inox spazzolato / Clothes-hanger rod for shelf, in aluminium or in brushed steel

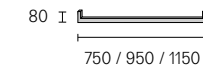

Cesta e vassoio in similpelle.
Synthetic leather box and tray.

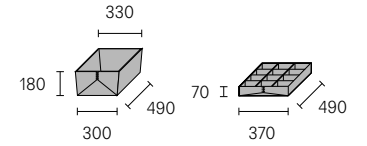

Asta portabiti a soffitto in acciaio inox spazzolato (H soffitto max 3000)
Ceiling clothes-hanger rod in brushed steel (H ceiling max 3000)

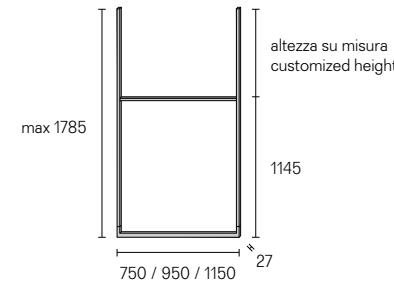

Illuminazione superiore a led
Upper led lighting

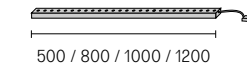

Base attrezzata con cassetto push a estrazione totale, in vetro laccato temperato con zoccolo in alluminio estruso
Floor base equipped with push drawer fitted with fully extractable runners, in tempered lacquered glass with extruded aluminium structure

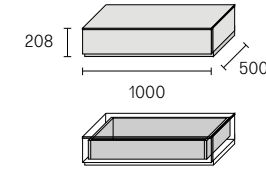

Base attrezzata per angolo con cassetto push a estrazione totale, in versione sinistra e destra, in vetro laccato temperato con zoccolo in alluminio estruso
Corner floor base equipped with push drawer fitted with fully extractable runners, left and right version, in tempered lacquered glass with extruded aluminium structure

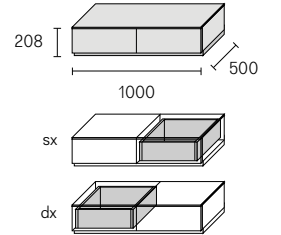

Basamento in legno tamburato con zoccolo in alluminio estruso
Floor base in honeycomb wood and structure in extruded aluminium

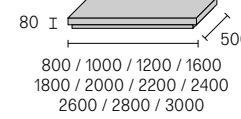

Cassettiera sospesa in vetro laccato temperato con cassetto push a estrazione totale / Suspended chest of drawers in tempered lacquered glass with push drawers fitted with fully extractable runners

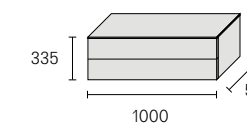

Cassettiera in vetro laccato temperato con cassetto push a estrazione totale per basamento o su ruote / Chests of drawers in tempered lacquered glass with push drawers fitted with fully extractable runners on floor base or on wheels

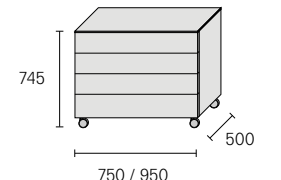
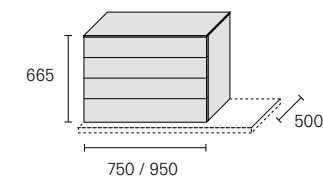

Ripiano con organizer e cesto basso estraibili con frontali in vetro e rivestimento in similpelle / Pull out shelf with organizer and small tray with glass fronts and covered with regenerated leather

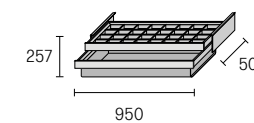

Ripiano con organizer e cesto alto estraibili con frontali in vetro e rivestimento in similpelle / Pull out shelf with organizer and small tray with glass fronts and covered with regenerated leather

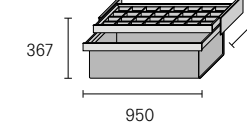

Ripiano e cesto basso estraibili con frontali in vetro e rivestimento in similpelle / Pull out shelf and small tray with glass fronts and covered with synthetic leather

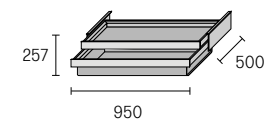

Ripiano e cesto alto estraibili con frontali in vetro e rivestimento in similpelle / Pull out shelf and small tray with glass fronts and covered with regenerated leather

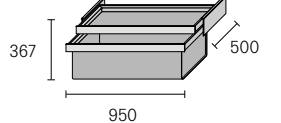

Ripiano in vetro e portapantaloni in alluminio estraibili / Pull out glass shelf and aluminium trousers rack

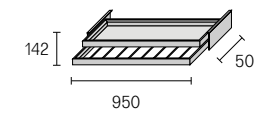

Ripiano e portapantaloni estraibili con frontali in vetro e rivestimento in similpelle / Pull out shelf and trousers rack with glass fronts and covered with synthetic leather

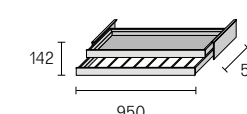

Ripiano con organizer e portapantaloni estraibili con frontali in vetro e rivestimento in similpelle / Pull out shelf with organizer and trousers rack with glass fronts and covered with synthetic leather

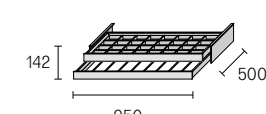

Finiture Finishings

Profilo pannello, profilo laterale, basamento e mensola
Panel profile, lateral profile, base and shelf



Pannello, base e contenitore
Panel, base and cabinet



Interno cassettera
Internal drawer unit



Zoccolino e profilo cassetto
Skirting and drawer profile



Accessori
Accessories

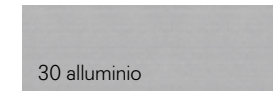

Asta portabiti
Clothes hanger bar

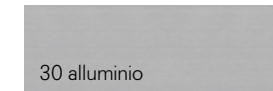

Ripiano estraibile e rivestimento asta portabiti
Pull out shelf and cloth hanger bar



Vassoio estraibile
Pull out rack

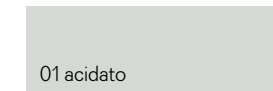

Perseguire la qualità, sempre, sotto tutti gli aspetti. Con questa mission Rimadesio ricerca costantemente soluzioni volte a migliorare i propri standard qualitativi ecologici. Obiettivo ottenuto sinergicamente, grazie all'utilizzo di materiali preziosi e riciclabili, all'assenza di sostanze tossiche per l'uomo e nocive per l'ambiente in ogni fase del processo produttivo,

Streben nach Qualität, unter allen Gesichtspunkten. Mit dieser Mission forscht Rimadesio ständig nach ökologischen Lösungen. Ein Ziel, welches sich aus Synergien ergibt, dank der Verwendung von hochwertigen und recycelbaren Materialien, dem Ausschluss von für den Menschen giftigen und umweltschädlichen Substanzen und den Antrieb der Produktions-

Poursuivre la qualité, toujours, et à tous les égards. Avec cette mission Rimadesio recherche constamment de solutions au fin d'améliorer ses normes de qualité écologique. Objectif atteint, grâce à l'utilisation de matériaux précieux et recyclables, l'absence à chaque étape de la production de substances toxiques nocives pour l'homme et l'environnement, l'utilisation de technologies

Perseguir la calidad, siempre, en todos los aspectos. Con esta misión Rimadesio busca constantemente soluciones destinadas a mejorar sus estándares de calidad ecológica. Objetivo conseguido sinérgicamente, gracias al uso de materiales preciosos y reciclables, a la ausencia de sustancias tóxicas para los seres humanos y nocivas para el medio ambiente en cada etapa

Quality as main purpose, always and in every aspect. With this mission Rimadesio is constantly searching for solutions to improve its own ecological standards.

all'impiego di tecnologie e macchinari evoluti alimentati con energia pulita proveniente da impianti fotovoltaici di ultima generazione, installati sulla copertura dell'headquarter di Giussano. Alluminio, vetro, legno, similpelle, materiali totalmente riciclabili e in parte già riciclati, ma anche le vernici prive di solventi di Ecoloursystem e i sistemi di imballaggio ecologici. Testimonianze di un dna green consolidato e di una coerenza trasversale, segnali di una continua attività di ricerca e di uno sguardo sempre proteso al futuro che si declina nell'innovazione tecnologica di sistemi, porte ed arredi, realizzati con la consapevolezza di voler affidare all'uomo solo attività dall'alto valore aggiunto.

anlagen mit sauberem Strom, welcher durch Photovoltaikanlagen neuester Generation erzeugt wird. Aluminium, Glas, Holz, Kunstleder, völlig recycelbare oder schon recycelte Materialien, aber auch die Lösungsmittelfreien Farben des Ecoloursystems und die umweltfreundlichen Verpackungsmaterialien. Alles Belege für eine fundierte grüne Dna und in einem übergreifenden Zusammenhang. Zeichen für eine kontinuierliche Forschungsaktivität und einen zukunftsorientierten Blick, die sich in den Innovationen der technischen Systemen, der Türen und Möbeln ausdrücken, welche mit dem Bewusstsein entwickelt werden, dem Menschen den größtmöglichen Zusatznutzen zu bieten.

et des machines avancées alimentées par l'énergie solaire après l'installation sur le toit de l'usine à Giussano de systèmes photovoltaïques de dernière génération. Aluminium, verre, bois, simili-cuir, des matériaux entièrement recyclables et déjà en partie recyclés, mais aussi peinture Ecoloursystem sans solvantset systèmes d'emballage respectueux de l'environnement. Témoignages d'un adn "vert" consolidé et d'une cohérence transversale, signes de recherche continue et d'une tendance à regarder en avant, qui correspond bien à l'innovation technologique des systèmes, des portes et des meubles, réalisés avec la conscience que l'apport de l'homme dans la production ne peut qu'avoir un valeur ajoutée.

del proceso de producción, al uso de tecnologías y máquinas avanzadas alimentadas por energía limpia a partir de sistemas fotovoltaicos de última generación, instalados en la cobertura del headquarter de Giussano. Aluminio, cristal, madera, similcuero, materiales completamente reciclables y, en parte, ya reciclados, sino también las pinturas Ecoloursystem libres de disolventes y los sistemas de embalaje ecológicos. Testimonios de un adn green consolidado y una coherencia transversal, señales de una continua investigación y de una vista siempre tendida al futuro que se declina en la innovación tecnológica de sistemas, puertas y muebles, realizados con el conocimiento que desea confiar al hombre sólo actividades de alto valor añadido.

Objective obtained thanks to the use of precious and recyclable materials, to the absence of substances that can be toxic to humans or harmful to the environment in every phase of the productive process, to the use of technology and evolved machinery, powered by clean energy derived from latest generation photovoltaic systems, installed on Giussano headquarters roof. Aluminium, glass, wood, synthetic leather: fully recyclable materials and partly already recycled, but also Ecoloursystem paints without solvents and ecological packing materials. Proofs of a reinforced green dna and wide coherence, signals of a continuous research and a glance directed to the future, that takes shape in the technological innovation of systems, doors and furniture, made with the awareness to entrust just high added value activities.

Vetri laccati Ecolorsystem
Ecolorsystem lacquered glasses

Lucidi Opachi Glossy Mat			Lucidi Opachi Glossy Mat			Lucidi Opachi Glossy Mat			Lucidi Opachi Glossy Mat			Lucidi Opachi Glossy Mat		
40	115	Grigio cenere	53	95	Bianco neve	45	97	Avorio	50	108	Bianco latte	76	116	Rosso india
	121	Azzurro cera	59	105	Grigio chiaro	304	137	Platino	78	114	Sabbia	75	129	Amaranto
35	100	Blu notte	56	98	Lino	85	130	Tufo	74	110	Canapa	84	128	Moro
86	131	Blu oceano	41	104	Grigio ombra	69	126	Palladio	51	113	Nocciola	300	133	Rame
47	96	Grigio perla	88	132	Grigio scuro	57	106	Tortora	52	107	Corda	301	134	Peltro
36	117	Blu Londra	48	103	Grigio ardesia	58	99	Caffè	73	109	Giallo kashmir	83	127	Piombo
	122	Verde inglese				46	102	Nero	43	119	Laguna	302	135	Grafite
									33	111	Verde oliva	303	136	Bronzo



Caratteristiche

Ecolorsystem è la denominazione che contraddistingue l'esclusiva collezione di vetri laccati Rimadesio, disponibili in finitura lucida e opaca. Colori ecologici perchè prodotti utilizzando esclusivamente vernici all'acqua di ultima generazione, con cottura a 110°C. Una tecnologia produttiva all'avanguardia nell'ambito del vetro, con impianti interni totalmente robotizzati che assicurano risultati di altissima qualità e un ciclo di lavorazione a basso impatto ambientale. Resistenza alla corrosione conforme alla norma UNI EN ISO 9227. Resistenza agli sbalzi di temperatura conforme alla norma UNI 9429. Colori inalterabili nel tempo perchè applicati sulla superficie interna del vetro, al sicuro da macchie, polvere e umidità. Lo spessore del vetro crea un esclusivo effetto di "profondità".

Vetri laccati lucidi

Superficie perfettamente liscia. Brillantezza equivalente a 100 gloss. Vetri non trasparenti, caratterizzati dall'alto potere riflettente. Resistenza alla graffiatura superiore rispetto alle convenzionali superfici laccate.

Vetri laccati opachi

Superficie con effetto vellutato al tatto. Vetri non trasparenti, caratterizzati da un effetto di opacità molto marcato. Microsolcatura superficiale che conferisce un'elevata resistenza alla graffiatura. Refrattari alle impronte digitali.

Characteristics

Ecolorsystem is the name that distinguishes the exclusive Rimadesio lacquered glass collection in glossy and mat finishing. Ecological colours produced, using exclusively water paints of latest generation, cooked at 110° C. Cutting edge production technology in the area of glass, with a fully robotised in-house plant, that ensures very high quality results and a low environmental impact work cycle. Corrosion resistance conforms to the UNI EN ISO 9227 standard. Temperature fluctuation resistance conforms to the UNI 9429 standard. The colour is inside the double glass, safe from stains, dust and humidity. The thickness of the glass creates an exclusive "depth" effect.

Glossy lacquered glasses

Perfectly smooth surface. Brightness equivalent to 100 gloss. Not transparent glass, characterized by high reflectivity. Higher scratch resistance compared to conventional painted surfaces.

Mat lacquered glasses

Surface with velvet touch effect. Not transparent glasses, characterized by a very marked opacity effect. Surface high resistant to scratching. Refractory fingerprints.

Eigenschaften

Ecolosystem ist der Name der neuen lackierten Glas-Kollektion von Rimadesio. Absolut oekologische Farben, da die modernsten Lackierungen, auf Wasser-Basis, an einer Temperatur von 110° C gekocht werden. Eine fortschrittliche Produktionstechnik in der Glasverarbeitung auf einer vollautomatisierten Anlage, die Ergebnisse höchster Qualität und gleichzeitig umweltfreundliche Verarbeitungsverfahren gewährleistet. Korrosionsprüfung gemäß Bestimmung UNI EN ISO 9227. Temperaturwechselprüfung gemäß Bestimmung UNI 9429. Die Farben sind unveränderlich, weil es auf die innere Oberfläche des Glases, sicher vor Flecken, Staub und Feuchtigkeit aufgetragen. Die Dicke des Glases erzeugt eine einzigartige Wirkung von "Tiefe".

Hochglanzend lackierte Gläser

Glaeser Vollkommen glatte Oberfläche. Helligkeit entsprechend 100 Gloss. Undurchsichtige Glaeser, durch eine hohe Reflektivität gekennzeichnet. Hoehere Kratzfestigkeit zu herkömmlichen lackierten Oberflächen verglichen.

Matt lackierte Gläser

Oberfläche mit "Velvet touch" Effekt. Undurchsichtige Glaeser, gekennzeichnet durch einen Matt-Effekt sehr ausgeprägt. Oberfläche, die eine hohe Resistenz gegen Kratzer gibt. Grosse Widerstand an Fingerabdrücke.

Caractéristiques

Ecolorsystem est le nom qui caractérise la collection exclusive de verres laqués de Rimadesio. Couleurs écologiques, parce que produites en utilisant exclusivement vernis à l'eau de dernière génération, cuites à 110° C. Une technologie de production avant-gardiste dans le domaine du verre, avec des équipements internes entièrement robotisés qui assurent des résultats de grande qualité et un cycle de production ayant un impact très faible sur l'environnement. Résistance à la corrosion conformément à la norme UNI EN ISO 9227. Résistance aux écarts de température conformément à la norme UNI 9429. Couleurs inaltérables parce que appliquée sur la surface interne du verre, à l'abri des taches, poussière et l'humidité. L'épaisseur du verre crée un effet unique de "profondeur".

Verres laqués brillants

Surface parfaitement lisse. Luminosité équivalent à 100 Gloss. Verres pas transparents, caractérisé par une haute réflectivité. Résistance aux rayures supérieure par rapport aux conventionnelles surfaces peintes.

Verres laqués mats

Surface avec effet toucher velours. Verres pas transparents avec caractéristique d'opacité très marquée. Surface avec une haute résistance aux rayures. Réfractaires aux empreintes digitales.

Características

Ecolorsystem es la denominación que marca la exclusiva colección de los cristales lacados Rimadesio, disponibles en acabado brillante y opaco. Colores ecológicos porque productos utilizando exclusivamente pinturas al agua de última generación, con cocción a 110° C. Una tecnología productiva a la vanguardia en el ámbito del cristal, con unas instalaciones internas totalmente robotizadas que aseguran resultados de altísima calidad y un ciclo de tratamiento respetuoso del medio ambiente. Resistencia a la corrosión conforme a la norma UNI EN ISO 9227. Resistencia a las variaciones de temperatura conforme a la norma UNI 9429. Colores inalterables en el tiempo, porque aplicados en la superficie interna del cristal, al resguardo de manchas, polvo y humedad. El grosor del cristal crea un exclusivo efecto de "profundidad".

Cristales lacados brillantes

Superficie perfectamente lisa. Brillantez equivalente a 100 gloss. Cristales no transparentes, del alto poder reflectante. Resistencia a las rayas mucho más alta que las convencionales superficies lacadas.

Cristales lacados opacos

Superficie con efecto aterciopelado al tacto. Cristales no transparentes, del característico efecto de opacidad muy marcado. Microsurcos superficiales con alta resistencia a las rayas. Refrattarios a las huellas dactilares.

40	Grigio cenere	53	Bianco neve	45	Avorio	78	Sabbia	76	Rosso india
38	Azzurro cera	59	Grigio chiaro	304	Platino	74	Canapa	75	Amaranto
35	Blu notte	56	Lino	85	Tufo	51	Nocciola	84	Moro
86	Blu oceano	41	Grigio ombra	69	Palladio	52	Corda	300	Rame
47	Grigio perla	88	Grigio scuro	57	Tortora	73	Giallo kashmir	301	Peltro
36	Blu Londra	48	Grigio ardesia	58	Caffè	43	Laguna	83	Piombo
39	Verde inglese					33	Verde oliva	302	Grafite
								303	Bronzo

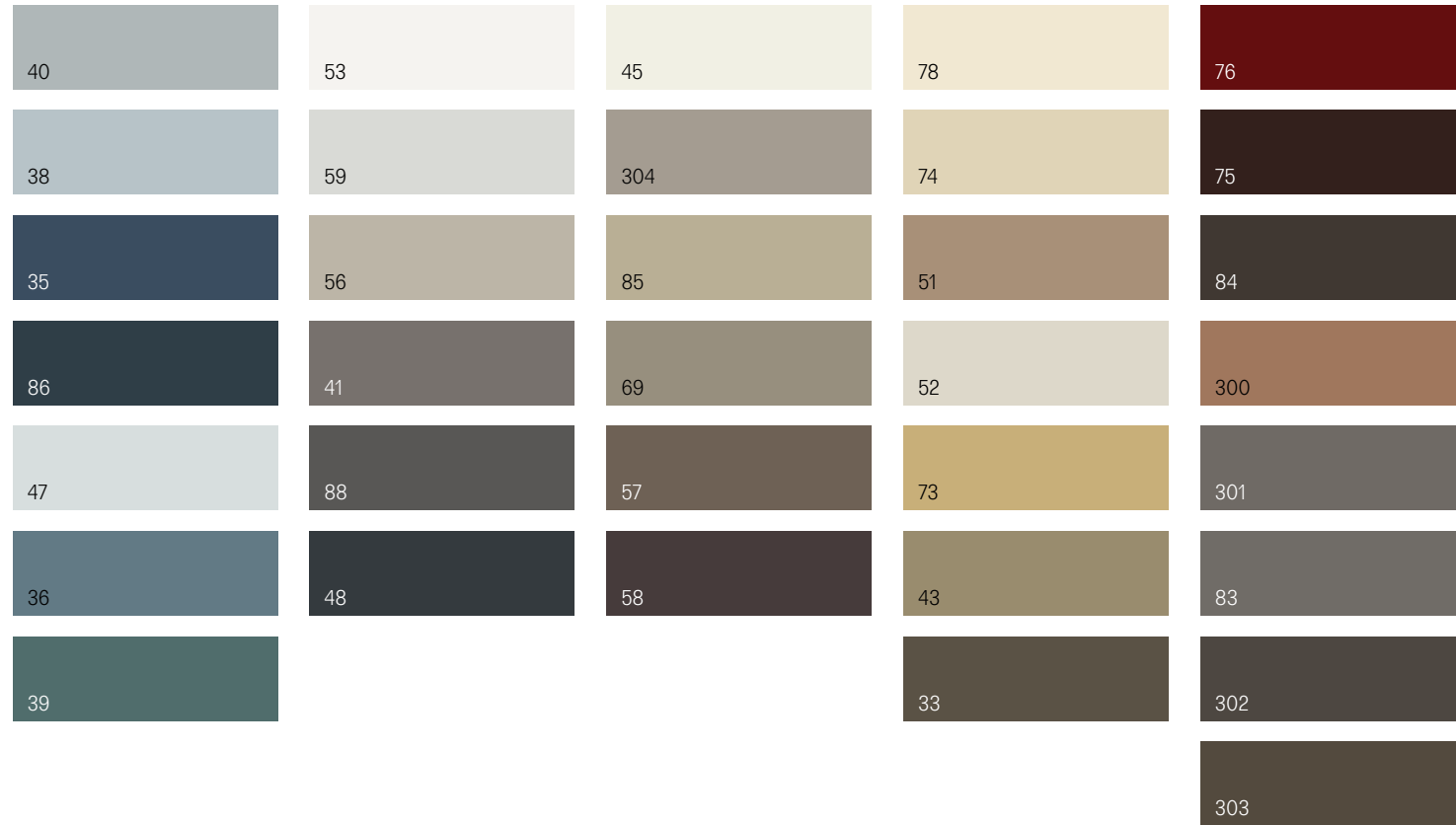

Caratteristiche

Ecolorsystem è la denominazione che contraddistingue l'esclusiva collezione di laccature opache Rimadesio, realizzate su componenti metallici, in legno e plastici. Colori ecologici perché prodotti utilizzando esclusivamente vernici all'acqua di ultima generazione, con cottura a 70° C. Una tecnologia produttiva all'avanguardia, con impianti interni robotizzati che assicurano risultati di altissima qualità e un ciclo di lavorazione a basso impatto ambientale. Resistenza alla corrosione della vernice ad acqua conforme alla norma UNI EN ISO 9227. Resistenza agli sbalzi di temperatura della vernice ad acqua conforme alla norma UNI 9429. Resistenza al distacco dello strato di vernice ad acqua verificato tramite processo di quadratura prima e dopo l'invecchiamento conforme alla norma UNI EN ISO 2409. Resistenza all'usura dello strato di vernice ad acqua mediante sfregamento secondo procedura Catas. Resistenza ai detersivi della vernice ad acqua conforme alla norma EN 12720.

Characteristics

Ecolorsystem is the name that distinguishes the exclusive Rimadesio lacquering collection in mat finishing, realized on metallic, wooden and plastic components. Ecological colours produced using exclusively water paints of latest technology, cooked at 70° C. A modern production technology, with fully robotised in-house plants that ensures very high quality results and a low environmental impact work cycle. Resistance to corrosion of the water paint in compliance with UNI EN ISO 9227 regulation. Resistance to temperature leap of water paint in compliance with UNI 9429 regulation. Resistance to detachment of the layer of water paint checked through the cross-cut test before and after the ageing in compliance with UNI EN ISO 2409 regulation. Resistance to use of the layer of water paint by rubbing according to Catas procedure. Resistance to detergent of water paint in compliance with EN 12720 procedure.

Charakteristik

Ecolorsystem ist die Bezeichnung, welche die exklusive Kollektion der matt lackierten Metall-, Holz- und Kunststoffkomponenten von Rimadesio auszeichnet. Umweltfreundliche Farbpalette, weil bei der Produktion ausschließlich auf 70° erhitzte, wasserlösliche Lacke der neuesten Generation verwendet werden. Eine fortschrittliche Produktionstechnologie mit Robotern welche Ergebnisse höchster Qualität und mit geringstmöglichen Umweltbelastungen sicherstellt. Korrosionsresistente, wasserbasierte Lacke gemäß der EU-Norm UNI EN ISO 9227. Temperaturwechselresistente, wasserbasierte Lacke gemäß der EU-Norm UNI 9429. Die verwendeten Lacke sind gemäß der EU-Norm UNI EN ISO 2409 resistent gegen Ablösung der Lackoberfläche vor und nach dem Alterungsprozess. Resistent bei der Verwendung des Lackes auf Wasserbasis, auf Reibung nach dem Catas Verfahren. Resistenz des Lackes auf Wasserbasis, auf Waschmittel laut Norm EN12720.

Characteristiques

Ecolorsystem est le nom qui caractérise la collection exclusive Rimadesio de laques mates sur pièces métalliques, en bois et en plastique. Couleurs écologiques parce qu'ils sont fabriqués en utilisant des peintures à base d'eau de dernière génération, avec un cuisson de 70°. Une technologie de production avant-gardiste, avec des équipements internes entièrement robotisés, qui assurent des résultats de haute qualité et un cycle de production avec un impact très faible sur l'environnement. Résistance à la corrosion de la peinture à base d'eau en conformité avec la norme UNI EN ISO 9227. Résistance aux écarts de température de la peinture à base d'eau conformément à la norme UNI 9429. Résistance au décollement de la couche de peinture à base d'eau, testée par le processus de coupe transversale avant et vieillissement après en conformité avec la norme UNI EN ISO 2409. Résistance à l'usure de la couche de peinture à l'eau par frottement selon la procédure Catas. Résistance aux détergents de la peinture à l'eau conforme à la norme EN 12720.

Características

Ecolorsystem es la denominación que distingue la exclusiva colección de laca mate Rimadesio, realizadas sobre componentes metálicos, en madera y plásticos. Colores ecológicos porque producidos usando solamente lacas base de agua de última generación, con cocción a 70°. Una tecnología productiva a la vanguardia, con sistemas internos robóticos que aseguran resultados de altísima calidad y un ciclo de producción de bajo impacto ambiental. Resistencia a la corrosión de la pintura a base de agua conforme a la norma UNI EN ISO 9227. Resistencia a los cambios de temperatura de la pintura al agua de conforme a la norma UNI 9429. Resistencia al desprendimiento de capa de laca verificado por medio del proceso de adherencia antes y después del envejecimiento conforme a la norma UNI EN ISO 2409. Resistencia al desgaste de lacapa de pintura de agua mediante el roce según el procedimiento Catas. Resistencia a los detergentes de la pintura al agua conforme a la norma EN 12720.

Collection designed by Giuseppe Bavuso

Art direction: Paolo Mojoli
Graphic project: Iuma
Photo: Santi Caleca, Federico Cedrone
Styling: Patrizia Cantarella with Rossella Ballabio,
Martina Lucatelli, Studiopepe
Technical photo: F2 Fotografia
Render: Alessandro Consonni
Stage setup: Ottonove
Films and print: Optima
Printed in Italy / September 2018

Thanks to: Amini Carpets, B&B Italia, Bang & Olufsen, Baxter,
Boule De Neige, Carrara Design Factory, Carl Hansen & Søn, Ciclotte,
Cecchi & Cecchi, Flexform, Flos, Fritz Hansen, Henry Timi,
Ivano Redaelli, Lika Cappelli, Living Divani, Klippan/mvh, Norrgatan,
Nude Glass, Oluce, Pineider, Pinetti, Pulpo, Rimowa Store Milano,
Society, Suede, Tato Italia, Vitra, When Objects Work.

Awards

1993	Siparium	Young & Design 1993
2000	Zenit	Award KBB
2001	Zenit	selezione Design Index ADI 2001
2002	Siparium	Top100 Frames
2005	Graphis	selezione Design Index ADI 2005
2007	Vela	selezione Design Index ADI 2007
2008	Vela	segnalazione XXI Premio Compasso d'Oro ADI
2015	Wind	winner Red Dot Award 2015
2016	Cover	AZ awards 2016 Best Furniture System
2016	Alambra	selezione Design Index ADI 2016
2017	Sail	selezione Design Index ADI 2017
2017	Soho	AZ awards 2017 Architectural products
2017	Daimon	Interior Design Magazine Best of Year awards

2013 **ADIMEMBER**

Modelli depositati e brevettati / Patented:

Sail, Soho, Velaria, Stripe, Daimon, Graphis, Siparium, Zen,
Zen frame, Moon, Vela, Luxor, Even, Aura, Spin, Link+, Planet, Flat,
Alambra, Abacus living, Cover, Zenit, Dress bold e Abacus.

Marchi registrati / Registered trademarks:

Rimadesio, Ecoloursystem, Siparium.



Rimadesio spa
Via Furlanelli 96
20833 Giussano (Mb) Italy
T +39 0362 3171
F +39 0362 317317
www.rimadesio.it
rimadesio@rimadesio.it

Flagship store Milano
via Visconti di Modrone 26
20122 Milano Italy
T-F +39 02 76280708
milano@rimadesio.it

Italy showroom:
Milano, Roma, Genova, Torino, Como, Brescia, Parma, Firenze,
Pescara, Palermo, Catania, Cosenza.

Worldwide showroom:
Genève, Wien, Nice, Madrid, Barcelona, Bilbao, Marbella, Vigo,
Bruxelles, Munich, Moscow, Saint Petersburg, Istanbul, Beirut, Tehran,
Tokyo, Seoul, Shanghai, Beijing, Hangzhou, Hong Kong, Singapore,
Manila, Hyderabad, New Delhi, New York, Mexico City, Santiago
del Chile, Cape Town, Casablanca.

Follow us on **facebook**