

#21

HENGE

The Last Dance

Index

ACCESSORIES

Himalaya Sartorial Rug	PP.	10, 11, 13, 14, 16, 17
New Zealand Sartorial Rug Rasato	PP.	38, 39, 42, 43

BOOKSHELVES

Bistrot	PP.	52, 53, 54, 55, 56, 57, 75
Web Evo	PP.	9, 10, 11, 13, 25

CHAIRS

Savanna	PP.	52, 57, 58
Chair Va	PP.	70, 71, 72

COFFEE TABLES

Big Bang	PP.	38, 39, 42, 43, 46, 48, 49
SR Table	PP.	10, 11, 13, 14, 16, 17, 18, 21, 22
Plynto	PP.	11, 13, 17

LIGHTING

Light Ring Polygonal	PP.	10, 11, 13
Maple Lamp	PP.	65, 66, 69
Test One	PP.	30, 33, 34, 37, 75
Superb-All Horizontal	PP.	38, 39, 51, 52, 54, 55, 57
Test Tree	PP.	10, 11, 13, 25, 26, 29
Test Two	PP.	38, 41

SOFAS AND ARMCHAIRS

Downtown Sofa	PP.	10, 11, 13, 16, 17, 25
RF Rock	PP.	38, 39, 41, 42, 43, 45
Radical Armchair	PP.	10, 14

TABLES

Time Table	PP.	52, 57, 61, 62, 63
------------	-----	--------------------

Beauty is a necessity to be shared to satisfy the desire we feel and, at the same time, to cultivate its resurgence. Henge continues along its research path, daily renewing its sublime obsession for contrast, uniqueness, and perfect imperfection.

#21 collection is an opportunity to taste the appealing charm created by the brand together with Massimo Castagna, Ugo Cacciatori and the renowned architecture studio, Yabu Pushelberg.

An unstoppable journey that overcomes all physical and geographical boundaries. Henge pursues materials and their evolution with great instinct, looking for the rarest and most expressive ones, rooted in different cultures and in the most remote international landscapes, combining woods, stones, metals, glass, leathers, and fabrics.

Massimo Castagna renews some of his iconic pieces from recent collections such as the Downtown Sofa. A sofa that stands out for the harmonious balance between the simple geometry and the great comfort provided by the softness of its particular goose padding. The SR Tables see the encounter between the special Ice Onyx and the Swamp Olive Ash (dated from 421 AD) with the new H-Pale Gold Patina structure. A contemporary distinctive sign, which imposes itself with a presence of great attractiveness.

























The new series of Test lamps by Ugo Cacciatori represent a new chapter of Henge in the interpretation of light. The large Test-One table lamp surprises at first sight. It evokes a modern cylinder finding its expression through the different materials: white like the moon in the polished Ice Onyx, mysterious as a dying star with the Rapolano travertine that shows glimpses from the stratified cavities. A series of lamps that are hardly missed.

































The collaboration between Henge and Yabu Pushelberg is persisting after the success of the previous collections. The company and the design studio have been mutually attracted to each other by a common design philosophy, an appreciation for details, craftsmanship, beauty, and the strength of the natural world. From this admiration for organic forms, already explored in the past with the Mushroom and the Puddle tables, Yabu Pushelberg, for the first time, interprets lighting for the brand, conceiving a new product, the Maple Lamp, inspired by the seeds of the maple tree. The strong architectural imprint is embodied in the sand casted bronze structure that supports the harmonious shapes of the illuminated body in borosilicate glass. Another gem of design and technique enriching the Henge universe.













Technical information

Accessories

HIMALAYA SARTORIAL RUG

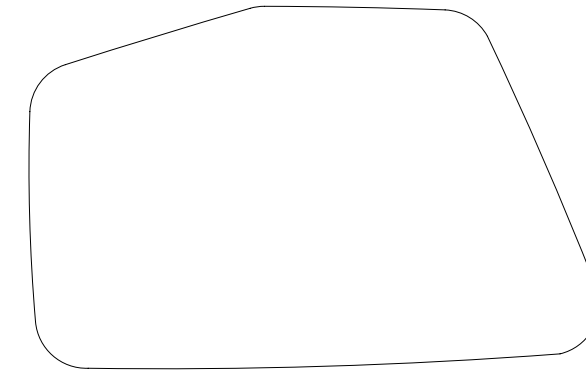

STRUCTURE

5 cm high hand-woven rugs on horizontal looms, finished with a knotting on the back. Made in Nepal using Himalayan wool, the most precious in the world, with only a limited production per year. Color obtained from the selection of the fleece of the sheep themselves. 100% natural, undyed wool. Spun, carded and knotted by hand, washed with sapid soap and hazelnuts that release a natural detergent. Edges tapered by hand on all sides. Completely organic product.

DIMENSIONS

Cm 520x517x5h

Cm 558x355x5h

Cm 550x328x5h

Cm 650x358x5h

Indicative dimensions, maximum variations of $\pm 3\%$

Size can be customized

HIMALAYA SARTORIAL RUG 520X517 H 5

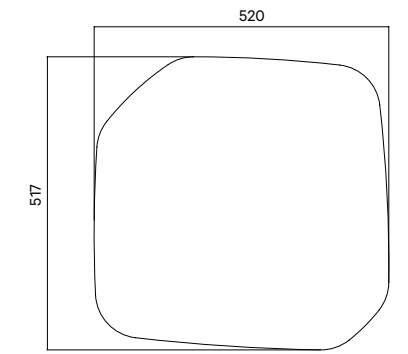

HIMALAYA SARTORIAL RUG 558X355 H 5

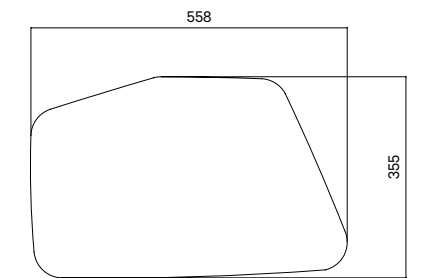

HIMALAYA SARTORIAL RUG 550X328 H 5

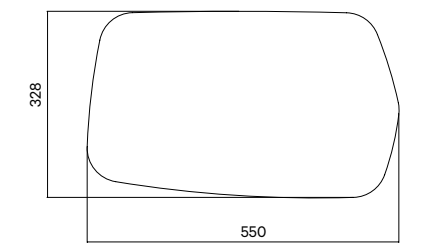

HIMALAYA SARTORIAL RUG 650X358 H 5

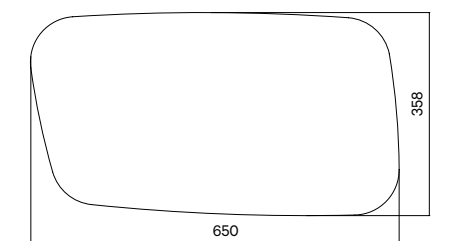

NEW ZEALAND SARTORIAL RUG RASATO

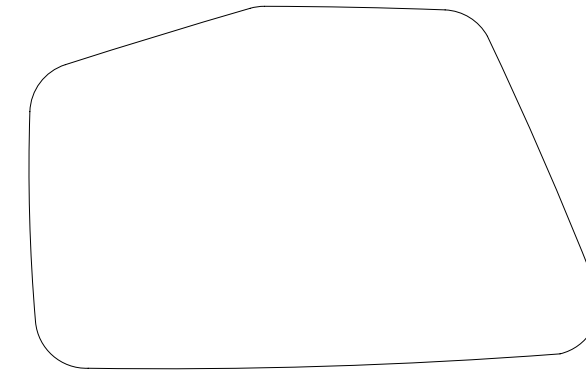

STRUCTURE

2 cm high hand-woven carpets on horizontal looms finished with a knotting on the back. Made with Himalayan wool, dyed in the range colors, hand loom knotted.

DIMENSIONS

Cm 520x517x5h

Cm 558x355x5h

Cm 550x328x5h

Cm 650x358x5h

Indicative dimensions, maximum variations of $\pm 3\%$

Size can be customized

NEW ZEALAND SARTORIAL RUG 520X517 H 5

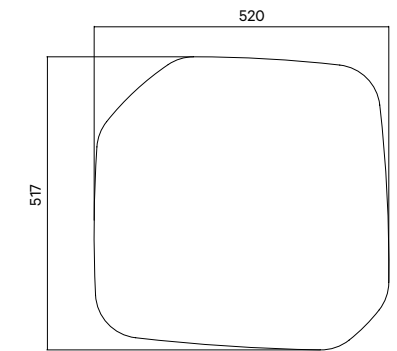

NEW ZEALAND SARTORIAL RUG 558X355 H 5

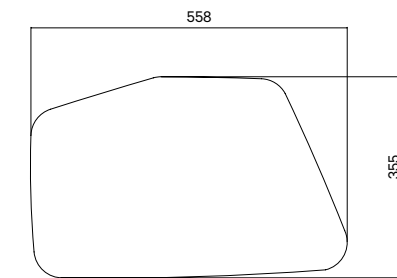

NEW ZEALAND SARTORIAL RUG 550X328 H 5

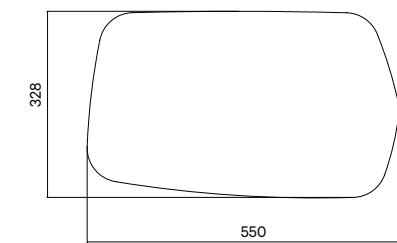

NEW ZEALAND SARTORIAL RUG 650X358 H 5

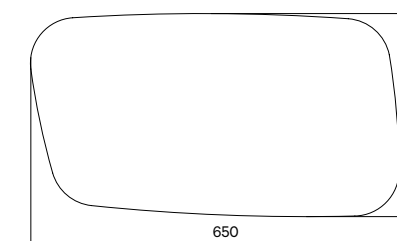

Bookshelves

WEB EVO

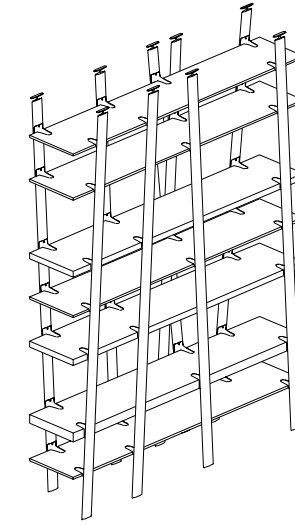

STRUCTURE

Upright in sand casting Peltro.

SHELVES

1,5 cm, 4,6 cm thick solid wood veneer.
Fix shelves as per drawing.

SHELVES FINISHES

Oak Thermowood, Eucalyptus Thermowood, Black
Eucalyptus Thermowood, Swamp Oak and Swamp Elm,
Swamp Olive ash oil finish based on natural wax and water.

DIMENSIONS

Cm 200x48x270h
Cm 250x48x270h
Cm 300x48x270h

BOOKSHELF 200X48X270H

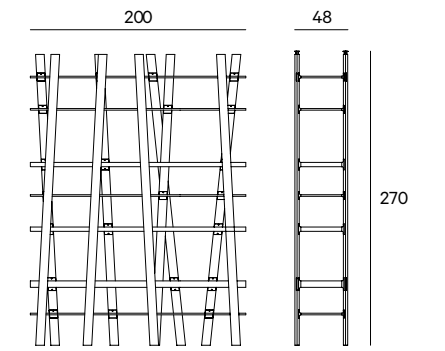

BOOKSHELF 250X48X270H

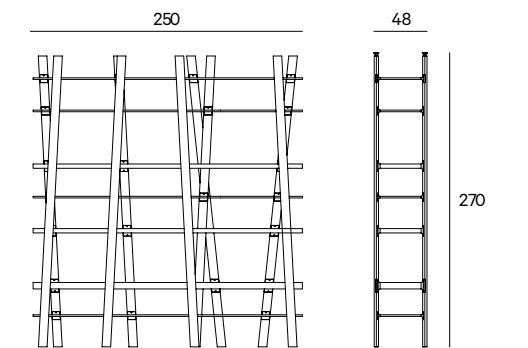

BOOKSHELF 300X48X270H

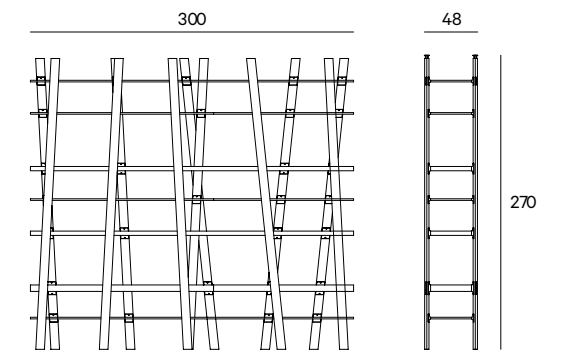

Chairs

CHAIR-VA

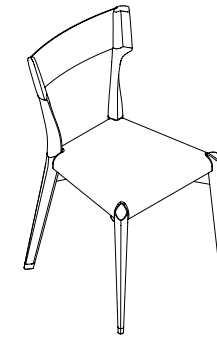

STRUCTURE

Wooden structure in Black Wood, Olive Ash or open pore matt lacquered in selected colours matching with the seat. Seat covered with leather from our sample catalogue. Cover not removable.

BACK REST AND UNDER SEAT BLADES

Burnished Titanio or Platino

DIMENSIONS

Cm 52x57x77h

CHAIR-VA 52X57X77H

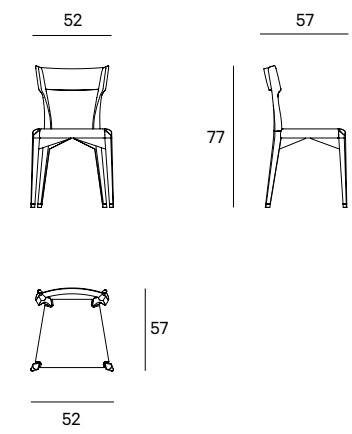

SAVANNA CHAIR

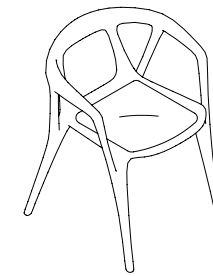

STRUCTURE

Wooden structure finish Black Wood, Olive Ash or open pore matt lacquered in selected colours matching with the chosen leather finish. Seat covered with leather from our samples catalogue. Cover not removable.

DIMENSIONS

Cm 58x53x72h
Seat cm 46h

SAVANNA CHAIR 58X53X72H

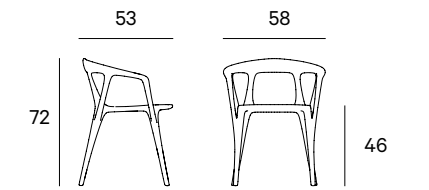

Sofas and Armchairs

RADICAL ARMCHAIR

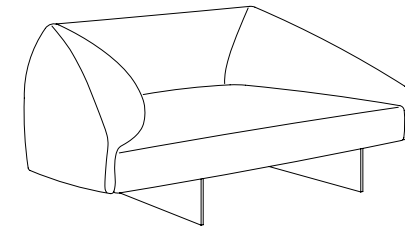

STRUCTURE

Solid wood covered with polyurethane foam in different densities. Seat backrest and armrest padded with polyurethane foam with different densities. Covered with duvet 100% white duck Gold Label, covered with anti-duvet 100% cotton fabric 210g.

BASE

Black burnished steel.

FINISHES OF COVER

Leather from our samples catalogue category 300, 400 or 500.

NON-REMOVABLE COVER

DIMENSIONS

Cm 135x100x64h

RADICAL ARMCHAIR 135X100 H 64

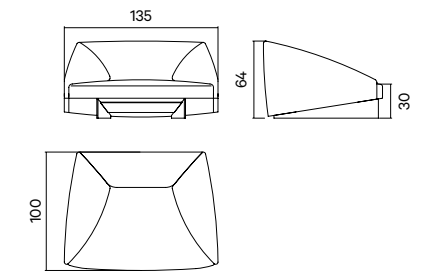

DOWNTOWN SOFA

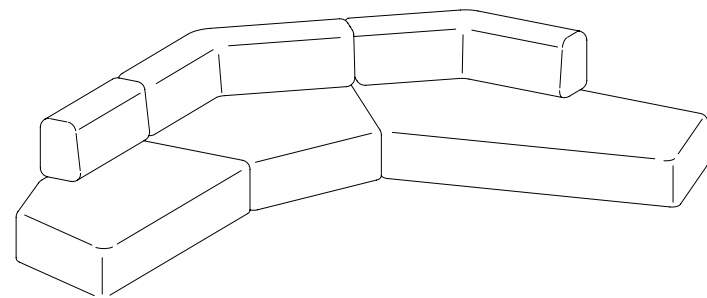

STRUCTURE

Solid wood padded with polyurethane foam, covered with 100% goose down, internal cover in 100% white cotton lining. Seat cushion with high resilience polyurethane foam PF45FR and memory foam, covered with 100% quilted goose down (Assopiuma certified Gold Label), with high density (SR75) structural internal support. Internal cover in 100% white cotton. Metal backrest support.

FINISHES OF COVER

Fabric or leather from our samples catalogue. Non-removable cover.

METAL BACK SUPPORT FINISHES

Black burnished steel, Burnished Platino, Burnished Titanio, Burnished brass

DIMENSIONS

Cm 100x75h
Seat cm 43h

NB Right/Rh and Left/Lh indicate the position of the armrest when facing the sofa.

DOWNTOWN SOFA "A" SX/LH 170X100 H 75

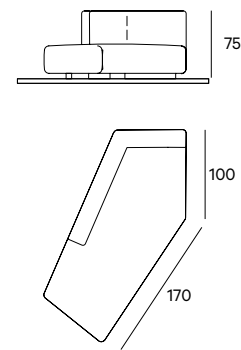

DOWNTOWN SOFA "A" DX/RH 170X100 H 75

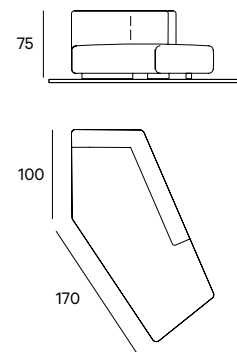

DOWNTOWN SOFA "B" SX/LH 190X100 H 75

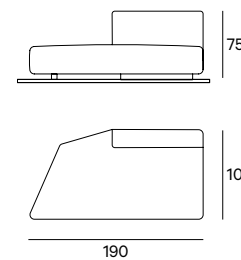

DOWNTOWN SOFA "B" DX/RH 190X100 H 75

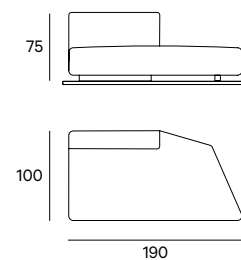

DOWNTOWN SOFA "C" SX/LH 200X100 H 75

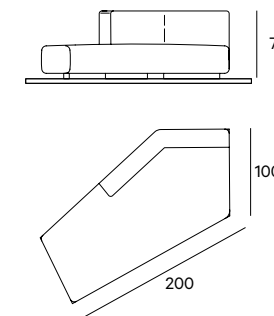

DOWNTOWN SOFA "C" DX/RH 200X100 H 75

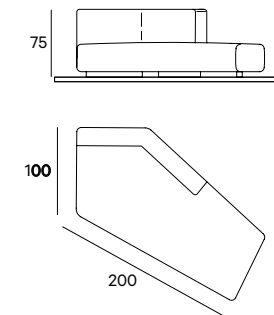

DOWNTOWN SOFA "D" SX/LH 250X100 H 75

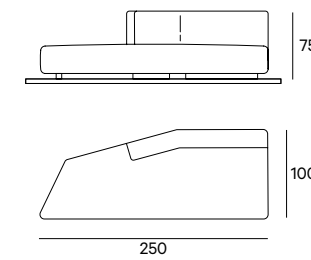

DOWNTOWN SOFA "D" DX/RH 250X100 H 75

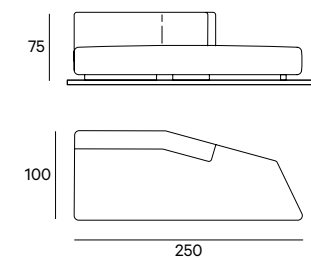

DOWNTOWN SOFA "G" SX/LH 220X100 H 80

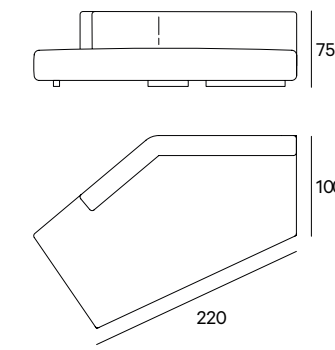

DOWNTOWN SOFA "G" DX/RH 220X100 H 80

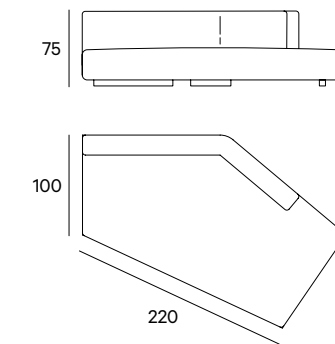

DOWNTOWN SOFA "E" 110X100 H 75

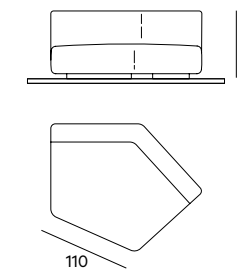

RF ROCK SOFA

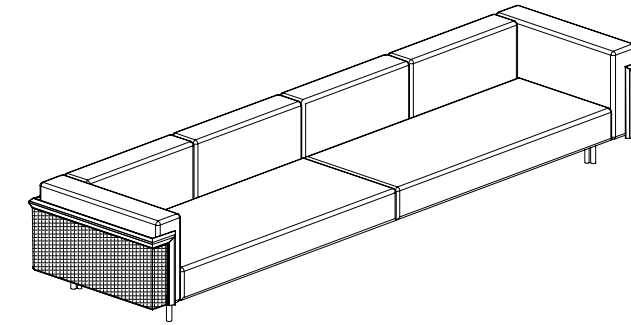

STRUCTURE
Norwegian solidwood.

PADDING
Structure in solid wood with metal mesh.
Seat cushion in Ecolypha 40 with pad in polyurethane T50 and VE40S, covered with duvet 100% white duck Gold Label 280 and anti-duvet 100% cotton fabric 210 gr.
Backrest and armrest cushions in PF25SM, covered with duvet 100% white duck Gold Label 280 and anti-duvet 100% cotton fabric 210 gr.

UPHOLSTERY
Leather or fabric from our range.

WOODEN + METAL MESH
Back structure in solid wood finished in Black Wood or Olive Ash

DIMENSIONS
Cm 170x100x72
Cm 205x100x72

RF ROCK SOFA SX/LH 170X100X72

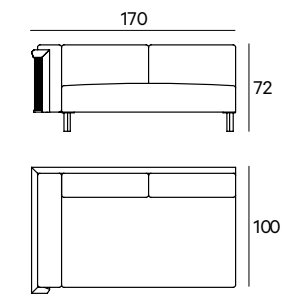

RF ROCK SOFA SX/LH 205X100X72

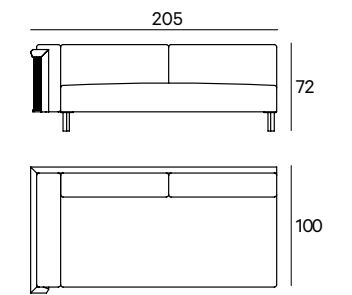

RF ROCK SOFA DX/RH 170X100X72

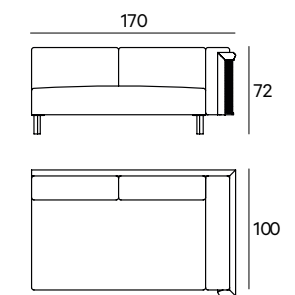

RF ROCK SOFA DX/RH 205X100X72

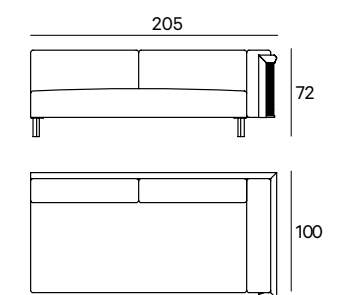

Coffee Tables

BIG BANG



STRUCTURE

Structure in sand casting metals. Nestled top in stone from our samples.

STRUCTURE FINISH

Sandcasting Peltro Sandcasting Brass, Bronze or brass Silver finish.

TOP

Nestled top in stones as per our samples.

DIMENSIONS

Cm 50x50x50h

Cm 70x50x40h

Cm 70x70x40h

Cm 110x110x30h

Cm 140x140x30h

BIG BANG TABLE 50X50 H 50

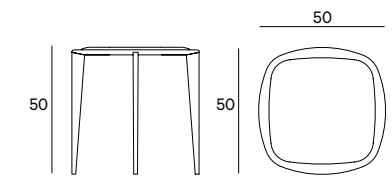

BIG BANG TABLE 70X70 H 40

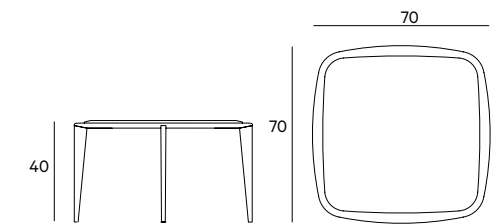

BIG BANG TABLE 70X50 H 40

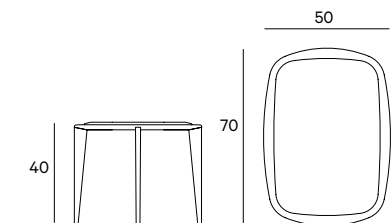

BIG BANG TABLE 110X110 H 30

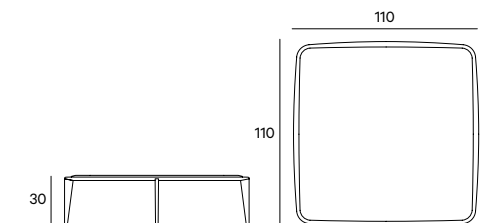

BIG BANG TABLE 140X140 H 30

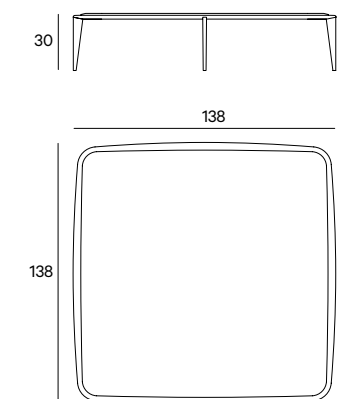

PLYNTO

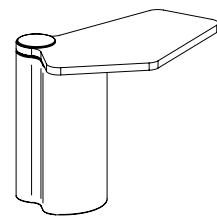

STRUCTURE
Stone structure.

STRUCTURE FINISH
Arabescato stone or Rapolano stone.

TOP
Swivel top in casted glass finish Steel Gray or Apuan Green.

DIMENSIONS
Cm 68x43x54h

PLYNTO 68X43 H 54

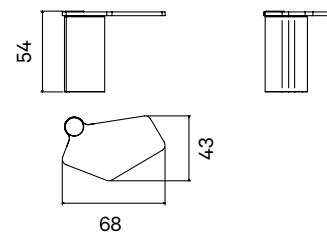

SR TABLE

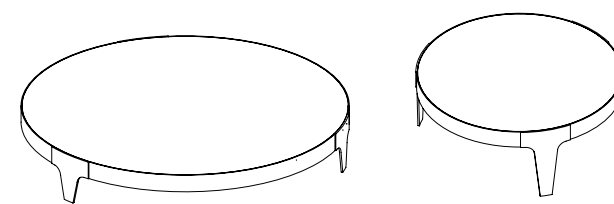

STRUCTURE
0,4 cm steel or brass. 0,8 cm think steel or brass legs.

FINISH
Black burnished steel, Brass, brass Patina, H-Silver®, Silver Patina, H-Pale Gold Patina, burnished by hand using traditional techniques, a result of an exclusive HENGE recipe.

TOP
Top thickness 2 cm.

TOP FINISHES
Swamp Olive Ash, Forest Fusion or Forest Fusion Black, H-Piuma, H-Piuma Light, Titanium foam. Stones as per our samples.

DIMENSIONS
Ø cm 81,6x39h
Ø cm 100x39h
Ø cm 121,6x25h
Ø cm 141,6x25h
Ø cm 160x25h

SR TABLE Ø 161,6 H 25

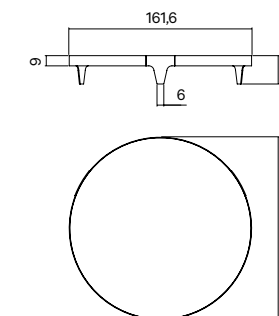

SR TABLE Ø 141,6 H 39

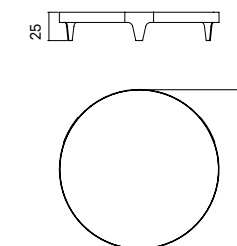

SR TABLE Ø 121,6 H 25

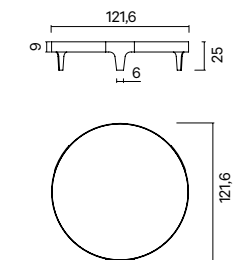

SR TABLE Ø 101,6 H 39

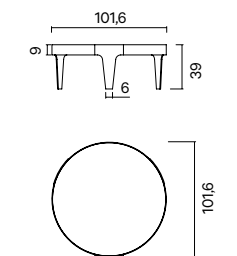

SR TABLE Ø 81,6 H 39

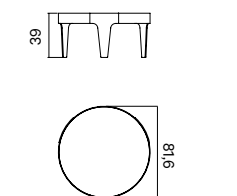

Tables

ZENITH TABLE STONE

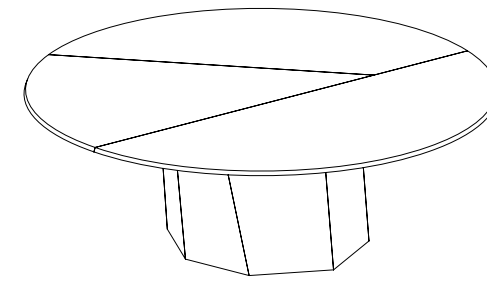

STRUCTURE

Internal structure in steel.
Carter covered with stone from our samples.

TOP

Stones as per our samples (Titanium stone excluded).

DIMENSIONS

Ø cm 170x65h
Ø cm 170x75h
Ø cm 200x75h
Ø cm 220x75h
Ø cm 250x75h

Size can be customized

ZENITH TABLE STONE Ø 250 H 75

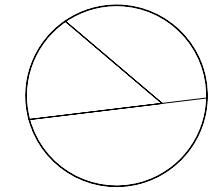
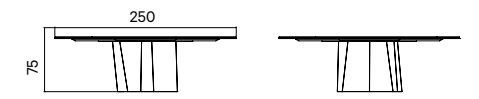

ZENITH TABLE STONE Ø 220 H 75

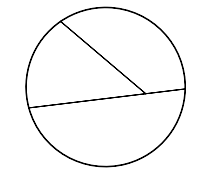

ZENITH TABLE STONE Ø 200 H 75

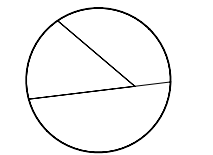
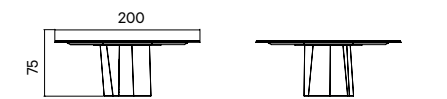

ZENITH TABLE STONE Ø 170 H 75

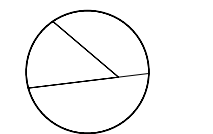
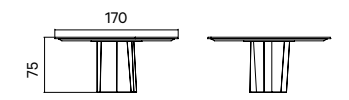

ZENITH TABLE STONE Ø 170 H 65

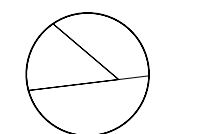
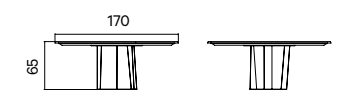

TIME TABLE EVO

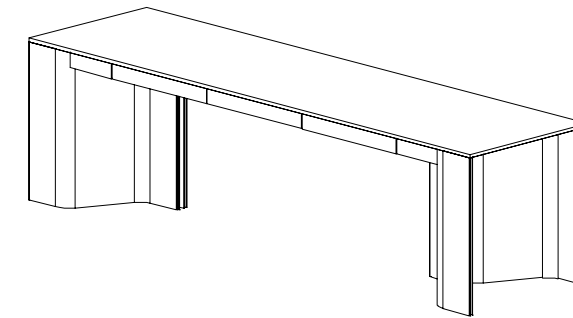

STRUCTURE
Solidwood, thickness 1

FINISH
Heat treated woods as our samples, Swamp Oak
and Swamp Elm oil finish based on natural wax
and water or covered with H-Pale Gold Patina,
Burnished Brass or Black, Burnished Brass.

DIMENSIONS
Cm 280x75x75h

TIME TABLE EVO 280X75X75H

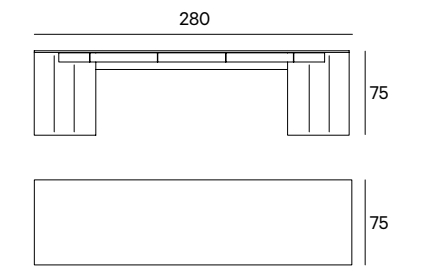

TIME TABLE EVO 240X75X75H

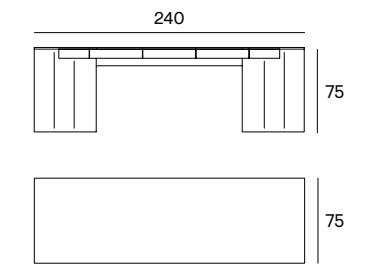

Lighting

TEST-ONE



Sculptural stone table lamp with hollowed monolithic diffuser element connected by a rotating brass ring with a switch and dimmer function.

DIMENSIONS
Cm 80x15x18

TEST-ONE 80x15x18

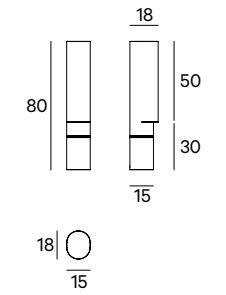

TEST-TWO



Sculptural stone lamp with hollowed monolithic diffuser element connected by a rotating brass ring with a switch and dimmer function.

DIMENSIONS
Cm 130x22x22

TEST-TWO 130X22X22

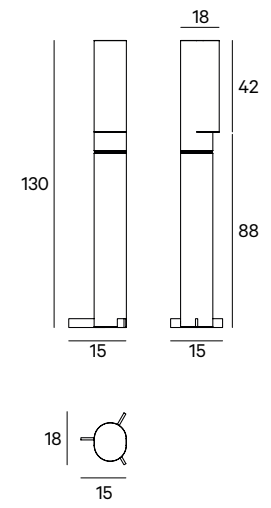

TEST-TREE

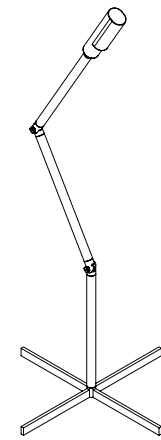

Floor lamp made of stone elements connected by solid burnished brass joints. Omnidirectional head and wide base with cross-shaped brass bars.

DIMENSIONS
Cm 230x87x87

TEST-TREE 230X87X87

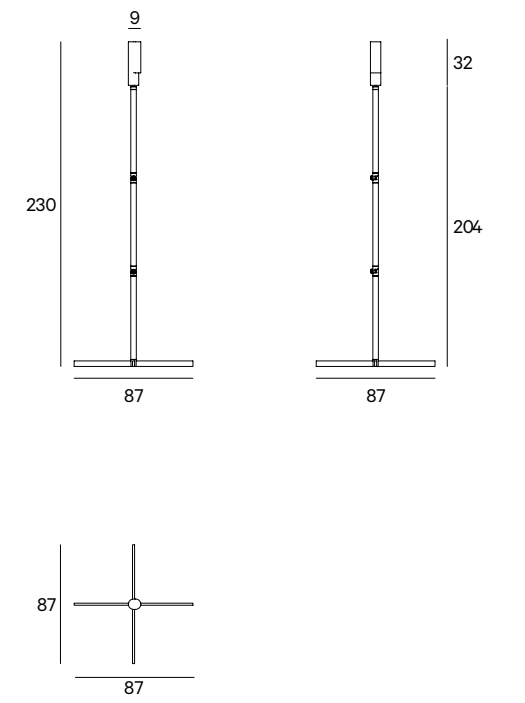

MAPLE LAMP

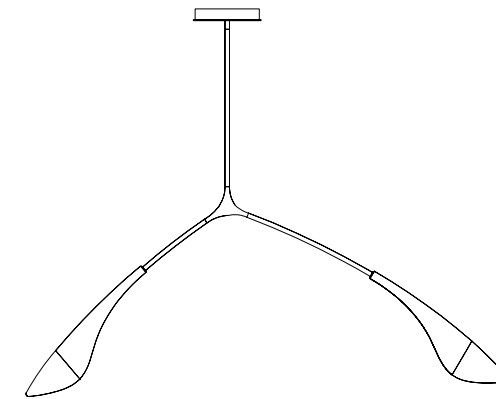

Low consumption LED suspension lamp with brass structure and central Y-shaped body in cast bronze (or brass). Colored borosilicate glass diffuser. Transformer integrated into the ceiling rosette. Light temperature at 3000K.

DIMENSIONS
Cm 147x120

MAPLE LAMP 147x120

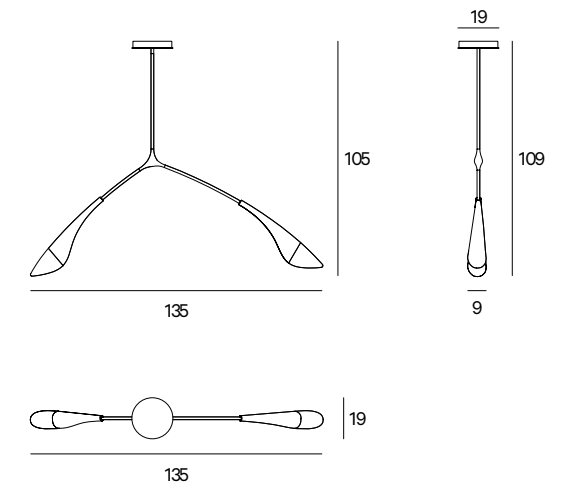

SUPERB-ALL HORIZONTAL

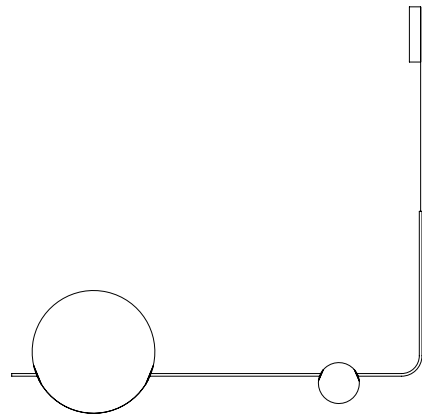

Dimmable ceiling energy-saving led lamp (energy efficiency index A) with warm light. Metal structure and light body in gray fiberglass available in different dimensions. Low voltage power supply cable inside the support rod. Transformer incorporated in the ceiling rosette. Standard overall high 200 cm. Can be customized. Available extra warm light 2700K (without extra cost). Dimmable push bottom, different dimming system available upon request.

FINISH

Black burnished Steel, Burnished Titano, Burnished Platino, Burnished Brass, Black Burnished Brass, H-Silver and H-Silver Black.

DIMENSIONS

Cm 200x160
Cm 200x120

Ø cm 20 – 7,5W 3000K
Ø cm 30 – 15W 3000K
Ø cm 40 – 27W 3000K
Ø cm 60 – 36W 3000K

SUPERB-ALL HORIZONTAL L 200 Ø40-Ø20

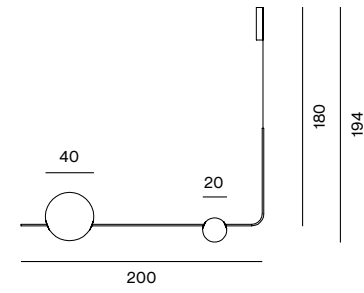

SUPERB-ALL HORIZONTAL L 200 Ø40-Ø30

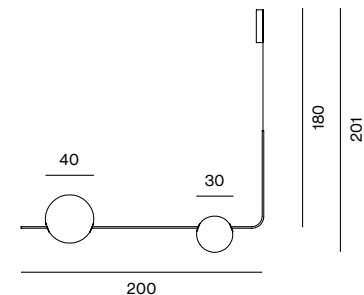

SUPERB-ALL HORIZONTAL L 200 Ø60-Ø20

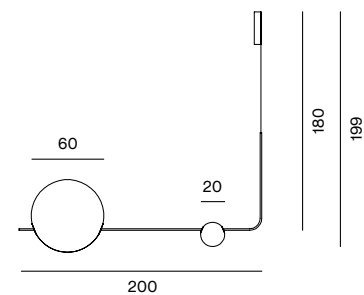

SUPERB-ALL HORIZONTAL L 200 Ø60-Ø30

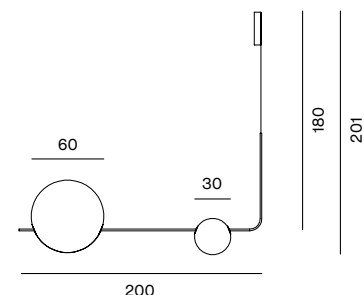

SUPERB-ALL HORIZONTAL L 160 Ø40-Ø20

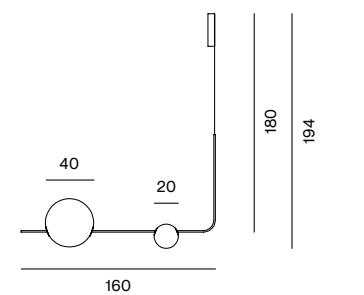

SUPERB-ALL HORIZONTAL L 160 Ø40-Ø30

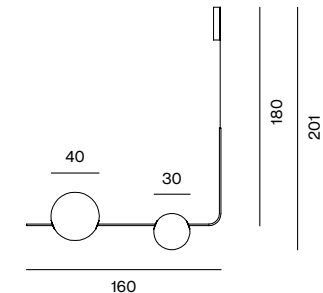

SUPERB-ALL HORIZONTAL L 160 Ø60-Ø20

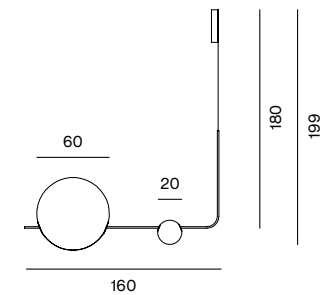

SUPERB-ALL HORIZONTAL L 160 Ø60-Ø30

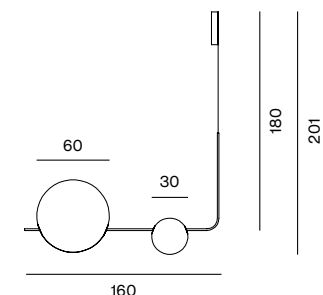

SUPERB-ALL HORIZONTAL L 120 Ø40-Ø20

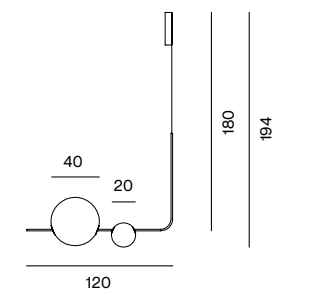

SUPERB-ALL HORIZONTAL L 120 Ø40-Ø30

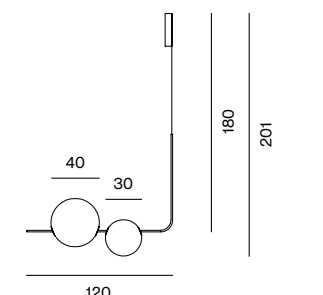

SUPERB-ALL HORIZONTAL L 120 Ø60-Ø20

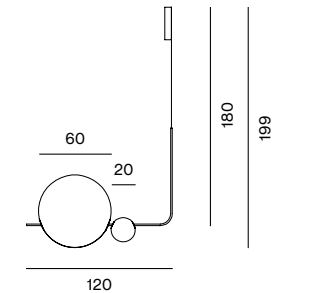

SUPERB-ALL HORIZONTAL L 120 Ø60-Ø30

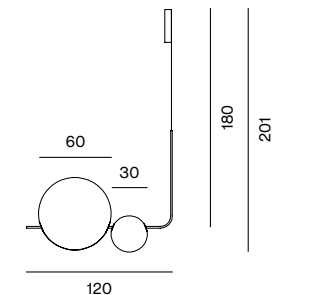

SUPERB-ALL HORIZONTAL L 200 Ø20

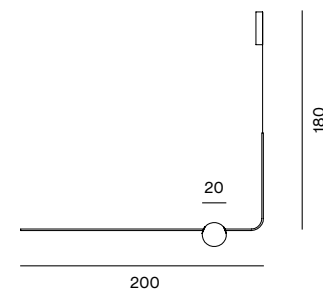

SUPERB-ALL HORIZONTAL L 200 Ø40

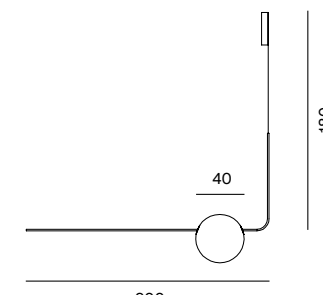

SUPERB-ALL HORIZONTAL L 200 Ø60

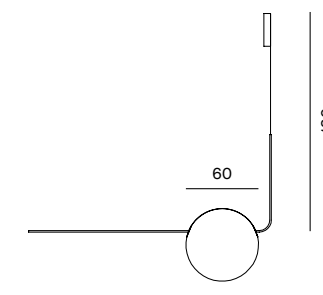

SUPERB-ALL HORIZONTAL L 160 Ø20

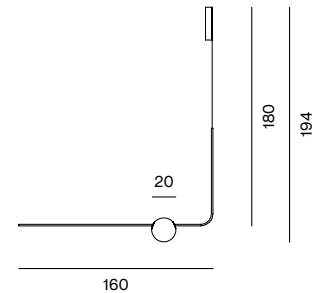

SUPERB-ALL HORIZONTAL L 160 Ø40

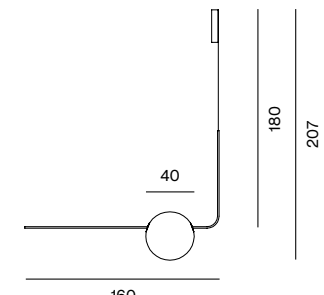

SUPERB-ALL HORIZONTAL L 160 Ø60

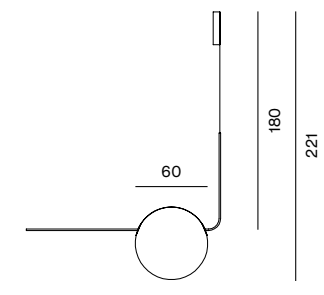

SUPERB-ALL HORIZONTAL L 120 Ø20

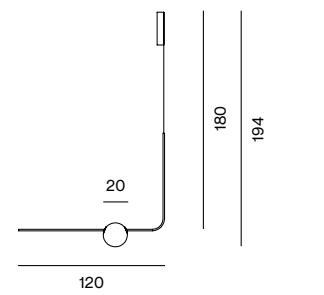

SUPERB-ALL HORIZONTAL L 120 Ø40

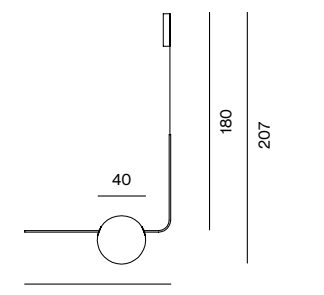

SUPERB-ALL HORIZONTAL L 120 Ø60

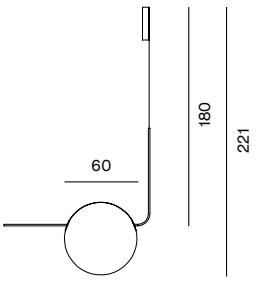

Finishes

BISTROT Structure and shelves in burnished Platino
DOWNTOWN SOFA Upholstered with leather cat 500 Phantom Suede Agave, metal backrest support in burnished Titanio
RADICAL ARMCHAIR Upholstered with leather cat 500 Phantom Nero, base in black burnished Steel
RF ROCK Seat and backrest upholstered with fabric Alcide 101, Metal mesh backrest in Olive Ash
ZENITH Top and base in Ostuni stone
CHAIR-VA Upholstered with leather Phantom Nero. Structure in Black Wood. Backrest in Black Burnished Steel
IS-A CHAIR Upholstered with leather Nabuk Sand 97
BIG BANG Structure in sand casting Titanio, top in the special stone Black Pearl
SR TABLE Top in Swamp Olive Ash. Structure in H-Pale Gold Patina
SR TABLE Top Ice Onyx, structure in H-Pale Gold
PLYNTO Base in Rapolano stone with top in Steel Gray
LIGHT RING POLYGONAL Structure in burnished Titanio
ABACO LIGHT Silver Patina, White Chrystal, H-Silver black
WEB EVO Sand casting Peltro, shelving in Swamp Olive Ash
TEST TREE Ice Onyx, base and joints in burnished brass
TEST ONE Ice Onyx Special Stone
TEST ONE Rapolano Stone
TEST TWO Rapolano Stone
BIG BANG Sand casting Peltro, top in the Special Stone Black Pearl
TIME TABLE H-Pale Gold Patina, Drawers in Swamp Olive Ash
SAVANNA Structure in Olive Ash. Seat in Phantom Suede Polvere
MAPLE LAMP Borosilicate Glass and Burnished Brass. Core in sand casting Brass
LIGHT RING HORIZONTAL XS Outside in burnished brass, inside in brass Patina
HIMALAYA SARTORIAL RUG Himalayan wool color 05
STARLIGHT HORIZONTAL Sandcasting bronze, black burnished brass
SUPERB-ALL HORIZONTAL Structure in burnished brass, spheres in fiberglass
LIGHT RING HORIZONTAL XS Outside in burnished brass, inside in brass Patina
NEW ZEALAND SARTORIAL RUG RASATO Himalayan wool color 4949/21

CONCEPT, ART DIRECTION
Studiogusto

PHOTO ART DIRECTION
Studiogusto

PHOTO
Andrea Pancino Studio
Giuseppe Toja (pp. 33, 37)
Giandomenico Troiano (pp. 69)

GRAPHIC DESIGN
Studiogusto

November 2021

HENGE

Via della Spiga 34
20121 Milano (MI) — Italy
T +39 0438 1710600
atelier@henge07.com
www.henge07.com

Open by appointment

S·34

Office and Factory
Via G. Verdi, 45
31010 Farra di Soligo (TV) - Italy

#21