

Discovery family

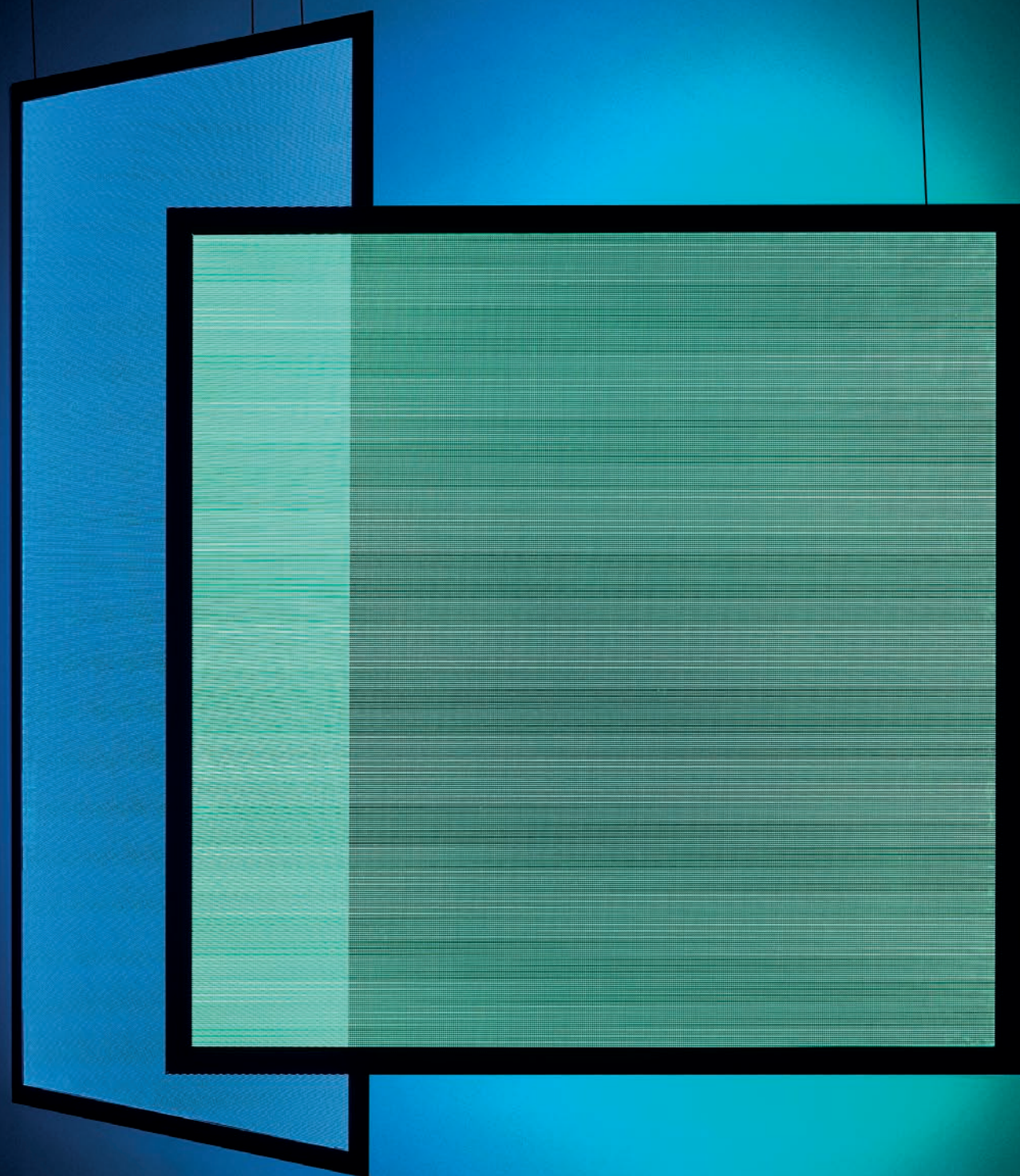

Artemide[®]

Discovery

Ernesto Gismondi

↪ 2015

Discovery is an element that does not invade the environment, totally absent and dematerialized acquires volume when it is turned on thanks to the light that draws the central emitting surface.

In 2018 Discovery was awarded the Compasso D'Oro, for its ability to interpret research, technological and material innovation, know-how and attention to the quality of light for human wellbeing. Discovery is a family of appliances based on minimal geometry. A very light aluminum ring houses an LED strip that injects light into a specially worked surface of transparent PMMA. The diffuser is composed of a perfectly transparent PMMA surface, processed with micro particles so small that the surface is hardly perceptible when the appliance is turned off.

When the appliance is turned on, the transparent interior appears to fill with light as if by magic, as absence is turned into a perfectly diffusing emitting surface.

This unique result is obtained through Discovery's direct and indirect emissions, which produce an embracing and uniform light. Their geometry and layout are calculated to obtain constant emission throughout the surface.

Discovery is an unprecedented development of a well-known optical principle, conveyed through the controlled interaction with matter and a focus on its yield and perceptive qualities.



Artemide
App



red dot design award
2017

Ph. Pierpaolo Ferrari | 2018

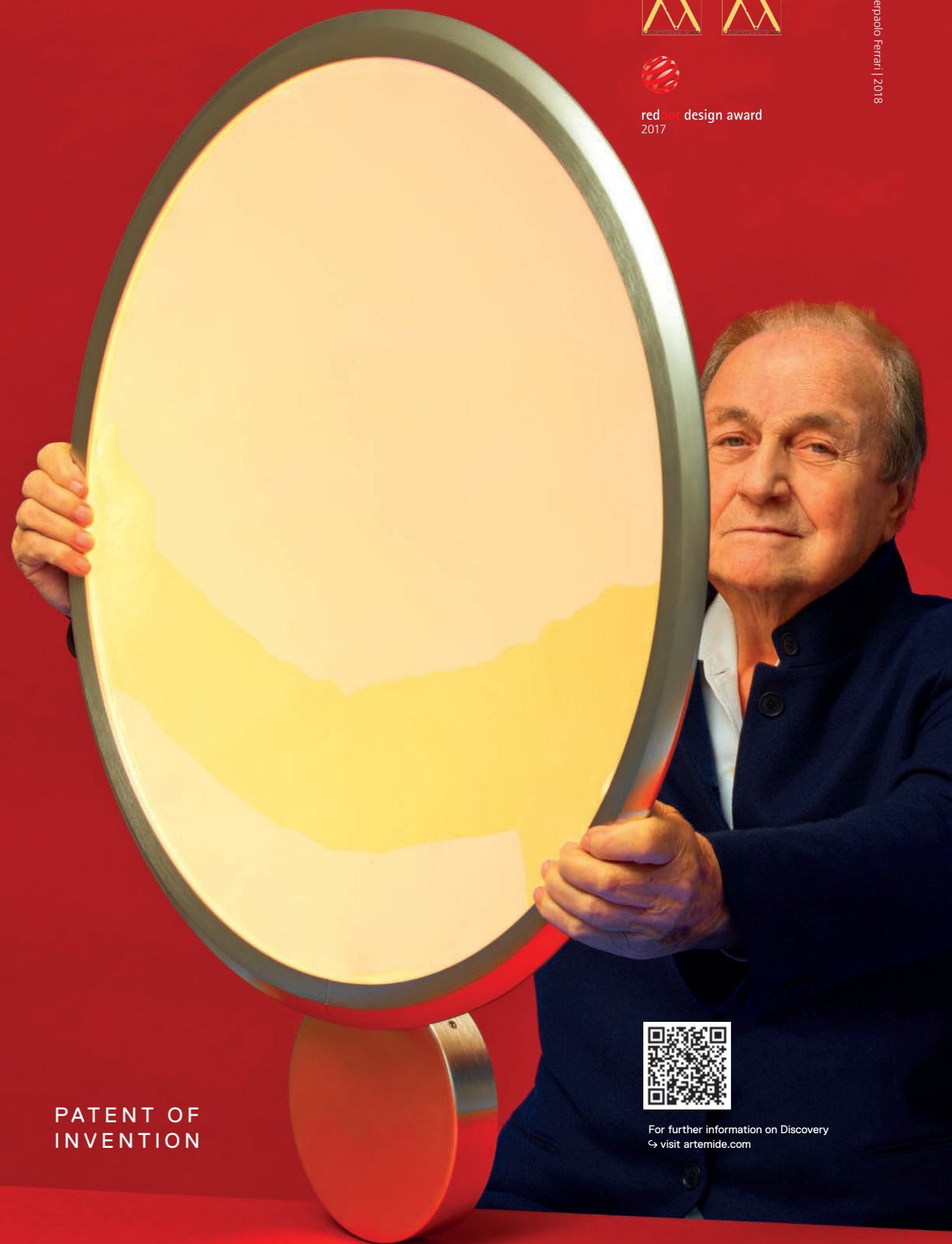

PATENT OF
INVENTION



For further information on Discovery
↪ visit artemide.com



Discovery
is visible

is invisible





3 Sizes 700, 1000, 1400
3 Finishes Silver, Black, Brushed bronze



↗ Patent of Invention

Discovery, thanks to its invention patent, is increasingly the perfect synthesis of Artemide's values, knowledge, innovative research and know-how.

An ultra-lightweight circular aluminium profile houses an LED strip that injects light into a transparent PMMA surface with a pattern of distributed micro-incisions for maximum efficiency and uniformity.



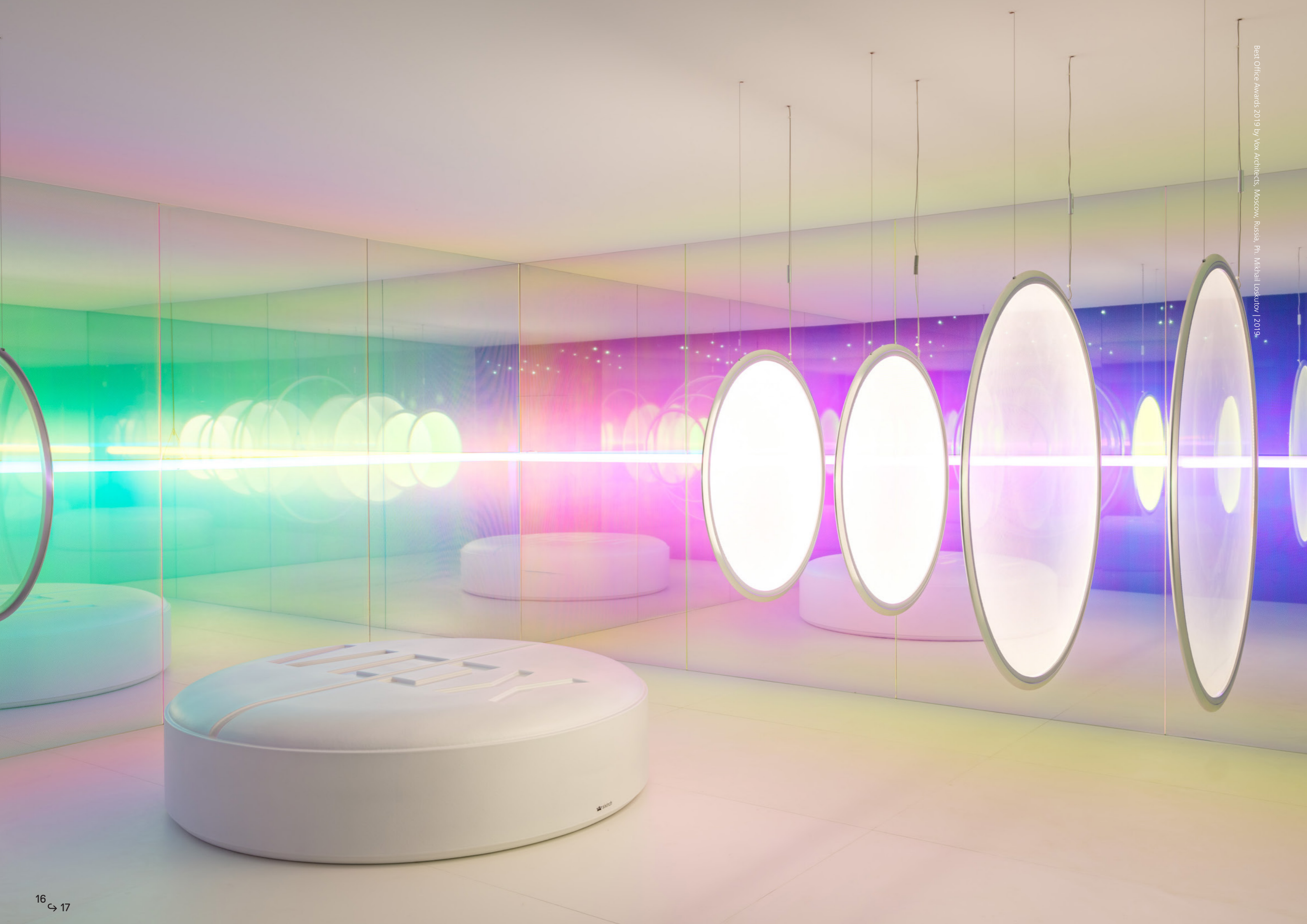

Discovery typologies

SUSPENSION HORIZONTAL



An ultra-light aluminum profile hosts a LED strip that injects light into a technopolymer surface with microengravings.
 The microengravings pattern ensures maximum efficiency and uniformity in direct and indirect emission.
 Dimmable devices (push dimmer).
 Available as suspension and wall/ceiling Ø 700 mm, as vertical suspension Ø 700-1000-1400 mm.

DISCOVERY



XF
 (>45°)
 40 W
 2857 lm



Artemide
 App

SUSPENSION VERTICAL



DISCOVERY VERTICAL Ø700 /
 TW / RGBW

DISCOVERY VERTICAL Ø1000 /
 TW / RGBW

DISCOVERY VERTICAL Ø1400 /
 TW / RGBW

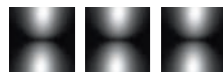

XF (>45°) 40 W 2857 lm	TW (>45°) 57 W 3936 lm	RGBW (>45°) 45 W 2333 lm
---------------------------------	---------------------------------	-----------------------------------



XF (>45°) 60 W 4859 lm	TW (>45°) 82 W 6348 lm	RGBW (>45°) 65 W 3761 lm
---------------------------------	---------------------------------	-----------------------------------

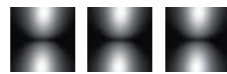

XF (>45°) 80 W 6762 lm	TW (>45°) 115 W 9315 lm	RGBW (>45°) 91 W 5519 lm
---------------------------------	----------------------------------	-----------------------------------

WALL



DISCOVERY WALL



XF
 (>45°)
 40 W
 2857 lm



UGR<19

Uniform and diffuse light suitable for workplaces

High-end and innovative technology

Maximum efficiency and uniformity

Perfectly transparent surface

Extracting light



↗ Discovery wall





↗ RGBW Emissions

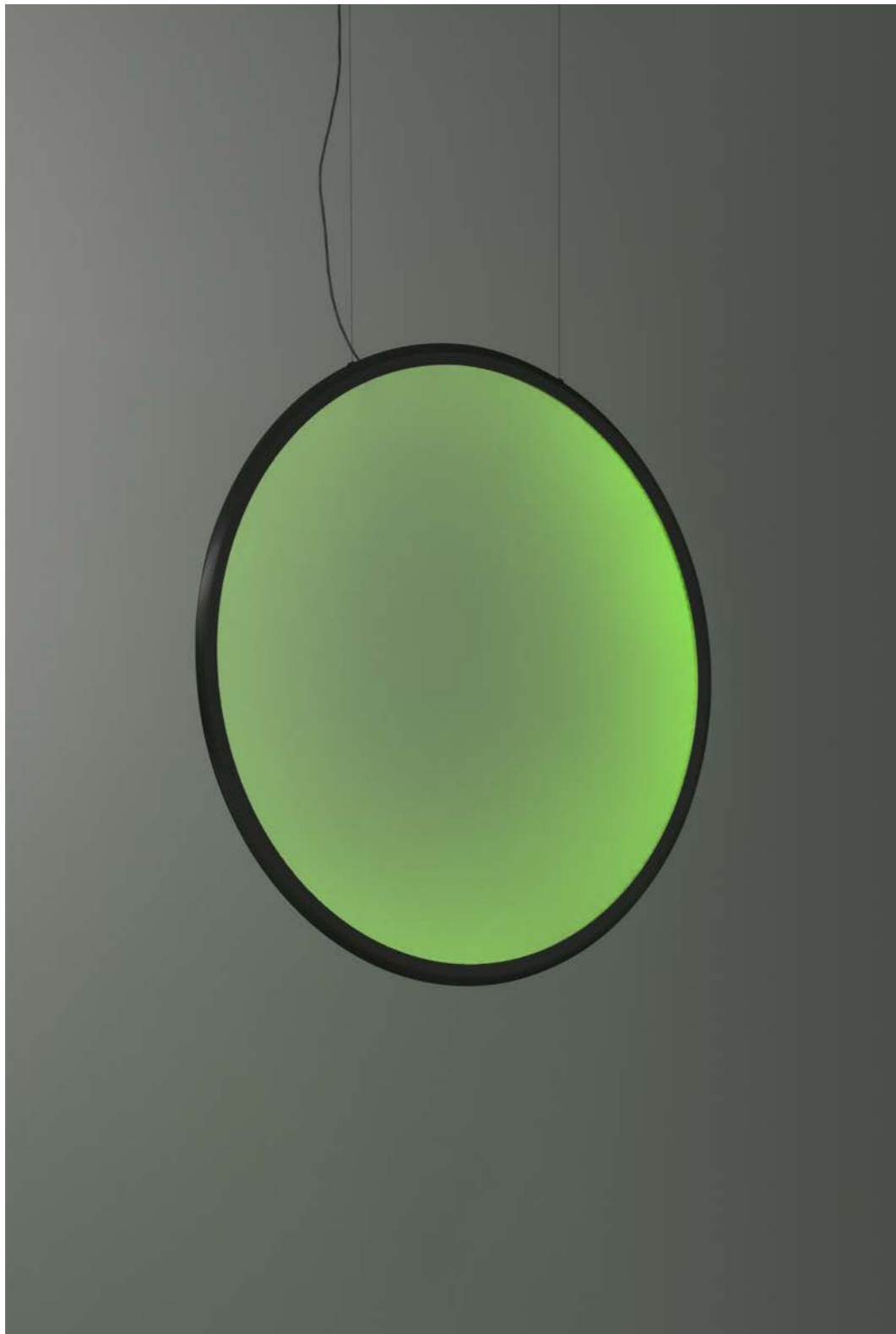

↗ TW Emissions



RGBW



TW



DISCOVERY



The APP driver can not be controlled by DALI dimming system and viceversa.

MacAdam 3SDCM
Life L90 (6K) 50000h
CRI=90

IP20

DISCOVERY WALL

W	Beam	Flux	CCT
40 W	XF	2857 lm	3000K

PUSH
Code
19980.10/30/60.A

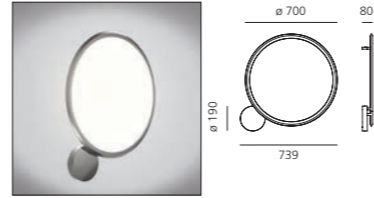

DISCOVERY

W	Beam	Flux	CCT
40 W	XF	2857 lm	3000K

PUSH
Code
19991.10/30/60.A

PUSH & APP
Code
19991.10/30/60.APP

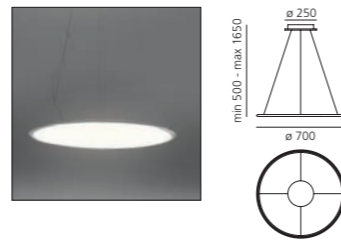

"GAGARIN" International Airport VIP Zone, Saratov, Russia, Ph. Sergey Anan'ev | 2019

DISCOVERY VERTICAL

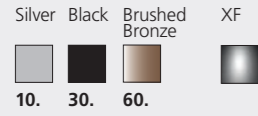

MacAdam 3SDCM
The APP driver can not be controlled by DALI Life L90 (6K) 50000h dimming system and viceversa.
CRI =90

IP20

DISCOVERY VERTICAL SUSPENSION

Ø	W	Beam	Flux	CCT
700 mm	40 W	XF	2857 lm	3000K
1000 mm	60 W	XF	4859 lm	3000K
1400 mm	80 W	XF	6762 lm	3000K

PUSH/DALI
Code
19920.10/30/60.A
19930.10/30/60.A
19940.10/30/60.A

PUSH & APP
Code
19920.10/30/60.APP
19930.10/30/60.APP
19940.10/30/60.APP

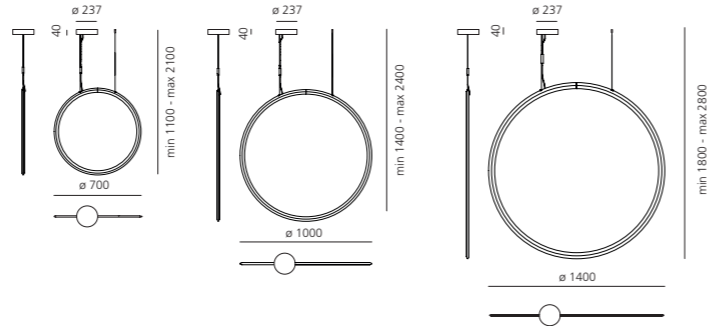

DISCOVERY VERTICAL SUSPENSION TW

Ø	W	Beam	Flux	CCT
700 mm	57 W	XF	Warm - 3739 lm Cold - 3936 lm	2700K-6500K
1000 mm	82 W	XF	Warm - 6029 lm Cold - 6348 lm	2700K-6500K
1400 mm	115 W	XF	Warm - 8848 lm Cold - 9315 lm	2700K-6500K



DALI DT8
Code
19922.10/30/60.A
19932.10/30/60.A
19942.10/30/60.A

APP
Code
19922.10/30/60.APP
19932.10/30/60.APP
19942.10/30/60.APP



DISCOVERY VERTICAL SUSPENSION RGBW

Ø	W	Beam	Flux
700 mm	45 W	XF	RGB 775 lm White 1558 lm
1000 mm	65 W	XF	RGB 1250 lm White 2512 lm
1400 mm	91 W	XF	RGB 1834 lm White 3686 lm

DALI
Code
19923.10/30/60.A
19933.10/30/60.A
19943.10/30/60.A

APP
Code
19923.10/30/60.APP
19933.10/30/60.APP
19943.10/30/60.APP

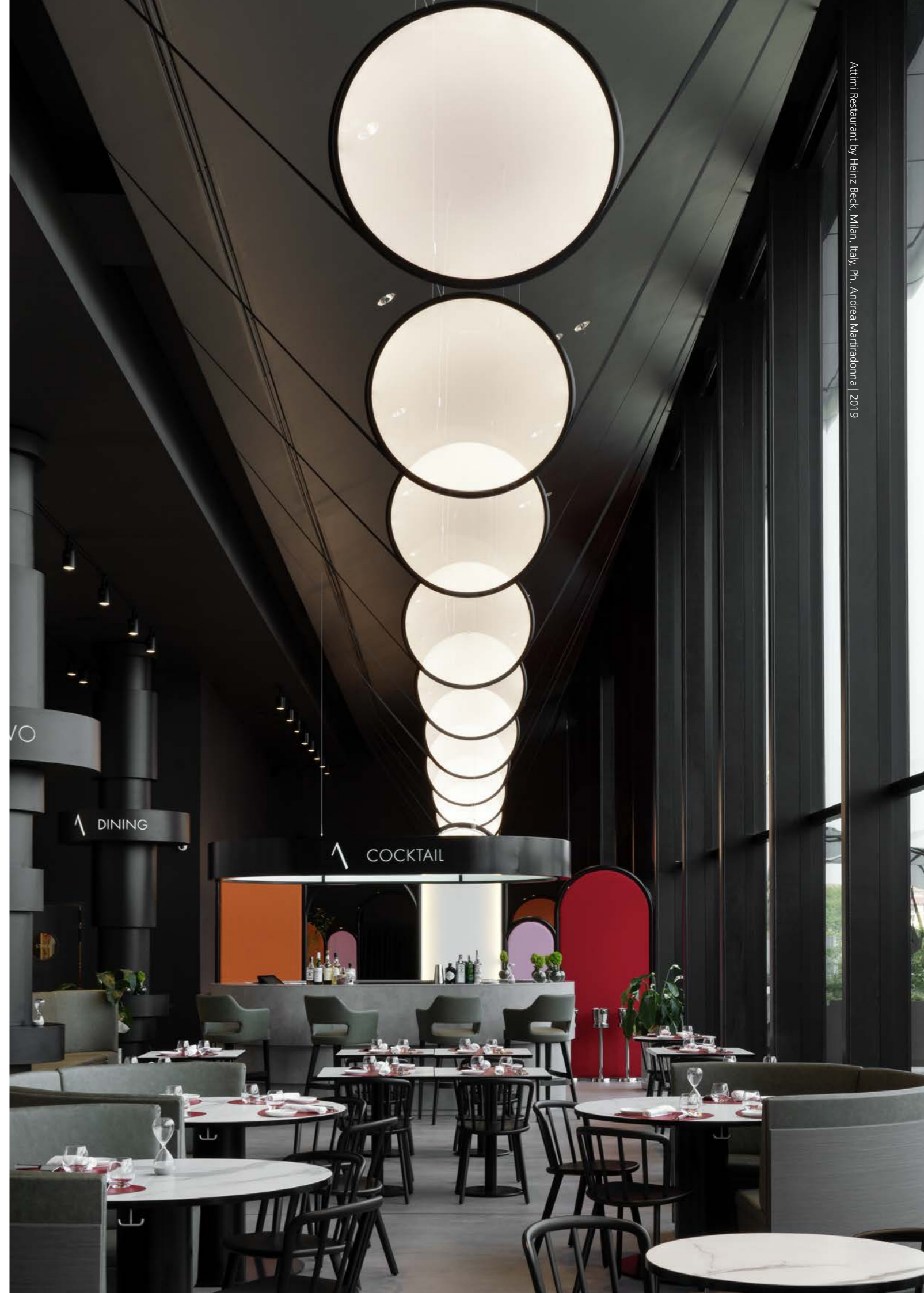
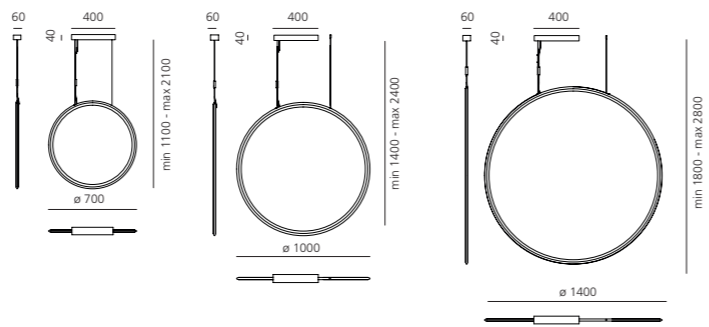
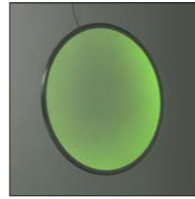

Atimi Restaurant by Heinz Beck, Milan, Italy. Ph. Andrea Marfàdonna | 2019

Discovery Space

Ernesto Gismondi

↪ 2019



↗ Total flexibility
in the space

Discovery Space finishes

Silver, Black, Brushed bronze

Discovery Space typologies

Discovery Space is available in two versions, Square 900x900 and Rectangular 750x1500 with the White, TW and RGBW emissions.

Through the use of two support cables, Discovery Space can be installed both vertically and horizontally, giving the possibility to create different wings that shape the spaces through presence and absence given by its different levels of transparency.

SQUARE

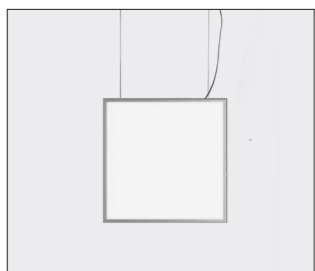

DISCOVERY SQUARE / TW / RGBW

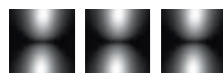

XF (>45°)	TW (>45°)	RGBW (>45°)
34 W	49 W	39 W
1955 lm	2527 lm	1498 lm

RECTANGULAR

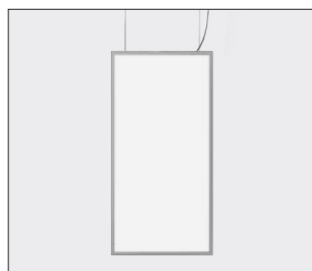

DISCOVERY RECTANGULAR / TW / RGBW



XF (>45°)	TW (>45°)	RGBW (>45°)
52 W	76 W	61 W
4003 lm	5174 lm	3066 lm



Artemide
App

DISCOVERY SPACE

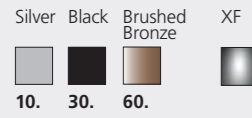

The APP driver can not be controlled by DALI dimming system and viceversa.

MacAdam 3SDCM
Life L90 (6K) 50000h
CRI =90

IP20

DISCOVERY SPACE SQUARE

W	Beam	Flux	CCT
34 W	XF	1955 lm	3000K

PUSH/DALI
Code
20040.10/30/60.A

PUSH & APP
Code
20040.10/30/60.APP

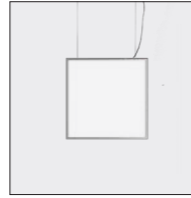

DISCOVERY SPACE SQUARE TW

W	Beam	Flux	CCT
49 W	XF	Warm - 2400 lm Cold - 2527 lm	2700K-6500K

TW[®]
Artemide Tunable White

DALI DT8
Code
20000.10/30/60.A

APP
Code
20000.10/30/60.APP

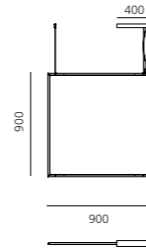

DISCOVERY SPACE SQUARE RGBW

W	Beam	Flux
39 W	XF	RGB 498 lm White 1000 lm

DALI
Code
20010.10/30/60.A

APP
Code
20010.10/30/60.APP

DISCOVERY SPACE RECTANGULAR

W	Beam	Flux	CCT
52 W	XF	4003 lm	3000K

PUSH/DALI
Code
20050.10/30/60.A

PUSH & APP
Code
20050.10/30/60.APP

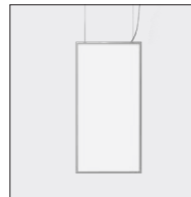

DISCOVERY SPACE RECTANGULAR TW

W	Beam	Flux	CCT
76 W	XF	Warm - 4914 lm Cold - 5174 lm	2700K-6500K

TW[®]
Artemide Tunable White

DALI DT8
Code
20020.10/30/60.A

APP
Code
20020.10/30/60.APP

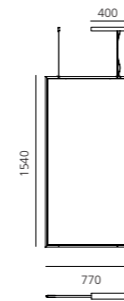

DISCOVERY SPACE RECTANGULAR RGBW

W	Beam	Flux
61 W	XF	RGB 1018 lm White 2047 lm

DALI
Code
20030.10/30/60.A

APP
Code
20030.10/30/60.APP



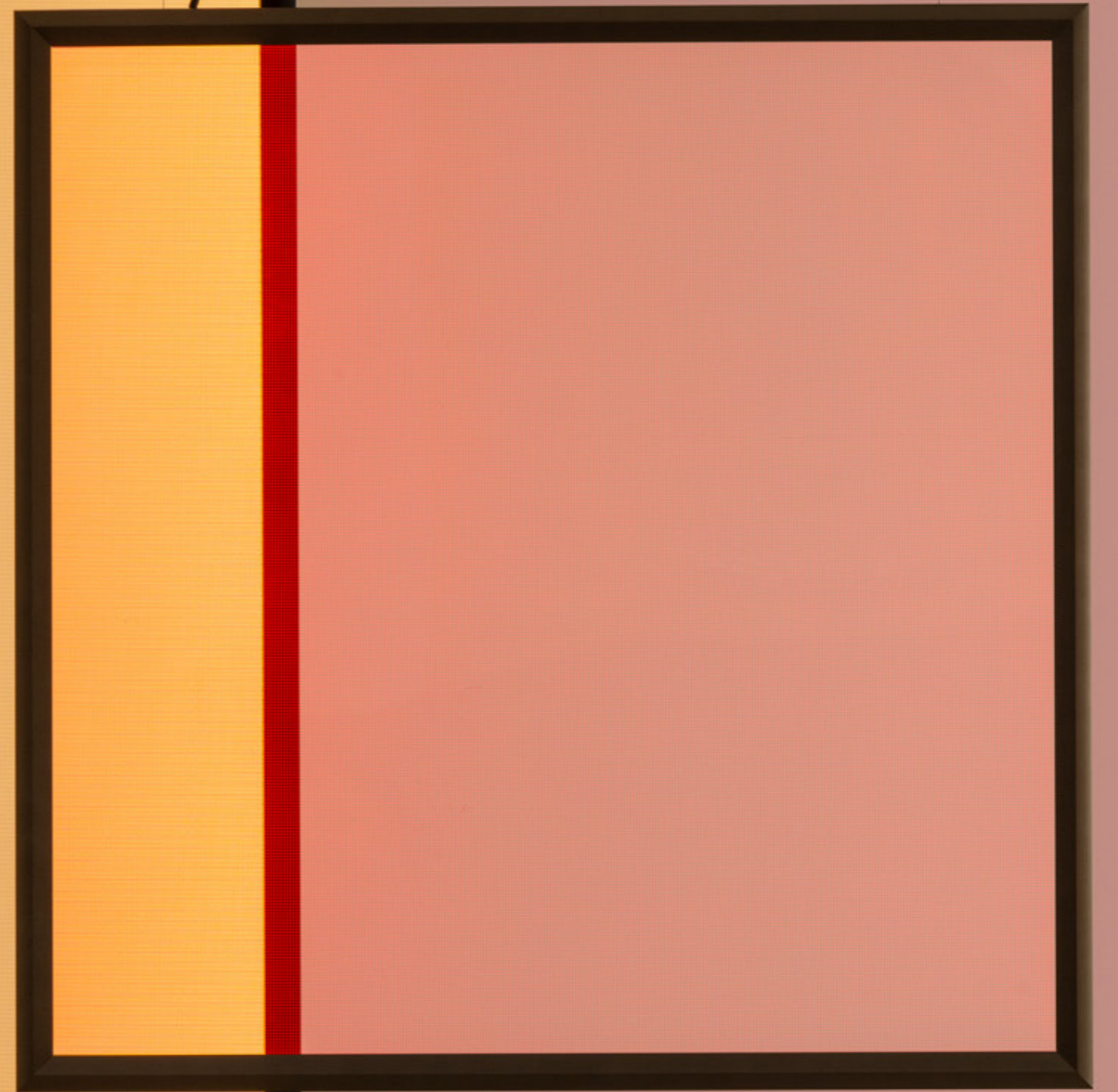

Discovery Family is compatible with **Artemide App**

Artemide App is a user-friendly and intuitive interface used to control individual products, groups of appliances and lighting scenarios. It is a tool that can be associated with several products from both the Design and the Architectural Catalogues.



Download Artemide App
and find more information on
artemide.com

Headquarters

Artemide S.p.A.

Via Bergamo, 18
20010 Pregnana Milanese (MI), Italy
Tel. +39 02 93518.1
Tel. +39 02 93526.1
Numero verde 800 834 093
(from Italy only)
info@artemide.com
artemide.com

Communication and Marketing Department

Via Canova, 34
20145 Milan (MI), Italy
Tel. +39 02.349611
marketing@artemide.com
artemide.com

Artemide S.p.A.

si riserva la facoltà di modificare, in qualunque momento e senza preavviso, le caratteristiche tecniche degli elementi illustrati nel presente catalogo.

Artemide S.p.A.

reserves the right to change, at any time and without prior warning, the technical specifications of any product illustrated in this catalogue.

Artemide S.p.A.

se réserve le droit de modifier, à n'importe quel moment et sans préavis, les caractéristiques techniques des éléments illustrés dans ce catalogue.

Artemide S.p.A.

behält sich das Recht vor jederzeit und ohne Ankündigung die technischen Daten der im Katalog abgebildeten Produkte zu ändern.

Artemide S.p.A.

se reserva la facultad de modificar, en cualquier y sin aviso previo, las características técnicas de los elementos ilustrados en el presente catálogo.



ISO 9001:2015



ISO 14001:2015



ISO 45001:2018