

HENGE

S34 / 1

**HENGE**

Home is a container in which we live experiences and share them with those who are part of our lives. It is the material expression of what we most love, and wish to be surrounded by, each day. It is the oldest form of “social network”, where we live and dream of being connected to our identity, cultivating unique emotions, interactions and bonds. The Home is above all, a dynamic journey, a long-term project that uses physical space to narrate our lives and wrap them up with beauty. It evokes safety and comfort throughout the various stages of our lives. Henge has moved its Home and has created a whole new space, in the center of Milan's Quadrilatero della Moda, Via Della Spiga 34. Just steps away from where it celebrated Milan and the Design Week for 7 incredible years.

The new Home is able to express with full force what, through evolution, consistent curiosity, and experimentation, Henge needs to say, to continue to break the rules and be wonderfully divergent. The new Home is called S34, a space that allows you to immerse yourself and delve into the personality and creative eclecticism that has been a hallmark of Henge's journey over the years. An augmented surface that merges architecture and products in one place. Three levels of light, form, matter, and function to explore.





34

Unique expressive qualities can establish an emotional conversation between the product and the people around it. The secret of this journey that leads to the soul of precious stones stems from an instinctive love for the beauty of an organic universe, one that is able to surprise you and bring out the amazing prodigious elements that nature forges. Textures, veins, and marks unreasonably considered imperfections are now special features thanks to the Brand's extraordinary wealth of manufacturing know-how and artisan craftsmanship.

This is the origin of the superb new collection, designed by Massimo Castagna, designers Ugo Cacciatori and Isabella Genovese, in collaboration with the renowned design firm Yabu Pushelberg. The process is in continuity with the past, but also capable of overcoming limits and boundaries each time arriving at unique pieces, with a perfect combination of design and daring workmanship. Clean lines and bold geometries become hallmarks of the new collection, which, often playing on unexpected contrasts, represents the authenticity of a beauty that will remain unchanged over time.





By using the formal language of modern taste, Henge brings back ancient craftsmanship techniques with new stories that do not need words to be narrated. Some, very rare ones, can speak for themselves in every language, without the need for an interpreter. The Breccia Medicea is one of them. This material brings out emotions, it is a marble able to energize anything surrounding it. Henge fell in love with its unique expressive ability, as it pours out mythical hues, physical manifestation of its emotions.









Henge's search for exceptional materials and the Brand's dedication to enhancing them has always been a journey toward an objective stylistic truth - putting all things in an iconic and organic balance. This is the key that makes #22 Collection the natural continuation of an ambitious journey that can look into the future with a new perspective.



BISTROT  
CHAIR-VA  
SISMA  
SUPERB-ALL  
TEST-ONE



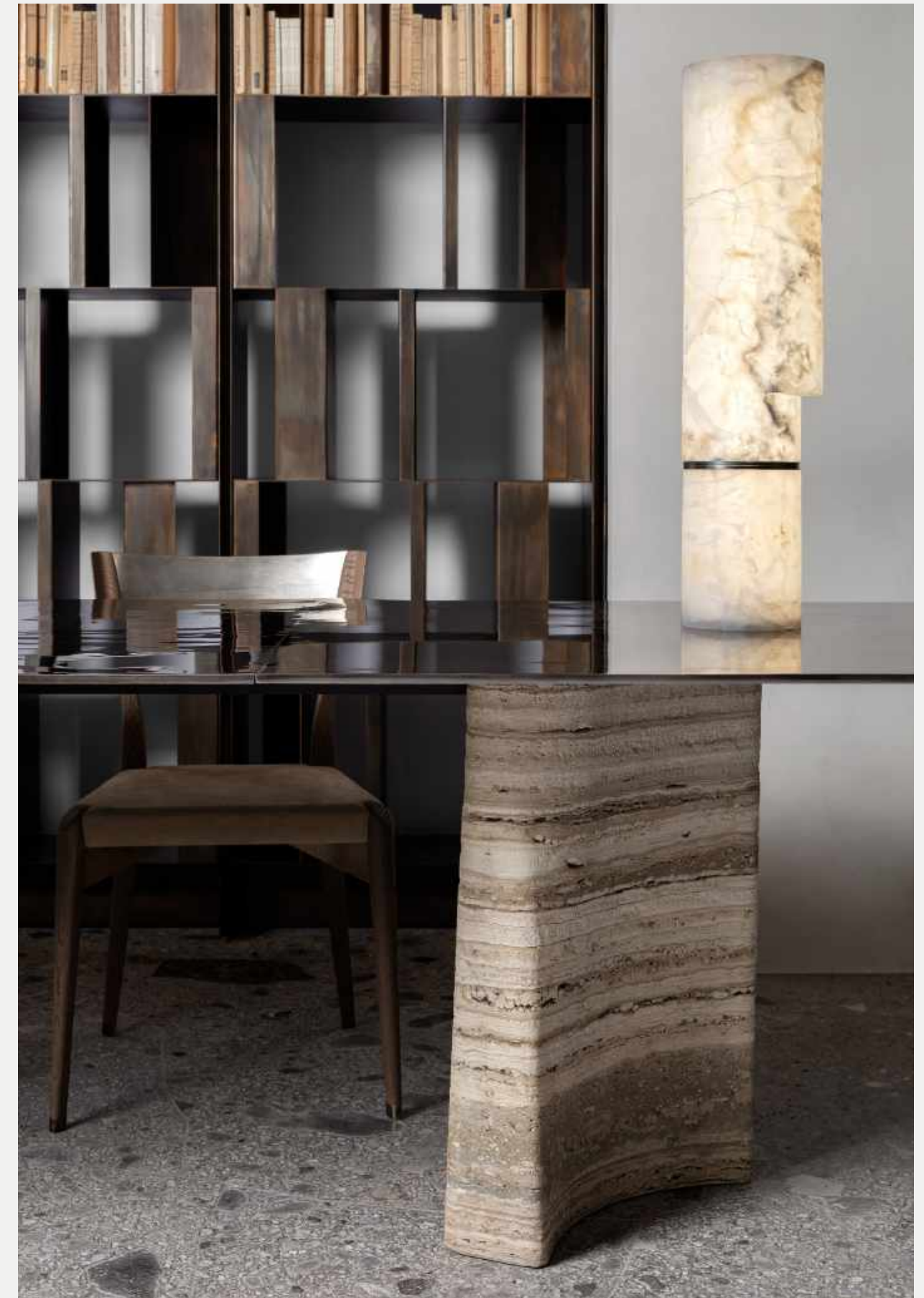











CAGE PURE  
GLADIO  
GOTHAM  
NEW ZEALAND RASATO  
SAVANNA  
SPYDER

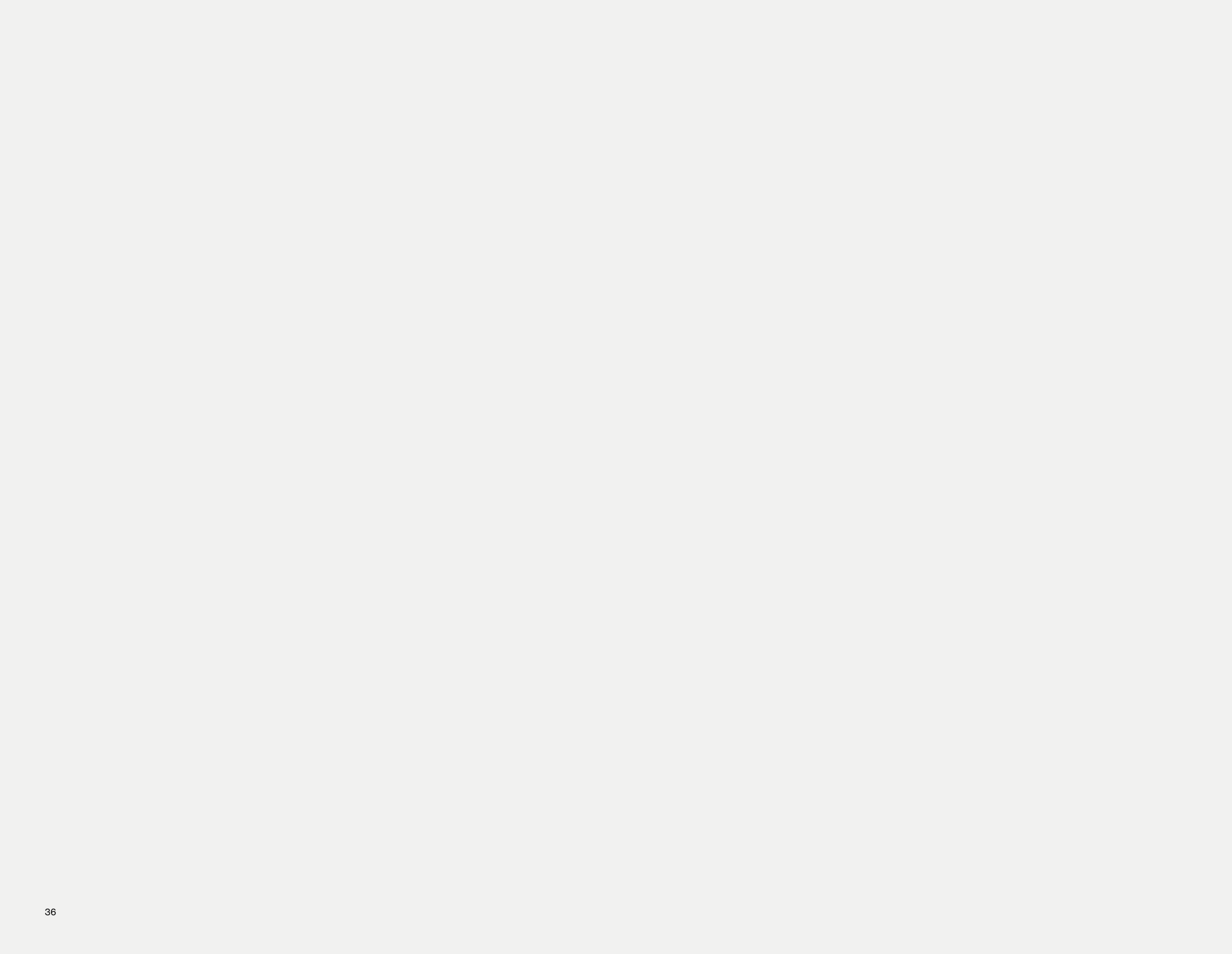

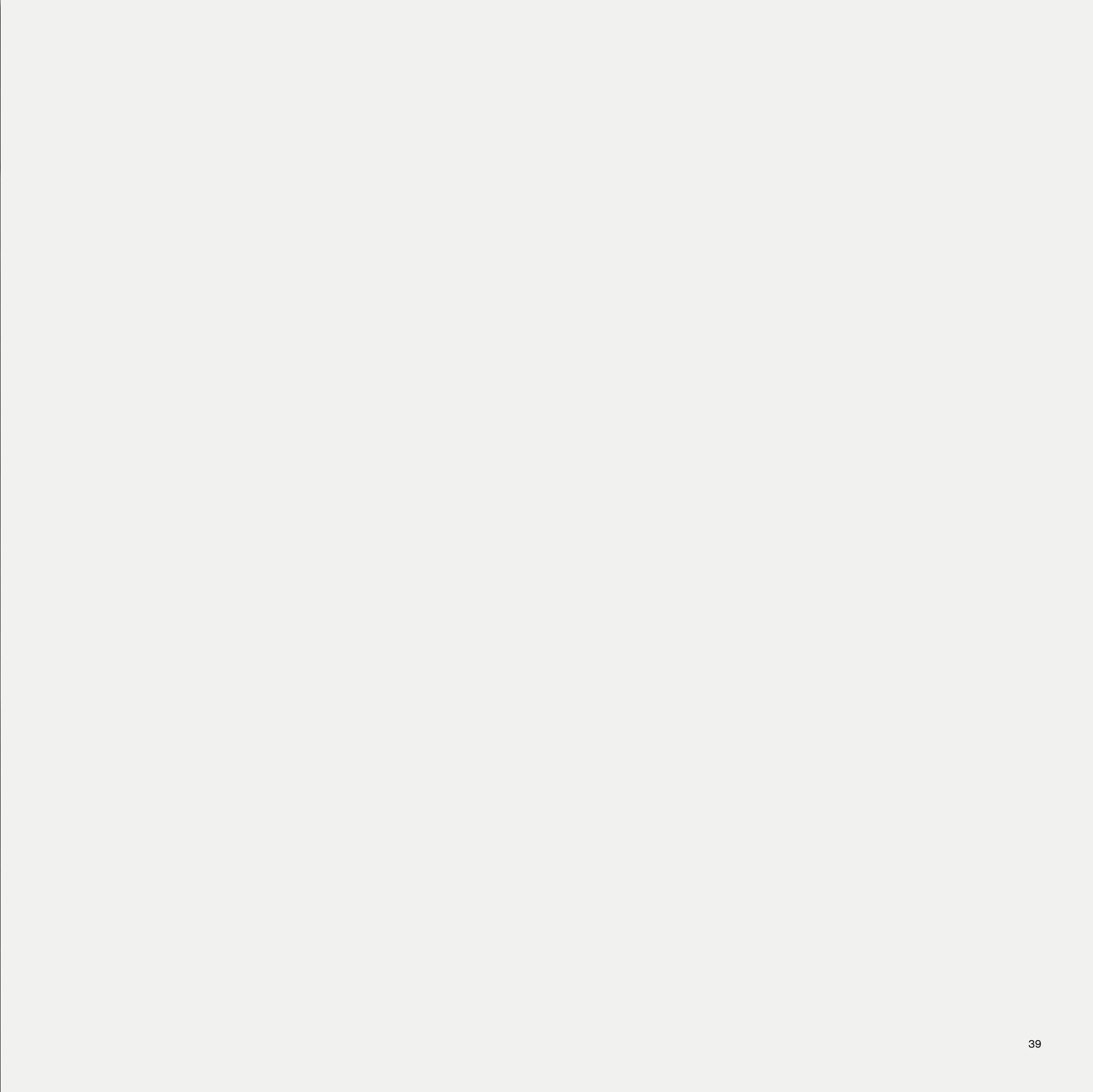



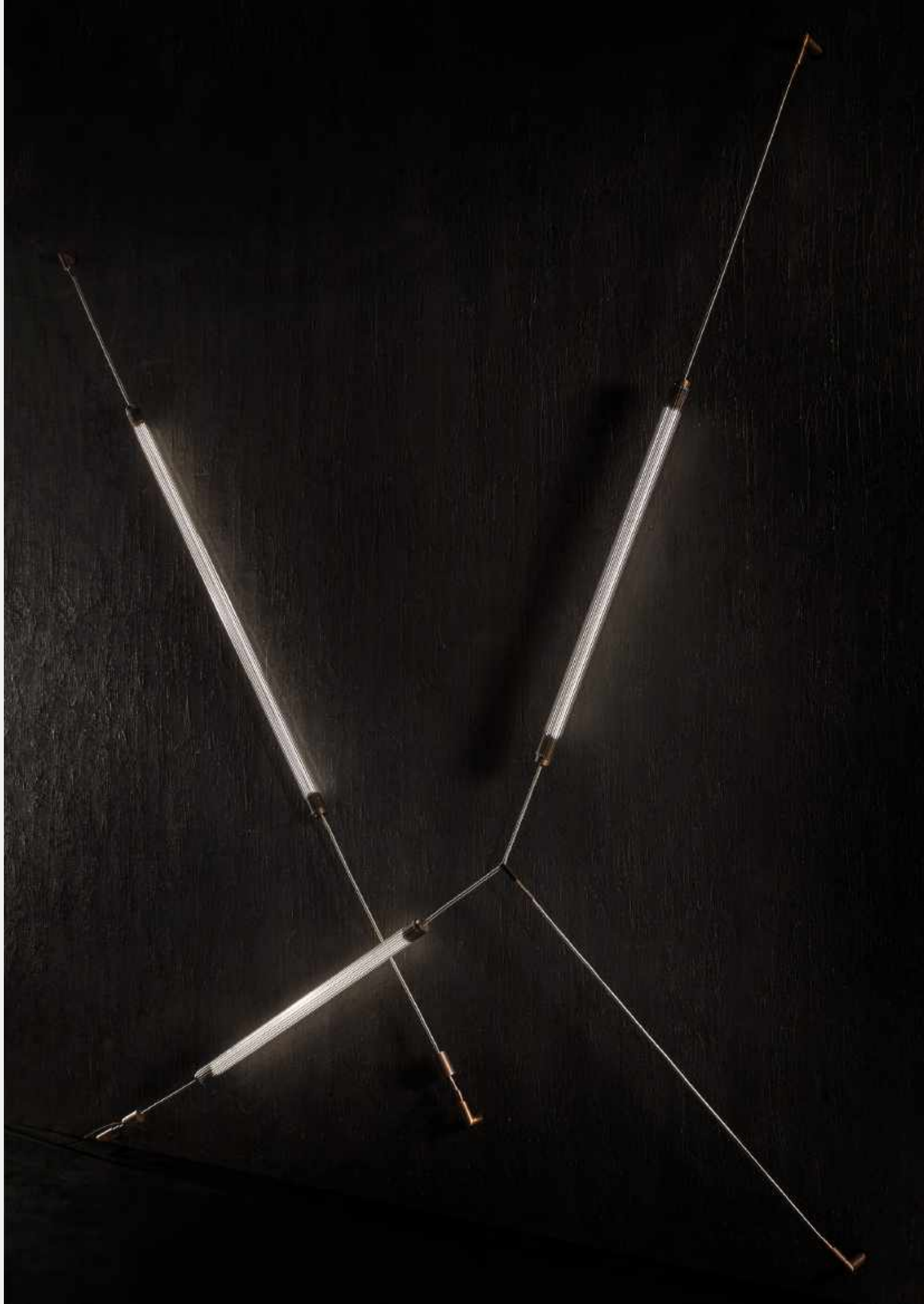
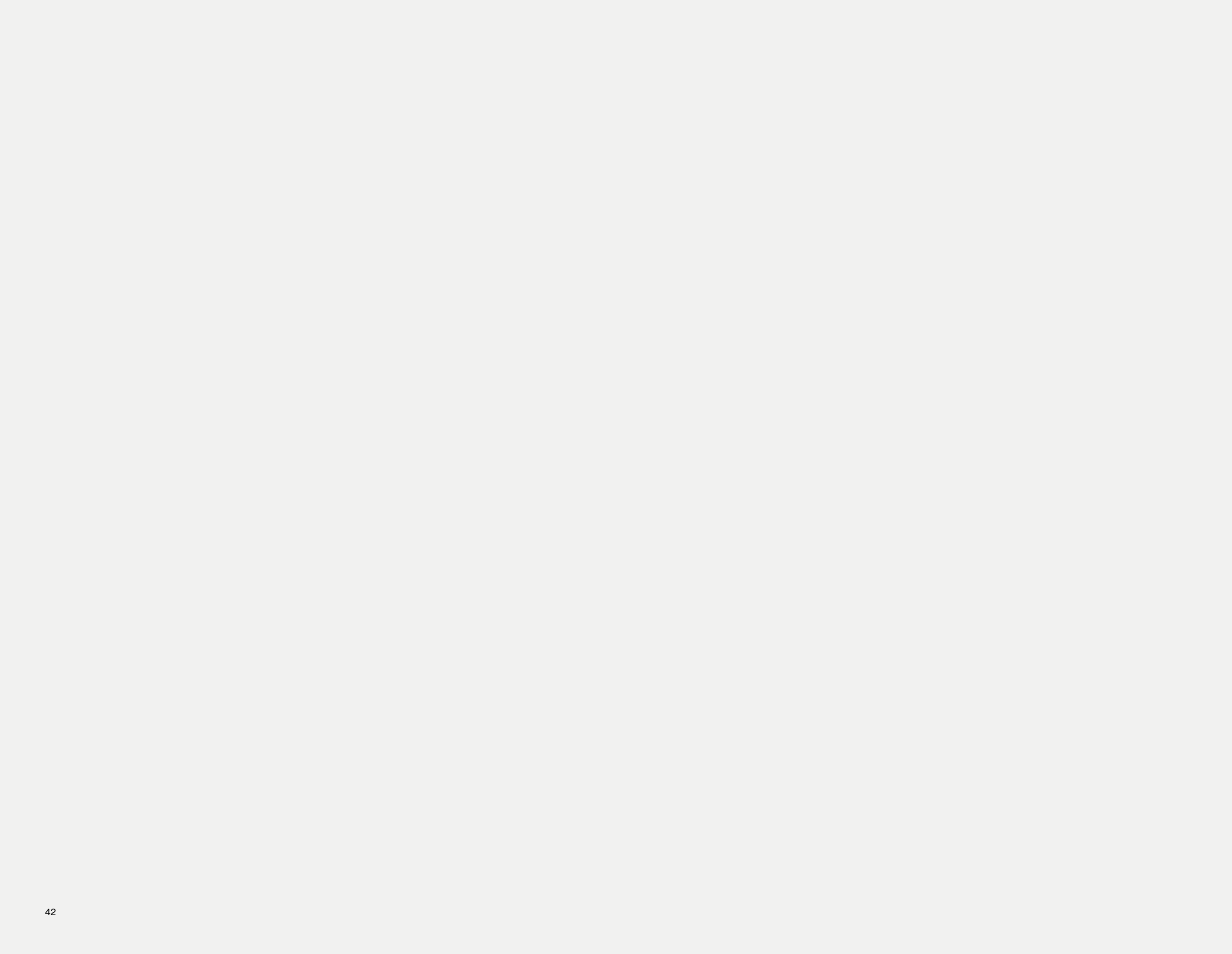



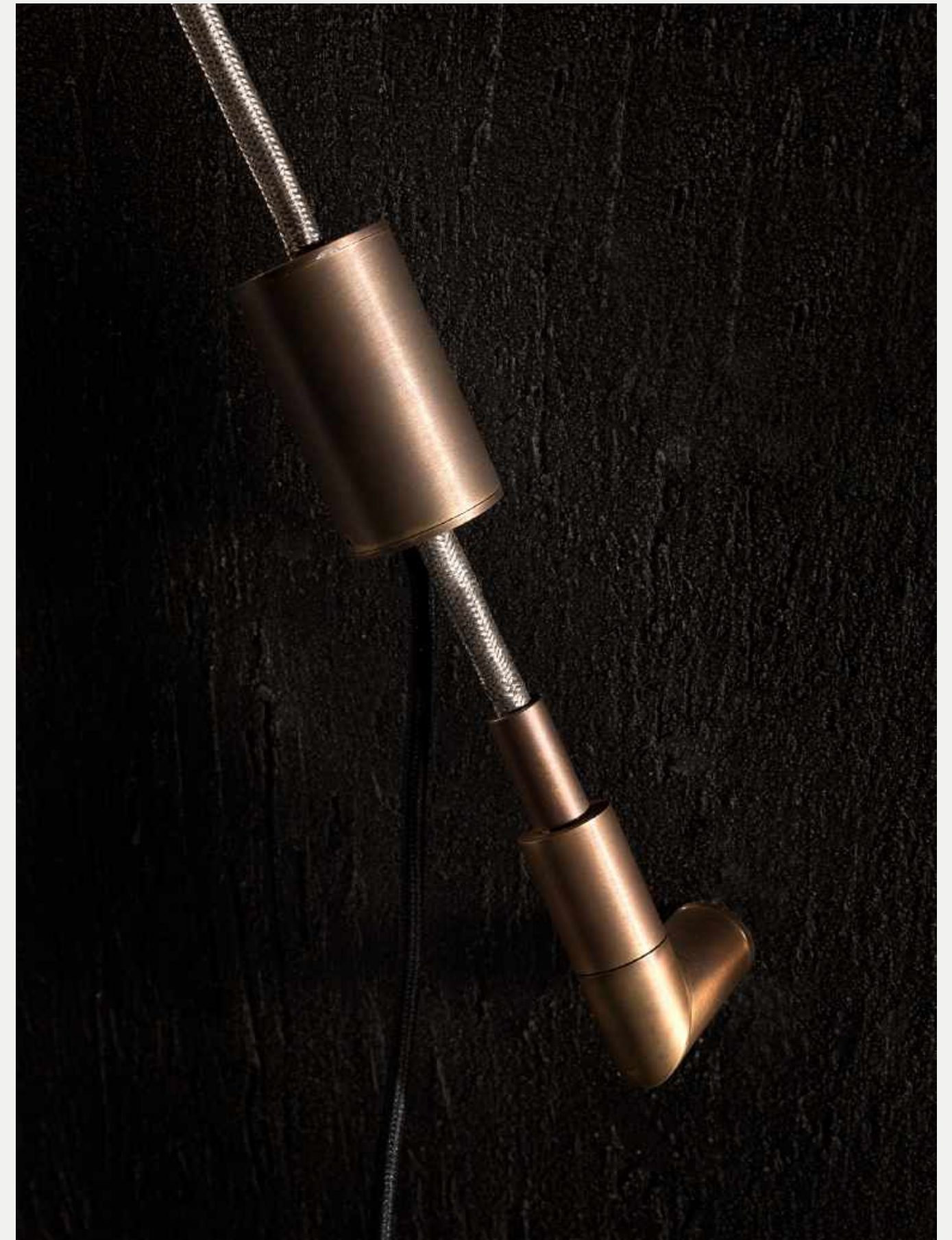















DOGMA  
DOWNTOWN  
ORIGAMI  
STARLIGHT  
TEST-TREE  
WEB









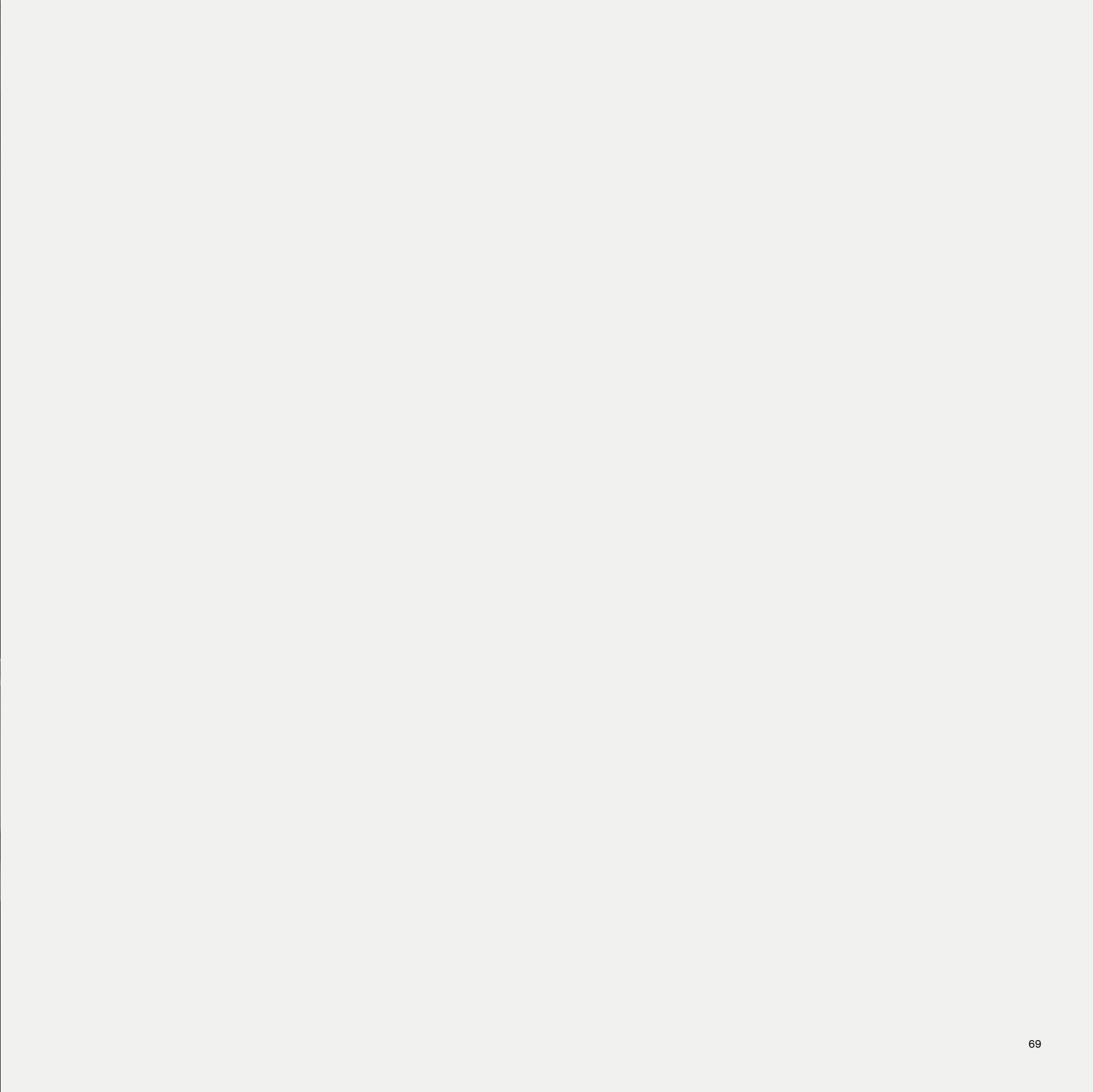













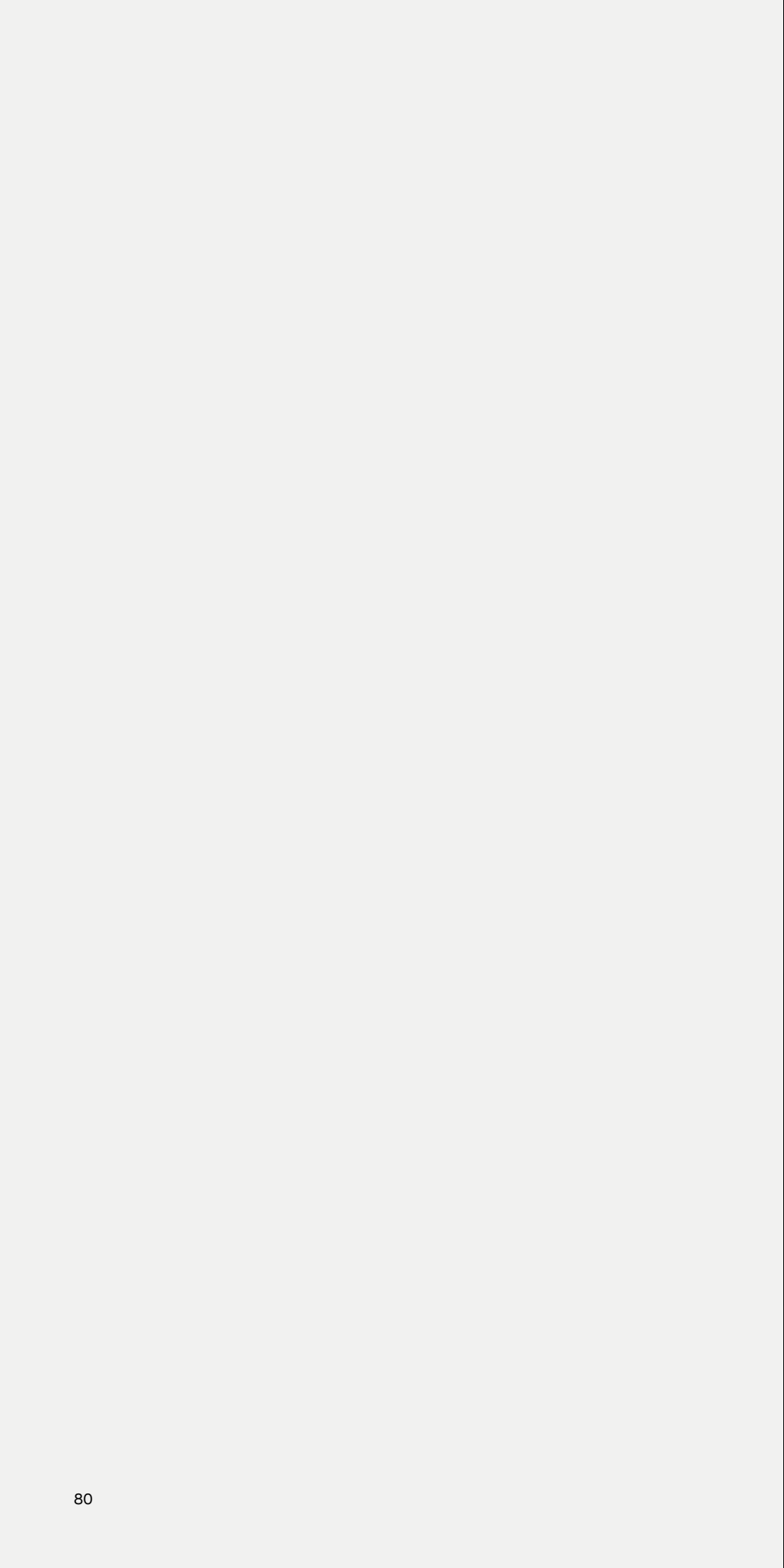



MAPLE  
STRIP  
TEST-TREE  
TIME  
WEB

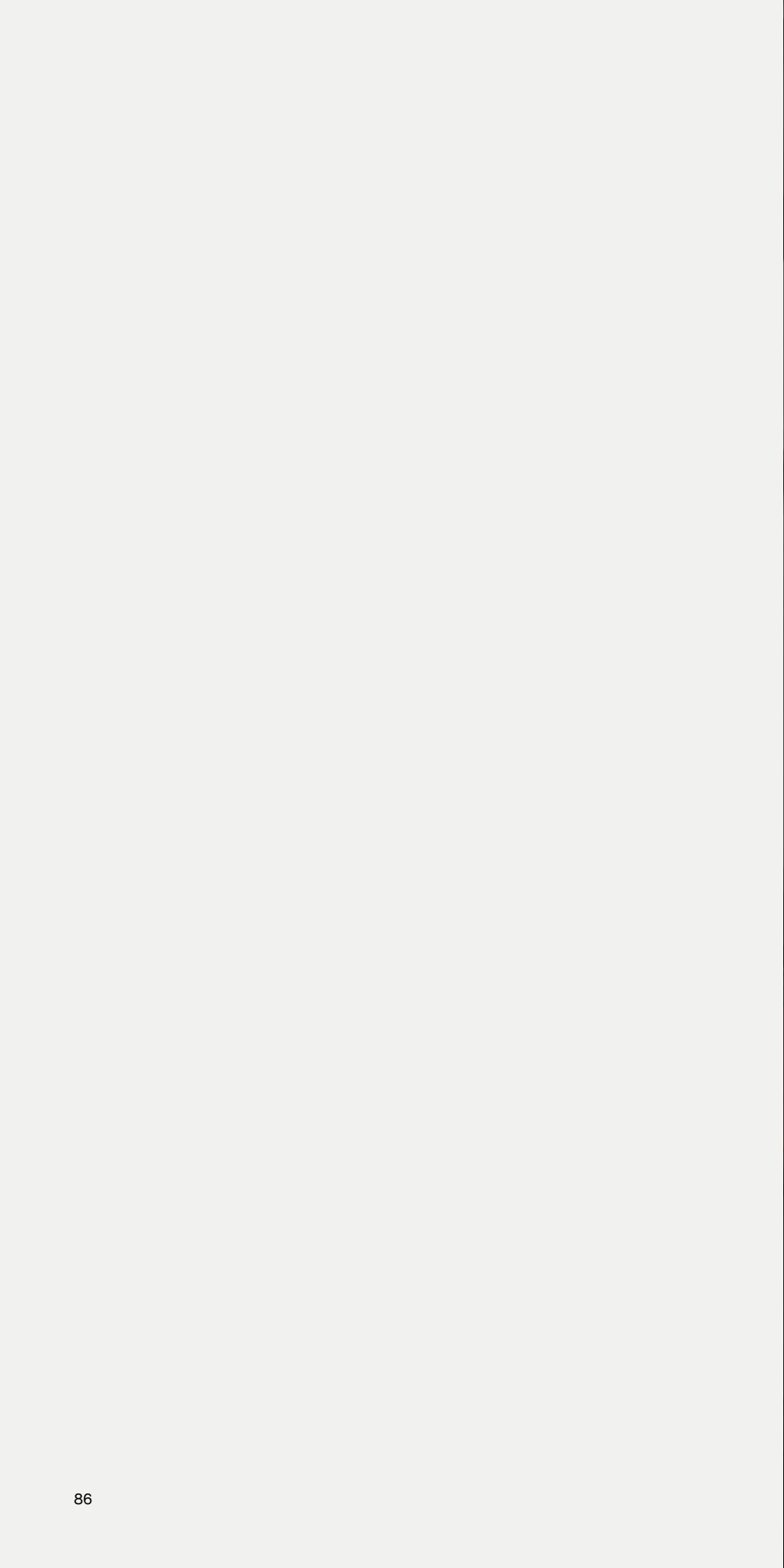













ABACO  
BE MINE  
CRYSTAL  
MUSHROOM  
NEW ZEALAND RASATO  
RF ROCK  
TAMBOURINE  
TEST-TWO





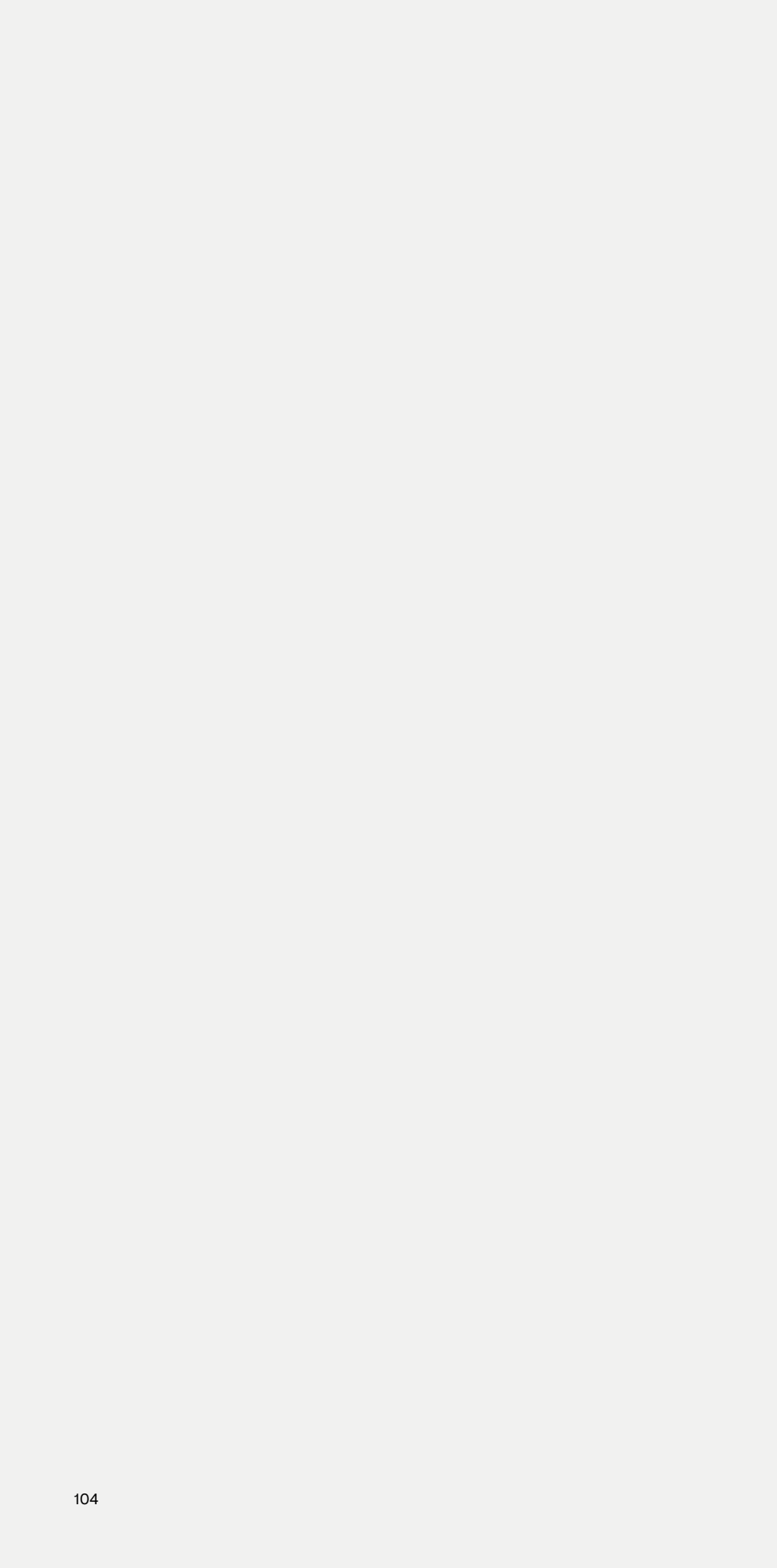



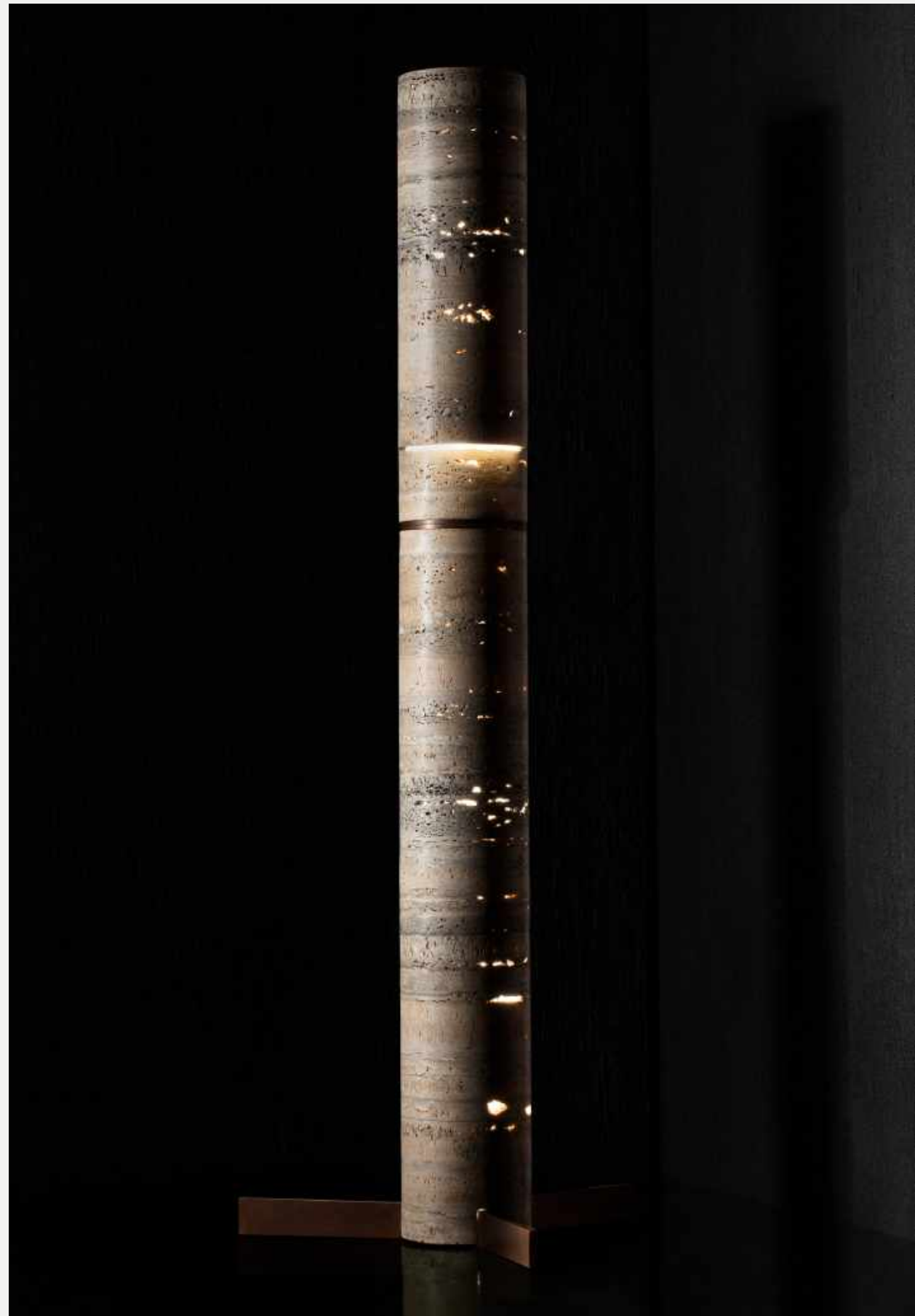

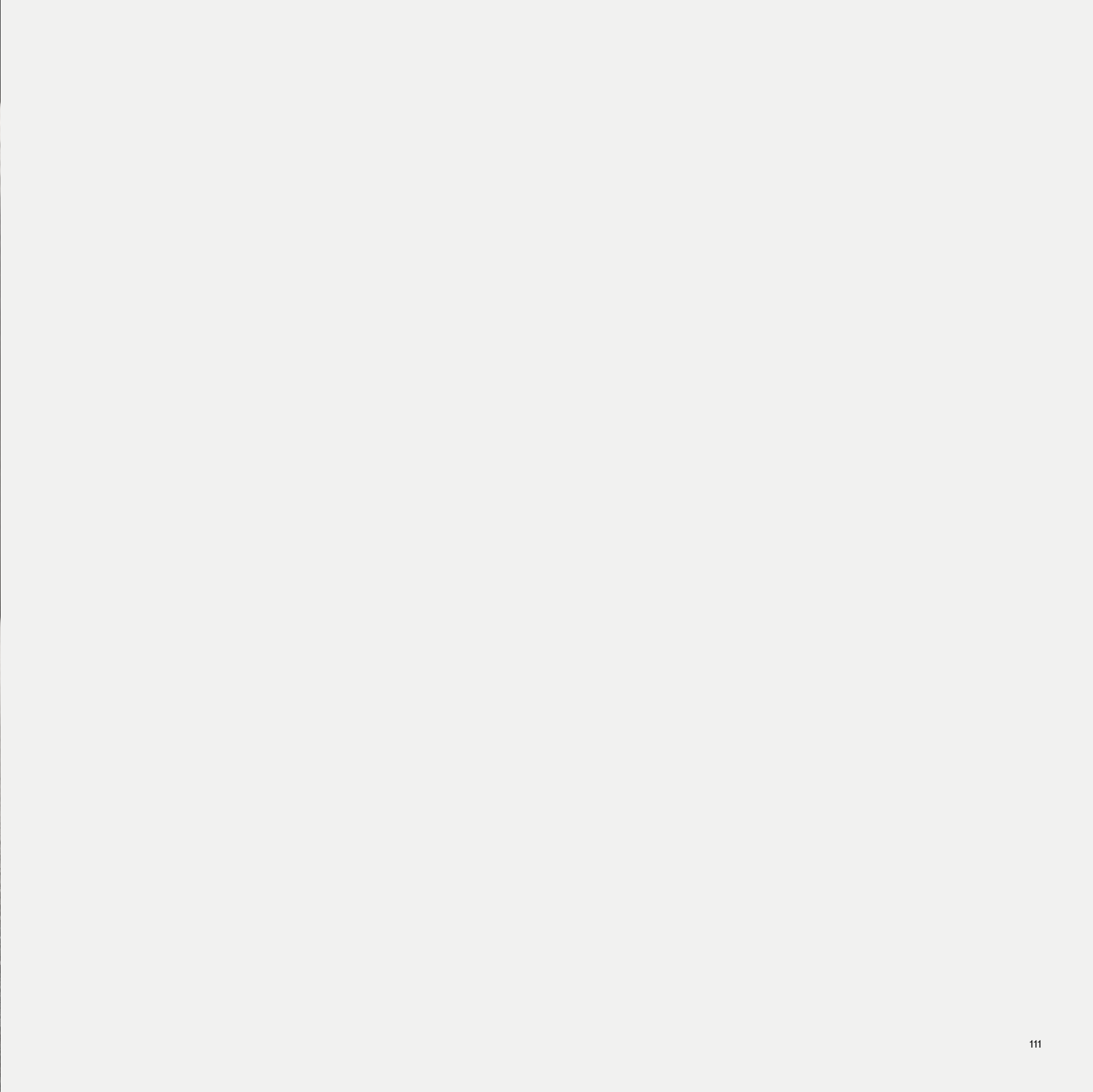







JILL  
CRYSTAL  
SYNAPSE  
UNICODE









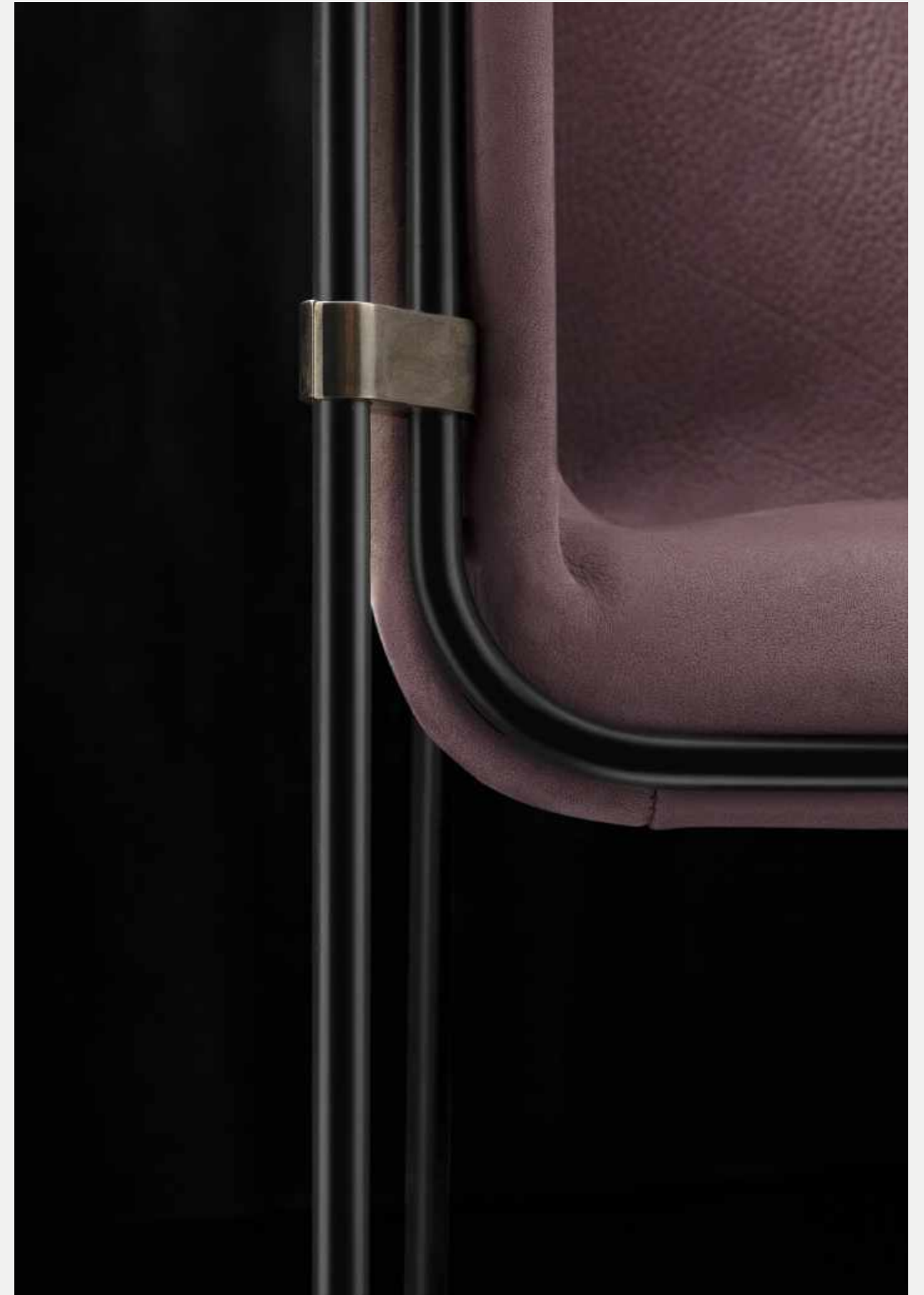







JILL STOOL  
OXYGEN



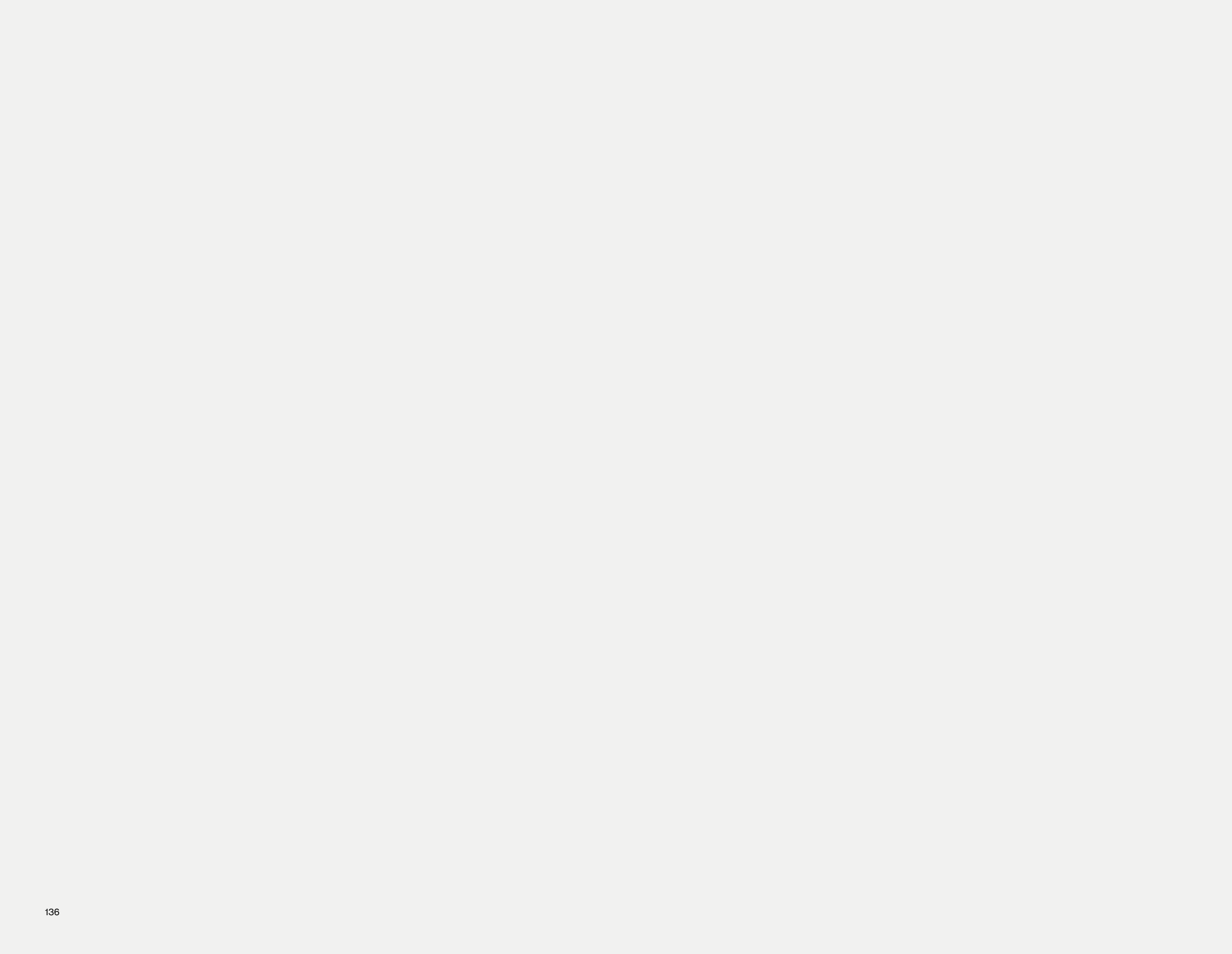











ALTER EGO  
BUG  
CAGE LAYER  
CHAIR-VA  
GATTOPARDO  
HIMALAYA  
HYPE  
POLYGONAL  
SR TABLE  
TAMBOURINE  
TEKE





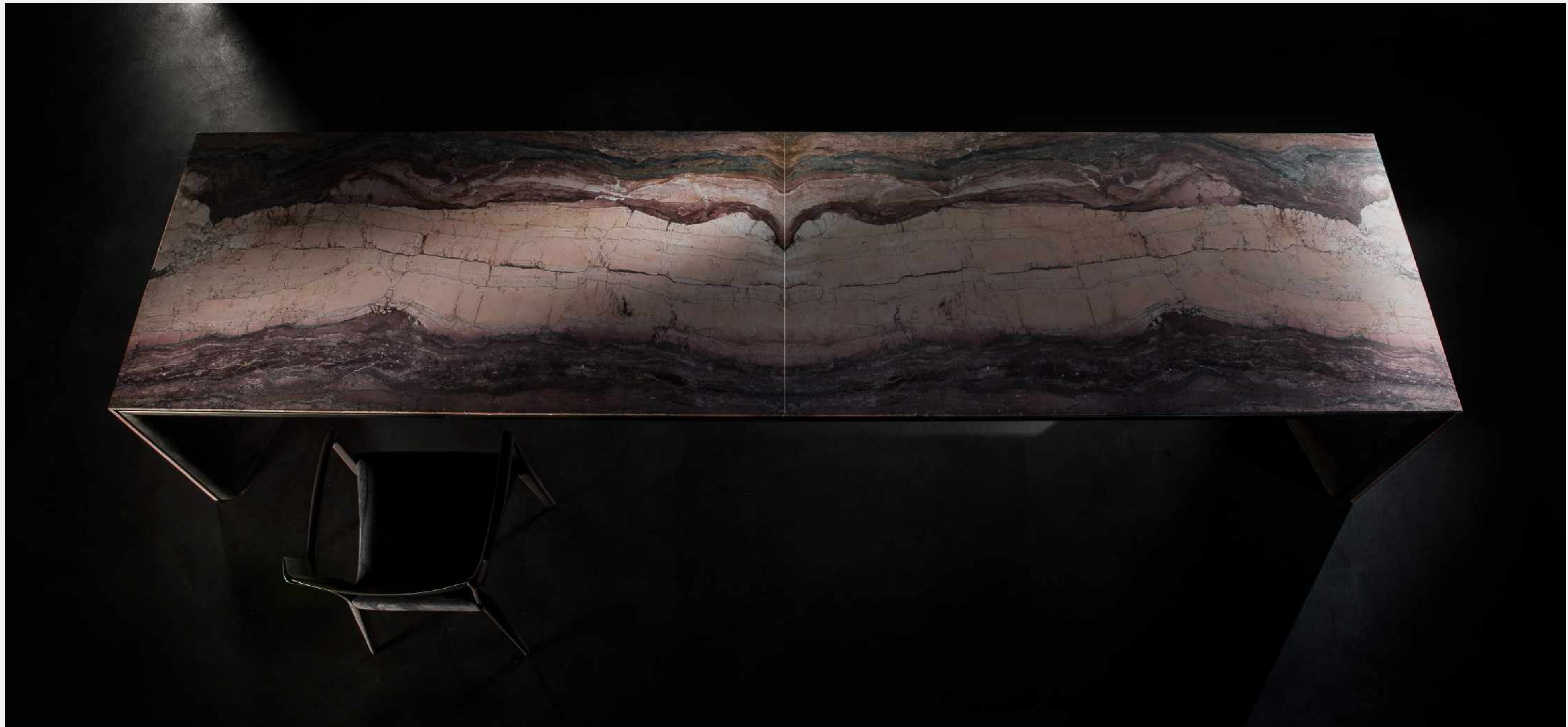

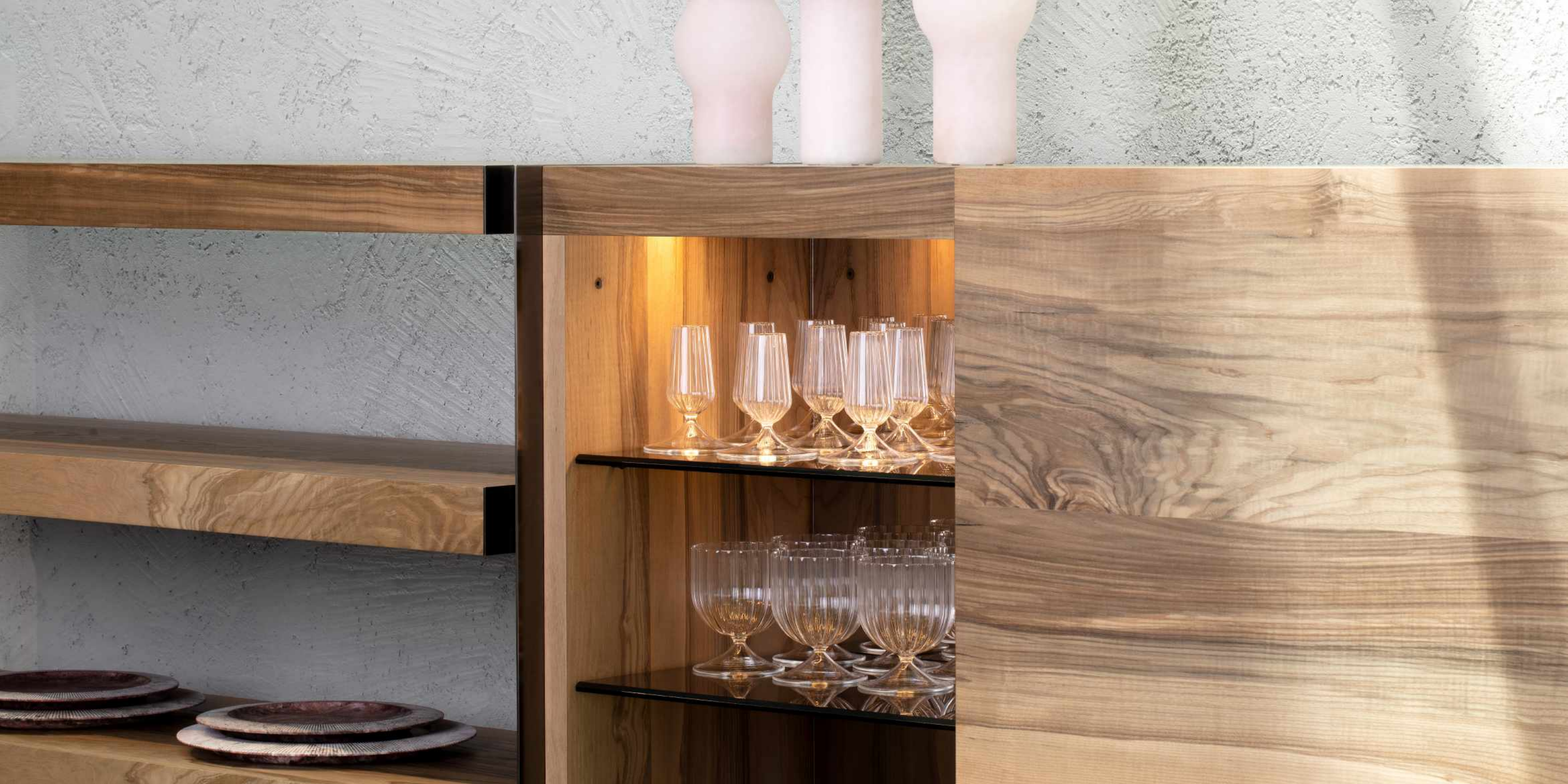







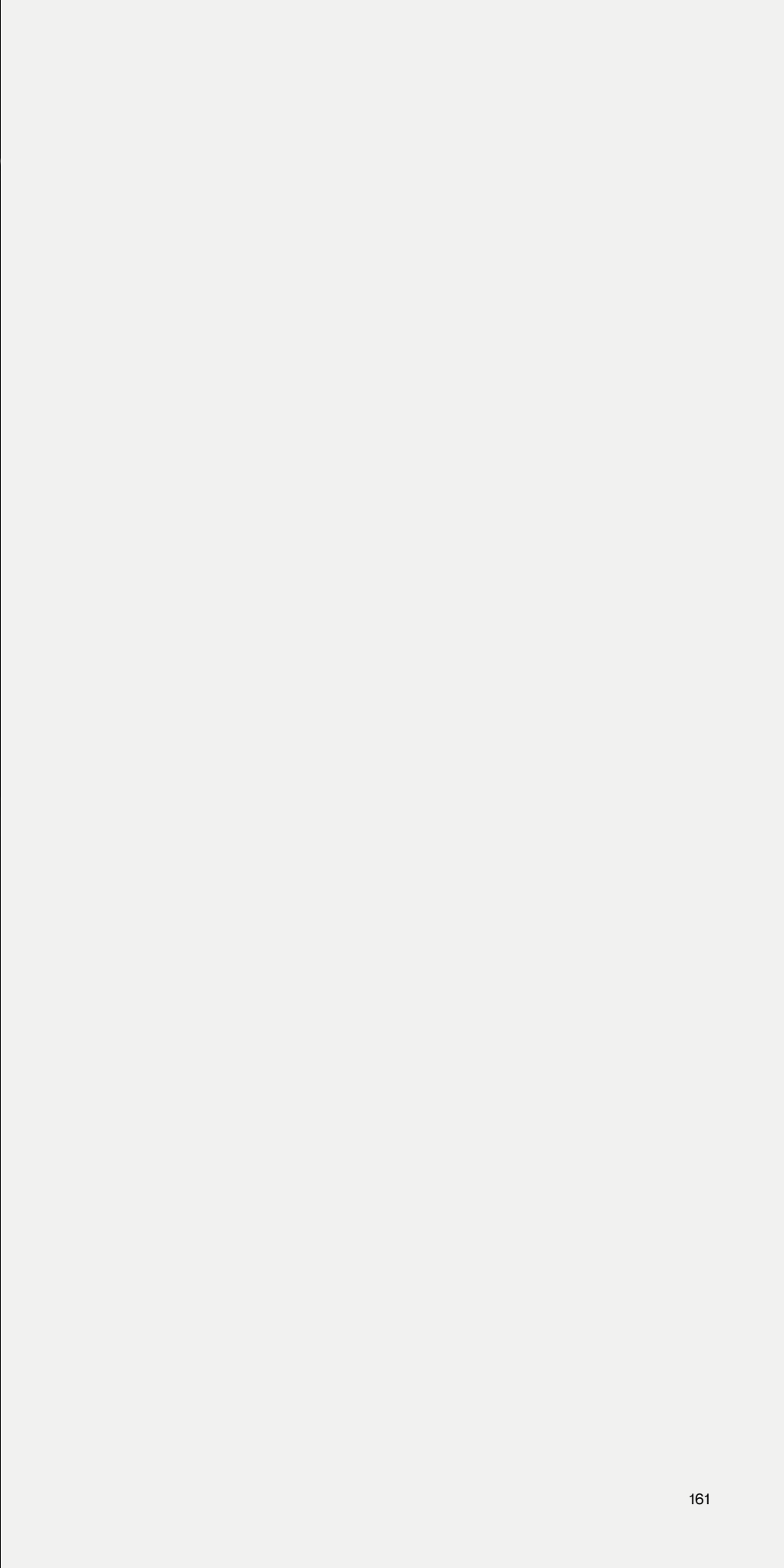









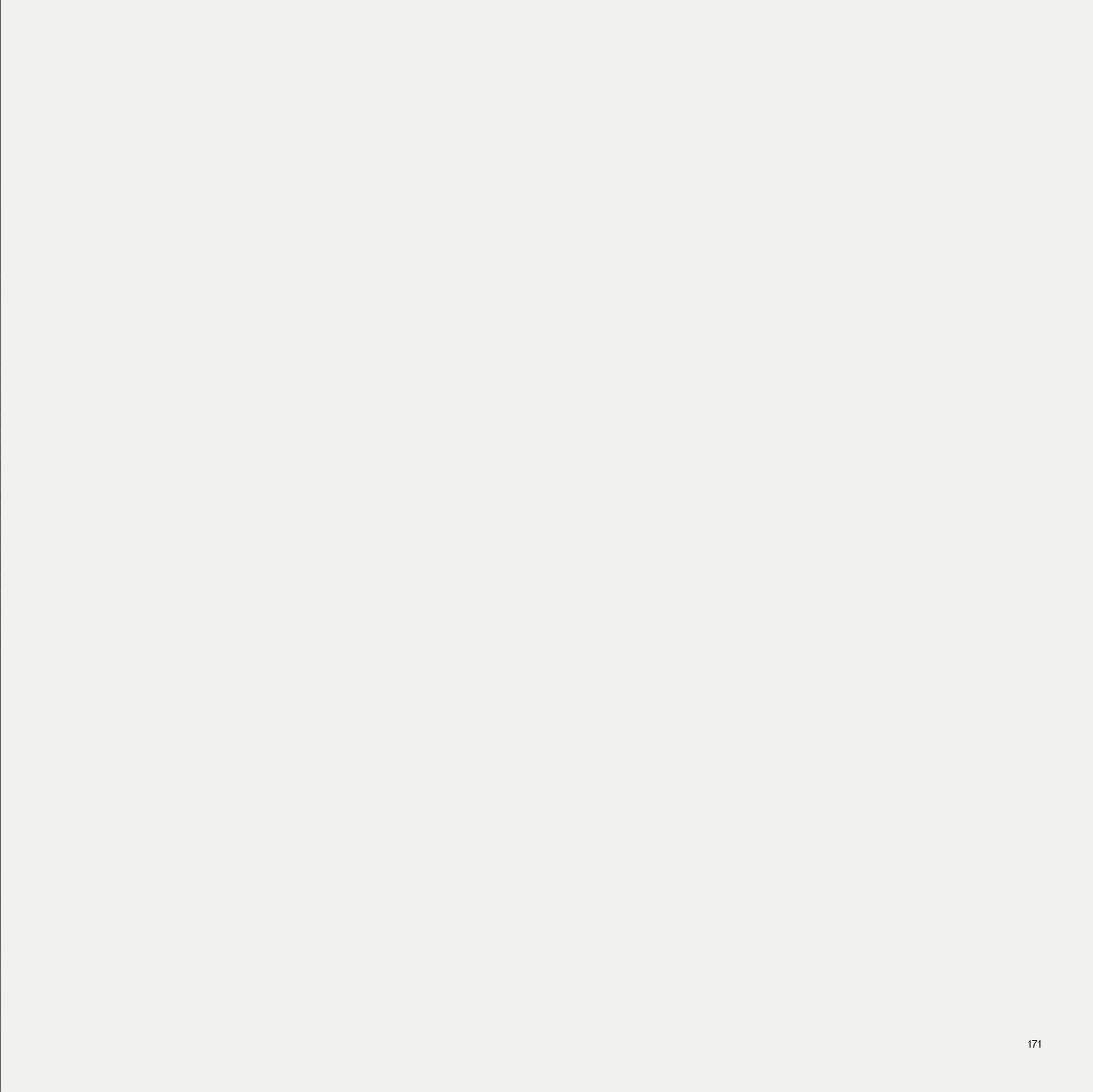

































BOND  
BIG BANG  
H-VOLTAGE  
LIGHT RING  
LOOM  
NEW ZEALAND  
OZONE  
OXYMORON



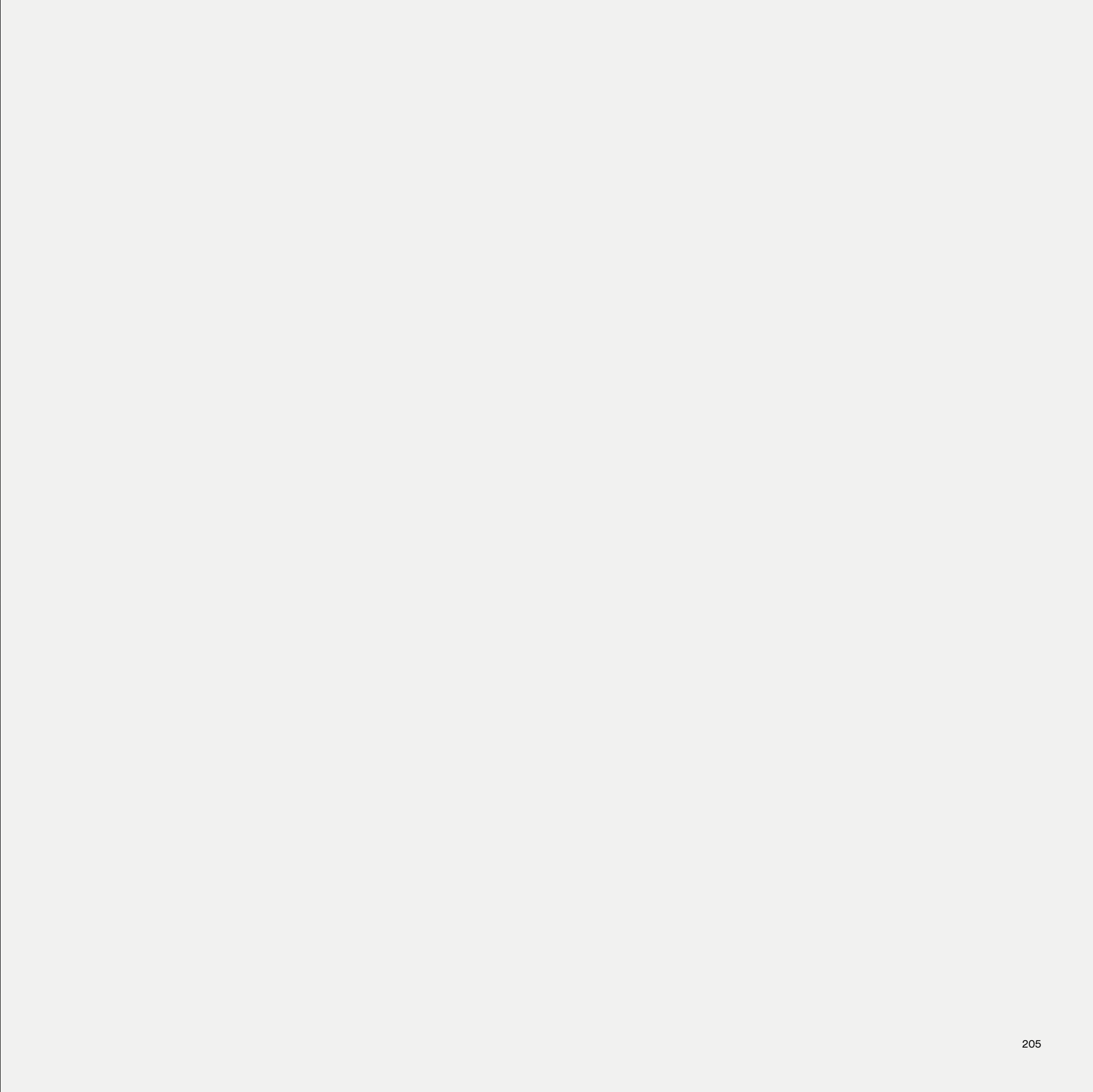







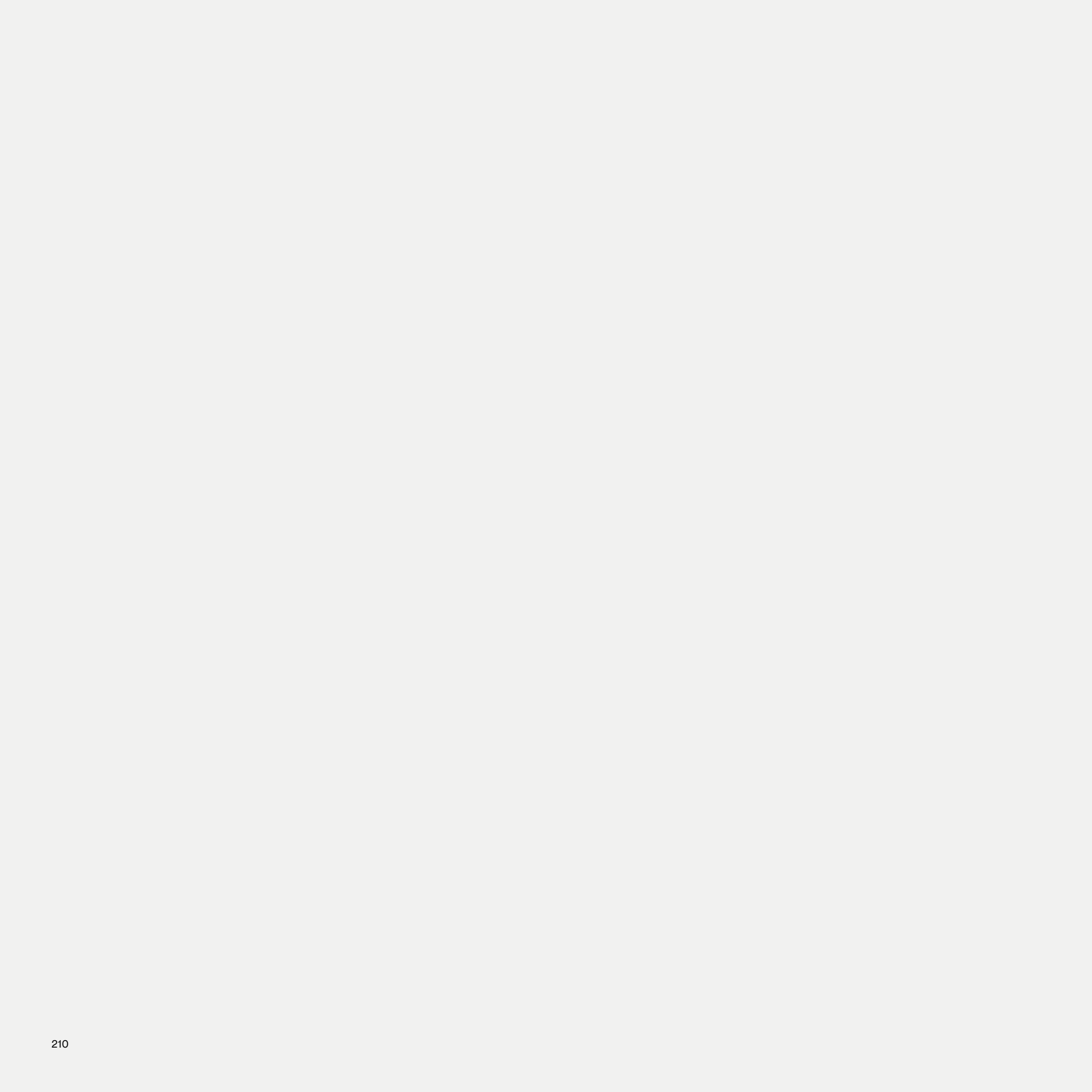















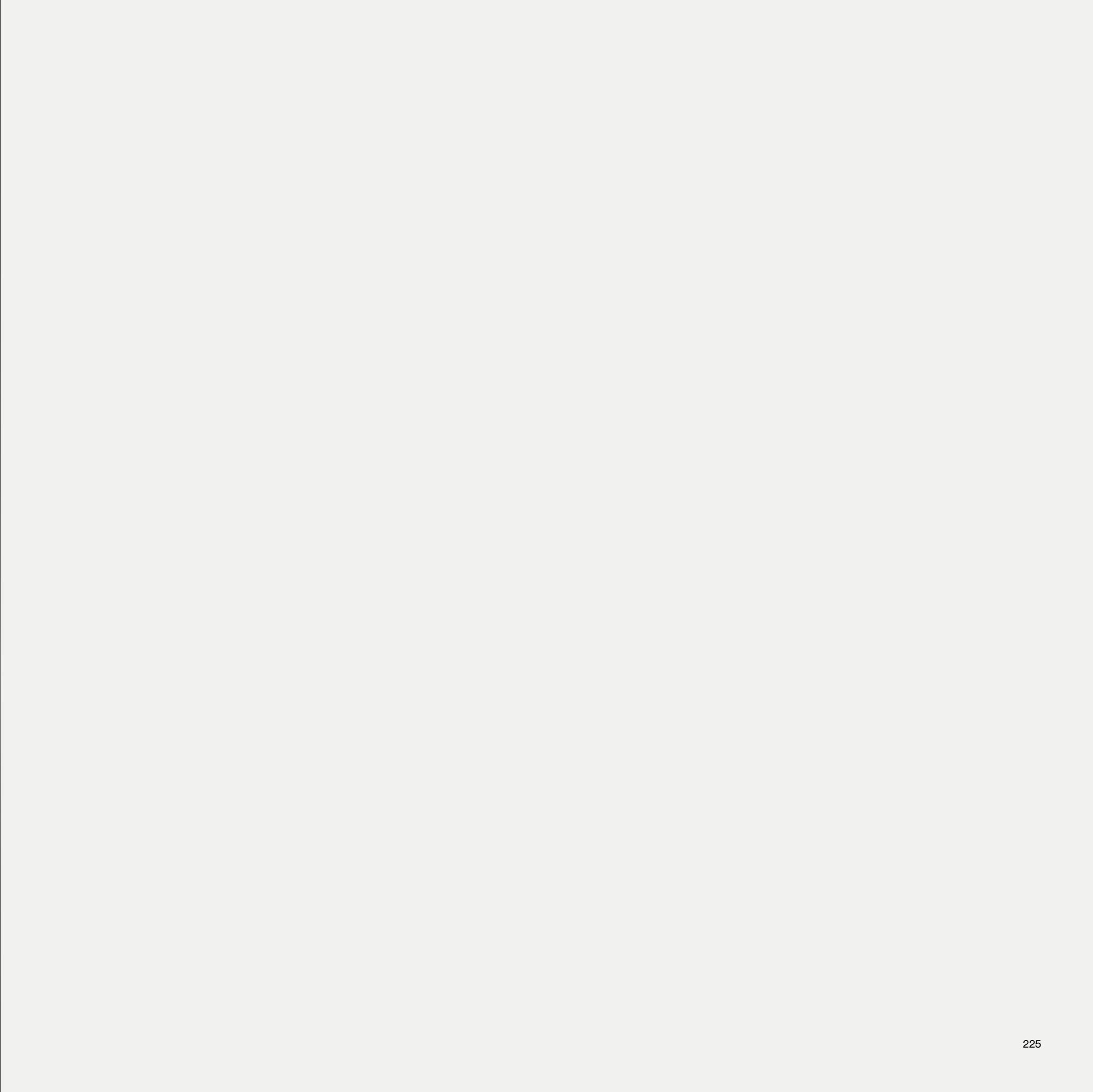

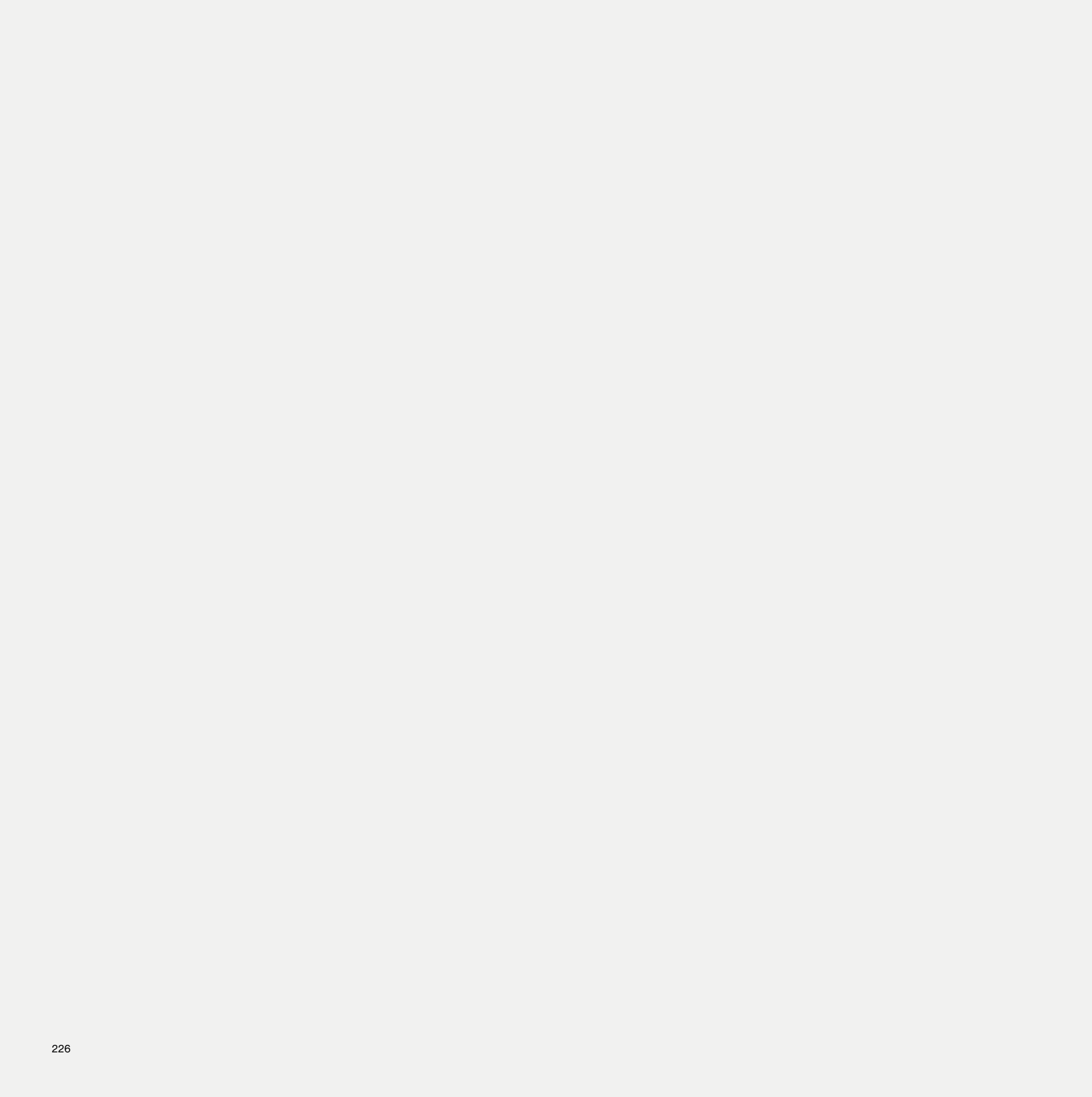



ABACO  
ALTER EGO  
BE MINE XXL  
BIG BANG  
BISTROT  
BOND  
BUG  
CAGE LAYER  
CAGE PURE  
CHAIR VA  
CHAIR VA (ARM)  
CRYSTAL  
DOGMA  
DOWNTOWN  
GATTOPARDO  
GLADIO  
GOTHAM  
H VOLTAGE  
HIMALAYA  
HYPE  
JILL  
JILL STOOL  
LIGHT RING XS  
LOOM  
MAPLE  
MUSHROOM  
NEW ZEALAND  
NEW ZEALAND RASATO  
ONEON  
ORIGAMI  
OXYGEN  
OXYMORON  
OZONE  
POLYGONAL  
RF ROCK  
SAVANNA  
SISMA  
SPIDER  
SR  
STARLIGHT  
SUPERB ALL  
SYNAPSE  
TAMBOURINE  
TEKE  
TEST ONE  
TEST TREE  
TEST TWO  
TIME  
UNICODE  
WEB



**ABACO**  
Tiles in Burnished Titanio, White Crystal and H-Pale Gold

98 102



**ALTER EGO**  
Top in Breccia Medicea, structure in Burnished Titanio

148 150 155 157



**BE MINE XXL**  
Sandcasting brass with top in shine brass or silver finish with top in finish shine Silver

99



**BIG BANG**  
Top in Black Pearl, structure in Sand Cast Peltro

200 201 220 226



**BISTROT**  
Burnished Titanio

23 81



**BOND**  
Phantom Black

200 202 206 209 210 226



**BUG**  
Structure in Black Burnished Steel, metal details in Black Burnished Brass

148 164 167 168



**CAGE LAYER**  
Shelves in Swamp Olive Ash, structure in Black Burnished Steel

155 171 172



CAGE PURE  
Shelves and structure in Black Burnished Brass

46 48 50



CHAIR-VA  
Seat in Ghost Polvere, backrest in Burnished Platinum, structure in Ash Wood

23 26 30



CHAIR-VA (with armrests)  
Seat in Phantom Black, backrest in Burnished Platinum, structure in Ash Wood

39 148 150 155 158 161



CRYSTAL  
CRYSTAL EVO  
White Crystal

112 118



DOGMA  
Paonazzo with shelf in Sand Cast Peltro

60 62 64 66



DOWNTOWN  
Phantom Black with backrest in Burnished Titanio

68 74 76 78 80



GATTOPARDO  
Black Burnished Steel and Mohair Agave, tray in Sand Cast Peltro

149 167 174 176 178



GLADIO  
Burnished Titanio

54 57 79 80 176



**GOTHAM**  
Top in Rapolano VS Travertine, legs in Cast Glass, structure in Black Burnished Steel

35 36 38 42 46 52



**H-VOLTAGE**  
Seat in Phantom Ghost Antracite, shell in micro fiber, legs in Black Burnished Steel

213 214 215 216 218



**HIMALAYA**  
Color 05

148 152 167



**HYPE**  
Doors and shelves in Swamp Olive Ash, structure in Sand Cast Peltro

148 152 154



**JILL & JILL STOOL**  
Seat in Ghost Gelso (Jill), Phantom Black (Jill Stool), structure in Black Burnished Steel with metal details in Sand Cast Peltro

99 124 125 132 140 142



**LIGHT RING XS**  
Burnished Platino, Burnished Titanio, Burnished Brass, and H-Silver Black

215 216



**LOOM**  
Doors in H-Piuma, back panel in Titanium Stone, sliding door in Burnished Brass with Bronze Glass, structure in Oak Thermowood

200 202 205



**MAPLE**  
Core in Sand Cast Brass and Transparent or Frosted Glass, supports in Burnished Brass

84



MUSHROOM  
Sand Cast Bronze

99 110 111



NEW ZEALAND  
Color Agave

200 220 226



NEW ZEALAND RASATO  
Color 1 DA06 (under Origami)  
Color 2 49/49-21 (under Be Mine)

60 68 74 98 101



ONEON  
Ice Onyx

189 190 193 194 196



ORIGAMI  
Paonazzo and Sand Cast Peltro, 55 size only  
Sand Cast Peltro

60 68 69 70 73 74



OXYGEN  
H-Pale Gold with top in Lava stone

135 136 138



OXYMORON  
Top in Forest Fusion, Steel structure with legs in  
Sand Cast Bronze.

212 214 216 217



OZONE  
Breccia Medicea dell'Acqua Santa

225 226



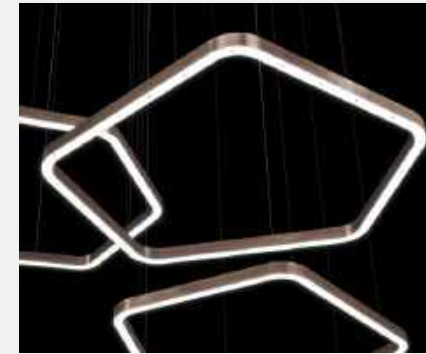

POLYGONAL  
Burnished Titanio

148 196



RF ROCK  
Laquered matt solid wood with fabric in Alcide Polvere

98 104 108



SAVANNA  
Seat in Ghost Polvere, structure in Ash Wood

35 50



SISMA  
Top in Sand Cast Peltro, legs in Rapolano Travertine

23 24 26 29



SPYDER  
Burnished Brass

35 38 41 44 45



SR  
Marble top in Ice Onyx, wood top in Swamp Olive Ash, both structures are in H-Pale Gold

148 162 167



STARLIGHT  
Core in Sand Cast Bronze and blades in Black Burnished Brass

69 74



SUPERB-ALL  
Fiberglass and Burnished Titanio

20



SYNAPSE  
Black Pearl

116 118 120 122



TAMBOURINE  
Seat in Ghost Agave, base in Sand Cast Peltro

98 100 101 167



TEKE  
Doors are made of Bronze Glass, structure in Steel with internal drawers in Ice Onyx

167 181 182 184



TEST-ONE & TEST-TWO  
Ice Onyx and metal ring in Burnished Titano Rapolano Travertine with ring in Burnished Brass

23 167 181 182  
99 106 107



TEST-TREE  
Ice Onyx and joints in Burnished Brass

74 92 93 95



TIME  
H-Pale Gold

88 90



UNICODE  
Burnished Titano, shelves in Wild Onyx

127 128



WEB  
Uprights in Sand Cast Peltro. Shelves in Swamp Olive Ash

74 84 86

ABACO  
ALTER EGO  
BE MINE XXL  
BIG BANG  
BISTROT  
BOND  
BUG  
CAGE LAYER  
CAGE PURE  
CHAIR VA  
CHAIR VA (ARM)  
CRYSTAL  
DOGMA  
DOWNTOWN  
GATTOPARDO  
GLADIO  
GOTHAM  
H VOLTAGE  
HIMALAYA  
HYPE  
JILL  
JILL STOOL  
LIGHT RING XS  
LOOM  
MAPLE  
MUSHROOM  
NEW ZEALAND  
NEW ZEALAND RASATO  
ONEON  
ORIGAMI  
OXYGEN  
OXYMORON  
OZONE  
POLYGONAL  
RF ROCK  
SAVANNA  
SISMA  
SPIDER  
SR  
STARLIGHT  
SUPERB ALL  
SYNAPSE  
TAMBOURINE  
TEKE  
TEST ONE  
TEST TREE  
TEST TWO  
TIME  
UNICODE  
WEB



DIMENSIONS 38X112H

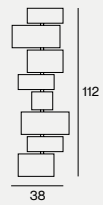

DIMENSIONS 34X126H



DIMENSIONS 38X131H

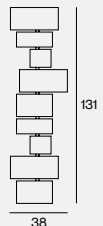

DIMENSIONS 34X154H

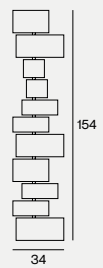

**ABACO**

Light and matter conspire, forging together an ironic and elegant artistic statement. Metal modules, aligned and alternated with White Chrystal stone pieces of different irregular sizes, compose a faceted pattern animated by beams of light intriguingly radiating from the intersections.

**STRUCTURE**

Dimmable wall lamp in different compositions energy saving (energy efficiency index A) with warm light. Metal structure with lampshade in different matching finishes: White Crystal stone and metal. Available in 4 typologies and 3 fix combination of materials. Available with extra warm light. Only for indoor use.

**DIMENSIONS**

- Composition 38x112h cm
- Composition 34x126h cm
- Composition 38x131h cm
- Composition 34x154h cm



DIMENSIONS 320X100X75H

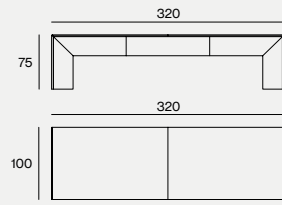

DIMENSIONS 360X100X75H

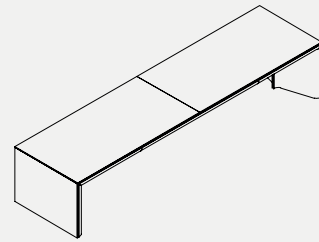
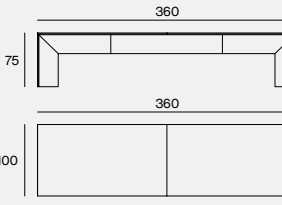

**ALTER EGO**

The table, Alter Ego, a manifesto of minimalism and rigorous elegance, seduces with its timeless style. Two different complementary and overlapping souls, precious metal and stone, emphasize a cross-hybridization of contemporaneity and tradition, its essential linearity, and sculptural purity.

**STRUCTURE**

Burnished Platino/Titanio or Black Burnished Steel.

**FINISH**

Stones from our range - 2cm thick

**DIMENSIONS**

- 320x100x75h cm
- 360x100x75h cm



DIMENSIONS 160X70X20H

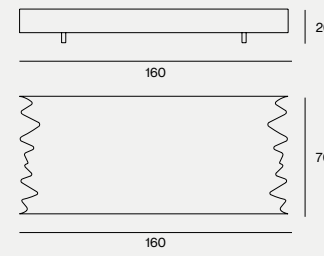

DIMENSIONS 180X70X20H

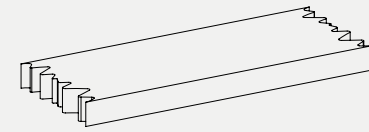
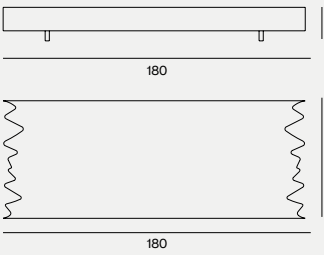

**BE MINE XXL**

**STRUCTURE**

Mullion in sandcasting brass top plate 0,5 cm thick.

**FINISHES**

Sandcasting brass with top in shine brass or silver finish with top in finish shine Silver.

**DIMENSIONS**

- Cm 30x60x5h
- Cm 40x60x35h

**BE-MINE XL**

- Cm 160x70x20h
- Cm 180x70x20h



**BIG BANG**

**STRUCTURE**

Structure in sand casting metals. Nestled top in stone from our samples

**STRUCTURE FINISH**

Sandcasting Peltro Sandcasting Brass, Bronze or brass Silver finish.

**TOP**

Nestled top in stones as per our samples.

**DIMENSIONS**

- Cm 50x50x50h
- Cm 70x50x40h
- Cm 70x70x40h
- Cm 110x110x30h
- Cm 140x140x30h



DIMENSIONS 50X50X50H

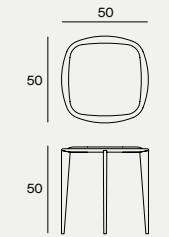

DIMENSIONS 70X50X40H

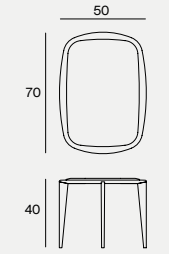

DIMENSIONS 70X70X40H

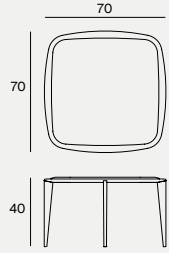

DIMENSIONS 110X110X30H

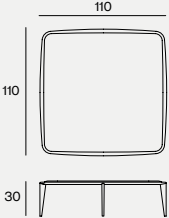

DIMENSIONS 138X138X30H

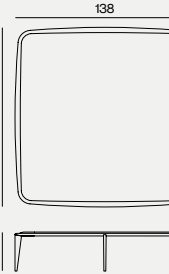



DIMENSIONS 200X29X270H

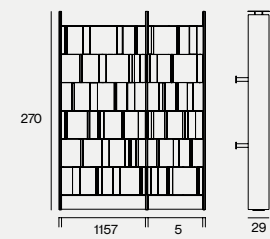

DIMENSIONS 240X29X270H

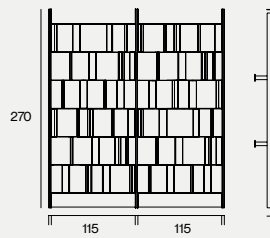

DIMENSIONS 276X29X270H

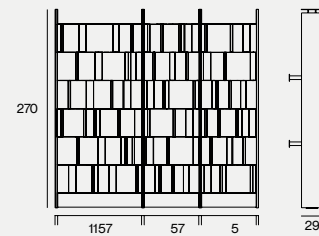

DIMENSIONS 316X29X270H

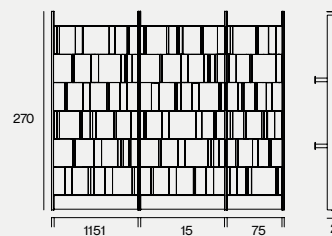

**BISTROT**

**STRUCTURE**

External columns in 2,7 cm thick solidwood covered with metal. Internal structure 0,2 cm thick in metal.

**FINISH**

Burnished brass, black burnished brass or steel finish burnished Titanio or burnished Platino. Base and wall support in black burnished steel using traditional techniques.

**DIMENSIONS**

Cm 200x29x270h  
Cm 240x29x270h  
Cm 276x29x270h  
Cm 316x29x270h



DIMENSIONS 120X85X66H

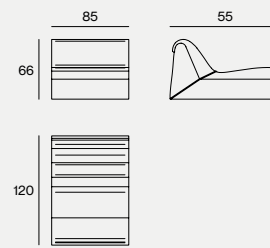

DIMENSIONS 130X130X66H

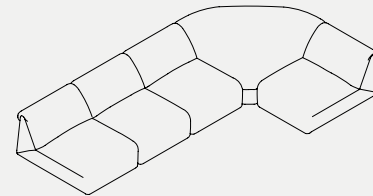
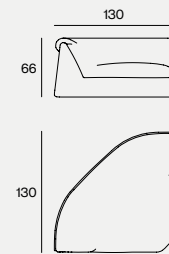

**BOND**

A casual and informal character characterizes the Bond sofa and its comfortable dimensions that are emphasized by rich upholstery. Designed according to a concept of high spirit of sharing, it responds with versatility to the needs of the most diverse layouts, offering free solutions.

**STRUCTURE**

Solid wood padded with polyurethane foam, covered with 100% goose down, internal cover in 100% white cotton lining. Seat cushion with high resilience polyurethane foam PF45FR and memory foam, covered with 100% quilted goose down (Assopluma certified Gold Label) with density (SR75) structural internal support. Internal cover in 100% white cotton.

**COVER**

Leather from our sample catalogue. Cover not removable.

**DIMENSIONS**

120x85x66h cm  
130x130x66h cm



DIMENSIONS 82X82X68H

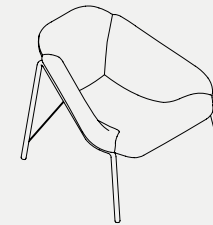
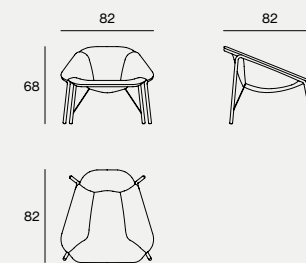

**BUG**

The armchair, Bug, a harmonious blend of essentiality and elegance, expresses with its bold polygonal shape a distinctive idiom. The generous, inviting seat balances with informality on the slender burnished iron legs, proudly exhibiting the refined detail of its brass feet.

**STRUCTURE**

Black Burnished Steel - Ø 2.5 cm diameter.

**SEAT**

Leather category 500. Natural rubber leather pullers in black color.

**LEG'S INSERTS**

Black Burnished brass.

**DIMENSIONS**

82x82x68h cm



DIMENSIONS 180X35X260H

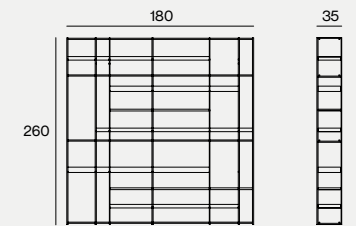

DIMENSIONS 180X45X260H

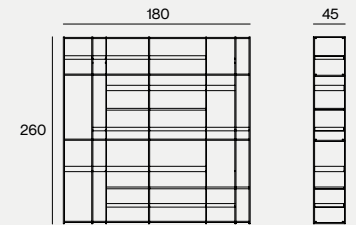

DIMENSIONS 240X35X260H

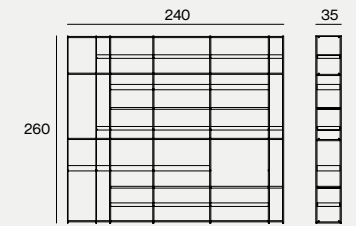

DIMENSIONS 240X45X260H

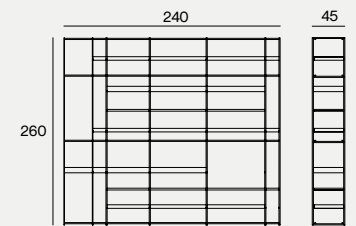

**CAGE LAYER**

Cage Layer, derives from a formal choice, the result of a chemical synergy between differences balancing and enhancing each other, finding strength and completion in their entirety. A light, black-burnished metal grid offering an attractive pattern of alternating shelves.

**STRUCTURE**

Black Burnished Steel  
Burnished Brass  
Black Burnished Brass

**SHELVES**

Woods available from our range

**DIMENSIONS**

180x35x260h cm  
240x45x260h cm



DIMENSIONS 180X35X260H

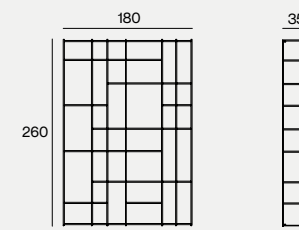

DIMENSIONS 180X45X260H

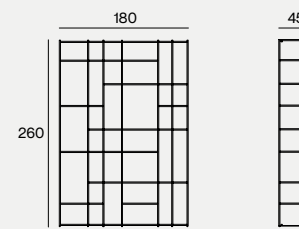

DIMENSIONS 240X35X260H

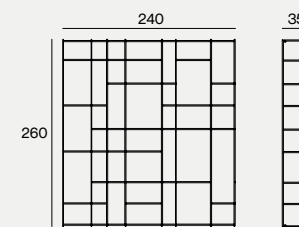

DIMENSIONS 240X45X260H

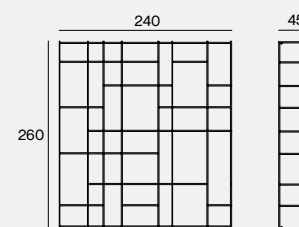

CAGE PURE

The two-sided bookshelf, Cage Pure, a light, and airy composition, an intriguing interplay of alternating and intersecting lines, helps with its permeability and the fluidity of the environment, performing an important aesthetic and functional role.

STRUCTURE & SHELVES

Black Burnished Steel  
Burnished Brass  
Black Burnished Brass

DIMENSIONS

180x35x260h cm  
240x45x260h cm



DIMENSIONS 52X57X83H

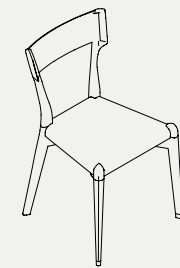
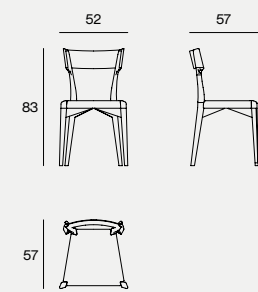

CHAIR-VA

Chair-Va, with or without armrests, revisits classicism, with futuristic scenarios in mind. Its composition appeals to new canons of expression, without renouncing a virtuous artisan interpretation.

SEAT

Leathers from our range

BACKREST

Burnished Platino/Titanio

STRUCTURE

Wooden structure finish in Black Wood, Olive Ash or open pore matt lacquered in selected colours matching with the chosen leather finish.

DIMENSIONS

52x57x77h cm



DIMENSIONS 57X57X75H

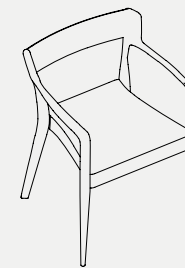
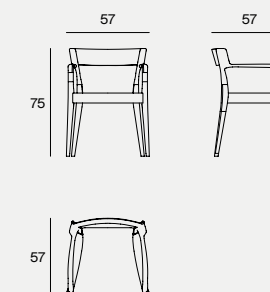

CHAIR-VA ARMCHAIR

Chair-Va, with or without armrests, revisits classicism, with futuristic scenarios in mind. Its composition appeals to new canons of expression, without renouncing a virtuous artisan interpretation.

SEAT

Leathers from our range

BACKREST

Burnished Platino/Titanio

STRUCTURE

Wooden structure finish in Black Wood, Olive Ash or open pore matt lacquered in selected colours matching with the chosen leather finish.

DIMENSIONS

58x51x75h cm



DIMENSIONS 150X7.5H

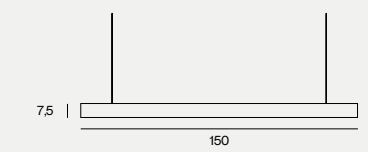

CENTRAL ELEMENT 150X7.5H

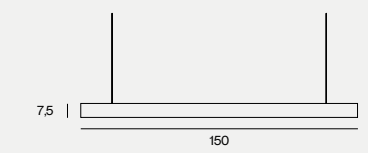

END ELEMENT 150X7.5H

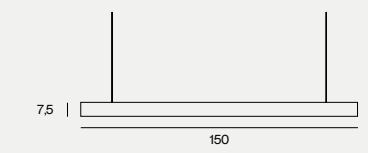

CRYSTAL

Long rectangular rods hover lightly in the air, displaying choreographic compositions, synergies between creativity and rigor, spectacularity and control, exhibiting alchemies of light, translucencies of arabesque textures.

STRUCTURE

Dimmable pendant energy saving led lamp (Energy efficiency index A) with body h7,5 cm in White Crystal stone. Low voltage power supply cable through suspension cable. Transformer incorporated in the ceiling rosette. Modular lamp with central and terminal elements. Standard overall height 180 cm adjustable. Can be customized. Available extra warm-white (without extra cost). Only for indoor use.

DIMENSIONS

Lamp cm 150x7,5h with downward pointing led. Terminal element 150x7,5h with downward pointing led. Central element 150x7,5h with downward pointing led.

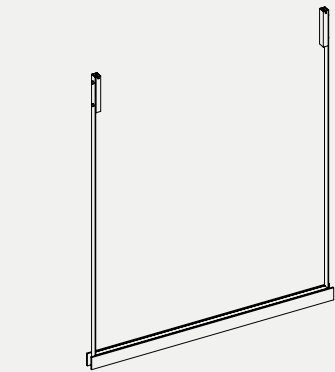

**DIMENSIONS 150X7.5H**

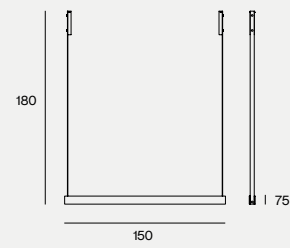

**CHRYSTAL EVO**

The Chrystal pendant light with long rectangular rods, offer with their essentiality very scenic effects due to their special size, possible combinations and particular luminosity that spreads through their White Crystal envelope.

**DESCRIPTION**

Low consumption suspension LED lamp with brass structure and central Y-shaped body in cast bronze (or brass). Transparent or frosted glass available. Transformer integrated in the ceiling canopy.

**METAL**

Burnished Brass or Black Burnished Glass. Matching core in Sand Cast Brass or Sand Cast Bronze.

**GLASS**

Grey or green.

**DIMENSIONS**

150 cm

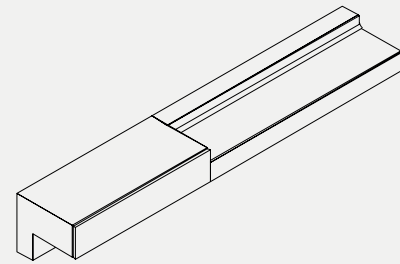

**DOGMA**

Anchored to a wall and cantilevered, the distinctive and slender volume of Dogma steals the scene. A unique and eclectic piece that combines expressive purity with a rebellious and unconventional character. A rich material texture is complemented by a daring, innovative combination with a 'tray-top' in sand cast metal. A sculptural synthesis of projections and recesses that imposes an artistic presence.

**STRUCTURE**

Made of 2.5 thick solid wood.

**FINISH**

Woods, stones and metals from our range.

**TRAY**

Sand Cast Peltro o stone depending on the material coordination options.

**DIMENSIONS**

280x65x55h cm  
320x65x55h cm  
360x65x55h cm  
400x65x55h cm

**DIMENSIONS 280X65X55H**

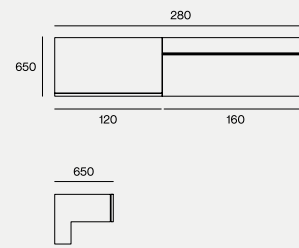

**DIMENSIONS 320X65X55H**

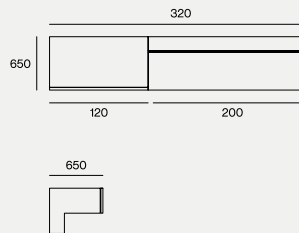

**DIMENSIONS 360X65X55H**

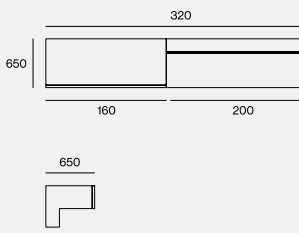

**DIMENSIONS 400X65X55H**

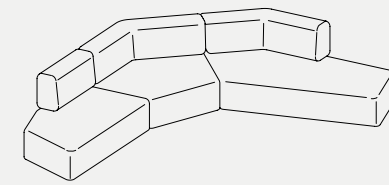
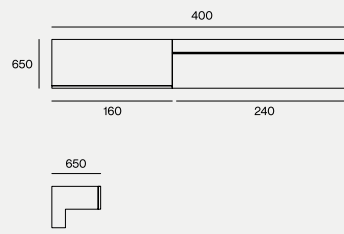

**DOWNTOWN**

**STRUCTURE**

Seating system. Solid wood padded with polyurethane foam, covered with 100% goose down, internal cover in 100% white cotton lining. Seat cushion with high resilience polyurethane foam PF45FR and memory foam, covered with 100% quilted goose down (Assopiuma certified Gold Label), with high density (SR75) structural internal support. Internal cover in 100% white cotton. Metal backrest support.

**FINISHES OF COVER:**

Fabric or leather from our samples catalogue. Cover not removable.

**FINISH OF METAL BACKREST SUPPORT:**

Black Burnished Steel, Burnished Platino, Burnished Titanio, Burnished Brass, Ottone Patina, H-Silver, H-Silver Black, Silver Patina

**DIMENSIONS**

Cm 100x75h  
Seat cm 43h

NB Right/Rh and Left/Lh indicate the position of the armrest when facing the piece of furniture.

**SOFA ELEMENT A LH 170X100X80H**

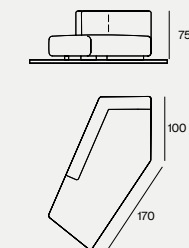

**SOFA ELEMENT A RH 170X100X80H**

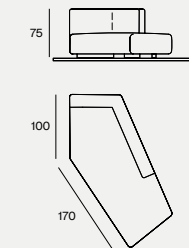

**SOFA ELEMENT B LH 190X100X80H**

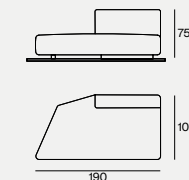

**SOFA ELEMENT B RH 190X100X80H**

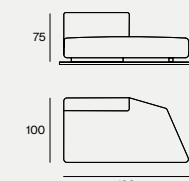

**SOFA ELEMENT C LH 200X100X80H**

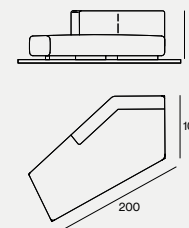

**SOFA ELEMENT C RH 200X100X80H**

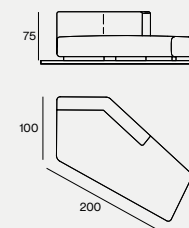

**SOFA ELEMENT D LH 250X100X80H**

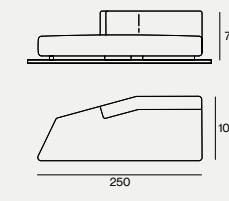

**SOFA ELEMENT D RH 250X100X80H**

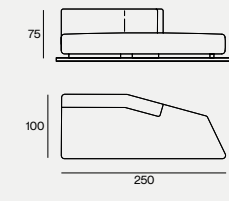

**CORNER ELEMENT E 110X100X80H**

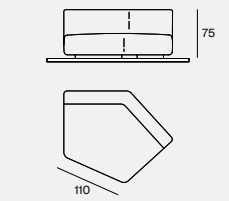

**SOFA ELEMENT G LH 220X100X80H**

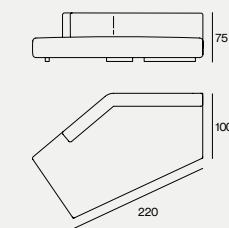

**SOFA ELEMENT G RH 220X100X80H**

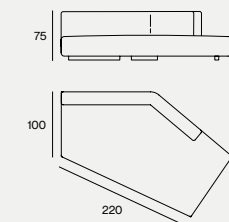

**SOFA ELEMENT H LH 260X100X75H**

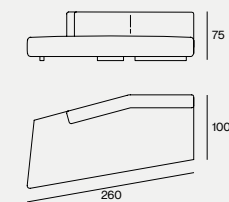

**SOFA ELEMENT H RH 260X100X75H**

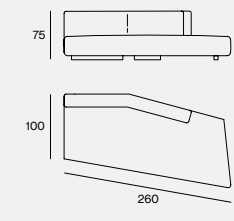

**DIMENSIONS ELEMENTS LH 260X136X75H**

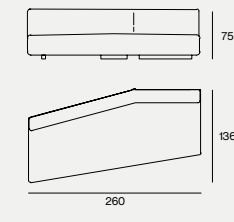

**DIMENSIONS ELEMENTS RH 260X136X75H**

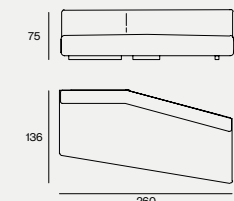

**DIMENSIONS ELEMENTS L LH 163X163X75H**

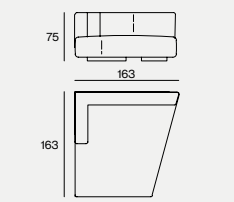

**DIMENSIONS ELEMENTS L RH 163X163X75H**

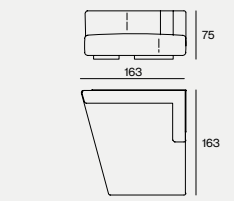

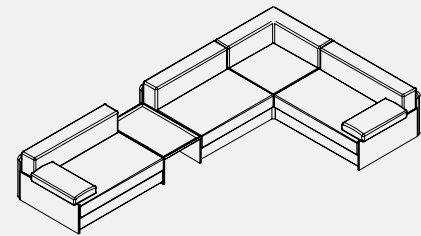

#### GATTOPARDO

The Gattopardo sofa, with its rigorous geometric volumes and its black burnished metal low back, reimagines an aesthetic synergy between memory and modern tones. The seat cushions underline the superb and refined linearity with their soft feather padding.

#### STRUCTURE

Black Burnished Steel.

#### PADDING

Seat cushions in Ecolypha 40 with pad in polyurethane T50 and VE40S, covered with duvet 100% white duck Gold Label 280 and anti-duvet 100% cotton fabric 210 gr. Backrest and armrest cushions in PF25SM, covered with duvet 100% white duck Gold Label 280 and anti-duvet 100% cotton fabric 210 gr.

#### UPHOLSTERY

Leathers and fabrics from our range (removable).

#### TRAY

Sand cast Peltro.

#### DIMENSIONS

120x107x70h cm  
140x107x70h cm

#### TRAY

98x63x3.5h cm

ELEMENT A WITH TRAY L 120X107X70H

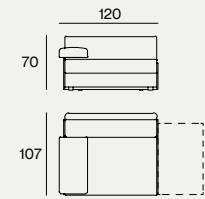

ELEMENT A WITH TRAY R 120X107X70H

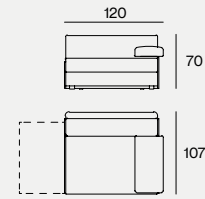

ELEMENT A WITH TRAY L 140X107X70H

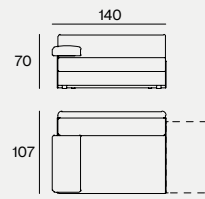

ELEMENT A WITH TRAY R 140X107X70H

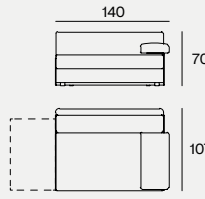

ELEMENT B WITH TRAY L 140X107X70H

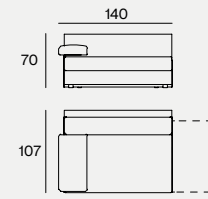

ELEMENT B WITH TRAY R 140X107X70H

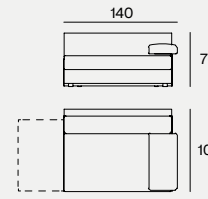

ELEMENT C WITH TRAY L 120X107X70H

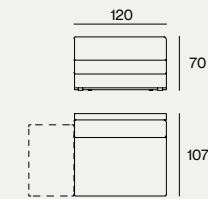

ELEMENT C WITH TRAY R 120X107X70H

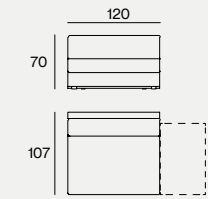

ELEMENT C WITH TRAY L 140X107X70H

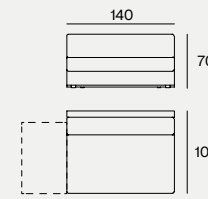

ELEMENT C WITH TRAY R 140X107X70H

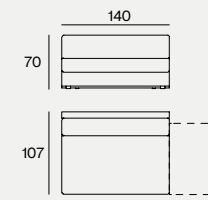

ELEMENT D 120X107X70H

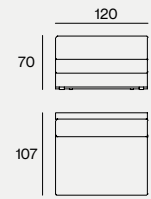

ELEMENT D 140X107X70H

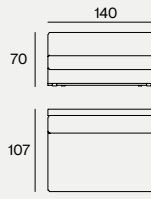

ELEMENT E 120X107X70H

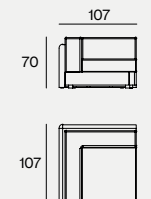

TRAY 98X63X3.5H

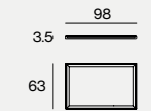

#### GLADIO

The main features of the wall lamp Gladio are long glass trihedrons expressed with long glass trihedrons framed by titanium bands.

#### DESCRIPTION

Dimmable wall light made of metal with a built in trihedron Murano glass. Transformer built in the wall box. Indoor use only.

#### METAL

Metals from our range

#### GLASS

Grey or green

#### DIMENSIONS

12x5x150h cm

DIMENSIONS 1X50X5H

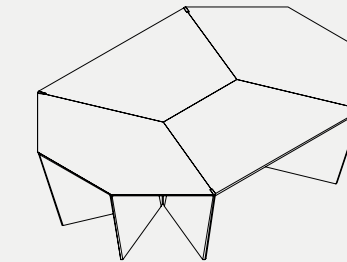
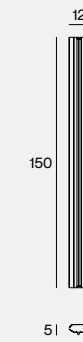

#### GOTHAM

The Gotham table, an unexpected combination of solidity and lightness, combines a refined octagonal top in natural stone with slender triangular legs in cast glass. A diamond nestled among a corolla of evanescent shades.

#### TOP

Stones from our range

#### STRUCTURE

Black Burnished Steel

#### LEGS

Cast glass grey or green

#### DIMENSIONS

270x190x75h cm (octagonal)  
300x110x75h cm (rectangular)  
340x110x75h cm (rectangular)

DIMENSIONS Ø 273X190X75H

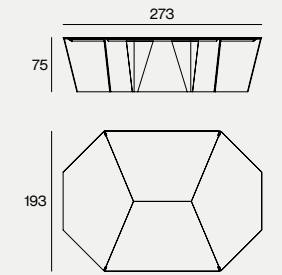

DIMENSIONS 300X110X75H

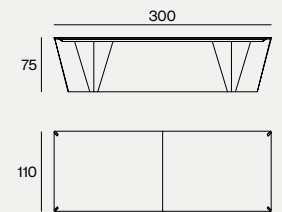

DIMENSIONS 340X110X75H

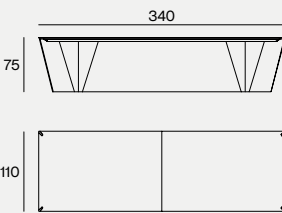





DIMENSIONS 52X57X77H

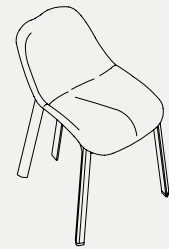
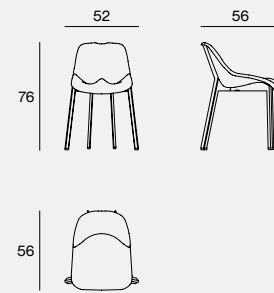

**H-VOLTAGE**

The new, H-Voltage chair, characterized by a sleek and essential shape, lends the ambiance, with its bold and powerfully contemporary look, a refined and metropolitan atmosphere. A highly distinctive, inviting solo with its tempting backward-extended leather shell.

**STRUCTURE**

Black Burnished steel - 5mm.

**SEAT**

Made of a fiberglass shell covered with Phantom or Ghost leathers.  
Cover not removable.

**DIMENSIONS**

52x60x85h cm



**HYPE SYSTEM**

Strong, rigorous lines define the volume of the Hype System. The wall-mounted cabinet configures a balanced composition of full and empty spaces, coplanar wooden shelves, and doors contrast with wide metal side panels. A refined complementarity to the studied simplicity of the design.

**STRUCTURE**

Structure made of 2.5 cm thick solid wood.  
Uprights in sand cast peltro 3cm thick.

**FINISH**

Selected woods from our range.

**DOORS**

Made of solid wood with selected finishes available in our range.

**DIMENSIONS**

140x45x155h cm  
240x45x155h cm  
280x45x155h cm

DIMENSIONS 140X45X155H

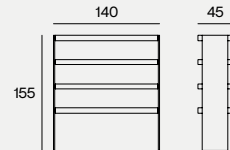

DIMENSIONS 280X45X155H

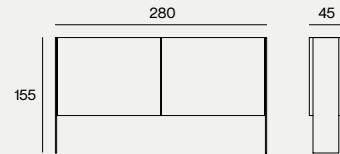

DIMENSIONS 240X45X155H

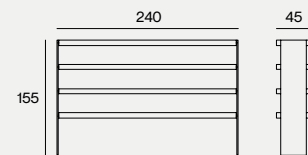

DIMENSIONS 240X45X155H

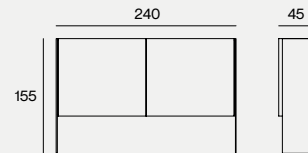

DIMENSIONS 280X45X155H

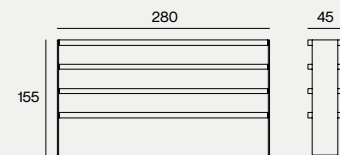

DIMENSIONS 140X45X155H

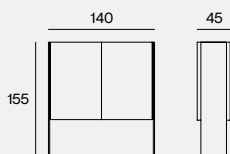

**JILL**

The armchair, Jill, satisfies a highly contemporary aesthetic taste. Casual and elegant, it expresses a refined balance, combining the slender, black-burnished steel frame with the soft, sensual materiality of the comfortable leather seat.

**STRUCTURE**

Ø 1.2 cm heavy duty metal pipe in black burnished steel.

**METAL DETAILS**

Sand cast Peltro

**SEAT**

Seat made of polyurethane with gold label feathers.  
Removable cover with leathers from our range.

**DIMENSIONS**

60x60x72h cm

DIMENSIONS 60X60X72H

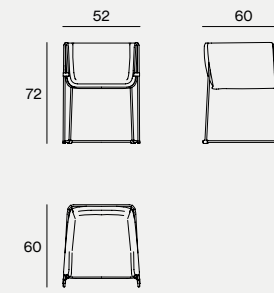

DIMENSIONS 55X60X88H

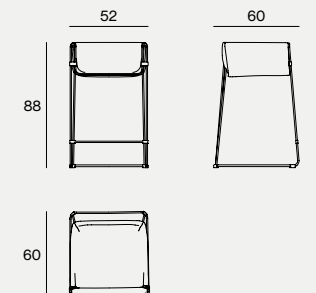

**JILL STOOL**

The armchair, Jill, satisfies a highly contemporary aesthetic taste. Casual and elegant, it expresses a refined balance, combining the slender, black-burnished steel frame with the soft, sensual materiality of the comfortable leather seat.

**STRUCTURE**

Ø 1.2 cm heavy duty metal pipe in black burnished steel.

**METAL DETAILS**

Sand cast Peltro

**SEAT**

Seat made of polyurethane with gold label feathers.  
Removable cover with leathers from our range.

**DIMENSIONS**

60x55x88h cm



DIMENSIONS Ø15

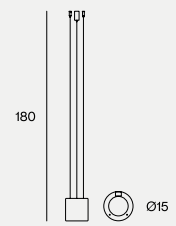

DIMENSIONS Ø20

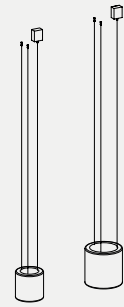
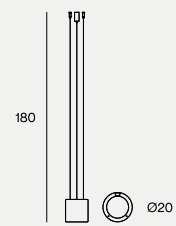

**LIGHT RING XS**

Brass cylinders in different finishes and sizes, supported by metal cables, combined and concerted with total creative freedom, draw dynamic and vibrant luminous graphisms.

**STRUCTURE**

Energy saving led (energy efficiency index A) lamp with warm light, transformer incorporated in the ceiling rosette, plated power lead with black metal cord. Available with extra warm light 2700K (without extra costs). Only for indoor use. Standard overall height 180 cm.

**FINISH**

External ring in black burnished steel, burnished Platino, burnished Titanio, burnished brass, black burnished brass, H-Silver, H-Silver Black, internal ring in the same material, glossy finish

**DIMENSIONS**

Ring Ø 15 h 15 cm with up and down pointing led -3000K  
 Ring Ø 20 h 20 cm with up and down pointing led -3000K

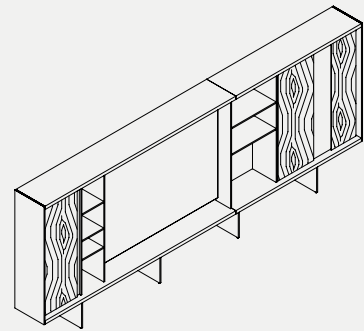

**LOOM**

**STRUCTURE**

Top and base thickness 4 cm, shelves thickness 1,5 cm solidwood veneered. Sides in 1,5 cm wood veneered. Storage with backrest in bronzed mirror and shelves in bronzed tempered glass thickness 1 cm. Led light recessed into the top (downward) 3000K.

**STRUCTURE FINISHES**

Oak thermowood, Eucalyptus thermowood, Black Eucalyptus thermowood, Swamp oak, Swamp Elm, or covered with black burnished Steel.

**SIDES FINISHES**

Oak thermowood, Eucalyptus thermowood, Black Eucalyptus thermowood, Swamp oak, Swamp Elm, or covered with black burnished Steel.

**HINGED DOORS**

With 3 cm hinged door in solidwood veneered.

**DOORS FINISHES**

Oak thermowood, Eucalyptus thermowood, Black Eucalyptus thermowood, Swamp oak, Swamp Elm or H-Piuma, with groove handle with insert in black burnished steel.

BOOKSHELF WITH TV PANEL 440X40X175H

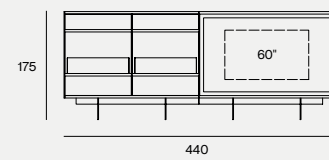

BOOKSHELF 440X40X175H



BOOKSHELF WITH TV PANEL 360X40X175H

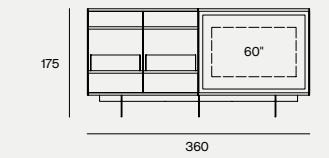

BOOKSHELF 450X40X175H



BOOKSHELF WITH TV PANEL 550X40X175H

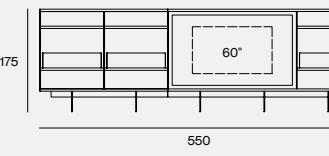

DOOR UNIT BOOKSHELF 440X40X175H

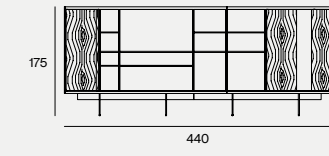

DOOR UNIT BOOKSHELF 440X40X175H

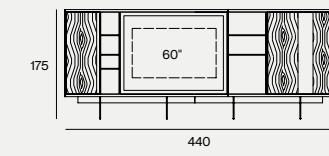

DOOR UNIT BOOKSHELF WITH TV PANEL 410X40X175H

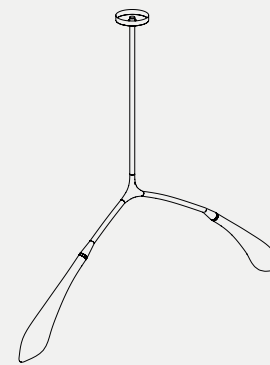
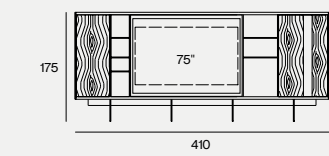

**MAPLE**

Like the seeds of the Maple tree, Maple, pendant light, expands its stems in black burnished brass, germinating with unusual and charismatic organic buds in blown glass.

**DESCRIPTION**

Low consumption suspension LED lamp with brass structure and central Y-shaped body in cast bronze (or brass). Transparent or frosted glass available. Transformer integrated in the ceiling canopy.

**METAL**

Burnished Brass or Black Burnished Glass. Matching core in Sand Cast Brass or Sand Cast Bronze.

**GLASS**

Grey or green.

**DIMENSIONS**

150x19x110h cm  
 110x19x110h cm

DIMENSIONS 150X19X110H

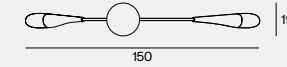
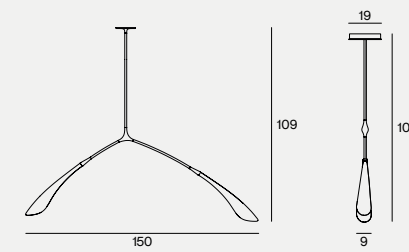

DIMENSIONS 110X19X110H

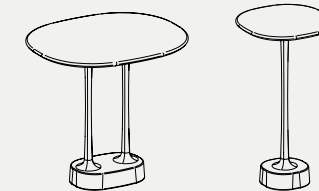
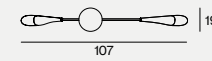
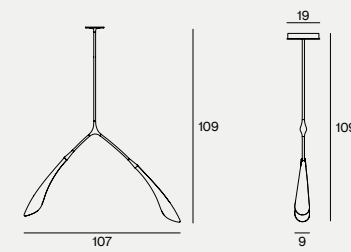

**MUSHROOM**

**STRUCTURE**

Mullion and top in sandcasting Brass, Bronze or Silver.

**DIMENSIONS**

Cm 32x32x60h  
 Cm 46x55x53h

DIMENSIONS 32X32X60H

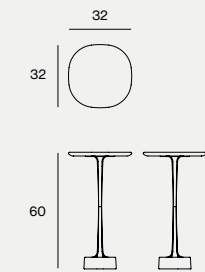

DIMENSIONS 46X55X53H

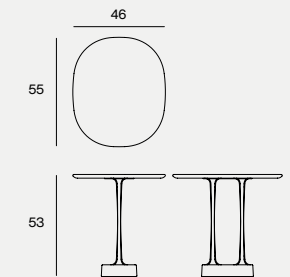



DIMENSIONS 360X100X94H

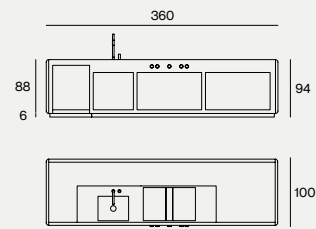

DIMENSIONS 310X130X94H

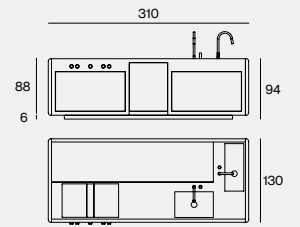

DIMENSIONS 310X130X94H

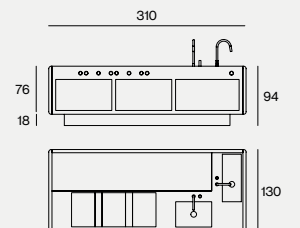

DIMENSIONS 470X108X94H

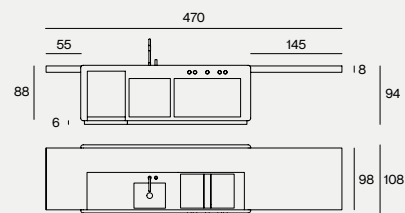

DIMENSIONS 420X97X94H

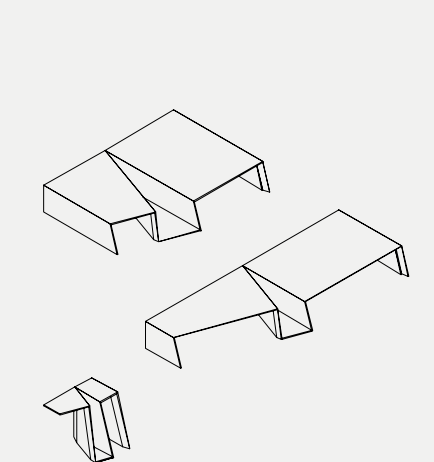
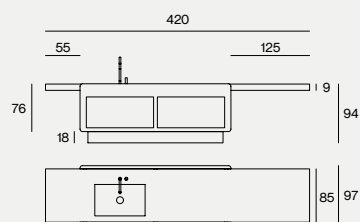

**ORIGAMI**

Origami, a skillfully crafted coffee table, performs the folding technique with great charm, like a famous Japanese artistic composition.

**STRUCTURE**

Module 1 in Sand Cast Peltro

Module 2 with stones from our range.

\*The sizes 170cm and 250cm require both modules

\*\*The size 55cm is available only in Sand Cast Peltro

**DIMENSIONS**

170x125x30h cm  
250x90x30h cm  
55x45x50h cm

DIMENSIONS 250X90X30H

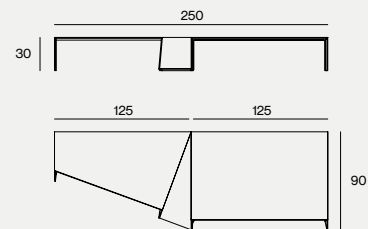

DIMENSIONS 170X125X30H

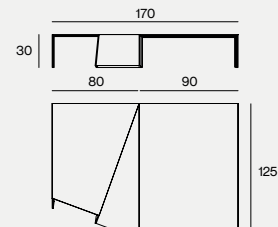

DIMENSIONS 55X45X50H

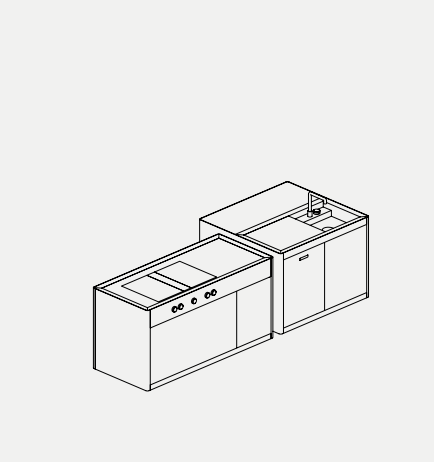
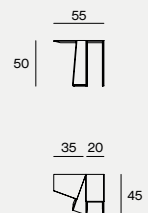

**OXYGEN**

Oxygen, speaks a language of surprising refinement and singularity, expressing itself with sensuality, and resonating like an intense, warm chromatic note. One or two monolithic blocks boldly combine the alchemy of a stone and the entire structure wrapped in precious metal.

**TOP**

Stones featured in the HK catalogue.

**SIDE PANELS**

Metals featured in the HK catalogue.

**DRAWERS**

Drawers in thermo solid wood with electric soft closing mechanism. Available options in Oak Thermo Wood and Swamp Olive Ash.

**CARCASS**

Matt black plywood – 2 cm

**ACCESSORIES**

Metal trays, cutlery holder, drain grid, chopping board, leather pads and stainless steel bins.

DIMENSIONS 360X90X93H

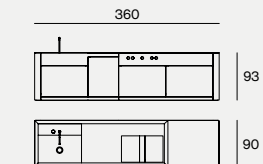

DIMENSIONS 360X150X93H

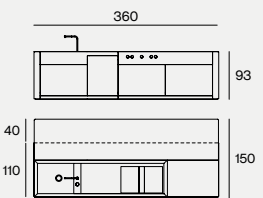

M1 450X78X93H / M2 250X72X93H

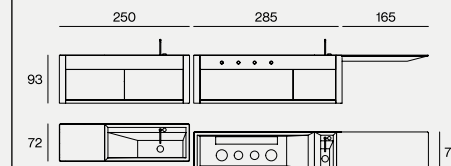

M1 320X150X93H / M2 220X72X93H

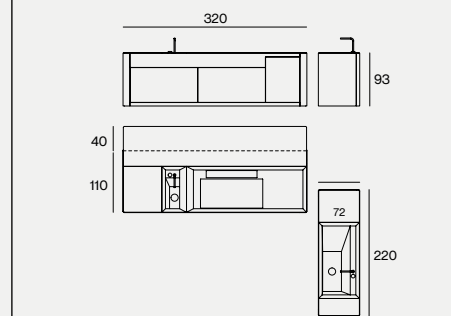

M1 185X81X93H / M2 130X120X93H

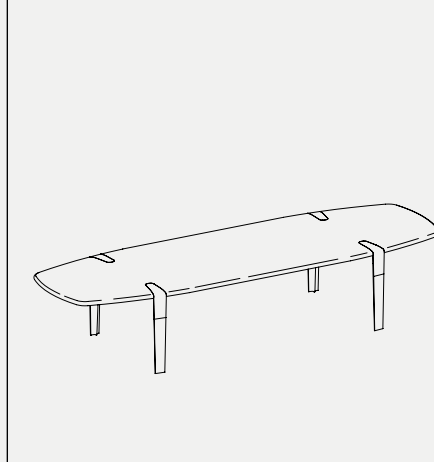
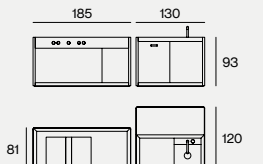

**OXYMORON**

**STRUCTURE**

Steel frame with legs in sandcasting, bronze.

**TOP**

6 cm thickness solidwood Forest Fusion or Forest Fusion black.

**DIMENSIONS**

Cm 300x110x75h  
Cm 250x110x75h  
Cm 380x120x75h  
Cm 330x120x75h  
Cm 330x150x75h  
Cm 300x150x75h  
CM 250x150x75H  
Sizes can be customized.

DIMENSIONS 380X120X75H

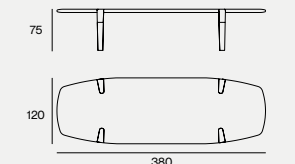

DIMENSIONS 330X120X75H

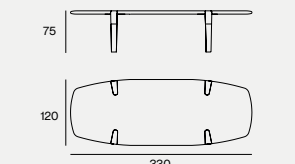

DIMENSIONS 300X110X75H

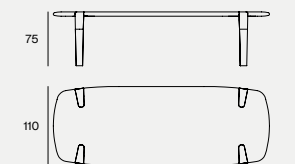

DIMENSIONS 250X110X75H

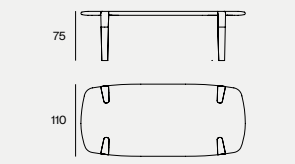

DIMENSIONS 330X150X75H

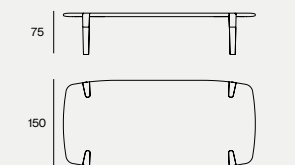

DIMENSIONS 300X150X75H

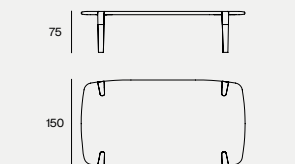

DIMENSIONS 250X150X75H

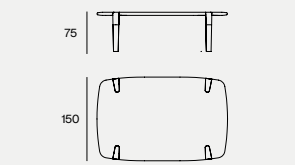



DIMENSIONS 360X85X93H

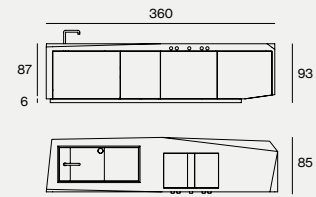

M1 320X85X93H / M2 192X97X93H

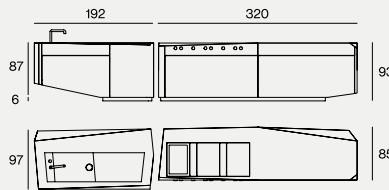

M1 320X85X93H / M2 125X125X93H

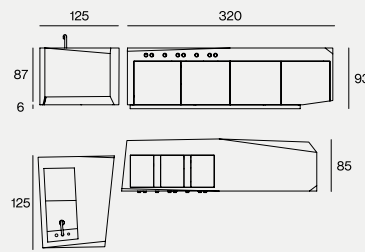

**OZONE**

An outstanding monolith, formed by one or two faceted blocks of natural stone. The Ozone expresses the essential and refined elegance of a kitchen island, a synthesis of functionality and aesthetics, the heart of a new vision of convivial sociality.

**TOP**

Top compatible with Bora and Gaggenau worktops.

**FINISHES**

Stones featured in our HK catalogue.

**DRAWERS**

Drawers in thermo solid wood with electric soft closing mechanism. Available options in Oak Thermo Wood and Swamp Olive Ash.

**CARCASS**

Matt black plywood – 2 cm

**PLINTH**

Black Burnished Steel – 6h cm

**ACCESSORIES**

Metal trays, cutlery holder, drain grid, chopping board, leather pads and stainless steel bins.

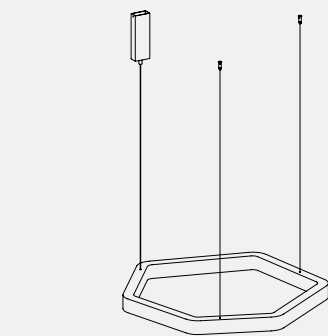
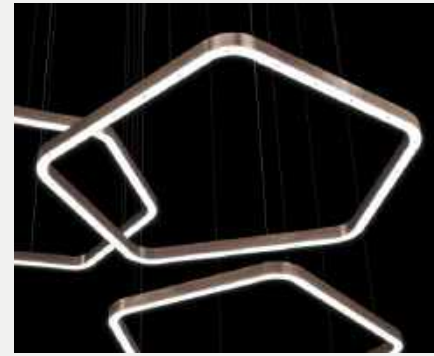

**POLYGONAL**

Concentric rings, in sequence or overlapping, wall-mounted or suspended, develop archetypal visual codes inspired by the beauty and purity that the circle synthesizes in its perfect symbolic form. An idea realized with important hand-crafted materials that diffuse a warm and intriguing light.

**STRUCTURE**

Energy saving led lamp (energy efficiency index A) with warm light, formed with rings of various sizes and types of illumination; transformer incorporated in the ceiling rosette, low voltage power supply to the rings through the suspension cables. Available alternative fixing system for lamp with remote transformer. Available with extra warm light (without extra costs). Only for indoor use. Dimmable upon request. Standard overall height 180 cm.

**FINISH**

Black burnished steel, burnished Platino, burnished Titanio, burnished brass, black burnished brass, H-Silver, H-Silver Black or Silver Patina using.

DIMENSIONS Ø50



DIMENSIONS Ø60



DIMENSIONS Ø70



DIMENSIONS Ø100



DIMENSIONS Ø120

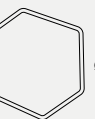

DIMENSIONS Ø140



DIMENSIONS Ø160



DIMENSIONS Ø180



DIMENSIONS Ø220



DIMENSIONS Ø280



DIMENSIONS Ø300

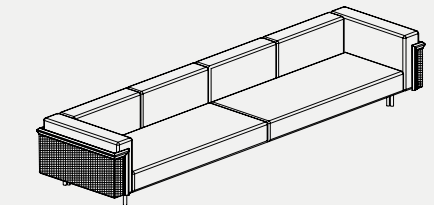
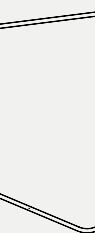

**RF ROCK**

**STRUCTURE**

Norwegian solid wood and metal mesh.

**PADDING**

Structure in solid wood with metal mesh. Seat cushion in Ecolypha 40 with pad in polyurethane T50 and VE40S, covered with duvet 100% white duck Gold Label 280 and anti-duvet 100% cotton fabric 210 gr. Backrest and armrest cushions in PF25SM, covered with duvet 100% white duck Gold Label 280 and anti-duvet 100% cotton fabric 210 gr.

**UPHOLSTERY**

Leather or fabric from our range.

**WOODEN BACK STRUCTURE**

In solid wood open pore matt lacquered in selected colors with metal mesh.

**DIMENSIONS**

Cm 100x72h

Seat cm 43h

SOFA WITH WOODEN FRAME 270X100X72H

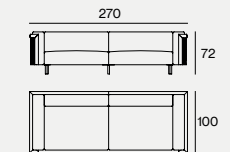

SOFA WITH WOODEN FRAME 340X100X72H

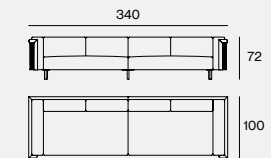

SOFA WITH WOODEN FRAME 410X100X72H

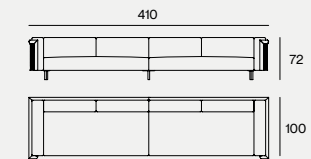

ELEMENT LH WITH WOODEN FRAME 135X100X72H

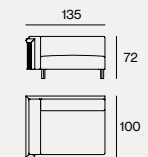

ELEMENT RH WITH WOODEN FRAME 135X100X72H

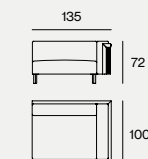

ELEMENT LH WITH WOODEN FRAME 170X100X72H

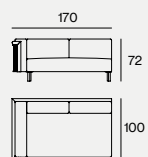

ELEMENT RH WITH WOODEN FRAME 170X100X72H

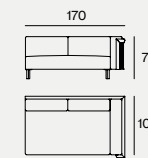

ELEMENT LH WITH WOODEN FRAME 205X100X72H

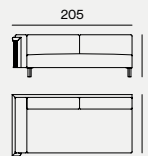

ELEMENT RH WITH WOODEN FRAME 205X100X72H

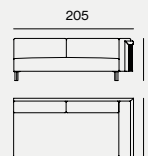

CORNER ELEMENT LH 135X100X72H

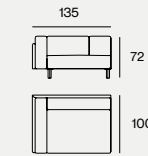

CORNER ELEMENT RH 135X100X72H

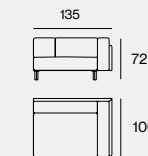

CORNER ELEMENT LH 170X100X72H

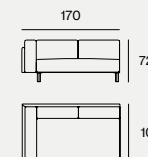

CORNER ELEMENT RH 170X100X72H

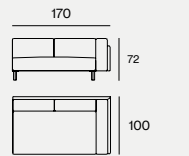

CORNER ELEMENT LH 205X100X72H

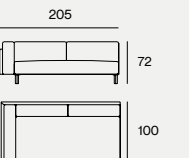

CORNER ELEMENT RH 205X100X72H

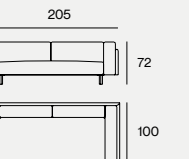

DIMENSIONS 235X90X72H

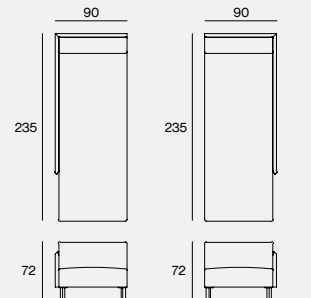

DIMENSIONS 135X140X72H

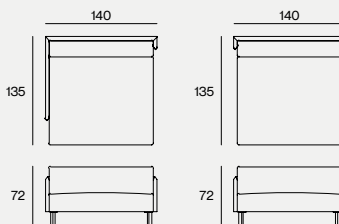



DIMENSIONS 58X53X72H

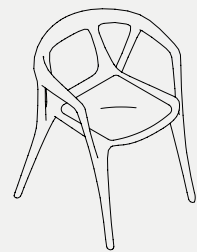
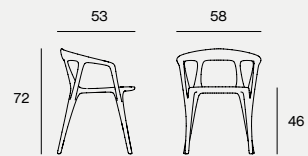

**SAVANNA**

**STRUCTURE**

Wooden structure finish Black Wood, Olive Ash or open pore matt lacquered in selected colours matching with the chosen leather finish. Seat covered with leather from our samples catalogue. Cover not removable.

**DIMENSIONS**

Cm 58 x 53 x 72 h  
Seat cm 46 h



DIMENSIONS 300X90X75H

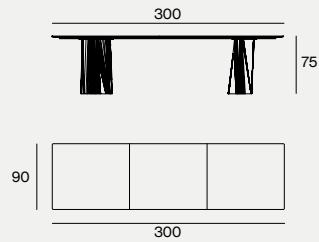

DIMENSIONS 320X150X75H

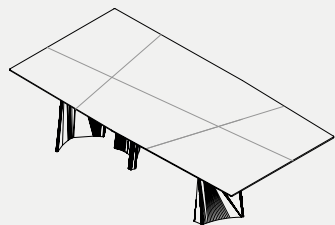
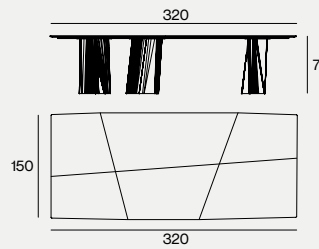

**SISMA**

Sisma, a table of great versatility, stems from the harmonious visual interplay between the generously proportioned concave and convex forms of its skillfully shaped and hand-chiseled legs.

**TOP**

Rapolano VS  
Sand Cast Peltro

**STRUCTURE**

Rapolano Travertine

**DIMENSIONS**

300x90x75h cm (2 legs)  
320x150x75h cm (3 legs)



**SPYDER**

The wall-mounted or suspended lights, Spyder, a triangulation of stretched out in tension metal cables and backlit glass cylinders in an industrial chic style. With a burnished brass finish, this light offers the possibility of 'spider web' compositions and interwoven, creative and endless patterns with powerful graphic incisiveness.

**DESCRIPTION**

Brass with light source in borosilicate glass. Energy efficiency index A. Available in 2 versions: single and double light module. Remote transformer. Only for indoor use.

**METAL**

Burnished Brass or Black Burnished Glass

**GLASS**

Grey or green

**DIMENSIONS**

100 cm  
150 cm  
100+150 cm

WALL MOUNTED LIGHT LENGTH 100 CM

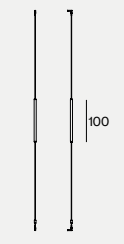

WALL MOUNTED LIGHT LENGTH 100 + 100 CM

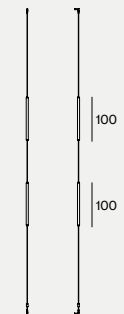

CEILING MOUNTED LIGHT LENGTH 100 CM

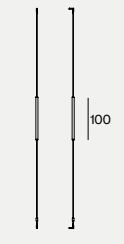

CEILING MOUNTED LIGHT LENGTH 100 + 100 CM

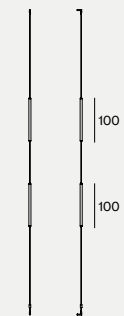

WALL MOUNTED LIGHT LENGTH 150 CM

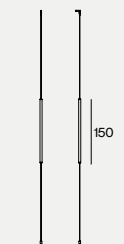

WALL MOUNTED LIGHT LENGTH 100 + 150 CM

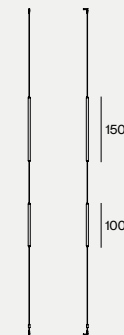

CEILING MOUNTED LIGHT LENGTH 150 CM

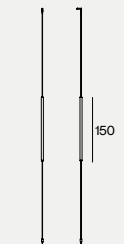

CEILING MOUNTED LIGHT LENGTH 100 + 150 CM

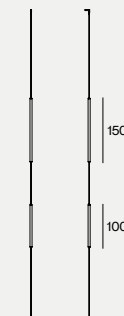

**SR**

**STRUCTURE**

0,4 cm steel or brass. 0,8 cm thick steel or brass legs.

**FINISHES**

Black burnished steel, Brass, brass Patina, H-Silver®, Silver Patina, H-Pale Gold Patina, burnished by hand using traditional techniques, a result of an exclusive HENGE recipe.

**TOP**

Top thickness 2 cm.

**TOP FINISHES**

Swamp Olive Ash, Forest Fusion or Forest Fusion Black, H-Piuma, H-Piuma Light, Titanium foam. Stones as per our samples.

**DIMENSIONS**

Ø cm 81,6x39h  
Ø cm 100x39h  
Ø cm 121,6x25h  
Ø cm 141,6x25h  
Ø cm 160x25h

DIMENSIONS Ø 81,6X39H

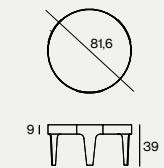

DIMENSIONS Ø 101,6X39H

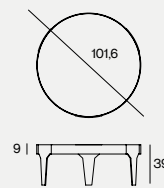

DIMENSIONS Ø 121,6X25H

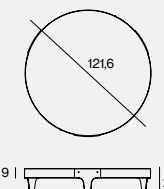

DIMENSIONS Ø 141,6X25H

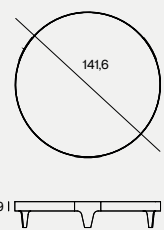

DIMENSIONS Ø 161,6X25H

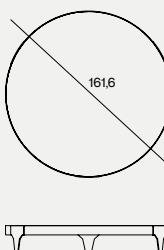

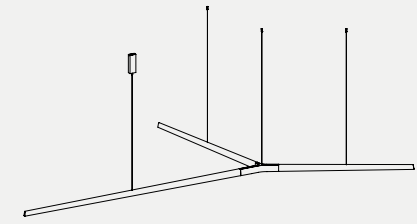

#### STARLIGHT

Emblematic pieces between art and design, sculptural ramifications of great purity and size that combine essentiality and refined treatment of materials, extraordinary encounters of bold geometries that trace extensive, eclectic suspended lightscapes.

#### STRUCTURE

Dimmable pendant energy saving led lamp (Energy efficiency index A) with Y-shaped central body (Energy efficiency index A) with warm light. Metal structure and light body in gray fiberglass available in different dimensions. Low voltage power supply cable inside the support rod. Transformer incorporated in the ceiling rosette. Available alternative fixing system for lamp with remote transformer. Available extra warm light (without extra costs). Only for indoor use. Dimmable push button. Other dimming systems available upon request. Standard overall height 180 cm.

D 262X174X8H - XL A

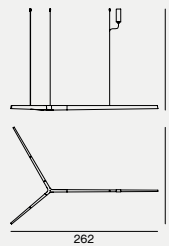

D 305X156X8H - XL B

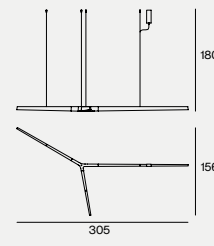

DIMENSIONS 311X126X8H - XL C

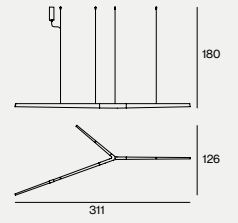

DIMENSIONS 405X249X8H - XL A MAXI

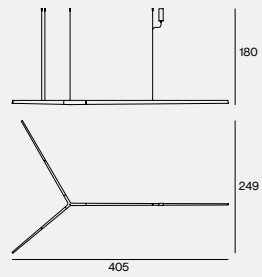

DIMENSIONS 483X280X8H - XL B MAXI

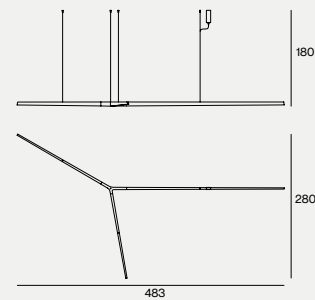

DIMENSIONS 459X226X8H - XL C MAXI

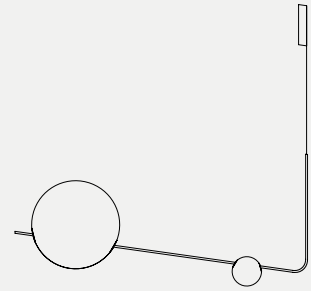
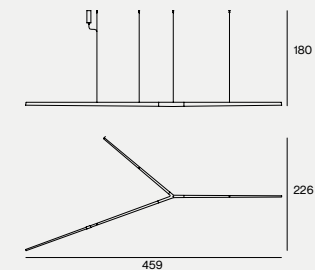

#### SUPERB ALL

Iconic and eccentric fiberglass spheres of varying sizes, suspended with daring narcissism from long, tapered burnished brass and metal stems, in an intersection between geometry and gravity, whimsically weave virtuous narratives, extravagantly emphasizing a metaphorical interplay.

#### STRUCTURE

Dimmable ceiling energy-saving led lamp (energy efficiency index A) with warm light. Metal structure and light body in gray fiberglass available in different dimensions. Low voltage power supply cable inside the support rod. Transformer incorporated in the ceiling rosette. Standard overall high 200 cm. Can be customized. Available extra warm light 2700K (without extra cost). Dimmable push bottom, different dimming system available upon request.

#### FINISH

Black burnished Steel, Burnished Titanio, Burnished Platino, Burnished Brass, Black Burnished Brass, H-Silver and H-Silver Black.

DIMENSIONS 120X180 - Ø20

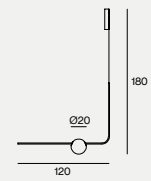

DIMENSIONS 120X180 - Ø40

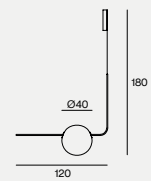

DIMENSIONS 120X180 - Ø60

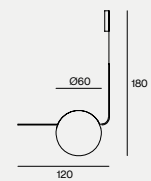

DIMENSIONS 120X180 - Ø40+Ø20

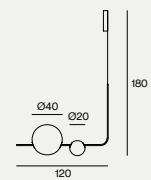

DIMENSIONS 120X180 - Ø40+Ø30

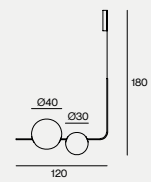

DIMENSIONS 120X180 - Ø60+Ø20

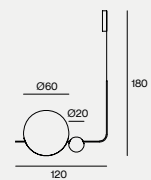

DIMENSIONS 120X180 - Ø60+Ø30

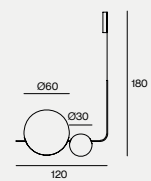

DIMENSIONS 160X180 - Ø20

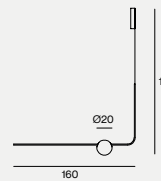

DIMENSIONS 160X180 - Ø40

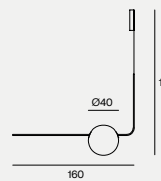

DIMENSIONS 160X180 - Ø60

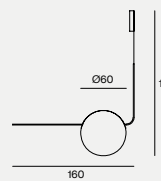

DIMENSIONS 160X180 - Ø40+Ø20

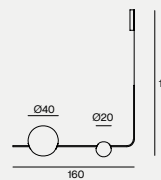

DIMENSIONS 160X180 - Ø40+Ø30

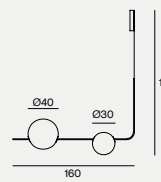

DIMENSIONS 160X180 - Ø60+Ø20

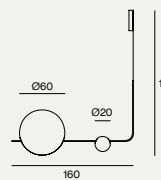

DIMENSIONS 160X180 - Ø60+Ø30

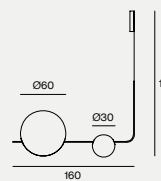

DIMENSIONS 200X180 - Ø20

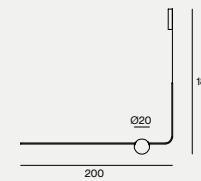

DIMENSIONS 200X180 - Ø40

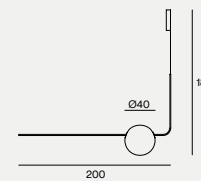

DIMENSIONS 200X180 - Ø60

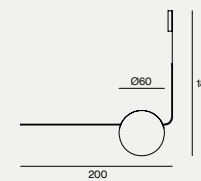

DIMENSIONS 200X180 - Ø40+Ø20

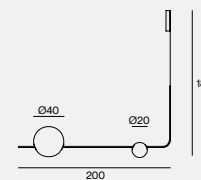

DIMENSIONS 200X180 - Ø40+Ø30

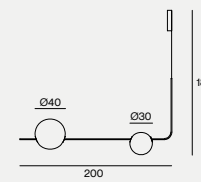

DIMENSIONS 200X180 - Ø60+Ø20

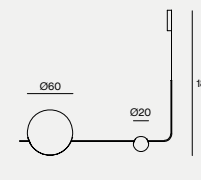

DIMENSIONS 200X180 - Ø60+Ø30

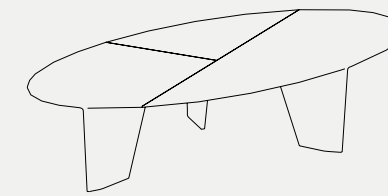
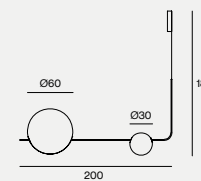

#### SYNAPSE

#### STRUCTURE

Black paint steel pipe.

#### TOP AND LEGS FINISH

Cappuccino sandblasted or Black Lake.

#### DIMENSIONS

Ø cm 200x75h  
Cm 360x180x75h  
Sizes can be customized.

DIMENSIONS Ø 200X75H

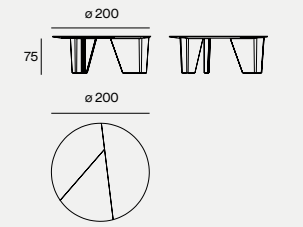

DIMENSIONS 360X180X75H

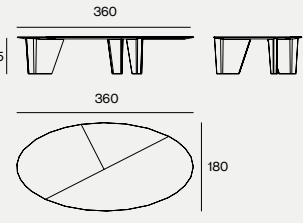



DIMENSIONS Ø 50X42H

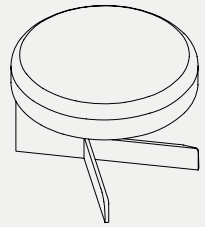
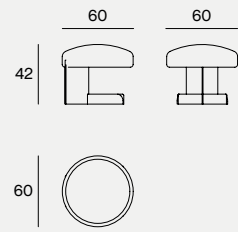

**TAMBOURINE**

Eclectic and versatile, the Tambourine pouf, playing on the contrast between the rigorous leg in metal and the soft, round seat, lends a distinctive vivid decorative accent.

**STRUCTURE**  
Sand Cast Peltro

**SEAT**  
Seat cushions in Ecolypha 40 with pad in polyurethane T50 and VE40S, covered with duvet 100% white duck Gold Label 280 and anti-duvet 100% cotton fabrics or leathers from our range.

**DIMENSIONS**  
Ø50x42h cm



DIMENSIONS 280X55X65H

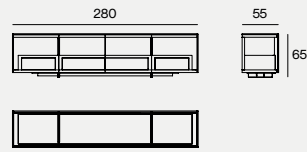

DIMENSIONS 325X55X65H

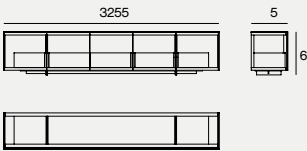

DIMENSIONS 390X55X65H

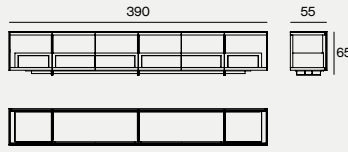

DIMENSIONS 280X55X85H

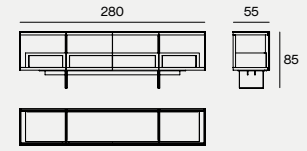

DIMENSIONS 325X55X85H

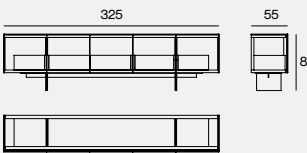

DIMENSIONS 390X55X85H

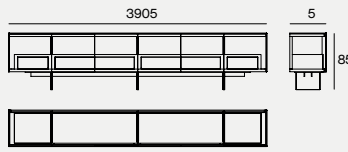

**TEKE**

**STRUCTURE**  
Sides, top and hinged doors in extra clear glass, bottom in black burnished brass. Backrest in stone, internal drawer cabinet covered with metal. Internal led light with natural warm light 3000K recessed in the bottom up warding.

**FINISH**  
Backrest in stone from our range. Internal cabinet with flap door covered with black burnished Steel, burnished Platino, burnished Titanio, burnished brass, Ottone Patina, H-Silver, Silver Patina.

**BASE**  
High 7 or 27 cm in black burnished steel.

**DIMENSIONS**  
Cm 280x55x65h  
Cm 325x55x65h  
Cm 390x55x65h  
Cm 280x55x85h  
Cm 325x55x85h  
Cm 390x55x85h



DIMENSIONS 15X18X71H

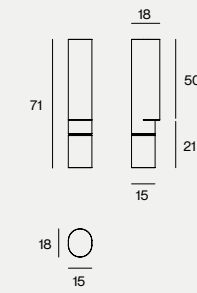

**TEST ONE**

A floor or table lamp, the Test series is an elegant and slender stone monolith, characterized by essential lines and rich material opulence. A presence with a strong personality that reveals a hidden expressive soul: brutalism that transforms into sculptural opalescence or lights up through its natural cavities, conspiring for sophisticated atmospheres of intimacy.

**STRUCTURE**  
Sculptural stone table lamp with hollowed monolithic diffuser element connected by a rotating brass ring with a switch and dimmer function.

**DIMENSIONS**  
Cm 71x15x18



DIMENSIONS 86X86X230H

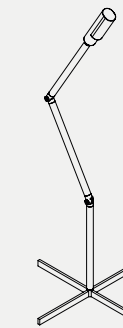
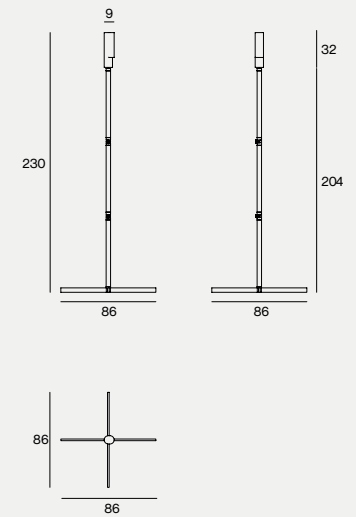

**TEST TREE**

Eccentric and sophisticated, in an extravagant high-tech interpretation, the floor lamp, Test-tree, synthesizes classic and contemporary in its minimal geometric structure. The slender silhouette of its segmented body, embellished with cylindrical diffusers in Ice Onyx, connected by brass joints, becomes in any ambience a catalyzing focal point.

**STRUCTURE**  
Floor lamp made of stone elements connected by solid burnished brass joints. Omnidirectional head and wide base with cross-shaped brass bars.

**DIMENSIONS**  
Cm 230x87x87



DIMENSIONS 45X45X130H

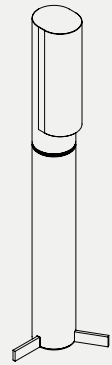
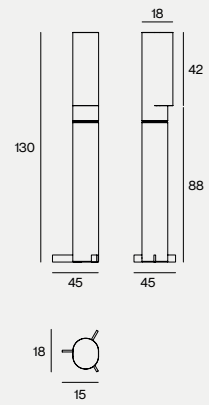

**TEST TWO**

A floor or table lamp, the Test series is an elegant and slender stone monolith, characterized by essential lines and rich material opulence. A presence with a strong personality that reveals a hidden expressive soul: brutalism that transforms into sculptural opalescence or lights up through its natural cavities, conspiring for sophisticated atmospheres of intimacy.

**STRUCTURE**

Sculptural stone table lamp with hollowed monolithic diffuser element connected by a rotating brass ring with a switch and dimmer function.

**DIMENSIONS**

Cm 130x15x18



DIMENSIONS 240X75X75H

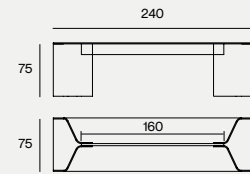

DIMENSIONS 280X75X75H

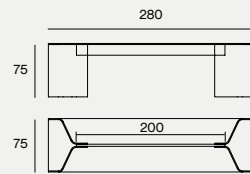

DIMENSIONS OPTIONAL DRAWERS

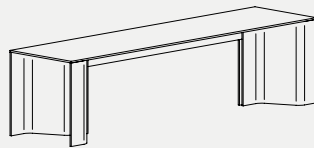
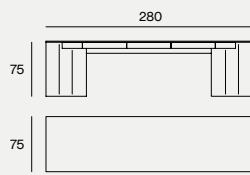

**TIME**

**STRUCTURE**

Solidwood, thickness 1,5 cm or 1 cm

**FINISH**

Heat treated woods as our samples, Swamp Oak and Swamp Elm oil finish based on natural wax and water or covered with H-Pale Gold Patina, Burnished Brass or Black Burnished Brass.

**DIMENSIONS**

Cm 240x75x75h  
Cm 280x75x75h  
Sizes can be customized.



MODULE B

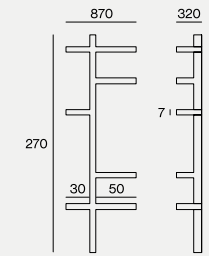

MODULE C

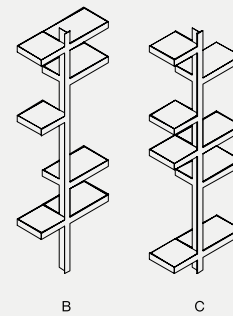
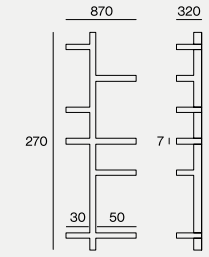

**UNICODE**

The bookcase, Unicode, a simple vertical metal structure of thick lines, stretches along the wall articulating a staggered alternation of shelves in precious stone or metal, imposing with its sculptural composure a graphic sign between functionality and art.

**STRUCTURE**

Made of steel finished in Burnished Platino or Burnished Titanio.

**SHELF INSERTS**

2 Shelves can be personalised with stones and woods available from our range.

**DIMENSIONS**

870x320x270h cm



DIMENSIONS 200X48X270H

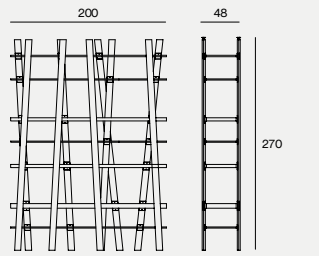

DIMENSIONS 250X48X270H

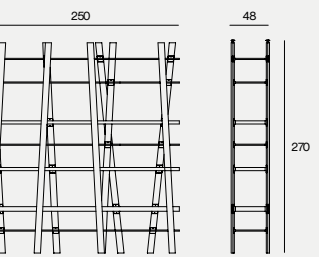

DIMENSIONS 300X48X270H

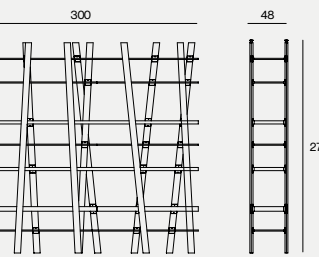

**WEB**

**STRUCTURE**

Upright in sandcasting Titanio.

**SHELVES**

1,5 cm thick solid wood veneer. Fix shelves as per drawing.

**SHELVES FINISHES**

Oak thermowood, eucalypto thermowood, black eucalyptus thermowood or Swamp Oak and Swamp Elm oil finish based on natural wax and water.

Mandatory ceiling fixing kit included.

**DIMENSIONS**

Cm 200x48x270h  
Cm 250x48x270h  
Cm 300x48x270h  
Sizes can be customized.



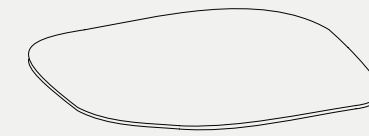

**HIMALAYA**

**STRUCTURE**

5 cm high hand-woven rugs on horizontal looms, finished with a knotting on the back. Made in Nepal using Himalaya wool, the most precious in the world, that only has a limited production per year. Color obtained from the selection of the fleece of the sheep themselves. It is 100% natural, undyed wool. Spun, carded and knotted by hand, washed with sapid soap and hazelnuts that release a natural detergent. Edges tapered by hand on all sides. Completely organic product.

**DIMENSIONS**

520x517x5h cm  
558x355 x5h cm  
550x328 x5h cm  
650x358 x5h cm  
Indicative dimensions, maximum variations of  $\pm 3\%$   
Sizes can be customized.

**DIMENSIONS 520X517X5H**

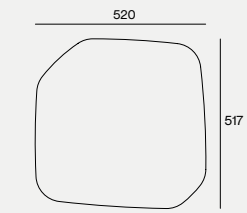

**DIMENSIONS 650X358X5H**



**DIMENSIONS 559X355X5H**



**DIMENSIONS 550X329X5H**

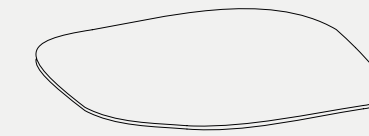

**NEW ZEALAND &  
NEW ZEALAND RASATO**

**STRUCTURE**

Hand-woven carpet on horizontal looms finished with a knotting on the back. Made with New Zealand wool, dyed in the range colors, hand loom knotted. Edges tapered by hand on all sides.

**DIMENSIONS**

520x517x5h cm  
650x358x5h cm  
559x355x5h cm  
550x329x5h cm  
Indicative dimensions, maximum variations of  $\pm 3\%$   
Sizes can be customized.

**DIMENSIONS 520X517X5H**

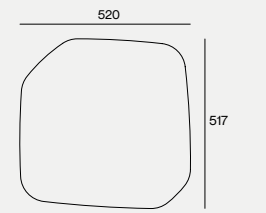

**DIMENSIONS 650X358X5H**



**DIMENSIONS 559X355X5H**

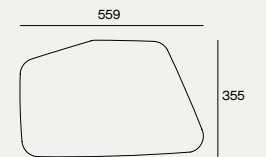

**DIMENSIONS 550X329X5H**

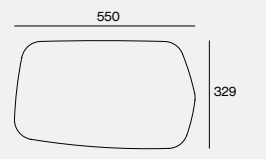

# S34 / 1

PRODUCT DESIGN BY  
Massimo Castagna  
Ugo Cacciatori  
Yabu Pushelberg  
Isabella Genovese  
Stephen Tierney

BOOK ART DIRECTION  
Studiogusto

GRAPHIC DESIGN  
Studiogusto

PHOTO & STYLING  
Giuseppe Toja  
Max Zambelli  
Andrea Pancino Studio  
Giandomenico Troiano

Elena Caponi Studio

PRINTED IN ITALY BY  
IMOCO Group

September 2022

## HENGE

## S·34

Henge Headquarters  
Via Fossa 1  
31051 Follina (TV) — Italy

Via della Spiga 34  
20121 Milano (MI) — Italy  
T +39 0438 1710600

atelier@henge07.com  
Open by appointment

[www.henge07.com](http://www.henge07.com)

