

Alphabet of light Gople system

BIG - Bjarke Ingels Group



Artemide[®]

Alphabet of Light

Authors

BIG - Bjarke Ingels Group

BIG is a Copenhagen, New York, London and Barcelona based group of architects, designers, urbanists, landscape professionals, interior and product designers, researchers and inventors. The office is currently involved in a large number of projects throughout Europe, North America, Asia and Middle East.

BIG's architecture emerges out of a careful analysis of how contemporary life constantly evolves and changes. Not least due to the influence from multicultural exchange, global economical flows and communication technologies, that all together require new ways of architectural and urban organization. They believe that in order to deal with today's challenges, architecture can profitably move into a field that has been largely unexplored. A pragmatic utopian architecture that steers clear of the petrifying pragmatism of boring boxes and the naïve utopian ideas of digital formalism. Like a form of programmatic alchemy, they create architecture by mixing conventional ingredients such as living, leisure, working, parking and shopping. By hitting the fertile overlap between pragmatic and utopia, the architects once again find the freedom to change the surface of our planet, to better fit contemporary life forms.



Alphabet of light

BIG - Bjarke Ingels Group
2016

Alphabet of light system is a lighting language that continues to grow with new curved elements so it can be developed with increasing freedom throughout space. It is a basic principle that generates an open system implementing just a handful of basic modules.

Thanks to specific geometric proportions, these modules can be combined together to form endless lighting structures, from the most elemental to the most complex, both linear and curved. The BIG idea is combined with Artemide's optoelectronic expertise to give rise to an innovative construction principle that casts continuous and comfortable light.

It is a minimal presence that conceals ultra-sophisticated optoelectronic and patented mechanical innovation as well as ground-breaking control. The system can be controlled using the Artemide App to create freedom both in geometric design and in the definition of dynamic performance levels, which can be programmed or modified in real time. BIG designed a new font, an alphabet that can be used to write and express one's thoughts, to establish an identity and to guide visitors through a space using light. It can help give shape to a wide range of locations and public spaces, from hotels and offices to universities and hospitals.



**Artemide
App**



For further information on Alphabet of light
→ visit artemide.com









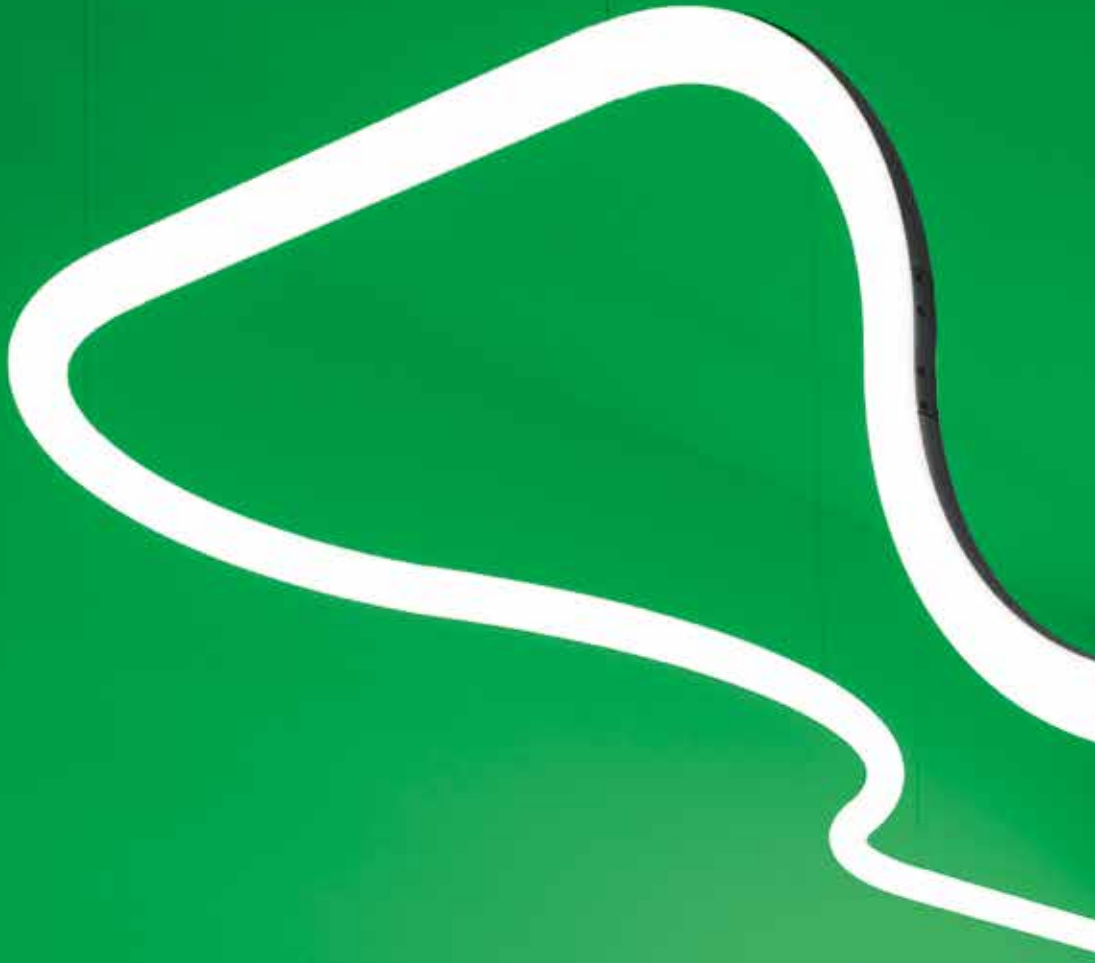

EPD

Environmental product declaration



EPDITALY0430
12/05/2023
www.epditaly.it

global geographic validity
in compliance with ISO14025 and EN50693:2019

certified codes: 2108010A, 2113010A, 2135010A
2267010APP, 2267010A, 1207000A, 1208000APP,
2154010A, 2158010A, 2250010A

+
through a dedicated LCA-TOOL all Alphabet of Light
stand alone codes and system compositions can be
certified



Alphabet of Light system

- PATENT OF INVENTION: MECHANICAL AND ELECTRICAL CONNECTION
- PATENT OF INVENTION: OPTICS







IBM Studios
Milano

WELCOME

IBM Studios
Milano

WELCOME









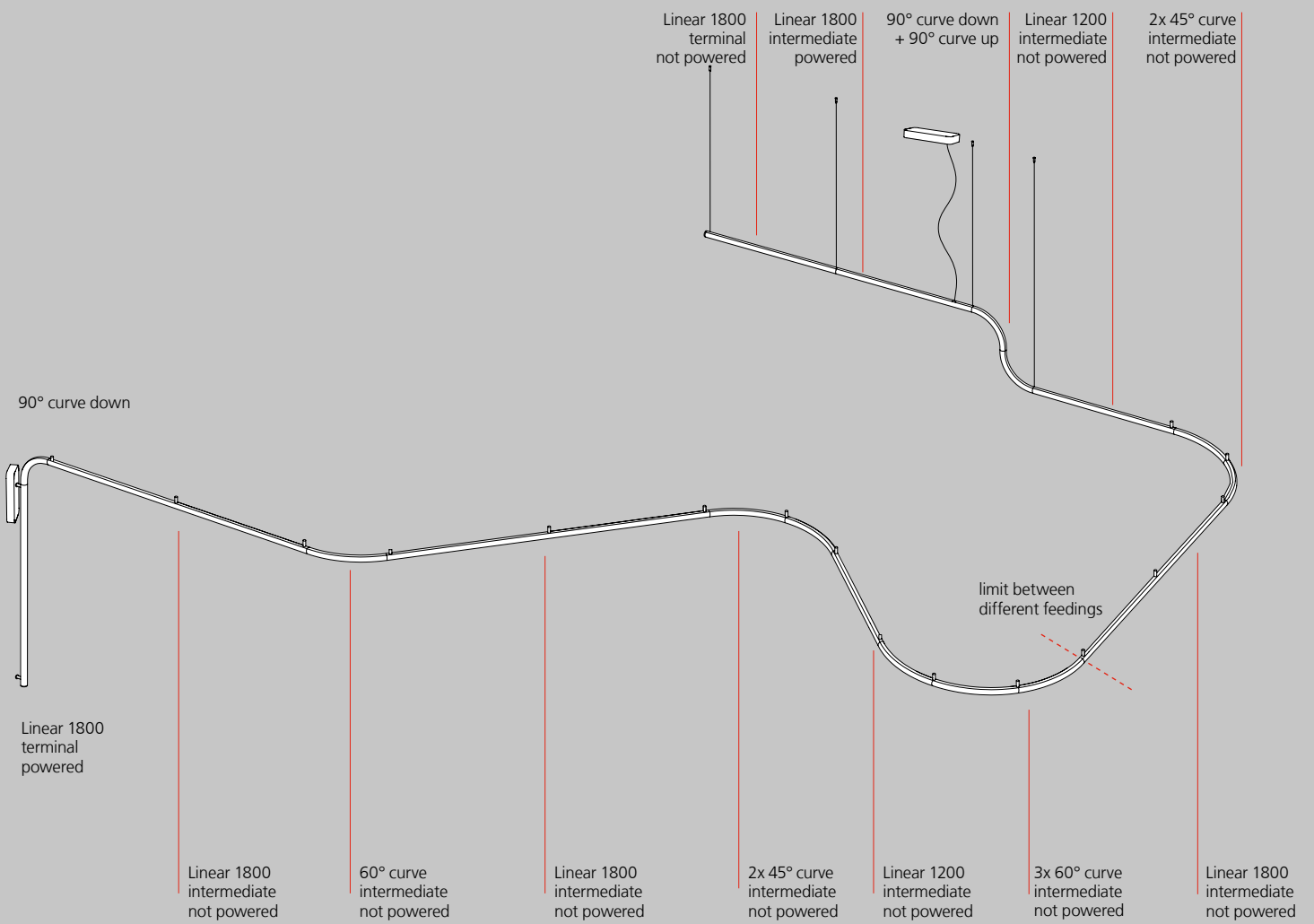

Alphabet of light system configuration

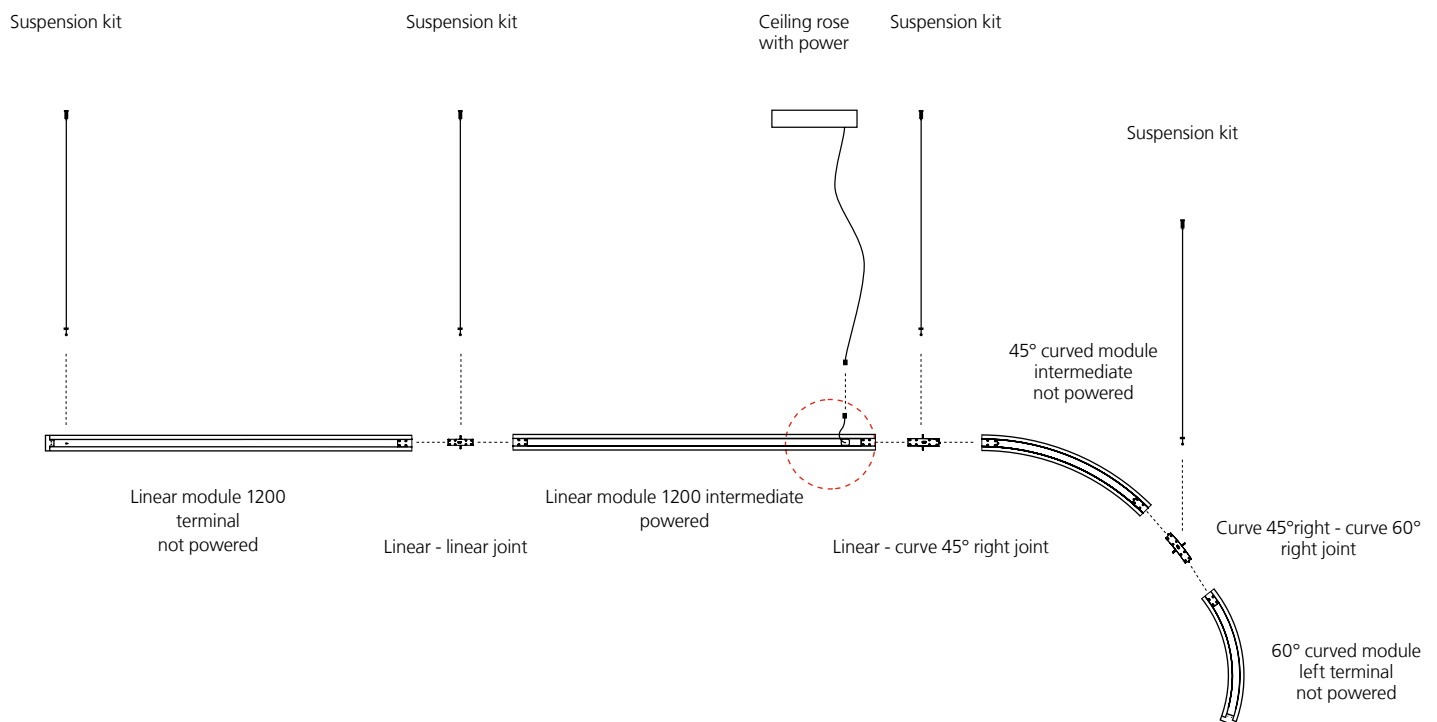

Materials: structure in anodized natural aluminum,
tube in white diffusing PMMA.

Linear module are available in three lengths: L 600 / 1200 / 1800 mm

Possibility to articulate the configuration on the horizontal plane with
45° and 60° curves and on the vertical plane with 90° curves.

Max 10 m for each power unit (10 m in one direction or X+Y=10 m in both directions).

Dali / 1-10 / Push or APP dimmable power units, recessed or ceiling mounted.

All modules powered by same power unit will use the same dimming.

Alphabet of light Configurator

Artemide provides tools to support the end customer and especially the lighting professionals in choosing the best lighting solution.

For an intuitive composition of the most complex systems, Artemide offers innovative and complete configurators on its website.

Alphabet of light system Configurator is a useful tool to simplify the design of your composition.

After defining the layout of the space, the desired system can be created by reconstructing it with a practical drag and drop of the various available modules. Once the project is completed, the system returns a complete datasheet with all the details to proceed with the order.

1. Build your space

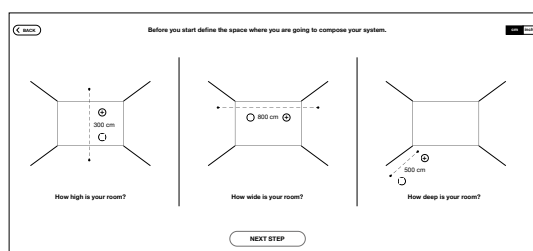

2. Drag and drop



3. Save it and send it!

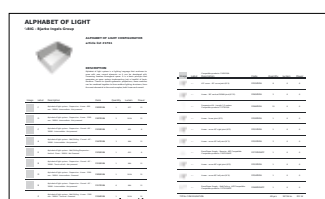



Suspension modules

→ LINEAR ELEMENTS

600 terminal (588 mm)

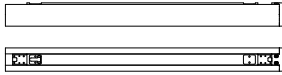

600 intermediate (588 mm)

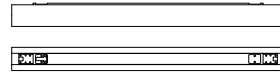

1200 terminal (1180 mm)

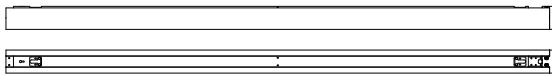

1200 intermediate (1180 mm)

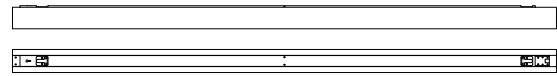

1800 terminal (1772 mm)

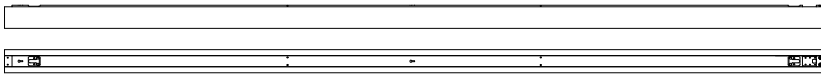

1800 intermediate (1772 mm)

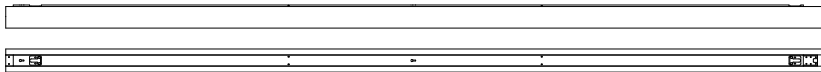

→ VERTICAL ELEMENTS*

90° Vertical UP

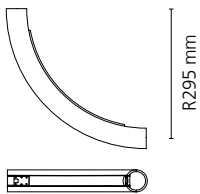

90° Vertical DOWN

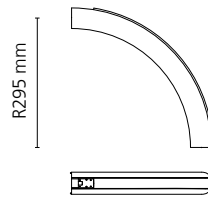

→ CONNECTION ELEMENTS*

X Joint

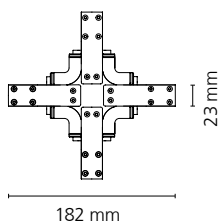

T Joint

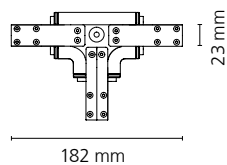

90° Joint

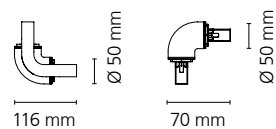

ALPHABET OF LIGHT - SYSTEM

Opal White



XF



*EDP compliance



EPDITALY0430
12/05/2023
www.epditaly.it

MacAdam 3SDCM
Life L70 (10K) 60000h
CRI =90

IP20



SUSPENSION LINEAR ELEMENTS

Length	W	V	Flux	CCT	Powered	Not powered
					Code	Code
600 terminal	11 W	24V	1133 lm	3000K	2100010AHE	2101010AHE
				3500K		
600 intermediate	11 W	24V	1133 lm	3000K	2100C10AHE	2101C10AHE
				3500K		
1200 terminal	21 W	24V	2267 lm	3000K	2104010AHE	2106010AHE
				3500K		
1200 intermediate	21 W	24V	2267 lm	3000K	2104C10AHE	2106C10AHE
				3500K		
1800 terminal	33 W	24V	3400 lm	3000K	2105010AHE	2107010AHE
				3500K		
1800 intermediate	33 W	24V	3400 lm	3000K	2105C10AHE	2107C10AHE
				3500K		
1800 terminal	33 W	24V	3400 lm	3000K	2108010AHE*	2110010AHE
				3500K		
1800 intermediate	33 W	24V	3400 lm	3000K	2108C10AHE	2110C10AHE
				3500K		
1800 terminal	33 W	24V	3400 lm	3000K	2109010AHE	2111010AHE
				3500K		
1800 intermediate	33 W	24V	3400 lm	3000K	2109C10AHE	2111C10AHE
				3500K		

VERTICAL ELEMENTS*

Length	W	V	Flux	CCT	Not powered
					Code
90° vertical UP	8 W	24V	750 lm	3000K	2124010AHE
				3500K	
90° vertical DOWN	8 W	24V	722 lm	3000K	2124C10AHE
				3500K	
90° vertical DOWN	8 W	24V	722 lm	3000K	2125010AHE
				3500K	
90° vertical DOWN	8 W	24V	722 lm	3000K	2125C10AHE
				3500K	

CONNECTION ELEMENTS*

	W	V	Flux	CCT	Not powered
					Code
X Joint	3 W	24V	253lm	3000K	2158010AHE*
				3500K	
T Joint	2,5 W	24V	211lm	3000K	2158C10AHE
				3500K	
90° Joint	1,5 W	24V	105lm	3000K	2156010AHE
				3500K	
90° Joint	1,5 W	24V	105lm	3000K	2156C10AHE
				3500K	
90° Joint	1,5 W	24V	105lm	3000K	2154010AHE*
				3500K	
90° Joint	1,5 W	24V	105lm	3000K	2154C10AHE
				3500K	

* Vertical elements and connection elements can only be combined with linear elements.

Suspension modules

→ CURVED ELEMENTS

22,5° terminal right

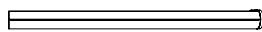

22,5° terminal left

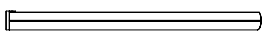

22,5° intermediate

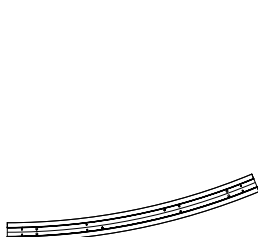
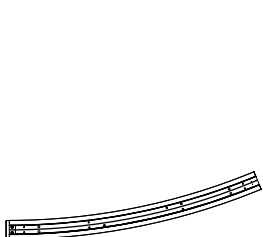
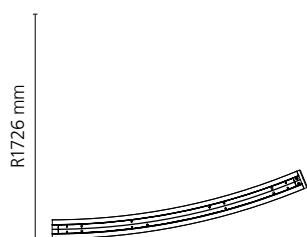
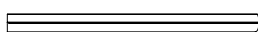

45° terminal right



45° terminal left



45° intermediate

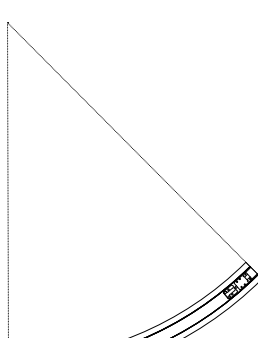
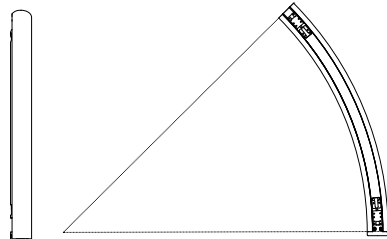
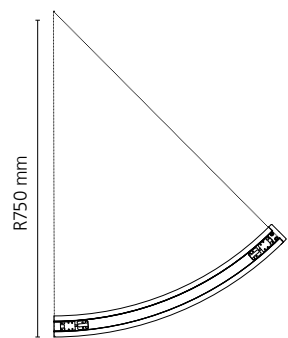

60° terminal right



60° terminal left



60° intermediate

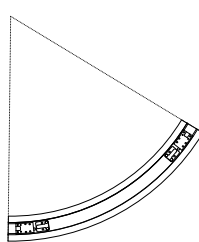
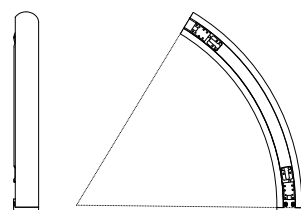
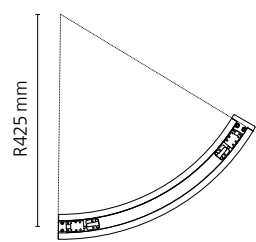

ALPHABET OF LIGHT - SYSTEM

Opal White



XF



*EDP compliance



EPDITALY0430
12/05/2023
www.epditaly.it

MacAdam 3SDCM
Life L70 (10K) 60000h
CRI =90

IP20



SUSPENSION CURVED ELEMENTS

Length	W	V	Flux	CCT	Powered	Not powered
					Code	Code
22,5° terminal left	11 W	24V	1118 lm	3000K	2602010AHE	2605010AHE
				3500K	2602C10AHE	2605C10AHE
22,5° terminal right	11 W	24V	1118 lm	3000K	2601010AHE	2604010AHE
				3500K	2601C10AHE	2604C10AHE
22,5° intermediate	11 W	24V	1118 lm	3000K	2600010AHE	2603010AHE
				3500K	2600C10AHE	2603C10AHE
45° terminal left	11 W	24V	1118 lm	3000K	2112010AHE	2115010AHE
				3500K	2112C10AHE	2115C10AHE
45° terminal right	11 W	24V	1118 lm	3000K	2113010AHE*	2116010AHE
				3500K	2113C10AHE	2116C10AHE
45° intermediate	11 W	24V	1118 lm	3000K	2114010AHE	2117010AHE
				3500K	2114C10AHE	2117C10AHE
60° terminal left	8 W	24V	815 lm	3000K	2118010AHE	2121010AHE
				3500K	2118C10AHE	2121C10AHE
60° terminal right	8 W	24V	815 lm	3000K	2119010AHE	2122010AHE
				3500K	2119C10AHE	2122C10AHE
60° intermediate	8 W	24V	815 lm	3000K	2120010AHE	2123010AHE
				3500K	2120C10AHE	2123C10AHE

Suspension accessories

	Code
Suspension kit L=1,50m	2266010A
Suspension kit L=4,00m	2273010A
*extension feeding cable L=1,25m	2274010A
*extension feeding cable L=2,50m	2275010A

*The total maximum length of the feeding cable is 4,00 m (either for ceiling mounted or remote power units).
Overpassing this value could affect uniformity of light emission.

Suspension Power Units

	Code
Dali / Push ceiling power unit (175W, 220-240VAC, L=306, W=140, H=44)	2267010A*
APP ceiling power unit (175W, 220-240VAC, L=306, W=140, H=44)	2267010APP*
Dali / Push remote power unit box (175W, 220-240VAC, L=306, W=140, H=44)	2272010A
APP remote power unit box (175W, 220-240VAC, L=306, W=140, H=44)	2272010APP



Ø 160

Optional control devices - BLL wireless switch



Device for switching and controlling Artemide App products.
Max N.3 inputs for external push buttons.
Max 1 m distance.
Mains power supply required.
To be installed inside flush mounting boxes or junction boxes.

Code
DV1080APP

Wall/ceiling modules

→ LINEAR ELEMENTS

600 terminal (588 mm)

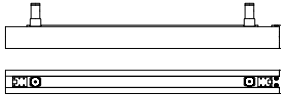

600 intermediate (588 mm)

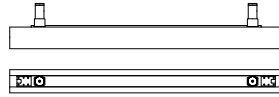

1200 terminal (1180 mm)

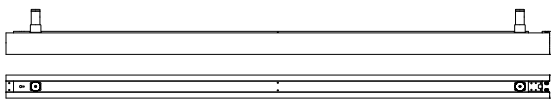

1200 intermediate (1180 mm)

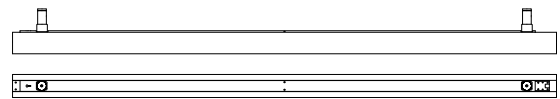

1800 terminal (1772 mm)

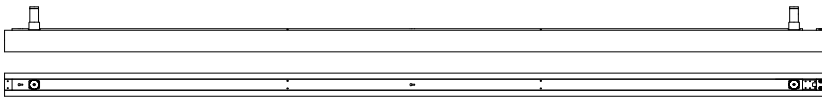

1800 intermediate (1772 mm)

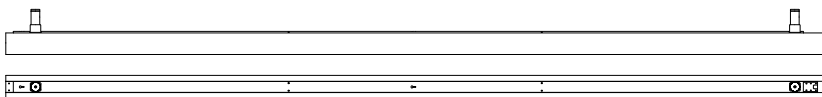

→ VERTICAL ELEMENTS

90° Vertical UP

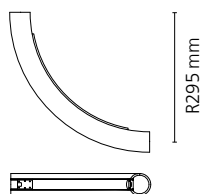

90° Vertical DOWN

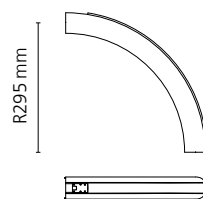

→ CONNECTION ELEMENTS*

X Joint

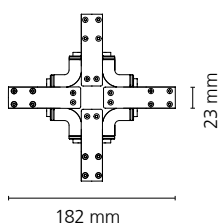

T Joint

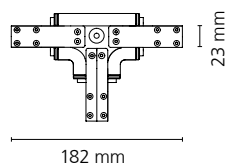

90° Joint

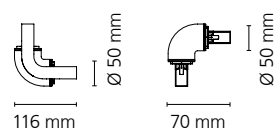

ALPHABET OF LIGHT - SYSTEM

Opal White



XF



*EDP compliance



EPDITALY0430
12/05/2023
www.epditaly.it

MacAdam 3SDCM
Life L70 (10K) 60000h
CRI =90

IP20



WALL/CEILING LINEAR ELEMENTS

Length	W	V	Flux	CCT	Powered	Semi-recessed powered	Not powered
					Code	Code	Code
600 terminal	11 W	24V	1133 lm	3000K	2130010AHE	2160010AHE	2131010AHE
				3500K	2130C10AHE	2160C10AHE	2131C10AHE
600 intermediate	11 W	24V	1133 lm	3000K			2132010AHE
				3500K			2132C10AHE
1200 terminal	21 W	24V	2267 lm	3000K	2134010AHE	2161010AHE	2136010AHE
				3500K	2134C10AHE	2161C10AHE	2136C10AHE
1200 intermediate	21 W	24V	2267 lm	3000K	2135010AHE*	2162010AHE	2137010AHE
				3500K	2135C10AHE	2162C10AHE	2137C10AHE
1800 terminal	33 W	24V	3400 lm	3000K	2138010AHE	2163010AHE	2140010AHE
				3500K	2138C10AHE	2163C10AHE	2140C10AHE
1800 intermediate	33 W	24V	3400 lm	3000K	2139010AHE	2164010AHE	2141010AHE
				3500K	2139C10AHE	2164C10AHE	2141C10AHE

VERTICAL ELEMENTS

Length	W	V	Flux	CCT	Not powered
					Code
90° vertical UP	8 W	24V	750 lm	3000K	2124010AHE
				3500K	2124C10AHE
90° vertical DOWN	8 W	24V	722 lm	3000K	2125010AHE
				3500K	2125C10AHE

WALL/CEILING LINEAR JOINT

	W	V	Flux	CCT	Not powered
					Code
X Joint	3 W	24V	253lm	3000K	2159010AHE
				3500K	2159C10AHE
T Joint	2,5 W	24V	211lm	3000K	2157010AHE
				3500K	2157C10AHE
90° Joint	1,5 W	24V	105lm	3000K	2155010AHE
				3500K	2155C10AHE

* Vertical elements and connection elements can only be combined with linear elements.

Wall/ceiling modules

→ CURVED ELEMENTS

22,5° terminal right

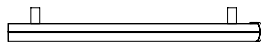

22,5° terminal left

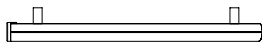

22,5° intermediate

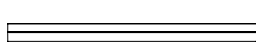

R1725 mm



45° terminal right



45° terminal left



45° intermediate



R750 mm

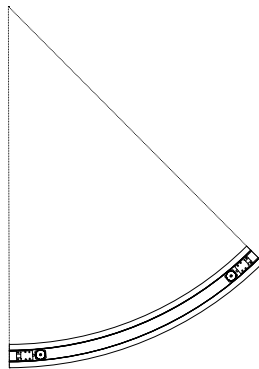
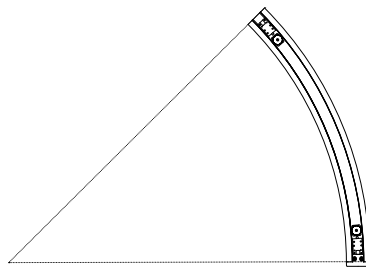
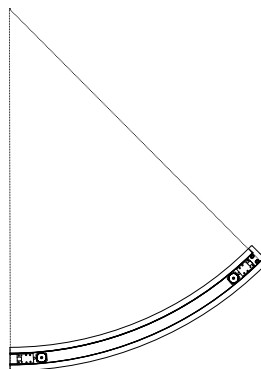

60° terminal right

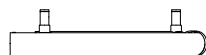

60° terminal left

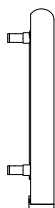

60° intermediate



R425 mm

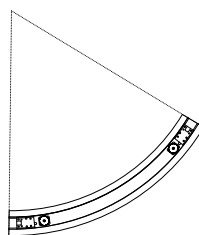
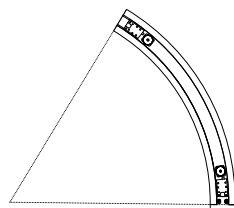
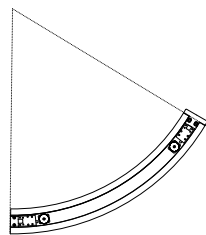

ALPHABET OF LIGHT - SYSTEM

Opal White



XF



MacAdam 3SDCM
Life L70 (10K) 60000h
CRI =90

IP20
⊕

WALL/CEILING CURVED ELEMENTS

Length	W	V	Flux	CCT	Powered	Semi-recessed powered	Not powered
					Code	Code	Code
22,5° terminal left	11 W	24V	1118 lm	3000K	2608010AHE	2627010AHE	2611010AHE
				3500K	2608C10AHE	2627C10AHE	2611C10AHE
22,5° terminal right	11 W	24V	1118 lm	3000K	2607010AHE	2626010AHE	2610010AHE
				3500K	2607C10AHE	2626C10AHE	2610C10AHE
22,5° intermediate	11 W	24V	1118 lm	3000K	2606010AHE	2625010AHE	2609010AHE
				3500K	2606C10AHE	2625C10AHE	2609C10AHE
45° terminal left	11 W	24V	1118 lm	3000K	2142010AHE	2165010AHE	2145010AHE
				3500K	2142C10AHE	2165C10AHE	2145C10AHE
45° terminal right	11 W	24V	1118 lm	3000K	2143010AHE	2166010AHE	2146010AHE
				3500K	2143C10AHE	2166C10AHE	2146C10AHE
45° intermediate	11 W	24V	1118 lm	3000K	2144010AHE	2167010AHE	2147010AHE
				3500K	2144C10AHE	2167C10AHE	2147C10AHE
60° terminal left	8 W	24V	815 lm	3000K	2148010AHE	2168010AHE	2151010AHE
				3500K	2148C10AHE	2168C10AHE	2151C10AHE
60° terminal right	8 W	24V	815 lm	3000K	2149010AHE	2169010AHE	2152010AHE
				3500K	2149C10AHE	2169C10AHE	2152C10AHE
60° intermediate	8 W	24V	815 lm	3000K	2150010AHE	2170010AHE	2153010AHE
				3500K	2150C10AHE	2170C10AHE	2153C10AHE

Wall/Ceiling Power Units

Dali / Push ceiling power unit (175W, 220-240VAC, L=306, W=140, H=44)

APP ceiling power unit (175W, 220-240VAC, L=306, W=140, H=44)

Dali / Push remote power unit box (175W, 220-240VAC, L=306, W=140, H=44)

APP remote power unit box (175W, 220-240VAC, L=306, W=140, H=44)

Code

2268010A

2268010APP

2271010A

2271010APP



Ø 160

Optional control devices - BLL wireless switch



Device for switching and controlling Artemide App products.

Max N.3 inputs for external push buttons.

Max 1 m distance.

Mains power supply required.

To be installed inside flush mounting boxes or junction boxes.

Code

DV1080APP

Joints

Zogenix, Emeryville, USA, ph. Emily Haopohan | 2020



ALPHABET OF LIGHT - SYSTEM

Opal White



XF



*EDP compliance



EPDITALY0430
12/05/2023
www.epditaly.it

MacAdam 3SDCM
Life L80 (12K) 72000h
CRI =80

IP20



JOINTS

Accessories		
Joint		Code
01	→ Linear - linear joint ← Linear - linear joint	2250010A*
02	→ Linear - curve 45° right joint ← Curve 45° left - linear joint	2251010A
03	→ Linear - curve 45° left joint ← Curve 45° right - linear joint	2252010A
04a	→ 45° curve right - 45° curve right joint ← 45° curve left - 45° curve left joint	2255010A
04b	→ 45° curve left - 45° curve left joint ← 45° curve right - 45° curve right joint	
05	→ Linear - curve 60° right joint ← 60° curve left - linear joint	2253010A
06	→ Linear - curve 60° left joint ← 60° curve right - linear joint	2254010A
07a	→ 60° curve right - 60° curve right joint ← 60° curve left - 60° curve left joint	2256010A
07b	→ 60° curve left - 60° curve left joint ← 60° curve right - 60° curve right joint	
08	→ 60° curve right - 45° curve left joint ← 45° curve right - 60° curve left joint	2257010A
09	→ 45° curve left - 45° curve right joint ← 45° curve left - 45° curve right joint	2260010A
10	→ 60° curve right - 60° curve left joint ← 60° curve right - 60° curve left joint	2259010A
11	→ 60° curve right - 45° curve right joint ← 45° curve left - 60° curve left joint	2261010A
12	→ 60° curve left - 45° curve left joint ← 45° curve right - 60° curve right joint	2262010A
13	→ 90° down - 90° up joint ← 90° up - 90° down joint	2263010A
14	→ Linear - 90° vertical up joint ← 90° vertical up joint - linear joint	2264010A
15	→ Linear - 90° vertical down joint ← 90° vertical down - linear joint	2265010A
16	→ 60° curve left - 45° curve right joint ← 45° curve left - 60° curve right joint	2258010A
17	→ 45° curve right - 45° curve left joint ← 45° curve right - 45° curve left joint	2269010A
18	→ 60° curve left - 60° curve right joint ← 60° curve right - 60° curve left joint	2270010A
19	→ 22° curve right - 22° curve right joint ← 22° curve left - 22° curve left joint	2612010A
20	→ Linear - curve 22° right joint ← Curve 22° left - linear joint	2613010A
21	→ Linear - curve 22° left joint ← Curve 22° right - linear joint	2614010A
22	→ 22° curve right - 22° curve left joint	2615010A
23	→ 22° curve right - 60° curve right joint ← 60° curve left - 22° curve left joint	2616010A
24	→ 22° curve right - 60° curve left joint ← 60° curve left - 22° curve right joint	2617010A
25	→ 22° curve right - 45° curve right joint ← 45° curve left - 22° curve left joint	2618010A
26	→ 22° curve right - 45° curve left joint ← 45° curve left - 22° curve right joint	2619010A
27	→ 22° curve left - 60° curve right joint ← 60° curve right - 22° curve left joint	2620010A
28	→ 22° curve left - 60° curve left joint ← 60° curve left - 22° curve left joint	2621010A
29	→ 22° curve left - 45° curve right joint ← 45° curve right - 22° curve left joint	2622010A
30	→ 22° curve left - 45° curve left joint ← 45° curve left - 22° curve left joint	2623010A
31	← 22° curve left - 22° curve right joint	2624010A

→ left to right path
← right to left path

→ left to right path
 ← right to left path

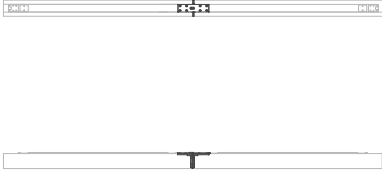

Code 2250010A_**JOINT 01**
 → LINEAR - LINEAR JOINT
 ← LINEAR - LINEAR JOINT

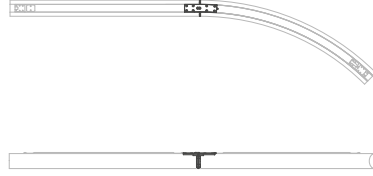

Code 2251010A_**JOINT 02**
 → LINEAR - CURVE 45° RIGHT JOINT
 ← CURVE 45° LEFT - LINEAR JOINT

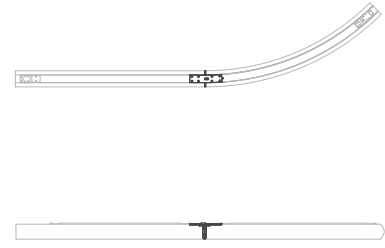

Code 2252010A_**JOINT 03**
 → LINEAR - CURVE 45° LEFT JOINT
 ← CURVE 45° RIGHT - LINEAR JOINT

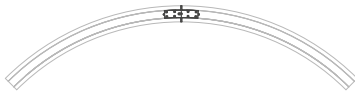

Code 2255010A_**JOINT 04a**
 → 45° CURVE RIGHT - 45° CURVE RIGHT JOINT
 ← 45° CURVE LEFT - 45° CURVE LEFT JOINT

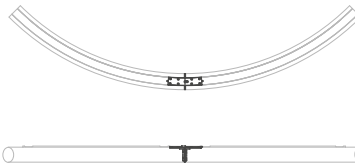

Code 2255010A_**JOINT 04b**
 → 45° CURVE LEFT - 45° CURVE LEFT JOINT
 ← 45° CURVE RIGHT - 45° CURVE RIGHT JOINT

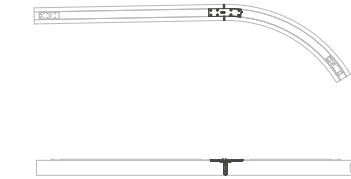

Code 2253010A_**JOINT 05**
 → LINEAR - CURVE 60° RIGHT JOINT
 ← 60° CURVE LEFT - LINEAR JOINT RIGHT

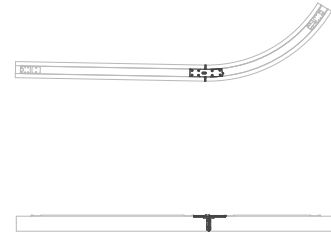

Code 2254010A_**JOINT 06**
 → LINEAR - CURVE 60° LEFT JOINT
 ← 60° CURVE RIGHT - LINEAR JOINT

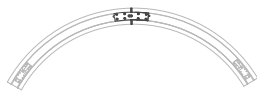

Code 2256010A_**JOINT 07a**
 → 60° CURVE RIGHT - 60° CURVE RIGHT JOINT
 ← 60° CURVE LEFT - 60° CURVE LEFT JOINT

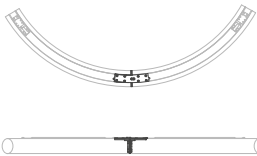

Code 2256010A_**JOINT 07b**
 → 60° CURVE LEFT - 60° CURVE LEFT JOINT
 ← 60° CURVE RIGHT - 60° CURVE RIGHT JOINT

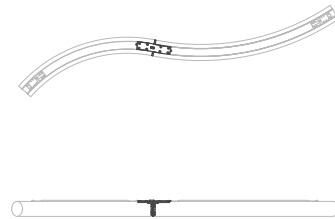

Code 2257010A_**JOINT 08**
 → 60° CURVE RIGHT - 45° CURVE LEFT JOINT
 ← 45° CURVE RIGHT - 60° CURVE LEFT JOINT

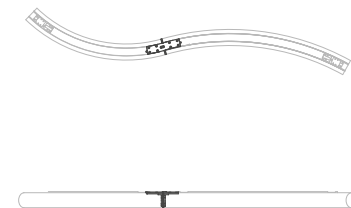

Code 2258010A_**JOINT 16**
 → 60° CURVE LEFT - 45° CURVE RIGHT JOINT
 ← 45° CURVE LEFT - 60° CURVE RIGHT JOINT

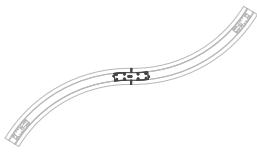

Code 2259010A **JOINT 10**
 → 60° CURVE RIGHT - 60° CURVE LEFT JOINT
 ← 60° CURVE RIGHT - 60° CURVE LEFT JOINT

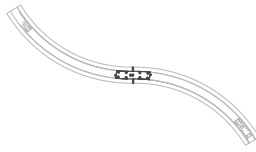

Code 2270010A **JOINT 18**
 → 60° CURVE LEFT - 60° CURVE RIGHT JOINT
 ← 60° CURVE LEFT - 60° CURVE RIGHT JOINT



Code 2261010A **JOINT 11**
 → 60° CURVE RIGHT - 45° CURVE RIGHT JOINT
 ← 45° CURVE LEFT - 60° CURVE LEFT JOINT



Code 2262010A **JOINT 12**
 → 60° CURVE LEFT - 45° CURVE LEFT JOINT
 ← 45° CURVE RIGHT - 60° CURVE RIGHT JOINT

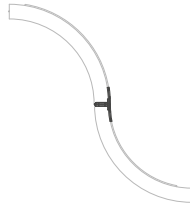

Code 2263010A **JOINT 13**
 → 90° VERTICAL DOWN - 90° VERTICAL UP JOINT
 ← 90° VERTICAL UP - 90° VERTICAL DOWN JOINT



Code 2264010A **JOINT 14**
 → LINEAR - 90° VERTICAL UP JOINT
 ← 90° VERTICAL UP - LINEAR JOINT



Code 2265010A **JOINT 15**
 → LINEAR - 90° VERTICAL DOWN JOINT
 ← 90° VERTICAL DOWN - LINEAR JOINT

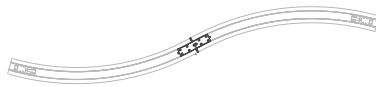

Code 2260010A **JOINT 09**
 → 45° CURVE LEFT - 45° CURVE RIGHT JOINT
 ← 45° CURVE LEFT - 45° CURVE RIGHT JOINT

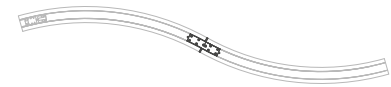

Code 2269010A **JOINT 17**
 → 45° CURVE RIGHT - 45° CURVE LEFT JOINT
 ← 45° CURVE RIGHT - 45° CURVE LEFT JOINT

→ left to right path
 ← right to left path

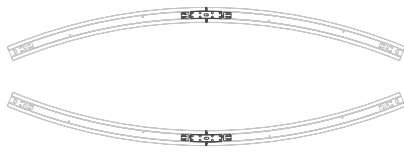

Code 2612010A_**JOINT 19**
 → 22° CURVE RIGHT - CURVE RIGHT JOINT
 ← 22° CURVE LEFT - CURVE RIGHT JOINT



Code 2613010A_**JOINT 20**
 → LINEAR - 22° CURVE RIGHT JOINT
 ← 22° CURVE LEFT - LINEAR JOINT



Code 2614010A_**JOINT 21**
 → LINEAR - 22° CURVE LEFT JOINT
 ← 22° CURVE RIGHT - LINEAR JOINT

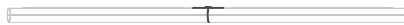

Code 2615010A_**JOINT 22**
 → 22° CURVE RIGHT - 22° CURVE LEFT JOINT



Code 2616010A_**JOINT 23**
 → 22° CURVE RIGHT - 60° CURVE RIGHT JOINT
 ← 60° CURVE LEFT - 22° CURVE RIGHT JOINT



Code 2617010A_**JOINT 24**
 → 22° CURVE RIGHT - 60° CURVE LEFT JOINT
 ← 60° CURVE LEFT - 22° CURVE RIGHT JOINT



Code 2618010A_**JOINT 25**
 → 22° CURVE RIGHT - 45° CURVE RIGHT JOINT
 ← 45° CURVE LEFT - 22° CURVE LEFT JOINT



Code 2619010A_**JOINT 26**
 → 22° CURVE RIGHT - 45° CURVE LEFT JOINT
 ← 45° CURVE LEFT - 22° CURVE RIGHT JOINT



Code 2620010A_**JOINT 27**
 → 22° CURVE LEFT - 60° CURVE RIGHT JOINT
 ← 60° CURVE RIGHT - 22° CURVE LEFT JOINT

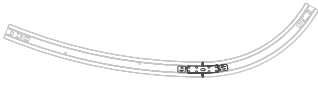

Code 2621010A_**JOINT 28**
→ 22° CURVE LEFT - 60° CURVE LEFT JOINT
← 60° CURVE LEFT - 22° CURVE LEFT JOINT

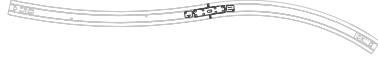

Code 2622010A_**JOINT 29**
→ 22° CURVE LEFT - 45° CURVE RIGHT JOINT
← 45° CURVE RIGHT - 22° CURVE LEFT JOINT

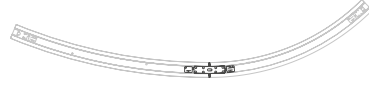

Code 2623010A_**JOINT 30**
→ 22° CURVE LEFT - 45° CURVE LEFT JOINT
← 45° CURVE LEFT - 22° CURVE LEFT JOINT



Code 2624010A_**JOINT 31**
← 22° CURVE LEFT - 22° CURVE RIGHT JOINT









Gople system

BIG - Bjarke Ingles Group
2020

Gople system combines with the Alphabet of light system, creating a universal lighting able to meet the requirements of any space, but above all to define a new approach to lighting projects.

This is an increasingly universal language that diversifies its performance and expands the freedom to illuminate every angle.

Gople spot adds accent lights to break up the diffused light of Alphabet of light. Light thus follows spaces and activities not just by tracing geometries that move fluidly in three directions, but also through an alternation of light and shadow, the choice of light emissions that are diversified and specialised.

Alphabet of light is a versatile, multi-use project, perfect for illuminating any space, which in combination with Gople system opens up new fields of application and increasingly becomes the ideal tool for retail spaces.

Gople spot offers efficient performance, excellent colour rendering and numerous variables in terms of emission qualities such as colour temperature and beam angles, which make it a professional, technical product.



**Artemide
App**



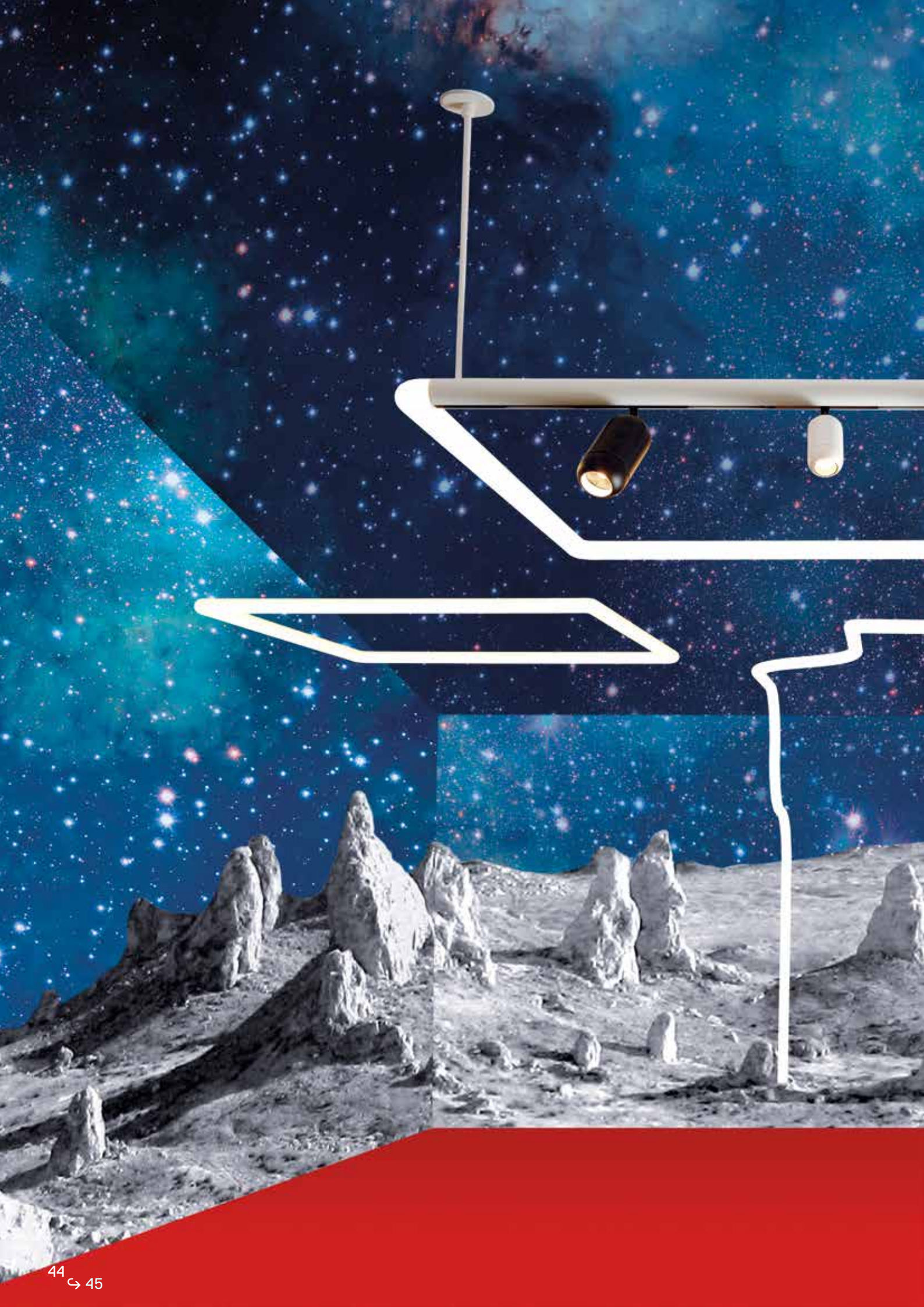



"The new Gople system follows the success of our original Gople pendant lamps, extending the language of Alphabet of light into new architectural typologies."

BIG

Complete system

Gople system is designed to allow double emission: it can have a track for direct spot emission and a diffused indirect light.

The different typology of Gople system modules can be combined with the maximum freedom.

The same diameter of Alphabet of light and Gople system allows to combine the two systems with mechanical continuity.



ALPHABET OF LIGHT

24V

GOPLE SYSTEM
TRACK

48V

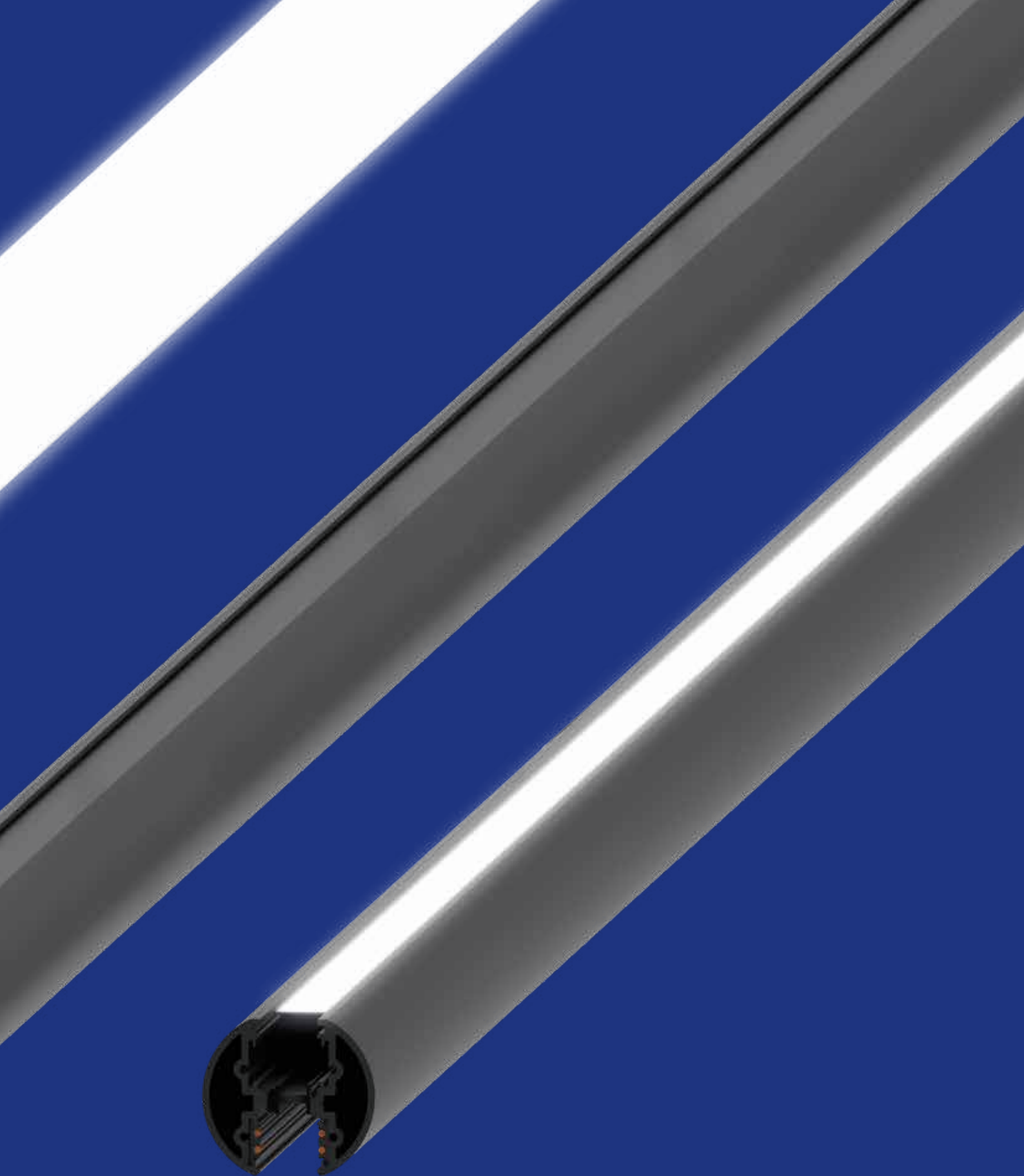

GOPLE SYSTEM
TRACK + INDIRECT EMISSION

48V

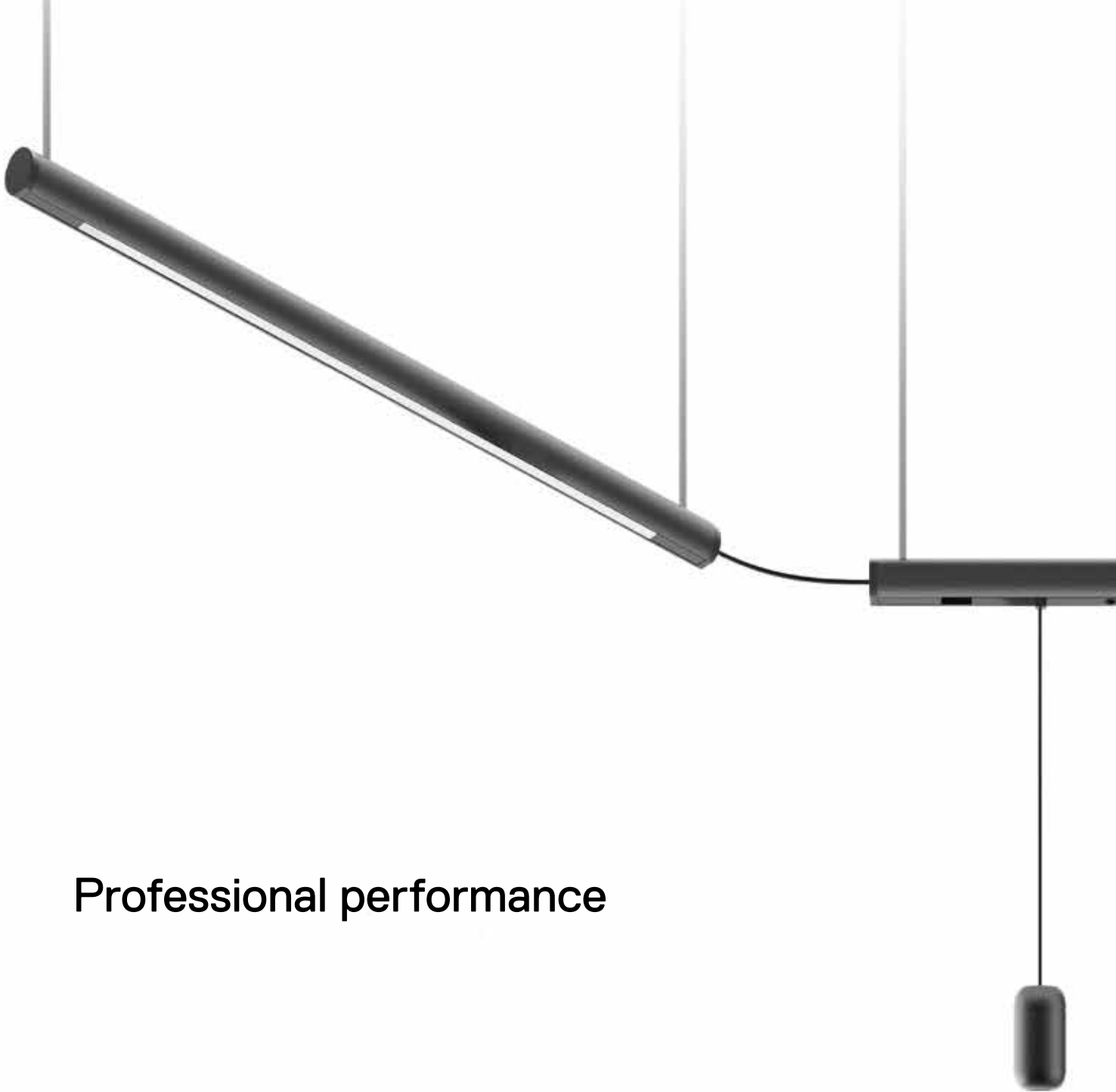

Professional performance

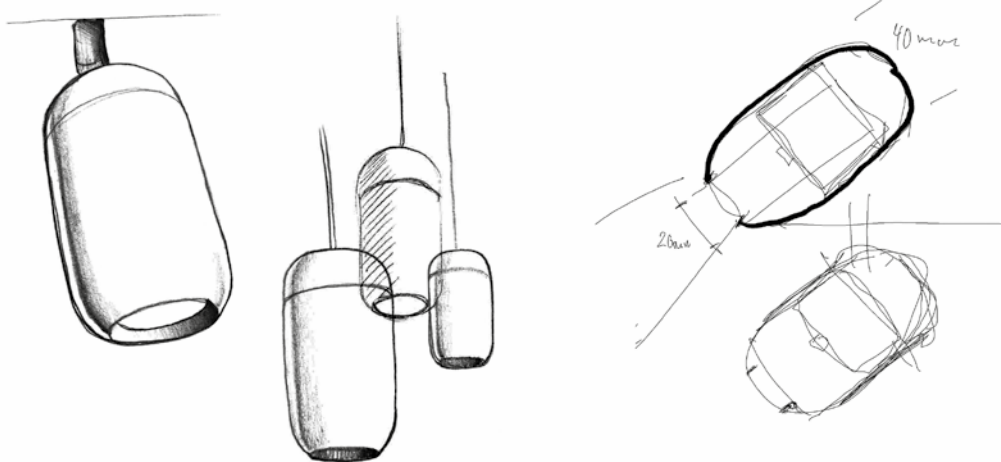



Gople spot offers highly professional performance within the soft geometries that remind in reduced-scale the iconic Gople diffuser.

The spotlight comes in two sizes, corresponding to different power and flux levels, each with multiple beam angles.

Artemide's expertise in managing the different qualities of light is also expressed in the ability to personalise light emissions with custom solutions, selecting the parameters of colour rendering (Gamut index and Fidelity Index) and spectrum quality dedicated to specific display situations.





Gople spot



GOPLE SPOT 60



S 14°	F 21°	WF 28°
9W	9W	9W
557 lm*	598 lm*	542 lm*



GOPLE SPOT 80



S 15°	F 22°	WF 31°
23W	23W	23W
1767 lm*	1786 lm*	1854 lm*



GOPLE SPOT PENDANT 60



S 14°	F 21°	WF 28°
9W	9W	9W
557 lm*	598 lm*	542 lm*



GOPLE SPOT PENDANT 80



S 15°	F 22°	WF 31°
23W	23W	23W
1767 lm*	1786 lm*	1854 lm*

* 3000 K Values.



Gople system
Direct Spot

90° Joint **Alphabet of light**
Linear Module

Gople system
Direct Spot + Indirect Diffused

Alphabet of light
45° Curved Module

Alphabet of light
Linear Module

Gople system
Direct Spot + Indirect Diffused

Gople system
Direct Spot + Indirect Diffused

Gople system
Direct Spot + Indirect Diffused

Alphabet of light
Linear Module

Alphabet of light
Linear Module

Gople system
Direct Spot

Gople system
Direct Spot

Alphabet of light
60° Curved Module

Alphabet of light
Linear Module

Gople system
Direct Spot + Indirect Diffused

Alphabet of light
90° Vertical Module

Gople system
Direct Spot

90° Joint **Alphabet of light**
Linear Module

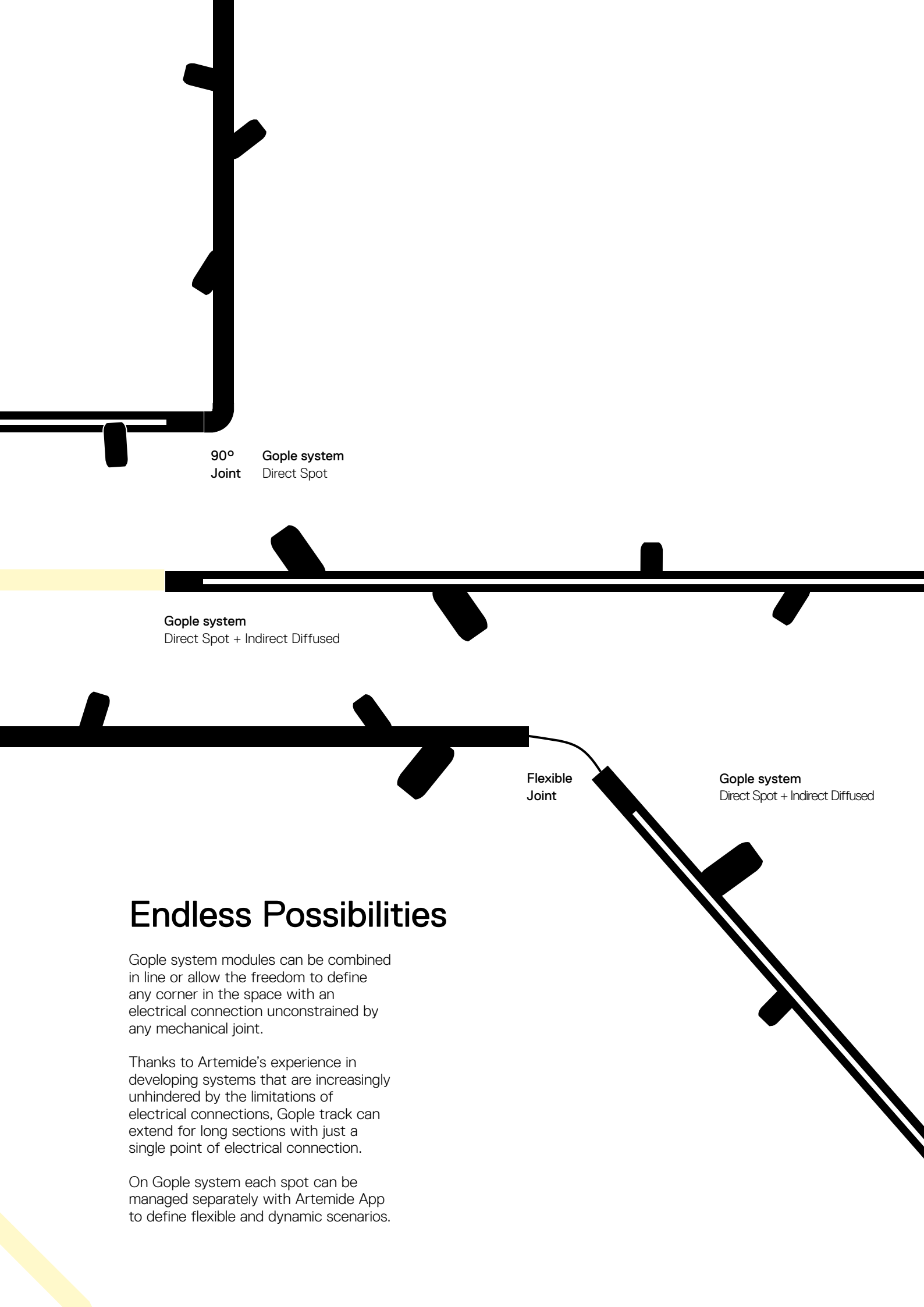

90° Joint
Gople system
Direct Spot

Gople system
Direct Spot + Indirect Diffused

Flexible Joint
Gople system
Direct Spot + Indirect Diffused

Endless Possibilities

Gople system modules can be combined in line or allow the freedom to define any corner in the space with an electrical connection unconstrained by any mechanical joint.

Thanks to Artemide's experience in developing systems that are increasingly unhindered by the limitations of electrical connections, Gople track can extend for long sections with just a single point of electrical connection.

On Gople system each spot can be managed separately with Artemide App to define flexible and dynamic scenarios.

GOPLE SYSTEM - ELEMENTS

White

Black

XF



01

04

MacAdam 2SDCM
Life L70 (20K) 116750h
CRI =80

IP20



→ LINEAR ELEMENTS

Direct Track 1180 mm

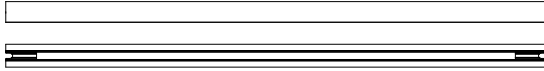

Direct Track 1772 mm

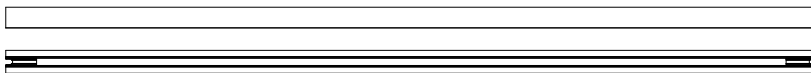

Direct Track + Indirect Emission 1180 mm

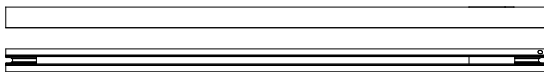

Direct Track + Indirect Emission 1772 mm

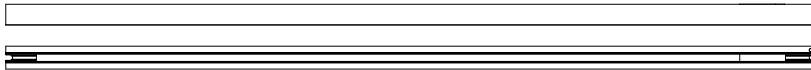

LINEAR DIRECT TRACK ELEMENTS

Suspension/Ceiling

Length	V
1180 mm	48V
1772 mm	48V

Code
CB003. 01/04
CB004. 01/04



LINEAR DIRECT TRACK + INDIRECT LIGHT ELEMENTS

Suspension

Length	W	V	Flux	CCT
1180 mm	16W indirect	48V	1420 lm indirect	3000 K
1772 mm	32W indirect	48V	2840 lm indirect	3000 K

Code
CB006. 01/04
CB007. 01/04

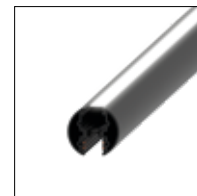

GOPLE SYSTEM - POWER SUPPLY KIT

White Black



01





04

The APP driver can not be controlled by DALI dimming system and viceversa.



IP20



CEILING

Power supply kit	ND	DALI/PUSH/0-10	Artemide App
	Code	Code	Code
 Ceiling Power supply kit (ND / DALI / PUSH / 0-10/ APP) 150W 400x110x49H	CB500. 01/04	CB501. 01/04	CB502. 01/04
 Ceiling Power supply kit (ND / DALI / PUSH / 0-10/ APP) 240W 400x110x49H	CB503. 01/04	CB504. 01/04	CB505. 01/04

RECESSED

Power supply kit	ND	DALI/PUSH/0-10	Artemide App
	Code	Code	Code
 Recessed Power supply kit (ND / DALI / PUSH / 0-10/ APP) 150W 396x178x108H	CB60001	CB60101	CB60201
 Recessed Power supply kit (ND / DALI / PUSH / 0-10/ APP) 240W 396x178x108H	CB60301	CB60401	CB60501
 Recessed Power supply kit (ND / DALI / PUSH / 0-10/ APP) 320W 396x178x108H	CB60601	CB60701	CB60801

REMOTE

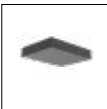
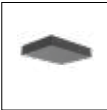
Power supply kit	DALI/PUSH/0-10	Artemide App
	Code	Code
 Remote power supply kit (DALI / PUSH / 0-10/APP) 240W 313x243x57,5H	CB70001	CB70101
 Remote power supply kit (DALI / PUSH / 0-10/APP) 320W 313x243x57,5H	CB70201	CB70301

Optional control devices - BLL wireless switch

	Code
 Device for switching and controlling Artemide App products. Max N.3 inputs for external push buttons. Max 1 m distance. Mains power supply required. To be installed inside flush mounting boxes or junction boxes.	DV1080APP

Gople system configuration

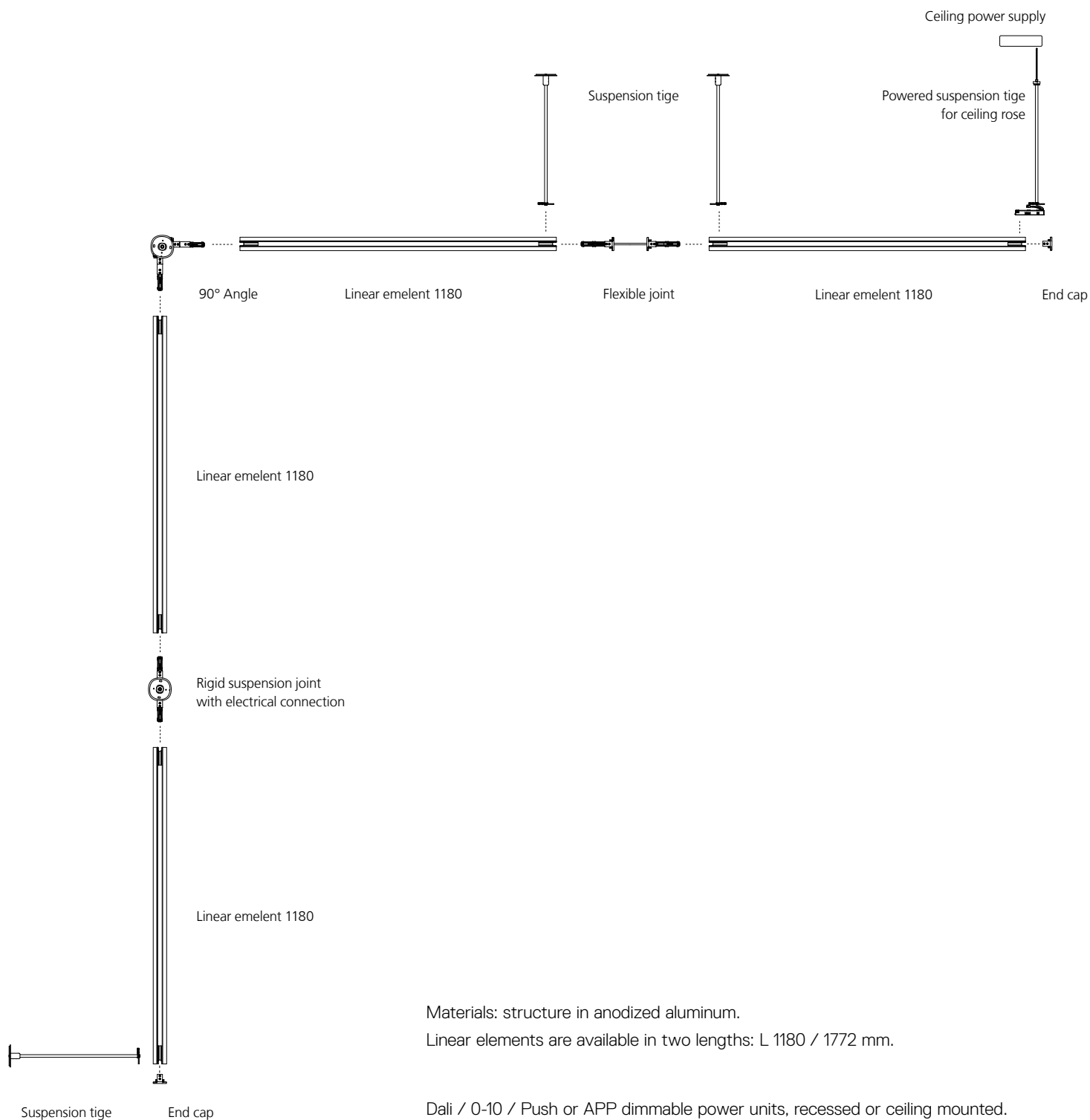

GOPLE SYSTEM - ACCESSORIES

White Black





01





04



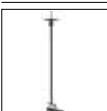
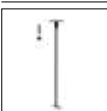

Suspension / Ceiling accessories

	Code
 <p>End cap</p>	CB300. 04
 <p>Flexible joint</p>	CB207. 04
 <p>Rigid suspension/ceiling joint with electrical connection</p>	CB208. 01/04

Suspension accessories

	Code
 <p>Powered suspension tige for ceiling rose (L=470mm)</p>	CB100. 01/04
 <p>Powered suspension tige / ceiling mounted for recessed and remote rose (L=500mm)</p>	CB102. 01/04
 <p>Suspension/ceiling tige</p>	CB103. 01/04
 <p>Powered suspension rigid joint for ceiling rose</p>	CB209. 01/04
 <p>Powered suspension rigid joint for recessed and remote rose</p>	CB212. 01/04

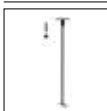
Ceiling accessories

	Code
 <p>Ceiling tige with powered head</p>	CB101. 01/04
 <p>Powered ceiling tige / ceiling mounted for recessed and remote rose</p>	CB112. 01/04
 <p>Suspension/ceiling tige</p>	CB103. 01/04
 <p>Ceiling rigid joint with powered head</p>	CB211. 01/04
 <p>Powered ceiling rigid joint for recessed and remote rose</p>	CB213. 01/04

GOPLE SYSTEM - 90° ANGLE

White Black



01



04

IP20
⊕

SUSPENSION / CEILING JOINT

90° Angle with electrical connection

Code

CB400. 01/04

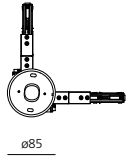

546

ø50

75

108

GOPLE SYSTEM + ALPHABET OF LIGHT 90° ANGLE

SUSPENSION / CEILING JOINT

90° Left Angle

(with rigid tige for suspension version and rigid tige for ceiling version)

Code

CB401. 01/04

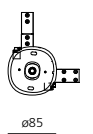

136

ø85

546

ø50

75

117

GOPLE SYSTEM + ALPHABET OF LIGHT 90° ANGLE

SUSPENSION / CEILING JOINT

90° Right Angle

(with rigid tige for suspension version and rigid tige for ceiling version)

Code

CB402. 01/04

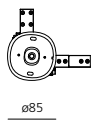

117

ø85

546

ø50

75

136



Gople spots



GOPLE SYSTEM - SPOT TRACK

White Black



01



04

S F WF



Delivery time on demand
2700K - 4000K

MacAdam 3SDCM
*MacAdam 2SDCM
CRI = 90

IP20



GOPLE 60 SPOT TRACK

W	V	Beam	Flux	CCT	Dimmable DALI Code
9 W	48V	S 14°	557 lm	2700K	CA000. 01/04
			557 lm	3000K	CA010. 01/04
			557 lm	4000K	CA020. 01/04
		*F 21°	556 lm	2700K	CA001. 01/04
			598 lm	3000K	CA011. 01/04
			641 lm	4000K	CA021. 01/04
		*WF 28°	503 lm	2700K	CA002. 01/04
			542 lm	3000K	CA012. 01/04
			580 lm	4000K	CA022. 01/04

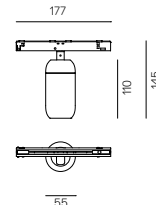

GOPLE 80 SPOT TRACK

W	V	Beam	Flux	CCT	Dimmable DALI Code
19 W	48V	S 15°	1739 lm	2700K	CA100. 01/04
			1837 lm	3000K	CA110. 01/04
			1986 lm	4000K	CA120. 01/04
		F 22°	1779 lm	2700K	CA101. 01/04
			1879 lm	3000K	CA111. 01/04
			2031 lm	4000K	CA121. 01/04
		WF 31°	1845 lm	2700K	CA102. 01/04
			1949 lm	3000K	CA112. 01/04
			2107 lm	4000K	CA122. 01/04

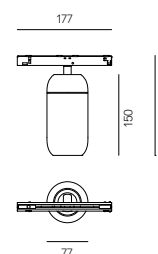

GOPLE 60 SPOT PENDANT TRACK

W	V	Beam	Flux	CCT	Dimmable DALI Code
9 W	48V	S 14°	557 lm	2700K	CA200. 01/04
			557 lm	3000K	CA210. 01/04
			557 lm	4000K	CA220. 01/04
		*F 21°	556 lm	2700K	CA201. 01/04
			598 lm	3000K	CA211. 01/04
			641 lm	4000K	CA221. 01/04
		*WF 28°	503 lm	2700K	CA202. 01/04
			542 lm	3000K	CA212. 01/04
			580 lm	4000K	CA222. 01/04

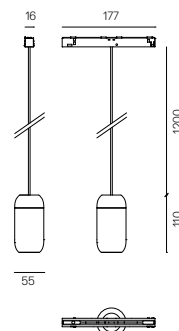

GOPLE 80 SPOT PENDANT TRACK

W	V	Beam	Flux	CCT	Dimmable DALI Code
19 W	48V	S 15°	1739 lm	2700K	CA300. 01/04
			1837 lm	3000K	CA310. 01/04
			1986 lm	4000K	CA320. 01/04
		F 22°	1779 lm	2700K	CA301. 01/04
			1879 lm	3000K	CA311. 01/04
			2031 lm	4000K	CA321. 01/04
		WF 31°	1845 lm	2700K	CA302. 01/04
			1949 lm	3000K	CA312. 01/04
			2107 lm	4000K	CA322. 01/04

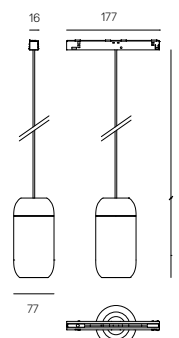

Alphabet of light & Gople system Joints



ALPHABET OF LIGHT AND GOPLE SYSTEM - JOINTS

White Black



IP20
⊕

JOINTS

		Code
01	→ Linear - linear joint	CB200. 01/04
02	→ Linear - curve 45° right joint	CB201. 01/04
03	→ Linear - curve 45° left joint	CB202. 01/04
04	→ Linear - curve 60° right joint	CB203. 01/04
05	→ Linear - curve 60° left joint	CB204. 01/04
06	→ Linear - curve up joint	CB205. 01/04
07	→ Linear - curve down joint	CB206. 01/04
08	→ Linear - curve 90° right joint	CB307. 01/04
09	→ Linear - curve 90° left joint	CB306. 01/04



Code CB200.01/04_ **JOINT 1**
→ LINEAR - LINEAR JOINT

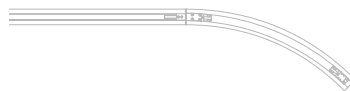

Code CB201.01/04_ **JOINT 2**
→ LINEAR - CURVE 45° RIGHT JOINT



Code CB202.01/04_ **JOINT 3**
→ LINEAR - CURVE 45° LEFT JOINT



Code CB203.01/04_ **JOINT 4**
→ LINEAR - CURVE 60° RIGHT JOINT



Code CB204.01/04_ **JOINT 5**
→ LINEAR - CURVE 60° LEFT JOINT



Code CB205.01/04_ **JOINT 6**
→ LINEAR - CURVE UP JOINT



Code CB206.01/04_ **JOINT 7**
→ LINEAR - CURVE DOWN JOINT



Code CB306.01/04_ **JOINT 8**
→ LINEAR - CURVE 90° RIGHT JOINT



Code CB307.01/04_ **JOINT 9**
→ LINEAR - CURVE 90° LEFT JOINT

Alphabet of light & Gople system Configuration

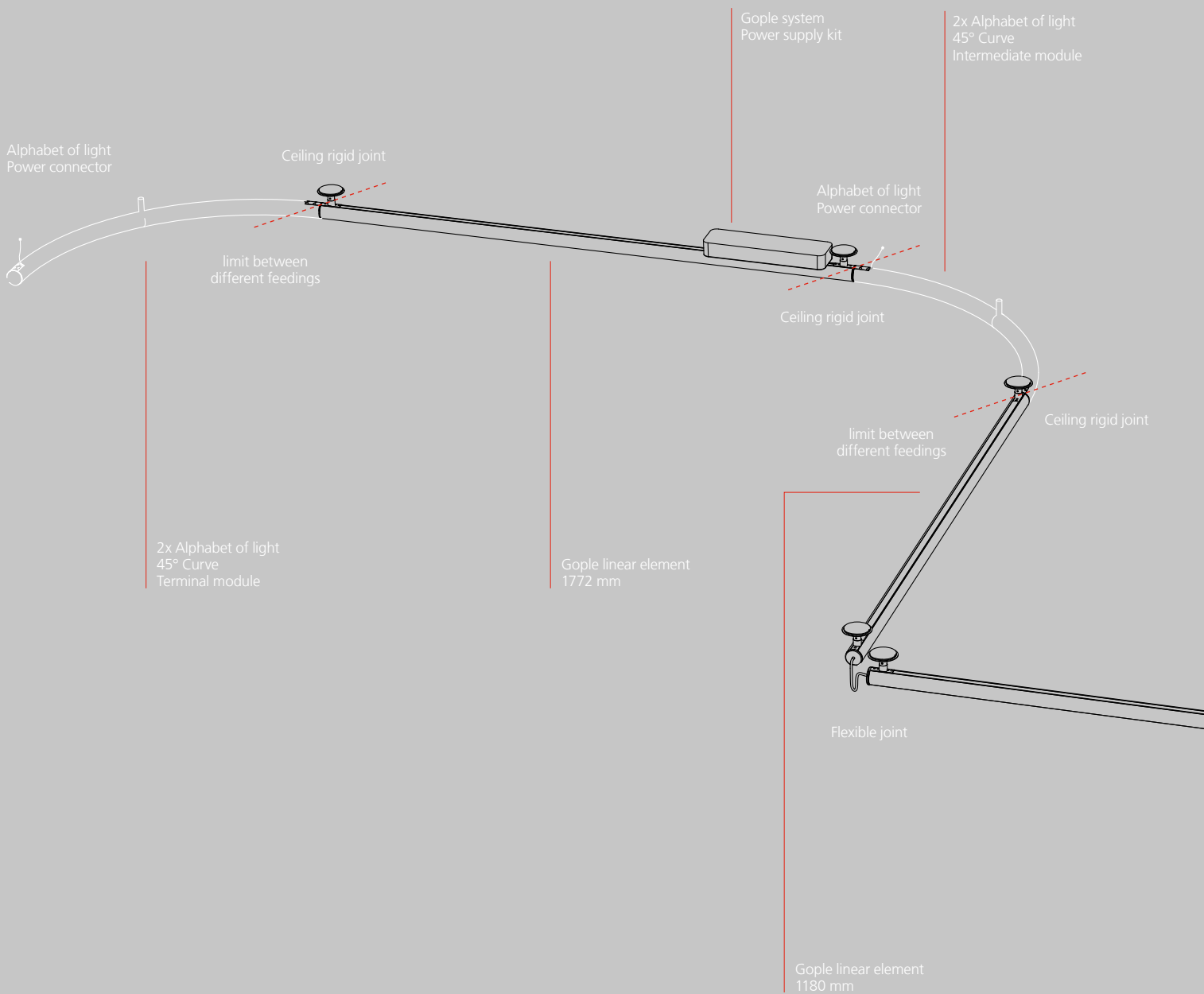

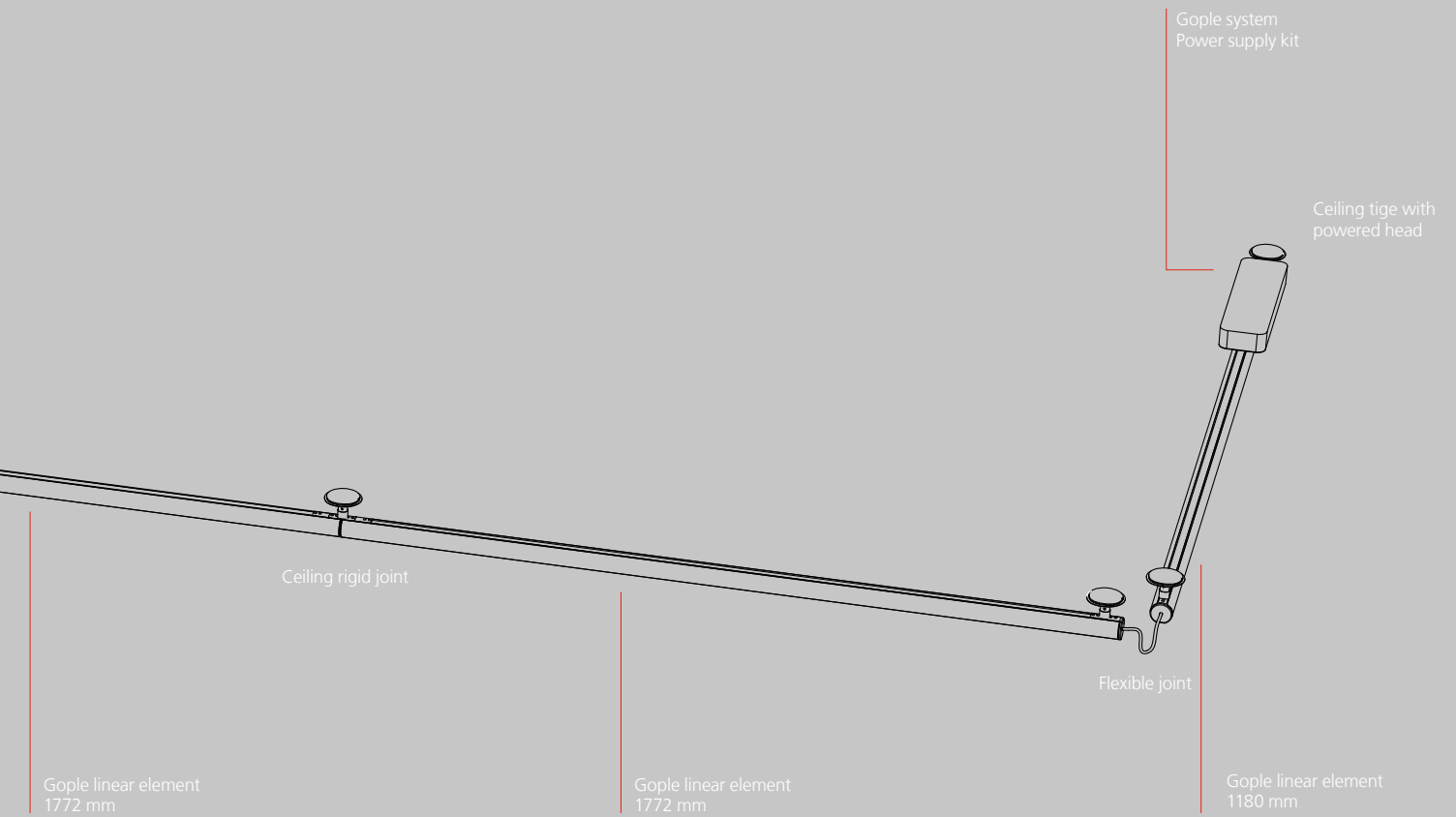
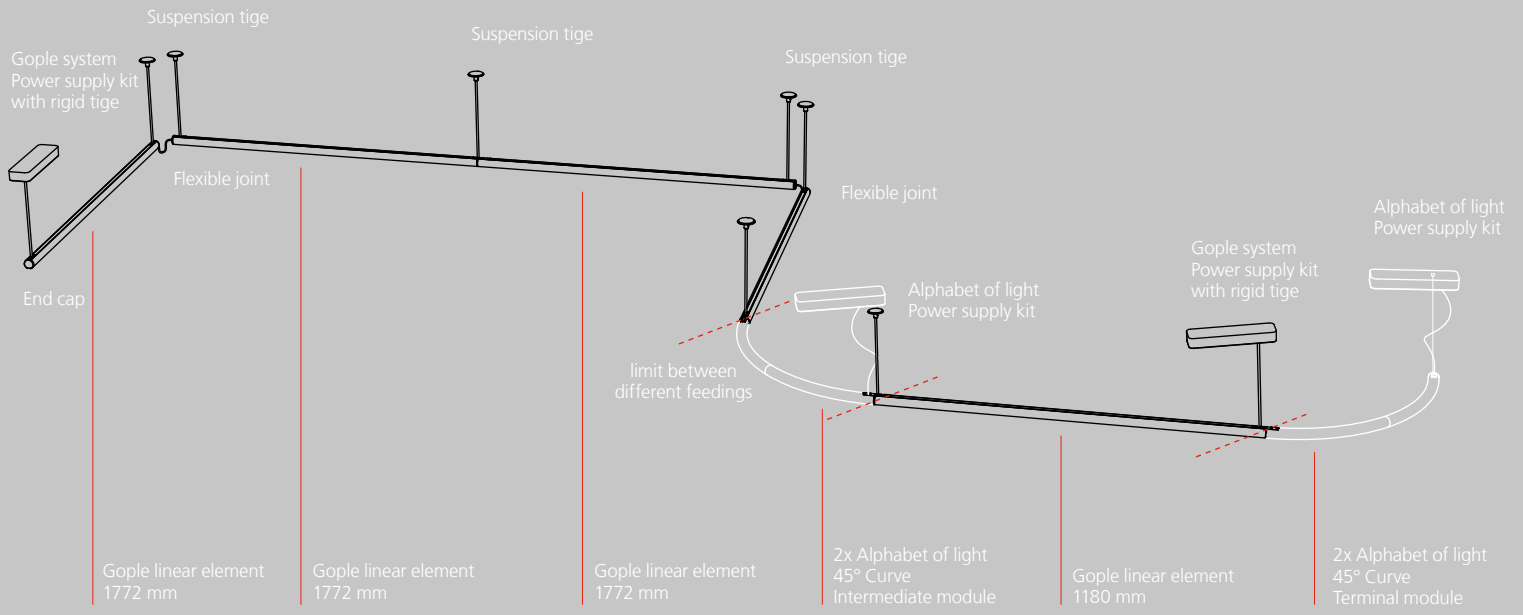





A glowing white curved light fixture, possibly a lamp or a decorative element, is shown against a dark background. The light is bright and diffused, creating a soft glow. The fixture is curved and appears to be made of a material that diffuses light, like PMMA.

Alphabet of light

Stand Alone

Linear

Rectangular

Square

Circular

Materials: structure in anodized natural aluminum, tube in white diffusing PMMA.

- PATENT OF INVENTION: MECHANICAL AND ELECTRICAL CONNECTION
- PATENT OF INVENTION: OPTICS



Artemide
App





ALPHABET OF LIGHT - LINEAR

Opal White



XF



*EDP compliance



EPDITALY0430
12/05/2023
www.epditaly.it

MacAdam 2SDCM
Life L80 (10K) 55000h
CRI =80

IP20



WALL/CEILING

	W	Flux	CCT
Linear 120	35 W	3480 lm	3000K
Linear 180	50 W	5226 lm	3000K
Linear 240	63 W	6968 lm	3000K

DALI / PUSH
Code
1304000A
1305000A
1308000A

APP & PUSH
Code
1304000APP
1305000APP
1308000APP

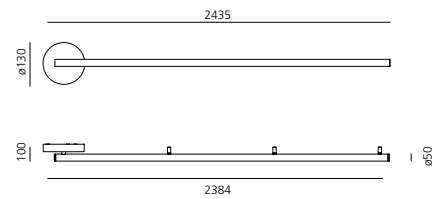
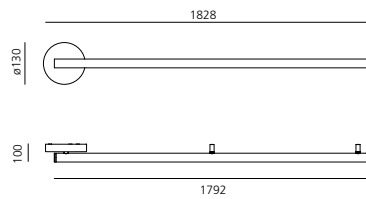
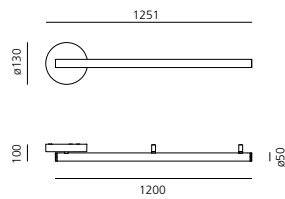

SUSPENSION

	W	Flux	CCT
Linear 120	35 W	3484 lm	3000K
Linear 180	50 W	5226 lm	3000K
Linear 240	63 W	6968 lm	3000K

DALI / PUSH
Code
1204000A
1205000A
1208000A

APP / PUSH
Code
1204000APP
1205000APP
1208000APP*

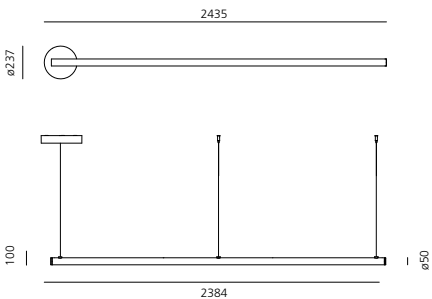
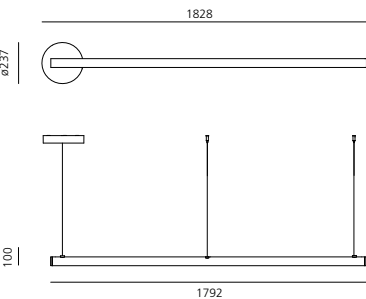
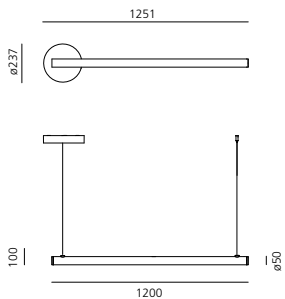
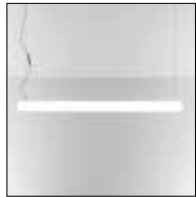

4.5 m extension feeding cable + 3 suspension wires L=6m for AoL linear 120/180/240

Code
1209000A

Optional control devices - BLL wireless switch



Device for switching and controlling Artemide App products.
Max N.3 inputs for external push buttons.
Max 1 m distance.
Mains power supply required.
To be installed inside flush mounting boxes or junction boxes.

Code
DV1080APP

ALPHABET OF LIGHT - LINEAR

<p>Opal White</p>	<p>XF</p>	<p>Constant current SELV driver supplied separately</p>	<p>MacAdam 3SDCM Life L80 (10K) 55000h CRI =80</p>	<p>IP20</p>
-------------------	-----------	---	--	-------------

WALL/CEILING SEMI-RECESSED

	L	W	Flux	CCT	Code
Linear 120	800mA	29 W	3480 lm	3000K	1425000A
Linear 180	1200mA	44 W	5226 lm	3000K	1426000A
Linear 240	1600mA	58 W	6968 lm	3000K	1427000A

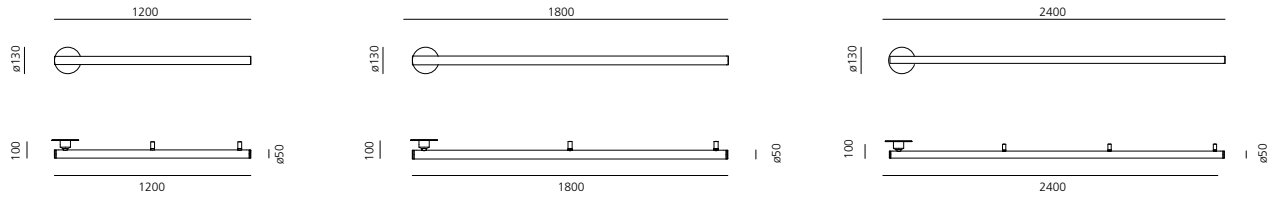

Model	Driver	Vac	Pw	L _{mm}	W _{mm}	H _{mm}		Code
Linear 120	CC 800mA	220-240	35	124	80	22	DALI / 1-10 / PUSH	DV1035
Linear 120	CC 800mA	220-240	35	124	80	22	APP / PUSH	DV1035APP
Linear 180	CC 1200mA	220-240	50	124	80	22	DALI / 1-10 / PUSH	DV1035
Linear 180	CC 1200mA	220-240	50	124	80	22	APP / PUSH	DV1035APP
Linear 240	CC 1600mA	220-240	63	130	76	30	DALI / 1-10 / PUSH	DV1034
Linear 240	CC 1600mA	220-240	63	130	76	30	APP / PUSH	DV1034APP













Luca Faloni | Munich, Germany | 2022

ALPHABET OF LIGHT - RECTANGULAR/SQUARE

Opal White	XF	MacAdam 3SDCM Life L70 (10K) 60000h CRI =90	IP20
			

SQUARE WALL/CEILING

	W	Flux	CCT	DALI / PUSH	APP & PUSH	
				Code	Code	
Square 120	100 W	9488 lm	3000K	1430210A	1430210APP	
Square 180	145W	14020 lm	3000K	1430220A	1430220APP	

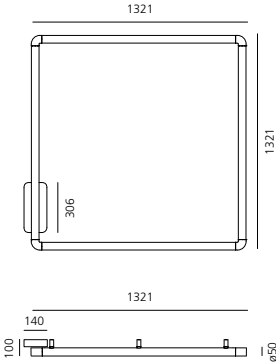

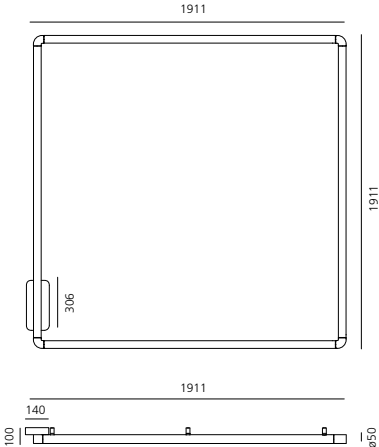

RECTANGULAR WALL/CEILING

	W	Flux	CCT	DALI / PUSH	APP & PUSH	
				Code	Code	
Rectangular	120 W	11754 lm	3000K	1430230A	1430230APP	

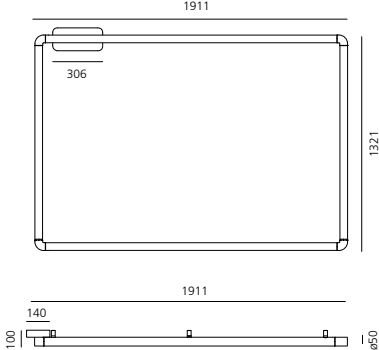



Optional control devices - BLL wireless switch



Device for switching and controlling Artemide App products.
 Max N.3 inputs for external push buttons.
 Max 1 m distance.
 Mains power supply required.
 To be installed inside flush mounting boxes or junction boxes.

Code
DV1080APP

ALPHABET OF LIGHT - RECTANGULAR/SQUARE

Opal White	XF	MacAdam 3SDCM Life L70 (10K) 60000h CRI =90	IP20
			

SQUARE SUSPENSION

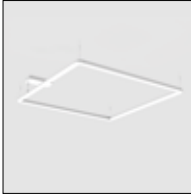
	W	Flux	CCT	DALI / PUSH	APP & PUSH	
				Code	Code	
Square 120	100 W	9488 lm	3000K	1430010A	1430010APP	
Square 180	145W	14020 lm	3000K	1430020A	1430020APP	

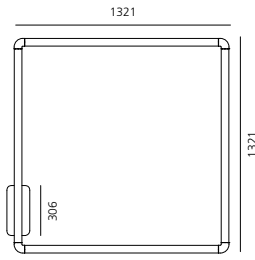

1321

1321

306

100

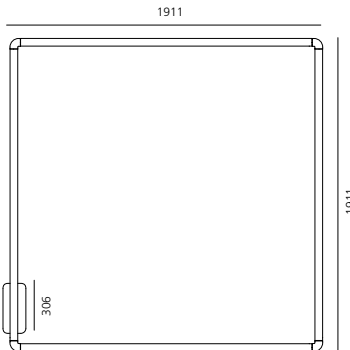

1911

1911

306

100

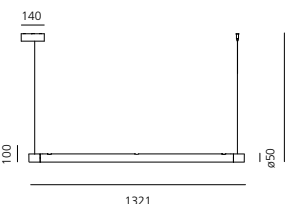

1321

100

140

50

min 500 - max 1500

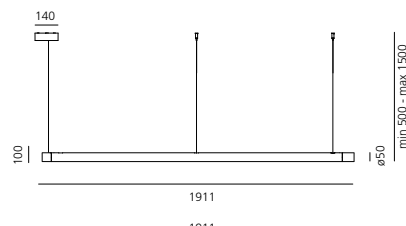

1911

100

140

50

min 500 - max 1500

RECTANGULAR SUSPENSION

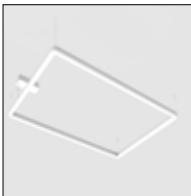
	W	Flux	CCT	DALI / PUSH	APP & PUSH	
				Code	Code	
Rectangular	120 W	11754 lm	3000K	1430030A	1430030APP	

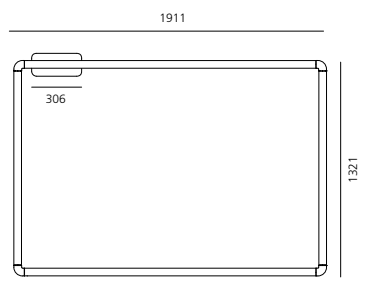

1911

1321

306

100

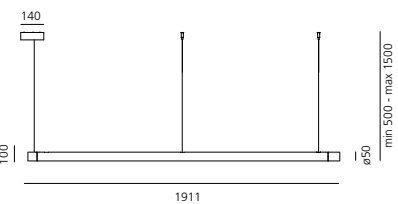

1911

100

140

50

min 500 - max 1500



Optional control devices - BLL wireless switch



Device for switching and controlling Artemide App products.
 Max N.3 inputs for external push buttons.
 Max 1 m distance.
 Mains power supply required.
 To be installed inside flush mounting boxes or junction boxes.

Code
DV1080APP

ALPHABET OF LIGHT - RECTANGULAR/SQUARE

Opal White	XF	MacAdam 3SDCM	IP20
		Life L70 (10K) 60000h	
		CRI =90	

SQUARE WALL/CEILING SEMI-RECESSED

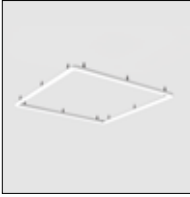
	W	Flux	CCT	Code	
Square 120	90 W	9488 lm	3000K	1430110A	
Square 180	138W	14020 lm	3000K	1430120A	

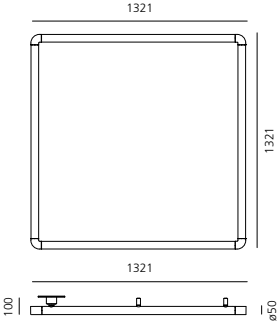
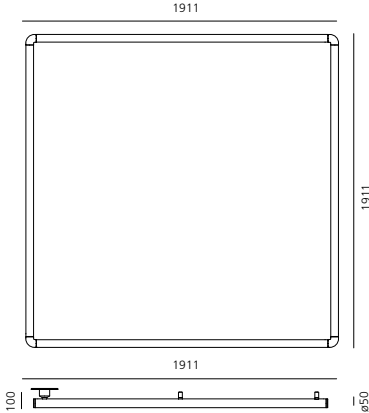
RECTANGULAR WALL/CEILING SEMI-RECESSED

	W	Flux	CCT	Code	
Rectangular	114 W	11754 lm	3000K	1430130A	

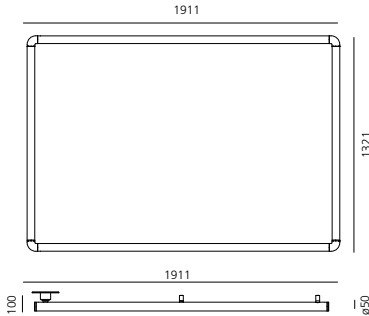

Wall/Ceiling Semi-recessed Power Units

Dali / Push remote power unit box (175W, 220-240VAC, L=306, W=140, H=44)
 APP remote power unit box (175W, 220-240VAC, L=306, W=140, H=44)

Code
2271010A
2271010APP

Optional control devices - BLL wireless switch



Device for switching and controlling Artemide App products.
 Max N.3 inputs for external push buttons.
 Max 1 m distance.
 Mains power supply required.
 To be installed inside flush mounting boxes or junction boxes.

Code
DV1080APP



Materials: structure in anodized natural aluminum,
tube in white diffusing PMMA.

Linear modules are available in three lengths: L 1200 / 1800 / 2400 mm.

Circular modules are available in two diameters: \varnothing tot 900 / 1550 mm.



La Biennale di Venezia, "Robin Hood Gardens: A Ruin in Reverse" Exhibition, | 2018







ALPHABET OF LIGHT - CIRCULAR

Opal White

XF



MacAdam 3SDCM
Life L70 (10K) 55000h
CRI =80

IP20
⊕

WALL/CEILING

	W	Flux	CCT	DALI / PUSH Code	APP & PUSH Code
Circular ø 90	55 W	6040 lm	3000K	1306000A	1306000APP
Circular ø155	91W	10740 lm	3000K	1307000A	1307000APP
Circular ø350	180W	21478 lm	3000K	1213000A	1213000APP

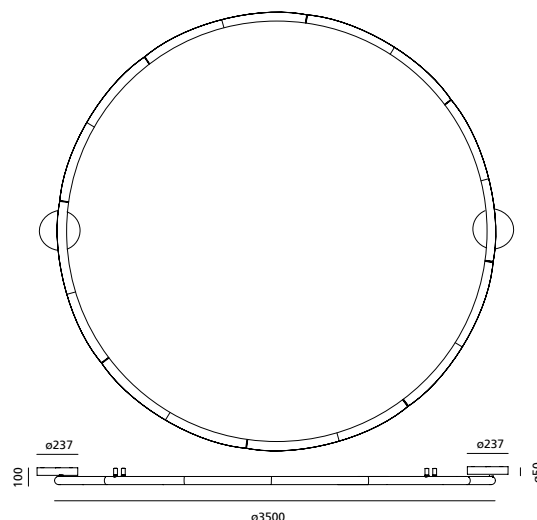
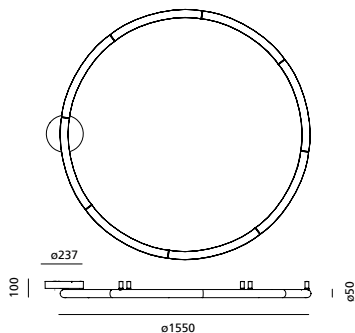
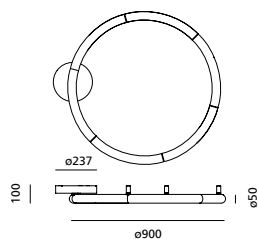

Optional control devices - BLL wireless switch



Device for switching and controlling Artemide App products.
Max N.3 inputs for external push buttons.
Max 1 m distance.
Mains power supply required.
To be installed inside flush mounting boxes or junction boxes.

Code
DV1080APP

ALPHABET OF LIGHT - CIRCULAR

Opal White



XF



Constant current SELV
driver supplied separately

MacAdam 3SDCM
Life L70 (10K) 55000h
CRI =80

IP20

WALL/CEILING SEMI-RECESSED

	W	Flux	CCT	Code
Circular ø 90	50 W	6040 lm	3000K	1428000A
Circular ø155	86 W	10740 lm	3000K	1429000A
Circular ø350	172W	21478 lm	3000K	1215000A

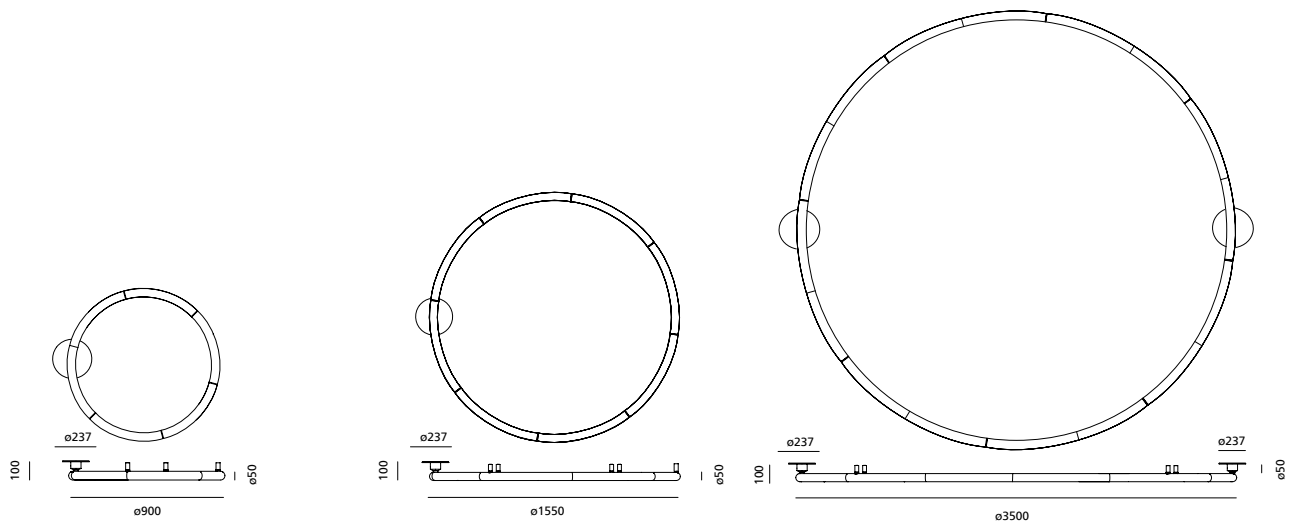

Model	Driver	Vac	Pw	L _{mm}	W _{mm}	H _{mm}		Code
Circular Ø90	CC 1400mA	220-240	55	130	76	30	DALI / 1-10 / PUSH	DV1034
Circular Ø90	CC 1400mA	220-240	55	130	76	30	APP / PUSH	DV1034APP
Circular Ø155	CC 1200+1200mA	220-240	91	350	80	23	DALI / 1-10 / PUSH	DV1036
Circular Ø155	CC 1200+1200mA	220-240	91	350	80	23	APP / PUSH	DV1036APP
Circular Ø350	CC 1050+1050mA	220-240	141	350	80	23	DALI / 1-10 / PUSH	DV1109
Circular Ø350	CC 1050+1050mA	220-240	141	350	80	23	APP / PUSH	DV1109APP

ALPHABET OF LIGHT - CIRULAR

Opal White



XF



*EDP compliance



EPDITALY0430
12/05/2023
www.epditaly.it

MacAdam 3SDCM
Life L70 (10K) 55000h
CRI =80

IP20



SUSPENSION

	W	Flux	CCT
Circular ø 90	55 W	6040 lm	3000K
Circular ø 155	91W	10740 lm	3000K
Circular ø 350	180W	21478 lm	3000K

DALI / PUSH
Code
1206000A
1207000A*
1214000A

APP / PUSH
Code
1206000APP
1207000APP
1214000APP

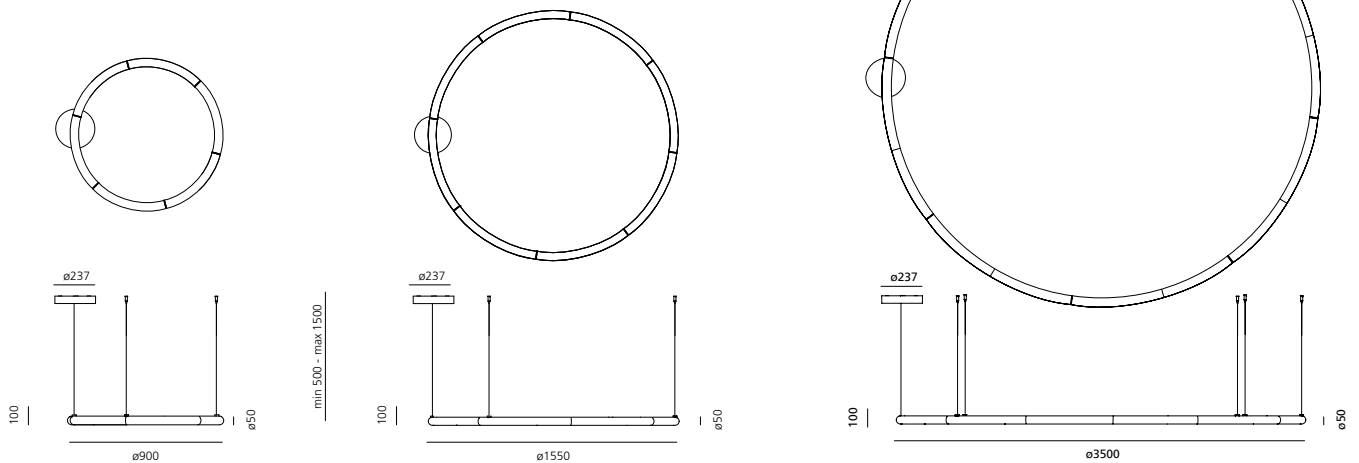

4.5 m extension feeding cable + 4 suspension wires L=6m for AoL circular Ø155
4.5 m extension feeding cable + 3 suspension wires L=6m for AoL circular Ø90

Code
1209100A
1209000A

Optional control devices - BLL wireless switch



Device for switching and controlling Artemide App products.
Max N.3 inputs for external push buttons.
Max 1 m distance.
Mains power supply required.
To be installed inside flush mounting boxes or junction boxes.

Code
DV1080APP











TEATRO ARENA

Alphabet of light Letters & Letters Mini

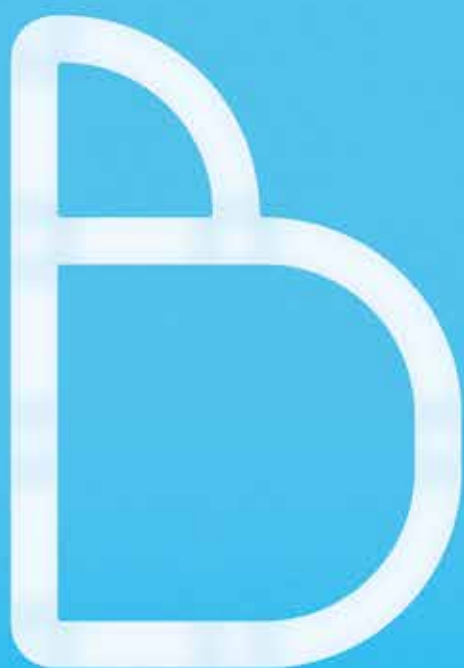

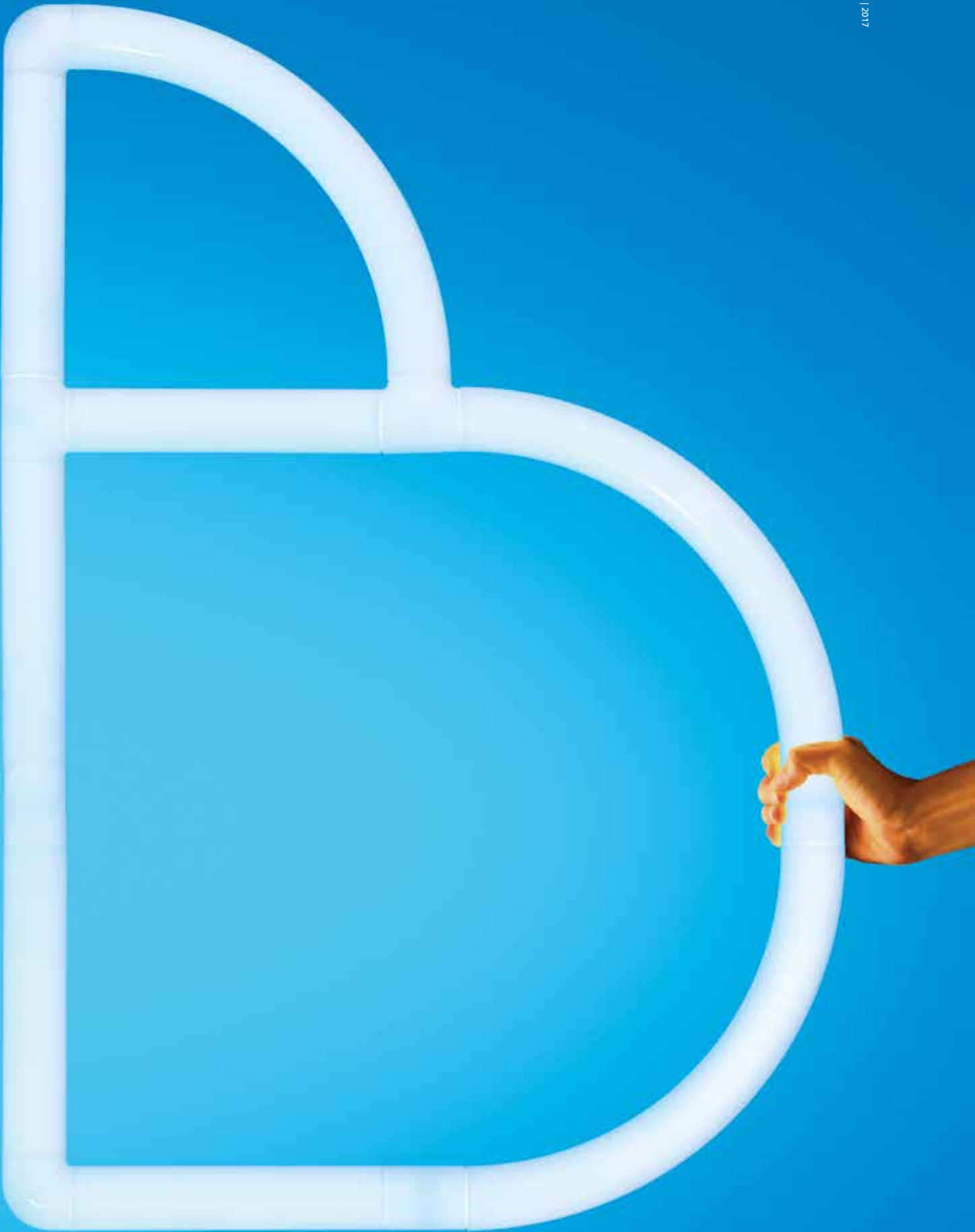

"Quick brown fox jumps over the lazy dog" Installation at Università Statale di Milano
Milano Design Week, Ph. Saverio Lombardi Vallauri | 2017





os over the lazy dog





Artemide Lighting Consultancy & Training Center, New York | 2017

Alphabet of light Letters installation

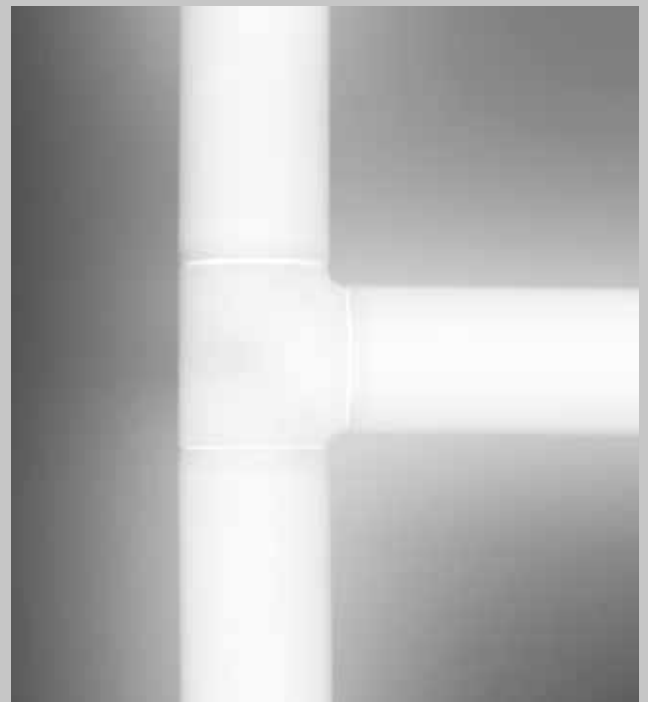
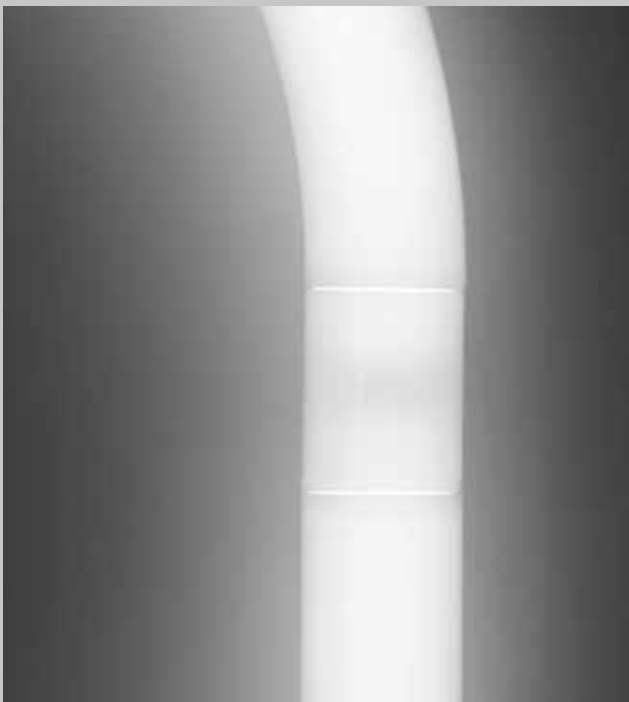
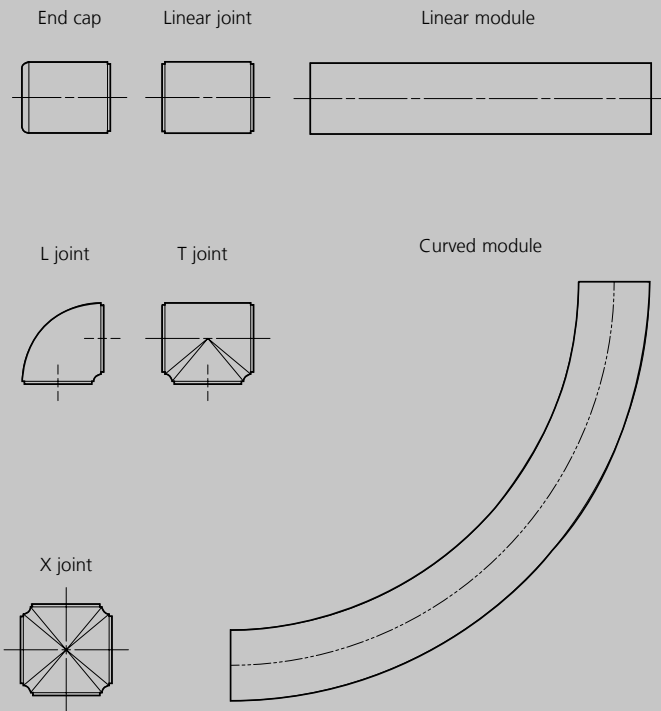

Modules

An entire alphabet composed by 7 elements:
5 joints + 2 constructive modules
with electro - mechanical connections.

→ MDF SUPPORT INSTALLATION

The letters are provided mounted on MDF panels to allow installation on any kind of wall. Installation requires creating a counter-frame to accommodate the drivers, supplied separately, and the power cables.

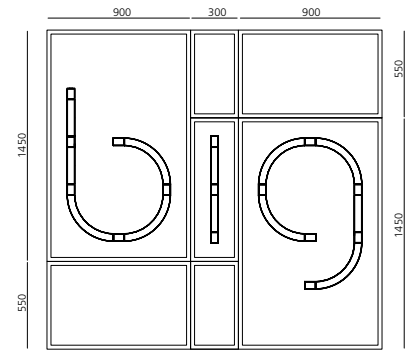

1. Create the supporting frame and provide for power connections for the individual letters.



2. Connect panel **b** to power source.



3. Fix panel **b** and connect panel **i** to power source.



4. Fix panel **i** and connect panel **g** to power source.



5. Fix panel **g** and close using the supplied panels.



6. Complete closing using the supplied panels.



7. Frame ready for finishing.



8. Apply the gauze and plaster flush with the gaps between panels.



9. Final painting.

→ CARDBOARD MOUNTING-SUPPORT INSTALLATION

The letters are provided with a packaging that ensures the right support during the installation process. This type of installation is suitable for existing drywalls that have accessible back space for the housing of drivers (code DV1009) supplied separately and cables (power supply 75 W max - 2 letters or more up to max 85% load).

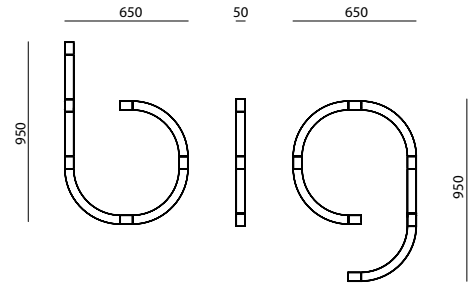

1. Drywall with accessible back space.

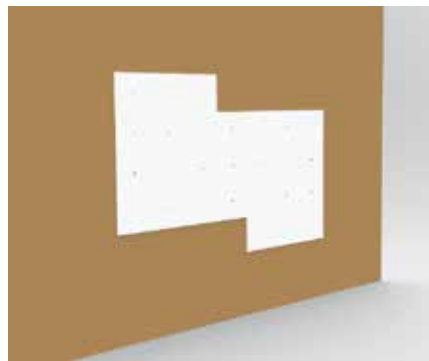

2. Use the provided template to drill the holes and paint the drywall.

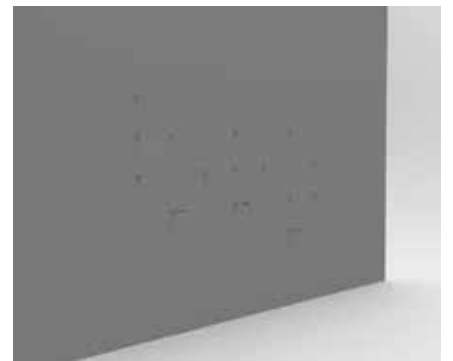

3. Install wall pins, identify output points and prepare wiring connections.

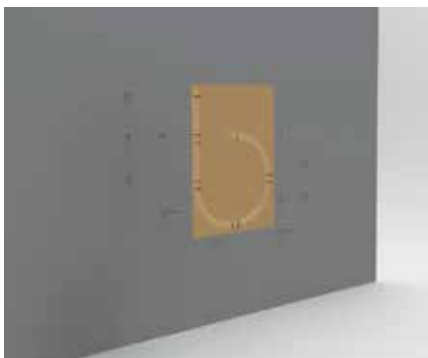

4. Connection of letter **b** to first wall output.



5. Attachment of letter **b** on wall pins.



6. Detail of the wall pins fixing.



7. Detail of the wall pins fixing.



8. Removal of the nylon wrapper.



9. Removal of the cardboard support.



10. Connect letter **i** to first wall output.



11. Fix letter **i** on wall pins.



12. Removal of the nylon wrapper.



13. Attachment of letter **g** to first wall output.



14. Removal of the nylon wrapper.



15. Finished.



ALPHABET OF LIGHT - LETTERS

Opal White



XF



24VDC Driver supplied separately.

MacAdam 3SDCM
Life L70 (6K) 36000h
CRI =80

IP20
⊕

Size			
Letter	W	Flux	H x L
A	36 W	3060 lm	950 x 650
B	38 W	3240 lm	950 x 650
C	22 W	1962 lm	950 x 650
D	36 W	3024 lm	950 x 650
E	30 W	2538 lm	950 x 650
F	22 W	1890 lm	950 x 650
G	24 W	2079 lm	950 x 650
H	32 W	2664 lm	950 x 650
I	12 W	1008 lm	950 x 50
J	24 W	2079 lm	950 x 650
K	30 W	2556 lm	950 x 650
L	20 W	1656 lm	950 x 650
M	46 W	3834 lm	950 x 950
N	30 W	2520 lm	950 x 650
O	32 W	2808 lm	950 x 650
P	32 W	2718 lm	950 x 650
Q	36 W	3150 lm	950 x 650
R	36 W	3060 lm	950 x 650
S	26 W	2295 lm	950 x 650
T	20 W	1674 lm	950 x 650
U	28 W	2412 lm	950 x 650
V	30 W	2520 lm	950 x 650
W	46 W	3834 lm	950 x 950
X	32 W	2664 lm	950 x 900
Y	24 W	2106 lm	950 x 650
Æ	50 W	4176 lm	950 x 950
Ø	44 W	3780 lm	950 x 650
À	44 W	3780 lm	950 x 650
Z	32 W	2736 lm	950 x 650

Letters	+ MDF Support
1201A00A	1211A00A
1201B00A	1211B00A
1201C00A	1211C00A
1201D00A	1211D00A
1201E00A	1211E00A
1201F00A	1211F00A
1201G00A	1211G00A
1201H00A	1211H00A
1201I00A	1211I00A
1201J00A	1211J00A
1201K00A	1211K00A
1201L00A	1211L00A
1201M00A	1211M00A
1201N00A	1211N00A
1201O00A	1211O00A
1201P00A	1211P00A
1201Q00A	1211Q00A
1201R00A	1211R00A
1201S00A	1211S00A
1201T00A	1211T00A
1201U00A	1211U00A
1201V00A	1211V00A
1201W00A	1211W00A
1201X00A	1211X00A
1201Y00A	1211Y00A
1201Æ00A	1211Æ00A
1201§00A	1211§00A
1201£00A	1211£00A
1201Z00A	1211Z00A

Size			
Letter	W	Flux	H x L
0	32 W	2808 lm	950 x 650
1	26 W	2205 lm	950 x 650
2	32 W	2835 lm	950 x 650
3	26 W	2304 lm	950 x 650
4	26 W	2214 lm	950 x 650
5	34 W	2943 lm	950 x 650
6	28 W	2502 lm	950 x 650
7	22 W	1872 lm	950 x 650
8	40 W	3456 lm	950 x 650
9	28 W	2502 lm	950 x 650

Letters	+ MDF Support
1200000A	1210000A
1200100A	1210100A
1200200A	1210200A
1200300A	1210300A
1200400A	1210400A
1200500A	1210500A
1200600A	1210600A
1200700A	1210700A
1200800A	1210800A
1200900A	1210900A

Size			
Letter	W	Flux	H x L
a	22 W	1971 lm	650 x 650
b	26 W	2295 lm	950 x 650
c	18 W	1638 lm	650 x 650
d	26 W	2295 lm	950 x 650
e	22 W	1971 lm	650 x 650
f	18 W	1557 lm	950 x 350
g	28 W	2502 lm	950 x 650
h	26 W	2214 lm	950 x 650
i	8 W	684 lm	650 x 50
j	14 W	1215 lm	950 x 350
k	26 W	2223 lm	950 x 650
l	12 W	1008 lm	950 x 50
m	34 W	2862 lm	650 x 950
n	22 W	1872 lm	650 x 650
o	24 W	2160 lm	650 x 650
p	26 W	2295 lm	950 x 650
q	26 W	2295 lm	950 x 650
r	14 W	1233 lm	650 x 350
s	24 W	2079 lm	650 x 650
t	18 W	1557 lm	950 x 350
u	22 W	1872 lm	650 x 650
v	20 W	1746 lm	650 x 650
w	28 W	2394 lm	650 x 950
x	16 W	1368 lm	650 x 650
y	28 W	2421 lm	950 x 650
æ	34 W	3069 lm	650 x 950
ø	32 W	2808 lm	650 x 650
à	28 W	2511 lm	650 x 650
z	28 W	2421 lm	650 x 650

Letters	+ MDF Support
1202a00A	1212a00A
1202b00A	1212b00A
1202c00A	1212c00A
1202d00A	1212d00A
1202e00A	1212e00A
1202f00A	1212f00A
1202g00A	1212g00A
1202h00A	1212h00A
1202i00A	1212i00A
1202j00A	1212j00A
1202k00A	1212k00A
1202l00A	1212l00A
1202m00A	1212m00A
1202n00A	1212n00A
1202o00A	1212o00A
1202p00A	1212p00A
1202q00A	1212q00A
1202r00A	1212r00A
1202s00A	1212s00A
1202t00A	1212t00A
1202u00A	1212u00A
1202v00A	1212v00A
1202w00A	1212w00A
1202x00A	1212x00A
1202y00A	1212y00A
1202æ00A	1212æ00A
1202§00A	1212§00A
1202£00A	1212£00A
1202z00A	1212z00A

Driver							
Driver	Vac	L _{mm}	W _{mm}	H _{mm}	IP	N° device	Code
75 W	220-240	180	52	30	20	1min-2max	Undimmable DV1009







Broken Nature "La Nazione delle Piante", XXII International Exhibition, Triennale di Milano. Ph. Federico Villa | 2017



ALPHABET OF LIGHT - LETTERS MINI

Opal White

XF

24VDC Driver supplied separately.

MacAdam 3SDCM
Life L70 (10K) 102000h
CRI =90

IP20



Size

Letter	W	Flux	H x L
A	11 W	1151 lm	355 x 245
B	12 W	1233 lm	355 x 245
C	7 W	740 lm	355 x 245
D	11 W	1151 lm	355 x 245
E	9 W	946 lm	355 x 245
F	7 W	699 lm	355 x 245
G	8 W	781 lm	355 x 245
H	10 W	987 lm	355 x 245
I	4 W	370 lm	355 x 25
J	8 W	781 lm	355 x 245
K	9 W	946 lm	355 x 245
L	6 W	616 lm	355 x 245
M	14 W	1439 lm	355 x 355
N	9 W	946 lm	355 x 245
O	11 W	1069 lm	355 x 245
P	10 W	1027 lm	355 x 245
Q	12 W	1192 lm	355 x 245
R	11 W	1151 lm	355 x 245
S	9 W	863 lm	355 x 245
T	6 W	616 lm	355 x 245
U	9 W	905 lm	355 x 245
V	9 W	946 lm	355 x 245
W	14 W	1439 lm	355 x 355
X	10 W	986 lm	343 x 343
Y	8 W	781 lm	355 x 245
Æ	15 W	1562 lm	355 x 355
Ø	14 W	1439 lm	355 x 245
À	13 W	1357 lm	433 x 245
Z	13 W	1027 lm	355 x 245

Letters

1215A00A
1215B00A
1215C00A
1215D00A
1215E00A
1215F00A
1215G00A
1215H00A
1215I00A
1215J00A
1215K00A
1215L00A
1215M00A
1215N00A
1215O00A
1215P00A
1215Q00A
1215R00A
1215S00A
1215T00A
1215U00A
1215V00A
1215W00A
1215X00A
1215Y00A
1215Æ00A
1215Ø00A
1215À00A
1215Z00A

Driver

Driver	Vac	L _{mm}	W _{mm}	H _{mm}	IP	N° device	Code
75 W 220-240	180	52	30	20	1min-2max	Undimmable	DV1009
25 W 220-240	153	41	32	20	1min-2max	Undimmable	DV1032



OLG

Alphabet of light and Gople system are compatible with **Artemide App**

Artemide App is a user-friendly and intuitive interface used to control individual products, groups of appliances and lighting scenarios. It is a tool that can be associated with several products from both the Design and the Architectural Catalogues.





Download Artemide App
and find more information on
[artemide.com](https://www.artemide.com)

Headquarters

Artemide S.p.A.

Via Bergamo, 18
20006 Pregnana Milanese (MI), Italy
Tel. +39 02 93518.1
Tel. +39 02 93526.1
Numero verde 800 834 093
(from Italy only)
info@artemide.com
artemide.com

Artemide S.p.A.

si riserva la facoltà di modificare, in qualunque momento e senza preavviso, le caratteristiche tecniche degli elementi illustrati nel presente catalogo.

Artemide S.p.A.

reserves the right to change, at any time and without prior warning, the technical specifications of any product illustrated in this catalogue.

Artemide S.p.A.

se réserve le droit de modifier, à n'importe quel moment et sans préavis, les caractéristiques techniques des éléments illustrés dans ce catalogue.

Artemide S.p.A.

behält sich das Recht vor jederzeit und ohne Ankündigung die technischen Daten der im Katalog abgebildeten Produkte zu ändern.

Artemide S.p.A.

se reserva la facultad de modificar, en cualquier y sin aviso previo, las características técnicas de los elementos ilustrados en el presente catálogo.

2024 updated version. V.4