









-  Mercedes Benz  
320 kW
-  Mercedes G 280  
with optional VOITH  
water retarder
-  MEGATRAK<sup>®</sup>
-  MAXbase
-  ECO Mode
-  CCS  
Crane Control System
-  MEGAFORM<sup>®</sup>  
TWIN-LOCK<sup>®</sup>

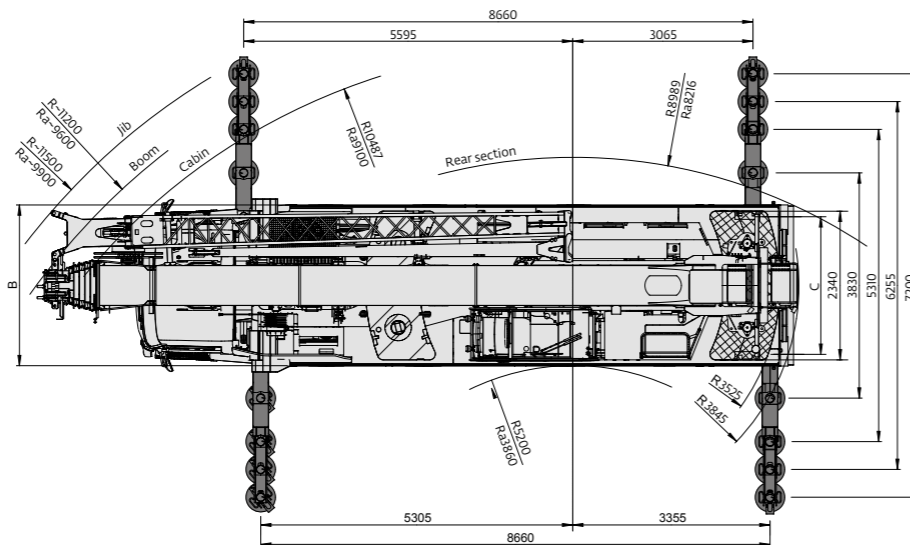
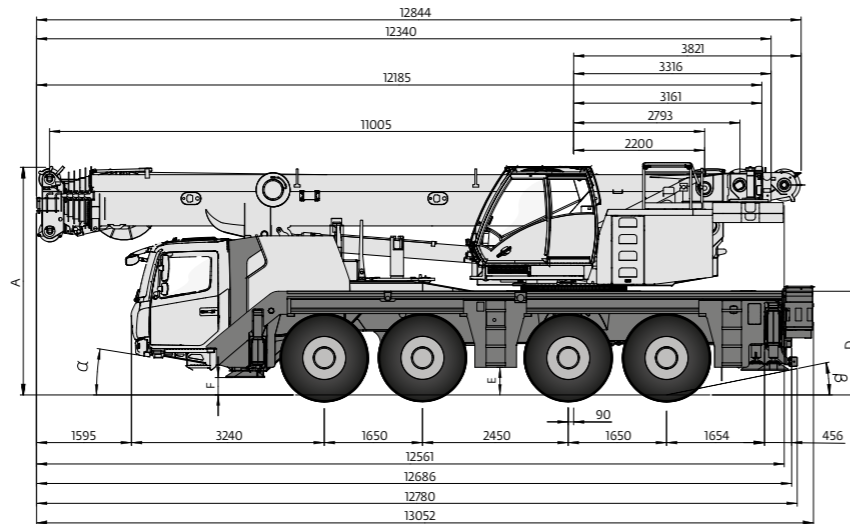

	A	A 126 mm*	B	C	D	E	F	α	β	β1
14.00 R25	3940	3810	2550	2320	1750	435	262	14	21	17
16.00 R25	3990	3860	2750	2280	1863	485	292	16	23	19
20.5 R25	3990	3860	2880	2320	1863	485	292	16	23	19

\* lowered, abgeseenkt, surbaissée, abbassato, rebaja, сниженный

Manitowoc Cranes

Regional headquarters

**Americas**  
Milwaukee, Wisconsin, USA  
Tel: +1 414 760 4600

Shady Grove, Pennsylvania, USA  
Tel: +1 717 597 8121  
Fax: +1 717 597 4062

**Europe and Africa**  
Dardilly, France -  
TOWERS  
Tel: +33 (0)4 72 18 20 20  
Fax: +33 (0)4 72 18 20 00

Wilhelmshaven, Germany -  
MOBILE  
Tel: +49 (0) 4421 294 0  
Fax: +49 (0) 4421 294 4301

**Middle East and Greater Asia-Pacific**  
Singapore  
Tel: +65 6264 1188  
Fax: +65 6862 4040

Dubai, UAE  
Tel: +971 4 8862677  
Fax: +971 4 8862678/79

**China**  
Shanghai, China  
Tel: +86 21 6457 0066  
Fax: +86 21 6457 4955



This document is non-contractual. Constant improvement and engineering progress make it necessary that we reserve the right to make specification, equipment, and price changes without notice. Illustrations shown may include optional equipment and accessories and may not include all standard equipment.

Die Angaben in diesem Dokument erfolgen ohne Gewähr. Wir verbessern unsere Produkte ständig und integrieren den technischen Fortschritt. Aus diesem Grund behalten wir uns das Recht vor, die technischen Daten, die Ausstattungsdetails und die Preise unserer Maschinen ohne Vorankündigung zu ändern.

Ce document est non-contractuel. Du fait de sa politique d'amélioration constante de ses produits liée au progrès technique, la Société se réserve le droit de procéder sans préavis à des changements de spécifications, d'équipement ou de prix. Les illustrations peuvent comporter des équipements ou accessoires optionnels ou ne pas comporter des équipements standards.

Este documento no es contractual. El perfeccionamiento constante y el avance tecnológico hacen necesario que la empresa se reserve el derecho de efectuar cambios en las especificaciones, equipo y precios sin previo aviso. En las ilustraciones se puede incluir equipo y accesorios opcionales y es posible que no se muestre el equipo normal.

Documento non contrattuale. In considerazione della sua politica di costante miglioramento dei prodotti connesso al progresso tecnico, la Società si riserva il diritto di modificare senza preavviso specifiche, equipaggiamenti o prezzi. Le illustrazioni possono contenere equipaggiamenti o accessori optional o non contenere equipaggiamenti standard.





Данный документ не является контрактным. Принимая во внимание необходимость постоянного совершенствования и модернизации мы оставляем за собой право изменять спецификации, конструкции и стоимость без предварительного уведомления. Приведенные иллюстрации могут содержать дополнительные компоненты и принадлежности, не входящие в стандартный комплект поставки оборудования.

©2019 The Manitowoc Company, Inc  
Form No: Folder\_GMK4090.01\_04.2019

www.manitowoc.com



GMK4090

-  90 t
-  8,7 - 21,0 m
-  51 m
-  75 m



Working range • Arbeitsbereiche • Diagramme de levage  
 Gama de trabajo • Area di lavoro • Грузовысотные характеристики

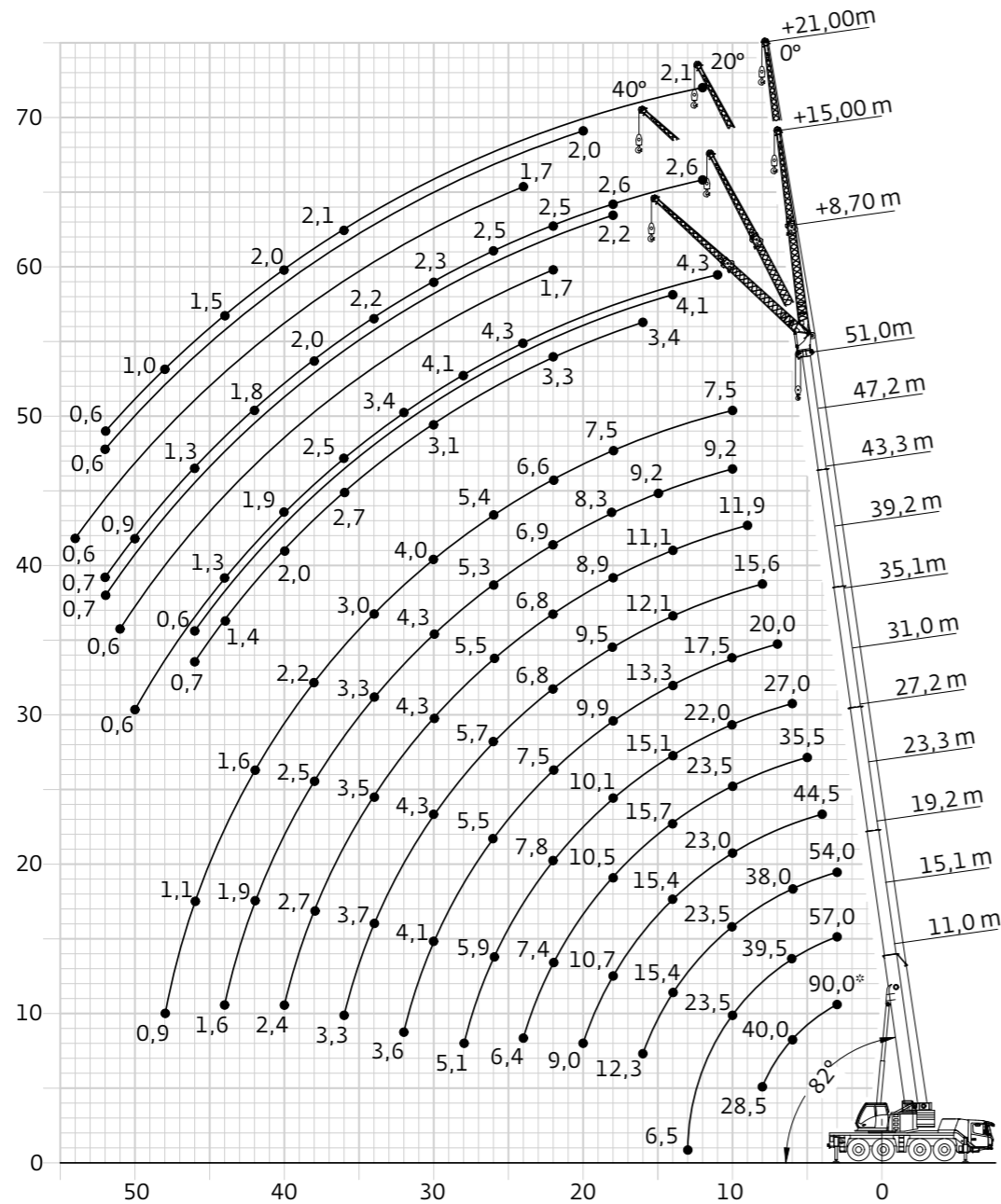

Telescopic boom • Teleskopausleger • Flèche principale  
 Pluma telescópica • Braccio telescopico • Телескопическая стрела

GMK4090

11,0 - 51,0 m   
 7,2 m   
 360°   
 18,3 t  
 EN 13000

m	11,0	15,1	19,2	23,3	27,2	31,0	35,1	39,2	43,3	47,2	51,0	m				
3,0	90,0*											3,0				
3,0	70,0	57,0	54,0									3,0				
4,0	53,5	50,5	47,0	44,5								4,0				
5,0	46,5	45,0	42,0	39,0	35,5							5,0				
6,0	40,0	39,5	38,0	35,5	33,5	27,0						6,0				
7,0	34,5	34,5	34,0	32,0	31,0	26,0	20,0					7,0				
8,0	28,5	30,0	30,0	29,5	28,5	25,0	19,7	15,6				8,0				
9,0		26,0	26,0	26,0	26,5	23,5	18,6	15,4	11,9			9,0				
10,0		23,5	23,5	23,0	23,5	22,0	17,5	15,2	11,9	9,2	7,5	10,0				
11,0		21,0	21,0	21,5	21,0	21,0	16,4	14,4	11,9	9,2	7,5	11,0				
12,0		18,2	18,9	19,2	18,6	18,6	15,3	13,7	11,9	9,2	7,5	12,0				
13,0		6,5	17,5	17,4	16,8	16,7	14,3	12,9	11,5	9,2	7,5	13,0				
14,0			15,4	15,4	15,7	15,1	13,3	12,1	11,1	9,2	7,5	14,0				
15,0			13,7	13,7	14,2	13,7	12,6	11,4	10,5	9,2	7,5	15,0				
16,0			12,3	12,5	12,8	12,3	11,7	10,7	9,9	9,0	7,5	16,0				
18,0				10,7	10,5	10,1	9,9	9,5	8,9	8,3	7,5	18,0				
20,0					8,8	8,4	8,8	8,0	8,0	7,6	7,0	20,0				
22,0					7,4	7,8	7,5	6,8	6,8	6,9	6,6	22,0				
24,0					6,4	6,8	6,4	6,4	5,9	6,0	6,1	24,0				
26,0						5,9	5,5	5,7	5,5	5,3	5,4	26,0				
28,0							5,1	4,8	4,9	5,0	4,9	28,0				
30,0								4,1	4,3	4,3	4,0	30,0				
32,0									3,6	3,9	3,7	3,5	32,0			
34,0										3,7	3,5	3,3	3,0	34,0		
36,0										3,3	3,1	2,9	2,6	36,0		
38,0											2,7	2,5	2,2	38,0		
40,0												2,4	2,2	1,9	40,0	
42,0													1,9	1,6	42,0	
44,0														1,6	1,3	44,0
46,0															1,1	46,0
48,0															0,9	48,0

\* Over rear with special equipment • Nach hinten mit Sonderausrüstung • En arrière avec équipement supplémentaire • Per la parte traserà con equipò adicònal  
 Sul posteriore con equipaggiamento ausiliario • Наò задней частью со специальным оборудованием

	Infinitely variable • Stufenlos • Progressivement variable • Infinitamente variable • Infinitamente variabile • Плавно-изменяемый	Rope • Seil • Câble • Cable Fune • Канат	Max. Single line pull • Max. Seilzug • Effort maxi au brin simple • Tiro máximo por ramal • Tiro max. per singola fune • Макс. натяжение каната
	0 - 120 m/min Single line • Einfacher Strang • Brin simple • Ramal simple Tiro a fune singola • Однократная запасовка	16 mm/220 m	50 kN
	0 - 120 m/min Single line • Einfacher Strang • Brin simple • Ramal simple Tiro a fune singola • Однократная запасовка	16 mm/220 m	50 kN
	-3,0° to +82° approx. 45 s • ca. 45 s • env. 45 s • aproximadamente 45 s aproximadamente 45 s • примерно 45 с		11,3 to 51,0 m approx. 335 s • ca. 335 s • env. 335 s • aproximadamente 335 s aproximadamente 335 s • примерно 335 с