

# HYDRAULIC CRAWLER CRANE

# **7250**

**Crawler Crane**

Max. Lifting Capacity:

**250t at 4.6m**

**Luffing Tower**

Max. Lifting Capacity:

**25t at 18.0m**

# Technology and Power, KOBELCO Takes Pride In

## *Hydraulic Crawler Crane 7250 Now Ready to Launch*

Kobelco's hydraulic crawler crane 7250 has taken advantage of new technologies to raise its performance to new heights. Precision and high-elevation crane jobs depend on accuracy and speed, whereas heavy-lifting depends on trustworthy power and strength.

The perfect answer comes in our new 7250. Hoist winches with powerful linepull are designed to handle the toughest jobs. Large drum capacities combined with a new hydraulic system promote ultra-smooth operation. Excellent transportation features enable cost saving.

Of course, Kobelco is renowned for its engineered technology backed with long and worldwide experience, therefore productivity-boosting technical advances can be found everywhere. With the lifting performance, transportation features, smooth control functions, safety features, also durability and reliability, the 7250 can handle and satisfy all types of crane jobs. Kobelco is proud to announce the new 7250 crawler crane.







## **Hydraulic Crawler Crane 7250 5 Major Features**

**1. Massive and Versatile  
Lifting Performance**

---

**2. Smooth Operation and Control**

---

**3. Excellent Cab with Enhanced Functions**

---

**4. Excellent Transportability and Assembly**

---

**5. Safe, Environmentally-Conscious  
Design**

---

For both high and heavy lifting

# Massive and Versatile Lifting Perf

## *Large Lifting Capacity*

Max. lifting capacity

**250t at 4.6m**

Max. crane boom length

**76.2m**

## *Long Boom Configuration to Achieve Wide Working Ranges*

The long boom specification provides a wider operating range with plenty of lifting capacity. The long boom can be made up of insert boom and tower insert jib, to make economic use of attachment components.

Long boom length

**73.2m to 91.4m**

Lifting capacity at the max. working radius

**3.2t at 78.1m**

(Using the 88.4m long boom)

## *Large Working Ranges with Fixed Jib Configuration*

The fixed jib specification have allowed work in higher and deeper sites.

Max. combination (crane boom + fixed jib)

**76.2m + 30.5m**

Lifting capacity at the max working radius

**2.4t at 88.0m**

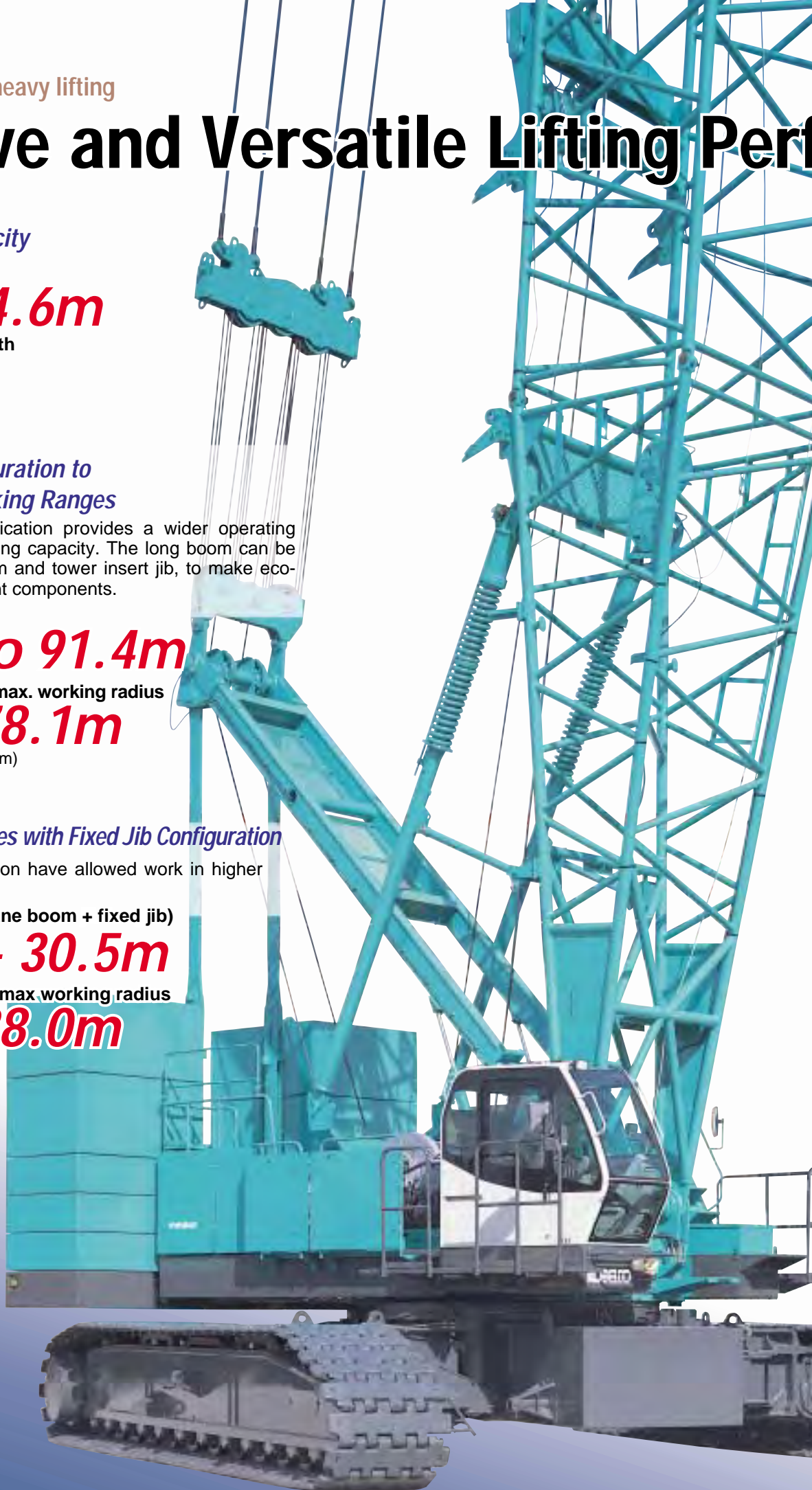



# formance

## High-Output Engine

The engine has an impressive rated output of 247 kW and complies with NRMM (Europe) Stage IIIA and US EPA Tier III exhaust emissions regulations. All of this power works with KOBELCO's unique Engine Speed Sensing (ESS) control system and new hydraulic systems to ensure stable and smooth simultaneous operations.

Engine output **247 kW**  
Meets NRMM (Europe) Stage IIIA



## High-Speed Lifting Increases Work Efficiency

The main and auxiliary winches deliver a fast maximum hoisting and lowering speed of 110 m/min that improves operational efficiency on high-rise jobs.

Max. line speed  
**110m/min** (First layer)

## New Crawler Design Improves Performance

Large crawlers have been added to further improve stability, while keeping the tail swing radius to just 5,850 mm. The result is a machine with great lifting capacity that can operate in a minimum of onsite space.

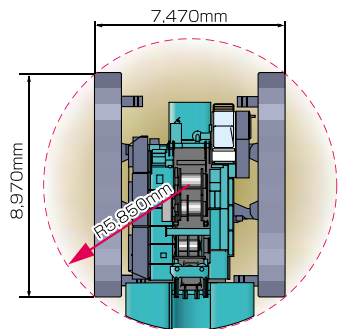

## High-Performance Winches Accommodate a Wide Range of Jobs

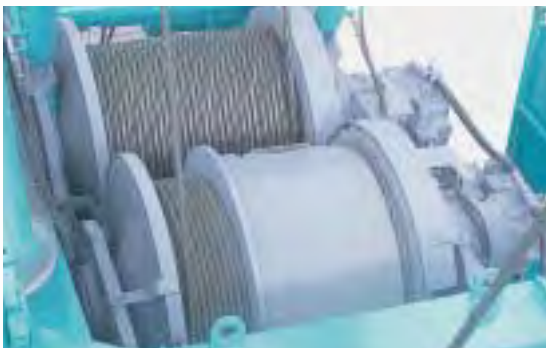

The winch shown in this photo is for tower jib specification.

## Wide and Large Capacity Winches

The wide hoist winches provide an impressive spooling capacity of 53 m on the first layer with 28 mm hoist rope. Their large capacity and large diameter help to prevent uneven spooling and wear while ensuring smooth operation when using a long boom for high-rise work.

Spooling capacity (first layer) **53m**

## Winches with a Powerful Line Pull Handle Hard Work with Ease

Through the efficient match-up of a high-output engine and high-performance hydraulic motors, the winches deliver plenty of line pull for single-line work. There's also ample capacity for heavy loads when they first clear the ground, and other tough jobs.

Rated line-pull (main/aux.)

Single line **132kN {13.5tf}**

## Choice of Two Types of Winch

The 7250 features non free-fall winches as standard that provides constant hydraulic power to the winches to prevent accidental free-fall through operator error. An optional free-fall winch (with wet-type disc brake) is also available, which delivers highly reliable performance for material handling and general foundation work.

### Non Free-fall Winch (Standard)

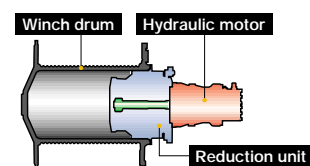

### Wet-Type Disc Brake System (Optional)

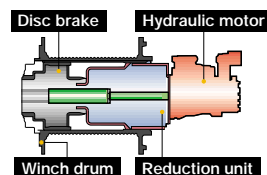

KOBELCO's new oil-cooled wet-type multi-disc brake system is first in its class and provides quiet, dependable braking power. The multiple discs are self-adjusting and self-equalizing. Forced-oil circulation keeps brake temperatures cooler during long, continuous operations and ensures smooth braking. The completely enclosed system eliminates the possibility of outside contamination, providing years of problem-free service life. In optional free-fall mode, the brake pedal is easily depressed to reduce operator fatigue.

For greater work efficiency

# Smooth Operation and Control

## New Hydraulic System Improves Simultaneous Operations

In case of luffing tower operation, the aux winch is used for jib hoisting. And the line speed reduction occurs by main hoist-lower and jib hoist-lower combined operation due to hydraulic pressure interference with conventional series hydraulic circuit (conflux hydraulic circuit).

The 7250 adopts one-pump to one-motor system (independent hydraulic circuit) for main, aux hoist and boom hoist. This is completely interference-free hydraulic circuit to perform smooth combined operation of main, aux, boom and jib hoist-lowering without any shocks and speed reduction in all ranges of winch speed and load condition.

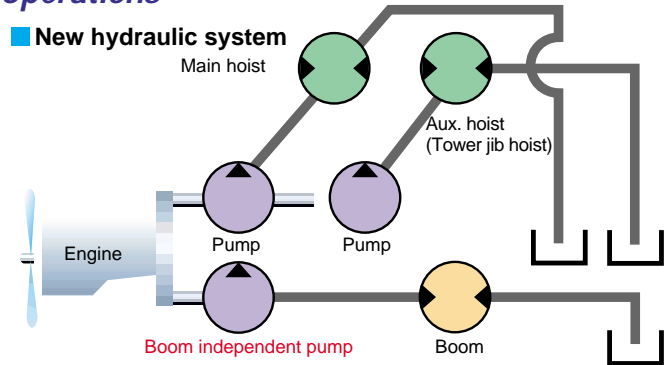

## Selectable Swing Modes to Match the Job at Hand

### ■ Free Swing Mode (High/Low):

This mode is designed for material handling and other cycle-duty operations that require consecutive swing cycles. The swing is completely free and can be operated at High or Low speed to suit job requirements.

### ■ Neutral Brake Swing Mode:

When the crane is working on a slope in Free Swing Mode, it may swing in an unintended direction as soon as the swing parking brake is released. To prevent this, the Neutral Brake Swing Mode reduces operating speeds by lowering the flow of oil in the hydraulic circuit, thus making swing starts and stops easy to control when working on a slope or in windy conditions.

Swing speed is also reduced in this mode to prevent the load from moving sideways.



## Control Levers Connected Directly to Pilot Valves for Smooth Operation

The control levers regulate the pilot valves directly to reduce the amount of play and ensure smooth, precise hoisting start-ups and inching. Control is light and sure, with almost no clatter even over long operating periods.

## Winch Speed Controller

The speeds of the main winch, auxiliary winch and boom hoist can be set independently with trimmer controls.



■ Hydraulic pilot system detects swing reaction force.

■ Electric throttle with a twist grip ensures sensitive engine control.

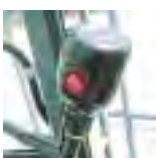

■ Red switch on the boom lever grip allows easy inching control for hoist, boom hoist, and travel. The operator can activate it without taking his hands off the boom hoist lever.

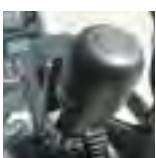

■ The drum turning sensor enables sensing start of hoisting and lowering (main and aux winches only) by touching the top of the hoisting lever grip (optional).

