

# UNI-T® 优利德®



## UT181A 使用手册 Operating Manual

真有效值数据记录万用表  
True RMS Datalogging  
Multimeters



P/N: 110401105261X  
MAY.2018 REV. 4

**UNI-T®**

**UT181A  
使用说明书**

## 序 言

尊敬的用户：

您好！感谢您选购全新的优利德仪表，为了正确使用本仪表，请您在本仪表使用之前仔细阅读本说明书全文，特别有关“安全注意事项”的部分。如果您已经阅读完本说明书全文，建议您将此说明书进行妥善保管，以便在将来的使用过程中进行查阅。

### 有限担保和有限责任

优利德公司担保本产品自购买之日起一年内，在材料和工艺上均无任何缺陷。本担保不适用于保险丝，一次性电池，或由于意外、疏忽、误用、改装、污染及非正常操作或处理引起的损坏。经销商无权以优利德的名义给予其它任何担保。如在保修期内需要保修服务，请与您就近的优利德授权服务中心联系，获得产品退还授权信息；然后将产品寄至该服务中心，并附上产品问题描述。本项担保是您能获得的唯一补偿。除此以外，优利德不提供任何明示或隐含的担保，例如适用于某一特殊目的的隐含担保。同时，优利德不对基于任何原因或推测而导致的任何特殊、间接、附带或继起的损坏或损失负责。由于某些地区或国家不允许对默示担保及附带或继起的损坏加以限制，故上述的责任限制与规定或许对您不适用。

## 目 录

一、概述-----	1	13、低通滤波-----	18
二、开箱检查-----	1	14、dBV-----	18
三、安全操作准则-----	1	15、dBm-----	18
四、电气符号-----	2	16、最大值最小值-----	18
五、外表结构-----	3	17、相对值-----	19
六、LCD显示屏-----	3	18、峰值检测-----	19
七、按键、旋钮开关和输入端子-----	4	19、比较模式COMP-----	19
八、技术指标-----	5	20、记录测量数据-----	19
1、一般规格-----	5	21、通讯-----	22
2、电气规格-----	5	十、保养和维护-----	23
九、测量操作说明-----	9	1、一般维护和维修-----	23
1、控制仪表电源-----	9	2、测试保险丝-----	23
2、仪表设置选项-----	10	3、更换保险丝-----	24
3、交流电压-----	10	4、电池充电-----	24
4、直流电压-----	12		
5、交直流电流-----	13		
6、电阻-----	14		
7、电导-----	14		
8、电容-----	15		
9、通断测量-----	16		
10、二极管-----	16		
11、频率/占空比测量/脉冲宽度-----	17		
12、温度-----	17		

### 一 概述

UT181A是60000计数4 5/6数位、自动量程便携式手持式真有效值智能万用表(以下简称仪表)。整机电路设计以大规模集成电路 $\Sigma/\Delta$ 模数转换器为核心,全量程的过载保护电路,独特的外观设计使之成为性能优越的专用电工仪表。可用于测量交直流电压、交直流电流、电阻、电导、二极管、电路通断、电容、温度、频率、脉冲宽度等参数,并具有数据保持、最大值/最小值/平均值测量、比较功能测量、相对值测量、峰值检测、趋势图捕捉、多达20000条数据记录/回读功能。

本使用说明书包括有关的安全信息和警告提示等,请仔细阅读有关内容并严格遵守所有的警告和注意事项。



**警告:**

在使用仪表之前,请仔细阅读有关“安全操作准则”。

打开包装盒,取出仪表,请仔细检查下列项目是否缺少或损坏:

### 二 开箱检查

1. 使用说明书-----一本
2. 表笔-----一付
3. K型温度探头-----二条
4. 温度转接座-----一个
5. 充电适配器-----一个
6. 充电转接座-----一个
7. USB传输线-----一条
8. 光盘-----一张
9. 布包-----一个
10. 保用证-----一张

如果发现任何一个项目缺少或损坏,请立即与您的供应商进行联系。

### 三 安全操作准则

请注意“警告标识及警告字句”。警告表示对使用者构成危险,对仪表或被测设备可能造成损坏的情况或行为。

本仪表设计符合IEC/EN61010-1、EN61010-2-030污染2级、过电压CATIII 1000V、CAT IV 600V和双重绝缘的安全标准;符合防水防尘IP65标准。如果未能按照有关的操作说明使用仪表,则可能会削弱或失去仪表为您提供的保护能力。

1. 切勿使用已损坏的仪表。使用仪表之前,请检查仪表的外壳,检查是否有裂纹或缺少塑胶件,特别注意接头周围的绝缘层。
2. 使用仪表之前,请确定电池盖已经闭合并且扣紧。打开电池盖之前,请先取下仪表上的测试导线。
3. 检查测试导线的绝缘层是否损坏或导线金属是否裸露在外。检查测试导线是否导通。若导线有损坏,请更换以后再使用仪表。
4. 端子或任何一个端子与接地点之间施加的电压不能超过仪表上标示的额定值。
5. 在外盖取下或机壳打开时,请勿使用仪表。
6. 对30V交流(有效值),42V交流(峰值)或60V直流以上的电压,应格外小心,这类电压有造成触电的危险。
7. 必须使用本手册指定规格的替换保险丝。
8. 测量时,必须使用正确的端子、功能档和量程档。不要单独工作。
9. 测量电流时,应先切断电路的电源,再把仪表连接到电路上。记住:仪表必须和电路串联。
10. 在电气连接时,先连接公共测试导线,然后才连接主测试导线;拆线时,先拆除主测试导线,然后再拆除公共测试导线。

## UT181A使用说明书

11. 若仪表工作失常，请勿使用。仪表的保护措施可能已经失效。若有疑问，应将仪表送修。
12. 不要在高温、高湿、易燃、易爆和强电磁场环境中存放或使用仪表。
13. 使用探针时，手指应握在在探针护指装置的后面。
14. 不要用低通滤波器选项来验证是否存在危险电压，可能会存在超过指示值的电压。首先，在未连接滤波器的情况下测量电压，以检测是否存在危险电压。然后再选低通滤波功能。
15. 测试电阻、电路通断、电导、二极管或电容器之前，应先切断电路的电源并把所有高压电容器放电。
16. 测量电流之前，应先检查仪表的保险丝。
17. 不要测量高于允许输入值的电压或电流，在不能确定被测量值的范围时，须将功能量程开关置于最大量程位置。
18. 当液晶显示器显示“”标志时，应及时充电，以确保测量精度。
19. 请勿随意改变仪表内部接线，以免损坏仪表和危及安全。
20. 维护保养请使用软布及中性清洁剂清洁仪表外壳，切勿使用研磨剂及溶剂，以防外壳被腐蚀，损坏仪表、危及安全。
21. 如果要更换表笔时则需用同样等级CAT III 1000V/CAT IV 600V或更高等级的表笔替代。



## 危险电压

当仪表检测到 $\geq 30V$ 或电压过载(OL)时，会显示“”符号，作为存在潜在危险电压的警告。

## 四 电气符号

	双重绝缘
	接地
	警告提示
	AC(交流)
	DC(直流)
	蜂鸣通断
	二极管
	电容
	AC或DC(交流或直流)
	高压危险
	符合欧洲共同体(European Union)标准
	符合ETL标准

### 五 外表结构 (见图1)

1.	外壳
2.	LCD显示屏
3.	功能按键
4.	旋钮开关
5.	测量输入端

### 六 LCD显示屏 (见图2)

项目	功能	说明
1	功能键标签	表示当前测量界面下的辅助功能
2	模拟条	模拟显示输入信号
3	负号	表示负读数
4	闪电符号	高压危险
5	时间日期	表示内部时钟设置的时间和日期
6	小测量值	若主显示屏和辅助显示屏被菜单或弹出信息遮盖住了, 显示实时输入值。
7	远程通信	表示该仪器的USB/蓝牙功能已打开
8	蜂鸣器	表示开启按键声音 (与通断性测试报警无关)
9	电池电量	表示充电电池的电量水平
10	量程指示符	表示仪表当前所处的量程及量程模式 (自动或手动)
11	单位	表示测量单位
12	辅助功能显示	表示辅助测量功能, 例如低通滤波
13	辅助显示屏	显示关于输入信号的辅助测量信息。

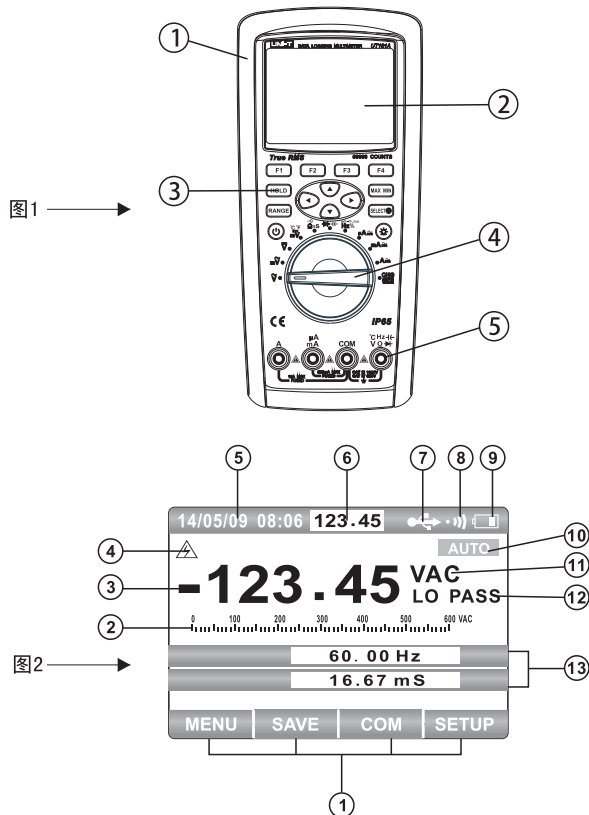

### 七、按键、旋钮开关和输入端子

#### (1) 按键

仪表上的14个按键用于激活可扩充用旋钮开关选定的功能的特性、浏览菜单或控制仪表电路的电源。图3所示的按键于下列表中作了说明。

按键	功能
	开启或关闭仪表电源
F1 F2 F3 F4	选择与旋钮开关功能档相关的子功能和模式。
	光标键用于选择菜单项，滚读信息，及执行数据输入
HOLD	保持显示屏中的当前读数
RANGE	将仪表量程模式切换至手动模式，然后依次在所有可用量程之间变换。长按此键，可返回自动量程测量。
MAX MIN	开始 MIN MAX（最小值最大值）记录
SELECT	短按选择档位的复合功能。长按进入帮助菜单。
	短按此键切换背光亮度，长按此键关闭背光。



图3



图4

#### (2) 旋钮开关（见图4）

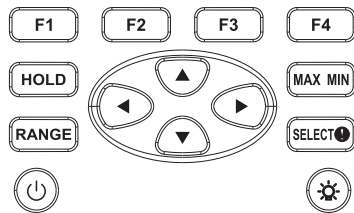
旋钮	功能
$\tilde{V}$	交流电压测量
$m\tilde{V}$	交流毫伏测量和交流合并直流(AC+DC)毫伏
$\bar{V}$	直流(DC)和交流合并直流(AC+DC)电压测量
$m\bar{V} \text{ } ^\circ\text{C} \text{ } ^\circ\text{F}$	直流毫伏和温度测量
$\Omega$ ns-  )	电阻、通断性和电导系数测量
$\rightarrow$  ←	二极管测试和电容测量
Hz% mS-Pulse	频率、占空比和脉冲宽度测量
$\mu\text{A} \approx$	交流(AC)直流(DC)和交流合并直流(AC+DC)微安测量
$\text{mA} \approx$	交流(AC)直流(DC)和交流合并直流(AC+DC)毫安测量
$\text{A} \approx$	交流(AC)直流(DC)和交流合并直流(AC+DC)安培测量
CHG	电池充电

#### (3) 输入端子

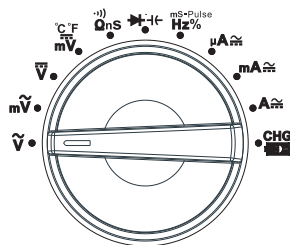
端子	描述
A	测量0A至10.00A电流(20A过载最长持续30秒，再中断10分钟)和频率的输入端子
mA $\mu$ A	测量0A至600mA电流和频率的输入端子
COM	用于所有测量的公共端子
$V \Omega \rightarrow$  ← CHz- ←	测量电压、通断性、电阻、二极管测量、电导、电容、频率、周期和占空比的输入端子

除上述之外，充电功能和温度测量功能通过相应的转接座使用四个端子。如果表笔误插错，显示屏会显示“Lead Error!”以示警告。



### 八. 技术指标

#### 1. 一般规格

任何端子和接地之间的最高电压: 1000V  
 mA或 $\mu$ A输入端子的保险丝保护: 0.8A H 1000V快熔式 6×32mm  
 A输入端子的保险丝保护: 10A H1000V快熔式10×38mm  
 最大显示: 60000  
 量程: 自动/手动  
 极性: 自动  
 工作温度: -20℃~50℃  
 储存温度: -30℃~60℃  
 相对湿度:  $\leq 80\%$  (0℃~30℃),  $\leq 75\%$  (30℃~40℃),  $\leq 45\%$  (40℃~50℃)  
 电磁兼容性: 在1V/m的射频场下: 总精度=指定精度+量程的5%, 超过1V/m以上的射频场没有指定指标。  
 工作海拔高度: 0~2000m  
 温度系数: 0.1X (指定准确度)/℃ (<18℃ 或 >28℃)  
 机内电池: 锂电池 7.4V 2200mAh  
 电源适配器: 输入100V~240V, 50/60Hz 0.2Amax输出DC10V 500mA (有输出短路保护) 外径5.5mm 内径2.5mm  
 电池不足: LCD显示“”符号  
 外形尺寸: 约(225×100×60)mm  
 重量: 约608g (包括电池)  
 安全标准: IEC/EN61010-1、EN61010-2-030污染2级、CAT III 1000V、CAT IV 600V  
 防水防尘标准: IP65

#### 2. 电气规格

准确度:  $\pm$  (%读数+字数), 校准期为一年; 若环境温度变化达到 $\pm 5^\circ\text{C}$ , 准确度在2小时后方可采用。  
 电池充电完成后, 准确度在2小时后方可采用。  
 环境温度: 23℃ $\pm$ 5℃;  
 环境湿度:  $\leq 75\%$  RH;  
 温度系数: 0.1×(准确度)/℃ (<18℃ 或 >28℃)

##### (1) 交流电压

量程	分辨率	误差极限: $\pm$ (% 读数 + 字数)			
60mV	0.001mV	45~1kHz	1k~10kHz	10k~20kHz	20k~100kHz
		$\pm(0.6\%+60)$	$\pm(1.2\%+60)$	$\pm(3\%+60)$	$\pm(4\%+60)$
600mV	0.01mV	45~1kHz	1k~10kHz	10k~20kHz	20k~100kHz
		$\pm(0.3\%+30)$	$\pm(1.2\%+40)$	$\pm(3\%+40)$	$\pm(4\%+40)$
6V	0.0001V	45~1kHz	1k~10kHz	10k~20kHz	20k~100kHz
		$\pm(0.3\%+30)$	$\pm(1.2\%+40)$	$\pm(3\%+40)$	$\pm(4\%+40)$
60V	0.001V	45~1kHz	1k~10kHz	10k~20kHz	20k~100kHz
		$\pm(0.3\%+30)$	$\pm(1.2\%+40)$	$\pm(3\%+40)$	$\pm(4\%+40)$
600V	0.01V	45~1kHz	1k~10kHz	10k~20kHz	20k~100kHz
		$\pm(0.3\%+30)$	$\pm(1.2\%+40)$	$\pm(3\%+40)$	仅供参考
1000V	0.1V	45~1kHz	1k~5kHz	5k~10kHz	10k~100kHz
		$\pm(0.6\%+30)$	$\pm(3\%+40)$	$\pm(6\%+40)$	仅供参考

\*输入阻抗: 约为10M $\Omega$

\*过载保护: 1000V

\*显示: 真有效值, 适用于量程的10%至100%

## UT181A使用说明书

### (2) 直流电压

量程	分辨率	误差极限: $\pm(\% \text{读数} + \text{字数})$
60mV	0.001mV	$\pm(0.025\%+20)$
600mV	0.01mV	$\pm(0.025\%+5)$
6V	0.0001V	
60V	0.001V	
600V	0.01V	$\pm(0.03\%+5)$
1000V	0.1V	

\*输入阻抗: 约为10M $\Omega$

\*过载保护: 1000V

\*60mV档需使用相对模式(REL)功能补偿偏差

### (3) 交流电压+直流电压

量程	分辨率	误差极限: $\pm(\% \text{读数} + \text{字数})$		
		50~1kHz	1k~10kHz	10k~35kHz
60mV	0.001mV	$\pm(1\%+80)$	$\pm(3\%+40)$	$\pm(6\%+40)$
600mV	0.01mV	$\pm(1\%+80)$	$\pm(3\%+40)$	$\pm(6\%+40)$
6V	0.0001V	$\pm(1\%+80)$	$\pm(3\%+40)$	$\pm(6\%+40)$
60V	0.001V	$\pm(1\%+80)$	$\pm(3\%+40)$	$\pm(6\%+40)$
600V	0.01V	$\pm(1\%+80)$	仅供参考	仅供参考
1000V	0.1V	$\pm(1.2\%+80)$	仅供参考	仅供参考

\*输入阻抗: 约为10M $\Omega$

\*过载保护: 1000V

\*显示: 真有效值, 适用于量程的10%至100%.

### (4) 交流电流

量程	分辨率	误差极限: $\pm(\% \text{读数} + \text{字数})$	
		45~1kHz	1k~10kHz
600 $\mu$ A	0.01 $\mu$ A	$\pm(0.6\%+40)$	$\pm(1.2\%+40)$
6000 $\mu$ A	0.1 $\mu$ A	$\pm(0.6\%+20)$	$\pm(1.2\%+40)$
60mA	0.001mA	$\pm(0.6\%+40)$	$\pm(1.2\%+40)$
600mA	0.01mA	$\pm(0.6\%+20)$	$\pm(1.2\%+40)$
10A	0.001A	$\pm(1\%+20)$	$\pm(3\%+40)$

\*显示: 真有效值, 适用于量程的10%至100%.

\*过载保护:  $\mu$ AmA量程: 0.8A H 1000V快熔式保险丝  $\Phi 6 \times 32\text{mm}$

10A量程: 10A H 1000V快熔式保险丝  $\Phi 10 \times 38\text{mm}$

\*20A接通 30秒, 然后停止10分钟, >10A未指定

### (5) 直流电流

量程	分辨率	误差极限: $\pm$ (%读数+字数)
600 $\mu$ A	0.01 $\mu$ A	$\pm$ (0.08%+20)
6000 $\mu$ A	0.1 $\mu$ A	$\pm$ (0.08%+10)
60mA	0.001mA	$\pm$ (0.08%+20)
600mA	0.01mA	$\pm$ (0.15%+10)
10A	0.001A	$\pm$ (0.5%+10)

\*过载保护:  $\mu$ A mA量程: 0.8A H 1000V快熔式保险丝  $\Phi$ 6x32mm  
10A量程: 10A H 1000V快熔式保险丝  $\Phi$ 10x38mm

\*20A 接通30秒, 然后停止10分钟。>10A未指定

### (6) 交流电流+直流电流

量程	分辨率	误差极限: $\pm$ (%读数+字数)	
600 $\mu$ A	0.01 $\mu$ A	50~1kHz	1k~10kHz
		$\pm$ (0.8%+40)	$\pm$ (2.0%+40)
6000 $\mu$ A	0.1 $\mu$ A	50~1kHz	1k~10kHz
		$\pm$ (0.8%+20)	$\pm$ (2.0%+40)
60mA	0.001mA	50~1kHz	1k~10kHz
		$\pm$ (0.8%+40)	$\pm$ (2.0%+40)
600mA	0.01mA	50~1kHz	1k~10kHz
		$\pm$ (0.8%+20)	$\pm$ (2.0%+40)
10A	0.001A	50~1kHz	1k~10kHz
		$\pm$ (1.2%+20)	$\pm$ (3%+40)

\*显示: 真有效值, 适用于量程的10%至100%.

\*过载保护:  $\mu$ A mA量程: 0.8A H 1000V快熔式保险丝  $\Phi$ 6x32mm  
10A量程: 10A H 1000V快熔式保险丝  $\Phi$ 10x38mm

\*20A 接通30秒, 然后停止10分钟。>10A未指定

### (7) 电阻

量程	分辨率	误差极限: $\pm$ (%读数+字数)
600 $\Omega$	0.01 $\Omega$	在REL状态下: $\pm$ (0.05%+10)
6k $\Omega$	0.0001k $\Omega$	$\pm$ (0.05%+2)
60k $\Omega$	0.001k $\Omega$	
600k $\Omega$	0.01k $\Omega$	
6M $\Omega$	0.0001M $\Omega$	$\pm$ (0.3%+10)
60M $\Omega$	0.001M $\Omega$	$\pm$ (2%+10)

\*过载保护: 1000V

\*60M  $\Omega$ 档湿度要求<50%

### (8) 电导

量程	分辨率	误差极限: $\pm$ (%读数+字数)
60nS	0.01nS	$\pm$ (2%+10)

\*过载保护: 1000V

\*湿度要求<50%

## UT181A使用说明书

### (9) 电容

量程	分辨率	误差极限: $\pm$ (%读数+字数)
6nF	0.001 nF	$\pm(3\%+10)$
60nF	0.01nF	$\pm(2.5\%+5)$
600nF	0.1nF	$\pm(2\%+5)$
6 $\mu$ F	0.001 $\mu$ F	
60 $\mu$ F	0.01 $\mu$ F	
600 $\mu$ F	0.1 $\mu$ F	
6mF	1uF	$\pm(5\%+5)$
60mF	10uF	未指定

\*过载保护:1000V

\*显示位数:6000

### (10) 温度

量程	分辨率	准确度
-40°C~40°C	0.1°C	$\pm(2.0\%+30)$
40°C~400°C		$\pm(1.0\%+30)$
400°C~1000°C		$\pm 2.5\%$
-40°F~104°F	0.2°F	$\pm(2.5\%+50)$
104°F~752°F		$\pm(1.5\%+50)$
752°F~1832°F		$\pm 2.5\%$

\*过载保护:1000V

\*使用温度转接座,可进行双通道温度测量

\*温度传感器:适用K型(镍铬~镍硅)热电偶,配件为点式K型(镍铬~镍硅)热电偶仅适用于230°C以下温度的测量。

### (11) 频率

量程	分辨率	准确度
60Hz	0.001 Hz	$\pm(0.02\%+8)$
600Hz	0.01 Hz	$\pm(0.01\%+5)$
6kHz	0.0001kHz	
60kHz	0.001kHz	
600kHz	0.01kHz	
6MHz	0.0001MHz	
60MHz	0.001MHz	

\*过载保护:1000V

\*输入幅度要求: 10Hz~30MHz:  $600\text{mV} \leq a \leq 30\text{V}_{\text{rms}}$ ,  
大于30MHz:未指定

### (13) 占空比

量程	分辨率	误差极限: $\pm$ (%读数+字数)
10%~90%(10Hz~2kHz)	0.01%	$\pm(1.2\%+30)$

\*过载保护: 1000V

\*上升时间 < 1  $\mu$ s 时,信号以触发电平为核心。

### (14) 脉冲宽度

量程	分辨率	误差极限: $\pm$ (%读数+字数)
250mS	0.001mS~0.01mS	$\pm(1.2\%+30)$

\*过载保护:1000V

\*上升时间 < 1  $\mu$ s 时,信号以触发电平为核心。

\*10Hz至200kHz, 脉冲宽度 > 2  $\mu$ s。脉冲宽度范围由信号的频率决定。

### (15)通断测试

量程	分辨率	备注
	0.01Ω	开路电压约为3V; 当蜂鸣器选择短路发声警告时,为<10Ω, 蜂鸣器连续发声,>50Ω, 蜂鸣器不发声。 当蜂鸣器选择开路发声警告时,为>50Ω, 蜂鸣器连续发声,<10Ω, 蜂鸣器不发声。

\*过载保护: 1000V



### (16)二极管测试



量程	分辨率	备注
	0.0001V	开路电压约3V, 可测量PN结约≤3V正向压降。当启动蜂鸣器时,对正常半导体结,它会发出短暂哔声;如果半导体结短路,它会连续发声。硅PN结正常电压值约为0.5~0.8V。

\*过载保护: 1000V

## 九.测量操作说明

### 1. 控制仪表电源

- 1) 手动启动和关闭仪表电源  
在仪表关闭时, 长按  可启动仪表。在仪表打开时  长按可将其关闭。  
仪表在充电时无法关机。
- 2) 电池电量指示符  
仪表用锂电池供电, 电池电量指示符位于显示屏的右上角, 它指示电池的相对情况。下表对指示符所代表的各种电池电量作了说明。

含义	电池容量
	满容量
	1/2容量
	已空

当电池电量低于3%容量时, 仪表会自动关机。

- 3) 控制背照灯  
如果在光线不足的情况下看不清显示屏, 短按可切换背光亮度。长按此键关闭背光, 进入省电模式, 背光关闭时绿色指示灯会闪烁, 指示仪表仍在采集数据, 短按任意按键或转动旋钮开关可重新打开背光。
- 4) 自动关机  
在仪表设置选项“**AUTO POWER SAVE**”菜单栏“**POWE OFF**”一项设置的时间内如果没有转动旋钮开关或按键动作, 仪表会自动关机, 长按  将重新启动仪表。当“**POWE OFF**”一项设置为OFF, 自动关机将完全禁止。
- 5) 仪表省电模式  
通过仪表设置“**AUTO POWER SAVE**”菜单栏设置背光亮度自动降低的调节时间和显示器关闭的时间来达到省电模式。  
请参阅仪表设置选项详细说明。

## UT181A使用说明书

## 2. 仪表设置选项

按功能键SETUP(菜单)可设置和查看仪表相关信息,按光标键用于选择以下仪表相关菜单项信息。



## 1) Keypad Tone

设置为ON,开启按键声音,设置为OFF,关闭按键声音同时右上角蜂鸣器符号“”会随开启出现或关闭消失。





## 2) Lead Alarm Buzzer

设置为ON,启动表笔误插错报警发声,设置为OFF,关闭表笔误插错报警发声。





## 3) Communication

设置为ON,启动USB或蓝牙通讯,左上角会显示“”符号。设置为OFF,关闭USB或蓝牙通讯,左上角“”符号会消失。

## 4) Date &amp; Time

按功能键SET(菜单)可设置仪表内部日期和时间,按或可以选择需要编辑的位置,按或可以输入不同的数字。再按功能键OK(菜单)确认。如要取消设置,可按功能键CANCEL(菜单)。

## 5) AUTO POWER SAVE

按功能键SET(菜单)可设置仪表背光亮度自动降低调节时间、显示器关闭时间和自动关机时间,按或移动光标选择不同的项目,按或可以输入该项目省电模式的时间,单位为分钟。



菜单项	说明	设置值
Brightness Down	背光亮度自动降低调节时间	ON:1-60 Min OFF:禁用此项功能
Display Off	显示器关闭时间	ON:1-60 Min OFF:禁用此项功能
Power Off	自动关机时间	ON:1-60 Min OFF:禁用此项功能

以上设置须按功能键OK(菜单)确认。如要取消设置,可按功能键CANCEL(菜单)。

## 6) More Settings其它更多的设置选项

按功能键ENTER(菜单)可设置帮助信息的语言,内存格式化,重置仪表设置选项,查询产品型号、序列号和可用内存空间。按光标键用于选择以下仪表相关菜单项信息。

## ● Help Menu Language

按功能键SET(菜单)可设置帮助信息的语言,按或可选择不同的语言。再按功能键OK(菜单)确认。如要取消设置,可按功能键CANCEL(菜单)。

## ● Memory Format

按功能键FORMAT(菜单)进入内存格式化,再按功能键YES(菜单)确认。如要取消格式化,可按功能键NO(菜单)。



## ● Reset All Setting

按功能键RESET(菜单)可将设置菜单重置为默认值,再按功能键YES(菜单)确认。如要取消重置,可按功能键NO(菜单)。

## ● About

按功能键ABOUT(菜单)可将查询产品型号、序列号和可用内存空间。

## 3. 交流电压

- 1) 将红表笔插入“V”插孔,黑表笔插入“COM”插孔。
- 2) 将仪表的旋钮开关转到或,如图5将表笔并联到待测电源或负载上
- 3) 从显示器上直接读取被测电压值,交流测量显示真有效值。
- 4) 按功能键MENU(菜单)打开其中一个可用于修改基本交流电压测量的菜单项的菜单,按光标键用于选择菜单项,红色光标表示被选中项,再按F1键进入相应的测量模式,F2可进入相对值测量,F3可设置dbm电阻,按F4关闭该附加功能窗口。

注意:

- 不要输入高于1000V的电压。测量更高的电压是有可能的,但有损坏仪表的危险。
- 在测量高电压时,要特别注意避免触电。
- 在完成所有的测量操作后,要断开表笔与被测电路的连接。
- AC转换是用AC耦合真有效值响应方式,以正弦波输入校正,非正弦波的准确度必须依据如下的调整:波峰因素1.4~2.0,则准确度为需加1.0%

波峰因素2.0~2.5, 则准确度为需加2.5%  
波峰因素2.5~3.0, 则准确度为需加4.0%



图5

#### 4. 直流电压

- 1) 将红表笔插入“V”插孔，黑表笔插入“COM”插孔。
- 2) 将仪表的旋钮开关转到直流V档或直流mV档或，如图6，将表笔并联待测电源或负载上
- 3) 从显示器上直接读取被测电压值。
- 4) 按功能键MENU(菜单)打开其中一个可用于修改基本直流电压测量的菜单项的菜单，按 $\odot$ 光标键用于选择菜单项，红色光标表示被选中项，再按F1键进入相应的测量模式，F2可进入相对值测量，按F4关闭该附加功能窗口。

#### ⚠ 注意：

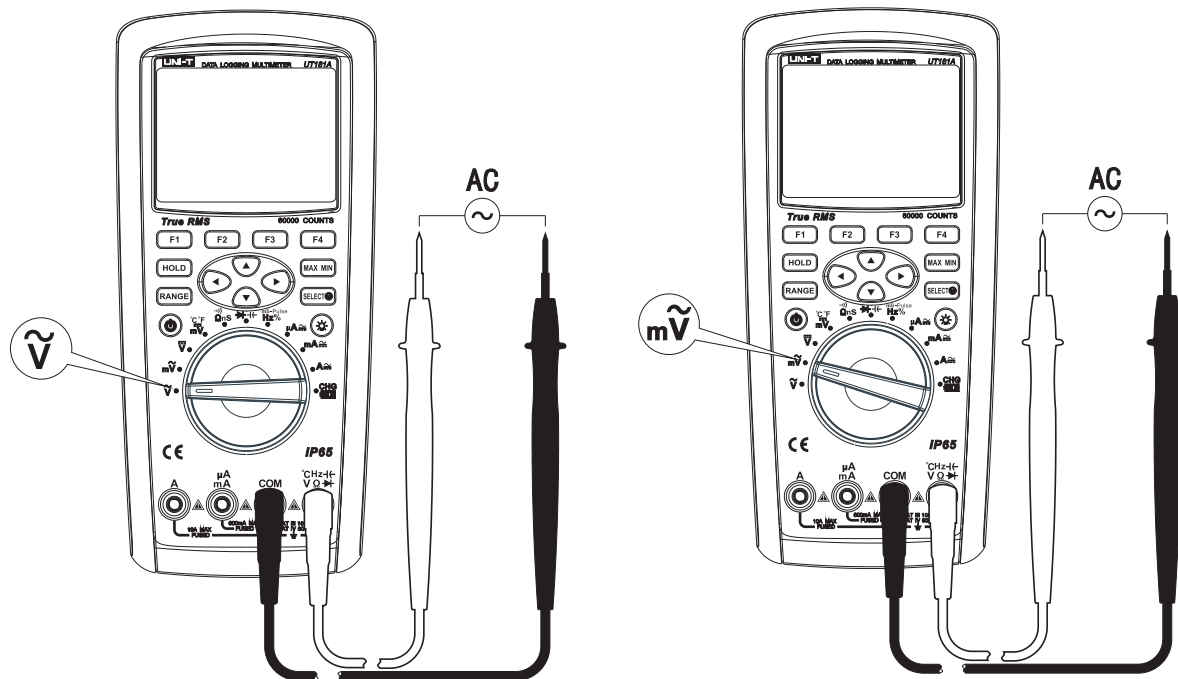
- 不要输入高于1000V 的电压。测量更高的电压是有可能的，但有损坏仪表的危险。
- 在测量高电压时，要特别注意避免触电。
- 在完成所有的测量操作后，要断开表笔与被测电路的连接。

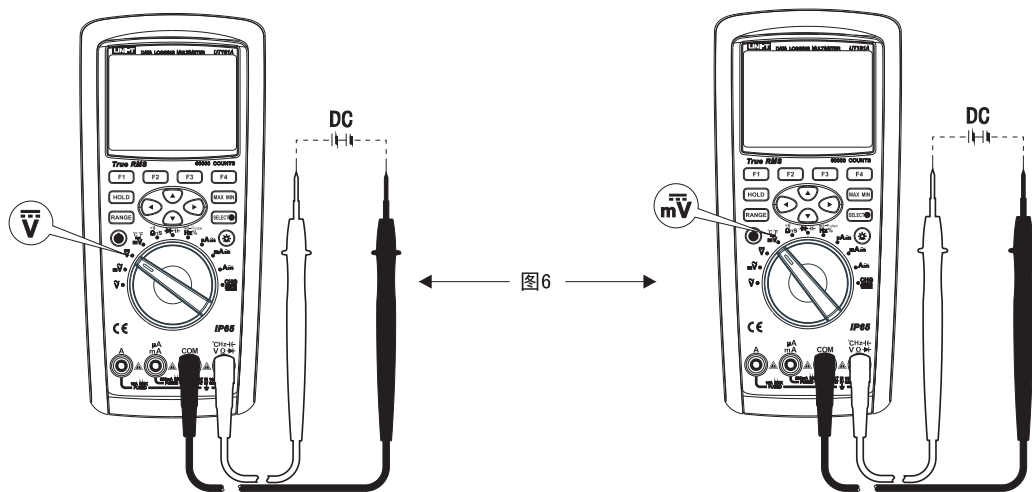



### 5. 交直流电流

- 1) 将红表笔插入“ $\mu A$  mA”或“A”插孔，黑表笔插入“COM”插孔。
- 2) 将仪表的旋钮开关转到图7，按SEECT键选择所需测量的交流或直流，将仪表表笔串联待测回路中。
- 3) 从显示器上直接读取被测电流值，交流测量显示真有效值。
- 4) 按功能键 MENU(菜单)打开其中一个可用于修改基本交直流电流测量的菜单项的菜单，按 $\odot \otimes \odot$ 光标键用于择菜单项，红色光标表示被选中项，再按F1键进入相应的测量模式，F2可进入相对值测量，按F4关闭该附加功能窗口。

#### ⚠ 注意：

- 在仪表串联到待测回路之前，应先将回路中的电源关闭，把所有高压电容器放电。
- 测量时应使用正确的输入端口和功能档位，如不能估计电流的大小，应从大电流量程开始测量。
- 当表笔插在电流输入端口上时，切勿把表笔测试针并联到任何电路上，会烧断仪表内部保险丝和损坏仪表。
- 在完成所有的测量操作后，应先断开电源再断开表笔与被测电路的连接。



图7

## UT181A使用说明书

## 6. 电阻

- 1) 将红表笔插入“ $\Omega$ ”插孔，黑表笔插入“COM”孔。
- 2) 将仪表的旋钮开关转到“ $\Omega$ nS”测量档，默认当前为电阻测量 $\Omega$ 档，如图8，将表笔并联到被测电阻两端。
- 3) 从显示器上直接读取被测电阻值。

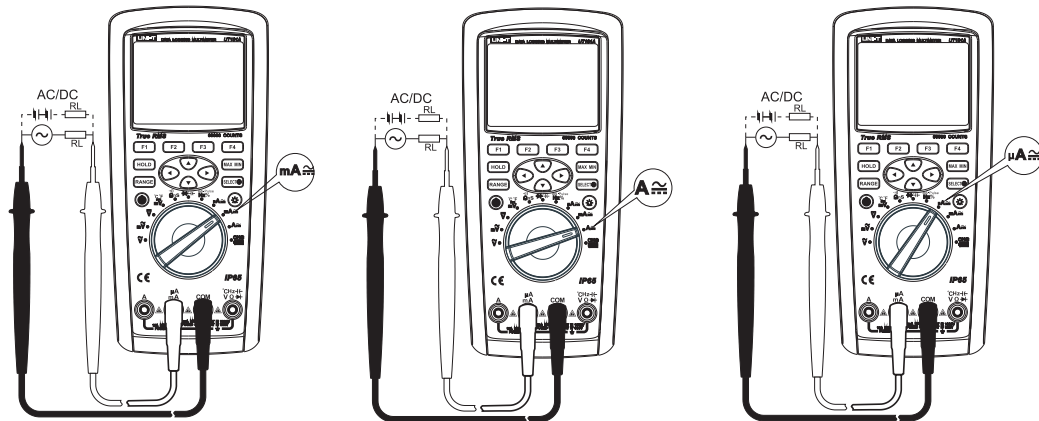
## △ 注意：

- 如果被测电阻开路或阻值超过仪表最大量程时，显示器将显示“OL”。
- 当测量在线电阻时，在测量前必须先将被测电路内所有电源关断，并将所有电容器放尽残余电荷。才能保证测量正确。
- 在低阻测量时，表笔会带来约 $0.1\Omega\sim 0.2\Omega$ 电阻的测量误差。为获得精确读数可以利用相对测量功能，首先短路输入表笔再按MENU再按F2进入相对值测量，待仪表自动减去表笔短路显示值后再进行低阻测量。
- 如果表笔短路时的电阻值不小于 $0.5\Omega$ 时，应检查表笔是否有松脱现象或其它原因。
- 测量 $1M\Omega$ 以上的电阻时，可能需要几秒钟后读数才会稳定。这对于高阻的测量属正常。为了获得稳定读数可用短测试线进行测量。
- 不要输入高于交流(有效值)30V，交流(峰值42V)或直流60V的电压，避免伤害人身安全。
- 在完成所有的测量操作后，要断开表笔与被测电路的连接。

## 7. 电导

- 1) 将红表笔插入“ $\Omega$ ”插孔，黑表笔插入“COM”孔。
- 2) 将仪表的旋钮开关转到“ $\Omega$ nS”测量档，按SELECT键选择电导60nS测量档，如图8，将表笔并联到被测电阻两端。
- 3) 从显示器上直接读取被测电导值。



图8

### ⚠注意:

- 当测量在线电阻时,在测量前必须先将被测电路内所有电源关断,并将所有电容器放尽残余电荷。才能保证测量准确。
- 不要输入高于交流(有效值)30V,交流(峰值42V)或直流60V的电压,避免伤害人身安全。
- 在完成所有的测量操作后,要断开表笔与被测电路的连接。

## 8. 电容

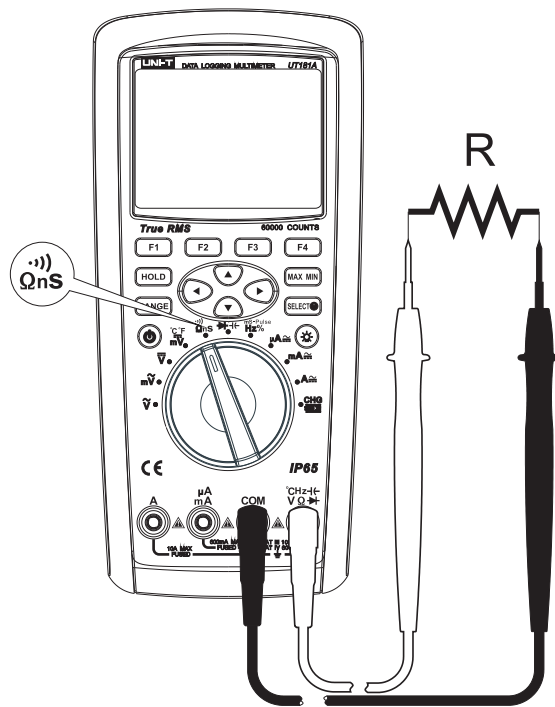
- 1) 将红表笔插入"**←**"插孔,黑表笔插入"COM"孔。
- 2) 将仪表的旋钮开关转到"**←**"测量档,按SELECT键选择电容测量档,如图9,将表笔并联到被测电容两端。
- 3) 从显示器上直接读取被测电容值。

### ⚠注意:

- 如果被测电容短路或容值超过仪表的最大量程时,显示器将显示0L。
- 对于小量程档电容的测量,须采用仪表相对测量REL功能,避免分布电容的影响,便于正确读数。
- 对于大于600 $\mu$ F电容的测量,会需要较长的时间,便于正确读数。
- 为了确保测量精度,建议电容在测试前将电容全部放尽残余电荷后再输入仪表进行测量,对带有高压的电容更为重要,避免损坏仪表和伤害人身安全。
- 不要输入高于交流(有效值)30V,交流(峰值42V)或直流60V的电压,避免伤害人身安全。
- 在完成测量操作后,要断开表笔与被测电容的连接。



图9

## UT181A使用说明书

## 9. 通断测试

- 1) 将红表笔插入“ $\Omega$ ”插孔，黑表笔插入“COM”孔。
- 2) 将仪表的旋钮开关转到“ $\Omega$ ns”测量档，按SELECT键选择通断测试档，如图8，将表笔并联到被测电阻两端。按功能键MENU(菜单)进入菜单项，如按SHORT(菜单)键，则蜂鸣器选择短路发声警告，被测两端之间电阻 $<10\Omega$ ，蜂鸣器连续发声 $>50\Omega$ ，蜂鸣器不发声。如按OPEN(菜单)键，则蜂鸣器选择开路发声警告，被测两端之间电阻 $>50\Omega$ ，蜂鸣器连续发声， $<10\Omega$ ，蜂鸣器不发声。
- 3) 从显示器上直接读取被测电阻值。

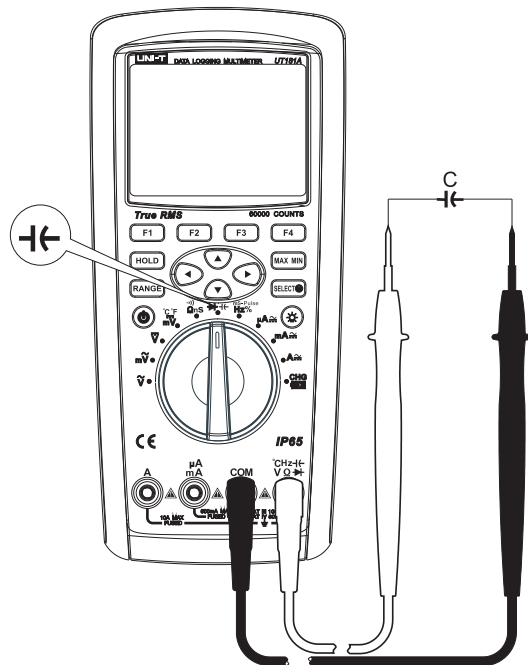
## ⚠ 注意：

- 当测量在线电阻时，在测量前必须先将被测电路内所有电源关断，并将所有电容器放尽残余电荷。才能保证测量正确。
- 不要输入高于交流(有效值)30V，交流(峰值42V)或直流60V的电压，避免伤害人身安全。
- 在完成所有的测量操作后，要断开表笔与被测电路的连接。

## 10. 二极管

- 1) 将红表笔插入“ $\rightarrow$ ”插孔，黑表笔插入“COM”插孔。红表笔极性为“+”，黑表笔极性为“-”。
- 2) 将仪表的旋钮开关转到“ $\rightarrow$ ”测量档，默认为二极管测量模式 $\rightarrow$ 。如图10，将表笔并联到被测二极管两端。从显示器上直接读取被测二极管的近似正向PN结电压。
- 3) 按功能键MENU(菜单)进入菜单项，如按ALARM(菜单)键，则启动蜂鸣器，对正常半导体结，它会发出短暂声音；如果半导体结短路，它会连续发声。硅PN结正常电压值约为0.5~0.8V。如按NORMAL(菜单)键，则不启动蜂鸣器。

## ⚠ 注意：

- 如果被测二极管开路或极性反接时，显示“OL”。

- 当测量在线二极管时，在测量前必须首先将被测电路内所有电源关断，并将所有电容器放尽残余电荷。
- 二极管测试开路电压约为3V。
- 不要输入高于交流(有效值)30V，交流(峰值42V)或直流60V的电压，避免伤害人身安全。
- 在完成所有的测量操作后，要断开表笔与被测电路的连接。



图10

### 11. 频率/占空比测量/脉冲宽度

- 1) 将红表笔插入“V”插孔,黑表笔插入“COM”。
- 2) 将仪表的旋钮开关转到“Hz% ms-Pulse”测量档,按SELECT键选择频率测量档Hz或占空比%或脉冲宽度ms-Pulse,如图11,将表笔并联到待测信号源上。
- 3) 从显示器上直接读取被测频率值或占空比或脉冲宽度。

#### ⚠ 注意:

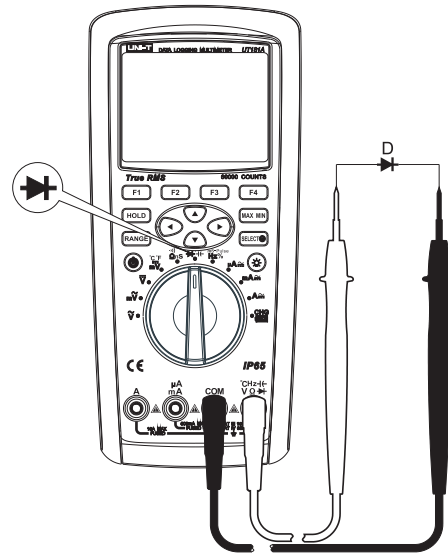
- 在占空比和脉冲宽度功能档时,模拟条显示被测信号的频率。
- 不要输入高于30Vrms被测频率电压,避免伤害人身安全。
- 在完成所有的测量操作后,要断开表笔与被测电路的连接。





图11

### 12. 温度

- 1) 将仪表的旋钮开关转到“mV°C°F”测量档,按SELECT键选择摄氏温度°C或华氏温度°F,图12,将温度转接座插入四个端子,两个温度探头接入温度转接座,探头探测待测物体的表面上。
- 2) 从显示器上直接读取两个被测表面的摄氏温度值或华氏温度值。
- 3) 按功能键 MENU(菜单)打开其中一个可用于修改基本温度测量的F2进入相对模式测量, F4关闭该附加功能窗口,按  光标键用于选择菜单项,红色光标表示被选中项,再按F1键进入相应的测量模式, F2进入相对模式测量, F4关闭该附加功能窗口。

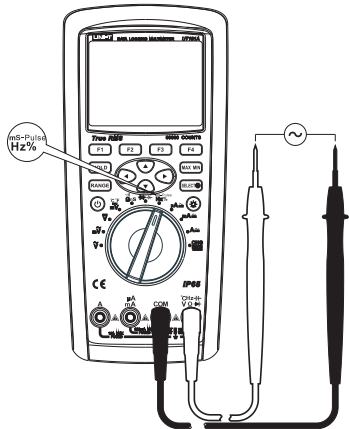
#### ⚠ 注意:

- 仪表所处环境温度不得超出18-28°C范围之外,否则会造成测量误差,在低温环境测量更为明显。
- 在完成所有的测量操作后,取下温度探头。
- 点式K型(镍铬~镍硅)热电偶(仅适用于230°C以下温度的测量)。



图12

## UT181A使用说明书

**13. 低通滤波测量**

- 1) 将红表笔插入“V”插孔，黑表笔插入“COM”插孔。
- 2) 将仪表的旋钮开关转到  $\checkmark$ ，如图5，将表笔并联到待测电源或负载上。
- 3) 按功能键 MENU(菜单)进入菜单项的菜单，按  $\odot \odot \odot$  光标键选择Low Pass菜单项，再按Low Pass功能键(菜单)进入低通滤波测量模式。
- 4) 仪表在交流模式下测量，交流信号要经过一个滤波器，该滤波器会拦截高于1KHz 的电压，如下图所示，低通滤波器可测量由逆变器器和变频电动机产生的复合正弦波上信号。

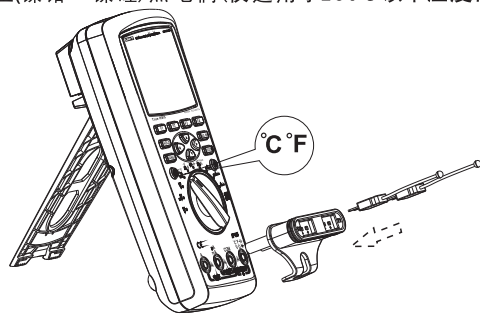
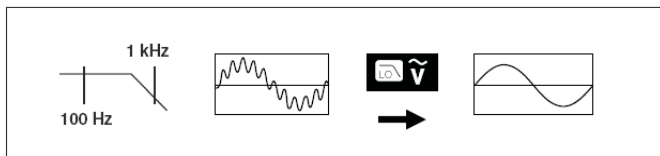
**△ 注意：**

- 为了避免电击或人身伤害，请不要用低通滤波器选项来验证是否存在危险电压，可能会存在超过指示值的电压。首先，在未连接滤波器的情况下测量电压，以检测是否存在危险电压。然后再选滤波功能。
- 在低通滤波测量模式下，仪表将转为手动模式。按RANGE键选量程。在低通滤波器启用时，自动量程不可用。
- 不要输入高于1000V 的电压。测量更高的电压是有可能的，但有损坏仪表的危险。
- 在完成所有的测量操作后，要断开表笔与被测电路的连接。

**14. dBV**

- 1) 将红表笔插入“V”插孔，黑表笔插入“COM”插孔。
- 2) 将仪表的旋钮开关转到  $\checkmark$ ，如图5，将表笔并联到待测电源或负载上。
- 3) 按功能键 MENU(菜单)进入菜单项的菜单，按  $\odot \odot \odot$  光标键选择dBV菜单项，再按dBV功能键(菜单)进入dBV测量。
- 4) 从显示器上主显dBV，副显相应的交流电压值，模拟条显示被测信号的交流电压。

**15. dBm**

- 1) 将红表笔插入“V”插孔，黑表笔插入“COM”插孔。
- 2) 将仪表的旋钮开关转到  $\checkmark$ ，如图5，将表笔并联到待测电源或负载上。
- 3) 按功能键 MENU(菜单)进入菜单项的菜单，按  $\odot \odot \odot$  光标键选择dBm菜单项，dBm 测量必须使用一个参考阻抗(电阻)在1mW的基础上计算dB值。按功能键RES(菜单)，可以选参考阻抗值，按  $\odot$  或  $\odot$ ，在十个定义的参考值之间滚动：4、8、16、25、32、50、75、600、1000和1200。按功能键EDIT(菜单)，通过  $\odot \odot \odot$  光标键，可以选择4 $\Omega$ ~1200 $\Omega$ 任意一个参考阻抗值。按功能键 OK(菜单)设置参考值。按功能键dBm(菜单)进入dBm测量。
- 4) 从显示器上主显dBm，副显相应的交流电压值和参考阻抗值，模拟条显示被测信号的交流电压。

**16. 最大值最小值**

按 MAX MIN 激活最大值最小值测量，主显显示实时测量值，辅助显示最大值、平均值、最小值、三个值对应的测量经过时间和开始日期和时间。按功能键RESTART(菜单)可以重新开始激活最大值最小值测量。按功能键EXIT(菜单)，退出最大值最小值测量。

### 17. 相对值

按功能键 MENU (菜单) 进入下一级界面, 再按功能键REL (菜单) 进入相对值测量模式界面, 再按功能键REL (菜单) 激活相对值测量, 此时主显显示: 测量值-基值, 辅助显示: 相对值和实时测量值。退出相对值测量按MENU (菜单) 选择基本功能测量即可。

### 18. 峰值检测

按功能键 MENU (菜单) 选择Peak选项, 再按功能键PEAK (菜单) 激活峰值检测。响应时间1ms, 使用峰值记录功能可更准确地测量瞬态值。

### 19. 比较模式COMP

按功能键COMP (菜单) 进入比较模式测量, 按  $\odot$  或  $\ominus$  选择如下比较模式设置选项:

#### 1) Pass Mode

按功能键EDIT (菜单) 进入比较类型设置模式, 按  $\odot$  或  $\ominus$  可设置以下四个类型选项中一个。

- INNER (Low Value  $\leq$  输入值  $\leq$  High Value)
- OUTER (输入值  $<$  Low Value 或 输入值  $>$  High Value)
- $<$  Value
- $>$  Value

以上设置须按功能键OK (菜单) 确认。如要取消设置, 可按功能键CANCEL (菜单)。

#### 2) Beep Mode

按功能键EDIT (菜单) 进入启动蜂鸣器模式, 按  $\odot$  或  $\ominus$  可选择以下三个选项中一个。

#### ● PASS ON

此项表示当比较结果显示PASS时, 启动蜂鸣器发声。

#### ● FAIL ON

此项表示当比较结果显示FAIL时, 启动蜂鸣器发声。

#### ● OFF

关闭蜂鸣器

以上设置须按功能键OK (菜单) 确认。如要取消设置, 可按功能键CANCEL (菜单)。

#### 3) Low Value 或 High Value 或 Value

按功能键EDIT (菜单) 可设置比较参考值, 按  $\odot$  或  $\ominus$  移动光标选择编辑的位置, 按  $\odot$  或  $\ominus$  可以输入不同的数字。再按功能键OK (菜单) 确认。如要取消设置, 可按功能键CANCEL (菜单)。

上述设置完成后, 按功能键START (菜单) 启动比较模式测量, 按功能键EXIT (菜单), 退出比较模式测量。

### 20. 记录测量数据

按功能键SAVE (菜单) 可进入单次记录、连续记录和查询记录模式。按  $\odot$  或  $\ominus$  光标键选择如下模式选项。

#### 1) Save

按功能键SAVE (菜单) 单次记录当前的测量数据, 记录数量最多达到20000条。

#### 2) View Save

按功能键VIEW (菜单) 查询单次记录的数据, 短按或长按功能键PREV (菜单) 向上一条查询记录的数据, 短按或长按功能键NEXT (菜单) 向下一条查询记录的数据, 按功能键DELETE (菜单) 删除当前的记录数据。按功能键RETURN (菜单) 返回上一次的菜单。除显示记录的数据外, 左下角显示当前记录数据的位置和记录数据的总数量, 右下角显示当前记录数据的日期和时间。

#### 3) Delete All Save

按功能键DELETE (菜单) 进入删除所有的单次记录的数据操作, 按功能键YES (菜单) 确认, 如取消操作, 按功能键NO (菜单)。

### 4) Record

按功能键ENTER(菜单)进入连续记录模式,连续记录的项目数量最多达到10000条。按 $\leftarrow$ 或 $\rightarrow$ 移动光标选择以下三个设置选项。

#### ● Edit Name

按功能键EDIT(菜单)给连续记录的项目命名。按 $\leftarrow$ 或 $\rightarrow$ 移动光标选择编辑的位置,短按F1键切换输入模式为“大写”模式,此后按 $\uparrow$ 或 $\downarrow$ 输入大写字母。短按F2键切换输入模式为“小写”模式,此后按 $\uparrow$ 或 $\downarrow$ 输入小写字母。短按F3键切换输入模式为“数字”模式,此后按 $\uparrow$ 或 $\downarrow$ 输入数字或符号。短按F4键保存编辑并退出编辑状态。

#### ● Set Interval

按功能键EDIT(菜单)设置连续记录间隔时间,短按或长按 $\leftarrow$ 或 $\rightarrow$ 移动光标选择需要编辑的位置。短按或长按 $\uparrow$ 或 $\downarrow$ 可以输入不同的数字。间隔时间可设置1Sec ~ 60Min.

#### ● Set Duration

按功能键EDIT(菜单)设置连续记录持续时间,短按或长按 $\leftarrow$ 或 $\rightarrow$ 移动光标选择需要编辑的位置。短按或长按 $\uparrow$ 或 $\downarrow$ 可以输入不同的数字。持续时间可设置天数,小时和分钟。

#### ● Max Duration

提示持续记录最大的时间

上述设置完成后,按功能键START(菜单)开始连续记录,如图13,显示器上显示“REC”字符并红点闪烁,相关显示信息如下表:

信息	说明
Elapsed Time	运行时间,以小时:分钟:秒格式显示
Remaining Time	剩余时间,以小时:分钟:秒格式显示
Samples	目前已经记录的事件记录点总数
Start	记录期间开始的时间和日期

如要手动停止,可以按功能键STOP(菜单),当停止记录时,会退到View Record菜单以查询记录事件。

相关操作见下文View Record菜单项内容。



图13



### 5) View Record

按功能键VIEW(菜单)可查询记录事件的信息,如图14,相关基本显示信息如下表:

信息	说明
Name	记录事件名称
Interval	间隔时间
Duration	连续记录停止后,实际持续时间
Samples	本条记录事件的记录点总数
Maximum	本条记录数据的最大值
Average	本条记录所有的数据的平均值
Minimum	本条记录数据的最小值
REC	本条记录事件的位置和记录事件的总数量
Start	记录期间开始的时间和日期

14/05/09 08:06	200.41			
Name: MEC_01				
Interval: 00 min 01 sec				
Duration: 00 day 00 hrs 00 min 29 sec				
Samples: 000030				
Maximum: 0.9998 VAC				
Average: 0.9997 VAC				
Minimum: 0.9997 VAC				
REC:18/18		Start:14/05/09 08:07:33		
TREND	PREV	NEXT	RETURN	

← 图14

按功能键PREV(菜单)显示上一条记录的基本信息.按功能键NEXT(菜单)显示下一条记录的基本信息.

按功能键RETURN(菜单)返回上一级菜单.按功能键TREND(菜单)查看本条记录的趋势图,如图15,趋势数据显示信息如下表:

编号	说明
①	光标对应的测量值
②	光标对应的测量日期和时间
③	光标
④	趋势线
⑤	X轴时间标签,显示在经过时间中
⑥	记录事件的名称
⑦	记录期间开始的时间和日期



图15

## UT181A使用说明书

查看趋势图，短按或长按F2键向左移动光标，每短按一次，光标向左移动一个数据，长按时光标加速向左移动。短按或长按F3键向右移动光标，每短按一次，光标向右移动一个数据，长按时光标加速向右移动。短按  $\triangleleft$  或  $\triangleright$  可以垂直缩放曲线图。短按  $\odot$  或  $\ominus$  可以水平缩放曲线图。按F1键可以选择是否删除本条记录。按功能键YES(菜单)确认删除，如取消删除操作，按功能键NO(菜单)。

## 6) Delete All Record

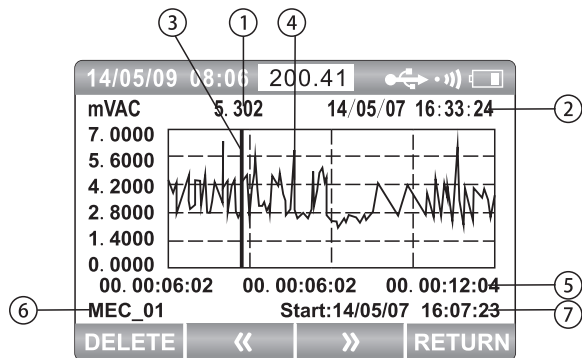
按功能键DELETE(菜单)进入删除所有的记录事件的操作，按功能键YES(菜单)确认，如取消操作，按功能键NO(菜单)。

## 21. 通讯

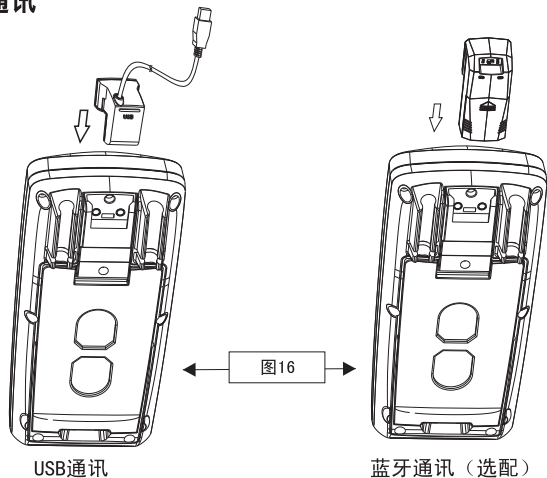

通过设置选项(详细操作见仪表设置选项)打开通讯，显示器左上角会显示“ $\leftrightarrow$ ”符号，如图16，仪表使用USB传输线(标准配件)接入PC进行USB通讯。仪表可以选用蓝牙模块(选配)和手机进行蓝牙通讯。

## 十. 保养和维修

### 1. 一般维护和维修

定期用湿布和温和的清洁剂清洁仪表的外壳。不要使用研磨剂、异丙醇或溶剂。端子上的脏物或湿气会影响读数，同时也会错误启动误插错报警功能。请按以下步骤清洁端子：

- 1) 关闭仪表并取下所有测试导线。
- 2) 把端子上的脏物清除。
- 3) 用中性清洁剂和水浸湿一根干净的棉签。用棉签清洁每个端子。
- 4) 如发现仪表有任何异常，应立即停止使用并送维修。用罐装压缩空气干燥每个端子，迫使水和清洁剂从端子中流出。
- 5) 在有需要对仪表进行校验或维修时，请由有资格的专业维修人员或指定的维修部门维修。

### 2. 测试保险丝

如图17所示，仪表处于电阻功能档，将一根测试导线插入图17插孔，将测试导线另一端的探头尖部接触电流输入插孔的金属。如果出现“Lead Error!”（测试导线连接错误）信息，表示探头尖部在电流输入插孔中插得过深。将导线退出一一点，直到错误信息消失并且显示屏上显示 0L（过载）或电阻读数。如果A 插孔的电阻值读数小于  $0.50 \Omega$ ，说明保险丝F2正常，如果读数为0L，需要替换F2；如果uA m的电阻值读数小于  $1.2M\Omega$ ，说明保险丝F1正常，如果读数为0L，需要替换F1；



图17

## UT181A使用说明书

## 3. 更换保险丝

如图18，请按照以下步骤检查或更换仪表的保险丝：

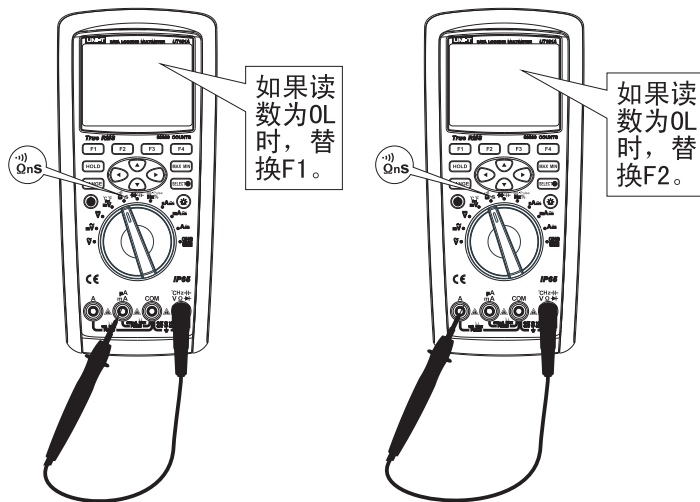
- 1) 关闭仪表并将测试导线从端子上取下。
- 2) 用平头螺丝刀把电池盖的螺丝以逆时针方向转半圈，然后卸下电池盖。
- 3) 轻轻地把保险丝的一端撬起，然后把保险丝从夹子上卸下来。
- 4) mA或 $\mu$ A输入端子必须安装的保险丝为：0.8A H 1000V快熔式 $6\times 32\text{mm}$   
(F1)A输入端子必须安装的保险丝为：10A H 1000V快熔式 $10\times 38\text{mm}$  (F2)
- 5) 重新装好电池盖，然后顺时针方向旋转螺险半圈，关紧电池盖。



图18

## 4. 电池充电

右上角电池电量指示符低于5%容量时，应即时充电，否则会影响测量精度。如图19，将旋钮开关转到 **CHG**，显示器上“Please plug in AC adapter!”字符串提示插入电源适配器充电。将电源转接座接入仪表的四个端子，然后将电源适配器插入电源转接座，显示器上“Charging”字符提示在充电过程中，并有红色指示灯亮，有充电进程动作，并以5%为步进，当充满时，红色指示灯灭，充电进程动作停止。

## ⚠ 注意：

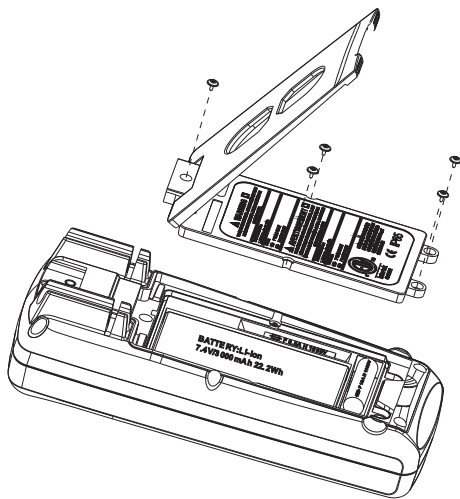
必须使用厂商指定的电源适配器。



图19

本说明书如有变更，恕不另行通知！

**优利德®**

**优利德科技(中国)股份有限公司**

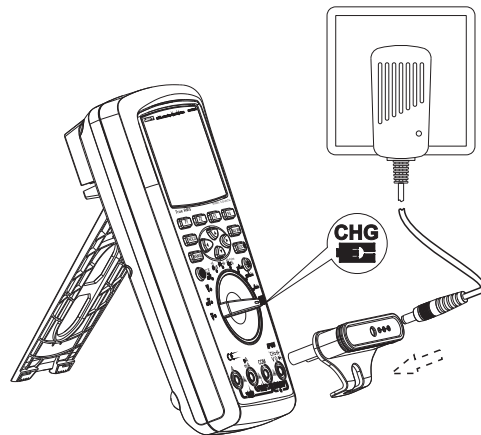
地址:中国广东省东莞松山湖高新技术产业  
开发区工业北一路6号

电话:(86-769)8572 3888

邮编: 523 808

<http://www.uni-trend.com.cn>



**UNI-T®**

**Model UT181A  
OPERATING MANUAL**



## **PREFACE**

Dear users,

Thank you for selecting new UNI-T meters. In order to use this meter properly, please read through this manual carefully before you use it especially on the section of "Safety Precautions". If you have finished reading this manual, we recommend that you properly keep this manual for reference in the future use.

## **LIMITED WARRANTY AND LIMITED LIABILITY**

UNI-T company guarantees that the product will be free from any defects in materials and workmanship from the date of purchase within one year. This warranty does not apply to fuses, disposable batteries, or damage from accident, neglect, misuse, alteration, contamination or abnormal operation or handling. Resellers are not authorized to give any other guarantee in the name of UNI-T. If any warranty service is required during the warranty period, please contact your nearest authorized UNI-T service center to obtain return authorization information; then send the product to that service center with a description of the problem. This warranty is the only compensation that you can get. In addition, UNI-T does not provide any warranty, express or implied, for example, implied warranty applicable for a particular purpose. Meanwhile, UNI-T is not responsible for any special, indirect, incidental or consequential damage or loss as a result of any reason or speculation. Because some regions or countries do not allow limitations on implied warranties and incidental or consequential damages, so the above limitations of liability and provisions may not apply to you.

## Contents

I. Overview-----	28	12. Temperature-----	54
II. Unpacking Inspection-----	28	13. LPF-----	55
III. Rules for Safe Operation-----	29	14. dBV-----	56
IV. Electrical Symbols-----	30	15. dBm-----	56
V. Meter Structure-----	31	16. Maximum Value and Minimum Value-----	56
VI. LCD Display-----	32	17. Relative Value-----	57
VII. Keys, Rotary Switch and Input Terminals-----	33	18. Peak Detection-----	57
VIII. Technical Index-----	35	19. Compare Mode COMP-----	57
1. General Specifications-----	35	20. Recording Measured Data-----	58
2. Electrical Specifications-----	36	21. Communication-----	62
IX. Measurement Operation-----	44	X. Maintenance and Repair-----	62
1. Meter Power Control-----	44	1. General Maintenance and Repair-----	62
2. Meter Settings-----	45	2. Testing Fuss-----	62
3. AC Voltage-----	47	3. Replacing Fuss-----	63
4. DC VoltageV-----	47	4. Battery Charge-----	64
5. AC and DC Current-----	48		
6. Resistance-----	50		
7. Conductance-----	51		
8. Capacitance-----	51		
9. Continuity Test-----	52		
10. Diode-----	52		
11. Frequency/Duty Cycle Measurement/Pulse Width-----	54		

## I. Overview

The Model UT181A is a 60000 counts 4 5/6 digits, handheld auto-range true RMS intelligent Multimeter (hereinafter referred to as “the meter”). The overall circuit is designed with LSI ADC as the core. The full-range overload protection circuit and unique appearance design make it to be a special electrical meter with superior performance. It can be used to measure the parameters such as AC and DC voltage, AC and DC current, resistance, conductance, diode, continuity, capacitance, temperature, frequency and pulse width, and it is provided with the functions of data hold, maximum/minimum/average measurement, comparison measurement, relative measurement, peak detection, trends capture and data record/readback as many as 20,000 pieces.

This Operating Manual covers information on safety and cautions. Please read the relevant information carefully and observe all the Warnings and Notes strictly.



**Warning:**

Please read the “Rules for Safe Operation” before using the meter.

## II. Unpacking Inspection

Open the package case and take out the meter. Please check the following items to see any missing or damaged part:

1. One operating manual
2. A pair of test leads
3. Two K type temperature probes
4. One temperature connector
5. One charging adapter
6. One charging connector
7. One USB cable
8. One CD
9. One cloth bag
10. One warranty card

If you find any missing or damage, please contact your supplier immediately.

### III. Rules for Safe Operation

Please note the "Warning Signs and Words." Warnings indicate the conditions and actions which pose hazards to users or may damage the meter or equipment under test.

This Meter is designed to comply with the safety standards, Conforms to UL STD. 61010-1, 61010-2-030, 61010-2-032, 61010-2-033, Certified to CSA STD. C22.2 NO. 61010-1, 61010-2-030, IEC STD 61010-2-032, 61010-2-033 in pollution degree 2, measurement category (CAT III 1000V, CAT IV 600V) and double insulation as well as with the IP65 standards for waterproof and dustproof. If you use the meter without following up the operating instructions, the protection provided by the meter may be impaired or lost.

**Measurement Category III** (CAT III) is for measurements performed in the building installation. Examples are measurements on distribution boards, circuit-breakers, wiring, including cables, bus-bars, junction boxes, switches, socket-outlets in the fixed installation, and equipment for industrial use and some other equipment, for example, stationary motors with permanent connection to the fixed installation.

**Measurement Category IV** (CAT IV) is for measurements performed at the source of the low-voltage installation. Examples are electricity meters and measurements on primary overcurrent protection devices and ripple control units.

1. Never use a damaged meter. Before using the meter, check

- the meter case to see cracks or any missing plastic part. Pay special attention to the insulation around the connectors.
2. Before using the meter, ensure the battery cover is closed and latched. Before opening the battery cover, remove the test leads from the meter.
  3. Inspect the test leads for damaged insulation or exposed metal. Check the test leads for continuity. If any test lead is damaged, replace it before using the meter.
  4. Do not apply more than the rated voltage, as marked on the meter, between the terminals or between any terminal and grounding.
  5. Do not use the meter when removing the cover or opening the case.
  6. When the meter works at a voltage 30V (rms) in AC, 42V (peak) in AC or over 60V in DC, special care should be taken for there is danger of electric shock.
  7. Replacement fuse must comply with the specifications in this Operating Manual.
  8. Use proper terminals, function and range for your measurement. Do not operate the meter separately.
  9. When measuring the current, shut off the power to the circuit then connect the meter to the circuit. Remember: The meter and the circuit must be connected in series.
  10. When making electrical connections, connect the common test lead before connecting the main test lead; when disconnecting, disconnect the main test lead before disconnecting the common test lead.

11. If the meter works improperly, do not use it. The protection measures of the meter may have failed. If in doubt, send the meter for repair.
12. Do not store or use the meter in an environment of high temperature, humidity, inflammable, explosive and strong magnetic field.
13. When using the probes, keep your fingers behind the finger guards.
14. Do not use the low-pass filter to verify hazardous voltage, for there may be a voltage over the indicated value. First, measure the voltage to check whether it is hazardous in the case of not connecting a filter, then select low-pass filtering.
15. Before testing resistance, continuity, conductance, diode or capacitor, shut off the power to the circuit and discharge all high-voltage capacitors.
16. Before measuring the current, check the fuses of the meter.
17. Do not measure the voltage or current higher than the allowed input values. When the range of measured values cannot be determined, set the functional range switch at the maximum-range position.
18. When the symbol " " shows on the LCD display, the battery should be promptly charged to ensure measurement accuracy.
19. Do not arbitrarily change the wiring within the meter to avoid damaging the meter and endangering the safety.
20. Soft cloth and mild detergent should be used to clean the













surface of the meter when servicing. No abrasive and solvent should be used to prevent the surface of the meter from corrosion, damage and accident.

21. To test the known voltage before use to confirm the product function is correct.
22. If you want to replace the test lead, you need to replace it with a test lead of the same or higher grade of CAT III 1000V/CAT IV 600V.

### **Dangerous Voltage**

When the meter detects the voltage  $\geq 30V$  or overload (OL), the symbol " " will display as a warning for potential hazardous voltage.

## IV. Electrical Symbols

	Double Insulated
	Grounding
	Warning
	AC (Alternating Current)
	DC (Direct Current)
	Continuity Buzzer
	Diode
	Capacitance
	AC or DC (Alternating Current or Direct Current)
	Danger High Voltage
	Conforms to Standards of European Union.
	This symbol signify the product comply with both USA and Canada requirement

## V. Meter Structure (see Figure 1)

1.	Case
2.	LCD
3.	Function Keys
4.	Rotary Switch
5.	Input Terminals

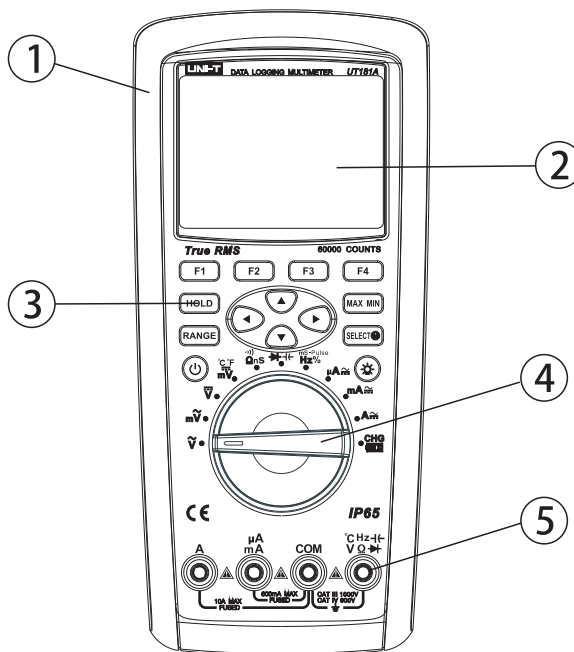

Figure 1

## VI .LCD Display (see Figure 2)

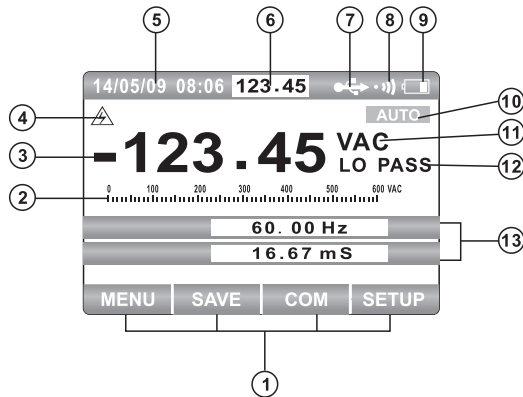

Figure 2





No.	Function	Description
1	Label of Function Keys	Indicates auxiliary functions under current measuring interface
2	Simulation Bar	Analog display of input signals
3	Minus Sign	Indicates minus reading
4	Lightning Symbol	Danger- High Voltage
5	Time and Date	Indicates the time and date set in internal clock
6	Small Measurements	Real-time input values are displayed when the primary and secondary displays are covered by menus or pop-up message.
7	Telecommunication	Indicates the USB/Bluetooth function is enabled.
8	Buzzer	Indicates the button sound is enabled (unrelated to the alarm of continuity test)
9	Battery Capacity	Indicates the capacity level of rechargeable battery
10	Range Indicator	Indicates the current range and range mode for the meter(auto or manual)
11	Unit	Indicates the measurement unit
12	Aided Function Display	Indicates the aided measuring function, such as LPF
13	Aided Display	Indicates the aided measuring information on input signals.

## VII. Keys, Rotary Switch and Input Terminals







### (1) Keys

The 14 keys on the meter are used to activate the selected features of extensible rotary switch, browse menus or control the meter power.





The keys shown in Figure 3 are described in the following table.

Key	Function
	Turn on or turn off the meter power
F1 F2 F3 F4	Select the sub-functions and modes related to the functions of rotary switch.
	Cursor keys are used to select menu items, scroll reading information and input data
HOLD	Keep the current reading on the display
RANGE	Switch the range mode of the meter to manual mode, then take turns to switch between all the available ranges. Long press the button to return to automatic range measurement.
MAX MIN	Starts to record MIN MAX values
SELECT 	Press to select the complex function. Long press to enter Help Menu.
	Press the key to switch the backlight brightness. Long press it to turn off backlight.



### (2) Rotary Switch (see Figure 4)

Knob	Function
	Measurement of AC Voltage
	Measurement of mV in AC and mV in AC+DC
	Measurement of voltage in DC and AC+DC
	Measurement of mV in AC and temperature
	Measurement of resistance, continuity and specific conductance
	Diode test and capacitance measurement



<b>Hz% mS-Pulse</b>	Measurement of frequency, duty cycle and pulse width
<b>μA</b> 	Measurement of μA in AC, DC and AC+DC
<b>mA</b> 	Measurement of mA in AC, DC and AC+DC
<b>A</b> 	Measurement of ampere in AC, DC and AC+DC
<b>CHG</b> 	Battery charge

### (3) Input Terminals

Terminal	Description
<b>A</b>	Input terminals for measuring the current (maximum duration is 30 seconds for 20A overload and suspend for 10 minutes)and frequency from 0A to10. 00A.
<b>mA μA</b>	Input terminals for measuring the current and frequency from 0A to 600mA.
<b>COM</b>	Common terminals for all measurements.
<b>V Ω  °C Hz </b>	Input terminals for measuring voltage, continuity, resistance, diode, conductance, capacitance, frequency, period and duty cycle.

In addition to the above, four terminals are used for charging and temperature measurement through corresponding connectors. "Lead Error!" will show on the display for warning if the probes are inserted improperly.

## VIII. Technical Index

### 1. General Specifications

The maximum voltage between any terminal and ground: 1000 V

The fuse protection of mA or  $\mu$ A input terminals: 0.8A H 1000V Fuse Type 6X32mm

A The fuse protection of A input terminals: 10A H1000V Fuse Type 10X38mm

Max. display: 60000

Range: Auto/Manual

Polarity: Auto

Operating temperature:  $-20^{\circ}\text{C}\sim 50^{\circ}\text{C}$

Storage temperature:  $-30^{\circ}\text{C}\sim 60^{\circ}\text{C}$

Relative humidity:  $\leq 80\%$  ( $0^{\circ}\text{C}\sim 30^{\circ}\text{C}$ ),  $\leq 75\%$  ( $30^{\circ}\text{C}\sim 40^{\circ}\text{C}$ ),  $\leq 45\%$  ( $40^{\circ}\text{C}\sim 50^{\circ}\text{C}$ )

Electromagnetic compatibility: In the RF-field of 1V/m: Overall accuracy= specified accuracy+ 5% of range.

No specified index for the RF-field over 1V/m.

Operating altitude: 0~2000m

Temperature coefficient: 0.1X (specified accuracy)/  $^{\circ}\text{C}$  ( $< 18^{\circ}\text{C}$  or  $> 28^{\circ}\text{C}$ )

Internal battery: Lithium battery of 7.4V 2200mAh

Power adapter: Input of 100V~240V,50/60Hz0.2Amax, Output of DC10V 500mA(short-circuit protection for output) . External diameter of 5.5 mm and internal diameter of 2.5mm.

Low battery: The symbol  shows on the LCD.

Dimension: About (225 X100X 60) mm

Weight: About 608g(including battery)

Safety standards: IEC/EN61010-1, EN61010-2-030, EN 61010-2-033 in pollution degree 2, CAT III 1000V,CAT IV 600V

The standards for waterproof and dustproof: IP65

## 2. Electrical Specifications

Accuracy:  $\pm(\% \text{ Reading} + \text{Digits})$ , one-year calibration period; If the temperature variation of environment reaches  $\pm 5^{\circ}\text{C}$ , the accuracy can be adopted after two hours.

The accuracy can be adopted after two hours when the battery charging is completed.

Ambient temperature:  $23^{\circ}\text{C} \pm 5^{\circ}\text{C}$ ;

Ambient humidity:  $\leq 75\% \text{RH}$ ;

Temperature coefficient:  $0.1 \times (\text{Accuracy}) / ^{\circ}\text{C}$  ( $< 18^{\circ}\text{C}$  or  $> 28^{\circ}\text{C}$ )

### (1) AC Voltage

Range	Resolution	Accuracy Tolerance: $\pm(\% \text{ Reading} + \text{Digits})$			
60mV	0.001mV	45~1kHz	1k~10kHz	10k~20kHz	20k~100kHz
		$\pm(0.6\%+60)$	$\pm(1.2\%+60)$	$\pm(3\%+60)$	$\pm(4\%+60)$
600mV	0.01mV	45~1kHz	1k~10kHz	10k~20kHz	20k~100kHz
		$\pm(0.3\%+30)$	$\pm(1.2\%+40)$	$\pm(3\%+40)$	$\pm(4\%+40)$
6V	0.0001V	45~1kHz	1k~10kHz	10k~20kHz	20k~100kHz
		$\pm(0.3\%+30)$	$\pm(1.2\%+40)$	$\pm(3\%+40)$	$\pm(4\%+40)$
60V	0.001V	45~1kHz	1k~10kHz	10k~20kHz	20k~100kHz
		$\pm(0.3\%+30)$	$\pm(1.2\%+40)$	$\pm(3\%+40)$	$\pm(4\%+40)$
600V	0.01V	45~1kHz	1k~10kHz	10k~20kHz	20k~100kHz
		$\pm(0.3\%+30)$	$\pm(1.2\%+40)$	$\pm(3\%+40)$	Only for reference
1000V	0.1V	45~1kHz	1k~5kHz	5k~10kHz	10k~100kHz
		$\pm(0.6\%+30)$	$\pm(3\%+40)$	$\pm(6\%+40)$	Only for reference

- Input impedance: About 10M $\Omega$
- Overload protection: 1000V
- Display: True virtual value for 10% to 100% of the range.

## (2) DC Voltage

Range	Resolution	Accuracy Tolerance:±(% Reading + Digits)
60mV	0.001mV	±(0.025%+20)
600mV	0.01mV	
6V	0.0001V	±(0.025%+5)
60V	0.001V	
600V	0.01V	±(0.03%+5)
1000V	0.1V	

- Input impedance: About 10MΩ
- Overload protection: 1000V
- Relative mode (REL) is required to compensate bias voltage for 60mV

## (3) AC Voltage + DC Voltage

Range	Resolution	Accuracy Tolerance:±(% Reading + Digits)		
60mV	0.001mV	50~1kHz	1k~10kHz	10k~35kHz
		±(1%+80)	±(3%+40)	±(6%+40)
600mV	0.01mV	50~1kHz	1k~10kHz	10k~35kHz
		±(1%+80)	±(3%+40)	±(6%+40)
6V	0.0001V	50~1kHz	1k~10kHz	10k~35kHz
		±(1%+80)	±(3%+40)	±(6%+40)
60V	0.001V	50~1kHz	1k~10kHz	10k~35kHz
		±(1%+80)	±(3%+40)	±(6%+40)
600V	0.01V	50~1kHz	1k~10kHz	10k~35kHz
		±(1%+80)	Only for reference	Only for reference
1000V	0.1V	50~1kHz	1k~10kHz	10k~35kHz
		±(1.2%+80)	Only for reference	Only for reference

- Input impedance: About 10MΩ
- Overload protection: 1,000V
- Display: True virtual value for 10% to 100% of the range.

#### (4) AC Current

Range	Resolution	Accuracy Tolerance:±(% Reading + Digits)	
600 μA	0.01 μA	45~1kHz	1k~10kHz
		±(0.6%+40)	±(1.2%+40)
6000 μA	0.1 μA	45~1kHz	1k~10kHz
		±(0.6%+20)	±(1.2%+40)
60mA	0.001mA	45~1kHz	1k~10kHz
		±(0.6%+40)	±(1.2%+40)
600mA	0.01mA	45~1kHz	1k~10kHz
		±(0.6%+20)	±(1.2%+40)
10A	0.001A	45~1kHz	1k~10kHz
		±(1%+20)	±(3%+40)

- Display: True virtual value for 10% to 100% of the range.
- Overload protection: μAmA range: 0. 8A H 1000V Fuse Type Φ 6x32 mm  
10 A range: 10A H 1000V Fuse Type Φ10x38mm
- Switch on for 30 seconds and suspend for 10 minutes for 20A. Not specified for over 10A.

## (5) DC Current

Range	Resolution	Accuracy Tolerance:±(% Reading + Digits)
600μA	0.01μA	±(0.08%+20)
6000μA	0.1μA	±(0.08%+10)
60mA	0.001mA	±(0.08%+20)
600mA	0.01mA	±(0.15%+10)
10A	0.001A	±(0.5%+10)

- Overload protection: μAmA range: 0. 8A H 1000V Fuse Type Φ 6x32 mm  
10 A range: 10A H 1000V Fuse Type Φ10x38mm
- Switch on for 30 seconds and suspend for 10 minutes for 20A. Not specified for over 10A.

## (6) AC Current + DC Current

Range	Resolution	Accuracy Tolerance:±(% Reading + Digits)	
		50~1kHz	1k~10kHz
600μA	0.01μA	±(0.8%+40)	±(2.0%+40)
		50~1kHz	1k~10kHz
6000μA	0.1μA	±(0.8%+20)	±(2.0%+40)
		50~1kHz	1k~10kHz
60mA	0.001mA	±(0.8%+40)	±(2.0%+40)
		50~1kHz	1k~10kHz
600mA	0.01mA	±(0.8%+20)	±(2.0%+40)
		50~1kHz	1k~10kHz
10A	0.001A	±(1.2%+20)	±(3%+40)
		50~1kHz	1k~10kHz

- Display: True virtual value for 10% to 100% of the range.
- Overload protection:  $\mu$ A mA range: 0. 8A H 1000V Fuse Type  $\Phi$  6x32 mm  
10 A range: 10A H 1000V Fuse Type  $\Phi$ 10x38mm
- Switch on for 30 seconds and suspend for 10 minutes for 20A. Not specified for over 10A.

## (7) Resistance

Range	Resolution	Accuracy Tolerance: $\pm$ (% Reading + Digits)
600 $\Omega$	0.01 $\Omega$	In REL state: $\pm$ (0.05%+10)
6k $\Omega$	0.0001k $\Omega$	$\pm$ (0.05%+2)
60k $\Omega$	0.001k $\Omega$	
600k $\Omega$	0.01k $\Omega$	
6M $\Omega$	0.0001M $\Omega$	$\pm$ (0.3%+10)
60M $\Omega$	0.001M $\Omega$	$\pm$ (2%+10)

- Overload protection: 1,000V
- Humidity for 60 M $\Omega$ : <50%

## (8) Conductance

Range	Resolution	Accuracy Tolerance: $\pm$ (% Reading + Digits)
60nS	0.01nS	$\pm$ (2%+10)

- Overload protection: 1000V
- Humidity: <50%

## (9) Capacitance

Range	Resolution	Accuracy Tolerance:±(% Reading + Digits)
6nF	0.001 nF	±(3%+10)
60nF	0.01nF	±(2.5%+5)
600nF	0.1nF	±(2%+5)
6μF	0.001μF	
60μF	0.01μF	
600μF	0.1μF	
6mF	1μF	±(5%+5)
60mF	10μF	Not specified

- Overload protection: 1000V
- Display digits: 6000

## (10) Temperature

Range	Resolution	Accuracy
-40°C~40°C	0.1°C	±(2.0%+30)
40°C~400°C		±(1.0%+30)
400°C~1000°C		±2.5%
-40°F~104°F	0.2°F	±(2.5%+50)
104°F~752°F		±(1.5%+50)
752°F~1832°F		±2.5%

- Overload protection: 1000V
- Two-channel temperature measurement can be performed via temperature connectors.
- Temperature sensor: Applicable to K type(chromel-silicel) thermocouple. Spare parts are point contact Ktype (chromel-silicel) thermocouple (only applicable to the measurement when temperature is below 230 ° C).



## (11) Frequency

Range	Resolution	Accuracy
60Hz	0.001 Hz	$\pm(0.02\%+8)$
600Hz	0.01 Hz	$\pm(0.01\%+5)$
6kHz	0.0001kHz	
60kHz	0.001kHz	
600kHz	0.01kHz	
6MHz	0.0001MHz	
60MHz	0.001MHz	

- Overload protection: 1000V
- Input amplitude: 10Hz~30MHz:  $600\text{mV} \leq a \leq 30\text{V}_{\text{rms}}$ . Greater than 30MHz: Not specified

## (12) Duty Cycle

Range	Resolution	Accuracy Tolerance: $\pm(\% \text{ Reading} + \text{Digits})$
10%~90%(10Hz~2kHz)	0.01%	$\pm(1.2\%+30)$

- Overload protection: 1000V
- When the rise time is less than  $1 \mu\text{s}$ , the signals center on trigger level.

## (13) Pulse Width

Range	Resolution	Accuracy Tolerance: $\pm(\% \text{ Reading} + \text{Digits})$
250mS	0.001mS~0.01mS	$\pm(1.2\%+30)$

- Overload protection: 1000V
- When the rise time is less than  $1 \mu\text{s}$ , the signals center on trigger level.
- The pulse width is greater than  $2 \mu\text{s}$  for 10Hz to 200kHz. The pulse width depends on signal frequency.

## (14) Continuity Test

Range	Resolution	Remark
	0.01Ω	Open circuit voltage is around 3V; when the buzzer selects short circuit for sound warning, the resolution is less than 10Ω. The buzzer continuously sounds, the resolution is greater than 50Ω. The buzzer does not sound. When the buzzer selects open circuit for sound warning, the resolution is greater than 50Ω. The buzzer continuously sounds, the resolution is less than 10Ω. The buzzer does not sound.

- Overload protection: 1000V

## (15) Diode Test

Range	Resolution	Remark
	0.0001V	Open-circuit voltage is around 3V. The forward voltage drop value of the measured PN junction is approximately $\leq 3V$ . When the buzzer activates, it will beep briefly for the normal semiconductor junction; If the semiconductor junction shorts out, it will beep continuously. Silicon PN junction drops between 0.5~0.8V as the normal value.

- Overload protection: 1000V

## IX. Measurement Operation

### 1. Meter Power Control



#### 1) Manually start up and shut down the meter power.

When the meter is off, long press  to start the meter. When the meter is on, long press  to shut it off.

The meter cannot be powered off when charging.

#### 2) Indicators for Battery Capacity

The meter is powered by lithium battery. The indicators for battery capacity are in the upper right corner of display to indicate the relative conditions of battery. Various indicators for battery capacity are described in the following table.

Meaning	Battery Capacity
	Full capacity
	Half capacity
	Empty

When the battery capacity is lower than 3% of full capacity, the meter will automatically shut down.

#### 3) Backlight Control

If the display is not visible in low-light situations,  press to switch the backlight brightness. Long press the key to turn off the backlight and enter power saving mode. When the backlight is off, the green light flashes to indicate that the meter is still collecting data. Press any key or turn the rotary switch to turn on the backlight again.



#### 4) Auto Power-off

If there is no turning of rotary switch or key action within the time set in the menu item "POWE OFF" under the meter setting "AUTO POWER SAVE", the meter will automatically shut down. Long press  to restart the meter. When the item "POWE OFF" is set as OFF, Auto power-off will be completely prohibited.

## 5) Power Saving Mode

Set the control time of automatic reduction for backlight brightness and off time for display via the meter menu bar "AUTO POWER SAVE" to enter power-saving mode. Please refer to the detailed description about the meter settings.

## 2. Meter settings

Press the function key SETUP (Menu) to set and view the relevant information on the meter. Press the cursor keys   to select relevant menu items of the meter as follows.



### 1) Keypad Tone

Set as ON to enable key sound and OFF to disable key sound, meanwhile the buzzer symbol  in the upper right corner will appear or disappear for its ON and OFF.





### 2) Lead Alarm Buzzer

Set as ON to enable the alarm sound for wrong insertion by probe and OFF to disable the alarm sound for mis-inserted probe.





### 3) Communication

Set as ON to enable USB or Bluetooth communication while a symbol  will appear in the upper left corner. Set as OFF to disable USB or bluetooth communication while the symbol  in the upper left corner will disappear.

### 4) Date & Time

Press the function key SET (Menu) to set the date and time within the meter. Press  or  to select the required edit position, and press  or  to enter different numbers, then press the function key OK (Menu) to confirm. To cancel the settings, press the function key CANCEL (Menu).



### 5) AUTO POWER SAVE

Press the function key SET (Menu) to set the control time of automatic reduction for backlight brightness, off time of display and auto power-off time. Press  or  to move the cursors to select different items. Press  or  to enter the time for power saving mode of this item with minute unit.



Menu Item	Description	Set Value
Brightness Down	Control time of automatic reduction for backlight brightness	ON: 1-60 Min OFF: This function is disabled
Display Off	Off time of display	ON: 1-60 Min OFF: This function is disabled
Power Off	Auto power-off time	ON: 1-60 Min OFF: This function is disabled

Press the function key OK (Menu) to confirm the above settings. To cancel the settings, press the function key CANCEL (Menu)

## 6) More Settings

Press the function key ENTER (Menu) to set the languages of help information, format memory, reset the meter settings, check product model, serial number and available memory space. Press the cursor keys   to select the relevant menu items of the meter as follows.

### ● Help Menu Language

Press the function key SET (Menu) to set the language for help information. Press  or  to select a different language. Then press the function key OK (Menu) to confirm.

To cancel the settings, press the function key CANCEL (Menu).

### ● Memory Format

Press the function key FORMAT (Menu) to enter memory format, then press the function key YES (Menu) to confirm.

To cancel the format, press the function key NO (Menu).

### ● Reset All Setting

Press the function key RESET (Menu) to reset the menu with default settings, then press the function key YES (Menu) to confirm. To cancel the reset, press the function key NO (Menu).

### ● About

Press the function key ABOUT (Menu) to check product model, serial number and available memory space.

### 3. AC Voltage

- 1) Insert the red test lead into the V terminal and the black test lead into the COM terminal.
- 2) Set the rotary switch to  $\tilde{V}$  or  $m\tilde{V}$  as shown in Figure 5. Connect the test leads to the power or load under test in parallel.
- 3) Directly read the measured voltage values on the display. True virtual values are displayed for AC measurement.
- 4) Press the function key MENU (Menu) to enter one menu item in which basic AC voltage measurement can be modified. Press the cursor keys  $\leftarrow$   $\rightarrow$  to select menu items. The red cursor key indicates the selected item, then press F1 to enter the corresponding measuring mode, press F2 to enter relative value measurement, press F3 to set dbm resistance, and press F4 to close the window of additional function.

#### ⚠ Attention:

- Do not input a voltage higher than 1000V. Higher voltage may be measured but it poses risk to damage the meter.
- When measuring high voltage, special care should be taken to avoid electric shock.
- After completing all the measuring operations, disconnect the connection between the test leads and the circuit under test.
- The response mode of AC coupled true RMS is adopted for the conversion of AC with sinusoidal input calibration. The accuracy of non-sinusoidal wave must be adjusted based on the following:

For crest of 1.4~2.0, the accuracy shall be added 1.0%.  
 For crest of 2.0~2.5, the accuracy shall be added 2.5%.  
 For crest of 2.5~3.0, the accuracy shall be added 4.0%.

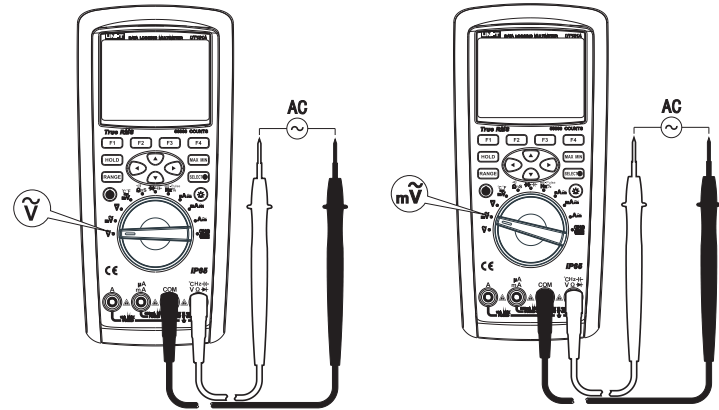

Figure 5

### 4. DC Voltage

- 1) Insert the red test lead into the V terminal and the black test lead into the COM terminal.
- 2) Set the rotary switch to DC V or DC mV as shown in Figure 6. Connect the test leads to the power or load under test in parallel.
- 3) Directly read the measured voltage values on the display.

- 4) Press the function key MENU (Menu) to enter one menu item in which basic DC voltage measurement can be modified. Press the cursor keys  $\leftarrow \rightarrow$  to select menu items. The red cursor key indicates the selected item, then press F1 to enter the corresponding measuring mode, press F2 to enter relative value measurement, and press F4 to close the window of additional function.

**⚠ Attention:**

- Do not input a voltage higher than 1000V. Higher voltage may be measured but it poses risk to damage the meter.
- When measuring high voltage, special care should be taken to avoid electric shock.
- After completing all the measuring operations, disconnect the connection between the test leads and the circuit under test.

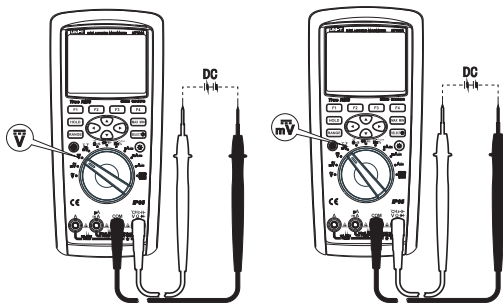

Figure 6

## 5. AC and DC Current

- 1) Insert the red test lead into the  $\mu$ A mA or A terminal and the black test lead into the COM terminal.
- 2) Set the rotary switch to the position as shown in Figure 7. Press the key SEECT to select the required AC or DC to be measured. Connect the test leads to the test circuit in series.
- 3) Directly read the measured current values on the display. True virtual values are displayed for AC measurement.
- 4) Press the function key MENU (Menu) to enter one menu item in which basic AC or DC current measurement can be modified. Press the cursor keys  $\leftarrow \rightarrow$  to select menu items. The red cursor key indicates the selected item, then press F1 to enter the corresponding measuring mode, press F2 to enter relative value measurement, and press F4 to close the window of additional function.

**⚠ Warning**

- Before connecting to the test circuit in series, turn off the power to the circuit first and discharge all the high-voltage capacitors.
- Use proper input terminals and functions for measurement. If the current size cannot be estimated, the range of large current should be measured first.
- When the test lead is inserted in the input terminal of current, do not connect its test prod to any circuit in parallel, it will blow the fuses within the meter and damage the meter.

- After completing all the measuring operations, disconnect the connection between the test leads and the circuit under test.

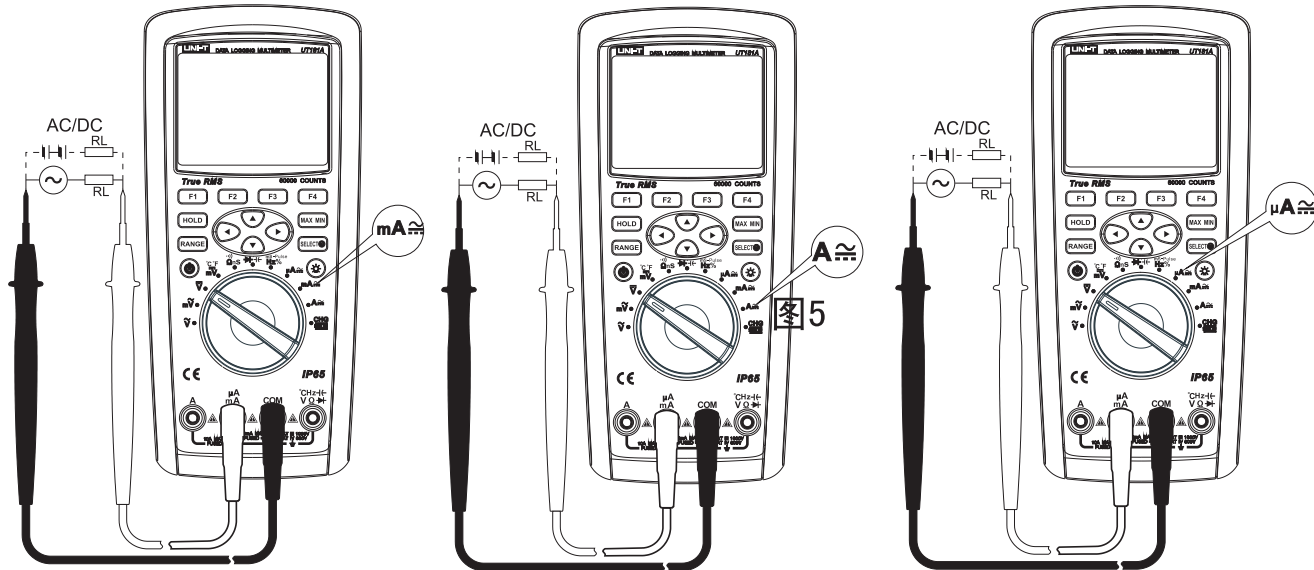

Figure 7



## 6. Resistance

- 1) Insert the red test lead into the  $\Omega$  terminal and the black test lead into the COM terminal.
- 2) Set the rotary switch to the measurement  $\Omega$  nS  $\rightarrow$  and current  $\Omega$  is the default resistance measurement as shown in Figure 8. Connect the test leads to both ends of the measured resistance.
- 3) Directly read the measured resistance values on the display.

### ⚠ Attention:

- If the open circuit of measured resistance or resistance value exceeds the maximum range of the meter, "OL" will show on the display.
- When measuring the in-circuit resistance, all the power within the measured circuit must be shut off before measurement and all the capacitors must be discharged to ensure a correct measurement.
- When measuring low resistance, the test lead will bring about measurement errors of resistance between 0.10 to 0.20. To obtain accurate readings, relative measurement can be adopted. First short the input test lead, then press the key MENU and press F2 to enter the relative measurement. Perform the measurement of low resistance after the meter automatically subtracts the display value of shorted test lead.
- If the resistance value is greater than 0.50 for a shorted test lead, the test lead should be checked to see any loose or other factors.

- When measuring the resistance above  $1M\Omega$ , the readings require a few seconds to be stable. It is normal for the measurement of high resistance. In order to obtain stable readings, short test lines can be used for the measurement.
- Do not input a voltage higher than 30V in AC(rms), AC(peak 42V) or 60V in DC to avoid personal injury.
- After completing all the measuring operations, disconnect the connection between the test leads and the circuit under test.

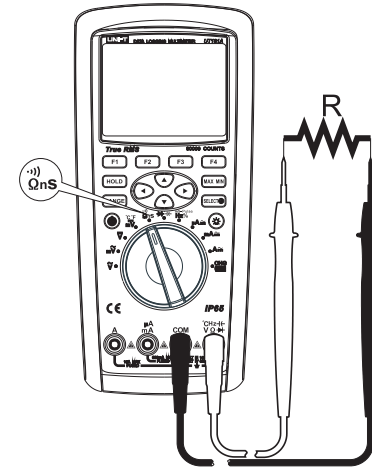

Figure 8

## 7. Conductance

- 1) Insert the red test lead into the  $\Omega$  terminal and the black test lead into the COM terminal.
- 2) Set the rotary switch to the measurement  $\Omega_{ns}$  . press the key SELECT to select conductance measurement 60nS. Connect the test leads to both ends of the measured resistance as shown in Figure 8.
- 3) Directly read the measured conductance value on the display.

### ⚠ Attention:

- When measuring the in-circuit resistance, all the power within the measured circuit must be shut off before measurement and all the capacitors must be discharged to ensure a correct measurement.
- Do not input a voltage higher than 30V in AC(rms),AC(peak 42V) or 60V in DC to avoid personal injury.
- After completing all the measuring operations, disconnect the connection between the test leads and the circuit under test.

## 8. Capacitance

- 1) Insert the red test lead into the  $\overline{C}$  terminal and the black test lead into the COM terminal.
- 2) Set the rotary switch to the measurement  $\overline{C}$  , press the key SELECT to select capacitance measurement. Connect the test leads to both ends of the measured capacitance as shown in Figure 9.

- 3) Directly read the measured capacitance value on the display.

### ⚠ Attention:

- If the measured capacitance shorts or capacitance value exceeds the maximum range of the meter, "OL" will show on the display.
- For the measurement of capacitance within small range, relative measurement REL should be adopted to avoid the influence of distributed capacitance for correct readings.
- For the measurement of capacitance greater than 600  $\mu F$ , it needs longer time for correct readings.
- To ensure the measuring accuracy, the capacitor should be discharged completely then put into the meter to measure especially for a capacitor with high voltage thus to avoid damage to the meter and personal injury.
- Do not input a voltage higher than 30V in AC(rms),AC(peak 42V) or 60V in DC to avoid personal injury.
- After completing all the measuring operations, disconnect the connection between the test leads and the capacitor under test.

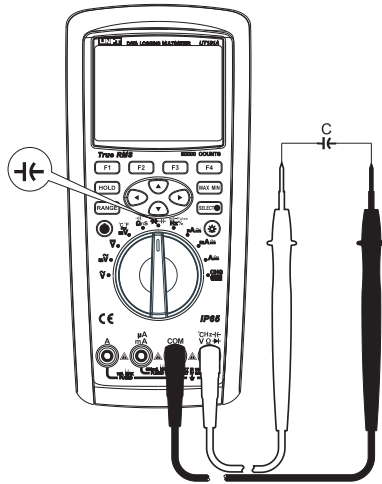

Figure 9

## 9. Continuity test

- 1) Insert the red test lead into the  $\Omega$  terminal and the black test lead into the COM terminal.
- 2) Set the rotary switch to the measurement  $\Omega$  (S), press the key SELECT to select the continuity test (S). Connect the test leads to both ends of the measured resistance as shown in Figure 8. Press the function key MENU (Menu) to enter the menu items. If pressing the key SHORT (Menu), then the buzzer selects

short circuit for alarm sound, the measured resistance between both ends  $<10\Omega$ , the buzzer continuously sound  $>50\Omega$ . The buzzer does not sound. If pressing the key OPEN (Menu), then the buzzer selects open circuit for alarm sound, the measured resistance between both ends  $>50\Omega$ , the buzzer continuously sound  $<10\Omega$ . The buzzer does not sound.

- 3) Directly read the measured resistance value on the display.

### ⚠ Warning

- When measuring the in-circuit resistance, all the power within the measured circuit must be shut off before measurement and all the capacitors must be discharged to ensure a correct measurement.
- Do not input a voltage higher than 30V in AC(rms), AC(peak 42V) or 60V in DC to avoid personal injury.
- After completing all the measuring operations, disconnect the connection between the test leads and the circuit under test.

## 10. Diode

- 1) Insert the red test lead into the  $\rightarrow$  terminal and the black test lead into the COM terminal. The polarity of red test lead is "+" and "-" for black test lead.
- 2) Set the rotary switch to the measurement  $\rightarrow$   $\leftarrow$  and the diode measuring mode  $\rightarrow$  is default. Connect the test leads to both ends of the measured diode as shown in Figure 10. Directly read the approximate forward PN junction voltage of the measured diode on the display.

- 3) Press the function key MENU(Menu) to enter menu items. If pressing the key ALARM, the buzzer starts up. It will beep briefly for the normal semiconductor junction; if the semiconductor junction shorts out, it will beep continuously. Silicon PN junction drops between 0.5~0.8V as the normal value. If pressing the key NORMAL, the buzzer will not start up.

**⚠ Attention:**

- If the measured diode is in open circuit or the polarity is reversed, "OL" will display.
- When measuring the in-circuit diode, all the power within the measured circuit must be shut off before measurement and all the capacitors must be discharged.
- Open-circuit voltage of diode test is around 3V.
- Do not input a voltage higher than 30V in AC(rms), AC(peak 42V) or 60V in DC to avoid personal injury.
- After completing all the measuring operations, disconnect the connection between the test leads and the circuit under test.

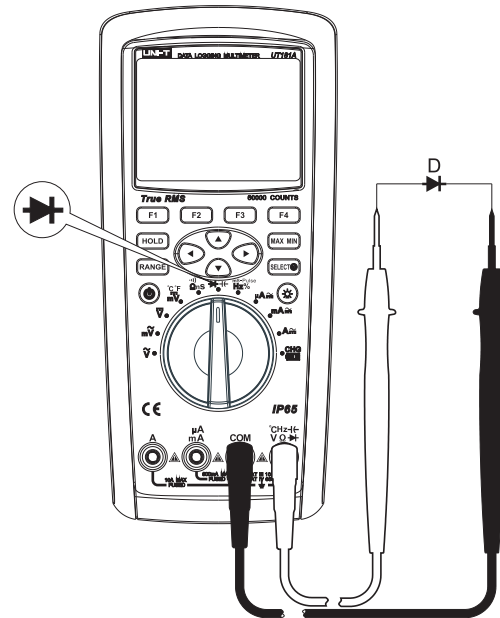

Figure 10

## 11. Frequency/Duty Cycle Measurement /Pulse Width

- 1) Insert the red test lead into the V terminal and the black test lead into the COM terminal.
- 2) Set the rotary switch to the measurement Hz% ms-Pulse, press the key SELECT to select Hz or Duty% or ms-Pulse. Connect the test leads to the signal source under test in parallel as shown in Figure 11.
- 3) Directly read the measured values of frequency or duty cycle or pulse width on the display.

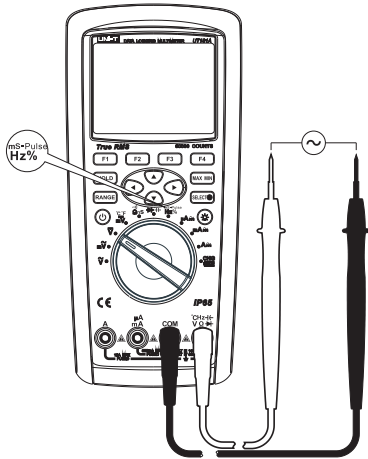

Figure 11

### ⚠ Attention:

- Simulation bar displays the frequency of the measured signal for duty cycle and pulse width.
- Do not input a voltage with higher frequency than 30Vrms to avoid personal injury.
- After completing all the measuring operations, disconnect the connection between the test leads and the circuit under test.

## 12. Temperature

- 1) Set the rotary switch to the measurement " $m\bar{V}^{\circ}C^{\circ}F$ ", then press the key SELECT to select Celsius  $^{\circ}C$  or Fahrenheit  $^{\circ}F$ . Insert the temperature connector into four terminals and connect two temperature probes to the temperature connector. The probes detect the surface of the object under test as shown in Figure 12.
- 2) Directly read Celsius or Fahrenheit temperature values of the two surfaces under test on the display.
- 3) Press the function key MENU (Menu) to open one menu item F2 in which basic temperature measurement can be modified to enter the relative measuring mode. Press F4 to close the window of additional function. Press the cursor keys  $\leftarrow \rightarrow$  to select menu items. The red cursor key indicates the selected item, then press F1 to enter corresponding value measurement. Press F2 to enter relative value measurement, and press F4 to close the window of additional function.

**⚠ Attention:**

- The ambient temperature for the meter shall not exceed the range from 18° C to 28 °C, otherwise it will cause measurement errors. The measurement effects are more obvious at low temperatures.
- Remove the temperature probes after completing all the measuring operations.
- Point contact K type (chromel-silicel) thermocouple (only applicable to the measurement when temperature is below 230 ° C).

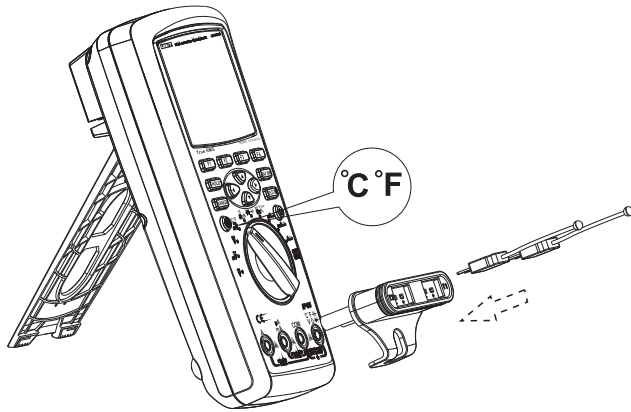
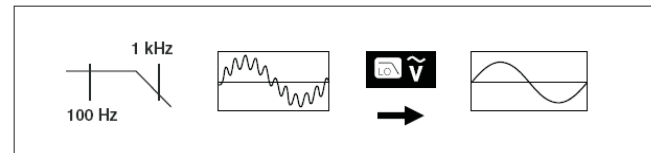

Figure 12

## 13. LPF Measurement

- 1) Insert the red test lead into the V terminal and the black test lead into the COM terminal.
- 2) Set the rotary switch to  $\checkmark$ . Connect the test leads to the power or load to be tested in parallel as shown in Figure 5.
- 3) Press the function key MENU (Menu) to enter one menu item. Press the cursor keys  $\leftarrow$   $\rightarrow$  to select Low Pass, then press the function key (Menu) Low Pass to enter LPF measuring mode.
- 4) The meter performs the measurement in AC mode. The AC signals go through a filter which holds up the voltage higher than 1KHz. As shown in the following figure, the low-pass filter can measure the composite signals of sinusoidal wave generated by inverter and variable-frequency motor.



**⚠ Attention:**

- To avoid electric shock or personal injury, do not use low-pass filter to verify hazardous voltage, for the voltage over the indicated value may exist. First, measure the voltage in the case of disconnecting the filter to see any hazardous voltage. Then select the filter function.

- In the LPF measuring mode, the meter will turn to manual mode. Press the key RANGE to select a range. When the low-pass filter is enabled, the automatic range is unavailable.
- Do not input a voltage above 1000V. Higher voltage may be measured but it poses the risk of damaging the meter.
- After completing all the measuring operations, disconnect the connection between the test leads and the circuit under test.

## 14.dBV

- 1) Insert the red test lead into the V terminal and the black test lead into the COM terminal.
- 2) Set the rotary switch to  $\checkmark$ . Connect the test leads to the power or load to be tested in parallel as shown in Figure 5.
- 3) Press the function key MENU(Menu) to enter one menu item. Press the cursor keys  $\leftarrow \rightarrow$  to select the menu item dBV, then press the function key (Menu) dBV to enter dBV measurement.
- 4) dBV is primarily shown and AC voltage value is secondly shown on the display. AC voltage of the measured signal is displayed on the simulation bar.

## 15.dBm

- 1) Insert the red test lead into the V terminal and the black test lead into the COM terminal.2) Set the rotary switch to  $\checkmark$ . Connect the test leads to the power or load to be tested in parallel as shown in Figure 5.3) Press the function key MENU (Menu) to enter one of the menu items, press the

cursor keys  $\leftarrow \rightarrow$  to select the menu item dBm. A reference impedance (resistance) must be used for the measurement of dBm to calculate dB value on the basis of 1mW. Press the function key RES (Menu) to select a reference impedance value. Press  $\uparrow$  or  $\downarrow$  to scroll between ten defined reference values: 4,8,16,25,32,50,75,600, 1000 and 1200. Press the function key EDIT (Menu) and the cursor keys  $\leftarrow \rightarrow$  to select any one of the reference impedance values between  $4\Omega \sim 1200\Omega$ . Press the function key OK (Menu) to set reference values. Press the function key dBm (Menu) to enter dBm measurement.

- 4) dBm is primarily shown and AC voltage value is secondly shown on the display. AC voltage of the measured signal is displayed on the simulation bar.

## 16. Maximum and Minimum Value

Press MAX MIN to activate the measurement of maximum and minimum values. Real-time measurements are primarily displayed. Maximum, average and minimum values, elapsed time, start date and time corresponding to the three values are secondly displayed. Press the function key RESTART (Menu) to re-activate the measurement of maximum and minimum values. Press the function key EXIT (Menu) to exit the measurement of maximum and minimum values.

## 17. Relative value

Press the function key MENU (Menu) to enter a next interface, press the function key REL (Menu) to enter the measuring mode of relative values, then press the function key REL (Menu) to activate the measurement of relative values, by this time the measurements \_ basic values are primarily displayed and the relative values and real-time measurements are secondly displayed. Press the function key MENU (Menu) to select basic measurement to exit the measurement of relative values.

## 18. Peak detection

Press the function key MENU (Menu) to select Peak item, then press the function key PEAK (Menu) to activate peak detection. Response time is 1ms. Transient values can be more accurately measured by using peak recording function.

## 19 Compare Mode COMP

Press the function key COMP(Menu) to enter the measurement of compare mode. Press  $\odot$  or  $\ominus$  to select the settings of compare mode as follows.

### 1) Pass Mode

Press the function key EDIT(Menu) to enter the setting mode of compare types. Press  $\odot$  or  $\ominus$  to set one of the four types as follows.

- INNER(Low Value  $\leq$  Input Value  $\leq$  High Value)
- OUTER (Input Value < Low Value or Input Value >High Value)

- <Value
- <Value
- >Value
- >Value

Press the function key OK (Menu) to confirm the above settings. To cancel the settings, press the function key CANCEL (Menu).

### 2) Beep Mode

Press the function key EDIT(Menu) to enter buzzer start mode. Press  $\odot$  or  $\ominus$  to select one of the three items as follows.

#### ●PASS ON

It indicates that the buzzer starts to sound when the compare result shows as PASS.

#### ●FAIL ON

It indicates that the buzzer starts to sound when the compare result shows as FAIL.

#### ●OFF

Buzzer close

Press the function key OK (Menu) to confirm the above settings. To cancel the settings, press the function key CANCEL (Menu).

### 3) Low Value or High Value or Value

Press the function key EDIT (Menu) to set compare reference values. Press  $\odot$  or  $\ominus$  to move the cursors to select edit locations. Press  $\odot$  or  $\ominus$  to enter different numbers. Press the function key OK (Menu) to confirm. To cancel the settings, press the function key CANCEL (Menu).



After completing the settings, press the function key START (Menu) to start the measurement of compare mode. Press the function key EXIT (Menu) to exit the measurement of compare mode.

## 20. Recording Measurement Data

Press the function key SAVE(Menu) to enter the modes of single recording, continuous recording and inquire recording. Press the cursor keys  $\leftarrow$   $\rightarrow$  to select the following modes.

### 1) Save

Press the function key SAVE (Menu) to record the current measuring data for once up to 20000 pieces.

### 2) View Save

Press the function key VIEW (Menu) to view one-time recorded data. Press or long press the function key PREV (Menu) to view the previous recorded data. Press or long press the function key NEXT (Menu) to view the next recorded data. Press the function key DELETE (Menu) to delete the current recorded data. Press the function key RETURN (Menu) to return to the last menu. In addition to displaying the recorded data, the location and total number of current recorded data are displayed in the lower left corner. The date and time of current data recording are displayed in the lower right corner.

### 3) Delete All Save

Press the function key DELETE(Menu) to delete all one-time recorded data. Press the function key YES (Menu) to

confirm. To cancel the operation, press the function key NO(Menu).

### 4) Record

Press the function key ENTER (Menu) to enter the continuous recording mode with maximum recording pieces up to 10000. Press  $\leftarrow$  or  $\rightarrow$  and move cursors to select the three settings as follows.

#### ● Edit Name

Press the function key EDIT (Menu) to name the continuous recording items. Press  $\leftarrow$  or  $\rightarrow$  to move the cursor and select edit locations. Press the F1 key to switch the input mode to "Uppercase" mode, then press  $\leftarrow$  or  $\rightarrow$  to input uppercase letters. Press the F2 key to switch the input mode to "Lowercase" mode, then press  $\leftarrow$  or  $\rightarrow$  to input lowercase letters. Press the F3 key to switch the input mode to "Digital" mode, then press  $\leftarrow$  or  $\rightarrow$  to enter numbers or symbols. Press the F4 key to save exit and exit edit mode.

#### ● Set Interval

Press the function key EDIT (Menu) to set the interval time of continuous recording. Press or long press  $\leftarrow$  or  $\rightarrow$  to move the cursors to select edit locations. Press or long press  $\leftarrow$  or  $\rightarrow$  to enter different numbers.

The interval time can be set as 1Sec ~ 60Min.

#### ● Set Duration

Press the function key EDIT (Menu) to set the duration time of continuous recording. Press or long press  $\leftarrow$  or  $\rightarrow$  to move the cursors to select edit locations. Press or long press  $\leftarrow$  or  $\rightarrow$  to enter different numbers. The duration time can be set as days, hours and minutes.

## ● Max Duration

Indicates the maximum time for continuous recording. After completing the settings, press the function key START (Menu) to start continuous recording as shown in Figure 13.

The character REC shows on the display and flashes with red dot. The relevant display information is shown in the following table.

Information	Description
Elapsed Time	Run time displayed in hours:minutes:seconds
Remaining Time	Time left displayed in hours:minutes:seconds
Samples	Total recording points for present recorded events
Start	Time and date started from recording period

To manually stop recording, press the function key STOP (Menu). When stop recording, return to the menu View Record to view the record events. See the relevant operations in the following menu View Record.



Figure 13

## 5) View Record

Press the function key(Menu) to view the information on record events as shown in Figure 14. The basic display information is in the following table.

Information	Description
Name	Name of record event
Interval	Interval time
Duration	Actual duration time after continuous recording stops
Samples	Total recording points for present record events
Maximum	Maximum value for present record data
Average	Average value for all data of present record
Minimum	Minimum value for present record data
REC	Position of present record incident and total number of record events
Start	Time and date started from recording period

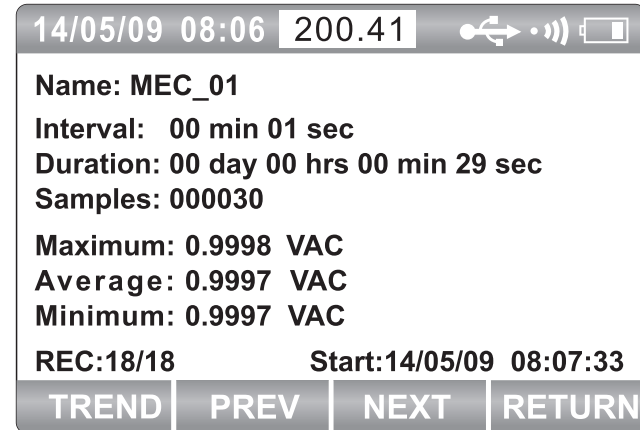

Figure 14

Press the function key PREV (Menu) to display basic information on the previous record. Press the function key NEXT (Menu) to display basic information on the next record. Press the function key RETURN (Menu) to return to the previous menu. Press the function key TREND (Menu) to view the trend chart of present record as shown in Figure 15. The display information of trend data is in the following table:

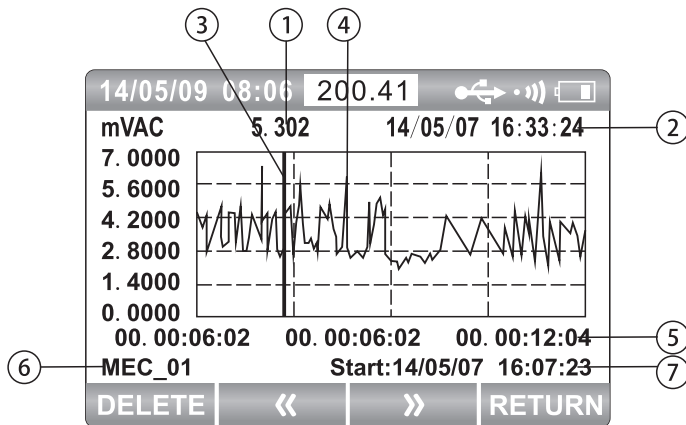

Figure 15

No.	Description
①	Measured value corresponding to cursor
②	Date and time for measurement corresponding to cursor
③	Cursor
④	Trend line
⑤	Time label of X-axis to display during elapsed time
⑥	Name of record event
⑦	Time and date started from recording period

View the trend chart. Press or long press the F2 key to move the cursor left. The cursor moves one data to the left for each pressing. Long pressing, the cursor speeds up to move left. Press or long press the F3 key to move the cursor right. The cursor moves one data to the right for each pressing. Long pressing, the cursor speeds up to move right. Press  $\odot$  or  $\ominus$  to scale the graph vertically. Press  $\triangleright$  or  $\triangleleft$  to scale the graph horizontally.

Press the F1 key to delete this record. Press the function key YES (Menu) to confirm the deletion. To cancel the deletion, press the function key NO (Menu).

### 6) Delete All Record

Press the function key DELETE (Menu) to delete all record events. Press the function key YES (Menu) to confirm. To cancel the operation, press the function key NO (Menu).

## 21.Communication

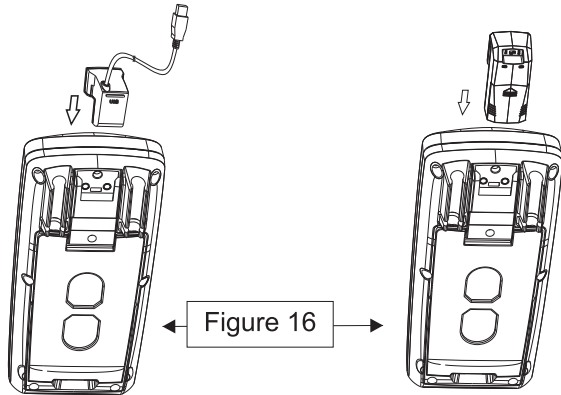

USB Communication Bluetooth Communication (optional)

Turn on communication via settings (see detailed operations in the meter settings). The symbol  will appear in the upper left corner on the display as shown in Figure 16.

The meter carries on USB communication with USB cable (standard accessory) connecting to PC. The meter can use bluetooth module (optional) and mobile phone for bluetooth communication.

## X. Maintenance and Repair

### 1. General Maintenance and Repair

Regularly clean the meter case with damp cloth and mild detergent. Do not use abrasives, isopropyl alcohol or solvents. Dirt or moisture on the terminals can affect readings but also enable the warning function mistakenly due to mis-insertion. Clean the terminals according to the following steps:

- 1) Turn off the meter and remove all test leads.
- 2) Clean up the dirt on the terminals.
- 3) Soak a clean cotton swab in mild detergent and water. Clean each terminal with the cotton swab. Dry each terminal with canned compressed air to force water and detergent to flow out of the terminals.
- 4) In case of anything abnormal for the meter, stop using it and send it for repair.
- 5) When the meter needs to be verified or repaired, qualified service personnel or designated maintenance department are required to repair it.

### 2. Testing Fuse

As shown in Figure 17, the measurement of the meter is for resistance function. Insert a test lead into the terminal as shown in Figure 17 and contact the probe tip at the other end of test lead with the metal in the terminal of current input. If the message "Lead Error!" (connection error for test lead) appears, it shows that the probe tip is

inserted too deeply in the terminal of current input. Draw out the test lead a little until the error message disappears and 0L (overload) or resistance reading appears on the display. If the resistance reading for A terminal is less than  $0.50\Omega$ , it shows that the fuse F2 is normal. If the reading is 0L, you need to replace F2; If the resistance reading of  $\mu A$  m is less than  $1.2M\Omega$ , it shows that the fuse F1 is normal. If the reading is 0L, F1 needs to be replaced;

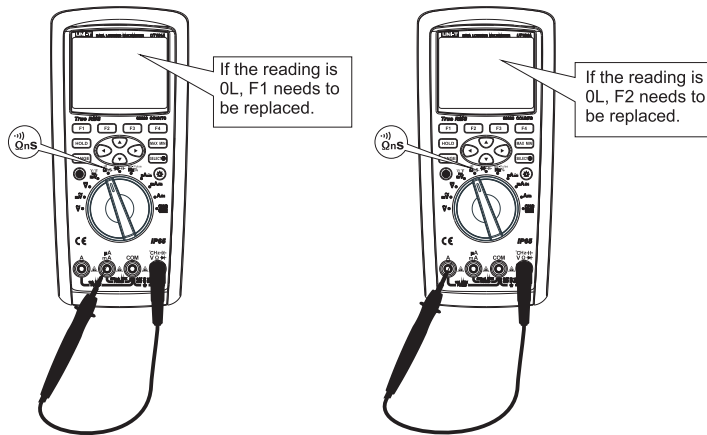

Figure 17

### 3. Replacing Fuse

Inspect or replace the meter fuse as shown in Figure 18 according to the following steps:

- 1) Turn off the meter and remove the test leads from the terminals.
- 2) Use a flat-head screwdriver to turn a counterclockwise semicycle for the screw on the battery cover then remove the battery cover.
- 3) Gently pry one end of the fuse and then remove the fuse from the clip.
- 4) The required fuse installed for mA or  $\mu A$  input terminal: 0.8A H 1000V Fuse Type 6X32mm(F1) The required fuse installed for A input terminal: 10A H 1000V Fuse Type 10X38 mm (F2)
- 5) Reinstall the battery cover and then turn the screw clockwise semicycle to tighten the battery cover.

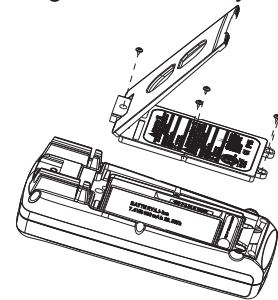



Figure 18

## 4. Battery charge

When the indicator of battery level in upper right corner is less than 5% of full capacity, the meter should be immediately charged, otherwise it will affect the measurement accuracy. As shown in Figure 19, set the rotary switch to , the string "Please plug in AC adapter!" on the display prompt you to insert a power adapter for charging. Connect the power connector to the four terminals in the meter, then insert the power adapter into the power connector. The character "Charging" on the display indicates it is in charging with a red light 5 % stepped in charging process. When the battery is fully charged, the red light is off and the charging process action stops.

### ⚠ Attention:

You must use the power adapter specified by the manufacturer.

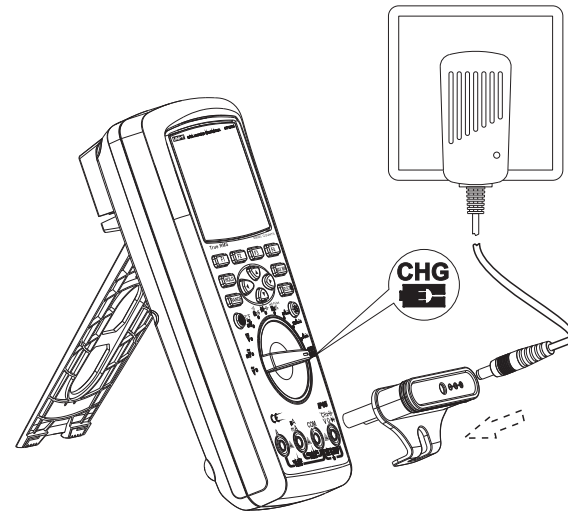

Figure 19

**UNI-T®**

**UNI-TREND TECHNOLOGY (CHINA) CO., LTD.**

No6, Gong Ye Bei 1st Road,  
Songshan Lake National High-Tech Industrial  
Development Zone, Dongguan City,  
Guangdong Province, China  
Tel: (86-769) 8572 3888  
<http://www.uni-trend.com>