

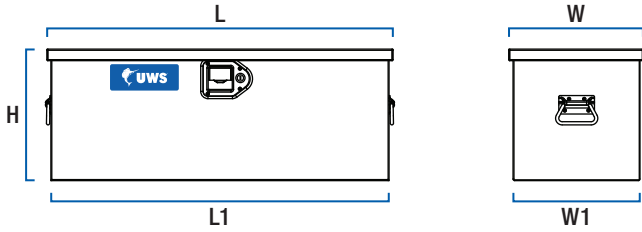

ATV TOOL BOXES

Diagram is representative. Your specific configuration may differ.



ATV Tool Boxes			Dimensions (inches)				
Part#	Finish	Cubic Feet	L	L1	W	W1	H
ATV	Bright aluminum	2.7	32.875	32	12.875	12	13.125
ATV-BLK	Gloss black	2.7	32.875	32	12.875	12	13.125



UTV TOOL BOXES

Diagram is representative. Your specific configuration may differ.

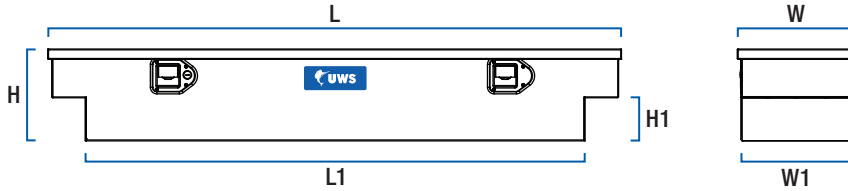

UTV Tool Boxes													
Make	Model	Style	Years	Kit (Box and hardware)	Box Only	Hardware Only	Cubic Feet	Dimensions (inches)					
				Matte Black#	Box#	Hardware#		L	L1	W	W1	H	H1
Can-Am	Defender	Full-size	16 - 18	8500002	UTV-59-MB	UTV-59CA	3.2	59.75	52	12.25	11.5	10.25	4.5
Honda	Pioneer	1000	17 - 18	8500004	UTV-59-MB	UTV-59HP	3.2	59.75	52	12.25	11.5	10.25	4.5
Kawasaki	Mule	Pro FXT	12 - 18	8500003	UTV-59-MB	UTV-59KM	3.2	59.75	52	12.25	11.5	10.25	4.5
Polaris	Ranger	Full-size	08 - 18	8500000	UTV-59-MB	UTV-59PR	3.2	59.75	52	12.25	11.5	10.25	4.5
Yamaha	Viking	Full-size	13 - 18	8500001	UTV-59-MB	UTV-59YV	3.2	59.75	52	12.25	11.5	10.25	4.5



EXTRA WIDE CROSSOVER TOOL BOXES

Standard tub, no rail

Diagram is representative. Your specific configuration may differ.

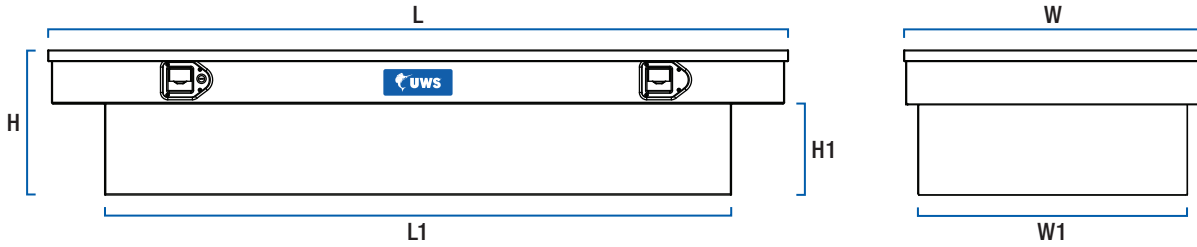

Extra-Wide Crossover Tool Boxes											
Part#	Profile	Finish	Angled	Rail	Cubic Feet	Dimensions (inches)					
						L	L1	W	W1	H	H1
Standard Tub											
TBS-69-LBTA	Standard	Bright alum.	No	No	12.2	69.875	59	28.125	25.25	14	8.5
TBS-69-LBTA-BLK	Standard	Gloss black	No	No	12.2	69.875	59	28.125	25.25	14	8.5
TBS-72-LBTA	Standard	Bright alum.	No	No	12.7	72.875	62	28.125	25.25	14	8.5
TBS-72-LBTA-BLK	Standard	Gloss black	No	No	12.7	72.875	62	28.125	25.25	14	8.5
Deep Tub											
TBSD-69-LBTA	Standard	Bright alum.	No	No	16.7	69.875	59	28.125	25.25	18.875	13.25
TBSD-69-LBTA-BLK	Standard	Gloss black	No	No	16.7	69.875	59	28.125	25.25	18.875	13.25
TBSD-72-LBTA	Standard	Bright alum.	No	No	17.1	72.875	62	28.125	25.25	18.875	13.25
TBSD-72-LBTA-BLK	Standard	Gloss black	No	No	17.1	72.875	62	28.125	25.25	18.875	13.25



GULL WING CROSSOVER TOOL BOXES

Standard tub, no rail

Diagram is representative. Your specific configuration may differ.

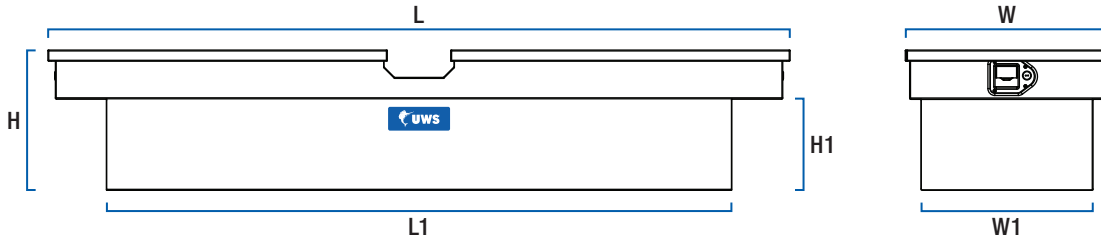

Gull Wing Crossover Tool Boxes											
Part#	Profile	Finish	Angled	Rail	Cubic Feet	Dimensions (inches)					
						L	L1	W	W1	H	H1
Standard Tub											
TB-60	Standard	Bright aluminum	No	No	7.3	60.875	50	20	17	14.75	9
TB-63	Standard	Bright aluminum	No	No	8	63.875	53	20	17	14.75	9
TB-69	Standard	Bright aluminum	No	No	8.5	69.875	59	20	17	14.75	9
TB-72	Standard	Bright aluminum	No	No	9	72.875	62	20	17	14.75	9
Deep Tub											
TBD-69	Standard	Bright aluminum	No	No	12.4	69.875	59	20	17	20.5	15
TBD-72	Standard	Bright aluminum	No	No	12.7	72.875	62	20	17	20.5	15



PULL HANDLE CROSSOVER TOOL BOXES

Standard tub, no rail

Diagram is representative. Your specific configuration may differ.

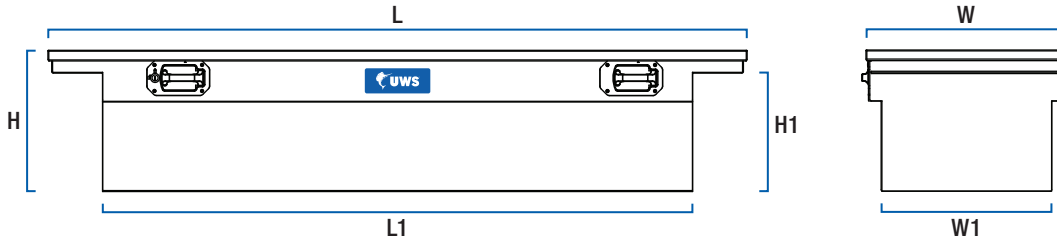

Pull Handle Crossover Tool Boxes											
Part#	Profile	Finish	Angled	Rail	Cubic Feet	Dimensions (inches)					
						L	L1	W	W1	H	H1
Standard Tub											
TBS-69-LP-PH	Low	Bright aluminum	No	No	8.4	69.875	59	20	17	14.5	11.75
TBS-69-LP-PH-BLK	Low	Gloss black	No	No	8.4	69.875	59	20	17	14.5	11.75
TBS-69-LP-PH-MB	Low	Matte black	No	No	8.4	69.875	59	20	17	14.5	11.75
TBS-72-LP-PH	Low	Bright aluminum	No	No	8.6	72.875	62	20	17	14.5	11.75
TBS-72-LP-PH-BLK	Low	Gloss black	No	No	8.6	72.875	62	20	17	14.5	11.75
TBS-72-LP-PH-MB	Low	Matte black	No	No	8.6	72.875	62	20	17	14.5	11.75



SECURE LOCK CROSSOVER TOOL BOXES

Standard tub, no rail

Diagram is representative. Your specific configuration may differ.

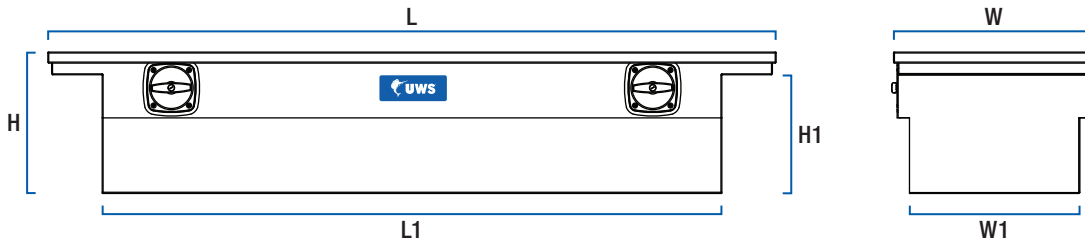

Deep, angled tub with lid rail

Diagram is representative. Your specific configuration may differ.

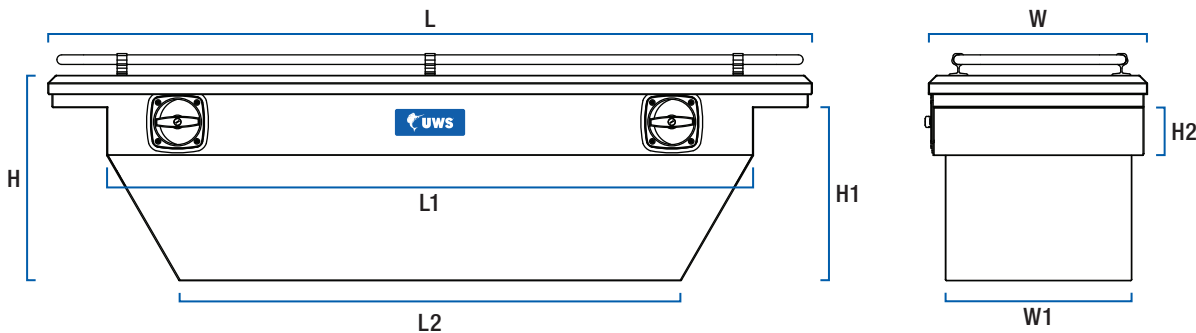

Secure Lock Crossover Tool Boxes

Part#	Profile	Finish	Angled	Rail	Cubic Feet	Dimensions (inches)							
						L	L1	L2	W	W1	H	H1	H2
Standard Tub													
SL-69-LP	Low	Bright alum.	No	No	8.4	69.875	59	--	20	17	14.5	11.75	--
SL-69-LP-MB	Low	Matte black	No	No	8.4	69.875	59	--	20	17	14.5	11.75	--
SL-69-LP-R	Low	Bright alum.	No	Yes	8.4	69.875	59	--	20	17	16.5	11.75	--
SL-69-LP-MB-R	Low	Matte black	No	Yes	8.4	69.875	59	--	20	17	16.5	11.75	--
SL-72-LP	Low	Bright alum.	No	No	8.6	72.875	62	--	20	17	14.5	11.75	--
SL-72-LP-MB	Low	Matte black	No	No	8.6	72.875	62	--	20	17	14.5	11.75	--
SL-72-LP-R	Low	Bright alum.	No	Yes	8.6	72.875	62	--	20	17	16.5	11.75	--
SL-72-LP-MB-R	Low	Matte black	No	Yes	8.6	72.875	62	--	20	17	16.5	11.75	--
Deep Tub													
SLD-69-A-LP*	Low	Bright alum.	Yes	No	10	69.875	59	46	20	17	18.75	15.875	4.375
SLD-69-A-LP-MB*	Low	Matte black	Yes	No	10	69.875	59	46	20	17	18.75	15.875	4.375
SLD-69-A-LP-R*	Low	Bright alum.	Yes	Yes	10	69.875	59	46	20	17	20.75	15.875	4.375
SLD-69-A-LP-MB-R*	Low	Matte black	Yes	Yes	10	69.875	59	46	20	17	20.75	15.875	4.375

* Built-in screwdriver holder not included



SLIM-LINE CROSSOVER TOOL BOXES

Standard tub, standard profile

Diagram is representative. Your specific configuration may differ.

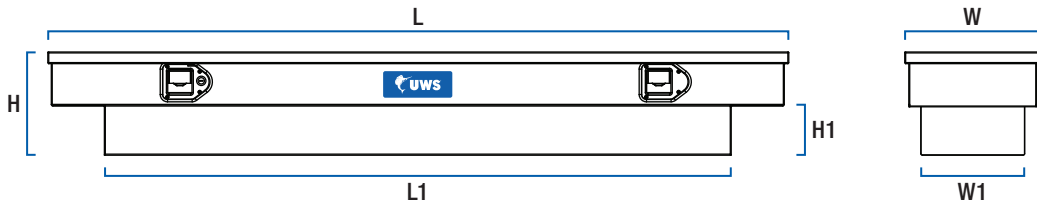

Standard tub, low profile

Diagram is representative. Your specific configuration may differ.

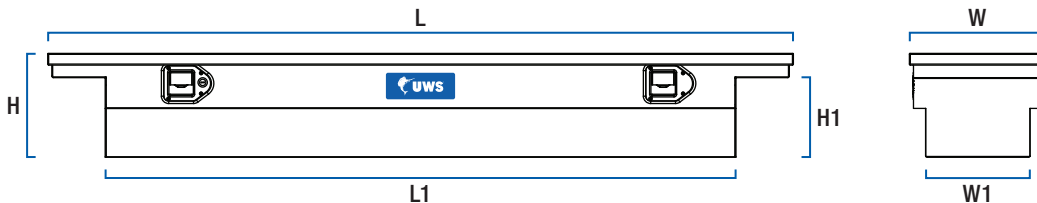

Slim-Line Crossover Tool Boxes

Part#	Profile	Finish	Angled	Rail	Cubic Feet	Dimensions (inches)					
						L	L1	W	W1	H	H1
Standard Tub											
TBS-60-SL	Standard	Bright alum.	No	No	3.2	60.875	50	12.75	9.75	10.375	4.625
TBS-60-SL-BLK	Standard	Gloss black	No	No	3.2	60.875	50	12.75	9.75	10.375	4.625
TBS-63-SL	Standard	Bright alum.	No	No	3.4	63.875	53	12.75	9.75	10.375	4.625
TBS-63-SL-BLK	Standard	Gloss black	No	No	3.4	63.875	53	12.75	9.75	10.375	4.625
TBS-69-SL	Standard	Bright alum.	No	No	3.8	69.875	59	12.75	9.75	10.375	4.625
TBS-69-SL-LP	Low	Bright alum.	No	No	3.5	69.875	59	12.75	9.75	10.375	7.5
TBS-69-SL-BLK	Standard	Gloss black	No	No	3.8	69.875	59	12.75	9.75	10.375	4.625
TBS-69-SL-LP-BLK	Low	Gloss black	No	No	3.5	69.875	59	12.75	9.75	10.375	7.5
TBS-72-SL	Standard	Bright alum.	No	No	3.9	72.875	62	12.75	9.75	10.375	4.625
TBS-72-SL-BLK	Standard	Gloss black	No	No	3.9	72.875	62	12.75	9.75	10.375	4.625
Deep Tub											
TBSD-69-SL	Standard	Bright alum.	No	No	6.4	69.875	59	12.75	9.75	18.3125	12.5
TBSD-69-SL-LP	Low	Bright alum.	No	No	6.1	69.875	59	12.75	9.75	18.3125	15.5
TBSD-69-SL-BLK	Standard	Gloss black	No	No	6.4	69.875	59	12.75	9.75	18.3125	12.5
TBSD-69-SL-LP-BLK	Low	Gloss black	No	No	6.1	69.875	59	12.75	9.75	18.3125	15.5
TBSD-72-SL	Standard	Bright alum.	No	No	6.7	72.875	62	12.75	9.75	18.3125	12.5
TBSD-72-SL-LP	Low	Bright alum.	No	No	6.5	72.875	62	12.75	9.75	18.3125	15.5
TBSD-72-SL-BLK	Standard	Gloss black	No	No	6.7	72.875	62	12.75	9.75	18.3125	12.5
TBSD-72-SL-LP-BLK	Low	Gloss black	No	No	6.5	72.875	62	12.75	9.75	18.3125	15.5



STANDARD CROSSOVER TOOL BOXES

Standard tub with rail

Diagram is representative. Your specific configuration may differ.

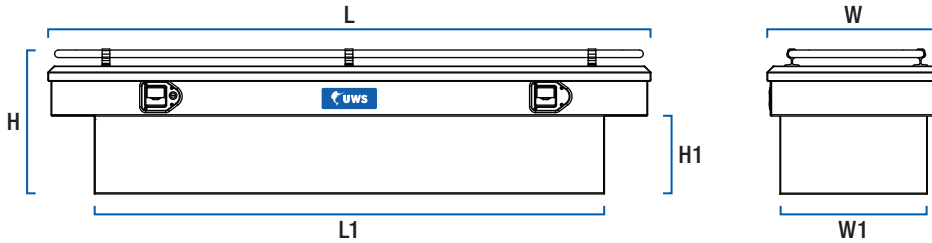

Deep, angled tub, no rail

Diagram is representative. Your specific configuration may differ.

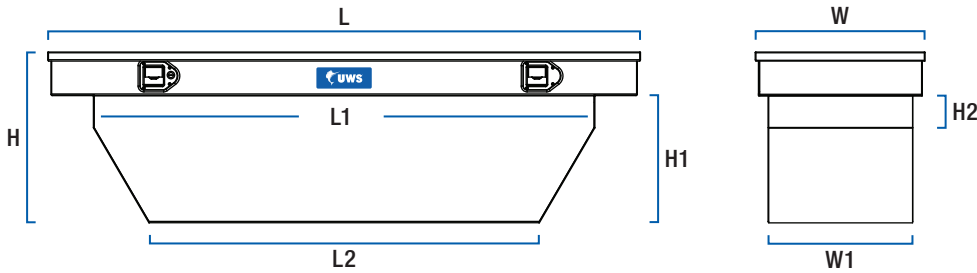

Standard Crossover Tool Boxes						Dimensions (inches)							
Part#	Profile	Finish	Angled	Rail	Cubic Feet	L	L1	L2	W	W1	H	H1	H2
						Standard Tub							
TBS-54	Standard	Bright alum.	No	No	6.9	54.875	44	--	20	17	14.75	9	--
TBS-54-LP	Low	Bright alum.	No	No	6.3	54.875	44	--	20	17	14.75	11.75	--
TBS-54-BLK	Standard	Gloss black	No	No	6.9	54.875	44	--	20	17	14.75	9	--
TBS-54-LP-BLK	Low	Gloss black	No	No	6.3	54.875	44	--	20	17	14.75	11.75	--
TBS-58	Standard	Bright alum.	No	No	7.1	58.875	48	--	20	17	14.75	9	--
TBS-58-LP	Low	Bright alum.	No	No	6.6	58.875	48	--	20	17	14.75	11.75	--
TBS-58-BLK	Standard	Gloss black	No	No	7.1	58.875	48	--	20	17	14.75	9	--
TBS-58-LP-BLK	Low	Gloss black	No	No	6.6	58.875	48	--	20	17	14.75	11.75	--
TBS-60	Standard	Bright alum.	No	No	7.4	60.875	50	--	20	17	14.75	9	--
TBS-60-LP	Low	Bright alum.	No	No	7.2	60.875	50	--	20	17	14.75	11.75	--
TBS-60-BLK	Standard	Gloss black	No	No	7.4	60.875	50	--	20	17	14.75	9	--
TBS-60-LP-BLK	Low	Gloss black	No	No	7.2	60.875	50	--	20	17	14.75	11.75	--
TBS-60-A*	Standard	Bright alum.	Yes	No	7	60.875	50	35.75	20	17	14.75	9	3
TBS-60-A-LP*	Low	Bright alum.	Yes	No	6.6	60.875	50	35.75	20	17	14.75	11.75	3.125

* Built-in screwdriver holder not included

Part number listing continued on the following page



STANDARD CROSSOVER TOOL BOXES

Standard Crossover Tool Boxes

Part#	Profile	Finish	Angled	Rail	Cubic Feet	Dimensions (inches)							
						L	L1	L2	W	W1	H	H1	H2
Standard Tub (continued)													
TBS-60-A-BLK*	Standard	Gloss black	Yes	No	7	60.875	50	35.75	20	17	14.75	9	3
TBS-60-A-LP-BLK*	Low	Gloss black	Yes	No	6.6	60.875	50	35.75	20	17	14.75	11.75	3.125
TBS-63	Standard	Bright alum.	No	No	7.8	63.875	53	--	20	17	14.75	9	--
TBS-63-LP	Low	Bright alum.	No	No	7.3	63.875	53	--	20	17	14.75	11.75	--
TBS-63-BLK	Standard	Gloss black	No	No	7.8	63.875	53	--	20	17	14.75	9	--
TBS-63-LP-BLK	Low	Gloss black	No	No	7.3	63.875	53	--	20	17	14.75	11.75	--
TBS-63-A*	Standard	Bright alum.	Yes	No	7.4	63.875	53	38.75	20	17	14.75	9	3
TBS-63-A-LP*	Low	Bright alum.	Yes	No	7	63.875	53	38.75	20	17	14.75	11.75	2.875
TBS-63-A-BLK*	Standard	Gloss black	Yes	No	7.4	63.875	53	38.75	20	17	14.75	9	3
TBS-63-A-LP-BLK*	Low	Gloss black	Yes	No	7	63.875	53	38.75	20	17	14.75	11.75	2.875
TBS-63-A-LP-MB*	Low	Matte black	Yes	No	7	63.875	53	38.75	20	17	14.75	11.75	2.875
TBS-66	Standard	Bright alum.	No	No	8.2	66.875	56	--	20	17	14.75	9	--
TBS-66-LP	Low	Bright alum.	No	No	7.5	66.875	56	--	20	17	14.75	11.75	--
TBS-66-BLK	Standard	Gloss black	No	No	8.2	66.875	56	--	20	17	14.75	9	--
TBS-66-LP-BLK	Low	Gloss black	No	No	7.5	66.875	56	--	20	17	14.75	11.75	--
TBS-69	Standard	Bright alum.	No	No	8.6	69.875	59	--	20	17	14.75	9	--
TBS-69-LP	Low	Bright alum.	No	No	8.4	69.875	59	--	20	17	14.75	11.75	--
TBS-69-BLK	Standard	Gloss black	No	No	8.6	69.875	59	--	20	17	14.75	9	--
TBS-69-LP-BLK	Low	Gloss black	No	No	8.4	69.875	59	--	20	17	14.75	11.75	--
TBS-69-MB	Standard	Matte black	No	No	8.6	69.875	59	--	20	17	14.75	9	--
TBS-69-LP-MB	Low	Matte black	No	No	8.4	69.875	59	--	20	17	14.75	11.75	--
TBS-69-A-LP*	Low	Bright alum.	Yes	No	8.3	69.875	59	48	20	17	14.75	11.75	2.875
TBS-69-A-LP-BLK*	Low	Gloss black	Yes	No	8.3	69.875	59	48	20	17	14.75	11.75	2.875
TBS-69-LBTA	Standard	Bright alum.	No	No	12.2	69.875	59	--	28.125	25.25	14	8.5	--
TBS-69-LBTA-BLK	Standard	Gloss black	No	No	12.2	69.875	59	--	28.125	25.25	14	8.5	--
TBS-69-R	Standard	Bright alum.	No	Yes	8.6	69.875	59	--	20	17	14.75	9	--
TBS-69-LP-R	Low	Bright alum.	No	Yes	8.4	69.875	59	20	17	16.75	11.75		--
TBS-72	Standard	Bright alum.	No	No	9	72.875	62	--	20	17	14.75	9	--
TBS-72-LP	Low	Bright alum.	No	No	8.6	72.875	62	--	20	17	14.75	11.75	--
TBS-72-BLK	Standard	Gloss black	No	No	9	72.875	62	--	20	17	14.75	9	--
TBS-72-LP-BLK	Low	Gloss black	No	No	8.6	72.875	62	--	20	17	14.75	11.75	--
TBS-72-MB	Standard	Matte black	No	No	9	72.875	62	--	20	17	14.75	9	--
TBS-72-LP-MB	Low	Matte black	No	No	8.6	72.875	62	--	20	17	14.75	11.75	--
TBS-72-LBTA	Standard	Bright alum.	No	No	12.7	72.875	62	--	28.125	25.25	14	8.5	--
TBS-72-LBTA-BLK	Standard	Gloss black	No	No	12.7	72.875	62	--	28.125	25.25	14	8.5	--
TBS-72-R	Standard	Bright alum.	No	Yes	9	72.875	62	--	20	17	14.75	9	--

* Built-in screwdriver holder not included

Part number listing continued on the following page



STANDARD CROSSOVER TOOL BOXES

Standard Crossover Tool Boxes

Part#	Profile	Finish	Angled	Rail	Cubic Feet	Dimensions (inches)							
						L	L1	L2	W	W1	H	H1	H2
Deep Tub													
TBSD-60A*	Standard	Bright alum.	Yes	No	7.5	60.875	50	38	20	17	20.75	15	--
TBSD-60A-LP	Low	Bright alum.	Yes	No	6.3	60.875	50	35.75	20	17	17.75	14.875	2.875
TBSD-60A-BLK*	Standard	Gloss black	Yes	No	7.5	60.875	50	38	20	17	20.75	15	--
TBSD-60A-LP-BLK	Low	Gloss black	Yes	No	6.3	60.875	50	35.75	20	17	17.75	14.875	2.875
TBSD-63	Standard	Bright alum.	No	No	7.7	63.875	53	--	20	17	20.75	15	--
TBSD-63A*	Standard	Bright alum.	Yes	No	7.7	63.875	53	40	20	17	20.75	15.875	--
TBSD-63A-LP*	Low	Bright alum.	Yes	No	6.8	63.875	53	36	20	17	17.75	15.875	2.875
TBSD-63A-BLK*	Standard	Gloss black	Yes	No	7.7	63.875	53	40	20	17	20.75	15	--
TBSD-63A-LP-BLK*	Low	Gloss black	Yes	No	6.8	63.875	53	36	20	17	17.75	14.875	2.875
TBSD-69	Standard	Bright alum.	No	No	12.4	69.875	59	--	20	17	20.75	15	--
TBSD-69-LP	Low	Bright alum.	No	No	10.8	69.875	59	--	20	17	18.75	15.875	--
TBSD-69-BLK	Standard	Gloss black	No	No	12.4	69.875	59	--	20	17	20.75	15	--
TBSD-69-LP-BLK	Low	Gloss black	No	No	10.8	69.875	59	--	20	17	18.75	15.875	--
TBSD-69-A	Standard	Bright alum.	Yes	No	10.2	69.875	59	46	20	17	20.75	15	3.78
TBSD-69-A-LP*	Low	Bright alum.	Yes	No	10	69.875	59	46	20	17	18.75	15.875	2.875
TBSD-69-A-BLK	Standard	Gloss black	Yes	No	10.2	69.875	59	46	20	17	20.75	15	3.75
TBSD-69-A-LP-BLK*	Low	Gloss black	Yes	No	10	69.875	59	46	20	17	18.75	15.875	2.875
TBSD-69-A-MB	Standard	Matte black	Yes	No	10.2	69.875	59	46	20	17	20.75	15	3.75
TBSD-69-A-LP-MB*	Low	Matte black	Yes	No	10	69.875	59	46	20	17	18.75	15.875	2.875
TBSD-69-LBTA	Standard	Bright alum.	No	No	16.7	69.875	59	--	28.125	25.25	18.875	13.25	--
TBSD-69-LBTA-BLK	Standard	Gloss black	No	No	16.7	69.875	59	--	28.125	25.25	18.875	13.25	--
TBSD-72-A	Standard	Bright alum.	Yes	No	12.6	72.875	62	56	20	17	20.75	15	12
TBSD-72-A-LP	Low	Bright alum.	Yes	No	11.2	72.875	62	56	20	17	18.75	15.875	2.875
TBSD-72-A-BLK	Standard	Gloss black	Yes	No	12.6	72.875	62	56	20	17	20.75	15	12
TBSD-72-A-LP-BLK	Low	Gloss black	Yes	No	11.2	72.875	62	56	20	17	18.75	15.875	2.875
TBSD-72-LBTA	Standard	Bright alum.	No	No	17.1	72.875	62	--	28.125	25.25	18.875	13.25	--
TBSD-72-LBTA-BLK	Standard	Gloss black	No	No	17.1	72.875	62	--	28.125	25.25	18.875	13.25	--

* Built-in screwdriver holder not included



NORTHERN DOG BOX

Diagram is representative. Your specific configuration may differ.

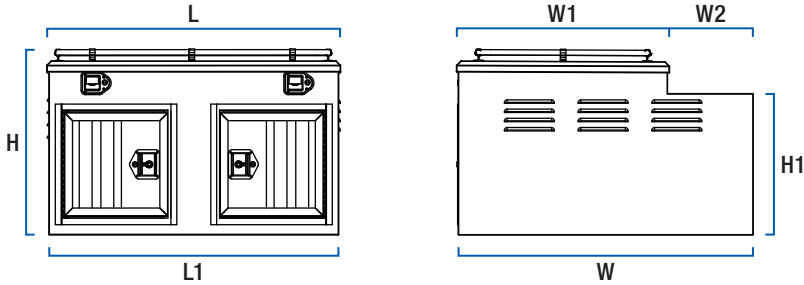

Northern Dog Box				Dimensions (inches)						
Part#	Finish	Cubic Feet	Doors	L	L1	W	W1	W2	H	H1
DB-4848N	Bright aluminum	35.2	2	48	47.1875	48.25	34.625	13.625	28.125	23

DOG BOX ACCESSORY BOX

Diagram is representative. Your specific configuration may differ.

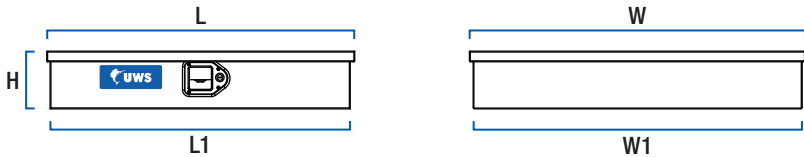

Accessory Box			Dimensions (inches)				
Part#	Finish	Cubic Feet	L	L1	W	W1	H
TCB-34	Bright aluminum	3.4	31.875	31	35	34	6.625



SOUTHERN DOG BOX

Diagram is representative. Your specific configuration may differ.

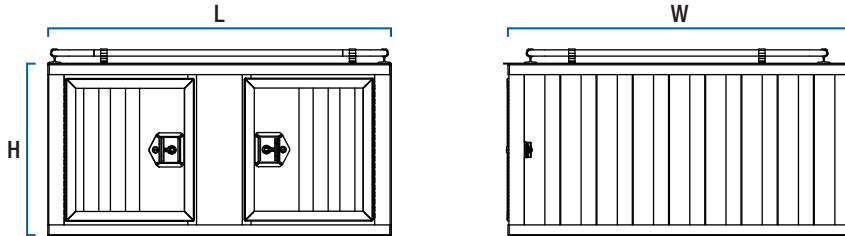

Southern Dog Boxes				Dimensions (inches)		
Part#	Finish	Cubic Feet	Doors	L	W	H
DB-3636	Bright aluminum	18	1	36	36	24
DB-4848	Bright aluminum	32	2	48	48	24

DOG BOX ACCESSORY BOX

Diagram is representative. Your specific configuration may differ.

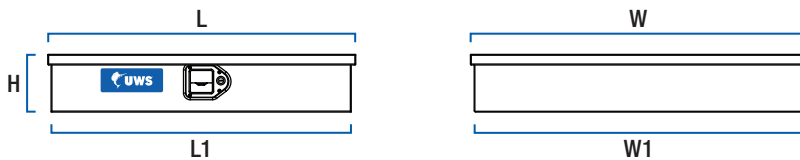

Accessory Box			Dimensions (inches)				
Part#	Finish	Cubic Feet	L	L1	W	W1	H
TCB-34	Bright aluminum	3.4	31.875	31	35	34	6.625



DRAWER TRUCK TOOL BOXES

Diagram is representative. Your specific configuration may differ.

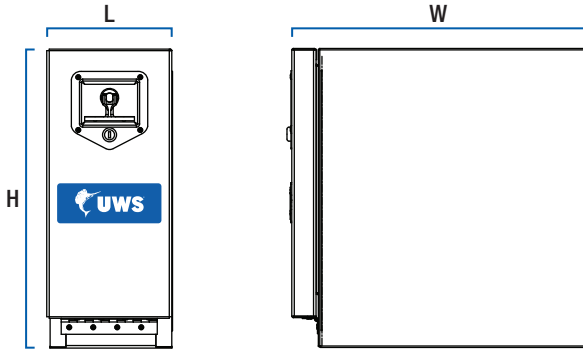

Drawer Truck Tool Boxes					
Part#	Finish	Cubic Feet	Dimensions (inches)		
			W	L	H
DS-18	Bright aluminum	1.5	18	7.75	18.75
DS-18-BLK	Gloss black	1.5	18	7.75	18.75
DS-22	Bright aluminum	1.9	22	7.75	18.75
DS-22-BLK	Gloss black	1.9	22	7.75	18.75



UTILITY CHEST BOXES WITH DRAWERS

Diagram is representative. Your specific configuration may differ.

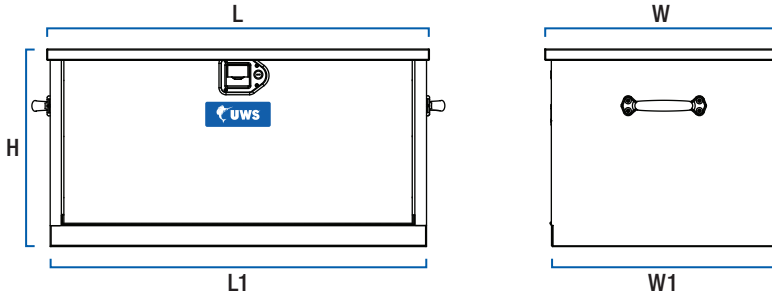

Utility Chest Boxes with Drawers

Part#	Finish	Cubic Feet	Drawers	Dimensions (inches)				
				L	L1	W	W1	H
TBC-38-DS	Bright aluminum	10.1	2	38	37	23	21.875	20
TBC-38-DS-BLK	Gloss black	10.1	2	38	37	23	21.875	20



TOPSIDE TOOL BOXES

One-door

Diagram is representative. Your specific configuration may differ.

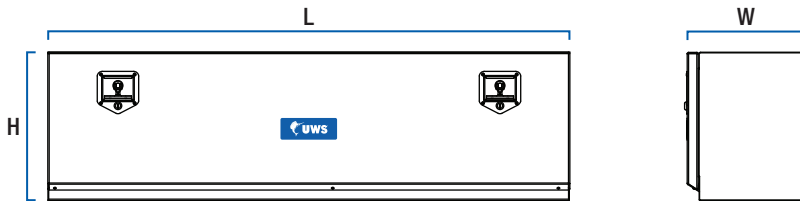

Two-door

Diagram is representative. Your specific configuration may differ.

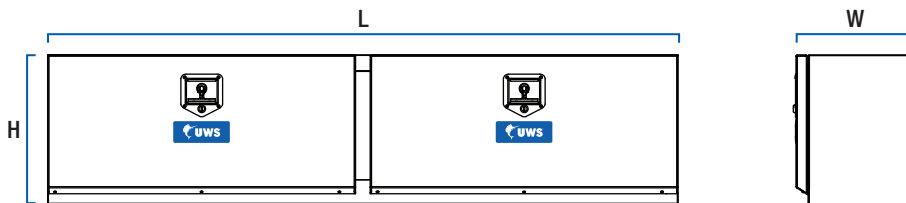

Topside Truck Tool Boxes

Part#	Finish	Cubic Feet	Door Size	Doors	Dimensions (inches)		
					L	W	H
TBTS-48	Bright aluminum	6.3	12" x 42.5"	1	48	13.685	17
TBTS-48-BLK	Gloss black	6.3	12" x 42.5"	1	48	13.685	17
TBTS-60	Bright aluminum	7.8	12" x 55.5"	1	60	13.685	17
TBTS-60-BLK	Gloss black	7.8	12" x 55.5"	1	60	13.685	17
TBTS-72	Bright aluminum	9.4	12" x 30.5"	2	72	13.685	17
TBTS-72-BLK	Gloss black	9.4	12" x 30.5"	2	72	13.685	17
TBTS-90	Bright aluminum	11.7	12" x 39.5"	2	90	13.685	17
TBTS-90-BLK	Gloss black	11.7	12" x 39.5"	2	90	13.685	17
TBTS-96	Bright aluminum	12.5	12" x 42.5"	2	96	13.685	17
TBTS-96-BLK	Gloss black	12.5	12" x 42.5"	2	96	13.685	17



TRUCK FENDER TOOL BOXES

Diagram is representative. Your specific configuration may differ.

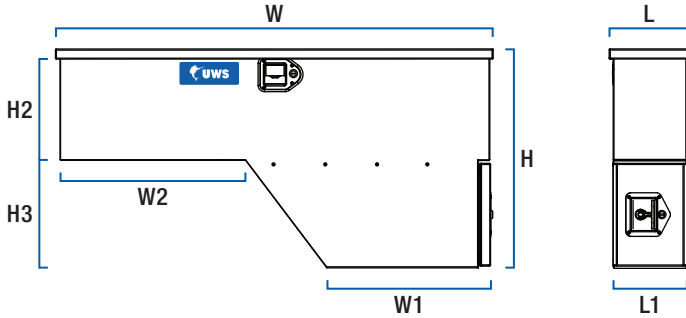

Truck Fender Tool Boxes

Part#	Finish	Vehicle Side	Cubic Feet	Dimensions (inches)							
				L	L1	W	W1	W2	H	H2	H3
FW-48-DS-P	Bright aluminum	Passenger	3.9	8.75	8	47.875	18	20.25	24.625	12.8125	11.75
FW-48-DS-P-BLK	Gloss black	Passenger	3.9	8.75	8	47.875	18	20.25	24.625	12.8125	11.75
FW-48-DS-D	Bright aluminum	Driver	3.9	8.75	8	47.875	18	20.25	24.625	12.8125	11.75
FW-48-DS-D-BLK	Gloss black	Driver	3.9	8.75	8	47.875	18	20.25	24.625	12.8125	11.75
FW-55-DS-P	Bright aluminum	Passenger	4.4	8.75	8	55.875	20	26	24.625	12.8125	11.75
FW-55-DS-D	Bright aluminum	Driver	4.4	8.75	8	55.875	20	26	24.625	12.8125	11.75
FW-55-DS-D-BLK	Gloss black	Driver	4.4	8.75	8	55.875	20	26	24.625	12.8125	11.75



TRUCK SIDE TOOL BOXES

Standard profile, single lock

Diagram is representative. Your specific configuration may differ.

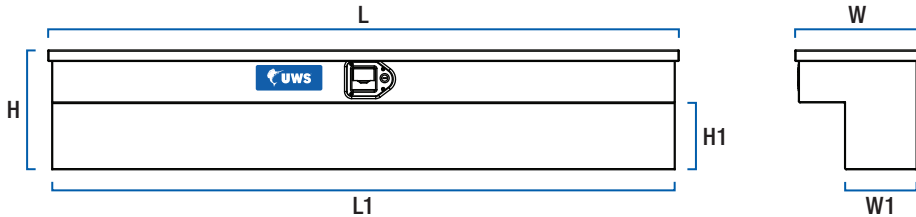

Low profile, single lock

Diagram is representative. Your specific configuration may differ.

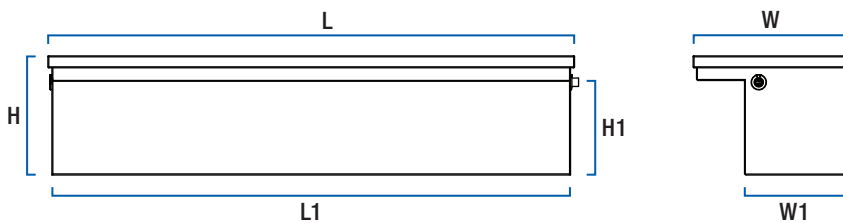

Truck Side Tool Boxes										
Part#	Finish	Angled	Rail	Cubic Feet	Dimensions (inches)					
					L	L1	W	W1	H	H1
Standard										
TBSM-36	Bright aluminum	No	No	2.2	36.875	36	12	7	12	6.5
TBSM-48	Bright aluminum	No	No	3	48.875	48	12	7	12	6.5
TBSM-48-BLK	Gloss black	No	No	3	48.875	48	12	7	12	6.5
TBSM-60	Bright aluminum	No	No	3.7	60.875	60	12	7	12	6.5
TBSM-60-BLK	Gloss black	No	No	3.7	60.875	60	12	7	12	6.5
TBSM-72	Bright aluminum	No	No	4.2	72.875	72	12	7	12	6.5
TBSM-72-BLK	Gloss black	No	No	4.2	72.875	72	12	7	12	6.5
TBSM-96	Bright aluminum	No	No	5.7	96.875	96	12	7	12	6.5
Low Profile										
TBSM-36-LP	Bright aluminum	No	No	2.3	36.75	36	14.375	9.25	11.75	8.75
TBSM-36-LP-BLK	Gloss black	No	No	2.3	36.75	36	14.375	9.25	11.75	8.75
TBSM-36-LP-MB	Matte black	No	No	2.3	36.75	36	14.375	9.25	11.75	8.75
TBSM-48-LP	Bright aluminum	No	No	3	48.75	48	14.375	9.25	11.75	8.75
TBSM-48-LP-BLK	Gloss black	No	No	3	48.75	48	14.375	9.25	11.75	8.75
TBSM-48-LP-MB	Matte black	No	No	3	48.75	48	14.375	9.25	11.75	8.75



UNDERBODY TOOL BOXES

One-door

Diagram is representative. Your specific configuration may differ.

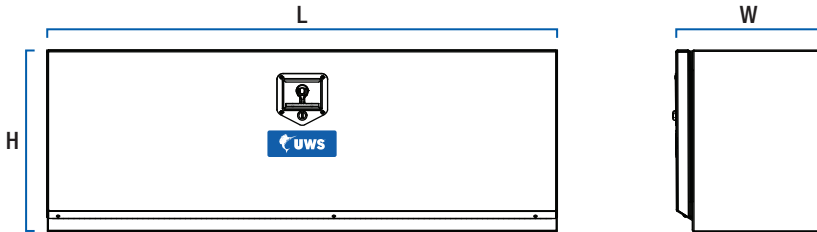

Two-door

Diagram is representative. Your specific configuration may differ.

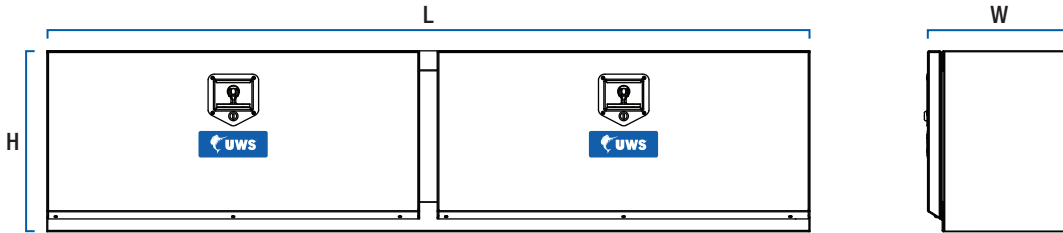

Underbody Tool Boxes

Part#	Finish	Cubic Feet	Door Opening	Doors	Dimensions (inches)		
					L	W	H
TBUB-24	Bright aluminum	4.6	13 x 19.5	1	24	19	18
TBUB-30	Bright aluminum	5.7	13 x 25.5	1	30	19	18
TBUB-36	Bright aluminum	6.9	13 x 31.5	1	36	19	18
TBUB-36-BLK	Gloss black	6.9	13 x 31.5	1	36	19	18
TBUB-48	Bright aluminum	9.2	13 x 43.5	1	48	19	18
TBUB-60	Bright aluminum	11	13 x 55.5	1	60	19	18
TBUB-72	Bright aluminum	12.9	13 x 30.5	2	72	19	18
TBUB-96	Bright aluminum	17.2	13 x 42.5	2	96	19	18



COMBO TRANSFER TANKS

Standard tool chest

Diagram is representative. Your specific configuration may differ.

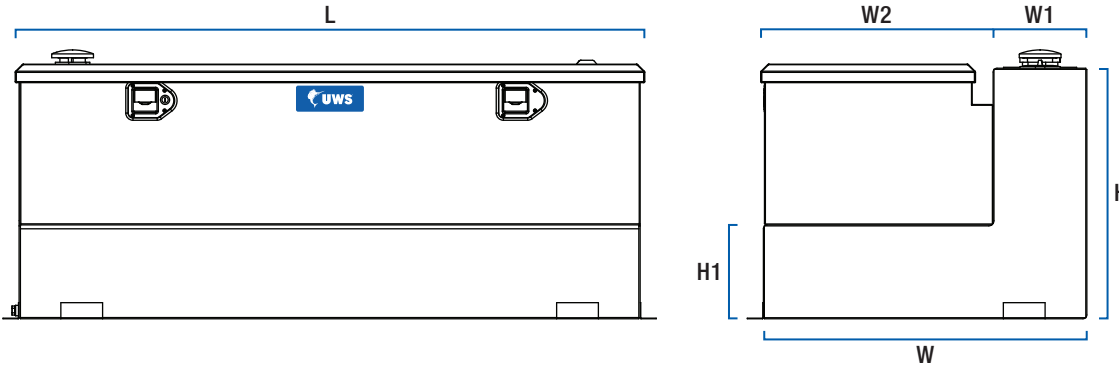

Angled tool chest

Diagram is representative. Your specific configuration may differ.

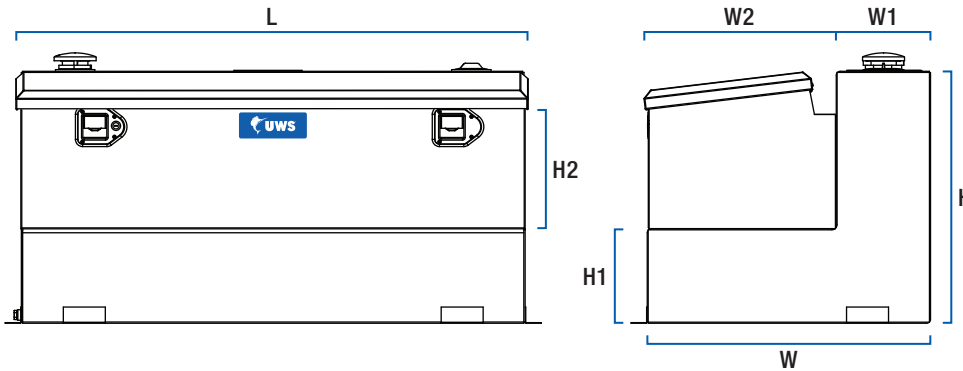

Combo Transfer Tanks

Part#	Finish	Gallons	Angled Lid	Cubic Feet	Dimensions (inches)						
					L	W	W1	W2	H	H1	H2
TT-45-COMBO	Bright aluminum	45	Yes	3.4	54.875	18.5	6	12	20.125	8	9
TT-45-COMBO-BLK	Gloss black	45	Yes	3.4	54.875	18.5	6	12	20.125	8	9
TT-50-COMBO	Bright aluminum	50	No	7	36.875	32.375	8	24	22.5	8	14.25
TT-50-COMBO-BLK	Gloss black	50	No	7	36.875	32.375	8	24	22.5	8	14.25
TT-75-COMBO	Bright aluminum	75	Yes	6.5	48.875	27.375	9	18	24	9	13
TT-75-COMBO-BLK	Gloss black	75	Yes	6.5	48.875	27.375	9	18	24	9	13
TT-85-COMBO	Bright aluminum	85	No	12	48.375	34.25	10	24	26.5	8	18
TT-85-COMBO-BLK	Gloss black	85	No	12	48.375	34.25	10	24	26.5	8	18
TT-100-COMBO	Bright aluminum	100	No	11.4	60.25	31.25	9	22	24.5	9	15
TT-100-CB-B	Gloss black	100	No	11.4	60.25	31.25	9	22	24.5	9	15
TT-101-COMBO	Bright aluminum	101	No	11.4	53.75	32.375	10	22	25.625	10	15
TT-101-CB-B	Gloss black	101	No	11.4	53.75	32.375	10	22	25.625	10	15

* Add 3" to dimension (A) for mounting bracket clearance



L-SHAPED TRANSFER TANKS

Diagram is representative. Your specific configuration may differ.

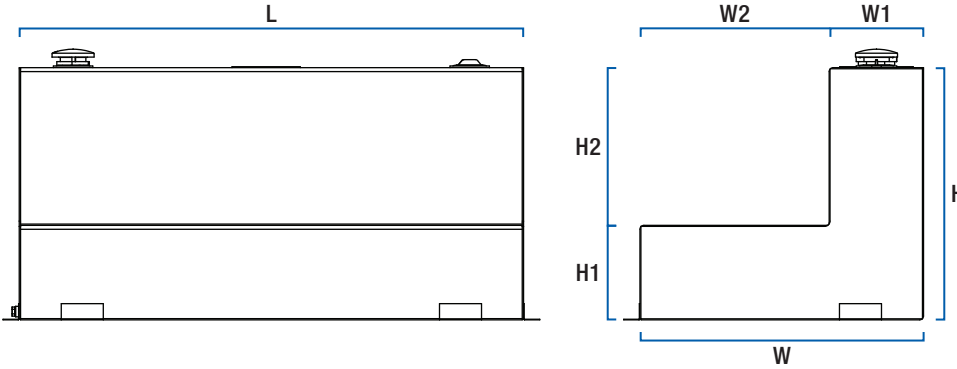

L-Shaped Transfer Tanks

Part#	Finish	Gallons	Dimensions (inches)						
			L	W	W1	W2	H	H1	H2
TT-50-L-T/P	Bright aluminum	50	36.25	32	8	24	22	8	14
TT-50-L-T/P-BLK	Gloss black	50	36.25	32	8	24	22	8	14
TT-75-L-T/P	Bright aluminum	75	48	27	9	18	24	9	15
TT-75-L-T/P-BLK	Gloss black	75	48	27	9	18	24	9	15
TT-85-L-T/P	Bright aluminum	85	48	34	10	24	26	8	18
TT-85-L-T/P-BLK	Gloss black	85	48	34	10	24	26	8	18
TT-100-L-T/P	Bright aluminum	100	59.5	31	9	22	24	9	15
TT-100-L-T/P-BLK	Gloss black	100	59.5	31	9	22	24	9	15
TT-101-L-T/P	Bright aluminum	101	53	32	10	22	25	10	15
TT-101-L-T/P-BLK	Gloss black	101	53	32	10	22	25	10	15

* Add 3" to dimension (A) for mounting bracket clearance



RECTANGULAR TRANSFER TANKS

Diagram is representative. Your specific configuration may differ.

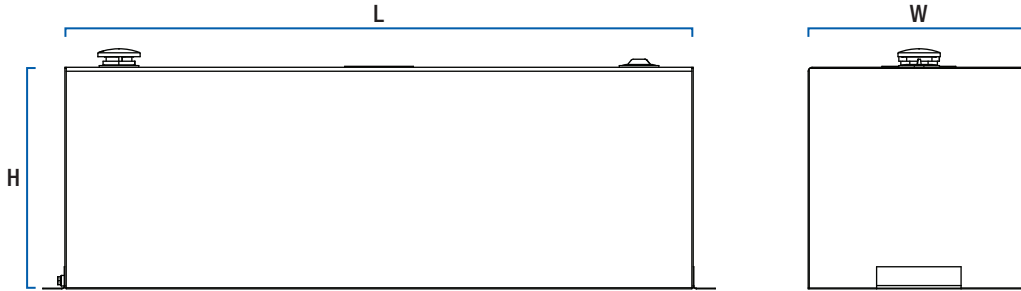

Rectangular Transfer Tanks					
Part#	Finish	Gallons	Dimensions (inches)		
			L	W	H
TT-45-R-T/P	Bright aluminum	45	54	10.5	19.5
TT-50-R-T/P	Bright aluminum	50	36	19	19
TT-100-R-T/P	Bright aluminum	100	59.5	21	21

*Add 3" to dimension (A) for mounting bracket clearance



5TH WHEEL UTILITY CHEST BOXES

Diagram is representative. Your specific configuration may differ.

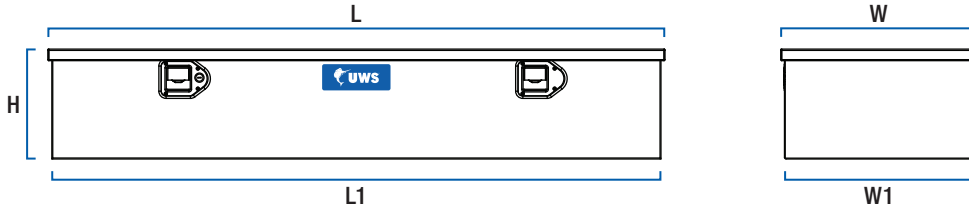

5th Wheel Utility Chest Boxes							
Part#	Finish	Cubic Feet	Dimensions (inches)				
			L	L1	W	W1	H
FWB-58	Bright aluminum	6.1	58.8125	58	18.75	18	11.125
FWB-58-BLK	Gloss black	6.1	58.8125	58	18.75	18	11.125



NOTCHED UTILITY CHEST BOXES

Diagram is representative. Your specific configuration may differ.

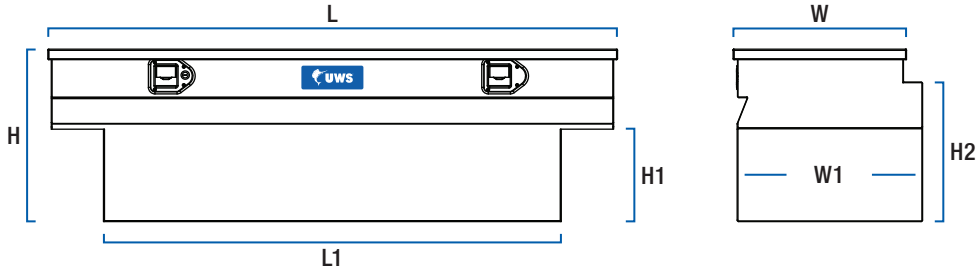

Notched Utility Chest Boxes			Dimensions (inches)						
Part#	Finish	Cubic Feet	L	L1	W	W1	H	H1	H2
TBC-60-N	Bright aluminum	10.3	59.8125	48	19.875	19.375	18.75	9.75	14.625
TBC-60-N-BLK	Gloss black	10.3	59.8125	48	19.875	19.375	18.75	9.75	14.625



SECURE LOCK UNDER TONNEAU UTILITY CHEST BOXES

Diagram is representative. Your specific configuration may differ.

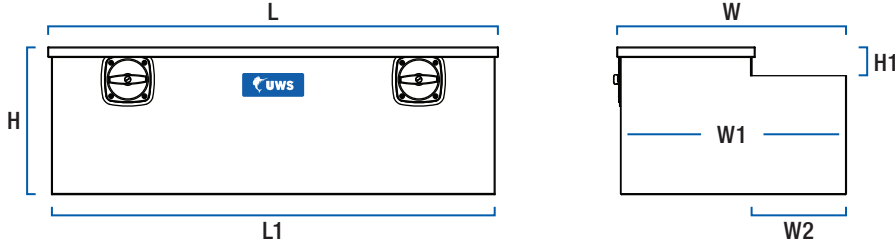

Secure Lock Under Tonneau Utility Chest Boxes

Part#	Finish	Cubic Feet	Dimensions (inches)						
			L	L1	W	W1	W2	H	H1
SLC-48	Bright aluminum	8.85	47.8125	47	24.375	24	9.6875	16.3125	3.6875
SLC-48-MB	Matte black	8.85	47.8125	47	24.375	24	9.6875	16.3125	3.6875



STANDARD UTILITY CHEST BOXES

Diagram is representative. Your specific configuration may differ.

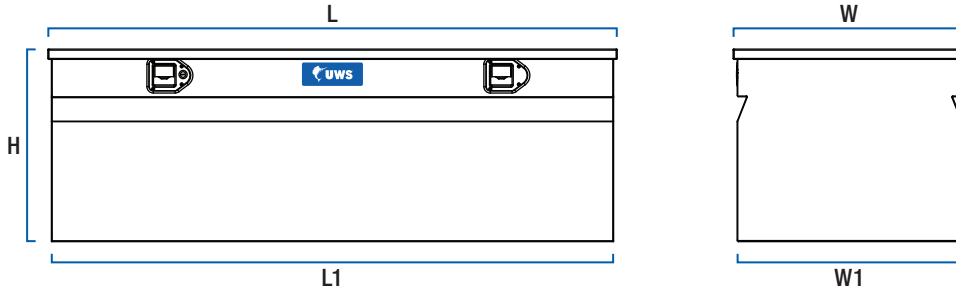

Standard Utility Chest Boxes

Part#	Finish	Cubic Feet	Dimensions (inches)				
			L	L1	W	W1	H
TBC-30	Bright aluminum	5.3	30.875	30	20	19.25	17.125
TBC-30-BLK	Gloss black	5.3	30.875	30	20	19.25	17.125
TBC-36	Bright aluminum	7.2	36.875	36	20	19.25	19
TBC-36-BLK	Gloss black	7.2	36.875	36	20	19.25	19
TBC-42	Bright aluminum	8.4	42.875	42	20	19.25	19
TBC-42-BLK	Gloss black	8.4	42.875	42	20	19.25	19
TBC-48	Bright aluminum	12.8	47.875	47	24.75	24	21.25
TBC-48-BLK	Gloss black	12.8	47.875	47	24.75	24	21.25
TBC-48-DD*	Bright aluminum	11.1	47.875	47	20.6875	20	21.125
TBC-60	Bright aluminum	16.7	30.875	30	20	19.25	17.125
TBC-60-BLK	Gloss black	16.7	30.875	30	20	19.25	17.125

* Designed to be used with #UWS-CARRIER



TOTE BOXES & FOOT LOCKERS

Tote box

Diagram is representative. Your specific configuration may differ.

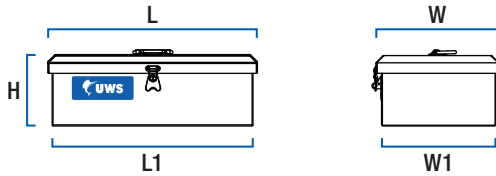

Foot locker

Diagram is representative. Your specific configuration may differ.

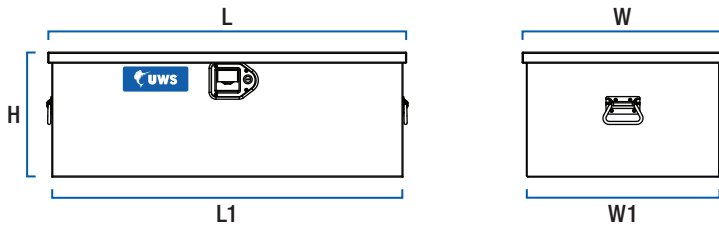

Tote Boxes & Foot Lockers							
Part#	Finish	Cubic Feet	Dimensions (inches)				
			L	L1	W	W1	H
Tote Boxes							
TB-1	Bright aluminum	0.8	20.875	20	12.25	11.41	7
TB-2	Bright aluminum	1.3	20.875	20	12.25	11.41	11.125
Foot Lockers							
FOOT-LOCKER	Bright aluminum	4.8	35.875	35	20	19.25	13.25
FOOT-LOCKER-BLK	Gloss black	4.8	35.875	35	20	19.25	13.25



TRAILER TONGUE TOOL BOXES

Diagram is representative. Your specific configuration may differ.

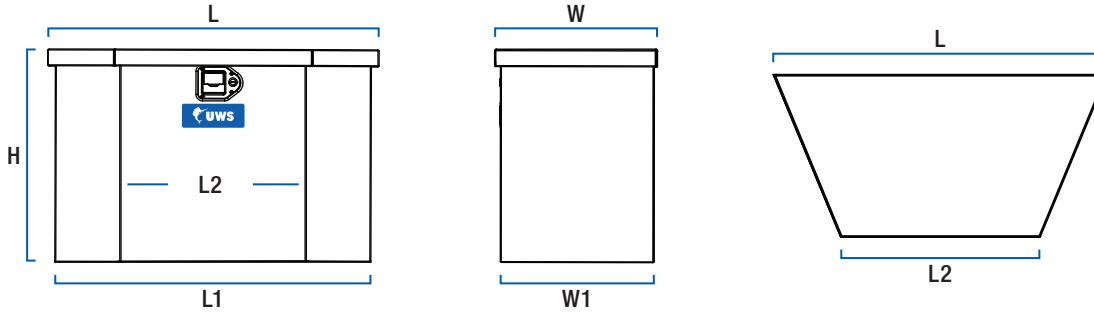

Trailer Tongue Boxes

Part#	Finish	Cubic Feet	Dimensions (inches)					
			L	L1	L2	W	W1	H
TBV-34	Bright aluminum	4.1	34.625	33	19.88	17	16	22
TBV-34-BLK	Gloss black	4.1	34.625	33	19.88	17	16	22
TBV-34-LP	Bright aluminum	2.9	34.625	33	19.88	17	16	13
TBV-34-LP-BLK	Gloss black	2.9	34.625	33	19.88	17	16	13
TBV-49	Bright aluminum	6.3	49.875	48	23.88	18.875	18	22
TBV-49-BLK	Gloss black	6.3	49.875	48	23.88	18.875	18	22



WEDGED UTILITY CHEST BOXES

Standard

Diagram is representative. Your specific configuration may differ.

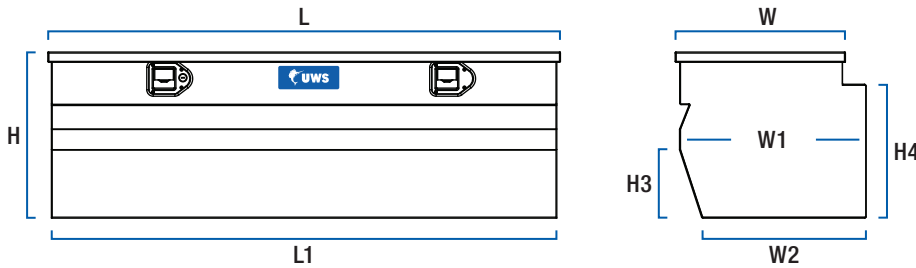

Angled

Diagram is representative. Your specific configuration may differ.

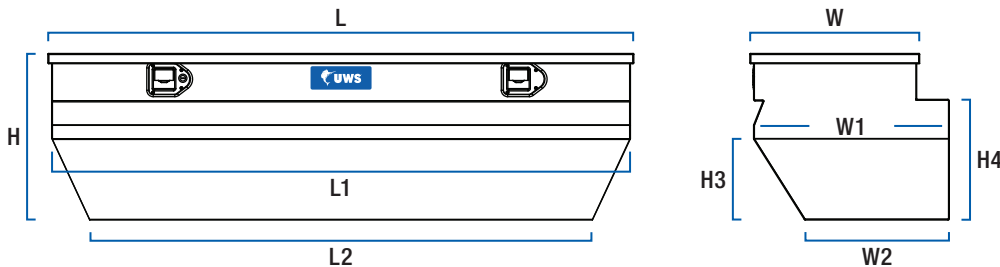

Wedged Utility Chest Boxes

Part#	Finish	Angled	Cubic Feet	Dimensions (inches)								
				L	L1	L2	W	W1	W2	H	H3	H4
TBC-36-W	Bright aluminum	No	7.2	36.875	36	--	20.375	20	17.625	18.5	7.3125	14.3125
TBC-36-W-BLK	Gloss black	No	7.2	36.875	36	--	20.375	20	17.625	18.5	7.3125	14.3125
TBC-42-W	Bright aluminum	No	8.4	42.875	42	--	20.375	20	17.625	18.5	7.3125	14.3125
TBC-42-W-BLK	Gloss black	No	8.4	42.875	42	--	20.375	20	17.625	18.5	7.3125	14.3125
TBC-48-W	Bright aluminum	No	9.6	48.875	48	--	20.375	20	17.625	18.5	7.3125	14.3125
TBC-48-W-BLK	Gloss black	No	9.6	48.875	48	--	20.375	20	17.625	18.5	7.3125	14.3125
TBC-55-W	Bright aluminum	No	11	54.875	54	--	20.375	20	17.625	18.5	7.3125	14.3125
TBC-55-W-BLK	Gloss black	No	11	54.875	54	--	20.375	20	17.625	18.5	7.3125	14.3125
TBC-55-WN	Bright aluminum	Yes	2.2	55.875	55	41	22	21.4375	17.5	20.8125	10.5	15.1875
TBC-55-WN-BLK	Gloss black	Yes	2.2	55.875	55	41	22	21.4375	17.5	20.8125	10.5	15.1875
TBC-60-W	Bright aluminum	No	12	60.875	60	--	20.375	20	17.625	18.5	7.3125	14.3125
TBC-60-W-BLK	Gloss black	No	12	60.875	60	--	20.375	20	17.625	18.5	7.3125	14.3125
TBC-62-WN	Bright aluminum	Yes	5.9	62.875	62	53.875	21.375	21	15.5625	18.5	8.75	13
TBC-62-WN-BLK	Gloss black	Yes	5.9	62.875	62	53.875	21.375	21	15.5625	18.5	8.75	13