

Country Pine Curved Corner

Rev. 6/6/08

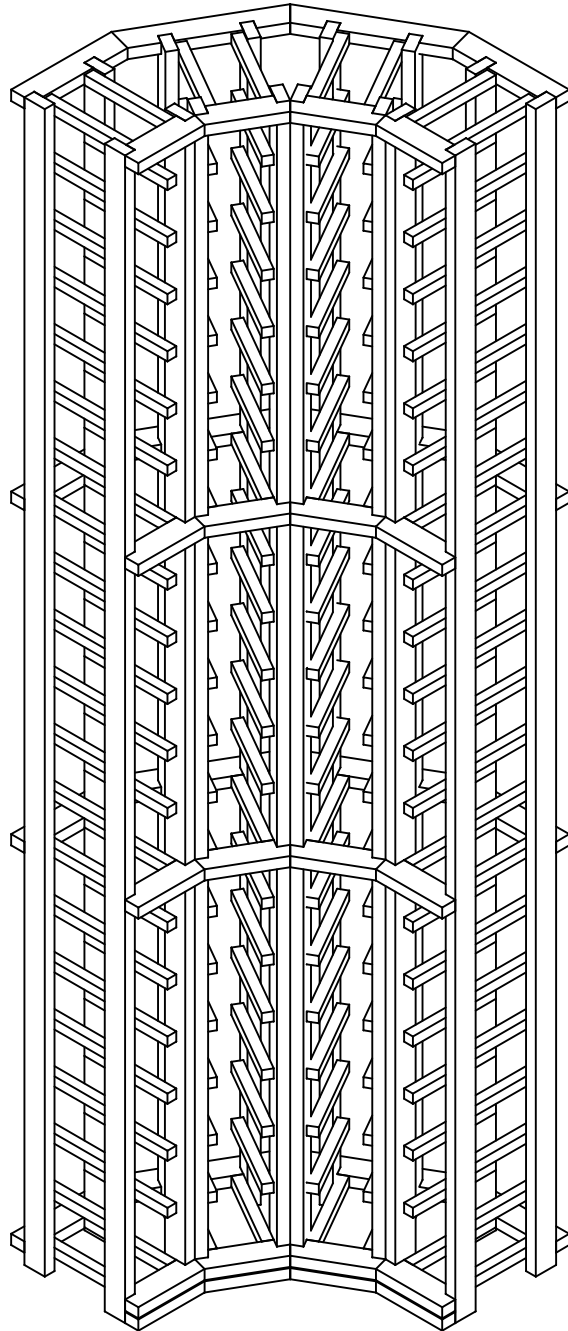

Wine Cellar Innovations
4575 Eastern Avenue
Cincinnati, Ohio 45226

Phone: (800) 229-9813
Fax: (513) 979-5280
www.winecellarinnovations.com

Parts List

Rev. 6/6/08

#	Qty.	Description
A:	4	Rear Spacer Bars
B:	5	Front Spacer Bars
C:	8	Racks
*	1	Bag of nails
*	1	Hardware Pack containing 2 angle brackets 2 plastic anchors 2 1" #8 screws 2 3/4" #6 screws

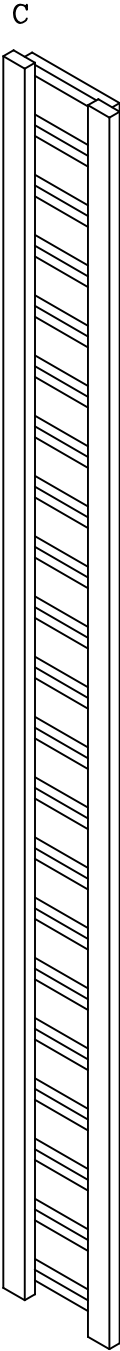
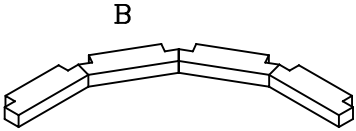
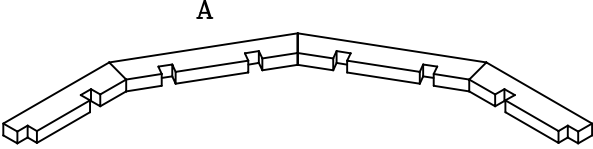

Step 1:

Attach (9) spacer bars to racks with nails

Nail through notches in spacer bars into post. Attach the back spacer bars, then the front spacer bars. This can be done with provided nails or with a brad nailer.

Note: 2 spacer bars are stacked on the bottom front.

NOTE: 1 side of front spacer bars will have exposed staples. Attach so the staples are in the least visible position.

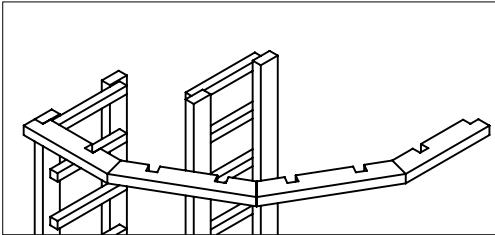

Spacer bar at top should be even with top of rack, spacer bar at bottom should be even with bottom of rack. Attach 1 rack at end of spacer bar repeat with remaining racks around to other end, make sure bottle rails on each set of racks face each other (see below).

attach in following order;

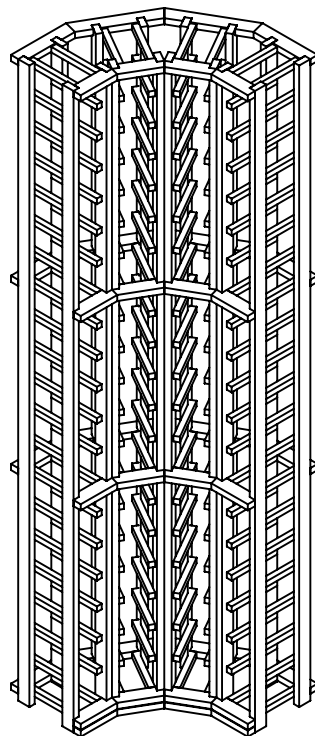
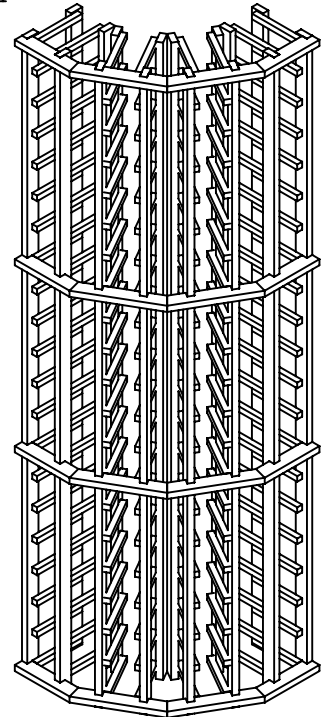
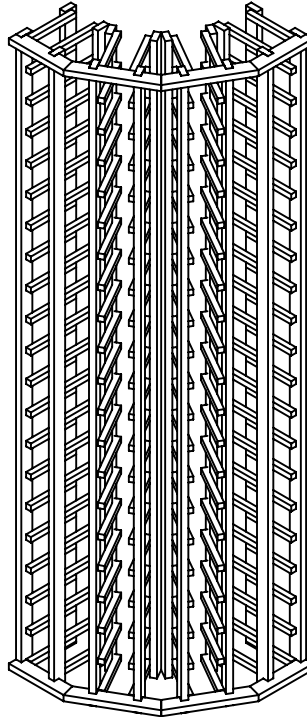
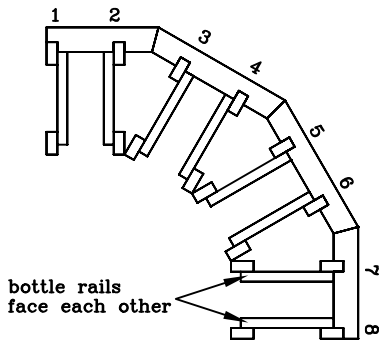

Final Step

Securing to wall

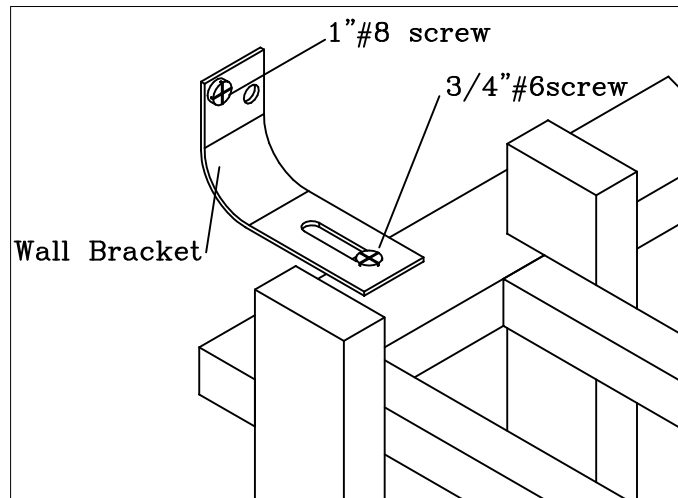

Secure rack to wall by attaching wall brackets to top back spacer bar or solid top. You will have 1 bracket on the left and 1 on the right.

Wine Rack is Complete

Note: Always remove bottles before moving rack.