

# Designer Series

Rev. 5/27/08

## Individual 2 Column Display

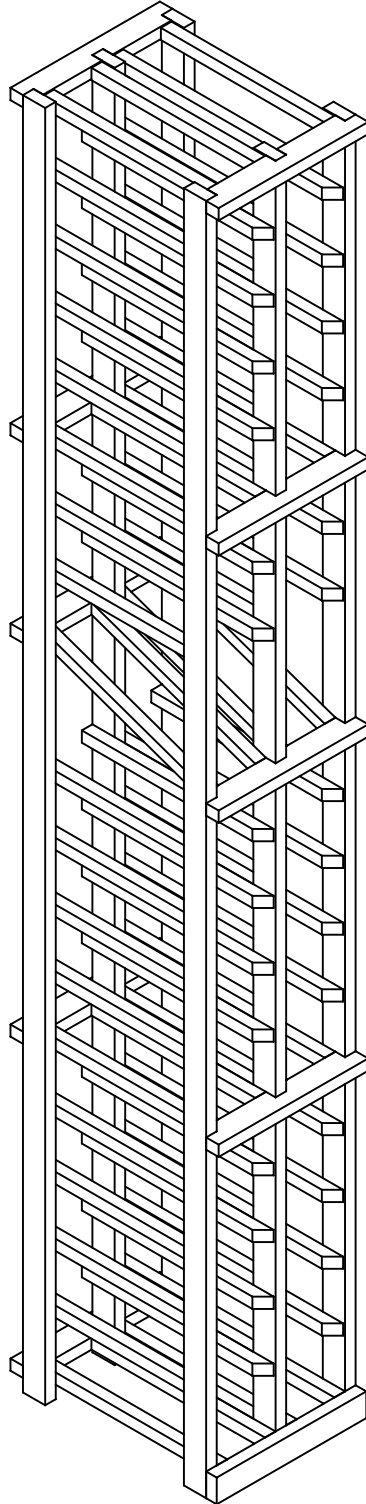

**Wine Cellar Innovations**  
4575 Eastern Avenue  
Cincinnati, Ohio 45226

Phone: (800) 229-9813  
Fax: (513) 979-5280  
[www.winecellarinnovations.com](http://www.winecellarinnovations.com)

# Individual 2 Column Display

Rev. 5/27/08

## Parts List

#	qty.	description
A	1	Left
B	1	Double
C	1	Right
D	9	Spacer bars
E	1	Sq. cut base
*	1	Bag of nails
*	1	Hardware Pack containing 2 angle brackets 2 plastic anchors 2 1" #8 screws 2 5/8" #6 screws

A

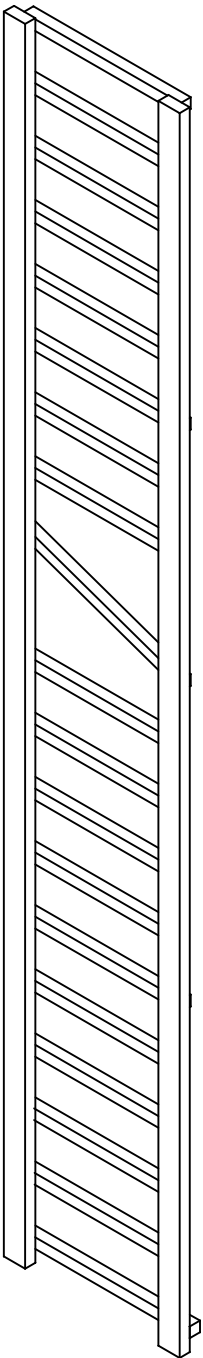

B

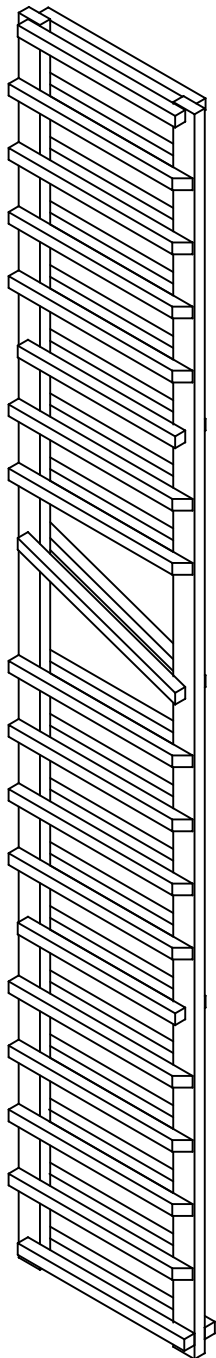

C

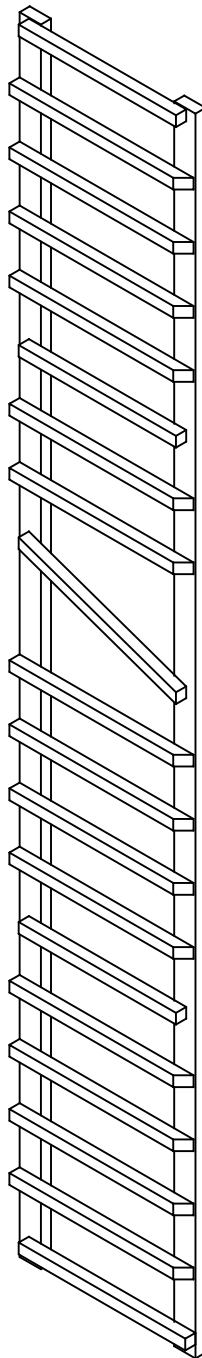

D

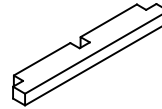

E

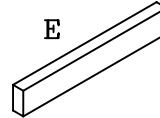

1. Attach (5) spacer bars to the back of the racks with nails.  
Top & bottom spacer bars should have a nail just on each end, the middle spacer bar should have a nail in each notch. This can be done with the provided nails or with a brad nailer.

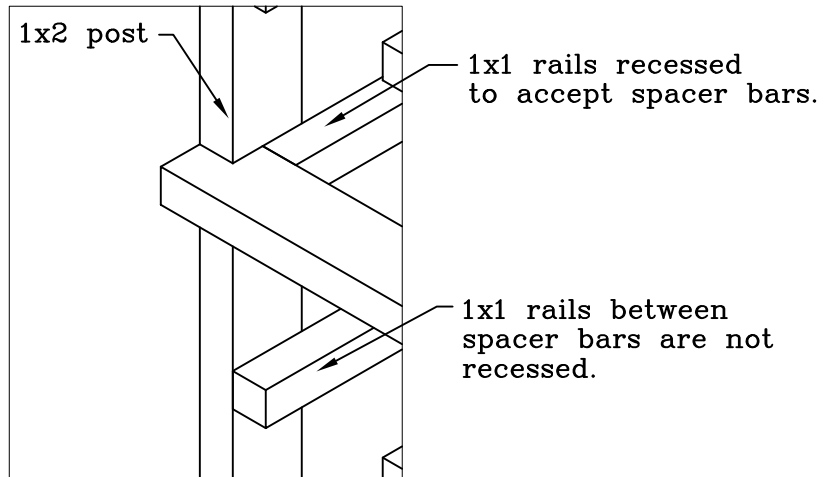
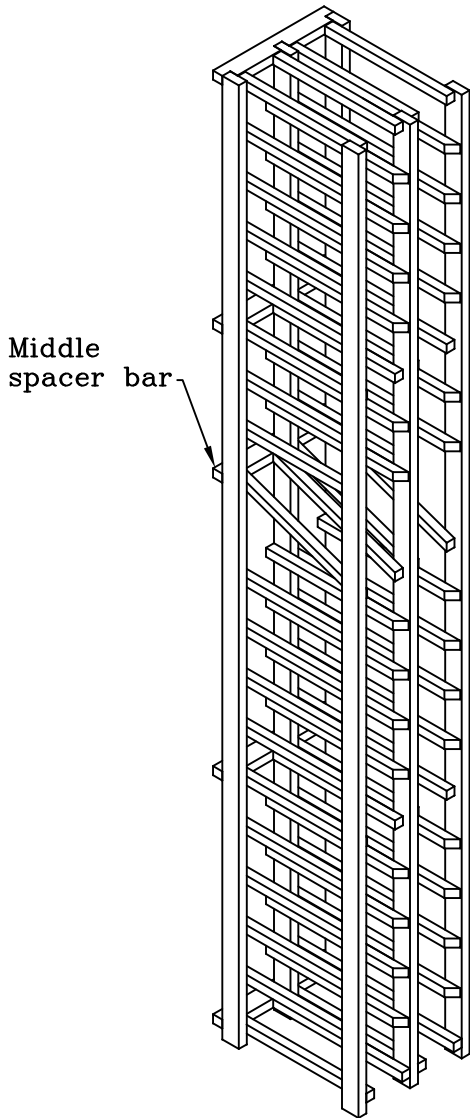

2. Attach (4) spacer bars to the front of the racks in the same manner as the back.

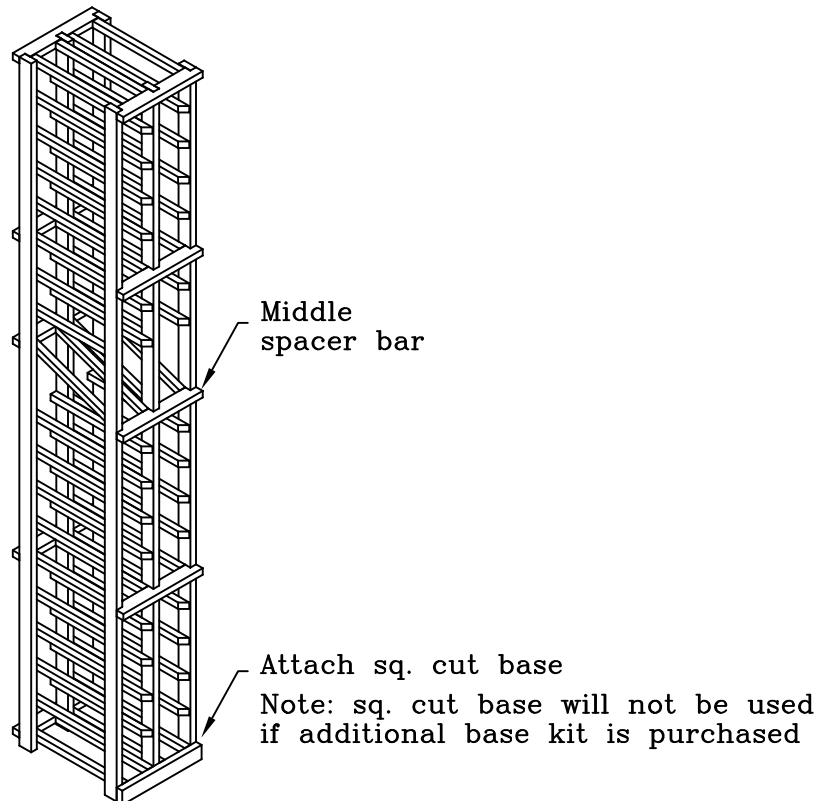

3.

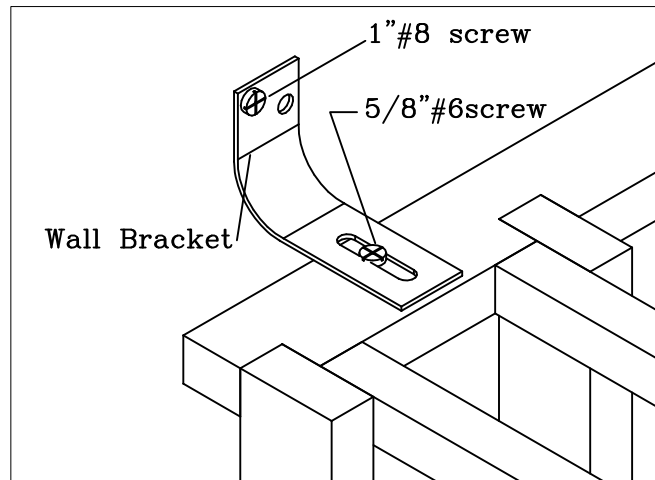

Secure rack to wall by attaching wall brackets to top back spacer bar. You will have 1 bracket on the left and 1 on the right.

Individual 2 column display assembly complete.

always remove bottles before moving racks.

**Wine Cellar Innovations**  
4575 Eastern Avenue  
Cincinnati, Ohio 45226

Phone: (800) 229-9813  
Fax: (513) 979-5280  
[www.winecellarinnovations.com](http://www.winecellarinnovations.com)