

Manual refers to
R2DS, R3DS, R4DS, R5DS
CP2DS, CP3DS, CP4DS, CP5DS

**** R3DS, CP3DS shown throughout manual ****

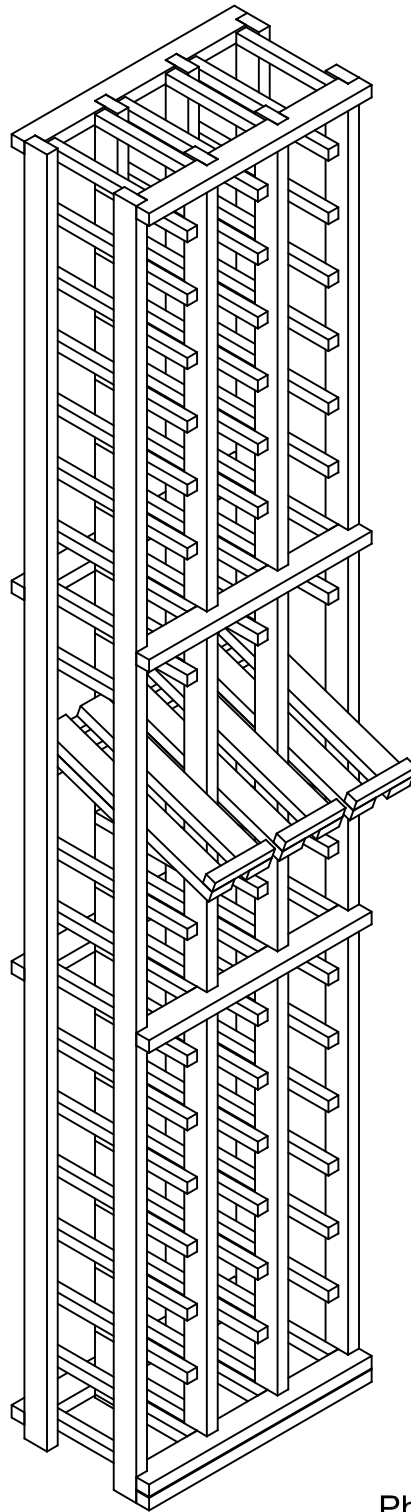

Wine Cellar Innovations
4575 Eastern Avenue
Cincinnati, Ohio 45226

Phone: (800) 229-9813
Fax: (513) 979-5280
www.winecellarinnovations.com

R2DS, CP2DS

#	Qty.	Description
A:	9	3 notch Spacer Bars
B:	1	Left Rack
C:	1	Right Rack
D:	1	Double Rack
E:	2	Display Trays
*	1	Bag of nails
*	1	Hardware Pack containing 2 angle brackets 2 plastic anchors 2 1" #8 screws 2 3/4" #6 screws

R3DS, CP3DS

#	Qty.	Description
A:	9	4 notch Spacer Bars
B:	1	Left Rack
C:	1	Right Rack
D:	2	Double Racks
E:	3	Display Trays
*	1	Bag of nails
*	1	Hardware Pack containing 2 angle brackets 2 plastic anchors 2 1" #8 screws 2 3/4" #6 screws

R4DS, CP4DS

#	Qty.	Description
A:	9	5 notch Spacer Bars
B:	1	Left Rack
C:	1	Right Rack
D:	3	Double Racks
E:	4	Display Trays
*	1	Bag of nails
*	1	Hardware Pack containing 2 angle brackets 2 plastic anchors 2 1" #8 screws 2 3/4" #6 screws

R5DS, CP5DS

#	Qty.	Description
A:	9	6 notch Spacer Bars
B:	1	Left Rack
C:	1	Right Rack
D:	4	Double Racks
E:	5	Display Trays
*	1	Bag of nails
*	1	Hardware Pack containing 2 angle brackets 2 plastic anchors 2 1" #8 screws 2 3/4" #6 screws

A for R2DS & CP2DS

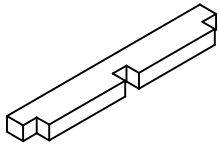

A for R3DS & CP3DS

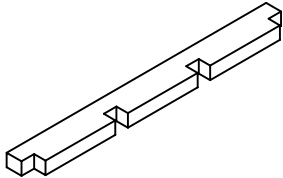

A for R4DS & CP4DS

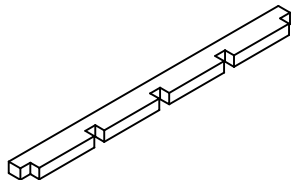

A for R5DS & CP5DS

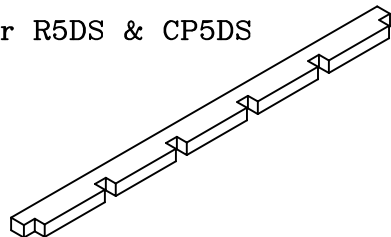

B

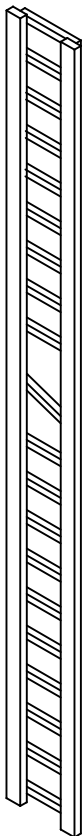

C

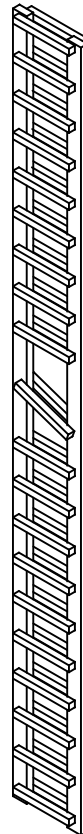

D

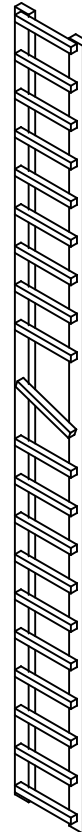

E

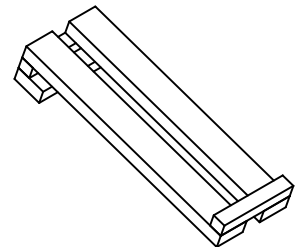

Step 1:

- a. Place 4 spacer bars on the floor staggered with notches facing up.

This position is temporary DO NOT nail staggered Spacer bars to racks.

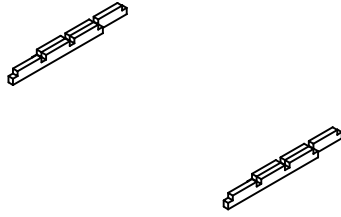

- b. Place (2) end and 1,2,3 or 4 double racks on the staggered spacer bars.

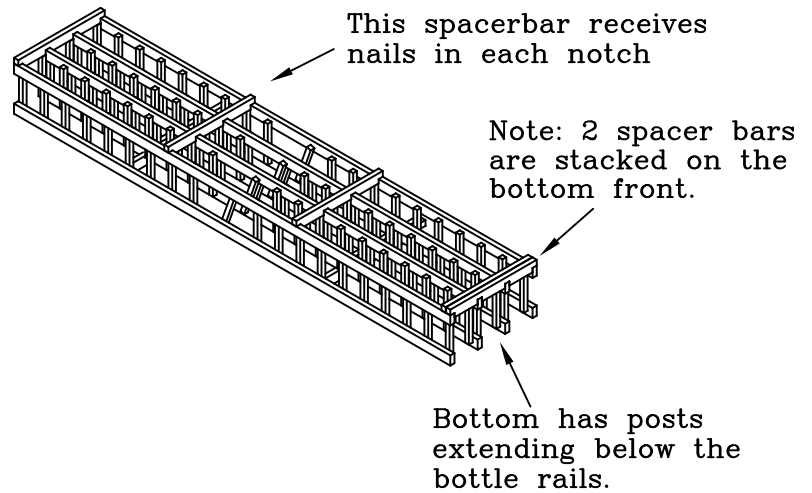

- c. Attach (5) spacer bars to racks with nails

Nail the nails into each spacer bar just on each end except the noted spacer bar above. This can be done with the provided nails or with a brad nailer.

Step 2:

Flip rack over and nail the remaining 4 spacerbars to the racks in the same manner as step 1.

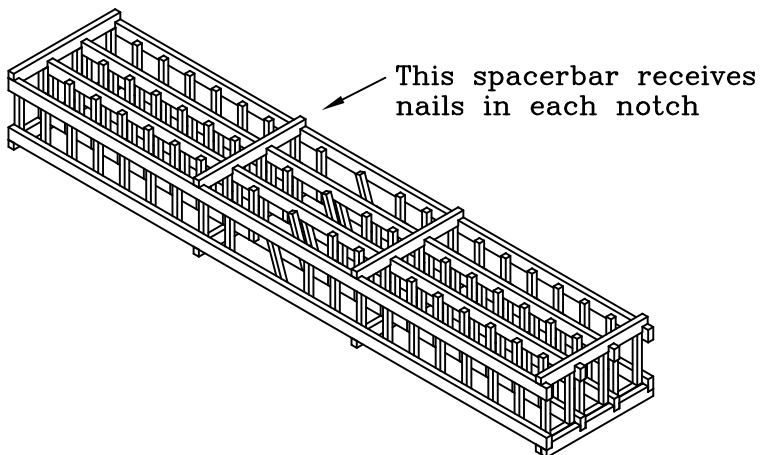

Step 3:

Insert display trays from the front of the rack. The back of the tray will slide over the back of the angled bottle rails attached to the racks.

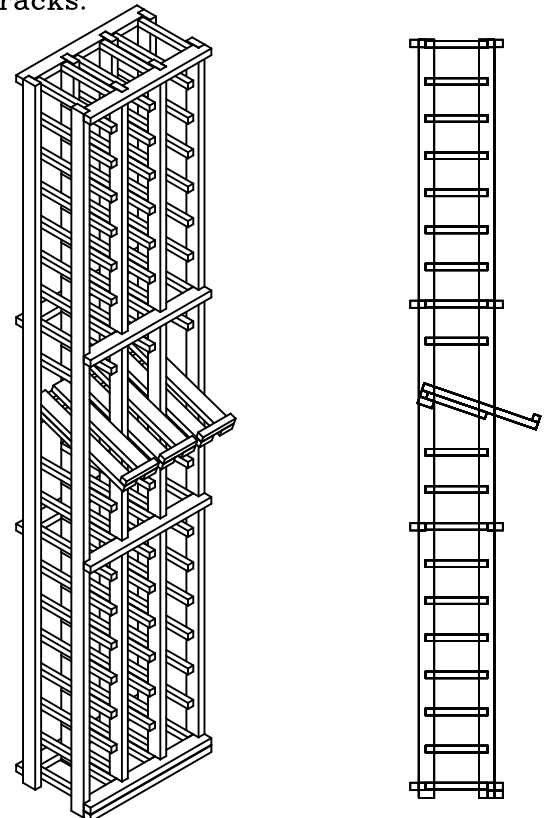

Final Step

Securing to wall

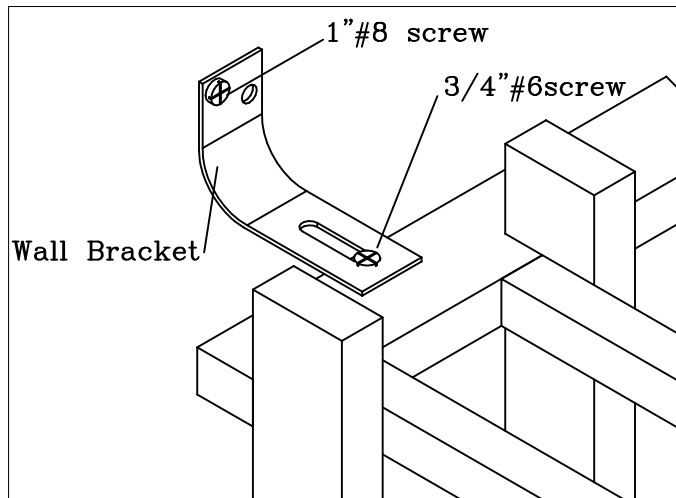

Secure rack to wall by attaching wall brackets to top back spacer bar or solid top. You will have 1 bracket on the left and 1 on the right.

Wine Rack is Complete

Note: Always remove bottles before moving rack.