

Winemaker Series

WMK3&4-IND3

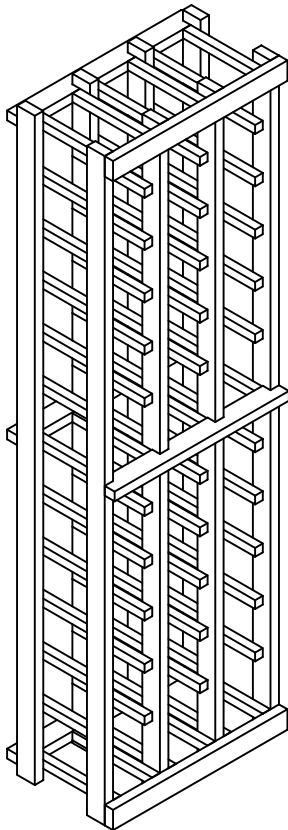

WMK3&4-IND3DS

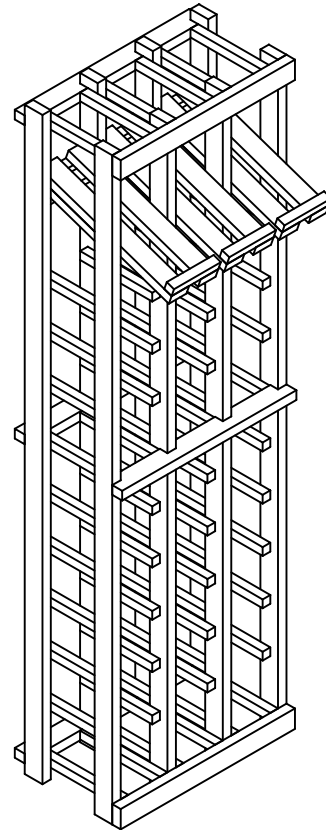

* 4ft. display version shown throughout manual.

Parts List

#	qty.	description
A	1	Right Rack
B	2	Double Rack
C	1	Left Rack
D	4	Spacer bars
E	2	Top/ Bottom Trim
F	1	Display Tray ***IND3DS only***
*	1	Bag of nails
*	1	Hardware Pack containing 2 L Brackets 2 Plastic anchors 2 1" #8 screws 2 5/8" #6 screws

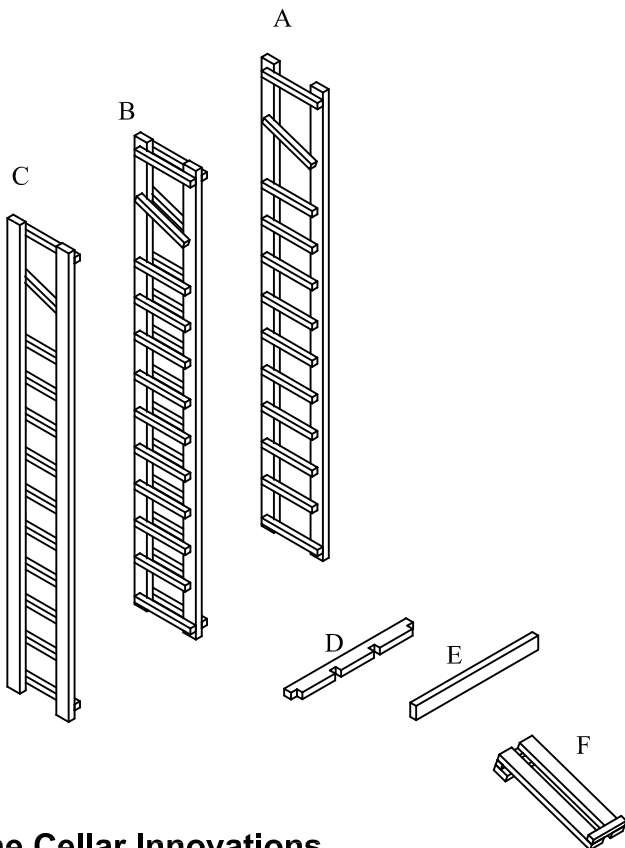

Wine Cellar Innovations
4575 Eastern Avenue
Cincinnati, Ohio 45226

Phone: (800) 229-9813
Fax: (513) 979-5280
www.winecellarinnovations.com

1. Attach (3) spacerbars to the back of the racks with nails. Note, the middle spacerbar is placed on the 7th rail from the bottom for the 4ft. version or the 6th rail from the bottom for the 3ft. version.
 Top & bottom spacer bars should only have a nail on each end, the middle spacer bar should have a nail in each notch. This can be done with the provided nails or with a brad nailer.

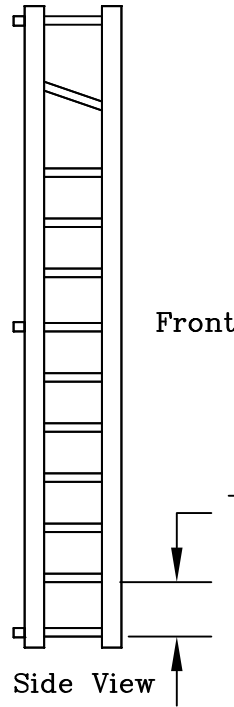
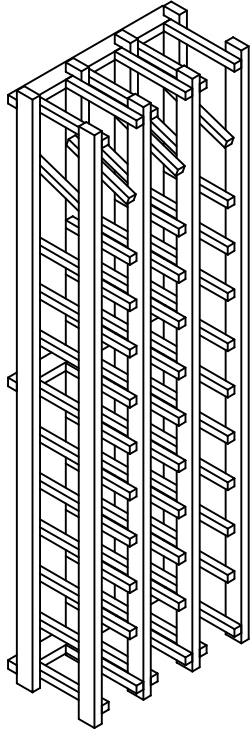

Front

Taller

NOTE: For correct orientation with non-display version, the bottom bottle space of the rack is 3/16" taller than the top bottle space.

Side View

2. Attach (1) spacer bar to the front of the racks nailing through the end notches.

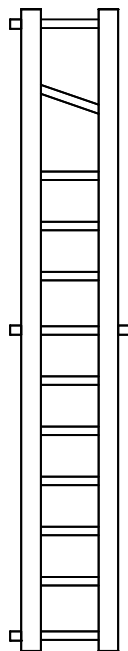
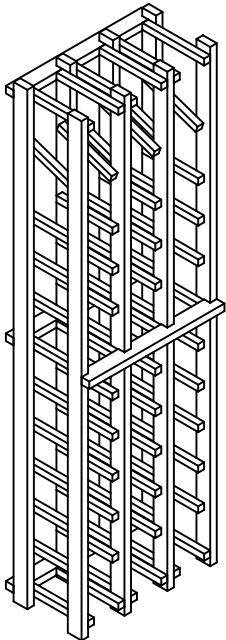

3. Attach top trim to front of racks with nails provided. If unit is not going to be stacked on top of another kit then attach bottom trim as well. If unit is going to be stacked on top of another kit then follow the trim kit instructions before attaching the bottom trim board.

DISPLAY VERSION Insert display tray from the front of the rack. The back of the tray will slide over the back of the angled bottle rails attached to the racks.

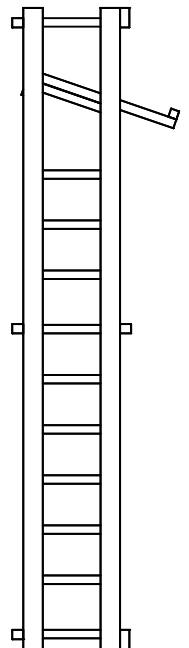
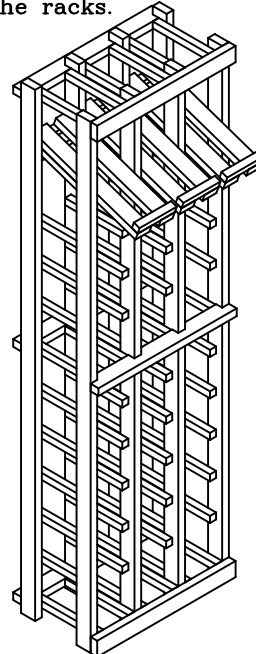

Final Step. Secure rack to wall by attaching wall brackets to top of rack. Racks should be placed 1 1/2" off of the wall.

