

# Winemaker Series

\*Lower display version and upper 4 ft. version shown throughout manual.

WMK3&4-INDGT, INDGTDS

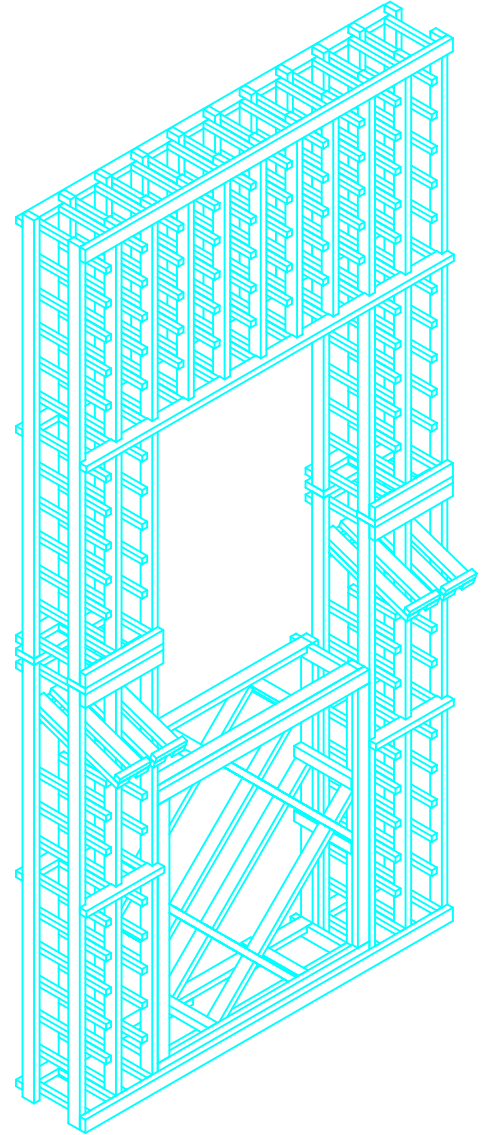
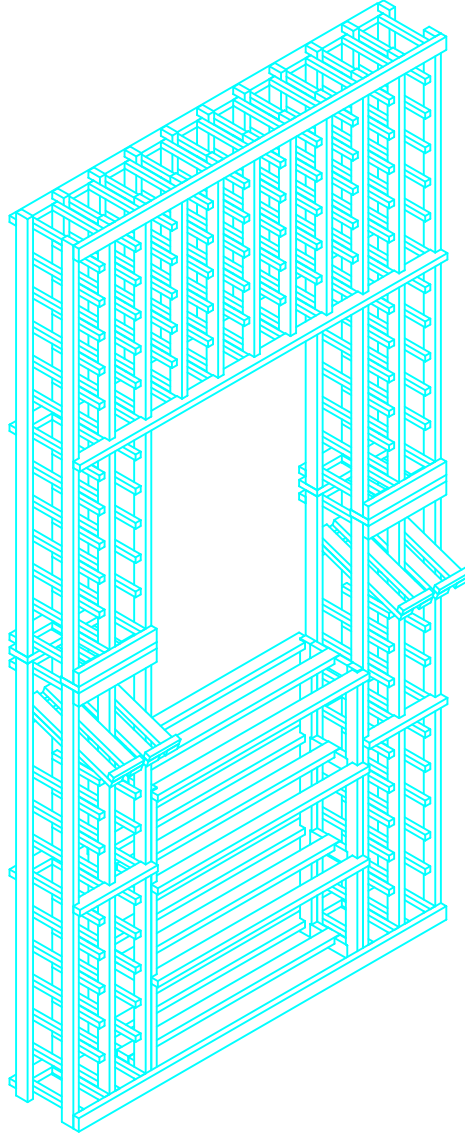
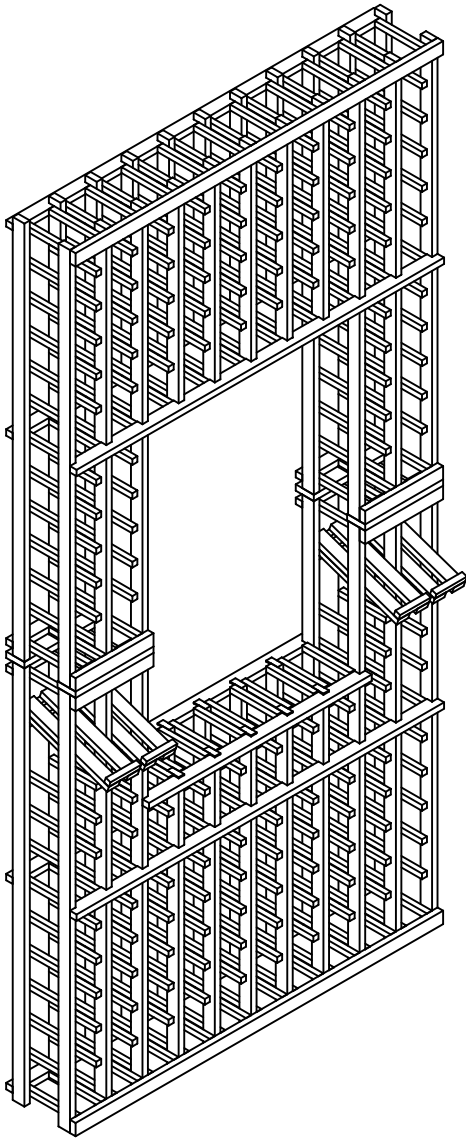

**Wine Cellar Innovations**  
4575 Eastern Avenue  
Cincinnati, Ohio 45226

Phone: (800) 229-9813  
Fax: (513) 979-5280  
[www.winecellarinnovations.com](http://www.winecellarinnovations.com)

# Winemaker Series

Individuals- upper

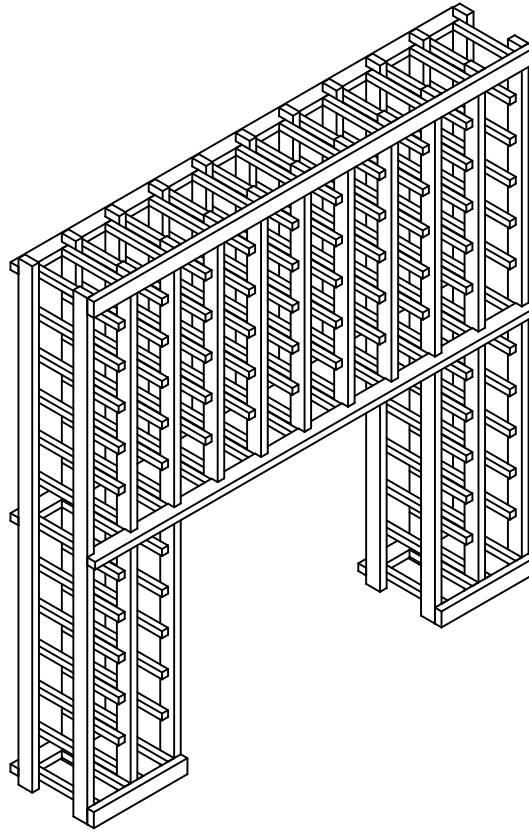

## Parts List

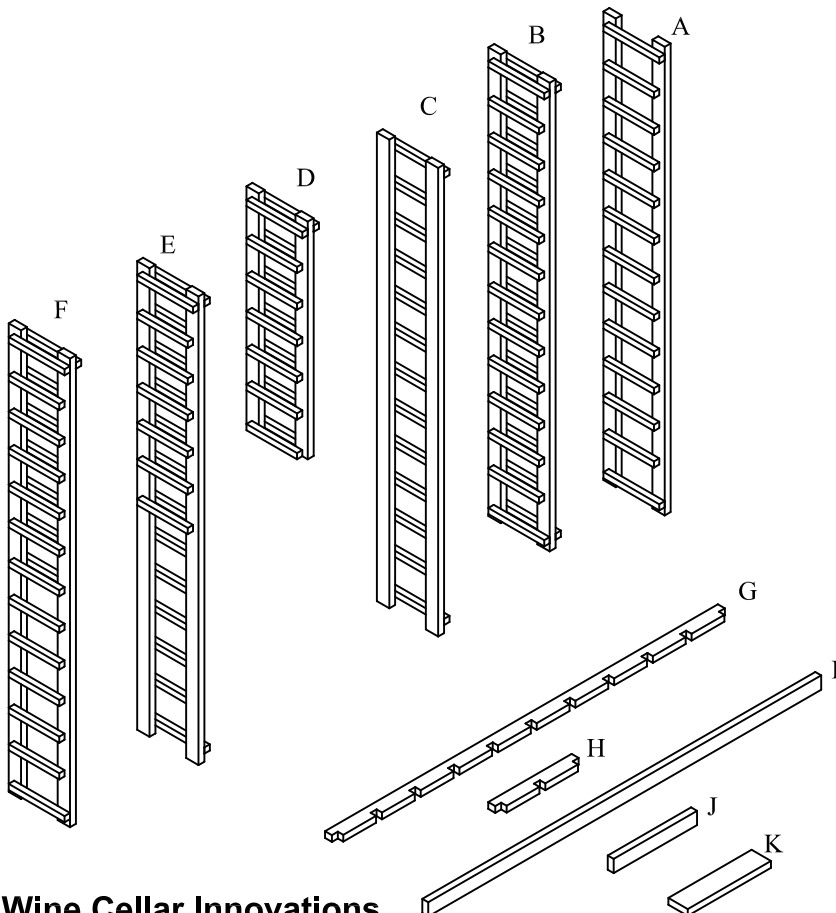

#	qty.	description
A	1	Right Rack
B	2	Double #1 Racks
C	1	Left Rack
D	5	Double #2 racks
E	1	Common#1 Rack
F	1	Common#2 Rack
G	3	11 Notch spacer bars
H	2	3 Notch spacer bars
I	1	Top Trim
J	2	Bottom Trim
K	4	Stackable Beam Supports
*	1	Bag of nails
*	1	Hardware Pack containing 2 L Brackets 2 plastic anchors 2 1" #8 screws 2 5/8" #6 screws

**Wine Cellar Innovations**  
4575 Eastern Avenue  
Cincinnati, Ohio 45226

Phone: (800) 229-9813  
Fax: (513) 979-5280  
www.winecellarinnovations.com

- Attach (4) spacer bars to the back of the racks with nails.  
 Note, the middle spacerbar is placed on the 7th rail (4 ft. version) or 6th rail (3 ft. version) from the bottom.  
 The top spacer bar should have a nail just on each end and the middle notch, the middle spacer bar gets nails in each notch, the 3 notch spacer bars should have a nail in each end notch. This can be done with the provided nails or with a brad nailer.

This spacer bar only should receive nails in every notch.

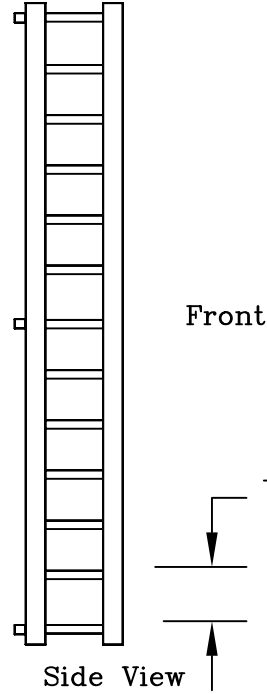
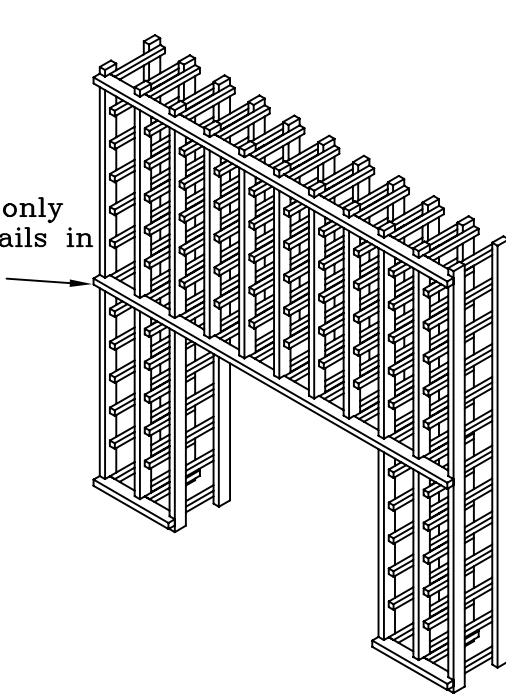

NOTE: For correct orientation the bottom bottle space of the rack is  $\frac{3}{16}$ " (4 ft version) or  $\frac{7}{16}$ " (3 ft version) taller than the top bottle space.

- Attach a spacer bar to the front of the racks by nailing on each end and the middle notches.

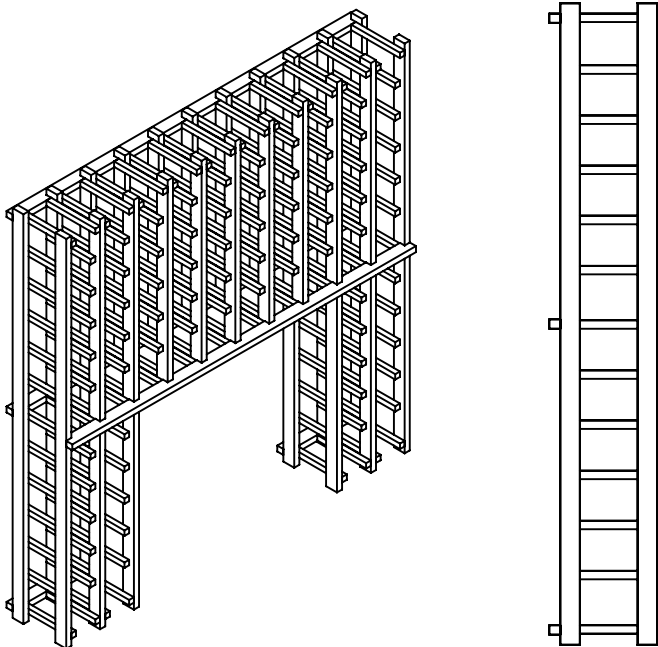

- Attach top trim to front of racks with nails provided.

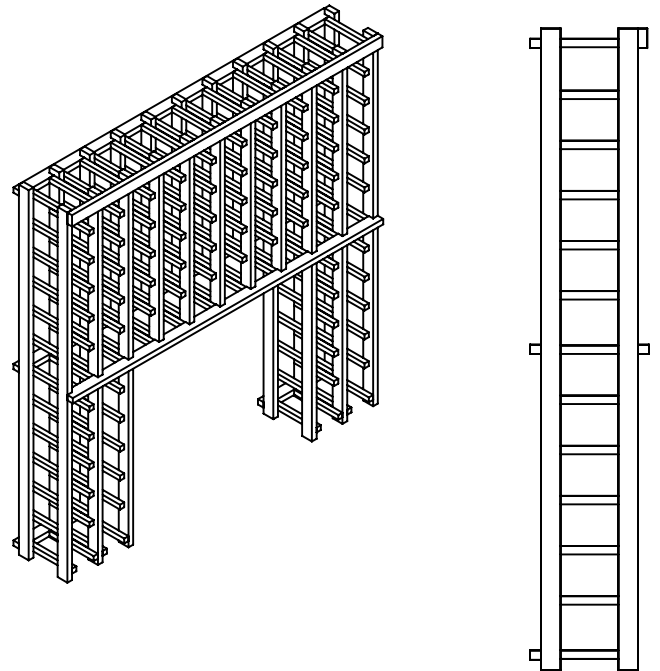

# Winemaker Series

Individuals- lower

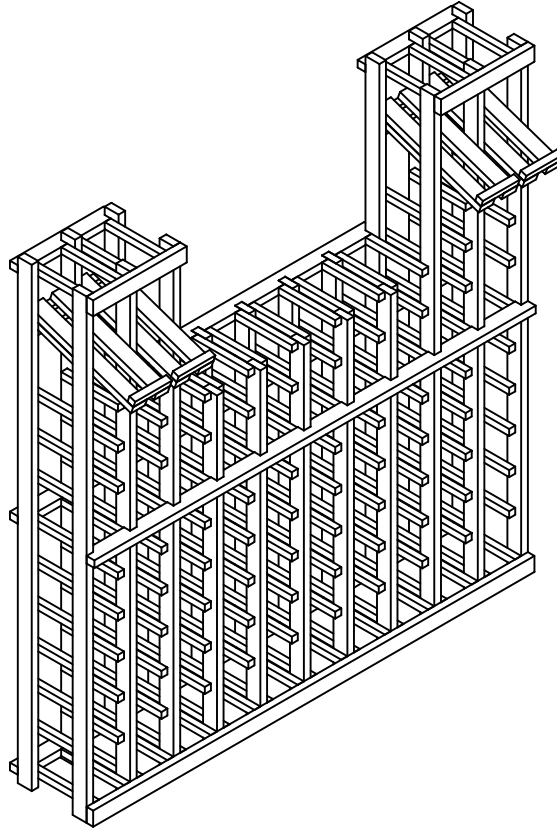

## Parts List

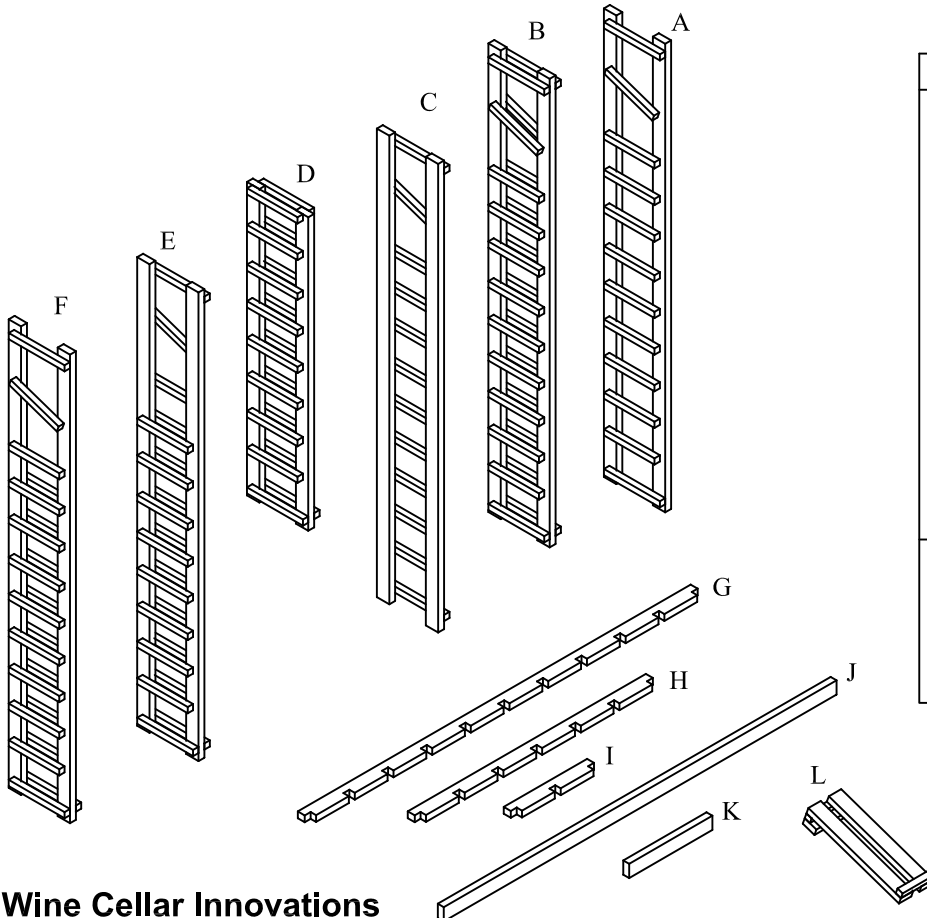

#	qty.	description
A	1	Right Rack
B	2	Double #1 Racks
C	1	Left Rack
D	5	Double #2 racks
E	1	Common#1 Rack
F	1	Common#2 Rack
G	3	11 Notch spacer bars
H	2	7 Notch spacer bars
I	2	3 Notch spacer bars
J	1	Bottom Trim
K	2	Top Trim
L	4	Display Tray ** INDGTDS Only **
*	1	Bag of nails
*	1	Hardware Pack containing 2 L Bracket 2 plastic anchors 2 1" #8 screws 2 5/8" #6 screws

**Wine Cellar Innovations**  
4575 Eastern Avenue  
Cincinnati, Ohio 45226

Phone: (800) 229-9813  
Fax: (513) 979-5280  
www.winecellarinnovations.com

1. Attach (5) spacer bars to the back of the racks with nails.

Note, the middle spacerbar is placed on the 7th rail from the bottom. The bottom spacer bar should have a nail just on each end and the middle notch, the middle 11 notch spacer bar gets a nail in each notch, the 3 and 7 notch spacer bars should have a nail in each end notch. This can be done with the provided nails or with a brad nailer.

This spacer bar only should receive nails in every notch.

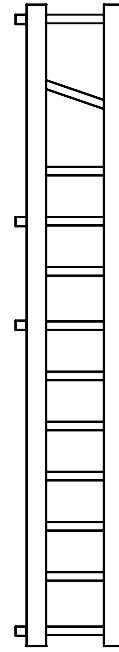
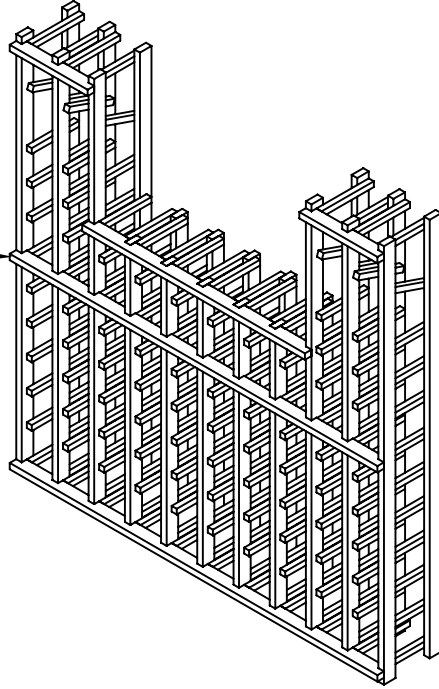

Front

Taller

NOTE: For correct orrrientation with non-display version, the bottom bottle space of the rack is 3/16" taller than the top bottle space.

Side View

2. Attach 2 spacer bars to the front of the racks by nailing on the ends as well as the middle notch for the 11 notch spacer bar.

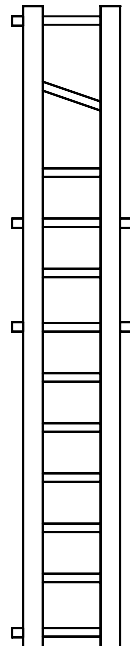
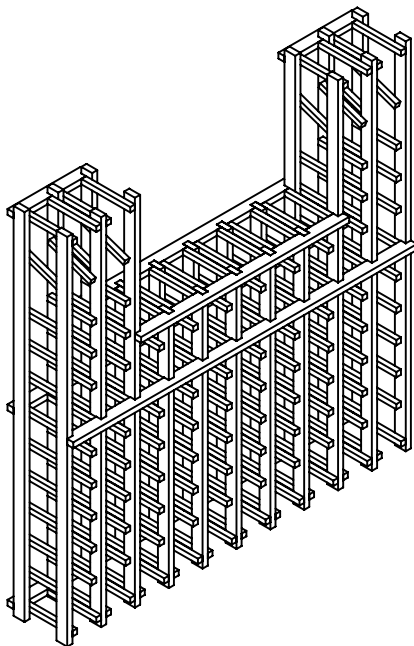

3. Attach bottom trim to front of racks with nails provided.

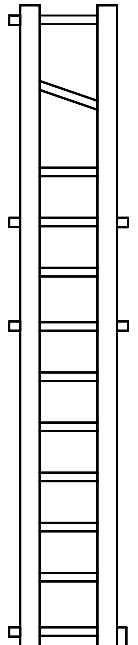
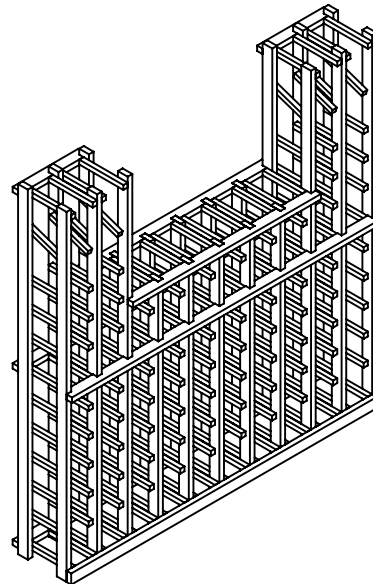

4.

Attach stackable beam supports to bottom of upper kit.

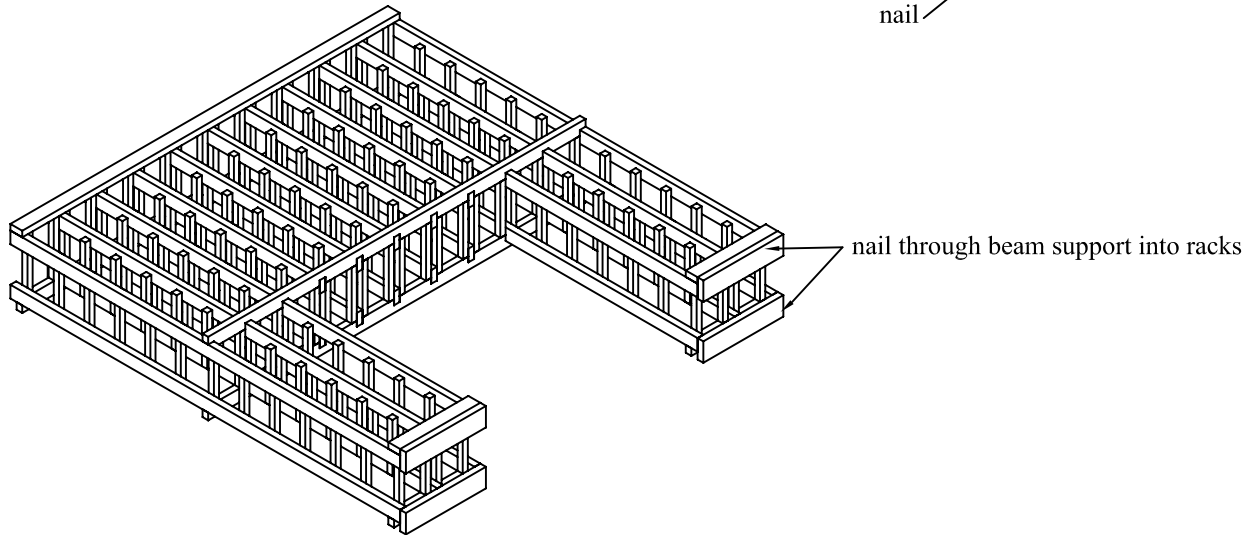
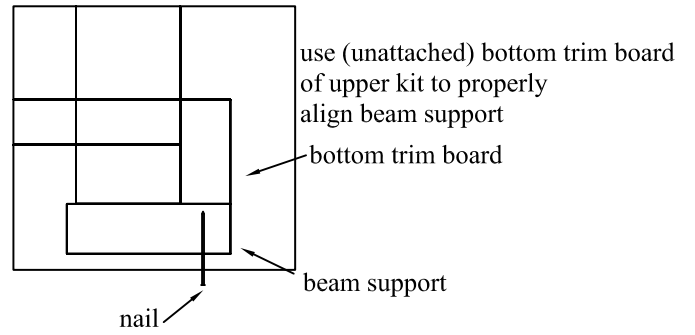

5. Place upper kit on top of lower kit.

Nail through front beam support into top trim of lower kit. Note: you do not need to nail through back beam support.

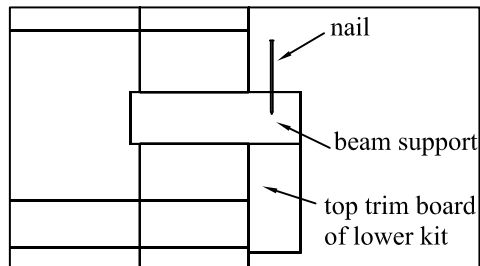
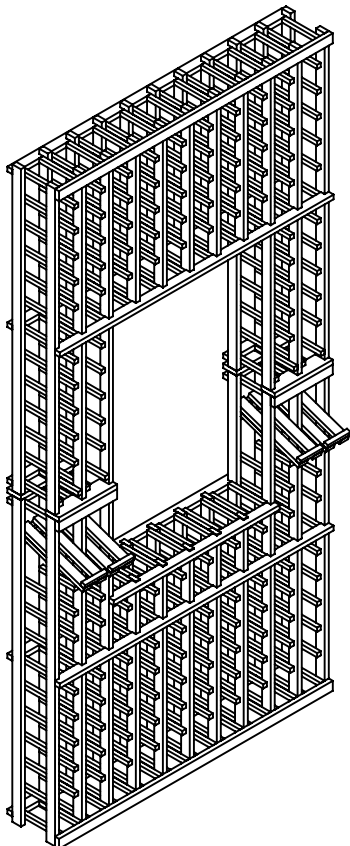

6. Attach bottom trim of upper kit to racks with nails provided.

**\*DISPLAY VERSION\*** Insert display tray from the front of the rack. The back of the tray will slide over the back of the angled bottle rails attached to the racks.

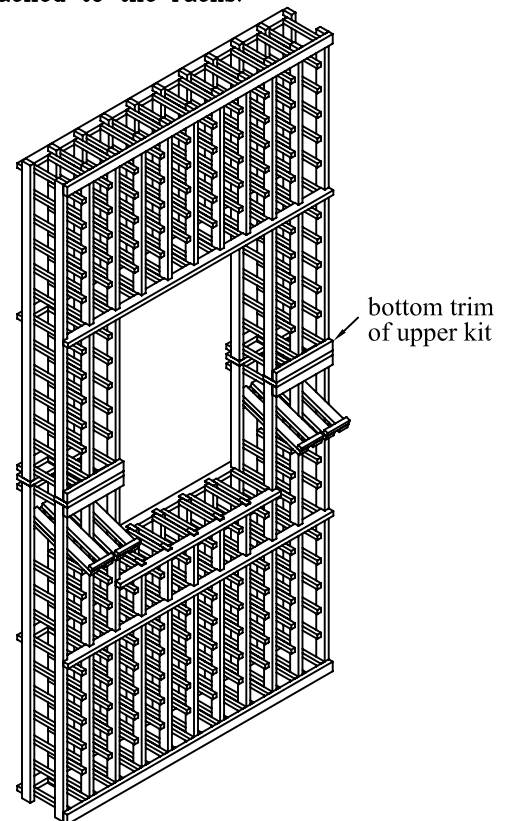

Final Step. Secure rack to wall by attaching wall brackets to top of rack. Racks should be placed 1 1/2" off of the wall.

