

Winemaker Series

WMK3&4-RECT1

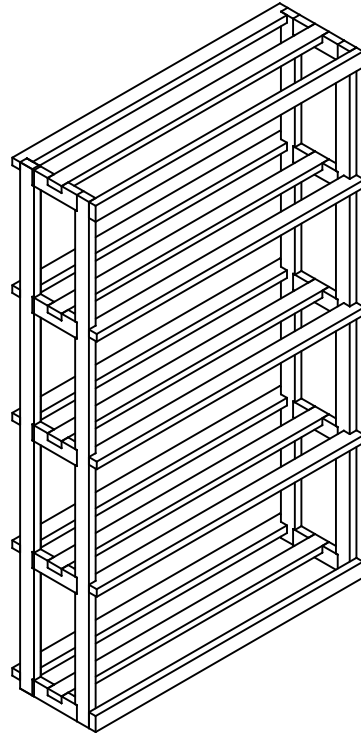

* 4ft. version shown throughout manual.

Parts List

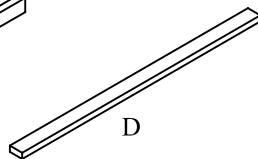
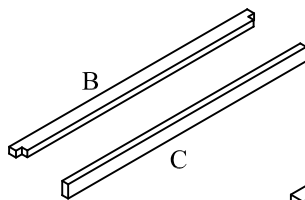
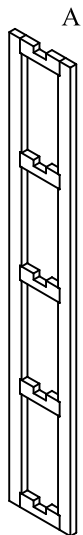

#	qty.	description
A	2	Racks
B	6 or 8	Spacer bars (6-3ft., 8-4ft.)
C	2	Top/ Bottom Trim
D	4 or 5	Slats (4-3ft., 5-4ft.)
*	1	Bag of nails
*	1	Hardware Pack containing 2 L Brackets 2 plastic anchors 2 1" #8 screws 2 5/8" #6 screws

1. Attach (8) spacer bars to the racks with nails.
This can be done with the provided nails or with a brad nailer.

Spacer Bars should be attached flush to top of rails.

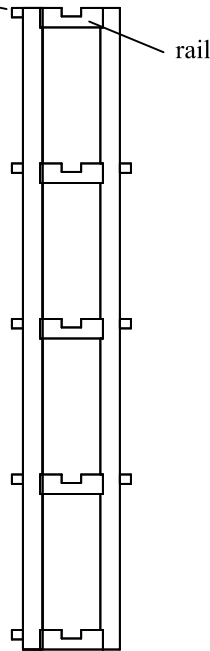
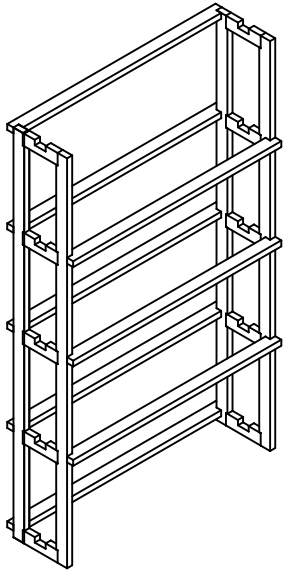

2. Attach top trim to front of racks with nails provided. If unit is not going to be stacked on top of another kit then attach bottom trim as well. If unit is going to be stacked on top of another kit then follow the trim kit instructions before attaching the bottom trim board.

3. Insert slats into notched rails on racks. If you are stacking this kit on top of another kit then wait until the kits have been attached to insert slats.

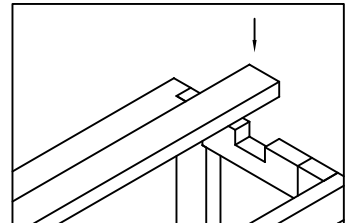
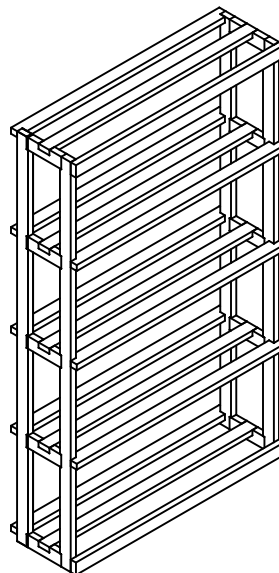
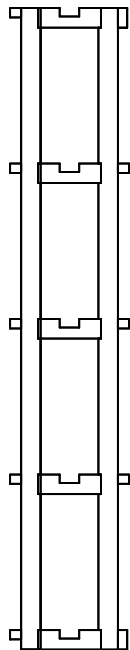
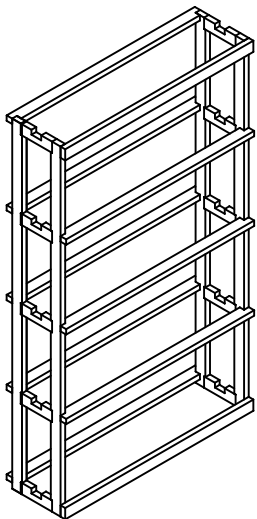

Final Step. Secure rack to wall by attaching wall brackets to top of rack. Racks should be placed 1 1/2" off of the wall.

