



VOX

**SOFORM
UPHOLSTERED PANELS**

INTRODUCTION

DESIGNERS 07

SOFORM PANELS 08

FABRICS 13

SOFORM PANELS

PERFECT RECTANGULAR 14

COSY ELEGANCE 20

GAME OF SQUARES 32

GEOMETRIC PLAY 38

IN CIRCLES 44

SETS

GREY AND PINK 54

GREY AND MUSTARD 66

GREEN AND GREY 80

NAVY BLUE AND GREY 94

SET IDEAS 108

SELF-ASSEMBLY 110





FREEDOM BEGINS
at home

At VOX, we believe that true freedom begins at home and rather than a defined interior style, what really matters are the needs and lifestyles of your family members. That's why it is our goal to inspire, advise and deliver complex interior solutions - matching collections of furniture, doors, floors and decorative walls.





DESIGNERS



DOROTA BALEWICZ



NATALIA POLAKOWSKA

Every day we join forces with talented creators. Thanks to their passion, upholstered decorations not only please the eyes, but fulfil their practical role.

The panel collection includes several geometric forms. They have been made with carefully selected fabrics to diversify interiors and offer great freedom of arrangement. Upholstered headrests and recesses help to create a friendly atmosphere, and ready-made sets invite you to play with wall decorations.

SOFORM PANELS. COMFY WALL

As soft as a cushion, soft to touch just like your favourite armchair and compellingly beautiful. This description fits every wall decorated with Soform panels. Dozens of variants and only one goal - to make you feel really comfortable in your home. Dedicated accessories will help to change the decoration into an original hanger or an inspiration board. A subtle accent or maybe the main part of a cosy arrangement? Choose your favourite shape and give your wall more meaning.

ONE PRODUCT, MANY WORLDS



Soform upholstered panels delight with their multiple applications. They are great as the decoration of the entire wall or when used to cover part of the wall only. They work well as a headboard or in a recessed area. Our soft to touch panels can be used anywhere you want, in the living room, in the bedroom, child's room or the hall. The wide range of shapes and sizes makes it possible to create any configuration. Play with your arrangements, combine the square with a rectangular or geometrical shape with circles. Enjoy the makeover of your favourite space.



FABRICS

TON FABRIC
NAVY BLUE VELVET SHINY



TON FABRIC
BLACK VELVET MATT

TON FABRIC
MUSTARD VELVET SHINY



BURANO FABRIC
LIGHT PINK VELVET MATT

CHOPPER FABRIC
PINK MELANGE

SCOT FABRIC
GREY VELVET MATT



ANGUS FABRIC
BEIGE TWEED

CLARK FABRIC
GREY WOOL

PETRUS FABRIC
GRAPHITE TWEED



MANGO FABRIC
GREY MELANGE

GEORGE FABRIC
BOTTLE GREEN
VELVET SHINY



MANGO FABRIC
GREEN MELANGE



A diagonal weave, stain-resistant knitted fabric with a fine structure, smooth velour with a velvet sheen or robust fabric with natural wool - there is no coincidence in the selection of fabrics. Soform upholstered panels captivate with their interesting looks and are comfortable to use. You can choose from 9 different fabrics in 12 colours. The upholstery may be hydrophobic, fire or abrasion resistant. Choose a solution that will fulfil your design fantasies.



PANEL REGULAR 1, GREY WOOL

PERFECT RECTANGLE



The panels have universal shapes and colours so they can easily be used to cover large wall areas, for instance in the hall. A grey composition made with grey rectangles creates a soft to touch backrest and ensures everyday comfort. Add some hooks to organise the space for coats and jackets of your nearest and dearest. Feel more comfortable and impress your guests at the very entrance.

REGULAR 1

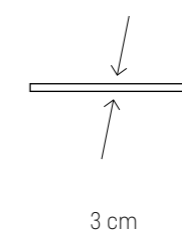
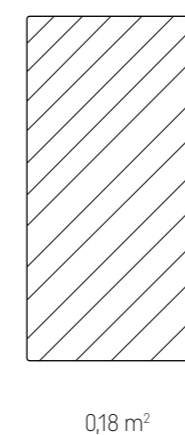
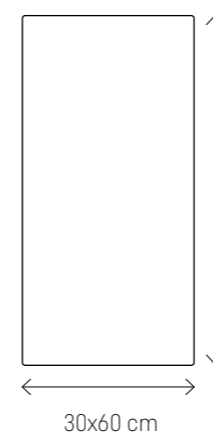

WIDE RANGE OF COLOURS



LIGHTNESS



EASY INSTALLATION



MADE IN POLAND

COLOURS



Beige Tweed



Graphite Tweed



Grey Wool



Pink Melange



Green Melange



Grey Melange



Light Pink
Velvet Matt



Grey Velvet
Matt



Black Velvet
Matt



Mustard Velvet
Shiny



Bottle Green
Velvet Shiny



Navy Blue
Velvet Shiny

Grey Wool fits nicely in halls, and Navy Blue Velvet Shiny – in your study. There is a choice from among 12 different colours.

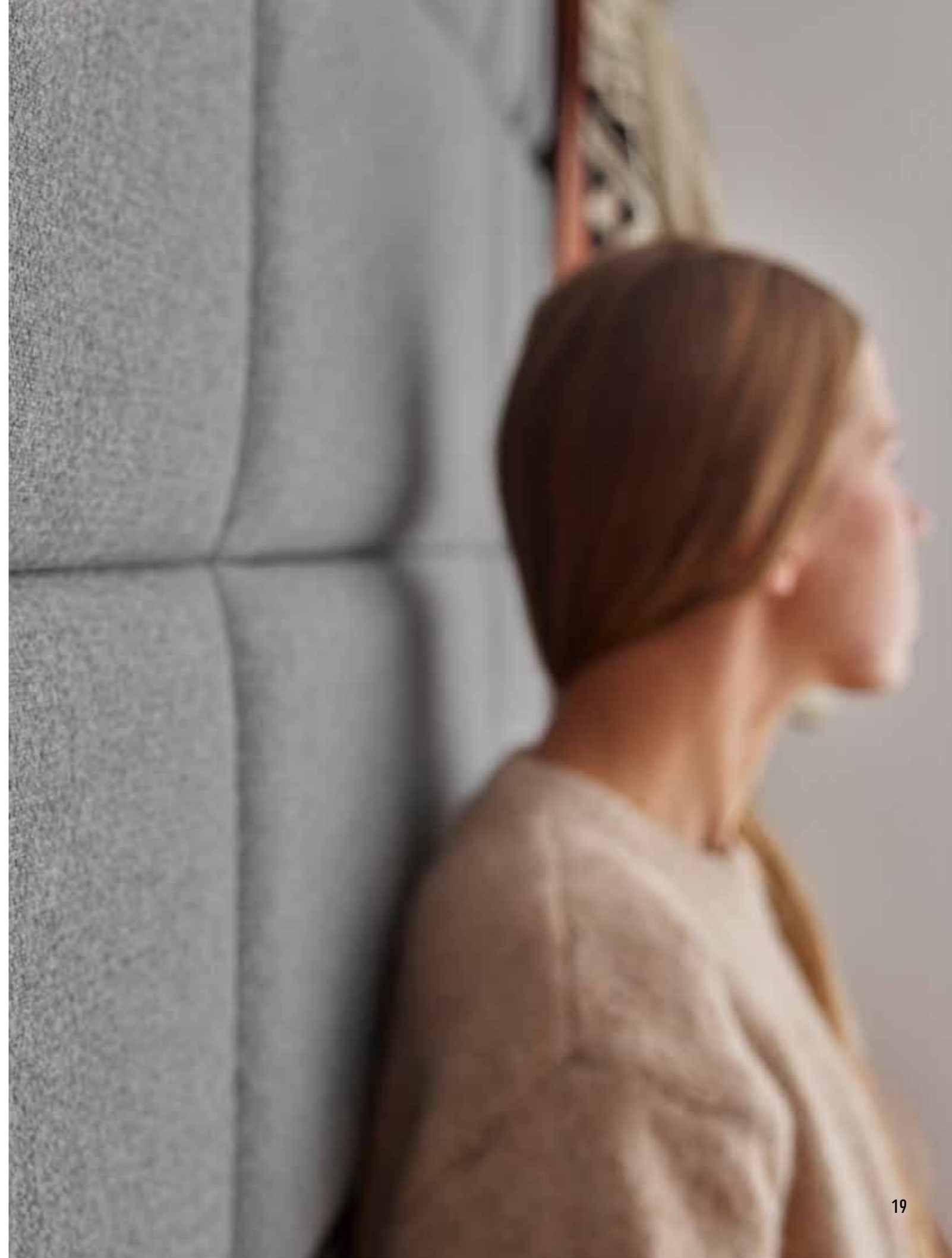







PANEL REGULAR 2, BLACK VELVET MATT

COSY ELEGANCE

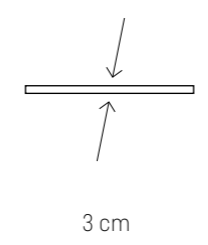
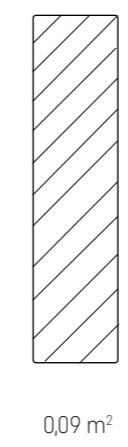
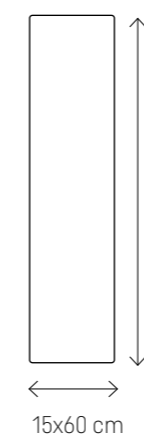
Elegance can take on many different faces and feels great in the company of cosiness. The slightly elongated shape of the panels offers great freedom of arrangement. You can create a unique headrest for your bed to feel comfortable during your evening reading session, while giving the impression of unusual warmth. You can easily choose the right colour to create a harmonious duet with your furniture. Here every arrangement is always a success.

REGULAR 2



-  WIDE RANGE OF COLOURS
-  LIGHTNESS
-  EASY INSTALLATION
-  MADE IN POLAND

COLOURS



Beige Tweed



Graphite Tweed



Grey Wool



Pink Melange



Green Melange



Grey Melange



Light Pink
Velvet Matt



Grey Velvet
Matt



Black Velvet
Matt



Mustard Velvet
Shiny



Bottle Green
Velvet Shiny



Navy Blue
Velvet Shiny

Green Melange works well in a boy's room, and Grey Velvet Matt will perfectly furnish the living room. There are many options available with which you can distinguish any space in your home.





EXAMPLE SETS

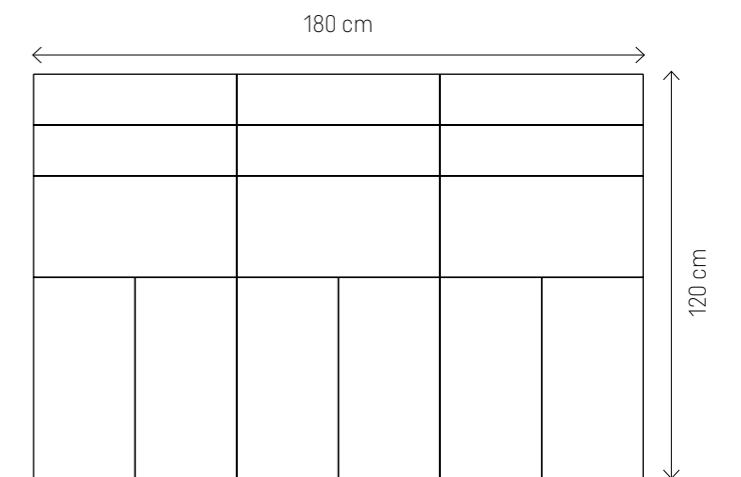
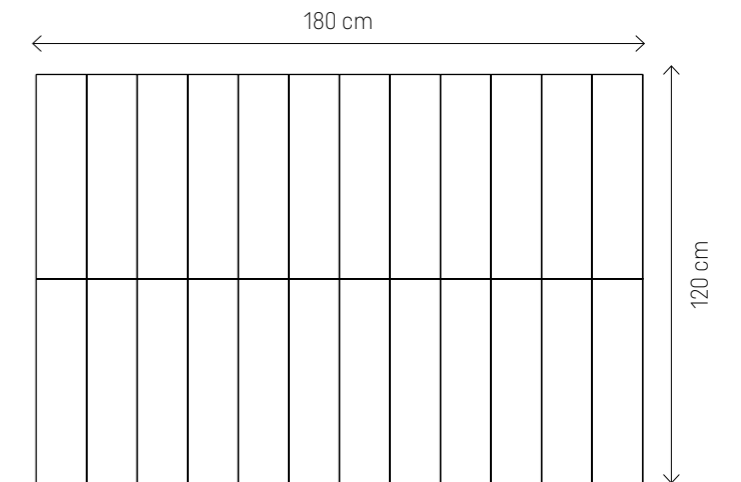

The panels can be combined in many ways. Rectangles offer the most flexibility and work well together both vertically and horizontally. Arrange them in a parallel or perpendicular manner and combine shades and fabrics. Discover the endless possibilities offered by Soform panels.

ATTENTION!

Upholstered panels are a solution that offer both decorative and practical value. Aesthetically finished, they provide additional acoustic insulation, insulate the wall and cover small irregularities on its surface.





PANEL REGULAR 2, GREEN MELANGE
 PANEL REGULAR 2, BOTTLE GREEN VELVET SHINY

EXAMPLE SETS

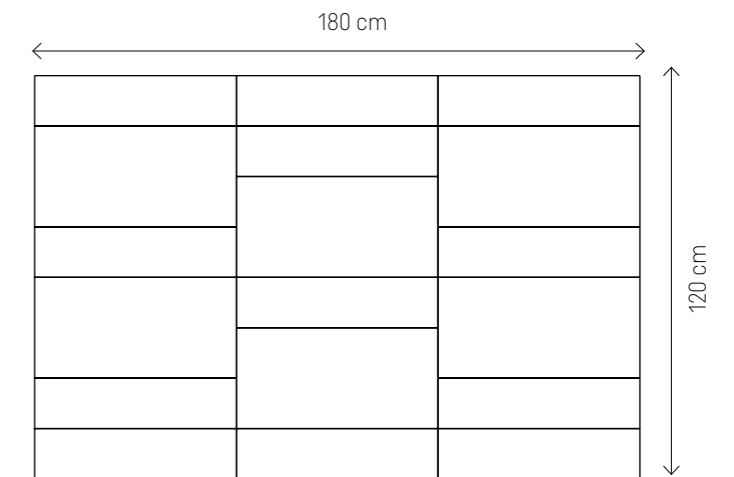
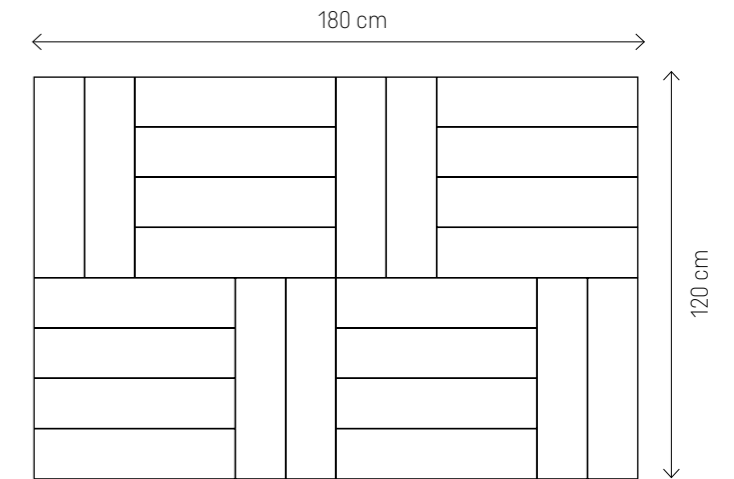

By combining Soform upholstered panels you can create functional compositions. The available shapes, fabrics and shades were selected by VOX designers to create a perfect harmony.



PANEL REGULAR 3, GREY WOOL
PANEL REGULAR 3, BEIGE TWEED
REGULAR 2, GREY WOOL

GAME OF SQUARES

When you recall your childhood playground games and being inspired by this memory, assemble a new composition. Large square panels are a great addition to your study or study corner. Mounted above the desk they will serve as a pin board for important notes and inspirations, yet making your interior feel a bit more cosy. It is extremely easy to combine them with other panels, for example Regular 1 and Regular 2, creating a composition perfectly suited to your specific needs.

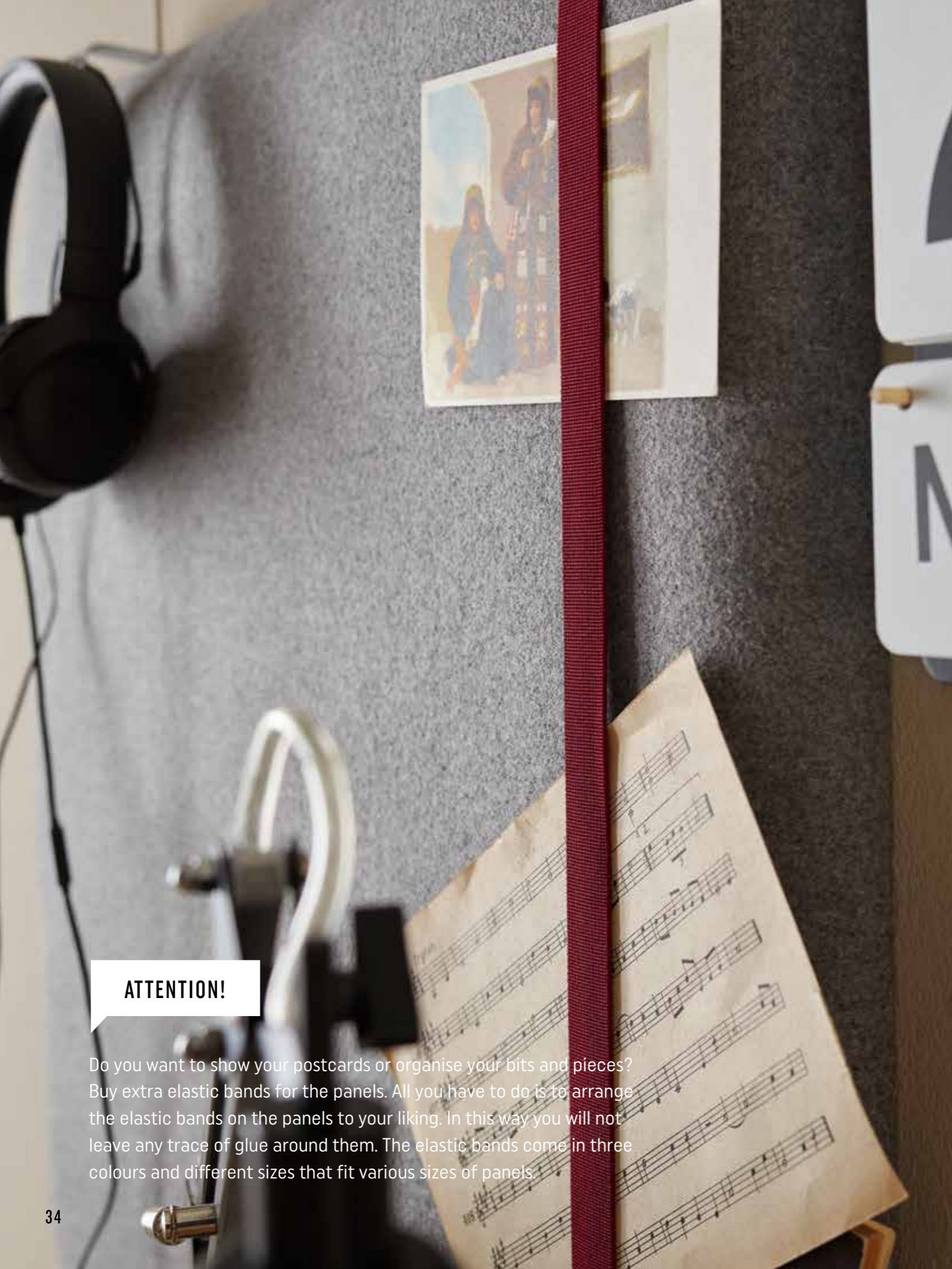

ATTENTION!

Do you want to show your postcards or organise your bits and pieces? Buy extra elastic bands for the panels. All you have to do is to arrange the elastic bands on the panels to your liking. In this way you will not leave any trace of glue around them. The elastic bands come in three colours and different sizes that fit various sizes of panels.

REGULAR 3

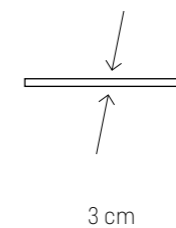
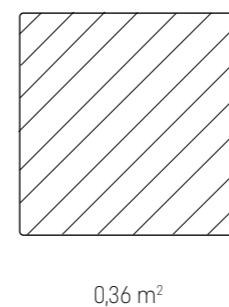
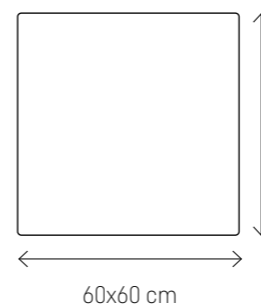
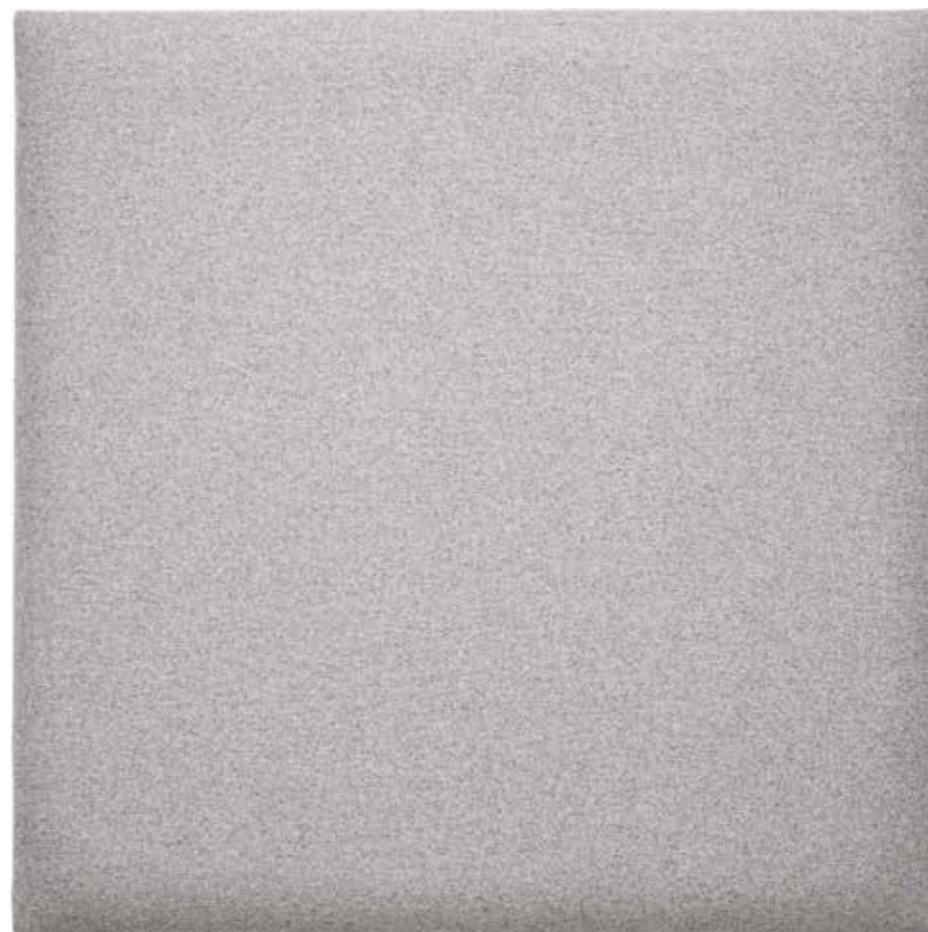

COLOURS



Beige Tweed



Graphite Tweed



Grey Wool



Pink Melange



Green Melange



Grey Melange



Light Pink
Velvet Matt



Grey Velvet
Matt



Black Velvet
Matt



Mustard Velvet
Shiny



Bottle Green
Velvet Shiny



Navy Blue
Velvet Shiny

Graphite Tweed in the dining room, or maybe Mustard Velvet Shiny in the living room? Choose the best colour for your home.





PANEL GEO, PINK MELANGE

GEOMETRIC PLAY

Enrich your interior with a soft backrest and a unique wall decoration in one. Slanted panels will appeal to all fans of unusual solutions. They can be used to arrange a headboard in your bedroom - such irregular composition will distinguish this personal space among others.

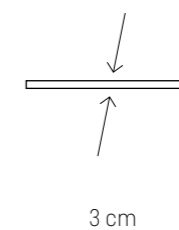
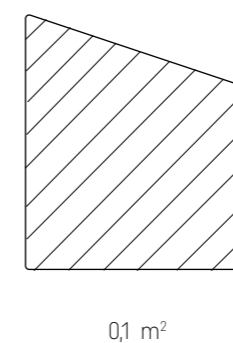
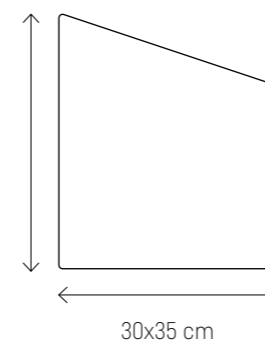

COLOURS



Beige Tweed



Graphite Tweed



Grey Wool



Pink Melange



Green Melange



Grey Melange



Light Pink
Velvet Matt



Grey Velvet
Matt



Black Velvet
Matt



Mustard Velvet
Shiny



Bottle Green
Velvet Shiny



Navy Blue
Velvet Shiny

Beige Tweed in a subdued hallway or Velvet Shiny Bottle Green in a tasteful guest bedroom? Choose a colour that will give the right character to your space.





PANEL OVAL 1, LIGHT PINK VELVET MATT

IN CIRCLES

Do round shapes appeal more to you than edgy geometry? You can opt for panels with rounded edges, available in three variants. They will be great as decorative wall protection in your child's room, a little fence in the drawing corner or quilted panels to which your little one will be able to attach their favourite pictures. You can create your own cosy composition.



OVAL 1

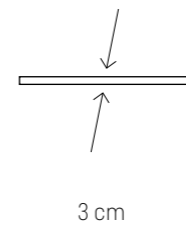
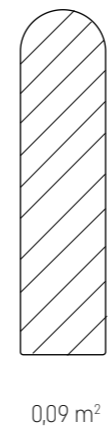
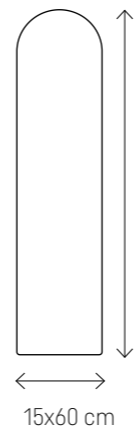

WIDE RANGE OF COLOURS



LIGHTNESS



EASY INSTALLATION



MADE IN POLAND

COLOURS



Beige Tweed



Graphite Tweed



Grey Wool



Pink Melange



Green Melange



Grey Melange



Light Pink Velvet Matt



Grey Velvet Matt



Black Velvet Matt



Mustard Velvet Shiny



Bottle Green Velvet Shiny



Navy Blue Velvet Shiny

Pink Melange works well in a feminine space, and Black Velvet Matt might complete an elegant bedroom.



OVAL 2



Beige Tweed

Graphite Tweed

Grey Wool

Pink Melange



Green Melange

Grey Melange

Light Pink
Velvet Matt

Grey Velvet
Matt



Black Velvet
Matt

Mustard Velvet
Shiny

Bottle Green
Velvet Shiny

Navy Blue
Velvet Shiny

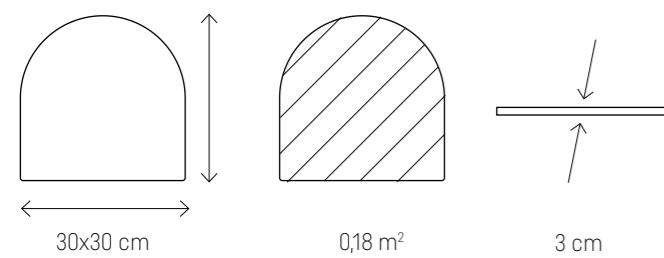

OVAL 3



Beige Tweed

Graphite Tweed

Grey Wool

Pink Melange



Green Melange

Grey Melange

Light Pink
Velvet Matt

Grey Velvet
Matt



Black Velvet
Matt

Mustard Velvet
Shiny

Bottle Green
Velvet Shiny

Navy Blue
Velvet Shiny

Grey Melange in the bedroom,
or Light Pink Velvet Matt in a girl's room?
You decide about the looks of your walls.





SETS. JUST CHOOSE

Too much choice? Maybe you prefer to use one of the ready-made sets offered by VOX designers. The available sets come in 5 sizes and 4 carefully chosen colour pallets. Well thought-through composition made with our panels may become a cosy addition to the living room, bedroom or the hall. Examine all the options and make your interior unique with simple and quick solution!



**LARGE SOFORM SET OVAL
GREY AND PINK**

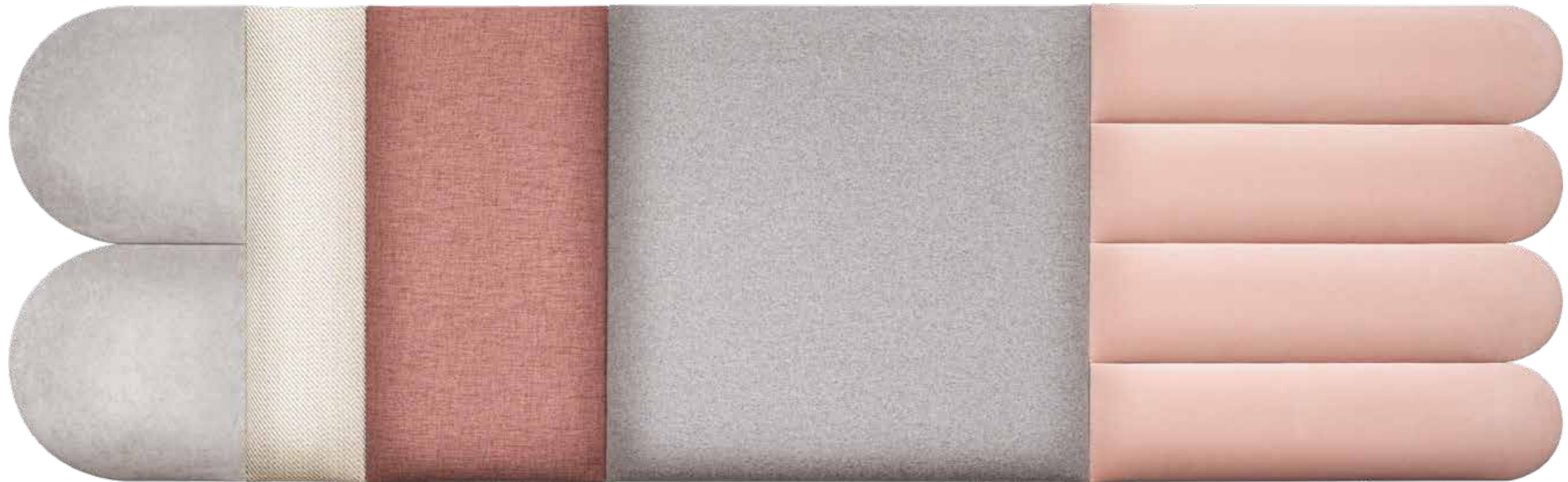

ELEMENTS

- OVAL 2 | Grey Velvet Matt 2 pcs.
- REGULAR 2 | Beige Tweed 1 pc.
- REGULAR 1 | Pink Melange 1 pc.
- REGULAR 3 | Grey Wool 1 pc.
- OVAL 1 | Light Pink Velvet Matt 4 pcs.

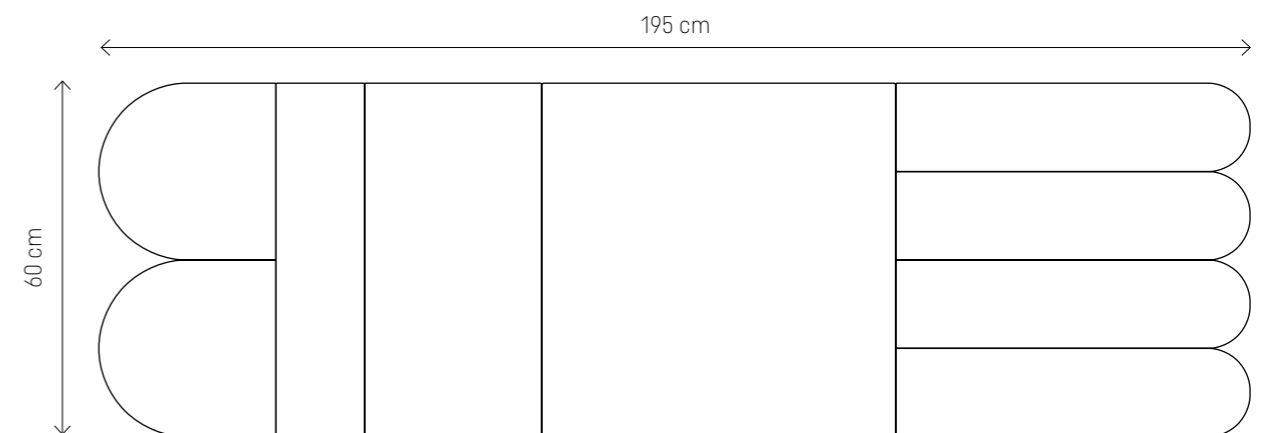

**LARGE SOFORM SET REGULAR
GREY AND PINK**



ELEMENTS

- REGULAR 1 | Grey Wool 1 pc.
- REGULAR 2 | Pink Melange 1 pc.
- REGULAR 3 | Light Pink Velvet Matt 1 pc.
- REGULAR 1 | Beige Tweed 1 pc.
- REGULAR 2 | Grey Wool 1 pc.
- REGULAR 1 | Pink Melange 1 pc.

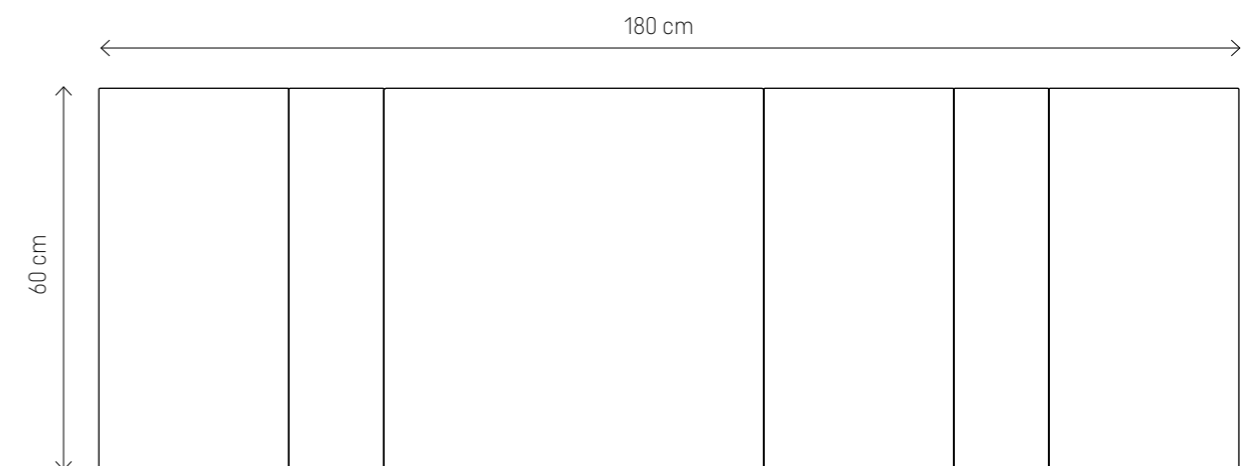



MEDIUM-SIZE SOFORM SET GREY AND PINK



ELEMENTS

- OVAL 2 | Grey Velvet Matt 2 pcs.
- REGULAR 1 | Beige Tweed 1 pc.
- REGULAR 3 | Light Pink Velvet Matt 1 pc.
- REGULAR 2 | Pink Melange 1 pc.

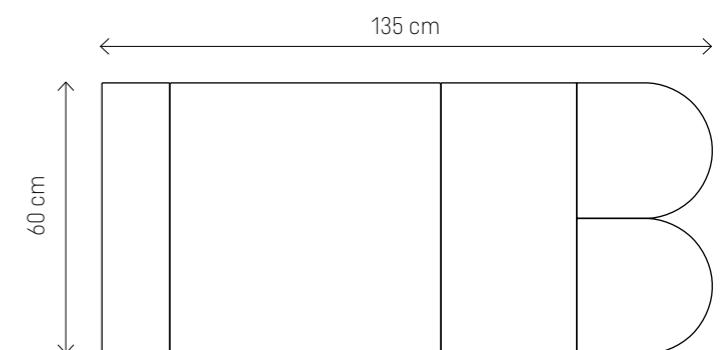



The sets can be mounted on the wall horizontally or vertically.
Choose the best option for yourself.

SMALL SOFORM SET
GREY AND PINK



ELEMENTS

- OVAL 2 | Light Pink Velvet Matt 1 pc.
- REGULAR 2 | Grey Wool 1 pc.
- OVAL 2 | Pink Melange 1 pc.

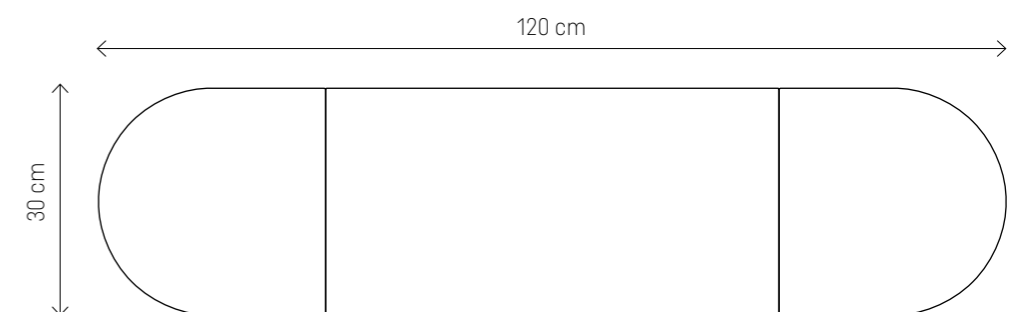



ATTENTION!

Notes, photos or souvenirs can be attached to the panels with pins or drawing pins. It is quick and easy to have all your important belongings anywhere you want.

**MINI SOFORM SET
GREY AND PINK**

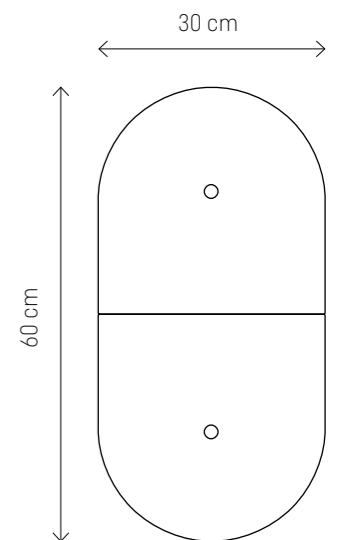

ELEMENTS

- OVAL 3 | Light Pink Velvet Matt 1 pc.
- OVAL 3 | Grey Wool 1 pc.



The composition attracts attention with its choice of colours - subdued grey and black are a great complement to the saturated mustard yellow.

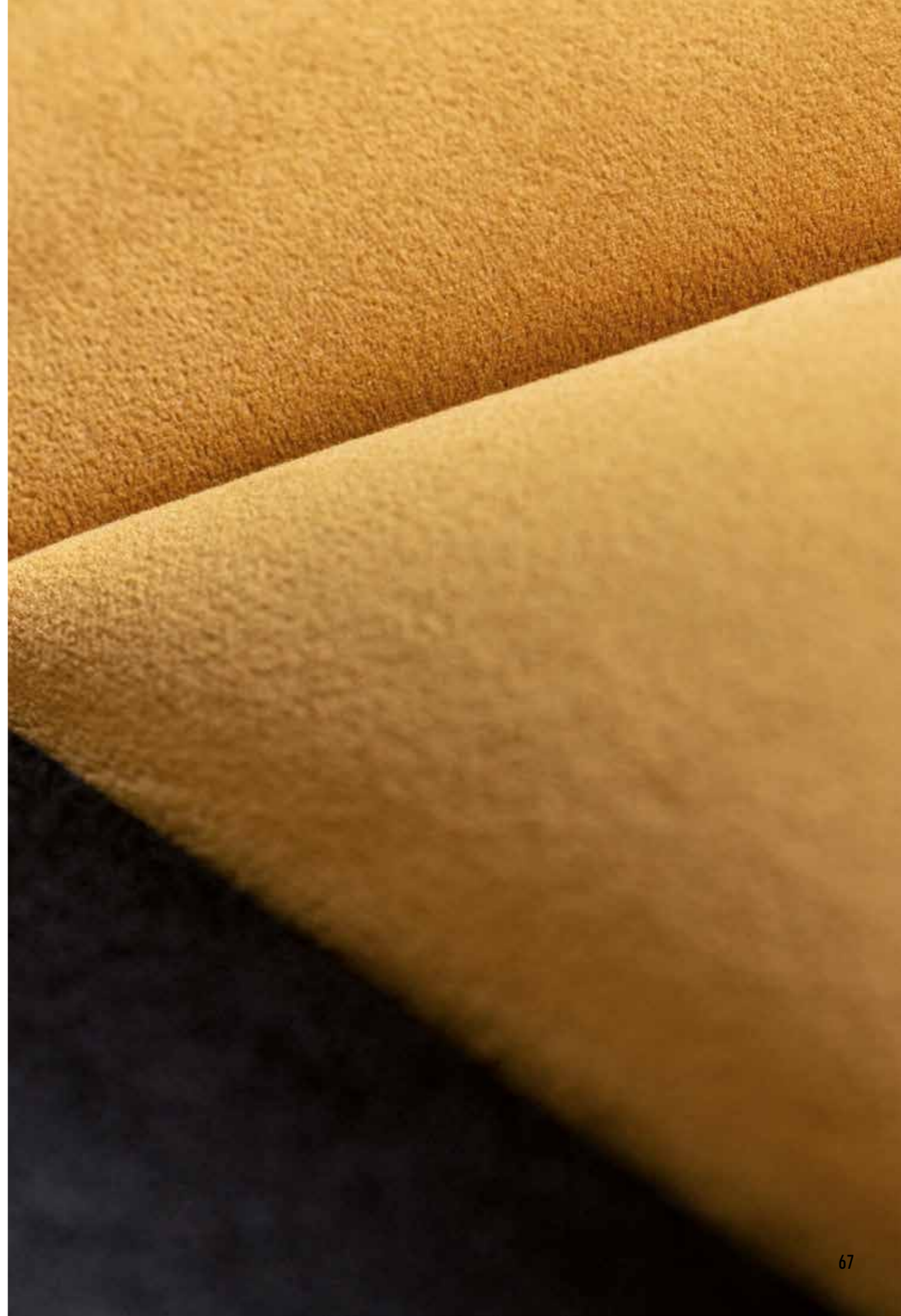

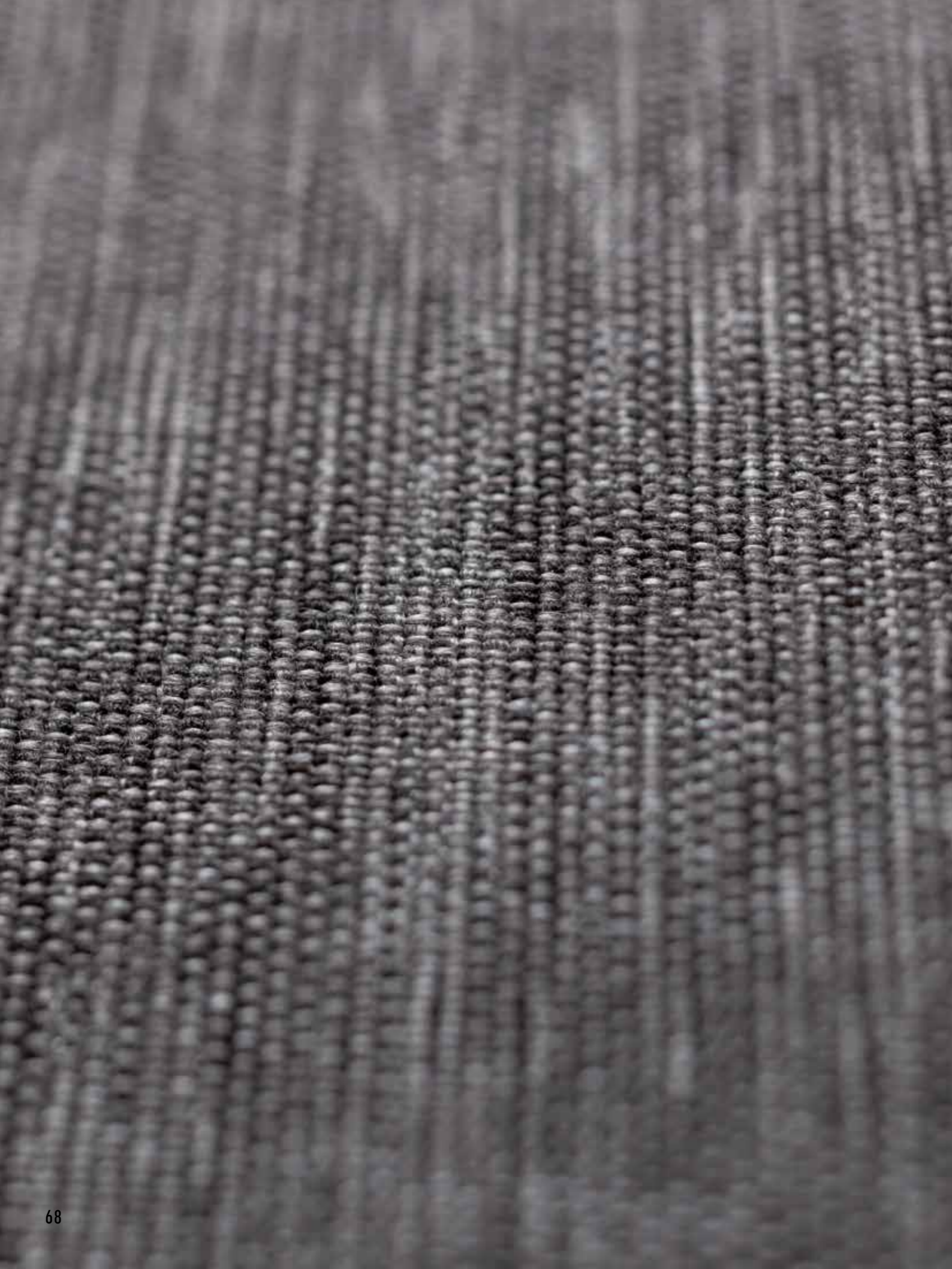

MEDIUM-SIZE SOFORM SET GREY AND MUSTARD



ELEMENTS

- REGULAR 2 | Black Velvet Matt 1 pc.
- REGULAR 3 | Grey Melange 1 pc.
- REGULAR 1 | Beige Tweed 1 pc.
- OVAL 3 | Mustard Velvet Shiny 2 pc.

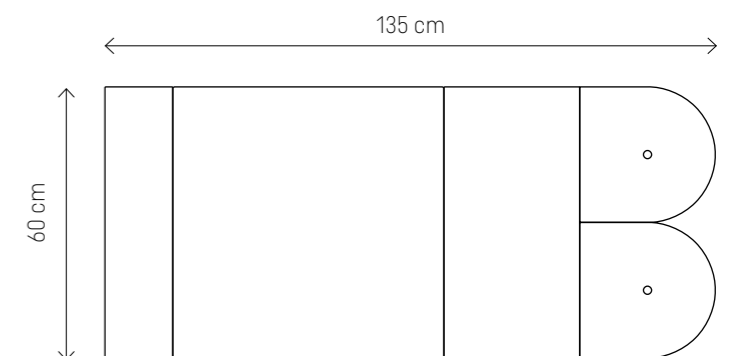

**LARGE SOFORM SET OVAL
GREY AND MUSTARD**

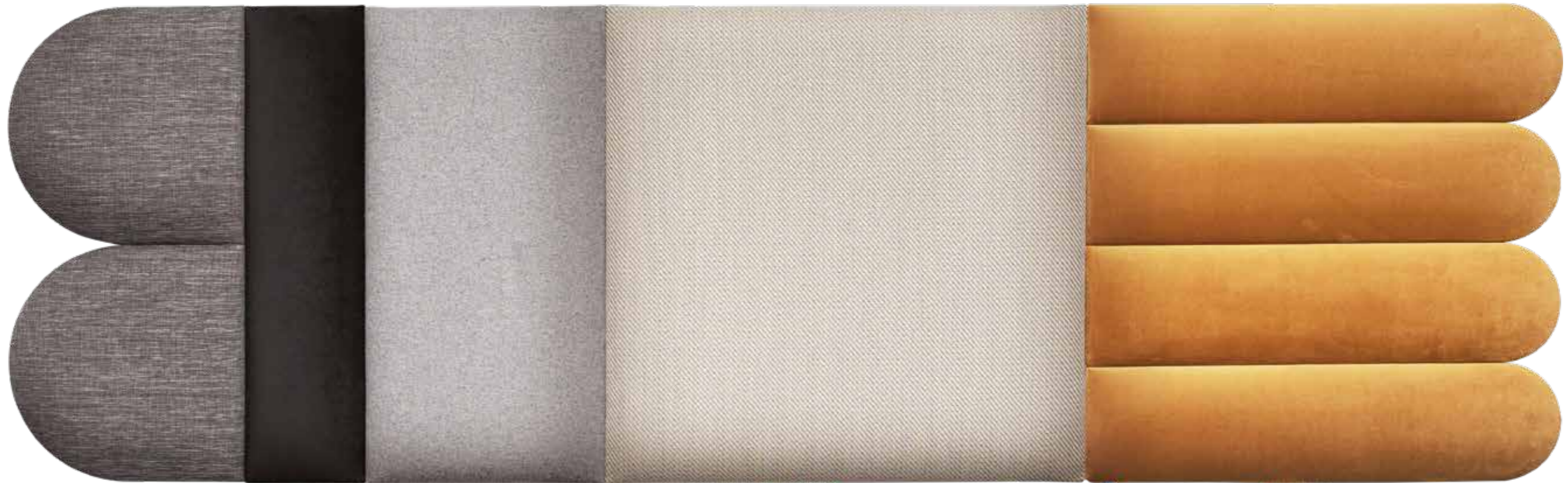

ELEMENTS

- OVAL 2 | Grey Melange 2 pcs.
- REGULAR 2 | Black Velvet Matt 1 pc.
- REGULAR 1 | Grey Wool 1 pc.
- REGULAR 3 | Beige Tweed 1 pc.
- OVAL 1 | Mustard Velvet Shiny 4 pcs.

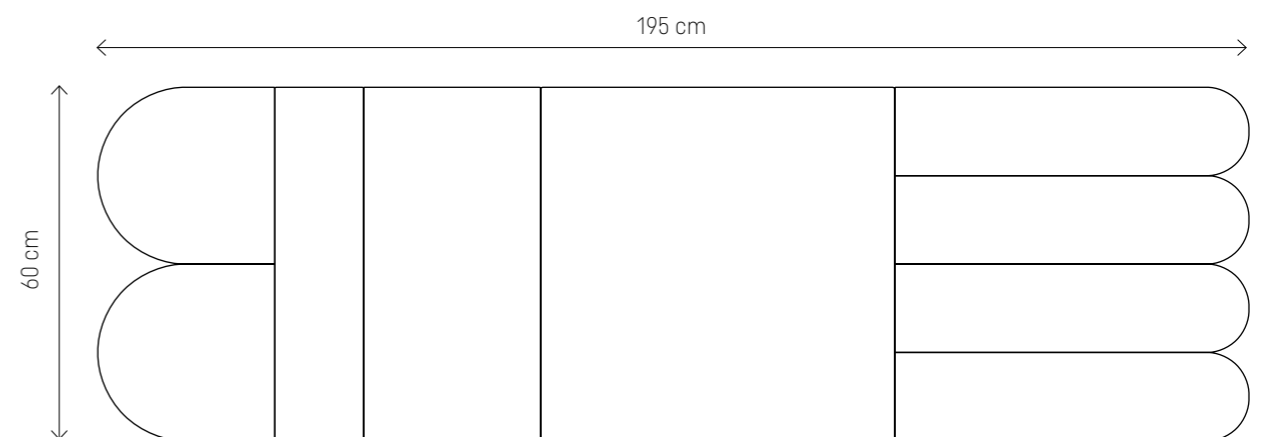

**LARGE SOFORM SET REGULAR
GREY AND MUSTARD**



ELEMENTS

- REGULAR 1 | Mustard Velvet Shiny 1 pc.
- REGULAR 2 | Black Velvet Matt 1 pc.
- REGULAR 3 | Grey Melange 1 pc.
- REGULAR 1 | Beige Tweed 1 pc.
- REGULAR 2 | Black Velvet Matt 1 pc.
- REGULAR 1 | Grey Wool 1 pc.

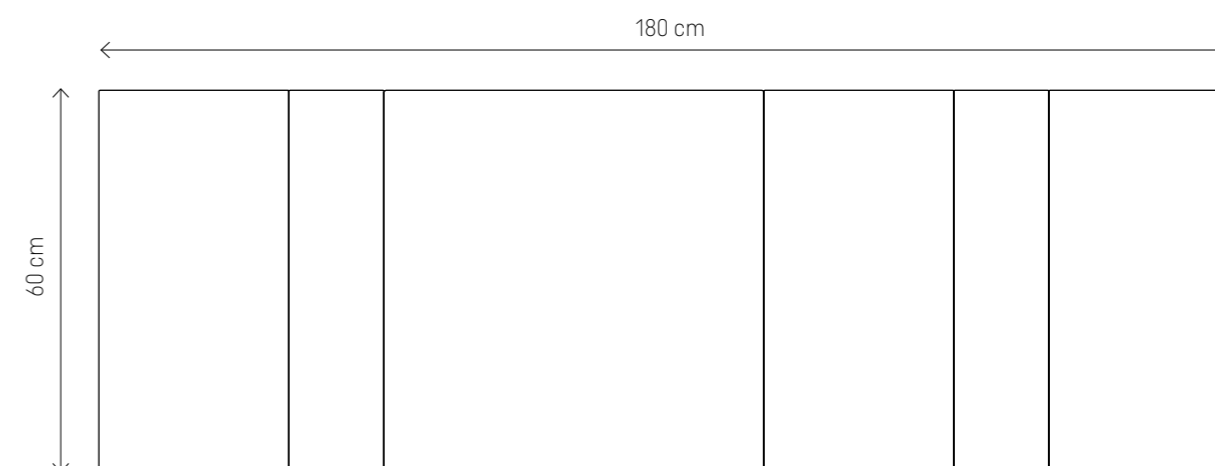



**SMALL SOFORM SET
GREY AND MUSTARD**

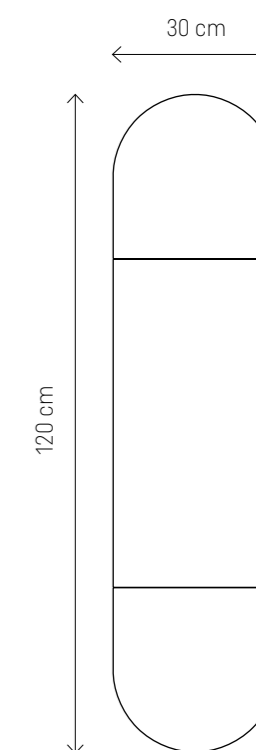

ELEMENTY

- OVAL 2 | Black Velvet Matt 1 pc.
- REGULAR 2 | Mustard Velvet Shiny 1 pc.
- OVAL 2 | Beige Tweed 1 pc.

MINI SOFORM SET GREY AND MUSTARD

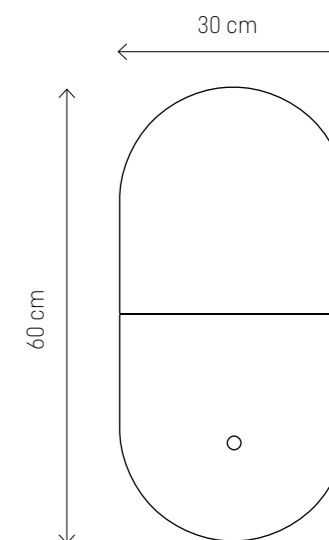
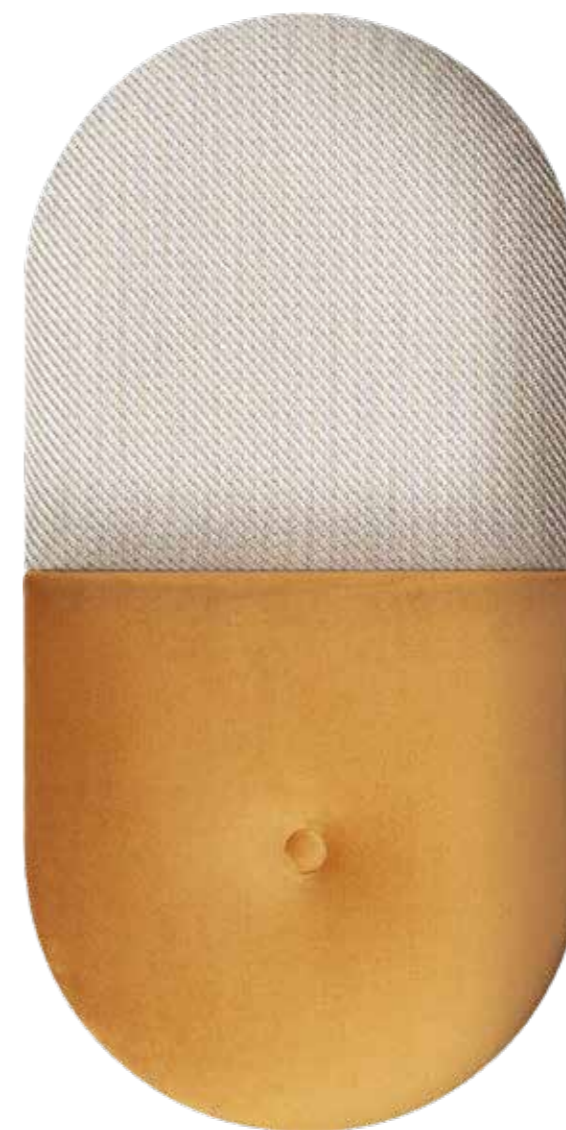

ELEMENTS

- OVAL 2 | Beige Tweed 1 pc.
- OVAL 3 | Mustard Velvet Shiny 1 pc.





ATTENTION!

The panels can be equipped with hooks to hang your handbag or a charger. A metal hook should be placed between the chosen panels before they are attached to the wall.

**MINI SOFORM SET
GREEN AND GREY**

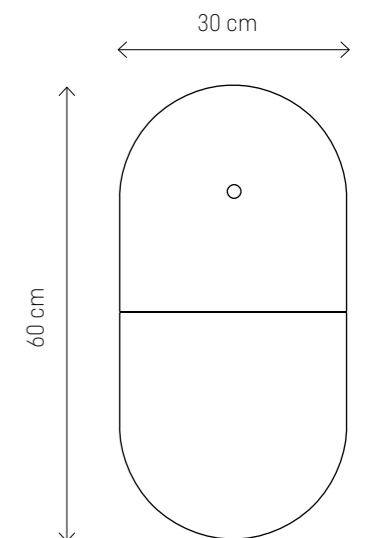
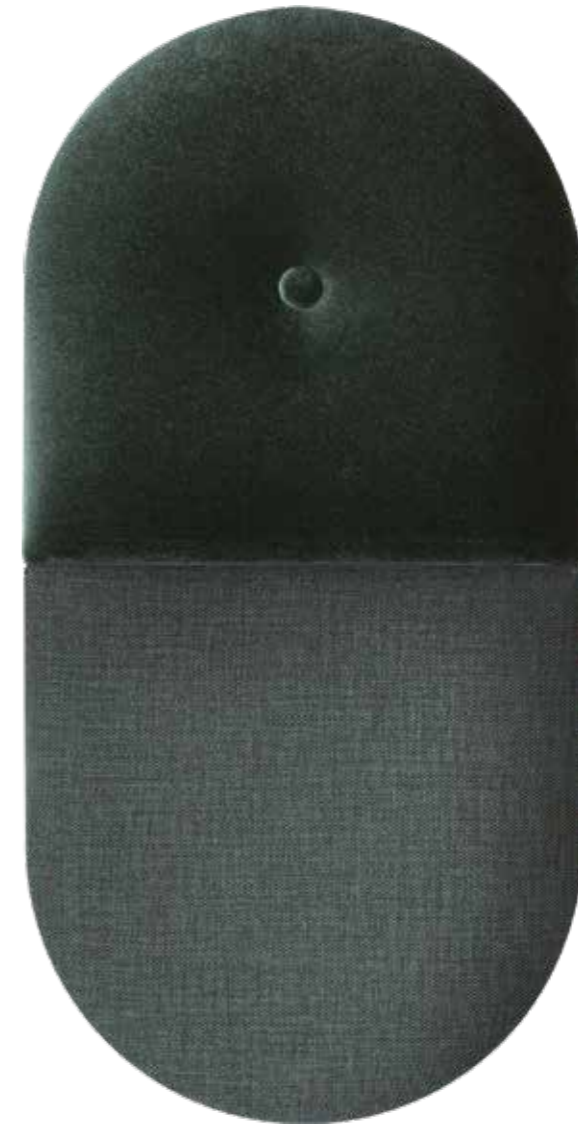

ELEMENTS

- OVAL 3 | Bottle Green Velvet Shiny 1 pc.
- OVAL 2 | Green Melange 1 pc.

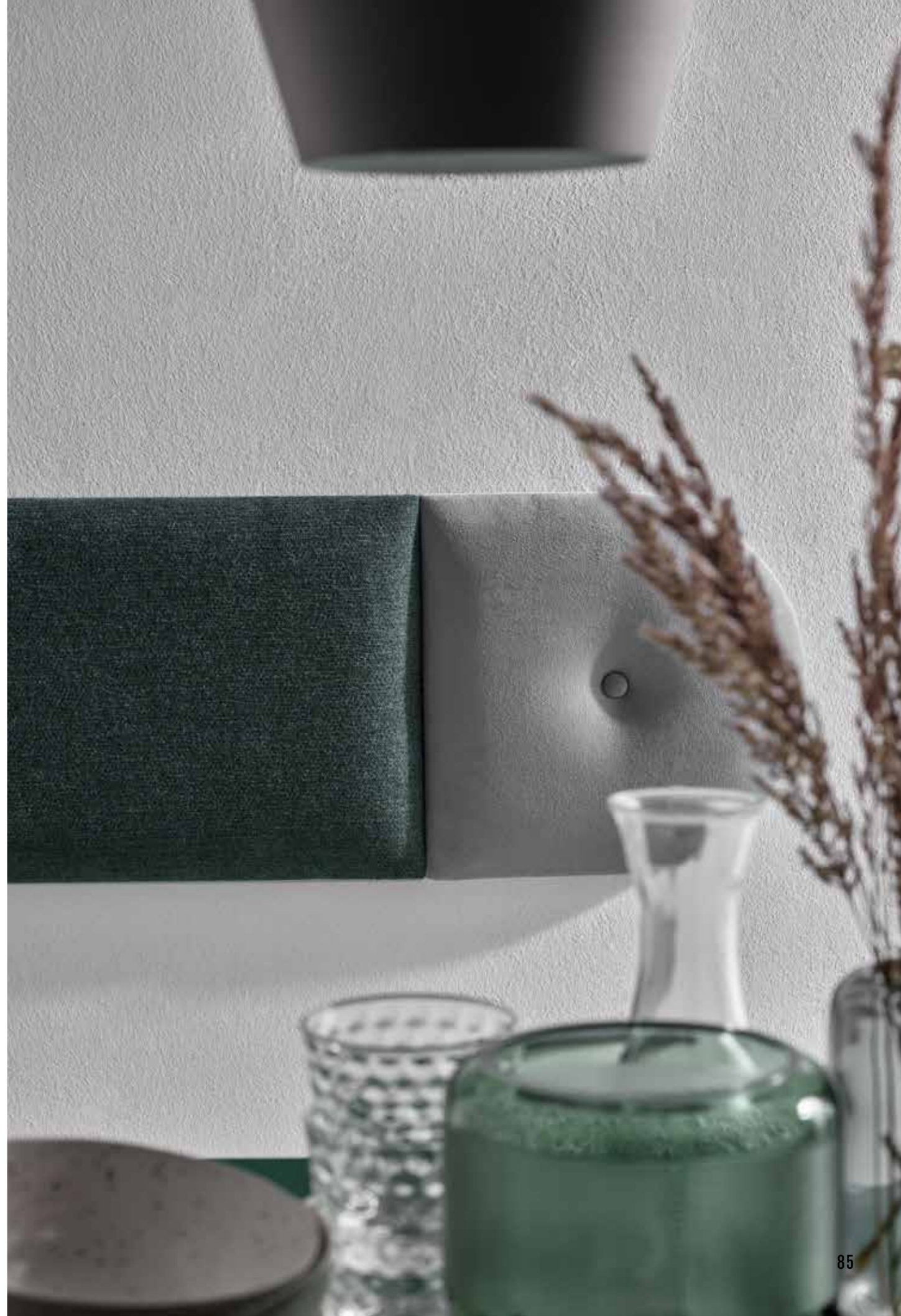

SMALL SOFORM SET
GREEN AND GREY



ELEMENTS

- OVAL 2 | Bottle Green Velvet Shiny 1 pc.
- REGULAR 2 | Green Melange 1 pc.
- OVAL 3 | Grey Velvet Matt 1 pc.

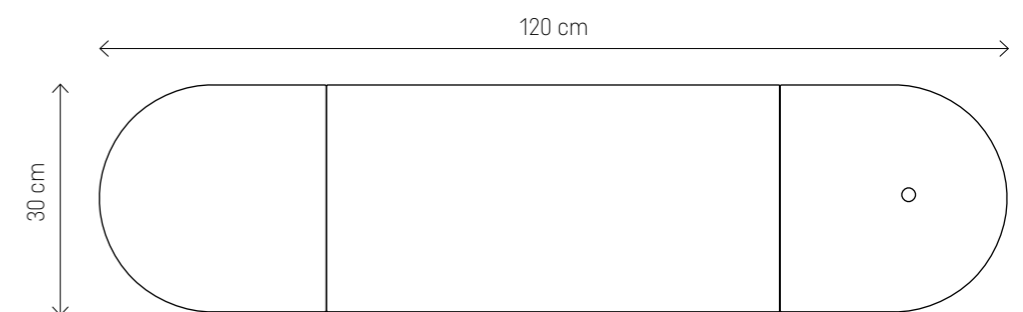



**MEDIUM-SIZE SOFORM SET
GREEN AND GREY**

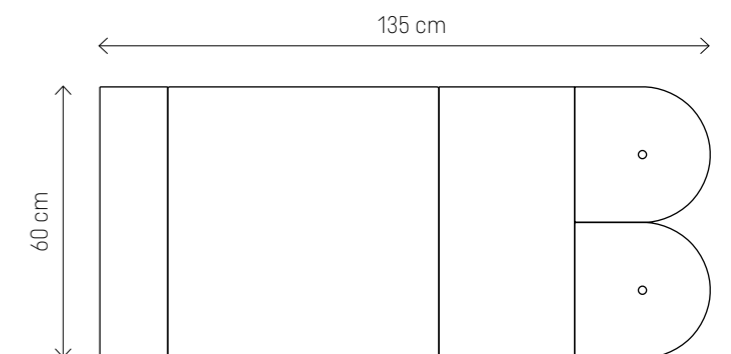

ELEMENTS

- REGULAR 2 | Grey Velvet Matt 1 pc.
- REGULAR 3 | Green Melange 1 pc.
- REGULAR 1 | Beige Tweed 1 pc.
- OVAL 3 | Bottle Green Velvet Shiny 2 pcs.

LARGE SOFORM SET OVAL
GREEN AND GREY

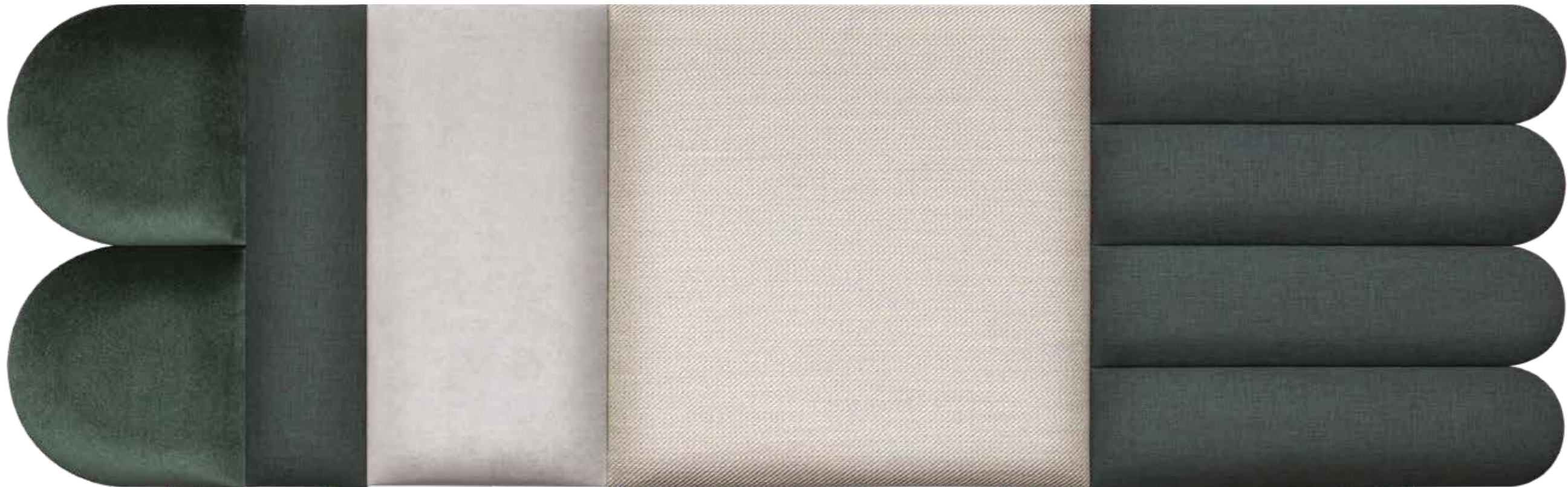

ELEMENTS

- OVAL 2 | Bottle Green Velvet Shiny 2 pcs.
- REGULAR 2 | Green Melange 1 pc.
- REGULAR 1 | Grey Velvet Matt 1 pc.
- REGULAR 3 | Beige Tweed 1 pc.
- OVAL 1 | Green Melange 4 pcs.

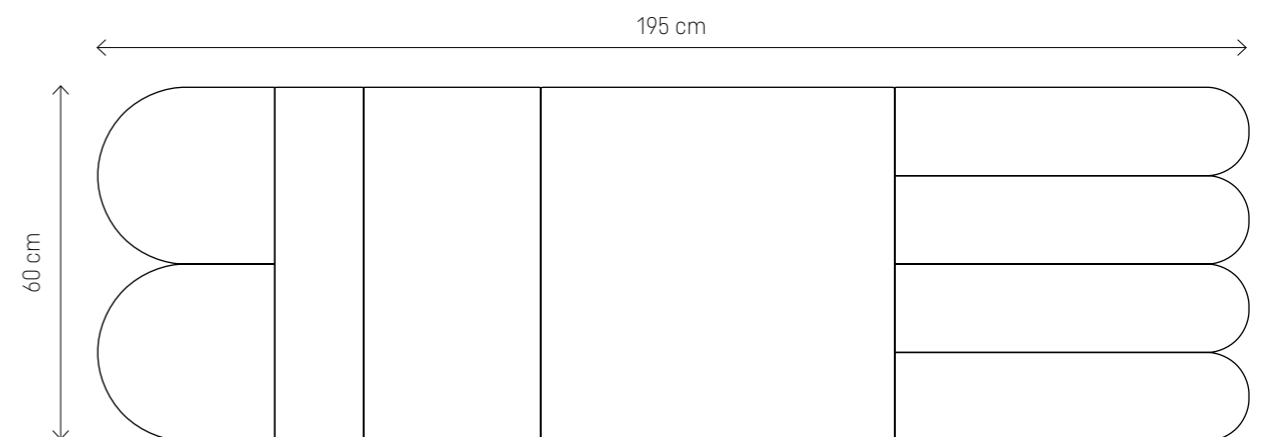

**LARGE SOFORM SET REGULAR
GREEN AND GREY**



ELEMENTS

- REGULAR 1 | Grey Velvet Matt 1 pc.
- REGULAR 2 | Bottle Green Velvet Shiny 1 pc.
- REGULAR 3 | Green Melange 1 pc.
- REGULAR 1 | Beige Tweed 1 pc.
- REGULAR 2 | Grey Velvet Matt 1 pc.
- REGULAR 1 | Green Melange 1 pc.

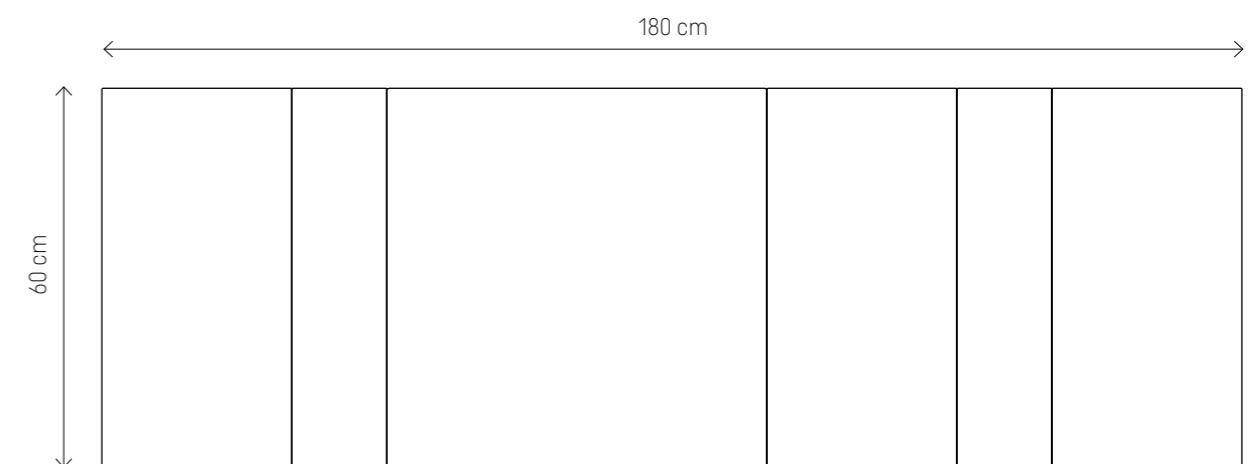



Let your interior become the stage for your creativity. The set of rectangular Regular panels will ensure your comfort while reading in the evening or enjoying your passion for music. Two quilted Oval panels put together constitute a perfect base for photographs and notes. If you wish to create a comfy office space you can combine Regular and Oval panels over your desk to organize your bits and pieces.

LARGE SOFORM SET REGULAR
NAVY BLUE AND GREY



ELEMENTS

- REGULAR 1 | Grey Velvet Matt 1 pc.
- REGULAR 2 | Navy Blue Velvet Shiny 1 pc.
- REGULAR 1 | Beige Tweed 1 pc.
- REGULAR 3 | Graphite Tweed 1 pc.
- REGULAR 2 | Grey Velvet Matt 1 pc.
- REGULAR 1 | Navy Blue Velvet Shiny 1 pc.

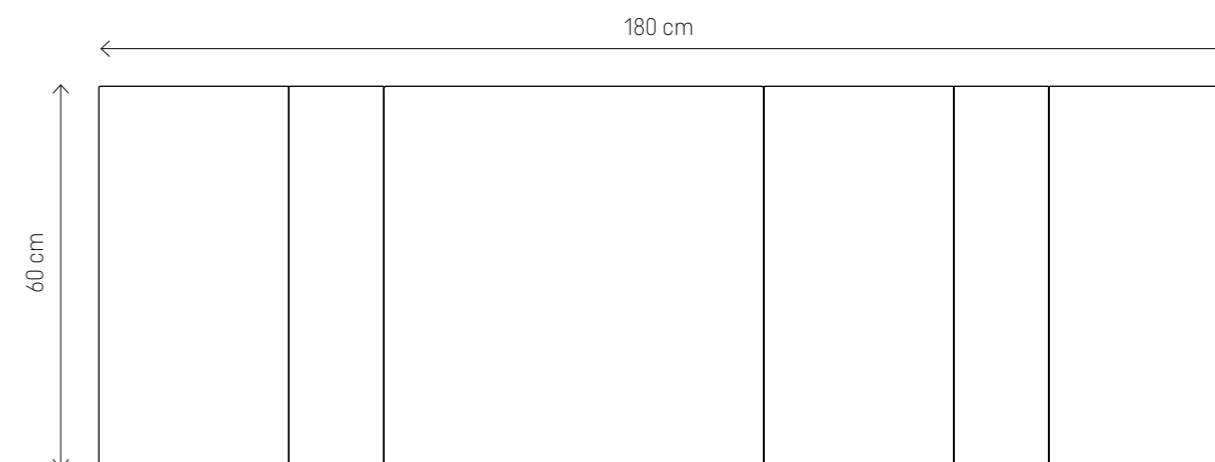

LARGE SOFORM SET OVAL
NAVY BLUE AND GREY



ELEMENTS

- OVAL 2 | Grey Velvet Matt 2 pcs.
- REGULAR 2 | Navy Blue Velvet Shiny 1 pc.
- REGULAR 1 | Beige Tweed 1 pc.
- REGULAR 3 | Graphite Tweed 1 pc.
- OVAL 1 | Navy Blue Velvet Shiny 4 pcs.

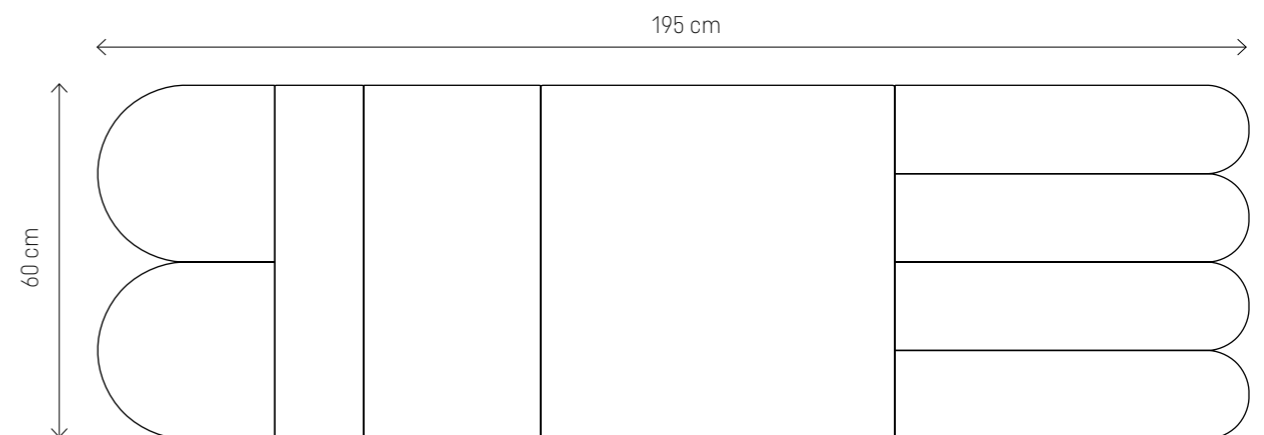

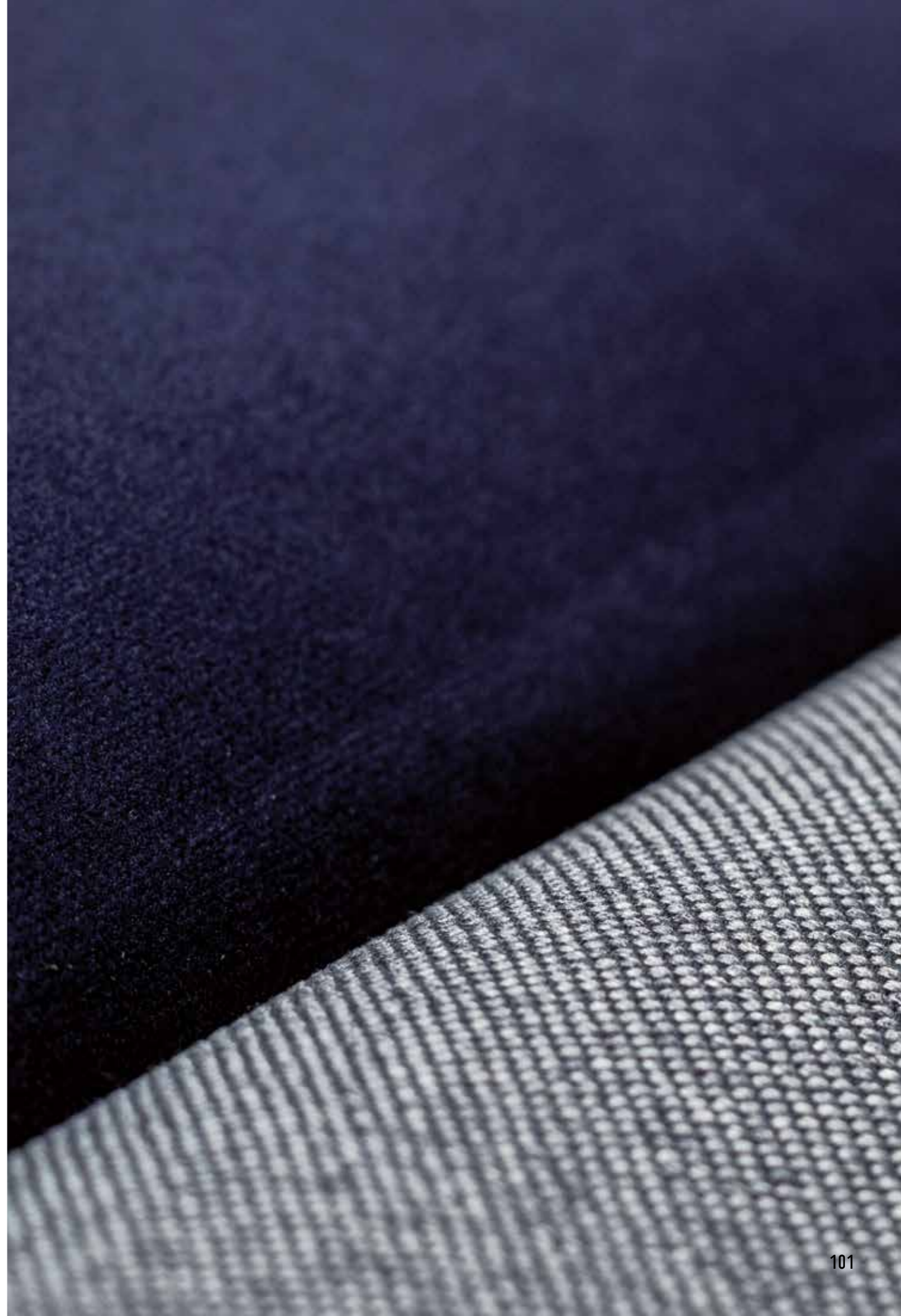

SMALL SOFORM SET
NAVY BLUE AND GREY



ELEMENTS

- OVAL 2 | Beige Tweed 1 pc.
- REGULAR 2 | Graphite Tweed 1 pc.
- OVAL 3 | Navy Blue Velvet Shiny 1 pc.

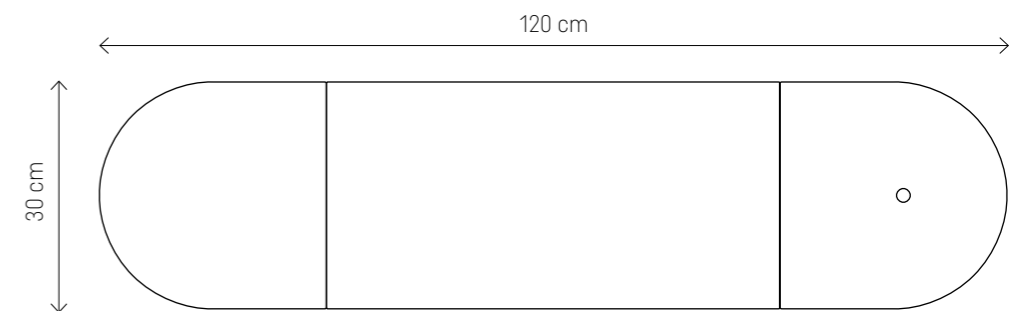



MEDIUM-SIZE SOFORM SET NAVY BLUE AND GREY



ELEMENTS

- REGULAR 2 | Beige Tweed 1 pc.
- REGULAR 3 | Graphite Tweed 1 pc.
- REGULAR 1 | Grey Velvet Matt 1 pc.
- OVAL 3 | Navy Blue Velvet Shiny 2 pcs.

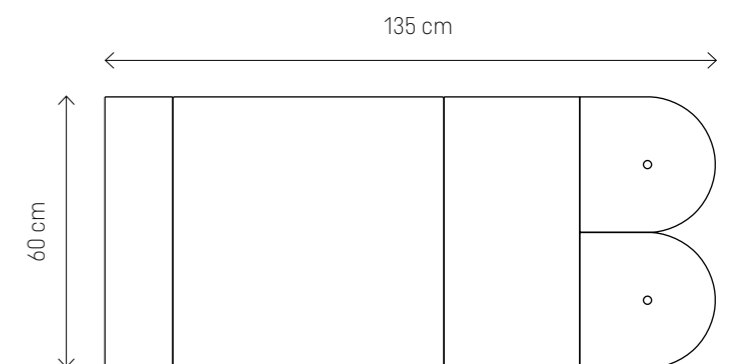

MINI SOFORM SET
NAVY BLUE AND GREY



ELEMENTS

- OVAL 3 | Beige Tweed 1 pc.
- OVAL 3 | Navy Blue Velvet Shiny 1 pc.

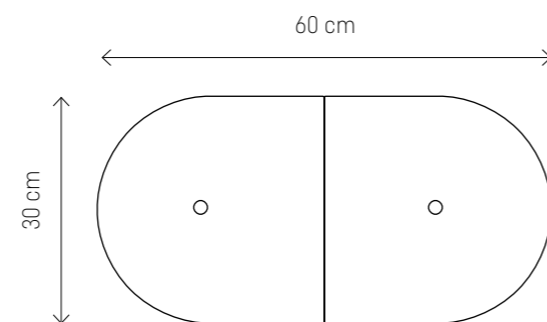

GREY AND PINK

LARGE OVAL SET



OVAL 2 | REGULAR 2 | REGULAR 1 | REGULAR 3 | OVAL 1

195x60 cm

LARGE REGULAR SET



REGULAR 1 | REGULAR 2 | REGULAR 3 | REGULAR 1 | REGULAR 2 | REGULAR 1

180x60 cm

MEDIUM-SIZE SET



REGULAR 2
REGULAR 3
REGULAR 1
OVAL 2

60x135 cm

SMALL SET



OVAL 2
REGULAR 1
OVAL 2

30x120 cm

MINI SET



OVAL 3
OVAL 3

30x60 cm

GREEN AND GREY

LARGE OVAL SET



OVAL 2 | REGULAR 2 | REGULAR 1 | REGULAR 3 | OVAL 1

195x60 cm

LARGE REGULAR SET



REGULAR 1 | REGULAR 2 | REGULAR 3 | REGULAR 1 | REGULAR 2 | REGULAR 1

180x60 cm

MEDIUM-SIZE SET



REGULAR 2
REGULAR 3
REGULAR 1
OVAL 2

60x135 cm

SMALL SET



OVAL 2
REGULAR 1
OVAL 2

30x120 cm

MINI SET



OVAL 3
OVAL 3

30x60 cm

GREY AND MUSTARD

LARGE OVAL SET



OVAL 2 | REGULAR 2 | REGULAR 1 | REGULAR 3 | OVAL 1

195x60 cm

LARGE REGULAR SET



REGULAR 1 | REGULAR 2 | REGULAR 3 | REGULAR 1 | REGULAR 2 | REGULAR 1

180x60 cm

MEDIUM-SIZE SET



REGULAR 2
REGULAR 3
REGULAR 1
OVAL 2

60x135 cm

SMALL SET



OVAL 2
REGULAR 1
OVAL 2

30x120 cm

MINI SET



OVAL 3
OVAL 3

30x60 cm

NAVY BLUE AND GREY

LARGE OVAL SET



OVAL 2 | REGULAR 2 | REGULAR 1 | REGULAR 3 | OVAL 1

195x60 cm

LARGE REGULAR SET



REGULAR 1 | REGULAR 2 | REGULAR 3 | REGULAR 1 | REGULAR 2 | REGULAR 1

180x60 cm

MEDIUM-SIZE SET



REGULAR 2
REGULAR 3
REGULAR 1
OVAL 2

60x135 cm

SMALL SET



OVAL 2
REGULAR 1
OVAL 2

30x120 cm

MINI SET



OVAL 3
OVAL 3

30x60 cm

SELF-ASSEMBLY READY IN FEW MINUTES

Soform upholstered panels are installed quickly, non-invasively and clean. Pick the fragment of the wall, draw support lines, add some glue to the panel and press it against the wall. Velcro tape can be used instead of glue. Place the tape on the back of the panel, take off the protection film and place the panel against the previously drawn lines.

Clean the wall. Place the arrangement on the floor. Draw a horizontal and a vertical line.

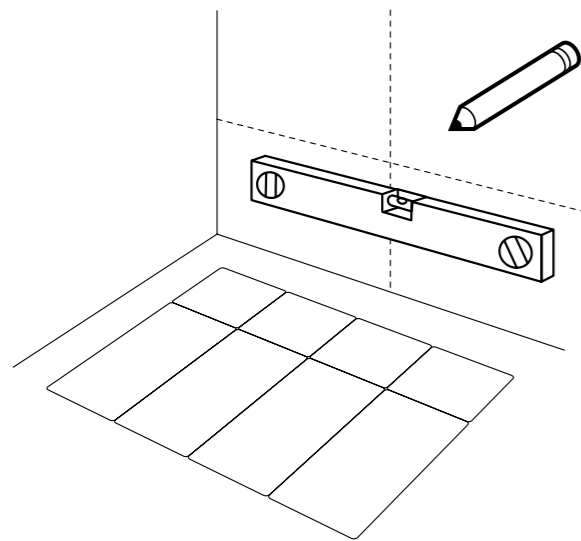

Add glue or place Velcro tape to the panel.

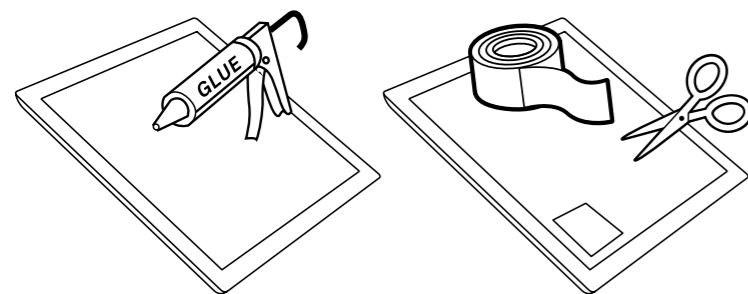

Glue according to the drawing, pressing the panels against the surface. You have limited time to correct the arrangement.

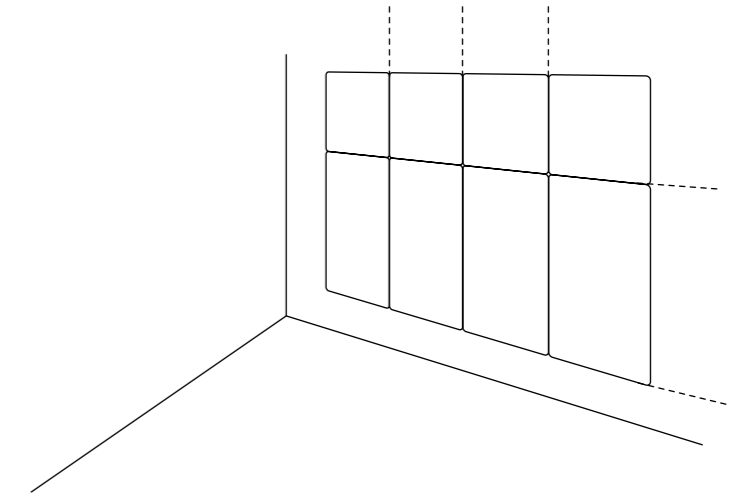

Place the elastic bands on the chosen panels before you glue the panels to the wall.

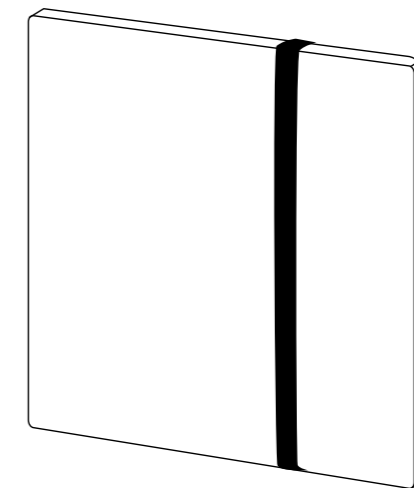

Mount the hooks between the panels before assembly.

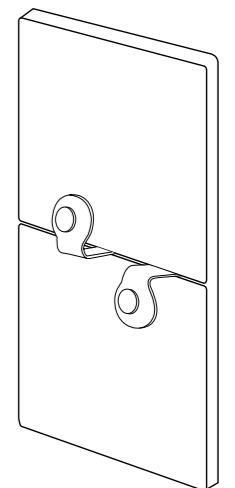

Detailed manual can be found inside the package and on our website.

DESIGN YOUR VOXBOX INTERIOR

DESIGN

and arrange your space using a wide range of not only furniture but also floors, doors, lamps and VOX accessories.

EVALUATE

the whole design including a detailed calculation. You don't have to spend time doing the maths - the program will provide you with the numbers of, for example, needed packets of your chosen floor type.

ORDER

the chosen products by moving from your design to the VOX online-shop. If you choose to create your design at one of the VOX showroom stores with our consultant, you will be able to place the order there.



In 2020, VOXBOX won the 'Dobry Wzór' award. The jury pointed out the practicality and usefulness of the app that helps design dream interiors directly in an Internet browser. Also, its interface, friendly even to an unexperienced user, has been appreciated by the jury.

YOU CAN SEE YOUR DESIGN IN VR TECHNOLOGY IN OUR SHOWROOMS.

LOOKING FOR INSPIRATION?

Use our range of ready-made designs. All you have to do is alter the dimensions of the default designs to match your interior.

vox.pl/en/projects-voxbox

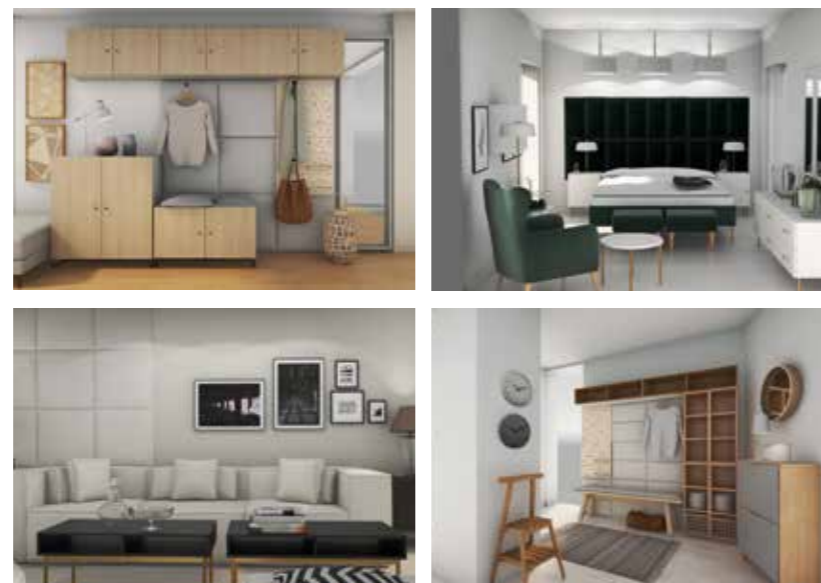

This catalogue is published for information purposes only and does not constitute a commercial offer within the meaning of article 66 § 1 of the Civil Code. VOX reserves the right to introduce changes and updates to the colours, dimensions, functions and prices of the presented products. The basis for the conclusion of the sales contract is a transaction conducted directly in the showroom or through the online shop: vox.pl

Copyright by Meble VOX Sp. z o.o. sp.k. All rights reserved. Copying and distribution of any materials contained in the catalogue without the written consent of the publisher is prohibited. The colours in the catalogue may differ from reality.

All data contained in the catalogue are valid for the month in which the catalogue goes to print - November 2021.



Meble VOX sp. z o.o. sp. k.
ul. Gdyńska 143
62-004 Czerwonak



vox.pl/en