

USER MANUAL



ColourPoint

Battery Wireless Up-light Lithium Battery Mk2



Contents

Contents	1
Disclaimer	3
Product Modification	3
Safety Information	3
Before You Begin	4
Product Overview	4
<i>Features</i>	4
<i>Product Contents</i>	4
<i>Safety</i>	4
Getting Started	5
<i>ColourPoint Key Elements</i>	5
<i>Power</i>	5
<i>Ventilation and Mounting</i>	6
Operation	7
<i>Power</i>	7
<i>Charging</i>	7
<i>External Power (Optional Accessory)</i>	7
<i>Control Panel</i>	8
Function Modes	9
<i>CUSTOM Colour</i>	9
<i>STATIC Operation</i>	10
<i>EFFECT Mode</i>	11
<i>DMX Mode</i>	11
DMX OPERATION	12
<i>DMX Mode</i>	12
<i>W-DMX Pairing and Unpairing</i>	13
<i>DMX Master Operation</i>	14

<i>DMX Slave Operation</i>	14
Additional Settings	16
<i>Power Mode</i>	16
<i>Brightness Control</i>	17
<i>PWM Frequency Control</i>	17
<i>Keypad Lock</i>	17
Mechanical	18
<i>Dimensions</i>	18
<i>Antenna</i>	18
<i>Locking</i>	18
Warranty	19
Compliance Information	20
<i>System Compliance</i>	20
FCC & Industry Canada Statement for Radio Compliance	20
<i>W-DMX Transmitter & Receiver</i>	20
WEEE & RoHS Statement	21

Disclaimer

CORE Lighting Limited believe the information in this manual is accurate and complete however assumes no responsibility for any error or omissions within this document or any other documentation accompanying the product. We reserve the right to revise this document at any time. Please see www.corelighting.co.uk/support to download latest version.

Product Modification

This CORE Lighting product has been designed and manufactured to meet the strict requirements of UK, EU and International safety regulations. Any unauthorised modifications to the product including replacement of parts with non-standard parts could compromise safety and result in the product being non-compliant with relevant standards.

There are no user serviceable parts within this product.

Safety Information

Important safety information is contained within this manual. Please read all instructions fully prior to installation and use of the equipment.

Internationally recognised symbols are used within the document to highlight important messages as follows:



Critical installation or usage information.

Failure to comply with this information may cause damage to the product, third party equipment or cause harm or injury



Important installation or usage information.

Failure to comply with this information may cause the product to operate incorrectly

Note: Restrictions apply to transporting this equipment on aircraft due to the lithium polymer batteries having capacity greater than 100Wh. Please consult IATA Packing Instructions 967 and CORE Lighting Ltd for further information.

Before You Begin

The CORE ColourPoint fixture is a battery-powered wireless up-lighter capable of providing portable and instant architectural and feature lighting anywhere. With high-powered red, green, blue and white LEDs the fixture is capable of producing any colour or shade of white using combinations of those LEDs. Ideal for illuminating buildings in colour, both indoors and outdoors, the fixture is powerful enough to light buildings of 4 or 5 storeys. Lighting effects may be created by connecting to effects generators such as lighting desks or other CORE Master units using the in-built Wireless DMX receiver. Simply connect wirelessly to the transmitter of the generator.

The product is designed, manufactured and supported in the UK plus local distributor support.

Product Overview

Features

- High powered 2000lumen RGBW LEDs equivalent to 5300 Lux @ 2m
- 4 x Cree high-powered RGBW LED arrays
- Lithium Ion Battery reducing unit weight to just 4.0Kg
- LEE Filter Colour Library or separate RGBW control. Plus built-in colour programs.
- Wireless DMX wireless Master + Slave control (2.4GHz W-DMX from Wireless Solution, Sweden)
- Cable DMX input and output of full universe– unit acts as Wireless DMX receiver to cable DMX converter or as cable DMX to Wireless DMX converter
- 4 or 5 Channel DMX operation and variable PWM frequency for TV work
- Intuitive LCD menu
- Designed and Manufactured in the UK
- Operating temperature range -20 to +45 degC or -4 to +113 degF

Product Contents

Please contact your dealer immediately if there are any signs of product damage or parts missing.

Single unit

- 1x ColourPoint wireless LED fixture
- 1x Stainless steel shroud
- 1x Battery charger
- 1x Power cable
- 1x Shortform Manual

Charging case of six units

- 6x ColourPoint Wireless LED fixtures
- 6x Stainless steel shroud
- 1x Charging case
- 1x Powercon Cable
- 1x Manual

Safety

- AVOID direct eye exposure to the light source when illuminated
- DO NOT submerge this product in water or expose to excessive water spray
- DO NOT hang this product other than by the means indicated in this manual
- DO NOT leave any flammable material near product whilst operating or charging
- ALWAYS use the supplied charger or charging case
- ALWAYS ensure the charger is connected to the specified voltage
- ALWAYS ensure the charging case lid is open whilst plugged into mains supply
- ALWAYS fully charge the unit immediately after discharge
- ALWAYS recharge the unit periodically if left unused, at least every 6 months.
- NEVER connect this product or charger to a dimmer pack
- DO NOT operate this fixture if it appears damaged in any way
- DO NOT operate this fixture where the ambient temperature exceeds 45°C



In the unlikely event that your product develops a fault, please contact your local dealer or authorised distributor.

Do not attempt to repair yourself unless specifically instructed by CORE Lighting Ltd.

Getting Started

ColourPoint Key Elements

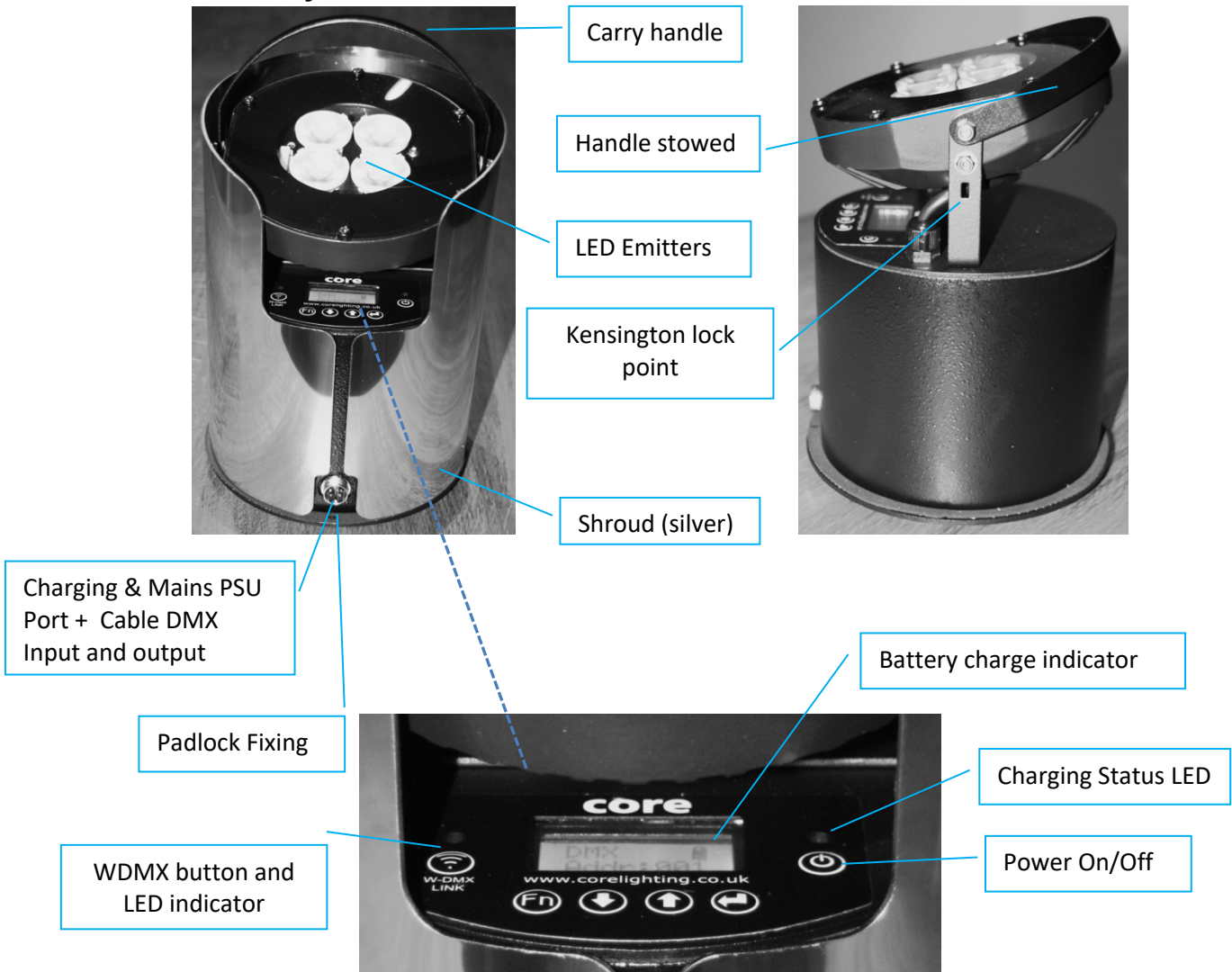

Power

The battery charger may be included as an accessory for individually purchased fixtures or built into the flight case for multiple charging fixtures. In each case the supply has an input voltage range of 100-240 VAC at 50/60Hz.



Ensure the product is used only with correct voltage and frequency of mains supply.



Never connect the charger or charging case to a dimmer circuit, even when a dimmer has been configured for 'non-dim' or 'switched' operation.



We do not recommend to run the fixture with more than 3 colours set to maximum value 255 at 100% brightness as this can run the head at very hot temperatures which can severely shorten the life of the LEDs.

This should not be necessary in ColourPoint as white LEDs are provided to set shades of white, which also run white colours much more efficiently, drain the battery less, and have a better white tone.



DO NOT plug the mains input (PowerCON) into the case while it is 'live' to prevent electrical damage to the input connector. Switch on at the wall after it is plugged in.



When using a charging flight case, ensure the unit is pushed fully down on the charging connector and the protruding screws are located in their positioning holes. The charge light on top of the unit should illuminate to signify this has been done.

Ventilation and Mounting



Always use the product in a safe position and ensure there is enough room around it for ventilation. **Never close the lid during charging; this allows escape of heat.**

Operation

Power



- Push and hold this power button for >1 second to switch the unit ON or OFF
- The display will show “CORE Lighting” and software version for a few seconds before starting
- The display backlight will extinguish after a short time to reduce power use

Charging

- **Turn the unit OFF** before connecting to the charger
- Only use the supplied charger or charging case
- External chargers should be plugged into the 5-pin connector on the front of the unit.
- Fully engage the unit into the case if necessary rotate until it locates on the protruding screws
- **DO NOT** plug the Powercon mains input into the case while it is ‘live’. Switch on at the wall when it is plugged in.
- Always recharge the battery fully before storage
- When charging in the charging case, it is best to **ensure the case lid remains open to disperse heat**, although the lid may be closed in cooler climates.
- Switch off the charger unit and unplug once fully charged
- Whilst charging the LED indicator will illuminate in AMBER
- Once fully charged the LED indicator will show GREEN



DO NOT use any charger other than the unit supplied with the ColourPoint.

Charging Charged



DO NOT plug the mains input (PowerCON) into the case while it is ‘live’ to prevent electrical damage to the input connector. Switch on at the wall after it is plugged in.



When using a charging flight case, ensure the unit is pushed fully down on the charging connector and the protruding screws are located in their positioning holes. The charge light on top of the unit should illuminate to signify this has been done.

The unit will switch itself off when placed in a charging case and will remain off. Do not try to switch on the unit whilst in the case to prevent any potential for the software & hardware combination to lock up. In the unfortunate situation where this should happen, then remove the base of the unit and unplug the battery (or let the battery drain completely). This will reset the microprocessor and recover from the lock-up.

External Power (Optional Accessory)

- A separately available power supply is available as an accessory to drive the ColourPoint from mains voltage 100-250VAC 50/60Hz.
- Connect this to the charging/power port in the front of the unit.
- The device supplies 24VDC to the ColourPoint which replaces battery power.
- Battery is disconnected whilst the Power Supply is plugged in so will not be charged or discharged.

Control Panel

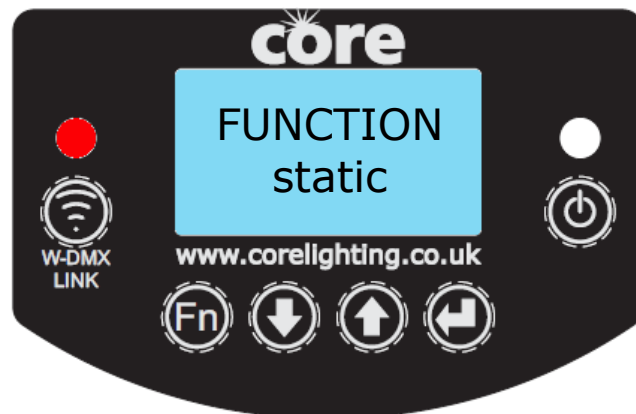

Enables changes to FUNCTION or SETTINGS or DMX Mode menus
Exits from the current option or menu



Navigates backwards through the menu list
or decrements a numeric value
or navigates back through available values



Navigates forward through the menu list
or increments a numeric value
or navigates forward through available values



Enters the currently displayed menu option
or saves the currently displayed value







Wireless DMX control. Used to link and unlink the fixture from a wireless network

Function Modes

There are four modes of Operation, accessed through the **FUNCTION** menu;



CUSTOM	This mode allows the user to control the level of the Red, Green, Blue or White output, allowing any colour to be created. If 'WDMX Master' is selected in the separate DMX Mode menu the colour is transmitted to external Slave fixtures when this unit is operated in this CUSTOM mode. Any DMX input signal, if present, is ignored.
STATIC	In this mode the fixture outputs a static LEE or preset 'cc' colour as selected. If 'WDMX Master' is selected in the separate DMX Mode menu the colour is transmitted to external Slave fixtures when this unit is operated in this STATIC mode. Any DMX input signal, if present, is ignored.
EFFECT	In this mode the fixture outputs pre-defined colour sequences, the speed of the sequence can be controlled. If 'WDMX Master' is selected in the separate DMX Mode menu the effect is transmitted to external Slave fixtures when this unit is operated in this EFFECT mode. Any DMX input signal, if present, is ignored.
DMX	In this mode the fixture is under control of Wireless-DMX *or cable input so may be controlled by a W-DMX compatible device or via a cable attached to the connector on the front of the unit. Note the choice of WDMX Slave or CableDMX Slave needs to be separately set in the DMX Mode menu (see below section for DMX Operation)

To change Function press . Use the  keys to select "CHANGE Function" and press  to accept.

Then use the  keys to select the required function as above and press .
The four modes of operation are discussed in more detail below.

CUSTOM Colour

When in Custom Colour mode the display indicates the current selected colour.

Simply press  to step through the colours or accept a colour value. Use  keys to change the value.

Value range 0 to 255.

Tip: Mix red & blue for purple/pink

Tip: Mix red & green for orange/yellow

Tip: Mix red & green with White for warm shades of white



FUNCTION CUSTOM
Set Col. Red: 255
Set Col. Grn: 000
Set Col. Blu:128
Set Col. Wh: 050

STATIC Operation

When in STATIC mode the display indicates the current selected colour.

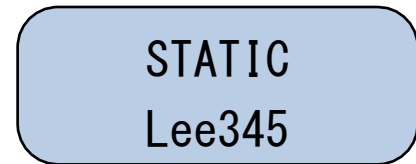
To change the current selected colour press .
The last character of the currently selected colour is underlined



Use the   keys to select a colour from the built-in library of 70 pre-programmed colours, including 60 popular LEE Filter Colours



The colour changes when cycling through the available options. The selected colour is only saved when <ENTER> is pressed. If <ENTER> is not pressed, the colour reverts to the previously selected colour after 8 seconds.



Available Colours

cc001	White	Lee075	Evening Blue	Lee157	Pink
cc002	Half Flesh Tone	Lee089	Moss Green	Lee159	No Colour Straw
cc003	Full Flesh Tone	Lee100	Spring Yellow	Lee162	Bastard Amber
cc004	Half Mint Green	Lee101	Yellow	Lee170	Deep Lavender
cc005	Mint Green	Lee102	Light Amber	Lee174	Dark Steel Blue
cc006	Half Ice Blue	Lee103	Straw	Lee181	Congo Blue
cc007	Full Ice Blue	Lee104	Deep Amber	Lee192	Flesh Pink
cc008	Soft Red	Lee106	Primary Red	Lee199	Regal Blue
cc009	Soft Green	Lee107	Light Rose	Lee323	Jade
cc010	Soft Blue	Lee108	English Rose	Lee341	Plum
		Lee113	Magenta	Lee345	Fuchsia
Lee002	Rose Pink	Lee115	Peacock Blue	Lee353	Lighter Blue
Lee009	Pale Amber Gold	Lee117	Steel Blue	Lee652	Urban Sodium
Lee010	Medium Yellow	Lee118	Light Blue	Lee722	Bray Blue
Lee013	Straw Tint	Lee119	Dark Blue	Lee724	Ocean Blue
Lee015	Deep Straw	Lee121	Lee Green	Lee738	Jazz Green
Lee017	Surprise Peach	Lee126	Mauve	Lee765	Lee Yellow
Lee019	Fire	Lee127	Smoky Pink	Lee776	Nectarine
Lee020	Medium Amber	Lee135	Deep Amber Gold	Lee777	Rust
Lee024	Scarlet	Lee136	Pale Lavender	Lee779	Bastard Pink
Lee026	Bright Red	Lee138	Pale Green	Lee789	Blood Red
Lee046	Dark Magenta	Lee139	Primary Green	Lee793	Vanity Fair
Lee058	Lavender	Lee147	Apricot	Lee795	Magical Magenta
Lee068	Sky Blue	Lee153	Pale Salmon		

EFFECT Mode

The ColourPoint is now equipped to generate a number of special effects as a stand-alone unit and will output these to a number of connected slave units when DMX is in Master Mode.

By pressing the  key the last used effect type is brought up, which can then be changed using the  keys.

By pressing the  key to confirm the effect type, the speed can be adjusted from a range 1 to 10 using the  keys. When confirmed with the  key the screen reverts to show the effect and speed.

Function
EFFECT

Type:
R'bow 1



EFFECT
R'bow 10

DMX Mode

When DMX mode is selected from the Function Menu the Colourpoint will operate as a DMX slave. The fixture will either follow the DMX data received wirelessly or via the cable connector on the front of the unit (the DMX input is selected in the “**Change DMX Mode**” menu).

Function
DMX

DMX Slave Operation

When in DMX Slave mode the display will show the current active DMX Start Address so the unit can be controlled from elsewhere. To change the address press the  button then the  keys to select the required starting address

The number of channels occupied depends on the “**5th DMX Channel**” setting (4 or 5 channels may be used by the fixture).

In Slave mode the fixture can transmit data received from the cable input; this is set up in the “**Change DMX Mode**” menu.

Set DMX
Addr: 001



DMX OPERATION

DMX Mode

The CORE ColourPoint can be configured to be DMX master or slave either using Wireless DMX (using the built-in Wireless Solution W-DMX wireless radio transmitter and receiver) or using cable DMX attached at the front of the unit. (Contact your dealer for details of interface cable accessories).

DMX control allows the fixture colour to be set up by or synchronized with sequences produced by a DMX lighting controller or other ColourPoint unit when in Receive, or SLAVE mode. Or with other CORE products having DMX or Wireless DMX Master outputs on board.

Alternatively when in MASTER mode the unit can be linked to many Slave units which will duplicate colour scenes or effects output from the fixture.

To select the DMX Mode press the  key to “Change FUNCTION” then  keys to select “Change DMX Mode”

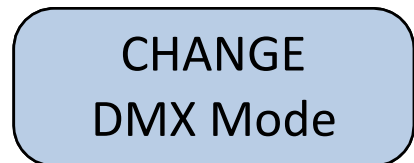

There are four modes of Operation, accessed through the **Change DMX Mode** menu;

WDMX Slave	The fixture will follow DMX data received over wireless DMX. Note that after enabling this setting DMX must be selected in the Function Menu for operation.
WDMX Master	In this mode the fixture outputs Wireless DMX data replicating the colour or effect that the unit is producing. DMX data is transmitted from both Wireless output and the DMX connector (any data present on the input cable is ignored). After enabling this setting the unit must be placed into EFFECT, CUSTOM or STATIC modes in the Function menu.
DMXCable Slave	The fixture will follow DMX data received through the connector on the front of the unit. Even if the wireless module is linked to a master the wireless DMX data will be ignored. Note that after enabling this setting DMX must be selected in the Function Menu for operation.
DMXCable to WDMX	In this mode the fixture receives DMX data through the DMX connector as a slave but the data is simultaneously output as wireless DMX. Note that after enabling this setting DMX must be selected in the Function Menu for operation.

W-DMX Pairing and Unpairing

ColourPoint units need to be manually paired with the lighting control unit equipped with a W-DMX transmitter. This could be a lighting desk with DMX Output, or a CORE Point15/20/30 Master unit with a W-DMX transmitter inside.

This allows a group of ColourPoint fixtures to be controlled from the lighting desk or Point15/20/30 Master using the built-in colour cycles (Inside Point15/20/30). Or set up individually selected colours across many units at once from just one Master unit.

W-DMX Link LED

The W-DMX link status is shown by the LINK LED, this provides information on the W-DMX link. This follows the same status indication as all Wireless Solution W-DMX products.



Description for operation in Slave mode:

OFF	If the LED is OFF the ColourPoint is not paired with a W-DMX transmitter
FLASHING	If the LED is FLASHING the ColourPoint is paired with a W-DMX transmitter, but the transmitter is switched off .
STEADY ON	If the LED is STEADILY ILLUMINATED the ColourPoint is paired with, and ready to receive data from a W-DMX transmitter. This is a fully paired and fully functioning system.
UNEVEN FLASHING	If the LED is FLASHING unevenly, the ColourPoint could be paired with a W-DMX transmitter, the transmitter is switched on, but no DMX Input to the transmitter . Alternatively, it could mean a fault condition on the W-DMX card inside the ColourPoint. See <i>*(1)</i> for rectification below.

**(1) – If uneven flashing of the WDMX LED occurs as a result of a fault condition (and not because the transmitter has no DMX signal input) then the internal WDMX card needs to be reset.*

a) Turn off the unit.

b) Simply hold down the WDMX button whilst switching ON the power button.

c) Release the WDMX button after a second and the WDMX internal card should be reset. The WDMX LED should now be extinguished.

Note this fault mode should not occur on units purchased since Oct 2014.

Unpairing from all W-DMX Transmitter units

- Switch on the ColourPoint.
- Press and hold the  button until the W-DMX LINK LED is turned OFF.
- ColourPoint is now **unpaired** from the W-DMX transmitter.

DMX Master Operation

Once Master mode is set, the Master may be linked to any number of unlinked slaves by pressing the Wireless  key momentarily. The adjacent link light will flash for a few seconds whilst it links to the unlinked slave units then go solid.

DMX
Master

DMX Slave Operation

Pairing with a W-DMX Transmitter unit or ColourPoint Master unit

- Switch on the ColourPoint.
- Ensure the ColourPoint is **unpaired** from any other transmitter (the LINK LED is OFF) – above.
- Ensure the transmitter is within range and switched on. Press its 'FUNCTION' button for more than 1s. On a ColourPoint Master unit simply hold down the  key momentarily.
- The transmitter will scan for all unlinked receivers for around 10 seconds; the LED will flash.
- If pairing is successful the LINK LED on the ColourPoint will illuminate.
- ALL Unlinked ColourPoint units (and other Unlinked W-DMX units too) may be linked at the same time. No apparent limit to the number being paired.
- For receiver units not to be paired with this transmitter, simply switch off those unwanted receivers before this pairing process. They may be paired with a different transmitter after switching on again and repeating the pairing process with the new transmitter.

Pairing with a CORE Point15, Point20 or Point30 Master unit

- Switch on the ColourPoint.
- Ensure the ColourPoint is **unpaired** from any other transmitter (the LINK LED is OFF) – above.
- Ensure the Master unit is within range and switched on.
- Select MODE MSTR → MSTR DMX → Add Unit → '+' to select 'YES' →  to confirm.
- The transmitter will scan for all unlinked receivers for around 10 seconds; the LINK LEDs flash.
- If pairing is successful the LINK LED on the ColourPoint will illuminate.
- ALL Unlinked ColourPoint units (and other Unlinked W-DMX units too) may be linked at the same time. No apparent limit to the number being paired.
- For receiver units not to be paired with this transmitter, simply switch off those unwanted receivers before this pairing process. They may be paired with a different transmitter after switching on again and repeating the pairing process with the new transmitter.

For successful linking the receiver must fulfill the following conditions:

Distance to transmitter (in free air)

- Less than 200m for Micro model transmitter
- Less than 500m for BlackBox or WhiteBox transmitter

Position above obstacles (e.g. crowds and trees)

- Minimum 1m



Pairing to a transmitter is remembered after power off or the battery is depleted.

This allows the system pairing to be set up in a warehouse and the whole system simply switched on at the site, which makes deployment very simple.



DMX Channels

The ColourPoint has 2 modes of operation.

From the **“CHANGE Settings”** menu select the **“5th DMX CHANNEL”** option as follows:

Mode	Chan	Function	Notes
5th CHAN Off	1	Red	This mode disables master dimmer and strobe functions. Each of the colour values may be set from 0 to 255. (In Master mode the Brightness setting will not control any slaves)
	2	Green	
	3	Blue	
	4	White	
5th CHAN M. Fader	1	Red	This mode enables the fixture's overall colour, set on channels 1 to 4, to be dimmed. Values are 0 to 255, where 255 represents 100% output. (In Master mode the Brightness setting will be transmitted on the 5 th channel)
	2	Green	
	3	Blue	
	4	White	
	5	Dimmer (0-100%)	

Additional Settings

Additional settings can be selected by pressing the  key to “Change FUNCTION” then 
 keys to select “CHANGE Settings”

There are four settings, accessed through the **Change Settings** menu;

5th DMX Channel	Selects whether a 5 th DMX channel is used for overall brightness (or master fader) control. When set the overall brightness is transmitted on channel 5 in master Mode. In Slave mode the overall brightness will be controlled by data on the 5 th channel
PWM Freq	The PWM rate can be set to prevent beating with a TV scan frequency.
Power Mode	Selects between Normal and Longlife mode. Output is set to 50% in long-life thereby doubling the battery duration
BRIGHTNS Control	The output brightness of the fixture is set between 0-100%.



Power Mode

Under the “**CHANGE Settings**” menu ColourPoint has two power modes that can be selected:

Power LongLife 50% Power
Power Normal Full Power

The “Normal” option provides maximum light output at the cost of reduced battery life. “LongLife” reduces the LED output by 50%, therefore enables 2 x running period for ALL FUNCTIONS, whether stand-alone or DMX.





To change the power mode press  and use the   keys to select “**CHANGE Settings**” then press . Use the   keys to select “**POWER MODE**” and press  to select.

Use   keys to toggle between “Norm” and “LongLife” then press  to save changes. This setting affects all Static, Cust Colr and DMX modes so that the battery life of each unit can be individually set, irrespective of what’s controlling it.



Brightness Control

Under the “**CHANGE Settings**” menu ColourPoint has a separate brightness control that can control the output of the unit in stand-alone mode:

The value may be changed from 0 to 100%.

Press  and use the   keys to select “**CHANGE Settings**” then press  to accept.

Use the   keys to select “**BRIGHTNS CONTROL**” and press  to select.

Use   keys to toggle between “0%” and “100%” then press  to save changes. This setting adjusts Static, Cust Col and Effect modes.

In 5 channel Slave DMX mode the brightness remains unchanged as the unit remains under external control.

PWM Frequency Control

For HD TV work ColourPoint is equipped with an option to adjust the PWM frequency of the LEDs to prevent ‘beating’ with the TV scan frequency.

To enable soft dimming press  and use the   keys to select “**CHANGE Settings**” then press  to select.

Then use the   keys to select “**PWM Freq**” and press  to select from value 488Hz to 3.9kHz.

Press  to save changes and the screen will revert to showing the ‘Function’ mode.



Beware that when using the higher frequencies the resolution of the colour intensity steps is reduced, so the effect of colour changing can become less smooth and more ‘steppy’. For optimum performance always select the lowest possible frequency of operation.

Keypad Lock

The keypad may be locked to prevent tampering or inadvertent adjustment of the unit.

To Lock: Hold down the  whilst switching ON the unit to Lock.

To Unlock: First switch OFF the unit. Hold down the  whilst switching ON the unit to Unlock.

Mechanical

Dimensions

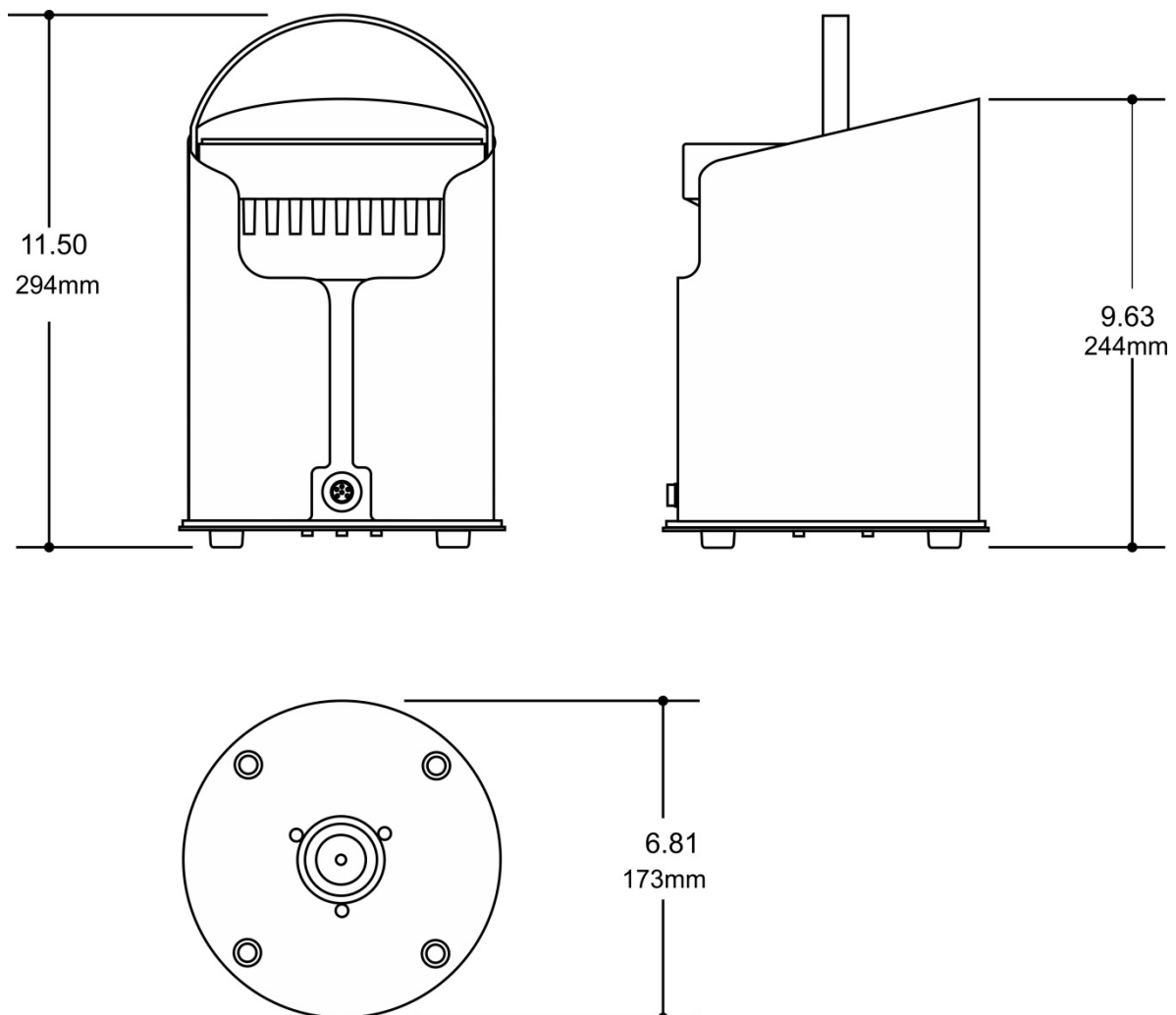

Antenna

The antenna is a high-gain type similar in performance to the Wireless Solutions W-DMX 2dB standard antenna according to testing. This antenna is now fitted to all CORE POINT units.

Locking

The unit may be locked to a nearby object by passing a locking wire or padlock through the locking holes in the bottom plate just below the connector socket, or through the handle.

A Kensington Lock point is also provided on the bridle assembly holding the head in place.

Warranty

CORE Lighting Limited (CORE Lighting) warrants this product to be free from defects in materials and workmanship (subject to the terms set forth below).

CORE Lighting will repair or replace (at CORE Lighting's option) this product or any defective parts in this product. The standard warranty period is 24 months from date of purchase, excluding battery pack which is 12 months, although this period may vary from country to country. If in doubt consult your dealer and ensure that you retain proof of purchase.

To obtain warranty service, please contact the CORE Lighting authorised dealer from which you purchased this product. If your dealer is not equipped to perform the repair of your CORE Lighting product, it can be returned directly to CORE Lighting, with carriage being paid at your own expense. You will need to ship this product in either its original packaging or packaging affording an equal degree of protection. Providing the product is found to be faulty, CORE Lighting will pay for return carriage.

Proof of purchase in the form of a bill of sale or receipted invoice, which is evidence that this product is within the warranty period, must be presented to obtain warranty service.

This Warranty is invalid if (a) the factory-applied serial number has been altered or removed from this product or (b) this product was not purchased from a CORE Lighting authorised dealer.

This Warranty does not cover cosmetic damage or damage due to acts of God, accident, misuse, abuse, negligence, commercial use, or modification of, or to any part of, the product. This Warranty does not cover damage due to improper operation, maintenance or installation, or attempted repair by anyone other than CORE Lighting or a CORE Lighting dealer, or authorised service agent which is authorised to do CORE Lighting warranty work. Any unauthorised repairs will void this Warranty. This Warranty does not cover products sold AS IS or WITH ALL FAULTS.

REPAIRS OR REPLACEMENTS AS PROVIDED UNDER THIS WARRANTY ARE THE EXCLUSIVE REMEDY OF THE CONSUMER. CORE LIGHTING SHALL NOT BE LIABLE FOR ANY INCIDENTAL OR CONSEQUENTIAL DAMAGES FOR BREACH OF ANY EXPRESS OR IMPLIED WARRANTY IN THIS PRODUCT. EXCEPT TO THE EXTENT PROHIBITED BY LAW, THIS WARRANTY IS EXCLUSIVE AND IN LIEU OF ALL OTHER EXPRESS AND IMPLIED WARRANTIES WHATSOEVER INCLUDING, BUT NOT LIMITED TO, THE WARRANTY OF MERCHANTABILITY AND FITNESS FOR A PRACTICAL PURPOSE.

Some countries and US states do not allow the exclusion or limitation of incidental or consequential damages or implied warranties so the above exclusions may not apply to you. This Warranty gives you specific legal rights, and you may have other statutory rights, which vary from state to state or country to country.

For any service, in or out of warranty, please contact your dealer.

Compliance Information

System Compliance

CORE Lighting Limited declares that this product conforms to the specifications listed in this manual, following the provisions of the European R&TTE directive 1999/5/EC:

Restrictions on Hazardous Substances (RoHS) (2002/95/CE)
Electromagnetic Compatibility (2004/108/EC).
Safety (EN 60950)
Technical requirements for radio equipment. (EN 300 328)



CAUTION—This equipment is intended to be used in all EU and EFTA countries.

Outdoor use may be restricted to certain frequencies and/or may require a license for operation. Contact local Authority for procedure to follow.

FCC & Industry Canada Statement for Radio Compliance W-DMX Transmitter & Receiver

We,

CORE Lighting Limited
Prindion House
Kingsmill Lane
Painswick
Gloucestershire GL6 6SA

declare under our sole responsibility that the product

FCC ID: UQT-WDMXOEMPCBF
Model: W-DMX OEM PCB F

complies with Part 15 of the FCC Rules.

Operation is subject to the following two conditions:

- (1) this device may not cause harmful interference, and
- (2) this device must accept any interference received, including interference that may cause undesired operation.

To assure continued compliance, any changes or modifications not expressly approved by the party responsible for compliance could void the user's authority to operate this equipment.

NOTE: This equipment has been tested and found to comply with the limits for a Class B digital device, pursuant to Part 15 of the FCC Rules. These limits are designed to provide reasonable protection against harmful interference in a residential installation.

This equipment generates, uses, and can radiate radio frequency energy and, if not installed and used in accordance with the instructions, may cause harmful interference to radio communications.

However, there is no guarantee that interference will not occur in a particular installation. If this equipment does cause harmful interference to radio or television reception, which can be determined by turning the equipment off and on, the user is encouraged to try and correct the interference by one or more of the following measures:

- Reorient or locate the receiving antenna.

- Increase the separation between the equipment and receiver.
- Connect the equipment into an outlet on a circuit different from that to which the receiver is connected.
- Consult the dealer or an experienced radio/TV technician for help.

RF Exposure Warning for North America, and Australia

Warning! To meet FCC and other national safety guidelines for RF exposure, **the antennas for this device must be installed to ensure a minimum separation distance of 20cm (7.9 in.) from persons.**

WEEE & RoHS Statement



The European Directive 2002/96/EC on Waste Electrical and Electronic Equipment (WEEE), requires that products must not be disposed of the normal unsorted municipal waste stream. Appliances must be collected separately in order to optimise the recovery and recycling of the materials they contain and reduce the impact on human health and the environment.

The consumer must contact their local authority or retailer for information concerning disposal of their products.

CORE Lighting provides a take-back facility for batteries used within CORE Lighting products, although the expense for transport remains the liability of the consumer. Please contact CORE Lighting directly if this service is required.