



DIGITAL USER MANUAL

# Shade Series™ Outdoor TV with Soundbar

TV SIZES 55-INCH, 65-INCH, 75-INCH

**MODEL NUMBERS**

SHD1-55  
SHD1-65  
SHD1-75

[WWW.SEURA.COM](http://WWW.SEURA.COM)

# Warnings



**WARNING:** Cancer and Reproductive Harm: [www.p65warnings.ca.gov](http://www.p65warnings.ca.gov).

## WARNING

Never place a display in an unstable location. A display set may fall, causing serious personal injury or death. Many injuries, particularly to children, can be avoided by taking simple precautions such as:

- Using cabinets or stands recommended by the manufacturer of the display.
- Only using furniture that can safely support the display.
- Ensuring the display is not overhanging the edge of the supporting furniture.
- Not placing the display on tall furniture (for example, cupboards or bookcases) without anchoring both the furniture and the display to a suitable support.
- Not placing the display on cloth or other materials that may be located between the display and supporting furniture.
- Educating children about the dangers of climbing on furniture to reach the display or its controls.

If your existing display is being retained and relocated, the same considerations as above should be applied.

## ATTENTION

*Ne placez jamais un téléviseur dans un endroit instable. Un téléviseur peut tomber et causer des blessures graves ou mortelles. Beaucoup de blessures, en particulier aux enfants, peuvent être évitées en prenant des précautions simples telles que:*

- *Utilisation des armoires ou des supports recommandés par le fabricant du téléviseur.*
- *Seulement en utilisant des meubles qui peuvent supporter en toute sécurité le téléviseur.*
- *Assurer le téléviseur est pas surplombant le bord du meuble de support.*
- *Non placer le téléviseur sur un grand meuble (par exemple, des armoires ou des bibliothèques) sans accrocher à la fois les meubles et le téléviseur sur un support approprié.*
- *Non placer le téléviseur sur le tissu ou d'autres matériaux qui peuvent être situés entre le téléviseur et le mobilier de soutien.*
- *Éduquer les enfants sur les dangers de grimper sur un meuble pour atteindre le téléviseur ou ses commandes.*

*Si votre téléviseur existant est conservé et transféré, les mêmes considérations que ci-dessus doivent être appliquées.*



## WARNINGS

A warning that an apparatus with class I construction shall be connected to a MAINS socket outlet with a protective earthing connection

### WARNING

To prevent injury, this apparatus must be securely attached to the floor/wall in accordance with the installation instructions.

Where the MAINS plug or an appliance coupler is used as the disconnect device, the disconnect device shall remain readily operable;

The apparatus shall not be exposed to dripping or splashing and no objects filled with liquids, such as vases, shall be placed on the apparatus.

To reduce the risk of fire or electric shock, do not expose the inside of this apparatus to rain or moisture. The inside of this apparatus shall not be exposed to dripping or splashing.

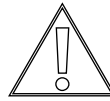

## AVERTISSEMENTS

*Un avertissement qu'un appareil de construction de CLASSE I doit être connecté à un socle du réseau d'alimentation muni d'une connexion à la terre de protection.*

### ATTENTION

*Pour éviter tout accident, cet appareil doit être fixé de façon sûre au sol ou au mur conformément aux instructions d'installation.*

*Lorsque la prise du RESEAU D'ALIMENTATION ou une prise placée sur l'appareil est utilisée comme dispositif de déconnexion, ce dispositif doit demeurer aisément accessible;*

*Le mode d'emploi doit stipuler que l'appareil ne doit pas être exposé à des égouttements d'eau ou des éclaboussures et de plus qu'aucun objet rempli de liquide tel que des vases ne doit être placé sur l'appareil.*

*Pour réduire le risque d'incendie ou de choc électrique, ne pas exposer l'intérieur de cet appareil à la pluie ou à l'humidité. L'intérieur de cet appareil ne doit pas être exposé à des gouttes ou des éclaboussures.*

# Important Safety Instructions

Apparatus shall not be exposed to dripping or splashing and no objects filled with liquids, such as vases, shall be placed on the apparatus.

**WARNING – TO PREVENT FIRE OR SHOCK HAZARD DO NOT EXPOSE THE SET TO RAIN OR MOISTURE.**

## IMPORTANT SAFETY INSTRUCTIONS

- 1) Read these instructions.
- 2) Keep these instructions.
- 3) Heed all warnings.
- 4) Follow all instructions.
- 5) Do not use this apparatus near water.
- 6) Clean only with a dry cloth.
- 7) Do not block any of the ventilation openings. Install in accordance with the manufacturer's instructions.
- 8) Do not install near any heat sources such as radiators, heat registers, stoves, or other apparatus (including amplifiers) that produce heat.
- 9) Do not defeat the safety purpose of the polarized or grounding type plug. A polarized plug has two blades with one wider than the other. A grounding type plug has two blades and a third grounding prong. The wide blade or the third prong is provided for your safety. When the provided plug does not fit into your outlet, consult an electrician for replacement of the obsolete outlet.
- 10) Protect the power cord from being walked on or pinched particularly at plugs, convenience receptacles, and the point where they exit from the apparatus.
- 11) Only use the attachments/accessories specified by the manufacturer.
- 12) Use only with a cart, stand, tripod, bracket, or table specified by the manufacturer, or sold with the apparatus. When a cart is used, use caution when moving the cart/apparatus combination to avoid injury from tip-over.
- 13) Unplug this apparatus during lightning storms or when unused for long periods of time.



- 14) Refer all servicing to qualified service personnel. Servicing is required when the apparatus has been damaged in any way, such as power supply cord or plug is damaged, liquid has been spilled or objects have fallen into the apparatus, the apparatus has been exposed to rain or moisture, does not operate normally, or has been dropped.
- 15) The apparatus shall not be exposed to dripping or splashing and that no objects filled with liquids, such as vases, shall be placed on the apparatus.
- 16) Shall be connected to a MAINS socket outlet with a protective earthing connection.
- 17) The disconnect device shall remain readily operable.
- 18) The socket-outlet shall be installed near the equipment and shall be easily accessible.

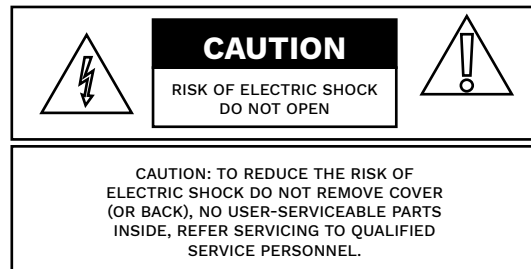

This symbol is intended to alert the user to the presence of uninsulated "dangerous voltage" within the product's enclosure that may be of sufficient magnitude to constitute a risk of electric shock to persons.



This symbol is intended to alert the user to the presence of important operating and maintenance (servicing) instructions in the literature accompanying the appliance.

*L'appareil ne doit pas être exposé à des gouttes ou des éclaboussures et aucun objet rempli de liquide, comme des vases, doit être placé sur l'appareil.*

**AVERTISSEMENT – POUR ÉVITER D'INCENDIE OU DE CHOC ÉLECTRIQUE NE PAS EXPOSER L'ENSEMBLE À LA PLUIE OU À L'HUMIDITÉ.**

## CONSIGNES DE SÉCURITÉ IMPORTANTES

- 1) Lisez ces instructions.
- 2) Conservez ces instructions.
- 3) Respectez tous les avertissements.
- 4) Suivez toutes les instructions.
- 5) Ne pas utiliser cet appareil près de l'eau.
- 6) Nettoyer uniquement avec un chiffon sec.
- 7) Ne pas bloquer les ouvertures de ventilation. Installez conformément aux instructions du fabricant.
- 8) Ne pas installer près de sources de chaleur telles que des radiateurs, registres de chaleur, poêles ou autres appareils (y compris les amplificateurs) qui produisent de la chaleur.
- 9) Ne pas contourner le dispositif de sécurité de la fiche polarisée ou mise à la terre. Une fiche polarisée possède deux lames dont une plus large que l'autre. Une prise de terre a deux lames et une troisième broche de mise à la terre. La lame large ou la troisième broche est fournie pour votre sécurité. Si la fiche fournie ne rentre pas dans votre prise, consultez un électricien pour remplacer la prise obsolète.
- 10) Protégez le cordon d'alimentation d'être piétiné ou pincé, en particulier au niveau des fiches, des prises de courant, et le point où ils sortent de l'appareil.
- 11) Utilisez uniquement les fixations / accessoires spécifiés par le fabricant.
- 12) Utilisez uniquement avec un chariot, un support, un trépied, un support ou une table spécifié par le fabricant ou vendu avec l'appareil. Quand un chariot est utilisé, faites attention lorsque vous déplacez l'ensemble chariot / appareil pour éviter les blessures en cas de chute.
- 13) Débranchez l'appareil en cas d'orage ou lorsqu'il est inutilisé pendant de longues périodes de temps.



*14) Les travaux de personnel qualifié. Une réparation est nécessaire lorsque l'appareil a été endommagé de quelque façon que ce cordon d'alimentation ou la fiche est endommagé, du liquide a été renversé ou des objets sont tombés dans l'appareil, l'appareil a été exposé à la pluie ou à l'humidité, ne fonctionne pas normalement, ou est tombé.*

*15) L'appareil ne doit pas être exposé à des gouttes ou des éclaboussures et aucun objet rempli de liquide, comme des vases, ne doit être placé sur l'appareil.*

*16) doit être relié à une prise secteur dotée d'une connexion de terre de protection.*

*17) Le dispositif de déconnexion doit rester facilement accessible.*

*18) La prise de courant doit être installée près de l'équipement et doit être facilement accessible.*



Ce symbole est destiné à alerter l'utilisateur de la présence d'une «tension dangereuse» non isolée à l'intérieur de l'enceinte du produit qui peut être d'une amplitude suffisante pour constituer un risque de choc électrique pour les personnes.



Ce symbole est destiné à alerter l'utilisateur de la présence d'instructions importantes d'utilisation et de maintenance (entretien) dans la documentation accompagnant l'appareil.

# FCC Warnings

Please keep this manual for future reference.

Information in this manual is subject to change without prior notice.



## **FCC Information**

This equipment has been tested and found to comply with limits for a class B digital device, pursuant to Part 15 of the FCC Rules. These limits are designed to provide reasonable protection against harmful interference in a residential installation.

This equipment generates, uses, and radiates radio frequency energy and, if not installed and used in accordance with the instructions, may cause harmful interference to radio communications.

There is no guarantee that interference will not occur in a particular installation. If this equipment causes unacceptable interference to radio and television reception, which can be determined by turning the equipment off and on, the user is encouraged to try to correct the interference by one or more of the following measures.

- Reorient or relocate the receiving antenna.
- Increase the separation between the equipment and receiver.
- Connect the equipment into an outlet on a circuit different from that to which the receiver is connected.

Consult the dealer or an experienced Radio/TV technician for additional help.

Change or modification not expressly approved by the party responsible for compliance could void the user's authority to operate the equipment.



## **WARNINGS**

To reduce the risk of fire, electrical shock and other injuries, keep these safety precautions in mind when installing, using, and maintaining your Outdoor Display. The socket-outlet should be installed near the equipment and be easily accessible. The display should be connected to a grounded GFCI protected main socket outlet.

**WARNING:** If you manipulate against the recommended usage, serious injury or death to user may result.

To protect against electric shock, do not immerse the power cord, power plug, or product in water or other liquid.

Do not overload AC outlets or extension cords. Overloading can cause fire or electric shock.

Close adult supervision is necessary when any product is used by or near children.

Do not operate any product with a damaged cord or plug or operate it after the appliance malfunctions or has been damaged in any manner.

Do not use the product close to any heat sources such as radiators, heat registers, stoves, or other products that produce heat.

Do not let the power cord come in contact with hot surfaces.

If you notice any smoke or scorched smell near the product, unplug power cord and refer to qualified personnel for service and/or repair.

Do not use or place any combustible or flammable substances near the product.

To electrically disconnect the product, turn OFF the product, then remove the electrical power plug from the outlet.

Do not place heavy articles on or step on the product.

Do not place the product on an unstable cart, stand, tripod or table.

Do not use this product for other than intended use.

This Séura product is intended for use indoors and outdoors.

This product is water resistant. Do not immerse this product in water.

For added safety during a lighting storm, or when this product is left unattended and unused for long periods of time, unplug it from the wall outlet and disconnect the antenna.

Specifications of this product are subject to unannounced changes; this manual may thus not reflect the current technical status.



*S'il vous plaît garder ce manuel pour référence future.*

*Les informations contenues dans ce manuel sont sujettes à modification sans préavis.*

### **Informations de la FCC**

*Cet équipement a été testé et déclaré conforme aux limites d'un appareil numérique de classe B, conformément à la partie 15 des règles de la FCC. Ces limites sont conçues pour fournir une protection raisonnable contre les interférences nuisibles dans une installation résidentielle.*

*Cet équipement génère, utilise et rayonne de l'énergie radiofréquence et, s'il n'est pas installé et utilisé conformément aux instructions, peut causer des interférences nuisibles aux communications radio.*

*Il n'y a aucune garantie que des interférences ne se produiront pas dans une installation particulière. Si cet équipement provoque des interférences inacceptables pour la radio et la télévision, ce qui peut être déterminé en mettant l'équipement hors tension, l'utilisateur est encouragé à essayer de corriger l'interférence par une ou plusieurs mesures suivantes.*

- Réorienter ou déplacer l'antenne de réception.
- Augmenter la distance entre l'équipement et le récepteur.
- Connecter l'équipement à une sortie sur un circuit différent de celui sur lequel le récepteur est branché.

*Consulter le revendeur ou un technicien radio / TV expérimenté pour de l'aide supplémentaire.*

*Tout changement ou modification non expressément approuvé par la partie responsable de la conformité peut annuler l'autorité de l'utilisateur à utiliser l'équipement.*



## **AVERTISSEMENTS**

*Pour réduire le risque d'incendie, de choc électrique et d'autres blessures, garder ces consignes de sécurité à l'esprit lors de l'installation, l'utilisation et l'entretien de votre télévision en plein air. La prise de courant doit être installée près de l'équipement et être facilement accessible. Le téléviseur doit être relié à une prise de courant avec terre protégé par disjoncteur différentiel.*

**ATTENTION:** *Si vous manipulez contre l'utilisation recommandée, des blessures graves ou la mort à l'utilisateur peuvent en résulter.*

*Pour protéger contre les chocs électriques, ne pas immerger le cordon d'alimentation, le cordon d'alimentation, ou un produit dans l'eau ou tout autre liquide.*

*Ne surchargez pas les prises de courant ou les rallonges. Une surcharge peut causer un incendie ou un choc électrique.*

*Surveillance d'un adulte est nécessaire lorsque tout appareil est utilisé par ou près des enfants.*

*Ne pas utiliser un produit avec un cordon ou une fiche détériorés fonctionner après un mauvais fonctionnement de l'appareil ou a été endommagé d'une manière quelconque.*

*Ne pas utiliser le produit à proximité de sources de chaleur telles que des radiateurs, registres de chaleur, poêles ou autres produits qui produisent de la chaleur.*

*Ne laissez pas le cordon d'alimentation entrer en contact avec des surfaces chaudes.*

*Si vous remarquez de la fumée ou une odeur brûlée près du produit, débranchez le cordon d'alimentation et de vous référer à un personnel qualifié pour l'entretien et / ou réparation.*

*Ne pas utiliser ou placer des matières combustibles ou inflammables à proximité du produit.*

*Pour débrancher électriquement le produit, éteignez le produit, puis retirez la fiche d'alimentation électrique de la prise.*

*Ne placez pas lourds articles ou étape sur le produit.*

*Ne pas placer le produit sur un chariot, un support, un trépied ou une table.*

*Ne pas utiliser ce produit pour d'autres fins que celles prévues.*

*Ce produit Séura est destiné à un usage intérieur et extérieur.*

*Ce produit est résistant à l'eau. Ne pas immerger le produit dans l'eau.*

*Pour plus de sécurité lors d'une tempête d'éclairage, ou quand le produit est laissé sans surveillance et inutilisé pendant de longues périodes de temps, débranchez-le de la prise murale et déconnectez l'antenne.*

*Spécifications de ce produit sont sujettes à modifications sans préavis; ce manuel ne peut donc pas tenir compte de l'état de la technique actuelle.*

# Warnings



## **WARNING: READ ALL INSTRUCTIONS BEFORE ATTEMPTING TO INSTALL OR SERVICE THIS PRODUCT.**

When installing and during use of this product, basic safety precautions should always be followed to reduce the risk of fire, electric shock and/or injury to persons including the following:

- Inspect the desired location for installation and be aware of all electrical wiring pathways, water pipes, gas lines, or other potentially hazardous conditions that may exist to protect from accidental damage during creation of on-site conditions.
- Ensure all required electrical specifications are adhered to and have been installed by the appropriate individuals and are code approved.
- Ensure all framing requirements, if needed, have been completed to building code and pose no structural issues.
- It is REQUIRED that this product is plugged into an electrical outlet protected by a Ground Fault Circuit Interrupter (GFCI) to protect against electric shock, fire, and/or injury. Failure to do so will void any warranty for this product.
- Only qualified individuals should attempt to service the product. Removing covers can expose you to high voltage and other dangerous conditions.
- To protect against electric shock, do not immerse the power cord, power plug, or product in water or other liquid.
- Do not overload AC outlets or extension cords. Overloading can cause fire or electric shock.
- Close adult supervision is necessary when any product is used by or near children.
- Do not operate any product with a damaged cord or plug or operate it after the appliance malfunctions or has been damaged in any manner.
- Do not let the power cord come in contact with hot surfaces.
- To electrically disconnect the product, turn OFF the product, then remove the electrical power plug from the outlet.
- Do not use this product for other than intended use.
- This Séura product is intended for use indoors and outdoors.
- This Séura product is water resistant. Do not immerse this product in water.
- Retain this manual in a safe place for future reference.



### **Warnings:**

Do not handle or remove your Outdoor Display from the packaging until it is ready to be installed.

To avoid damage to the Outdoor Display, only transport it in a vertical position.

It is highly recommended that at least two (2) persons assist in the installation of the Outdoor Display.



## **AVERTISSEMENT: LIRE TOUTES LES INSTRUCTIONS AVANT D'INSTALLER OU SERVICE CE PRODUIT.**

Lors de l'installation et pendant l'utilisation de ce produit, les précautions de sécurité de base doivent toujours être suivies pour réduire le risque d'incendie, de choc électrique et / ou de blessures, notamment les suivantes :

- Inspecter l'emplacement souhaité pour l'installation et être conscient de toutes les voies de câblage électrique, les canalisations d'eau, conduites de gaz, ou d'autres conditions potentiellement dangereuses qui peuvent exister pour protéger contre les dommages accidentels lors de la création des conditions sur place.
- S'assurer que toutes les spécifications électriques requises sont respectées et ont été installés par les personnes appropriées et sont le code approuvé.
- S'assurer que toutes les exigences d'encadrement, si nécessaire, ont été achevés au code du bâtiment et ne posent pas de problèmes structurels.
- Il est nécessaire que ce produit est branché sur une prise électrique protégée par un disjoncteur de fuite à la terre (GFCI) pour protéger contre les chocs électriques, des incendies et / ou blessures. Ne pas le faire annulera toute garantie pour ce produit.
- Seules les personnes qualifiées doivent tenter de réparer le produit. Le retrait des capots peut vous exposer à de hautes tensions et d'autres situations dangereuses.
- Pour protéger contre les chocs électriques, ne pas immerger le cordon d'alimentation, cordon d'alimentation, ou un produit dans l'eau ou tout autre liquide.
- Ne surchargez pas les prises de courant ou les rallonges. Une surcharge peut causer un incendie ou un choc électrique.
- Fermer surveillance d'un adulte est nécessaire lorsque tout appareil est utilisé par ou près des enfants.
- Ne pas utiliser un produit avec un cordon ou une fiche détériorés fonctionner après un mauvais fonctionnement de l'appareil ou a été endommagé d'une manière quelconque.
- Ne laissez pas le cordon d'alimentation entrer en contact avec des surfaces chaudes.
- Pour débrancher électriquement le produit, éteignez le produit, puis retirez la fiche d'alimentation électrique de la prise.
- Ne pas utiliser ce produit pour d'autres fins que celles prévues.
- Ce produit Séura est destiné à un usage intérieur et extérieur.
- Ce produit Séura est résistant à l'eau. Ne pas immerger le produit dans l'eau.
- Conservez ce manuel dans un endroit sûr pour référence ultérieure.



### **Avertissements:**

Ne pas manipuler ou supprimer votre téléviseur extérieure de l'emballage jusqu'à ce qu'il soit prêt à être installé.

Pour éviter d'endommager la télévision en plein air, seul le transporter dans une position verticale.

Il est fortement recommandé qu'au moins deux (2) personnes aident à l'installation de la télévision en plein air.

# Contents

## BEFORE USE

Before Installation .....	9
---------------------------	---

## INSTALLATION AND SETUP

Setup.....	10
Remote Functions .....	10
Service Buttons .....	10
Connections.....	11

## MENUS AND SETTINGS

On Screen Display Menu (OSD).....	12
Troubleshooting.....	16
Control and Integration .....	17

## TECHNICAL DETAILS

Technical Specifications.....	18
Product Limited Warranty .....	19



### **IMPORTANT**

---

The display should not be installed directly over a flat surface if heavy or driving rain may puddle and splash up onto the lower portion of the display.

Direct sunlight on the display screen will heat internal components and should be avoided.

### **IMPORTANT**

---

*Le téléviseur ne doit pas être installé directement sur une surface plane, si de fortes pluies ou de conduite peut flaquer d'eau et éclabousser sur la partie inférieure du téléviseur.*

*Lumière directe du soleil sur l'écran du téléviseur va chauffer les composants internes et devrait être évitée.*



## The screen is most optimally viewed at ambient temperatures of 32°F to 104°F

### Operation and Storage Requirements

The maximum ambient temperature range for operating the device is **-24°F to 104°F\***. The screen is most optimally viewed at ambient temperatures of **32°F to 104°F**. Do not install the device in the proximity of heat sources, such as heating pipes, heaters, furnaces or other devices that radiate heat. Mount the device in such a way that it is protected against moisture. To prevent fire or electric shock, never allow liquids to enter the unit. The uninstalled product must be stored in dry and well-ventilated rooms, without extreme temperature fluctuations. Heat sources and aggressive active substances may not be stored in the proximity of the device. The required storage temperature is **-24°F to 140°F**. The device must be stored in the complete packaging, as delivered.

### Installation

Easy to use standard mounting systems are available and can be specified or recommended by Séura. Install the product in a way that it is fixed properly and take care that children are not exposed to danger. Please take extra care during installation, avoid impacts. Before cabling your monitor, check that the power is off. To avoid any possibility of electric shock, always connect your equipment to properly grounded outlets. Use of power cords or adapters other than those provided may cause fire or malfunction. Place this product as close to the power socket as possible. Leave enough space to insert and remove the power plug on demand. Even if you power off the product with your remote control, power is still present unless the power cord is unplugged. The device may only be operated with the provided power adapter. The rated voltage is indicated on the product label. The device is factory-set to the optimal operating voltage (see Technical Specification). Use only power cords and plugs that are suitable for your local electrical outlets. Do not install the power cord in a way that could obstruct a walkway. Ensure furthermore that the cable is not clamped and that it cannot be pulled out accidentally from the power adapter. Do not install the power cords in the proximity of heating elements and never place heavy items on the cable or power adapter. Do not modify or repair the power cords.

\*When the unit is used in temperatures below the ideal operating temperature range, the picture may appear slightly delayed or blurred. This is normal, and the picture will return to normal after the temperature increases to the ideal operating temperature range.

### CAUTION

Do not use any power cords or adapters other than those provided with this product! Use of power cords or adapters other than those provided with this product may cause fire, electric shock or malfunction. The individual components can be destroyed if the polarity is reversed or an incorrect connection is used. A goodwill replacement is not possible in such cases, since each device is submitted to meticulous quality inspections prior to shipping. The connecting plugs must be attached in such a way that the connector is held firmly. Have trained technical personnel install the electrical facilities necessary for mounting. Connect the power cord to a grounded GFCI (ground fault circuit interrupter) protected outlet. Never cut or damage the power cord.

Please disconnect the device from the power outlet in the following cases:

1. The device is out of use for a lengthy period.
2. The device malfunctions or displays other unusual features, necessitating maintenance work.
3. During a thunderstorm.

Please plan the positioning of the power outlet and the source cables before proceeding with the structural measures and positioning of the Séura Outdoor Display.

### AVERTISSEMENT

*N'utilisez pas de cordons d'alimentation ou des adaptateurs autres que ceux fournis avec ce produit! L'utilisation de cordons d'alimentation ou des adaptateurs autres que ceux fournis avec ce produit peut causer un incendie, un choc électrique ou un dysfonctionnement. Les composants individuels peuvent être détruits si la polarité est inversée ou une connexion incorrecte est utilisée. Un remplacement de l'écart d'acquisition n'est pas possible dans ce cas, étant donné que chaque appareil est soumis à des contrôles de qualité minutieux avant l'expédition. Les prises de raccordement doivent être fixées de manière à ce que le connecteur est fermement maintenu. Personnel technique ont été formés installent les installations électriques nécessaires pour le montage. Branchez le cordon d'alimentation à une fuite à la terre à la terre (ground fault circuit de coupure) de prise protégée. Ne jamais couper ou endommager le cordon d'alimentation.*

*S'il vous plaît débrancher l'appareil de la prise de courant dans les cas suivants:*

1. L'appareil est hors d'usage pendant une longue période.
2. Les dysfonctionnements de l'appareil ou d'autres caractéristiques inhabituelles affiche, nécessitant des travaux d'entretien.
3. Lors d'un orage.

*S'il vous plaît planifier le positionnement de la prise de courant et les câbles de la source avant de procéder à des mesures structurelles et le positionnement de la Télévision Séura extérieure.*

### NOTE

Make sure the power source circuits are properly grounded. Use the supplied power cord in order to connect it to the power source. If your installation requires a different power cord, be sure to use an officially approved power cord displaying the mark of the safety agency that defines the regulations for power cords in your country. Please consider that the AC outlet for the power adapter is placed within reach of the Séura Outdoor Display and should be easily accessible in case it needs to be powered off.

Install the unit in an environment where the operating ambient temperature will not exceed 60°C / 124°F. Ensure that your installation complies with your national and local safety rules. Any servicing, adjustment, maintenance or repair must be performed only by service-trained personnel.

Ensure the power outlet is installed in an accessible location, to access it easily in case of a defect.

# Setup

## Meet Séura® Shade Series™ Outdoor TV

Before using the device, please check the following contents of the box for completeness:



50W Outdoor Soundbar



Power Cable



Right Angle Coax Adapter

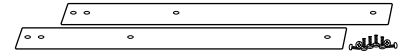

Soundbar Mounting Brackets and 8 Stainless Steel Screws



IR Remote Control with (2) AAA Batteries

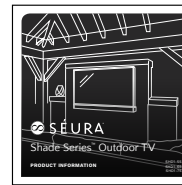
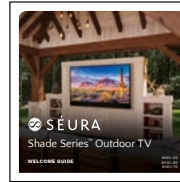

Welcome Guide and Product Information

## Remote Functions

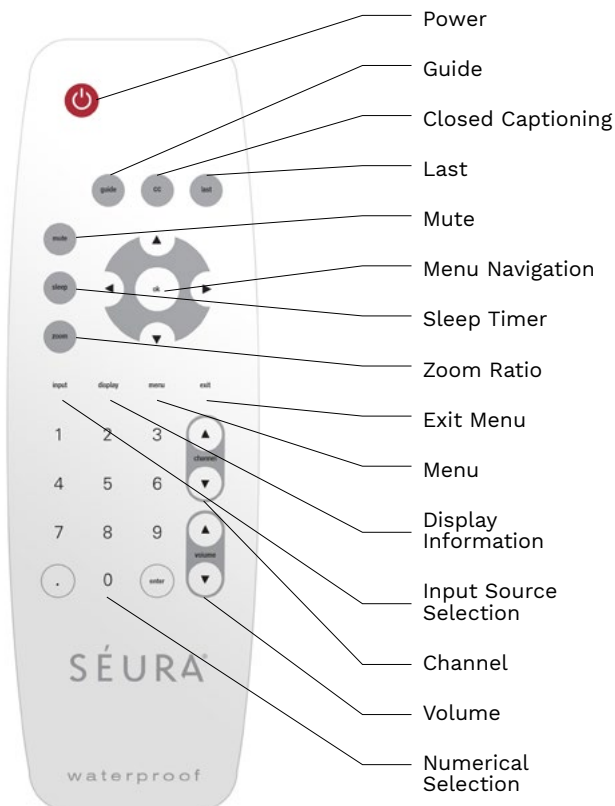

## Service Buttons

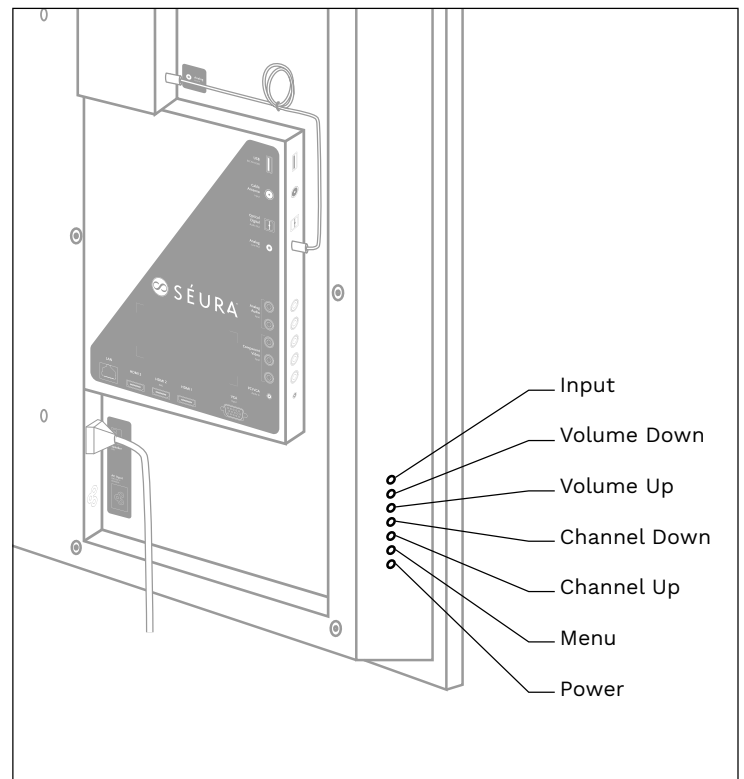

## Connections

Remove the weatherproof media compartment cover to access all connections. To connect a source such as a streaming device or cable box, connect one end of an HDMI cable (or other, cables not included) into an HDMI port on the TV and the other end into your device.

**TIP:** Ensure your media source is located in a dry location. Housing the device inside the media compartment is not recommended.

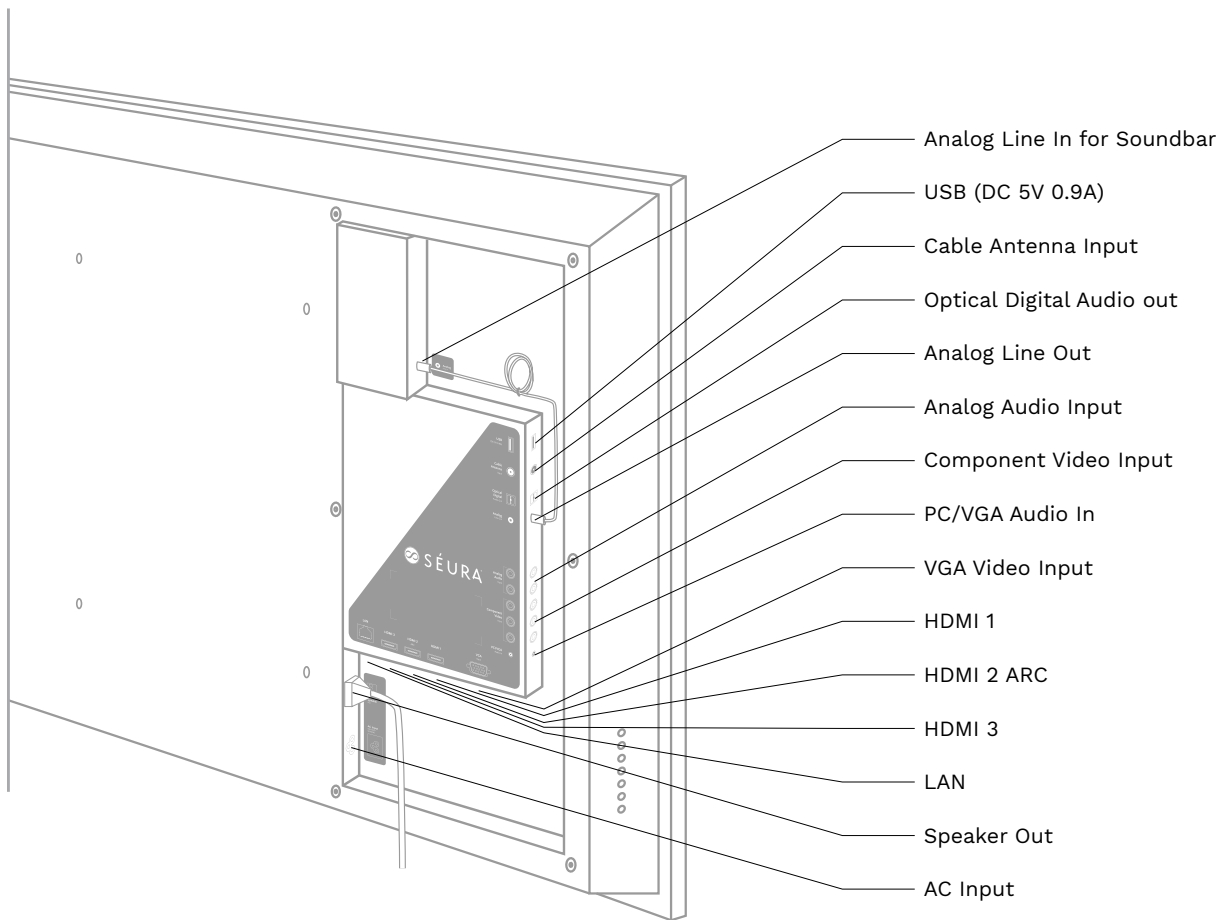

**TIP:** For connections along the right side, right angle connection adapters are recommended to prevent cords from bending within the cabinet.

# On Screen Display Menu (OSD)

## On Screen Display Menu (OSD)

In the on screen display menu (OSD) you can adapt the characteristics of your display based on personal preferences.

Using the remote:	Using the service buttons:
<ol style="list-style-type: none"> <li>1. Press <b>MENU</b> on your remote control to open the OSD menu</li> <li>2. Navigate within the OSD with the left/right and up/down arrows</li> <li>3. Change settings with the left/right or up/down arrows</li> <li>4. Go back one step with <b>MENU</b></li> <li>5. Confirm selection with the <b>OK</b> button</li> <li>6. Press to <b>EXIT</b> the OSD menu.</li> </ol>	<ol style="list-style-type: none"> <li>1. Press <b>MENU</b> on the control panel. The service buttons are located on the left side of the TV.</li> <li>2. Navigate within the OSD and change setting values by pressing Volume Down/Up and Channel Down/Up on the service buttons.</li> </ol>

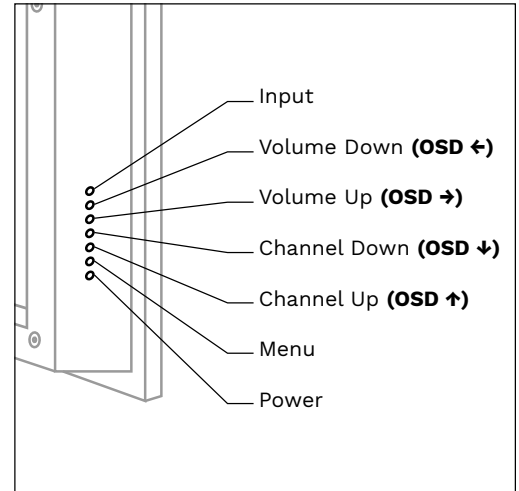

## Adjusting the Input

Using the remote:	Using the service buttons:
<ol style="list-style-type: none"> <li>1. Press <b>INPUT</b> to display the Input Source list</li> <li>2. Press the up or down arrows until the desired Input Source is highlighted.</li> <li>3. Press <b>OK</b> to confirm selection of the chosen input.</li> <li>4. Press to close the Input Source list without selecting an alternative source</li> </ol> <p>OR</p> <p>If available, use the quick input controls on the remote to directly designate the input source.</p>	<ol style="list-style-type: none"> <li>1. Touch <b>INPUT</b> on the control panel. The control panel is located on the right side of the display.</li> <li>2. To toggle input selection, repeatedly press <b>INPUT</b>.</li> <li>3. To confirm selection</li> </ol>

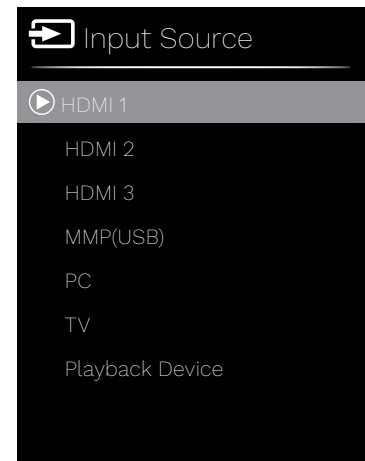

# On Screen Display Menu (OSD)

## OSD Menu Hierarchy

To access the menu, press **MENU** on your remote. The carousel of submenus are represented by the four indicator dots at the top of the menu. To scroll through the submenus, press left/right on your remote. The order of submenus is Audio, Picture, Link and System.

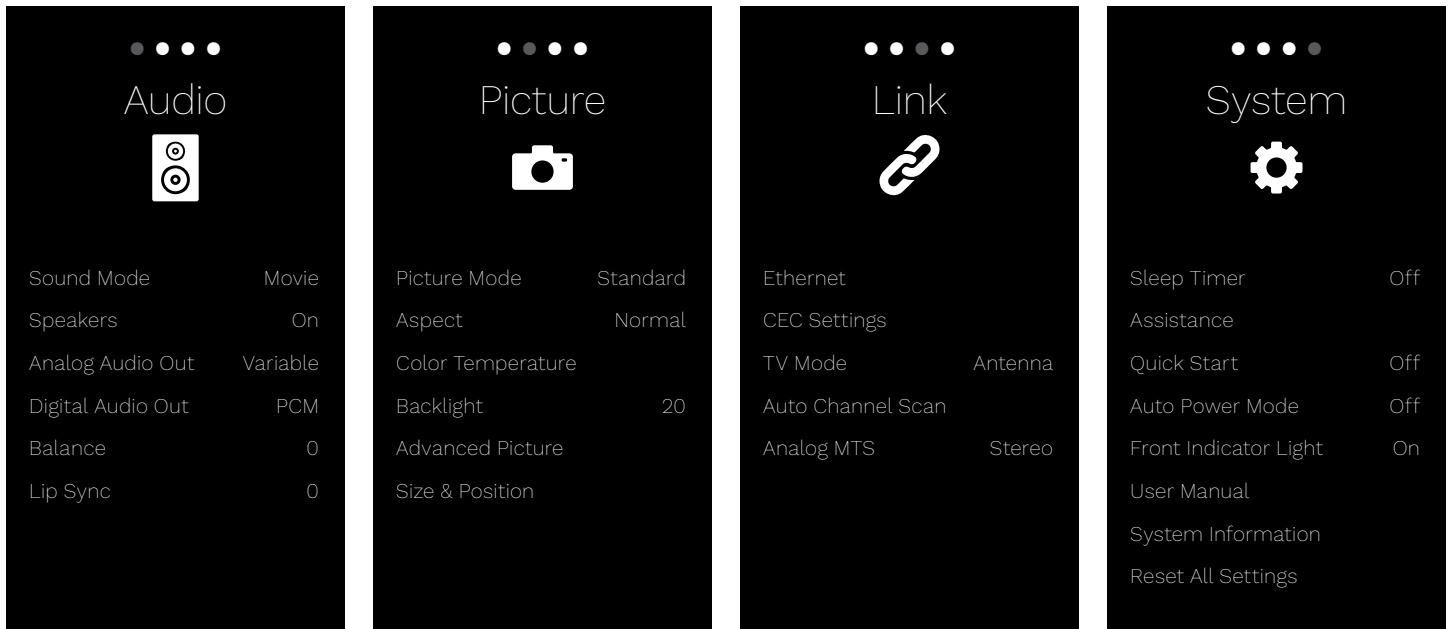

## Audio

Adjust the audio output settings.

Adjustment options include:

### Sound Mode

### Speakers

### Analog Audio Out

### Digital Audio Out

### Balance

### Lip Sync

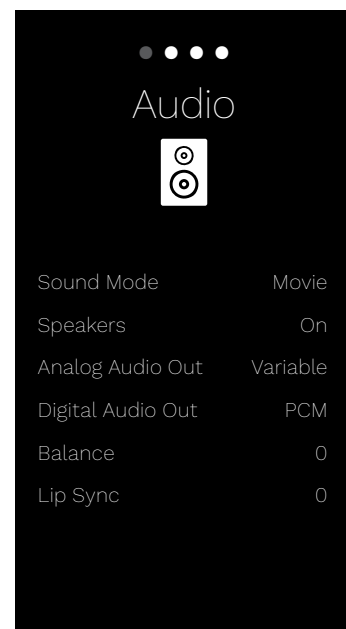

# On Screen Display Menu (OSD)

## Picture

The Picture menu offers options to enhance and refine the image characteristics of your Séura Outdoor Display.

Adjustment options include:

### Picture Mode<sup>1</sup>

### Aspect

### Color Temperature

### Backlight

### Advanced Picture<sup>1,2</sup>

#### Contrast

#### Brightness

#### Color

#### Tint

#### Sharpness

#### Motion Enhancer

#### Color Enhancement

#### Dynamic Contrast

#### Noise Reduction

#### Local Dimming

#### Low Latency

#### Gamma Adjustment

#### Film Mode

#### C.M.S. Hue

#### C.M.S. Saturation

#### C.M.S. Value

#### 10 Point Setting

### Size & Position<sup>1,3</sup>

#### Horiz. Position

#### Vertical Position

#### Horizontal Size

#### Vertical Size

1. Not available on USB input

2. Not available on PC input

3. Not available on TV input

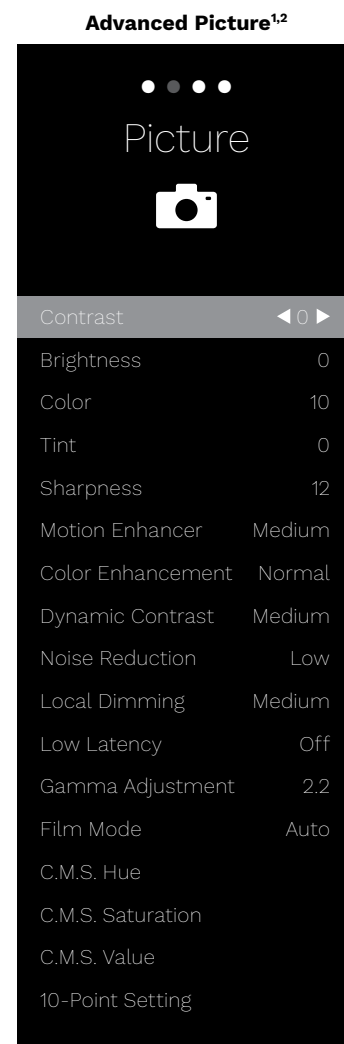
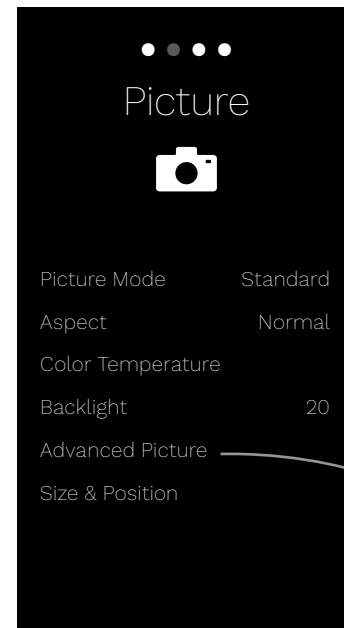

# On Screen Display Menu (OSD)

## Link

The link menu contains configuration settings for IP control and video link.

Adjustment options include:

### Ethernet<sup>1</sup>

#### Type

#### Proxy Settings

#### Connect

### CEC Settings

#### CEC Function Enable

#### System Audio Control

#### Auto Power On

#### Auto Power Off

### HDMI<sup>2</sup>

### TV Mode<sup>3</sup>

### Auto Channel Scan<sup>3</sup>

### Analog MTS<sup>3</sup>

1. Not available on USB input

2. Only on HDMI input

3. Only on TV input

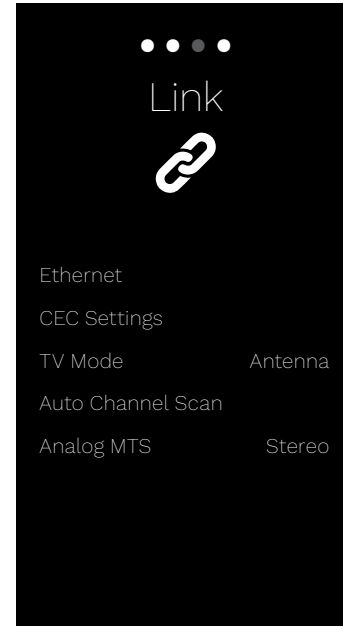

## System<sup>1</sup>

The system menu contains configuration settings for general TV use.

Adjustment options include:

### Sleep Timer

### Parental Controls<sup>2</sup>

### Closed Caption<sup>2</sup>

### Assistance

### Quick Start

### Auto Power Mode

### Front Indicator Light

### User Manual

### System Information

### Reset All Settings

1. Not available on USB input

2. Only available on TV input

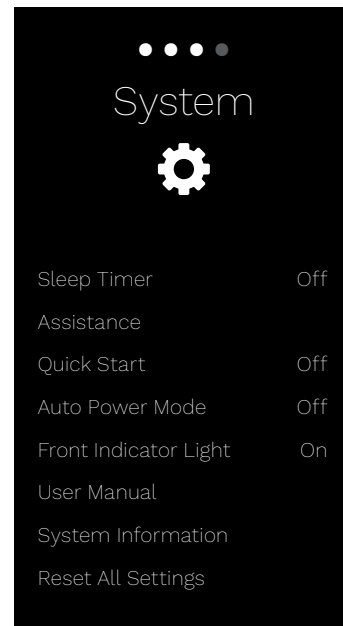

# Troubleshooting

If the product is not working properly, please check the following troubleshooting solutions before you contact customer service:

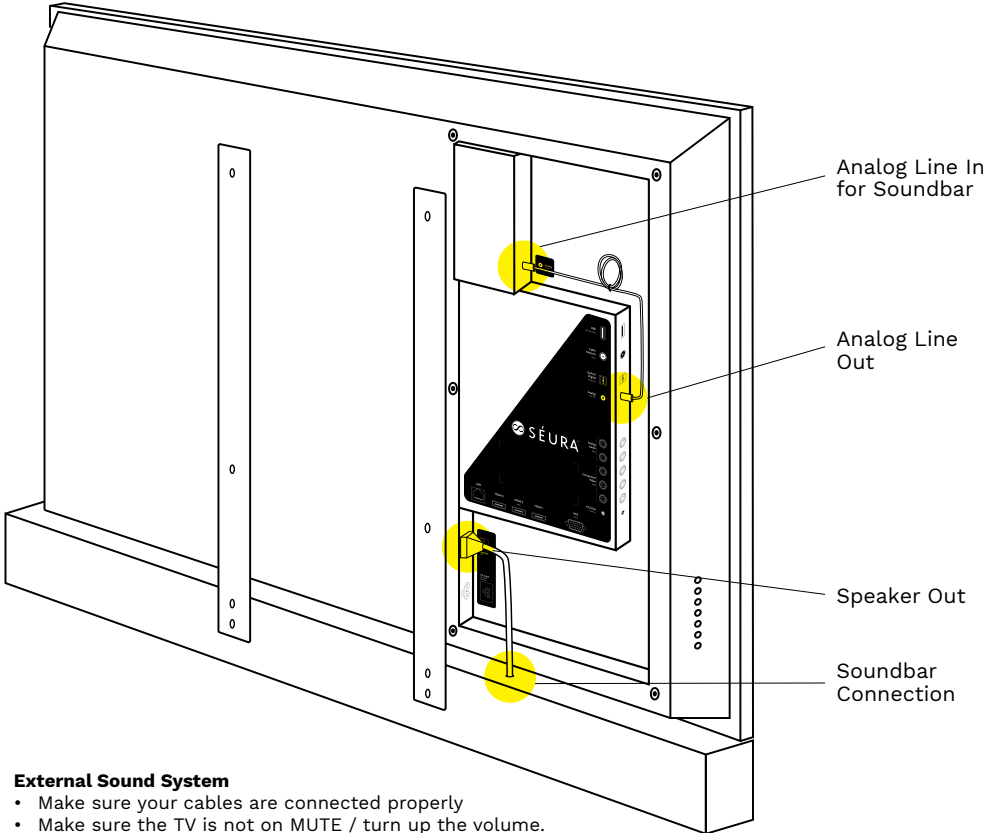
Challenge	Possible Solution
<p><b>Will Not Power Up</b></p>	<ul style="list-style-type: none"> <li>• Make sure to check that the AC power cable is connected to an outlet and the TV</li> <li>• Make sure that the power outlet is receiving power</li> <li>• Try pressing <b>POWER</b> button on the TV to make sure the problem is not the remote.</li> </ul> <p>If the TV turns on, refer to 'Remote control does not work' troubleshooting guide.</p>
<p><b>Remote Control Not Working</b></p>	<ul style="list-style-type: none"> <li>• Make sure that there is known working batteries in the remote and in the correct polarity</li> <li>• Make sure there are no obstacles in between the IR receiver and the remote (ex. sunlight or tape)</li> <li>• Try pointing the remote directly at the TV from 5 feet away.</li> </ul>
<p><b>Signal Issue</b></p>	<ul style="list-style-type: none"> <li>• Check cable connections to ensure they are connected.</li> <li>• Plug the video source directly into the display which will remove any potential issues associated with an extender or matrix switch device. (if applicable)</li> <li>• Replace cables with known working cables.</li> <li>• Make sure the connected devices are powered ON.</li> <li>• Make sure that the TV's source is on the correct <b>INPUT</b>.</li> <li>• Power cycle the video source device by unplugging the device and plugging the device back in.</li> </ul>
<p><b>No Sound</b></p>	<p><b>Soundbar</b></p> <ul style="list-style-type: none"> <li>• Make sure your cables are connected properly</li> <li>• Make sure the TV is not on <b>MUTE</b> / turn up the volume.</li> <li>• Make sure the 3.5mm cable is plugged into the AMP (see diagram)</li> <li>• Make sure the soundbar is plugged into the TV</li> </ul>  <p><b>External Sound System</b></p> <ul style="list-style-type: none"> <li>• Make sure your cables are connected properly</li> <li>• Make sure the TV is not on MUTE / turn up the volume.</li> <li>• Make sure the Digital Audio Settings within the TV is not set to <b>OFF</b></li> <li>• Test the external sound system with another device to ensure that it is working.</li> </ul>

For additional technical support, please contact Séura at **1-800-957-3872** during regular business hours: M-F 8:00 am - 4:30 pm, Central Time.



**For complete control documentation, please visit [www.seura.com/download-center](http://www.seura.com/download-center)**

For additional technical support, please contact Séura at **1-800-957-3872** during regular business hours:  
M-F 8:00 am - 4:30 pm, Central Time.

# Technical Specifications

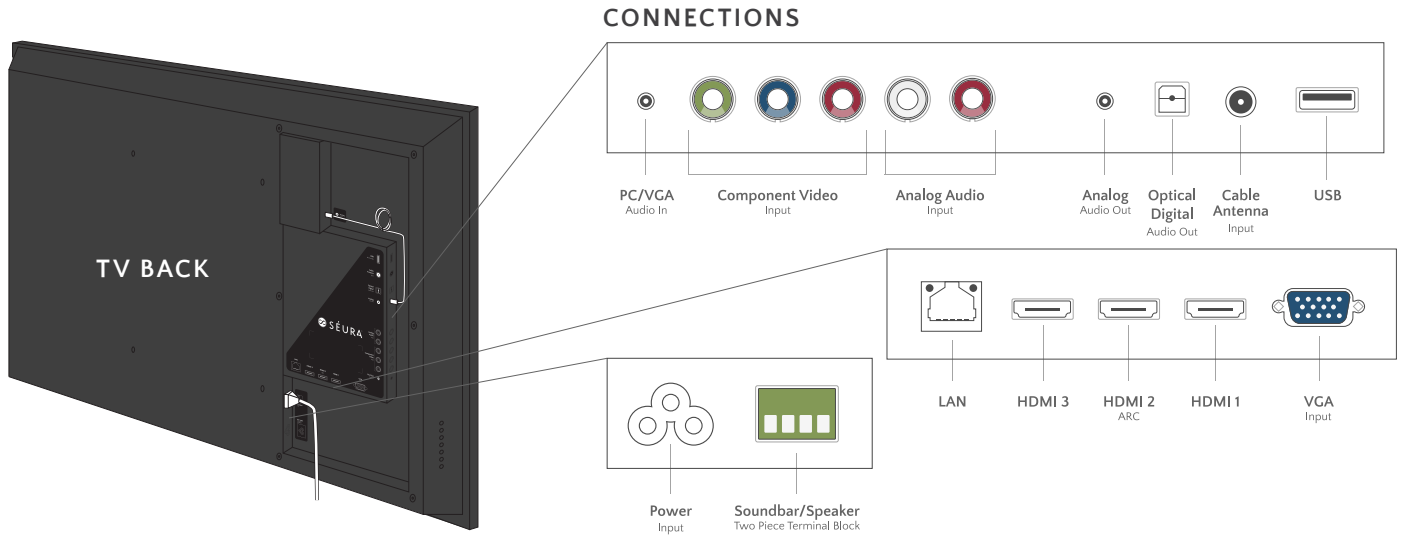

**55 INCH 4K UHD**  
Model: SHD1-55

**65 INCH 4K UHD**  
Model: SHD1-65

**75 INCH 4K UHD**  
Model: SHD1-75

	55 INCH 4K UHD Model: SHD1-55	65 INCH 4K UHD Model: SHD1-65	75 INCH 4K UHD Model: SHD1-75	
<b>GENERAL</b>	OPERATING TEMPERATURE RANGE	-24°F to 104°F*		
	IDEAL OPERATING TEMPERATURE	32°F to 104°F		
	NON-OPERATING TEMPERATURE	-24°F to 140°F		
	OPERATING HUMIDITY RANGE	20–80% RH, non-condensing		
	WATERPROOF RATING	IP54 Rating†		
	ISOTROPIC BLACKOUT PREVENTION	Yes		
<b>VIDEO</b>	DISPLAY RESOLUTION	3840 x 2160		
	DISPLAY BRIGHTNESS	450 cd/m2		
	ASPECT RATIO	16:9		
	CONTRAST RATIO	Typical 4000:1		
	LOCAL DIMMING	Yes		
	TUNER	Yes		
	HDMI	3		
	COMPONENT YPbPr	1		
	USB	1		
	HDR COMPATIBLE	HDR10		
	RESPONSE TIME	8 ms	8 ms	8 ms
	VIEWING ANGLE	178° Horizontal/Vertical	178° Horizontal/Vertical	178° Horizontal/Vertical
POWER CONSUMPTION, DISPLAY	125W	205W	266W	
POWER CONSUMPTION, AC OUTLET	Max 200W			
<b>AUDIO</b>	INCLUDED SPEAKERS	50w 2-Channel Soundbar		
	AUDIO: COMPONENT AUDIO INPUT	RCA x2		
	AUDIO: PC AUDIO INPUT	Stereo 3.5mm		
	AUDIO: OPTICAL DIGITAL OUT	1		
	AUDIO: ANALOG LINE OUT	Stereo 3.5mm (pre-wired to Analog Line in for Soundbar)		
	AUDIO: ANALOG LINE IN	Stereo 3.5mm (pre-wired to Analog Line Out for Soundbar)		
	AUDIO: SPEAKER LEVEL OUT	Two Piece Phoenix Type Terminal Block (to Soundbar)		
<b>INSTALLATION</b>	TV DIMENSIONS	48.9" w x 28.4" h x 3.4" d	57.75" w x 33.5" h x 3.4" d	Coming Soon
	TV WITH SOUNDBAR DIMENSIONS	48.9" w x 33.1" h x 3.4" d	57.75" w x 38.2" h x 3.4" d	Coming Soon
	TV WEIGHT	44 lbs.	61 lbs.	Coming Soon
	TV WITH SOUNDBAR WEIGHT	70 lbs.	74 lbs.	Coming Soon
	COMPARTMENT DIMENSIONS	11" w x 21" h x 1.3" d		
	VESA PATTERN	400 x 400mm		
<b>OTHER</b>	LAN	1 (IP Control)		
	CERTIFICATIONS AND COMPLIANCE	FCC		
	WARRANTY	Séura warrants Outdoor Displays with respect to Séura's labor, structure, assembly, display including remote, and power supply for two (2) years.		
	REMOTE	Séura Water Resistant IR Remote Control		

\* The screen is most optimally viewed at ambient temperatures of 32°F to 104°F

† IP Rating is an international standard that specifies the degree of protection against dust and water ingress. Séura Outdoor TVs are IP rated and designed to protect against rain, snow, ice, dust, and other outdoor elements.

The standard limited warranty policies of Séura, Inc. ("Séura") shall apply to all equipment or other goods ("Products") at the time of sale to any authorized Séura distributor and/or product reseller. These warranty policies may be modified by Séura from time to time. Copies of the standard limited warranties then in effect for a particular Product will be made available upon request and are also available on the Séura website at <https://www.seura.com/warranty/>. This warranty is valid only with respect to Product sales in the U.S. and Canada.

If any Product fails to work or operate properly because of a defect in materials or workmanship, Séura will, if notified of such defect within the applicable warranty period indicated below, at its option, either: (a) repair the Product with new or refurbished parts onsite or at Séura's factory, including Séura's labor if applicable; or (b) replace the Product with a new or refurbished Product; or (c) if repair or replacement is not commercially feasible, refund an amount equal to a pro rata share of the current MSRP (as determined by the remainder of the warranty period). The remedy chosen will be in good faith and at the discretion of Séura. In no event will Séura be responsible for any costs related to installation and/or removal of Product.

Séura warrants its Products as set forth below, which warranty periods shall start and run from the date of Séura's sale of the Product:

- **Lighted Mirrors** (excluding Select Lighted Mirrors) with respect to Séura's labor, glass, structure, and assembly for seven (7) years; electrical and LED light strips for five (5) years. Mirror technology with respect to Séura's labor and parts including wireless music technology, clocks, nightlights, defoggers, dimmers, and voice technology are covered for two (2) years.
- **Select Lighted Mirrors** with respect to Séura's labor, glass, structure, and assembly for one (1) year; electrical and LED light strips for three (3) years.
- **SMART Mirrors** with respect to Séura's labor, glass, structure, and assembly for three (3) years; display including remote, power supply and SMART Technology for one (1) year.
- **TV Mirrors** with respect to Séura's labor, glass, structure, and assembly for three (3) years; TV including remote and power supply for two (2) years.
- **Lighted TV Mirrors** with respect to Séura's labor, glass, structure, and assembly for three (3) years; electrical and LED light strips for five (5) years. TV including remote and power supply for two (2) years.
- **Indoor Waterproof TVs** with respect to Séura's labor, glass, structure, and assembly for three (3) years; TV including remote and power supply for two (2) years.
- **Outdoor Displays** with respect to Séura's labor, structure, assembly, display including remote, and power supply for two (2) years.
- **Indoor and Outdoor Mounts** for two (2) years against defects in original hardware and/or workmanship. Excludes corrosion or rust resulting from damaged, scratched or chipped paint or other surfaces.
- **Outdoor Soundbars** with respect to labor and parts for one (1) year.
- **Protective Display Covers** for two (2) years against material and/or workmanship defects.
- **Decorative Frames** for one (1) year.

**Exceptions to Warranty:** This warranty is valid only with respect to Product sales in the U.S. and Canada. Séura does not warrant Products against defects arising out of, related to, or caused by, whether totally or partially, and whether directly or indirectly, any of the following:

- A. Failing to properly clean and maintain, any Product, part or component of a Product, including, but not limited to, filters, front bezel, and other Product areas or components;
- B. A Product's extended use, including particularly, commercial applications, where a Product is operating on average more than twelve (12) hours per day on a permanent or extended periodic basis;
- C. Circumstances, damage (including concealed damage) or other conditions occurring during shipment of a Product or at any time after a Product leaves Séura's facility (including without limitation transport of the Product to or from Séura before or after authorized service). Products must be packed properly using original packaging or Séura replacement or pre-authorized packaging. Customer assumes all risk, and costs, including transportation costs, while Product is in transit to or from Séura;
- D. Circumstances, damage or other conditions occurring during unpacking and/or removal of a Product from its original packaging, including the removal of protective material;
- E. Improper, incorrect, or insufficient AC supply voltage to a Product;
- F. Alterations, modifications, including use of unauthorized mount, or changes to a Product without Séura's prior written authorization;
- G. The incorporation of a Product into or within a product of a third party, without Séura's prior written authorization;
- H. A Product's misuse, neglect use, abuse, or improper operation, including the failure to follow a Product's normal and ordinary operating instructions;
- I. The effects of fire, flood, lightning, electrical surges, water and other liquid infiltration, smoke, insect or animal infestation, sand, mud, chemicals, improper cleaning agents and other substances not intended to come into contact with a Product, including any such substances contact with a Product as the result of acts of God;
- J. The improper or faulty installation, setup, or adjustment of a Product;
- K. A Product's repair, attempted repair, or total or partial disassembly by any party other than a Séura authorized service representative;
- L. When the Product occurs with pixel errors within the specified and permitted area. (For more information about this, inquire directly with Séura regarding the Séura Pixel Policy.)
- M. Corrosion that does not affect the performance of a Product or the reasonable cosmetic appearance of a Product (including without limitation, scratches or other paint or finish damage to a Product that lead to or are caused by, in part or in total, corrosion);
- N. When a Lighted Mirror or Lighted TV Mirror using LEDs retains an overall brightness greater than 70% of the original brightness, including cases whereas an individual LED fails; and/or

O. Normal wear and tear on the Product.

Séura does not warrant that its Products will integrate with any third party products at present or in the future. It is purchaser's responsibility to test and verify compatibility. Further, Séura does not warrant its software or programs, or any content downloaded after shipment. It is the purchaser responsibility to take precautions to protect the product from malware, viruses, data loss, and other potentially destructive programs.

**Warranty Disqualifiers.** This Limited Warranty only extends to, and runs for the benefit of, the original purchaser of the Product and only covers a Product purchased new. All warranty claims must be submitted together with original proof of purchase and any Product subject to a warranty claim must retain its original Séura serial number. Séura reserves the right to require any warranty claimant to produce the original purchase receipt or other original purchase date proof as may be reasonably required by Séura to verify the Product's warranty eligibility. Séura shall have no liability with respect to Products whose serial number has been removed, defaced, replaced, or otherwise tampered with in any manner. Séura reserves the right to examine all failed product components and determine, in its sole discretion, whether any product components are defective and covered under warranty.

**LIMITATION OF LIABILITY.** THE EXPRESS LIMITED WARRANTIES SET FORTH HEREIN ARE IN LIEU OF ALL OTHER WARRANTIES, WRITTEN OR ORAL, EXPRESSED OR IMPLIED, INCLUDING, BUT NOT LIMITED TO, ANY IMPLIED WARRANTIES OF MERCHANTABILITY OR FITNESS FOR A PARTICULAR PURPOSE OR USE. SÉURA WILL NOT BE LIABLE FOR ANY DAMAGE TO OTHER PROPERTY CAUSED BY ANY DEFECT IN THE PRODUCT, DAMAGES BASED ON INCONVENIENCE, LOSS OF BUSINESS OPPORTUNITY, LOSS OF GOODWILL, INTERFERENCE WITH BUSINESS RELATIONSHIPS, OR OTHER COMMERCIAL LOSS, EVEN IF THE CUSTOMER HAS BEEN ADVISED OF THE POSSIBILITY OF SUCH DAMAGES. SÉURA WILL NOT BE LIABLE FOR ANY LOSS, DAMAGE OR LIABILITY OR ANY DIRECT, INCIDENTAL, INDIRECT, PUNITIVE, SPECIAL OR CONSEQUENTIAL DAMAGES RESULTING FROM THE USE OR MISUSE OF A PRODUCT, OR ARISING OUT OF ANY BREACH, BY THE PURCHASER OF A PRODUCT, OF THIS LIMITED WARRANTY. SÉURA SHALL NOT BE LIABLE FOR ANY CLAIM AGAINST THE CUSTOMER BY ANY OTHER PARTY. SÉURA SHALL NOT BE LIABLE FOR ANY VERBAL WARRANTY ASSURANCES MADE BY ANY EMPLOYEE OR AUTHORIZED DISTRIBUTOR, RESELLER OR INSTALLER THAT CONFLICTS WITH OR ENHANCES THE WRITTEN WARRANTY HEREIN. SOME STATES DO NOT ALLOW THE EXCLUSION OR LIMITATION OF INCIDENTAL OR CONSEQUENTIAL DAMAGES, OR LIMITATIONS ON HOW LONG AN IMPLIED LIMITED WARRANTY LASTS, SO THE EXCLUSIONS MAY NOT APPLY TO A PARTICULAR PURCHASER. NOTWITHSTANDING ANYTHING HEREIN TO THE CONTRARY, SÉURA'S MAXIMUM AGGREGATE LIABILITY RELATED TO ANY WARRANTY CLAIM OR WITH RESPECT TO A PRODUCT SHALL NOT EXCEED THE THEN CURRENT SÉURA WHOLESALE PRICE OF THE SPECIFIC PRODUCT FROM WHICH THE CLAIM DERIVES.

NOTICE OF ANY WARRANTY CLAIM MUST BE RECEIVED BY SÉURA, IN WRITING, PRIOR TO THE EXPIRATION OF THE APPLICABLE WARRANTY PERIOD SET FORTH ABOVE. THE PRODUCT WARRANTY APPLIES ONLY FOR THE PERIODS SET FORTH ABOVE.

**Warranty Procedure.** A warranty claimant must contact Séura at 920-857-9069 for a diagnostic. Please have your Product receipt available. At that time, Séura will provide technical support over the phone to attempt to fix the problem. If unsuccessful, a Séura Representative will determine if the Product will be serviced onsite, replaced, or returned to Séura's factory in Green Bay, Wisconsin for repair. If Séura determines that the Product is not covered under the warranty or damaged in shipping, Séura will notify and inform the purchaser of service alternatives that are available on a fee basis.

**Toll-Free Technical Support:** Please call 1-800-957-3872 to speak with a Séura Technical Support Representative. Séura Representatives are available Monday-Friday, 8:00am-4:30pm Central Time.

**Onsite Service:** If Technical Support determines the problem may be fixed onsite, a Séura service agent will be scheduled within 24 hours to service the unit. A Séura representative will work with the customer to schedule a convenient time for onsite service. Parts may be sent to the customer's location. Onsite service is available in the United States during normal business hours Monday – Friday, unless other special circumstances exist and special arrangements are made.

**Factory Service:** If Technical Support determines the Product must be sent back to Séura's factory for repair, the customer must follow return instructions below. Séura will ship the repaired Product to the authorized reseller, installer or customer's address. This warranty does not cover removal or installation costs of Products.

**Advanced Replacement:** If Technical Support determines the Product must be replaced, Séura will ship a new Product to the authorized reseller, installer or customer's address. The customer must follow return instructions below to send the damaged Product back to Séura's factory. Credit card information will be collected before shipment of the replacement Product. If Séura does not receive the original Product back within thirty (30) days of shipping the replacement Product, the credit card on file will be charged at full MSRP. This warranty does not cover removal or installation costs of Products.

**Return Instructions:** If return is necessary, Séura will issue a return goods authorization (RGA) number and, if applicable, specific return and shipping instructions. A Product will only be accepted for warranty claims if returned and shipped to Séura in the Product's original packaging materials. If original packaging is not available, please contact Séura to receive authorized replacement packaging. Packages not bearing the issued returned goods authorization (RGA) number will not be accepted by Séura and will be returned to sender. In addition to the Product, the package must include the warranty claimant's original sales receipt for the purchase of the Product. All Product returns shall be received by Séura, at 1230 Ontario Road; Green Bay, WI 54311 with freight prepaid by the warranty claimant. Séura shall not be responsible for, and the warranty claimant assumes and retains all such responsibility, any damage or loss to or of the Product during shipment to and from Séura as the result of a warranty claim.

**Exclusive Remedy.** This Limited Warranty sets forth the exclusive remedies of a warranty claimant, and the exclusive liabilities and obligations of Séura, with respect to allegations of a defective Product.

19163121.3

The Bluetooth® word mark and logos are registered trademarks owned by the Bluetooth SIG, Inc. and any use of such marks by Séura is under license. Other trademarks and trade names are those of their respective owners.

