

WARRANTY REGISTRATION
**REGISTER FOR
EXTRA BENEFITS**

Activate within 30 days of purchase:
seura.com/activate



 **SÉURA**
Full Sun Series™

WELCOME GUIDE

UB4-50
UB4-65
UB4-85

Specifications

GENERAL	OPERATING TEMP. RANGE (MAX)	-40 to 140° F*
	OPERATING TEMP. RANGE (IDEAL)	32 to 122° F
	NON-OPERATING TEMP. RANGE	-40 to 140° F*
	OPERATING HUMIDITY RANGE	10-90% RH Non-condensing
	WATERPROOF RATING	IP55
	ISOTROPIC BLACKOUT PREVENTION	High TNI panels help prevent screen blackout
	ACTIVE HEATING/COOLING	Extreme Temperature Protection™
VIDEO	DISPLAY TYPE	LED Backlit LCD
	DISPLAY RESOLUTION	4K UHD 3840 x 2160
	DISPLAY BRIGHTNESS	2000 nits
	DISPLAY COATING	Anti-Glare
	ASPECT RATIO	16:9
	CONTRAST RATIO	5000:1
	REFRESH RATE	60Hz
	FRAME RATE	30 fps+
	VIEWING ANGLE	178° Horiz/Vert
	RESPONSE TIME	8ms
	OUTDOOR OPTICS™	Five outdoor picture modes from full sun to nighttime viewing
	COLOR GAMUT WIDTH	HDR-10 Rec 709 Compliant
	COLOR MANAGEMENT SYSTEM	Yes
TUNER	ATV (NTSC) / DTV (ATSC)	
DC Output	DC 5V 0.5A	
AUDIO	ANALOG AUDIO INPUT	RCA x 1
	ANALOG AUDIO	Stereo 3.5mm Variable
	BLUETOOTH® AUDIO BROADCASTING	Bluetooth® 4.2, 50 ft Clear Span
	DIGITAL AUDIO OUT	1 x Optical, 1 x Coax
	DOLBY DIGITAL	Dolby Digital 2.1
	INTERNAL SPEAKERS	N/A
SOUNDBAR	Sold Separately	



50 INCH
Model: UB4-50

65 INCH
Model: UB4-65

85 INCH
Model: UB4-85

	50 INCH Model: UB4-50	65 INCH Model: UB4-65	85 INCH Model: UB4-85	
DIMENSIONS	DIMENSIONS	45.1" w x 26.2" h x 3.8" d	58.2" w x 33.6" h x 3.8" d	76.0" w x 43.6" h x 3.8" d
	WEIGHT	60 lbs.	104 lbs.	187 lbs
	MEDIA COMPARTMENT DIMENSIONS	Upper portion: 3.9" w x 7.7" h x 1.7" d	Upper portion: 5.1" w x 7.8" h x 1.6" d	Upper portion: 5.1" w x 7.7" h x 1.6" d
		Lower portion: 10.1" w x 5.7" h x 1.7" d	Lower portion: 11.6" w x 5.6" h x 1.6" d	Lower portion: 11.8" w x 5.7" h x 1.6" d
VESA PATTERN	400 x 400mm	400 x 400mm	600 x 400mm	
OTHER	POWER CONSUMPTION, DISPLAY	Standby: 1.0W Max: 398W	Standby: 3.5W Max: 682W	Standby: 3.5W Max: 1096W
	ELECTRICAL	NEMA 5-15P 3-prong 120V Outlet	NEMA 5-15P 3-prong 120V Outlet	NEMA 5-20P† 3-prong 120V Outlet
	WARRANTY	Séura warrants Outdoor Displays w/ respect to Séura's labor, structure, assembly, display including remote and power supply for two (2) years		
	REMOTE	Séura Water Resistant IR Remote		

*Installation in sunlight reduces the maximum permitted air temperature. Extreme Temperature Protection™ utilizes internal fans that are necessary for controlling the internal TV temperature. The fans are performing as designed when creating a low-level hum in warm temperatures.

†The 85" model requires a 20 amp circuit with a NEMA 5-20P compatible electrical outlet.

WARNING: READ ALL INSTRUCTIONS BEFORE ATTEMPTING TO INSTALL OR SERVICE THIS PRODUCT.



This symbol is intended to alert the user to the presence of uninsulated "dangerous voltage" within the product's enclosure that may be of sufficient magnitude to constitute a risk of electric shock to persons.



This symbol is intended to alert the user to the presence of important operating and maintenance instructions in the literature accompanying the appliance.

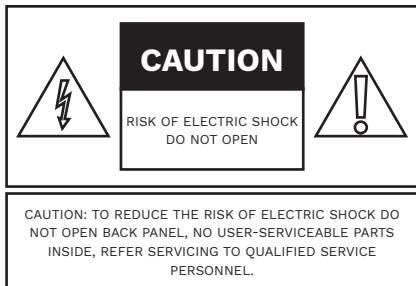

Warnings:

Do not handle or remove your outdoor display from the packaging until it is ready to be installed.

To avoid damage to the outdoor display, only transport it in a vertical position.

It is highly recommended that at least two (2) persons assist in the installation of the outdoor display.

Do not submerge in water: The Séura® Outdoor Display will resist water exposure from normal rain, sprinklers, snow, etc.; however, it is not designed to be submerged in water.

Do not wash with garden hose or pressure-wash: The Séura® Outdoor Display will resist water exposure from normal rain, sprinklers, snow etc.; however, it is not designed to withstand pressure washers, high-pressure water jets, projected snow from a blower, or hurricane-type weather.

Do not let metal pieces or objects of any kind fall into the display. High voltage flows in the product, and inserting an object can cause electric shock and/or short internal parts.

To prevent fire, never place any type of candle or flames on the top or near the display.

To prevent fire or shock hazard, do not place the AC cord under the display or other heavy items.

Power Lines

An outside antenna system should not be located in the vicinity of overhead power lines or other electric light or power circuits, or where it can fall into such power lines or circuits. When installing an outside antenna system, extreme care should be taken to keep from touching such power lines or circuits as contact with them might be fatal.

Accessories

Do not use accessories not specifically recommended by the manufacturer. Use of improper attachments can result in accidents.

AVERTISSEMENT: LIRE TOUTES LES INSTRUCTIONS AVANT D'INSTALLER OU SERVICE CE PRODUIT.



Ce symbole est destiné à alerter l'utilisateur de la présence d'une «tension dangereuse» non isolée à l'intérieur de l'enceinte du produit qui peut être d'une amplitude suffisante pour constituer un risque de choc électrique pour les personnes.



Ce symbole est destiné à alerter l'utilisateur de la présence d'instructions importantes d'utilisation et de maintenance dans la documentation accompagnant l'appareil.



Avertissements:

Ne pas manipuler ou supprimer votre moniteur extérieure de l'emballage jusqu'à ce qu'il soit prêt à être installé. Pour éviter d'endommager la moniteur en plein air, seul le transporter dans une position verticale. Il est fortement recommandé qu'au moins deux (2) personnes aident à l'installation de la moniteur en plein air.

N'immergez pas le Séura® Outdoor moniteur dans l'eau: le moniteur Séura® Outdoor résistera à l'exposition à l'eau causée par la pluie, les gicleurs, la neige, etc. Cependant, il n'est pas conçu pour être immergé dans l'eau.

Ne lavez pas avec un tuyau d'arrosage ou avec un nettoyeur haute pression: Séura® Outdoor moniteur résistera à l'exposition à l'eau causée par la pluie, les sprinklers, la neige, etc. Cependant, il n'est pas conçu pour résister aux laveuses à pression, aux jets d'eau à haute pression, aux projections de neige d'un ventilateur ou aux intempéries de type ouragan.

Ne laissez pas de morceaux de métal ou d'objets de toute sorte tomber dans la moniteur. Une tension élevée circule dans le produit et l'insertion d'un objet peut provoquer un choc électrique et / ou un court-circuit des pièces internes.

Pour éviter les incendies, ne placez jamais de bougies ni

de flammes sur le dessus ou à proximité du moniteur.

Pour éviter tout risque d'incendie ou d'électrocution, ne placez pas le cordon d'alimentation sous le moniteur ou d'autres objets lourds.

Les lignes électriques

Une antenne extérieure ne doit pas être située à proximité de lignes électriques aériennes ou d'autres circuits d'éclairage ou de circuits électriques, ni à un endroit où elle pourrait tomber dans de telles lignes ou circuits. Lorsque vous installez une antenne extérieure, veillez à ne pas toucher ces lignes ou circuits électriques, car tout contact avec ces derniers pourrait être fatal.

Accessoires

N'utilisez pas d'accessoires non spécifiquement recommandés par le fabricant. L'utilisation d'accessoires inappropriés peut entraîner des accidents.



WARNINGS

Never place a television set in an unstable location. A television set may fall, causing serious personal injury or death. Many injuries, particularly to children, can be avoided by taking simple precautions such as:

- Using cabinets or stands recommended by the manufacturer of the television set.
- Only using furniture that can safely support the television set.
- Ensuring the television set is not overhanging the edge of the supporting furniture.
- Not placing the television set on tall furniture (for example, cupboards or bookcases) without anchoring both the furniture and the television set to a suitable support.
- Not placing the television set on cloth or other materials that may be located between the television set and supporting furniture.
- Educating children about the dangers of climbing on furniture to reach the television set or its controls.

If your existing television set is being retained and relocated, the same considerations as above should be applied.



WARNING: Cancer and Reproductive Harm: www.p65warnings.ca.gov.

Specifications of this product are subject to unannounced changes; this manual may thus not reflect the current technical status.

Spécifications de ce produit sont sujettes à modifications sans préavis; ce manuel ne peut donc pas tenir compte de l'état de la technique actuelle.



ATTENTION

Ne placez jamais un téléviseur dans un endroit instable. Un téléviseur peut tomber

et causer des blessures graves ou mortelles. Beaucoup de blessures, en particulier aux enfants, peuvent être évitées en prenant des précautions simples telles que:

- *Utilisation des armoires ou des supports recommandés par le fabricant du téléviseur.*
- *Seulement en utilisant des meubles qui peuvent supporter en toute sécurité le téléviseur.*
- *Assurer le téléviseur est pas surplombant le bord du meuble de support.*
- *Non placer le téléviseur sur un grand meuble (par exemple, des armoires ou des bibliothèques) sans accrocher à la fois les meubles et le téléviseur sur un support approprié.*
- *Non placer le téléviseur sur le tissu ou d'autres matériaux qui peuvent être situés entre le téléviseur et le mobilier de soutien.*
- *Éduquer les enfants sur les dangers de grimper sur un meuble pour atteindre le téléviseur ou ses commandes.*

Si votre téléviseur existant est conservé et transféré, les mêmes considérations que ci-dessus doivent être appliquées.

FCC Supplier's Declaration of Conformity

Séura Outdoor Entertainment
UB4-50, UB4-65, UB4-85

These devices comply with part 15 of the FCC Rules. Operation is subject to the following two conditions: (1) This device may not cause harmful interference, and (2) this device must accept any interference received, including interference that may cause undesired operation.

Séura
Address: 1230 Ontario Road, Green Bay, WI 54301 United States
Phone number: 920-857-9069



Caution: The user is cautioned that changes or modifications not expressly approved by the party responsible for compliance could void the user's authority to operate the equipment.

Note: This equipment has been tested and found to comply with the limits for a Class B digital device, pursuant to part 15 of the FCC Rules. These limits are designed to provide reasonable protection against harmful interference in a residential installation. This equipment generates uses and can radiate radio frequency energy and, if not installed and used in accordance with the instructions, may cause harmful interference to radio communications. However, there is no guarantee that interference will not occur in a particular installation. If this equipment does cause harmful interference to radio or television reception, which can be determined by turning the equipment off and on, the user is encouraged to try to correct the interference by one or more of the following measures:

- Reorient or relocate the receiving antenna.
- Increase the separation between the equipment and receiver.
- Connect the equipment into an outlet on a circuit different from that to which the receiver is connected.
- Consult the dealer or an experienced radio/TV technician for help.

This equipment complies with FCC radiation exposure limits set forth for an uncontrolled environment. This equipment should be installed and operated with a minimum distance of 20 cm between the radiator and any part of your body.



WARNINGS

To reduce the risk of fire, electrical shock and other injuries, keep these safety precautions in mind when installing, using, and maintaining your outdoor display. The socket-outlet should be installed near the equipment and be easily accessible. The display should be connected to a grounded GFCI protected main socket outlet.

WARNING: If you manipulate against the recommended usage, serious injury or death to user may result.



AVERTISSEMENTS

Pour réduire le risque d'incendie, de choc électrique et d'autres blessures, garder ces consignes de sécurité à l'esprit lors de l'installation, l'utilisation et l'entretien de votre moniteur en plein air. La prise de courant doit être installée près de l'équipement et être facilement accessible. Le moniteur doit être relié à une prise de courant avec terre protégé par disjoncteur différentiel.

ATTENTION: Si vous manipulez contre l'utilisation recommandée, des blessures graves ou la mort à l'utilisateur peuvent en résulter.

Important Safety Instructions

1. Read these instructions.
2. Keep these instructions.
3. Heed all warnings.
4. Follow all instructions.
5. Clean only with a dry cloth.
6. Do not block any of the ventilation openings. Install in accordance with the manufacturer's instructions.
7. Do not install near any heat sources such as radiators, heat registers, stoves, or other apparatus (including amplifiers) that produce heat.
8. Do not defeat the safety purpose of the polarized or grounding type plug. A polarized plug has two blades with one wider than the other. A grounding type plug has two blades and a third grounding prong. The wide blade or the third prong is provided for your safety. When the provided plug does not fit into your outlet, consult an electrician for replacement of the obsolete outlet.
9. Protect the power cord from being walked on or pinched particularly at plugs, convenience receptacles, and the point where they exit from the apparatus.
10. Only use the attachments/accessories specified by the manufacturer.
11. Use only with the cart, stand, tripod, bracket, or table specified by the manufacturer, or sold with the apparatus. When a cart is used, use caution when moving the cart/apparatus combination to avoid injury from tip-over.
12. Unplug this apparatus during lightning storms or when unused for long periods of time (30 days or longer).
13. Refer all servicing to qualified service personnel. Servicing is required when the apparatus has been damaged in any way, such as power supply cord or plug is damaged, liquid has been spilled or objects have fallen into the apparatus, the apparatus has been exposed to rain or moisture, does not operate normally, or has been dropped.
14. To reduce the risk of fire or electric shock, do not expose the inside of this apparatus to rain or moisture. The inside of this apparatus shall not be exposed to dripping or splashing.
15. The apparatus shall be connected to a MAINS socket outlet with a protective earthing connection. Where the MAINS plug or an appliance coupler is used as the disconnect device, the disconnect device shall remain readily operable.
16. The disconnect device shall remain readily operable.
17. The socket-outlet shall be installed near the equipment and shall be easily accessible.
18. Inspect the desired location for installation and be aware of all electrical wiring pathways, water pipes, gas lines, or other potentially hazardous conditions that may exist to protect from accidental damage during creation of on-site conditions.
19. Ensure all required electrical specifications are adhered to and have been installed by the appropriate individuals and are code approved.
20. Ensure all framing requirements, if needed, have been completed to building code and pose no structural issues.
21. It is REQUIRED that this product is plugged into an electrical outlet protected by a Ground Fault Circuit Interrupter (GFCI) to protect against electric shock, fire, and/or injury. Failure to do so will void any warranty for this product.
22. Only qualified individuals should attempt to service the product. Removing covers can expose you to high voltage and other dangerous conditions.
23. Do not overload AC outlets or extension cords. Overloading can cause fire or electric shock.
24. Close adult supervision is necessary when any product is used by or near children.
25. Do not operate any product with a damaged cord or plug or operate it after the appliance malfunctions or has been damaged in any manner.
26. To electrically disconnect the product, turn OFF the product, then remove the electrical power plug from the outlet.
27. This Séura product is intended for use indoors and outdoors.
28. If you notice any smoke or scorched smell near the product, unplug power cord and refer to qualified personnel for service and/or repair.
29. Do not use or place any combustible or flammable substances near the product.
30. Do not use this product for other than intended use.
31. This product is water resistant. Do not immerse this product in water.
32. The cable distribution system should be grounded (earthed) in accordance with ANSI/NFPA 70, the National Electrical Code (NEC), in particular Section 820.93, Grounding of Outer Conductive Shield of a Coaxial Cable.



Consignes De Sécurité Importantes

1. Lisez ces instructions.
2. Conservez ces instructions.
3. Respectez tous les avertissements.
4. Suivez toutes les instructions.
5. Nettoyer uniquement avec un chiffon sec.
6. Ne pas bloquer les ouvertures de ventilation. Installez conformément aux instructions du fabricant.
7. Ne pas installer près de sources de chaleur telles que des radiateurs, registres de chaleur, poêles ou autres appareils (y compris les amplificateurs) qui produisent de la chaleur.
8. Ne pas contourner le dispositif de sécurité de la fiche polarisée ou mise à la terre. Une fiche polarisée possède deux lames dont une plus large que l'autre. Une prise de terre à deux lames et une troisième broche de mise à la terre. La lame large ou la troisième broche est fournie pour votre sécurité. Si la fiche fournie ne rentre pas dans votre prise, consultez un électricien pour remplacer la prise obsolète.
9. Protégez le cordon d'alimentation d'être piétiné ou pincé, en particulier au niveau des fiches, des prises de courant, et le point où ils sortent de l'appareil.
10. Utilisez uniquement les fixations / accessoires spécifiés par le fabricant.
11. Utilisez uniquement avec un chariot, un support, un trépied, un support ou une table spécifié par le fabricant ou vendu avec l'appareil. Quand un chariot est utilisé, faites attention lorsque vous déplacez l'ensemble chariot / appareil pour éviter les blessures en cas de chute.
12. Débranchez l'appareil en cas d'orage ou lorsqu'il est inutilisé pendant de longues périodes de temps (30 jours ou plus).
13. Les travaux de personnel qualifié. Une réparation est nécessaire lorsque l'appareil a été endommagé de quelque façon que ce cordon d'alimentation ou la fiche est endommagé, du liquide a été renversé ou des objets sont tombés dans l'appareil, l'appareil a été exposé à la pluie ou à l'humidité, ne fonctionne pas normalement, ou est tombé.
14. Pour réduire le risque d'incendie ou de choc électrique, ne pas exposer l'intérieur de cet appareil à la pluie ou à l'humidité. L'intérieur de cet appareil ne doit pas être exposé à des gouttes ou des éclaboussures.
15. L'appareil ne doit être relié à une prise secteur dotée d'une connexion de terre de protection. Lorsque la prise du RESEAU DALIMENTATION ou une prise placée sur l'appareil est utilisée comme dispositif de déconnexion, ce dispositif doit demeurer aisément accessible.
16. Le dispositif de déconnexion doit rester facilement accessible.
17. La prise de courant doit être installée près de l'équipement et doit être facilement accessible.
18. Inspecter l'emplacement souhaité pour l'installation et être conscient de toutes les voies de câblage électrique, les canalisations d'eau, conduites de gaz, ou d'autres conditions potentiellement dangereuses qui peuvent exister pour protéger contre les dommages accidentels lors de la création des conditions sur place.
19. Assurez-vous que toutes les spécifications électriques requises sont respectées et ont été installées par les personnes appropriées et sont approuvées par le code.
20. S'assurer que toutes les exigences d'encadrement, si nécessaire, ont été achevées au code du bâtiment et ne posent pas de problèmes structurels.
21. Il est REQUIS que ce produit soit branché dans une prise électrique protégée par un disjoncteur de fuite à la terre (GFCI) pour se protéger contre les chocs électriques, les incendies et / ou les blessures. Le non-respect de cette consigne annulera toute garantie de ce produit.
22. Seules les personnes qualifiées doivent tenter de réparer le produit. Le retrait des capots peut vous exposer à de hautes tensions et d'autres situations dangereuses.
23. Ne surchargez pas les prises de courant ou les rallonges. Une surcharge peut causer un incendie ou un choc électrique.
24. Fermer surveillance d'un adulte est nécessaire lorsque tout appareil est utilisé par ou près des enfants.
25. Ne pas utiliser un produit avec un cordon ou une fiche détériorés fonctionner après un mauvais fonctionnement de l'appareil ou a été endommagé d'une manière quelconque.
26. Pour débrancher électriquement le produit, éteignez le produit, puis retirez la fiche d'alimentation électrique de la prise.
27. Ce produit Séura est destiné à un usage intérieur et extérieur.
28. Si vous remarquez de la fumée ou une odeur de brûlure à proximité du produit, débranchez le cordon d'alimentation et consultez un personnel qualifié pour le service et / ou la réparation.
29. N'utilisez ni ne placez aucune substance combustible ou inflammable à proximité du produit.
30. N'utilisez pas ce produit pour un usage autre que celui prévu.
31. Ce produit est résistant à l'eau. Ne pas plonger ce produit dans l'eau.
32. Le système de distribution par câble doit être mis à la terre (mise à la terre) conformément à la norme ANSI / NFPA 70, le National Electrical Code (NEC), en particulier la section 820.93. Mise à la terre du blindage conducteur externe d'un câble coaxial.



The screen is most optimally viewed at ambient temperatures of 32°F to 122°F

Operation and Storage Requirements

The maximum ambient temperature range for operating the device is -40°F to 140°F*. The screen is most optimally viewed at ambient temperatures of 32°F to 122°F. Do not install the device in the proximity of heat sources, such as heating pipes, heaters, furnaces or other devices that radiate heat. To prevent fire or electric shock, never allow liquids to enter the unit. The uninstalled product must be stored in dry and well ventilated rooms, without extreme temperature fluctuations. Heat sources and aggressive active substances may not be stored in the proximity of the device. The required storage temperature is -40°F to 140°F at an air humidity of 10 - 90% RH non-condensing. The device must be stored in the complete packaging, as delivered. The product must not operate on average more than twelve (12) hours per day on a permanent or extended periodic basis. The product must have proper, correct and sufficient AC supply voltage.

When the unit is used in temperatures below the ideal operating temperature range, the picture may appear slightly delayed or blurred. This is normal, and the picture will return to normal after the temperature increases to the ideal operating temperature range.

Séura Full Sun Series TVs utilize internal fans that actively heat and cool the electronics, a feature necessary for controlling the internal TV temperature in environments from -40° F to 140° F. The fans are performing as designed when creating a low-level hum when activated. Séura's cooling system volume specification is <40dB from 1 meter away from TV, with thermostatically control and modifiable control curve. The fan speed will increase in hotter temperatures in order to keep the TV cool. Fan speeds, as a percentage with 100% = full speed, at various TV temperatures are approximately: 104°F = 26% 113°F = 58% 122°F = 89% 131°F = 100%

*Installation in sunlight reduces the maximum permitted air temperature.

Get to know your Séura® Full Sun Series™ Outdoor Display

If you have questions, call Séura at 1-800-957-3872 to speak to a design expert.

Selecting the Installation Location

Installation over a gas fireplace is acceptable if the distance from the heat source is such that the air temperature surrounding the display does not exceed the maximum operating temperature. A mantle or other heat shield is recommended to further protect the display from heat. Installation over a wood fireplace or near heaters or blowers is not recommended and may result in damage to the electronics. If you have questions about your situation, you may call Séura at 1-800-957-3872 to speak to a design expert.

Not for installation in a sauna or directly above a hot tub where extreme heat and steam could damage the electronics.

Ventilation

Adequate ventilation must be maintained to ensure reliable and continued operation and to protect the display from overheating. There must be **at least 1.5 inches of space on all sides**. Do not install inside a cabinet, kiosk, or other enclosure.



Battery Disposal

Caution: This product may be shipped with batteries. Do not dispose of batteries in a fire or with ordinary household waste. Batteries may explode and can cause damage. Replace batteries only with the same or equivalent type of battery recommended by Séura. The disposal of batteries may be regulated by your state. For more information on recycling or properly disposing of your batteries, please check with your local municipality.

Cable Management

When running cables from inside the compartment to the sources, allow adequate spacing at the foam entry to the cabinet that allows the foam seal to completely surround each cable. Bunching the cables together can create gaps in the foam that allows moisture and insects to enter the cabinet that may result in damage.

When running HDMI cables longer than 30 feet, check your cable specifications. HDMI cables lose signal over long distances and your media setup may require a signal booster or HDMI balun.

Once connections are made, the media compartment cover must be secured. Failure to close the media compartment exposes the ports and components to the elements and has the potential to permanently damage electronics.

Screen Health

The 4K liquid crystal panel is a high technology product with 8,294,400 pixels, giving you fine picture details. Occasionally, a few non-active pixels may appear on the screen as a fixed point of blue, green or red. Please note that this does not affect the performance of your product. Pixel errors outside of Séura's specified and permitted area are covered under Séura's limited product warranty. Please inquire directly with Séura Technical Support regarding Séura's pixel policy.

Meet Séura® Full Sun Series™



In the Box



Power Cable

On 85-inch model only, the power cable is hardwired to the display.



IR Remote Control



Resource Information

Parts

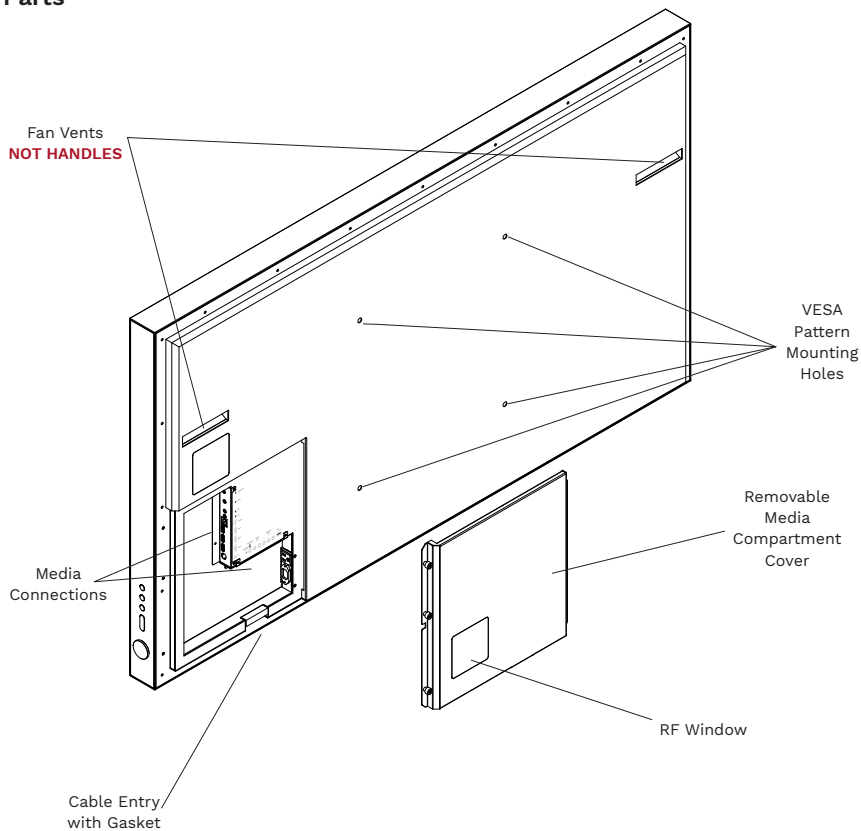

Installing Your Full Sun Series™

Séura® Full Sun Series™ is designed to be wall-mounted using the standard mounting hole pattern (VESA) on the back of the display. Use an outdoor-rated wall mount (sold separately) to mount to most outdoor wall surfaces. Follow the instructions with your mount for full details to install your display.

NOTE: Before beginning installation, verify that the weight rating and VESA hole pattern on the mount you purchased is compatible with your outdoor display.

1. Attach the Soundbar (optional, sold separately)

Follow the instructions included with your soundbar to attach to your Full Sun Series.

2. Install the Wall Mounting Brackets (sold separately)

Follow the instructions included with your outdoor-rated wall mount to attach brackets to your display and wall. Before hanging the display, proceed to step 3.

3. Make Media Connections (see graphics on page 15)

Make all other preferred media connections inside the media compartment. Turn on the display and verify all media sources.

TIP: In case you decide to add an additional streaming device or media player at a later date, we recommend connecting extra HDMI or other cabling at the time of installation so you won't have to remove the display from the wall to connect.

Reattach the media compartment cover. Take care when screwing into place to minimize gaps around cords. At entry, cables should be spaced out to allow the foam seal to completely surround each cable. Bunching the cables together can create gaps in the foam that allow moisture and insects to enter the cabinet that may result in damage.

If using an IR device (for example, Apple TV and Roku models prior to 2019), you will need to set up CEC control for your streaming device. This option is available in the settings menu of your streaming device. To enable CEC on your Séura TV, go to Menu – Network – Advanced Network Setting – CEC. This allows you to use Séura's TV remote to control the streaming device. If your streaming device does not use an RF connection and is not CEC compatible, then it will not receive remote control commands when placed in the media compartment. An IR emitter may work in getting a signal to the streaming device.

4. Hang Full Sun Series on the Wall

Complete installation by hanging Full Sun Series on the mount according to the mount instructions.

Séura is not liable for damage or destruction to third party devices used with Séura products.

Accessing the Weatherproof Media Compartment

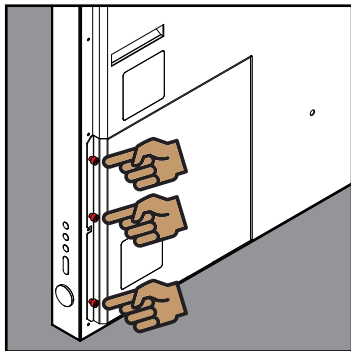

1. Unscrew the three thumb screws and remove the cover by pulling it towards you.

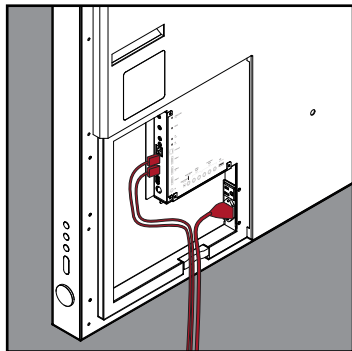

2. Route the cables to the proper inputs and place the cable cords over the rubber sealing gasket on the bottom of the cable access opening.

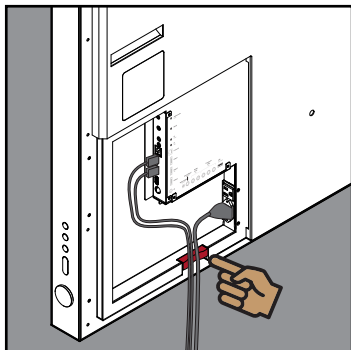

3. Ensure the cables are routed past the indentation on the bottom of the door. Cables cannot be routed through the top or side of the rubber sealing gasket.

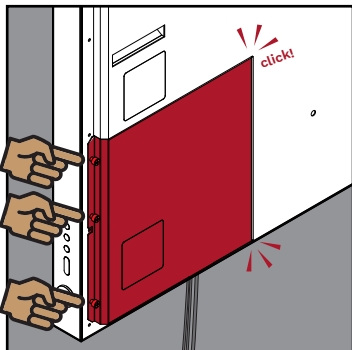

4. Close the cover. Press firmly on the cover and tighten the thumb screws.

Connecting Your Full Sun Series™

Open the weatherproof media compartment to access all connections. To connect a source such as a streaming device or cable box, connect one end of an HDMI cable (or other, cables not included) into an HDMI port on the display and the other end into your device.

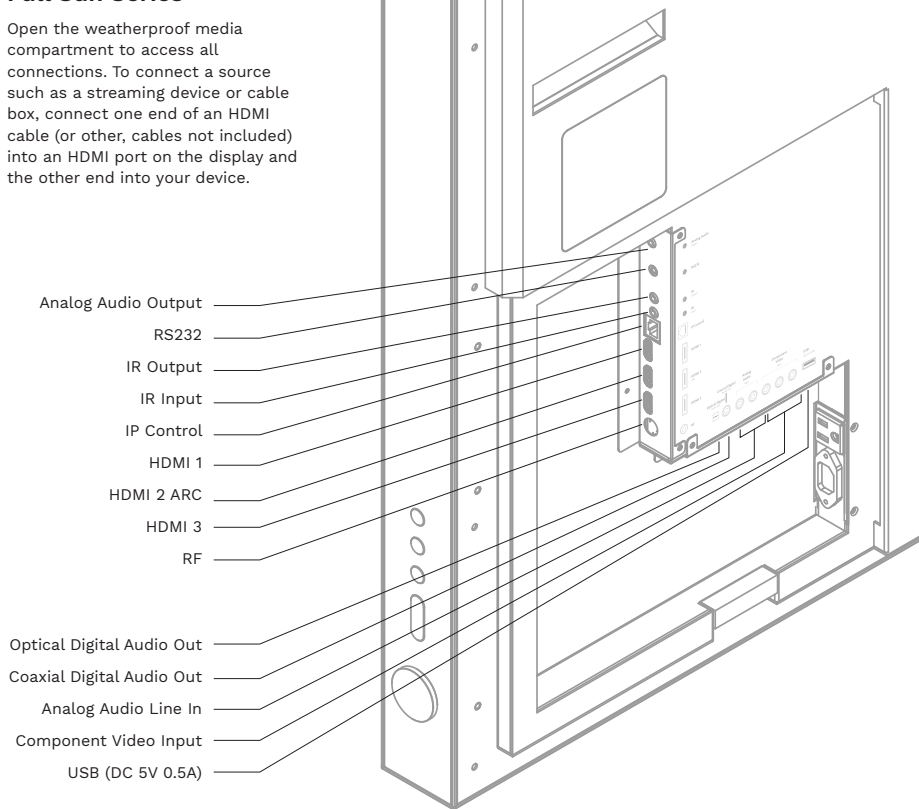

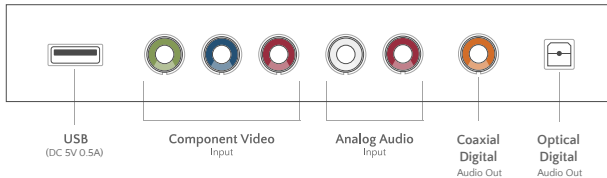
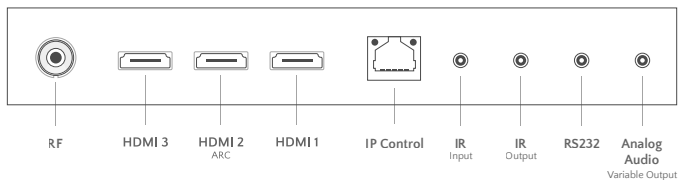

HDMI 1 and 3 connect to devices that use HDMI cables. These connection ports receive digital audio and high-definition signal through a single cable. These ports can accept an HDCP video device for video or PC for monitor display usage.

HDMI 2 ARC functions the same as HDMI 1 and 3, but has Audio Return Channel (ARC) functionality that can provide a better sound experience with devices that are ARC compatible.

USB connects to a USB device to view photos or to install firmware updates.

IR Input (3.5mm Stereo Jack Plug) connects to an IR receiver. The tip is signal. The sleeve is ground.

IR Output (3.5mm Stereo Jack Plug) connects to an IR emitter. The tip is signal. The sleeve is ground.

IP Control (RJ45) is used for connecting your control system via IP.

Analog Audio Output (3.5mm, Variable) connects to external, amplified audio devices such as soundbars.

RS-232 (3.5mm) connects a control system via RS-232.

RF (Coaxial) connects a digital or analog cable via a cable box or over-the-air antennas.

Optical Digital Audio Out (Fixed) is used for sending audio signals to other audio devices, such as stereo and surround sound receivers via an optical connection.

Coaxial Digital Audio Out (Fixed) is used for sending audio signals to other audio devices, such as stereo and surround sound receivers via a coaxial connection.

Analog Audio In is used for receiving audio signals from analog audio devices such as Blu-ray players or game consoles.

Component/Video In ports are for DVD players or satellite/cable boxes that use component cables. From left to right, connect green, blue and red for video. Next, connect white for left channel audio and red for right channel audio. Use the input button on your Séura remote to view this connection.

Making TV Connections

Connecting with HDMI (Best)

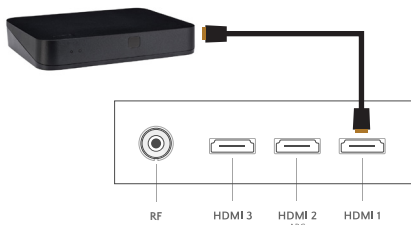

1. Make sure the power to the TV and the set-top box is turned off.
2. Connect an HDMI cable to the HDMI output of the set-top box and the other end to an HDMI port in the media compartment of the TV.
3. Turn on the TV and the set-top box.
4. Use the remote control's source button or the source button on the TV to switch to the appropriate HDMI port.

NOTE:

- Refer to the set-top box's manual to make sure the set-top box is configured to output correctly to the TV.
- This model supports SHARP's universal remote codes. If Séura is not listed, please use SHARP's codes in the universal remote's handbook.
- The TV will turn off automatically if there's no signal present for more than 15 minutes.

Connecting with Component (Good)

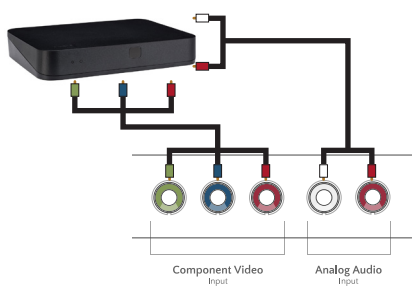

1. Make sure the power to the TV and the set-top box is turned off.
2. Using a Component Video Cable, connect the green, blue, and red connectors to the corresponding ports on both the set-top box and the TV.
3. Using an RCA Audio Cable, connect the white and red connectors to the corresponding audio ports on both the set-top box and the TV.
4. Turn on the TV and the set-top box.
5. Use the remote control's source button or the source button on the TV to switch to the appropriate YPbPr1 port.

Making Audio Connections

Connecting with Digital Optical (Best)

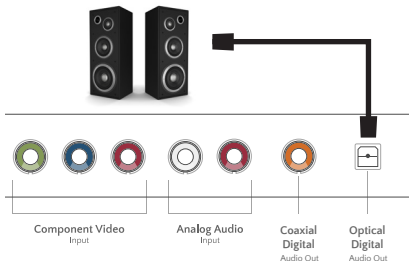

1. Make sure the power to the TV and receiver is turned off.
2. Using a coaxial or optical cable, connect to the receiver's coaxial or optical digital input and the coaxial or optical digital port on back of TV.
3. Turn on the TV and receiver.

Connecting with RCA Audio Analog (Good)

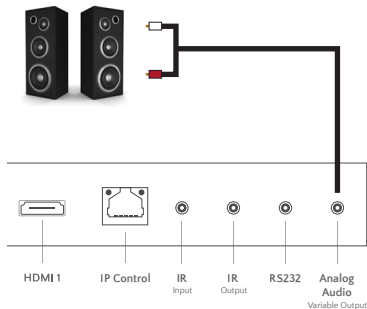

1. Make sure the power to the TV and the set-top box is turned off.
2. Using a 3.5mm stereo/audio cable, connect the receiver's audio input connection to the 3.5mm stereo/audio connection on the Analog Audio port located on the back of the TV. If the amplifier audio connection requires RCA audio out jacks, you will need a 1/8" Stereo Mini Plug to RCA adapter cable.
3. Turn on the TV and the receiver.

VESA Wall Mounting

Install your wall mount on a solid wall perpendicular to the floor. When attaching to other building materials, please contact your nearest dealer. If installed on a ceiling or slanted wall, it may fall and result in severe personal injury. We recommend that you use a Séura wall mount when mounting the display to a wall.

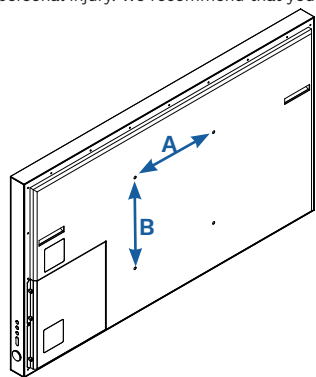

NOTE

Screw length needed depends on the wall mount used. For further information, refer to the instructions included with the mount.

Standard dimensions for wall mounting are shown in the above table.

When purchasing a Séura wall mount, a detailed installation manual and all parts necessary for assembly are provided.

Do not use screws longer than the standard dimension, as they may cause damage to the inside of the display.

	50 INCH UB4-50	65 INCH UB4-65	85 INCH UB4-85
VESA pattern (A x B)	400 x 400mm		600 x 400mm
Standard screw	M8	M8	M8
Top/bottom of TV to top/bottom VESA hole	5.2 inches	8.9 inches	13.9 inches
Right/left side of TV to right/left VESA hole	14.7 inches	21.2 inches	26.1 inches

VESA holes are centered on back of TV, top/bottom and left/right. See pages 50-52 for complete TV dimensions.

For wall mounts that do not comply with the VESA standard screw specifications, the length of the screws may differ depending on their specifications.

Do not use screws that do not comply with the VESA standard screw specifications.

Do not fasten the screws too strongly, this may damage the display or cause the display to fall, leading to personal injury. Séura is not liable for these kinds of accidents.

Séura is not liable for display damage or personal injury when a non-VESA or non specified wall mount is used or the consumer fails to follow the display installation instructions.

Consult with your local dealer for a wall mount that complies with the VESA pattern and weight of your display model. Refer to the instructions provided with your TV wall mount.

While a Séura mount is recommended, ensure that any third party mount is adequately secured with enough space to allow connectivity to external devices. If you are using a non-adjustable mount, attach the mount to the wall. Attach the cables to the display first, then attach the display to the mount.

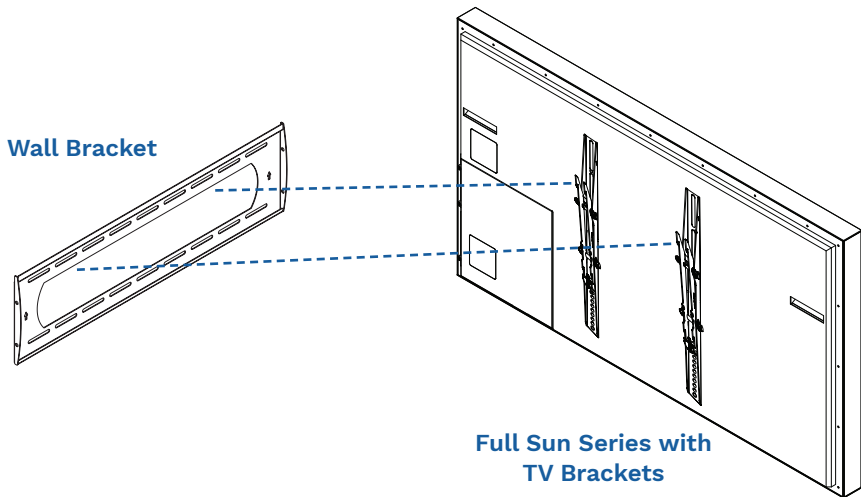

CAUTION: To adjust mount angles, position hands near the middle height of the vertical mounting brackets and apply light pressure. Do not apply pressure to the bottom TV corners.

CAUTION: Do not install your wall mount kit while your display is turned on. It may result in personal injury due to electric shock.

CAUTION: Do not allow children to climb on or hang from the display.

Remote Functions

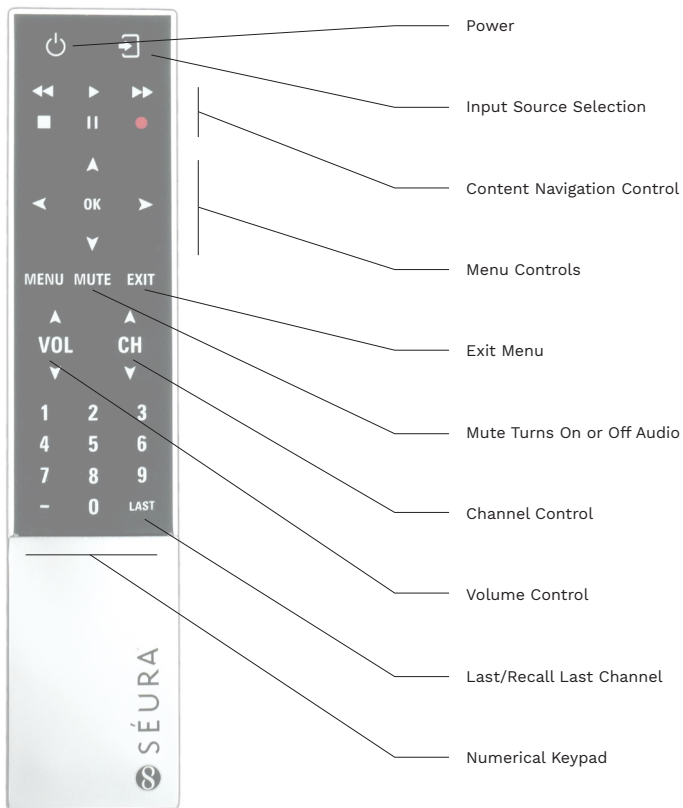

Side Panel Controls

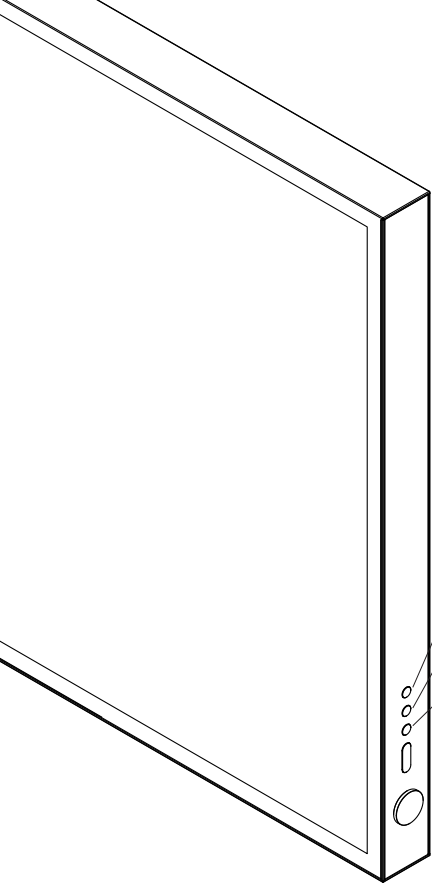

Power

Turn on the TV by pressing the button once. Press the button again to turn off the TV.

Menu

This button activates the on screen display (OSD). If a sub-menu is active, pressing this button will return selection to the previous menu level.

Source

This button switches between the different sources of the TV. When the OSD is active, this button acts as the enter button and confirms the menu selection.

Channel Control

These buttons change the TV channel up or down. If the OSD is active, these buttons function as up or down controls on the menu.

Volume Control

Turn the dial to increase and decrease the volume.

On Screen Menu: Picture

Picture Mode

Select between several different preset and user specified picture modes for optimal backlight, brightness, contrast, and color.

Full Sun

100% Brightness - Best for full sun environments

Shade

75% Brightness - Best for shaded or partial sun environments

Night

50% Brightness - Best for darker, partial light settings (optimal color accuracy)

Energy Saving

50% Brightness - Similar to Night Mode with reduced color accuracy

User

Allows user to manually adjust backlight, brightness, contrast and color settings

Aspect Ratio

Select between preset aspect ratios (how the viewable image fits on the screen).

Normal: 16:9

Zoom: 4:3

Wide: 21:09

Panoramic: 18:6

Auto (recommended)

Detects source media's aspect ratio and automatically adjusts picture accordingly



On Screen Menu: Picture

Advanced Picture Settings

HDMI 2.0 Format

Enable enhanced HDR HDMI 2.0 format to match user media source.

Standard

Enables SDR (Standard Dynamic Range)

Enhanced

Enables HDR (High Dynamic Range)

Adaptive Contrast

This is not relevant for Full Sun Series TVs.

Color Temperature

Adjust the correlated color temperature of the display.

Warm 2200-3000K (emphasizes red, yellow and orange hues)

Normal 3000-4000K

Cold 4000K+ (emphasizes blue, green and purple hues)

Overscan

Turn Overscan setting on/off. Overscan slightly enlarges the video image in order to hide possible artifacts that might appear on the edges of the picture.

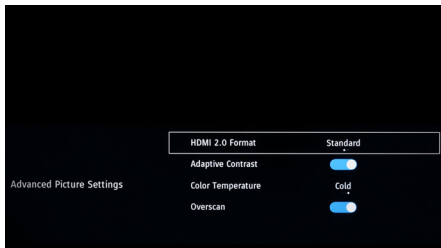

On Screen Menu: Picture

Reset Picture Settings

Reset all settings in the Picture menu to factory default.

Do you want to continue?

Confirms the user's intent to revert settings in the Picture menu to factory default.

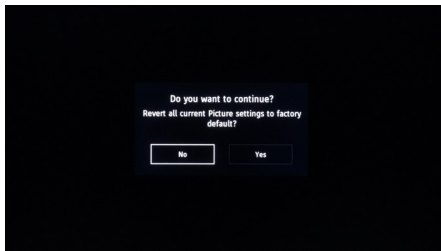

On Screen Menu: Audio

Sound Mode

Choose from several preset modes or customize to best match the surrounding environment of the TV, which can vary due to factors like listening environment, type of program watched or the type of device connected.

Standard

Use for typical viewing environments

Theater

Enhances treble and bass for a rich sound experience when watching movies

Music

Enhances mid-range frequencies for a more balanced audio performance when watching music based media

Speech

Enhances high-range frequencies to increase clarity in dialog based media

Late Night

Enhances dialog clarity and bass for quieter listening environments

Equalizer Options

100, 500, 1.5k, 5k, 10k

Select USER to create customized settings for each TV input. These settings will be automatically saved on each input for convenience.

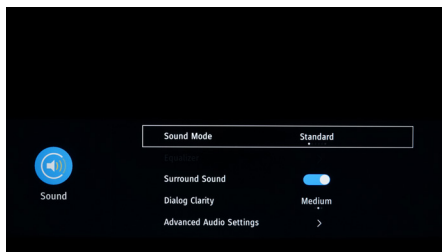

On Screen Menu: Audio

Surround Sound

Turn on 5.1 digital surround sound which employ 5 speakers (3 front, 2 rear) and a subwoofer to provide a truer, more immersive audio experience.

Dialog Clarity

Adjust high frequency audio clarity to enhance dialog while, unlike SPEECH mode, keeping background volume steady. Select High, Medium or Low intensity.

Advanced Audio Settings

Auto Volume Control

Turn on auto volume control to level out loud commercials and make quiet dialog more audible.

Digital Audio Output

Change the format of digital audio outputs for different types of external amplifiers and audio devices.

PCM: Pulse Code Modulated, used for Dolby systems

RAW: Raw Audio Output, used with systems other than Dolby

Digital Audio Delay

Adjust the delay sent from digital audio signals (coaxial, optical).

Lip Sync

Adjust the delay in which all audio signals are sent to allow for better lip sync with on screen dialog.

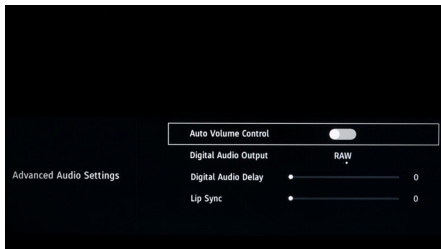
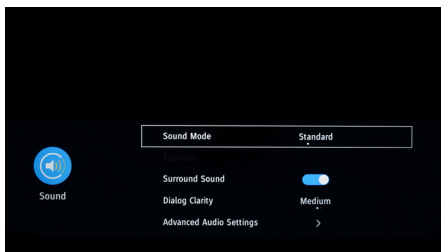

On Screen Menu: Audio

Reset Default Audio Settings

Reset all options in the Sound menu to factory default

Do you want to continue?

Confirms the user's intent to revert settings in the Sound menu to factory default.

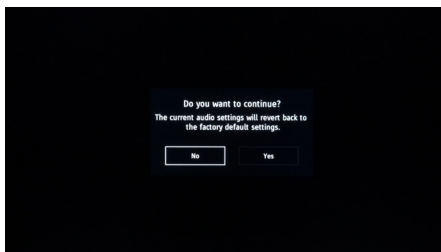

On Screen Menu: Channel

Tuner Mode

Make sure what kind of connection is made with your TV when selecting "Antenna" or "Cable".

Antenna

Select this option if you are receiving channels via digital air broadcast. To do this, you must have a digital broadcast antenna. If necessary, adjust the direction of the antenna to obtain the maximum signal strength.

Cable

Select this option if you are receiving channels through a cable connection.

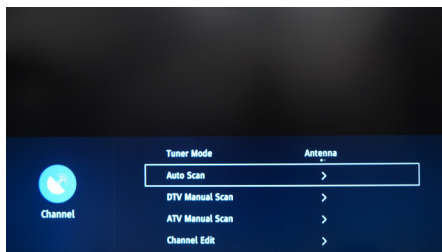

Auto Scan

Select the television signal format you will receive when scanning for channels. Use DTV+ATV in most situations.

DTV+ATV: Receives Digital TV Signals + Advanced TV Signals

DTV: Receives Digital TV Signals Only

ATV: Receives Advanced TV Signals Only

Auto Scan

This is typically the easiest and quickest way to setup TV channels when using either a digital antenna or cable. When selecting Auto Scan, the TV will automatically scan for both DTV and ATV signals and store only those channels that are found.

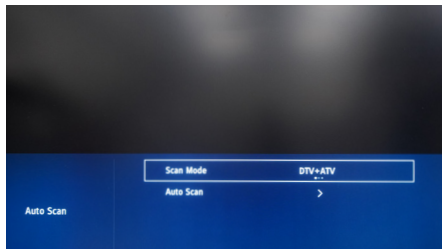

On Screen Menu: Channel

DTV Manual Scan

This only scans for a DTV signal within a specified range. Use this mode if auto scan is unable to locate channels you know exist in your area.

ATV Manual Scan

This only scans for a ATV signal within a specified range. Use this mode if auto scan is unable to locate channels you know exist in your area

Channel Edit

Channel Edit allows the user to manually remove specific channels as desired when using the TV function.

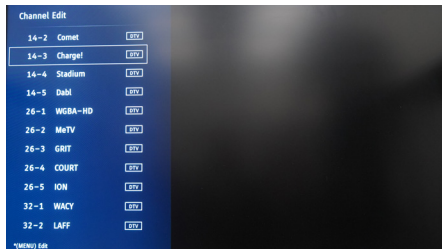
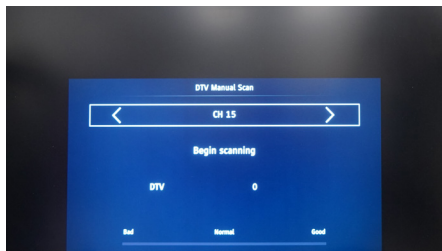

On Screen Menu: Network

Network

Ethernet

This indicates when the display is connected to IP via the ethernet port.

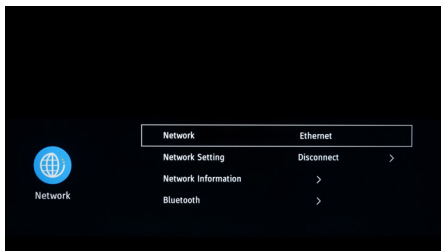

Network Setting

Disconnect

DHCP/Static toggles on and off the DHCP or Static options for IP address. Toggle to "Static" when manually entering an IP address.

IP Address: Sets the IP address in Static mode

Netmask: Sets the netmask in Static mode

Gateway: Sets the gateway in Static mode

DNS: Sets the DNS in Static mode

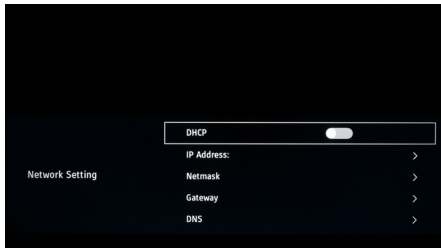

On Screen Menu: Network

Network Information

IP Address

Displays the current IP address

Netmask

Displays the current netmask

Gateway

Displays the current gateway

DNS

Displays the current DNS

Network Test

Network Test performs a test to ensure the IP connection is established. A dynamic graphic will display the word “Success” if the connection is secured.



Bluetooth

Enabled

Select “Enabled” to allow Bluetooth connectivity.

Manage Devices

Select “Manage Devices” to display a list of connected devices and a list of devices that are available for pairing. If there are no devices available for pairing, the screen will display “No Device Found”.

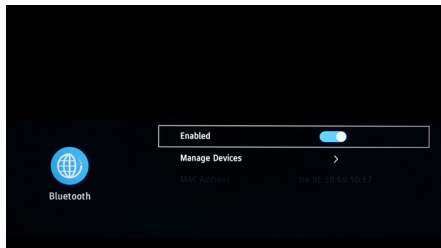

On Screen Menu: Accessibility

Menu Audio

Menu Audio turns on text to speech to provide audio narration of menu options.

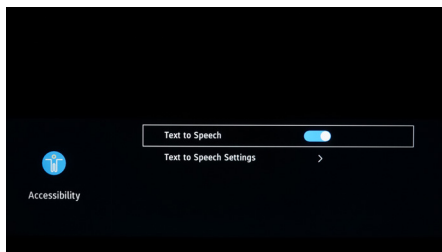

Menu Audio Settings

Volume

Adjusts Menu Audio volume

Rate

Adjusts Menu Audio speed

- Slow
- Normal
- Fast

Pitch

Adjusts audio narration from higher to lower pitch

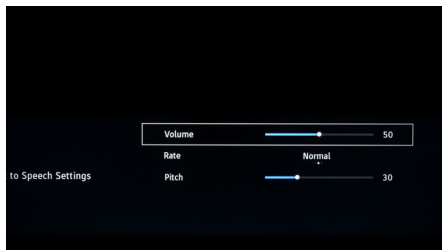

On Screen Menu: System

Menu Language

“Menu Language” allows user to select English, Spanish or French for the on-screen, TV menu.

- English
- Spanish
- Français

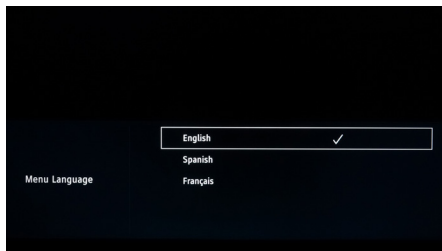

Language

“Location” establishes the location of the display to adjust parental controls and time zone settings.

- USA
- Mexico
- Canada

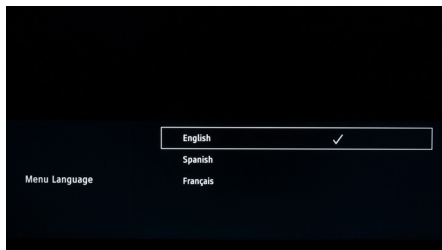

On Screen Menu: System

Time

Time Zone

Time Zone allows the user to select the appropriate time zone for the location being used.

Daylight Savings

“Daylight Savings” enables Daylight Savings synchronization when the TV is controlled with an IP connection.

Auto Sync

“Auto Sync” enables Time synchronization when the TV is controlled with an IP connection.

Time

User can manually enter the time.

Date

User can manually enter the date.

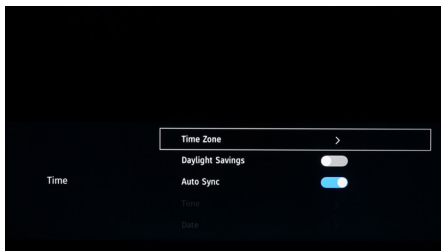

Parental Controls

Locks

During initial TV set up, use factory default PIN “0000”. To set your own 4-digit pin, refer “Change PIN” section on page 41 of this manual.

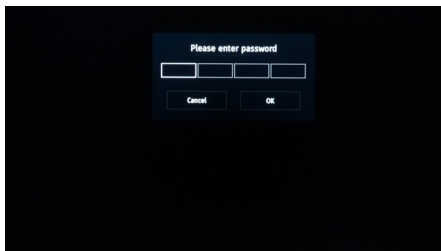

On Screen Menu: System

Parental Controls

US TV Ratings

TV parental guidelines used in the United States to help parents determine if a program is suitable for their child.

TV_Y: All Children - Intended for children ages 2 to 6 and is not designed or expected to frighten.

TV_Y7: Directed to Older Children - Intended for children ages 7 and older. Best suited for children who know the difference between real life and make-believe. Contains mild fantasy or comedic violence. Some content could frighten younger children (under age 7).

TV_G: General Audience - Intended for all ages. Contains little or no violence, no strong language and little or no sexual dialogue or situations.

TV_PG: Parental Guidance Suggested - Intended for younger children in the company of an adult. Possibly contains some suggestive dialogue, infrequent coarse language, some sexual situations or some moderate violence.

TV_14: Parents Strongly Cautioned - Intended for children ages 14 and older in the company of an adult. Possibly contains intensely suggestive dialogue, strong coarse language, intense sexual situations or intense violence.

TV_MA: Mature Audience Only - Intended for adults and may be unsuitable for children under 17. Possibly contains crude indecent language, explicit sexual activity or graphic violence.



On Screen Menu: System

Parental Controls

Movie Ratings

Motion Picture Association of America (MPAA)
voluntary ratings

None

G: General - Programs appropriate for viewing by persons of all ages.

PG: Parental Guidance Suggested - Some material may not be suitable for children.

PG-13: Parents Strongly Cautioned - Some material may be inappropriate for children under 13 years old.

R: Restricted - Under 17 years old requires accompanying parent or adult guardian in theater.

NC-17: No one under 17 years old admitted.

X: No one under 17 years old admitted (older rating that is the same as NC-17 but may be encoded in the data of older movies).

NR: Not rated

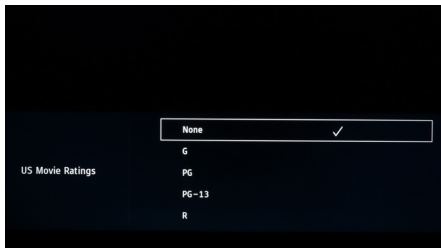

On Screen Menu: System

Parental Controls

Canadian English Ratings

E: Exempt - These programs are exempt from classification.

C: Children - These programs are suitable for children under the age of 8 and pays careful attention to themes that could threaten their sense of security and well-being.

C8+: Children age 8+ - These programs are suitable for children ages 8+ and contains no portrayal of violence as the preferred, acceptable, or only way to resolve conflict; nor encourage children to imitate dangerous acts which they may see on the screen.

PG: Parental Guidance - These programs contain themes or content that may not be suitable for children.

14+: Age 14 or older - Those under 14 years old should view with an adult. Parents cautioned that content may contain violence, coarse language and/or sexually suggestive scenes.

18+: Age 18 or older - Persons under 18 should view with an adult. Parents are strongly cautioned that content will likely contain explicit violence, frequent coarse language, sexual activity and/or horror.

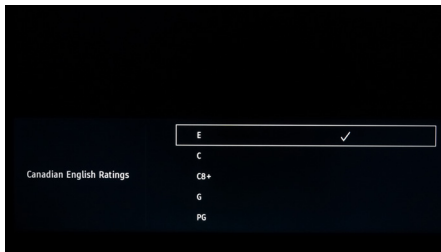

On Screen Menu: System

Parental Controls

Canadian French Ratings

E: Exempt - These programs are exempt from classification.

G: General - These programs are appropriate for viewing by persons of all ages.

8ans+: Age 8 or Older - Viewing with adult supervision recommended for children age 8 or under. Content may contain mild or occasional violence.

13ans+: Age 13 or Older - The program may be viewed, purchased or rented only by persons 13 years of age or older. Content could contain scenes of frequent violence.

16ans+: Age 16 or Older - The program may be viewed, purchased or rented only by persons 16 years of age or older. Content could contain scenes of frequent and intense violence.

18ans+: Age 18 or Older - The program may be viewed, purchased or rented only by persons 18 years of age or older. Content could contain scenes of frequent and extreme violence.

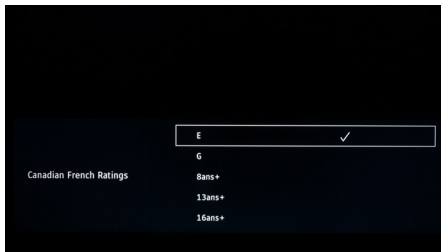

On Screen Menu: System

Parental Controls

Block Unrated

Prevent viewing of unrated content

Input Block

Allows user to set a PIN lock on each individual input

TV

HDMI1

HDMI2

HDMI3

AV

Component

Change PIN

Allows user to change PIN (default = 0000)

Restore Parental Control Defaults

Resets Parental Controls to factory setting

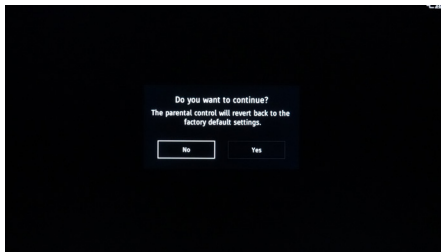

On Screen Menu: System

CEC Setting

Using the HDMI CEC (Consumer Electronics Control) protocol, you can interactively operate compatible system equipment (Blu-ray disc equipment, AV amplifier, DVD).

To access this function: System > CEC Setting

CEC Enable

Select "CEC Enable" to enable or disable the CEC functions listed below.

Power Off Device

By selecting "Power Off Device", the off power function is enabled. CEC commands will now be able to turn off the TV and place your devices in standby mode. **Auto Power On**

By selecting "Auto Power On", the on power function is enabled. While the TV is in standby mode, it automatically turns on and plays back the image from the HDMI source.

HDMI ARC

Selecting "HDMI ARC" allows the user to listen to the TV audio via audio equipment without using an optical fiber cable, which conventionally is required. HDMI2 is the ARC port.

Device Scan

Selecting "Device Scan" displays a list of connected CEC devices.

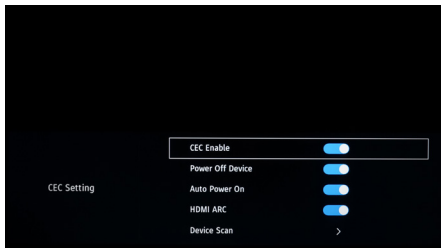

On Screen Menu: System

Advanced Settings

IR Input

The IR Input option allows you to choose between Modulated or Unmodulated settings. If using a control system to control the TV by running wires from the control system's IR output port to the TV's IR input port, select the correct IR signal (modulated or unmodulated) depending on what the control system requires. Some control systems use a modulated IR signal and some use an unmodulated IR signal.



On Screen Menu: Support

Software Version

Software Version

This displays the current firmware version identifier.

Model

This displays the TV model number.

Technical Support

Call this phone number to contact technical support for assistance.

Serial Number

This displays the TV's unique serial number.

USB Firmware Upgrade

Use for updating firmware through the USB service port when necessary.

Restore to Factory Default

Scroll below the USB Firmware Upgrade option to select this option. Restoring to the default factory settings simply returns the TV settings to the state in which it was shipped.



USB Playback: Photos

Photo Mode

You can connect a USB memory device to the TV to view photo content.

- Depending on the USB memory device, the TV may not be able to recognize the recorded data.
- It may take time to read the recorded data if the USB device contains many files or folders.
- Use only alphanumeric characters for naming files.
- File names over 80 characters may not be displayed.

Connecting a USB Memory Device/USB Hard Drive

- Insert the USB device with photos into the USB terminal on the TV.
- When connecting a USB hard drive, be sure to use a hard drive with an AC adapter.
- Do not remove a USB device or memory card from the TV while transferring files, using the slide show function, switching screens, or before you exit "USB" from the INPUT list.
- Do not insert and remove a USB device or hard drive to and from the TV repeatedly.
- When using a card reader, be sure to insert a USB memory device first.

Caution

- Do not use a USB extension cable when connecting a USB memory device to the USB terminal on the TV.
- Using a USB extension cable with the USB device may prevent the TV from performing correctly.

USB Playback: Photos

To select desired item, use arrow buttons on remote.

A few seconds after the cursor is positioned on a thumbnail, the file information is displayed in the right of the center of the screen.

Select "OK" to enter a directory, open a photo, or start a slideshow.

Press "MENU" to return to the previous process.

Slide Show

To view photos as a slideshow, select the image you want to start with and press "OK". The slideshow function will cycle through all photos within a folder on the inserted USB media device. To end the slideshow, press the "MENU" button.

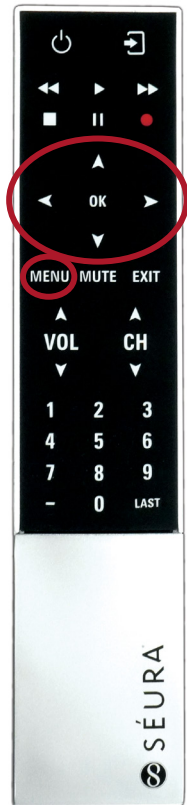

Using HDMI CEC (Consumer Electronics Control)

Using the HDMI CEC (Consumer Electronics Control) protocol, you can interactively operate compatible system equipment (Blu-ray disc equipment, AV amplifier, DVD).

To access this function: Menu > System > CEC Setting > CEC Enable

In addition to CEC control, Audio Return Channel (ARC) can be turned on within the CEC menu. ARC is connected to HDMI 2, and allows audio signals to be sent over one HDMI cable between the display and ARC enabled audio devices.

NOTES

- For connecting the TV to CEC compatible equipment, use commercially available cables.
- Point the remote control toward the TV and not toward connected HDMI equipment.
- Video noise may occur depending on the type of HDMI cable used. Make sure to use an HDMI certified cable.
- These operations affect the HDMI equipment selected as the current input source. If the equipment does not operate, turn on the equipment and select the appropriate input source using INPUT.
- The CEC feature may not operate properly when an HDMI splitter or AV selector unit is used. These devices may cause interruptions to the image and/or sound. Ensure that all devices in the signal chain are CEC compatible.

Caring for your Séura® Full Sun Series™

While Full Sun Series may be safely exposed to weather and moisture, the use of a Séura Outdoor Cover when not in use is recommended.

Transporting the Display

When transporting Full Sun Series, never carry it by holding or putting pressure on the screen. Screen pressure may damage the LCD or weaken the waterproof seal. Be sure to always transport with two people supporting it with both hands.

Caring for the Screen

To clean the screen, gently wipe the surface of the front panel with a clean, soft and lint-free cloth. If needed, dampen the cloth with distilled water or isopropyl alcohol and lightly wipe the screen. Do not use force as pressure on the screen may damage the LCD or weaken the waterproof seal. Do not use solvents or chemical cleaners as they may damage the screen. Do not use a garden hose or pressure washer on the display.

Caring for the Cabinet

Clean regularly with a clean, soft and lint-free cloth. Do not use a chemical cloth (wet/dry sheet type cloth). Use a mild detergent, isopropyl alcohol or multi-use cleaner to remove dust and debris. Stubborn stains such as mineral water deposits may be removed with a calcium or lime remover such as CRL®. However, DO NOT allow CRL® to touch the LCD screen as it will distort the surface. Cleaning with an abrasive cloth or using strong force may scratch the surface of the cabinet. Do not apply insecticides or other volatile liquids.

Use of a Séura Outdoor Cover when not in use is highly recommended to protect your display. Do not allow the cabinet to remain in contact with rubber or vinyl products for a long period of time. Plasticizers inside the plastic may cause the cabinet to deform and cause the paint to peel off.



Troubleshooting

If the product is not working properly, please check the following troubleshooting solutions before you contact customer service:

Challenge	Possible Solution
Will Not Power Up	<ul style="list-style-type: none">• Make sure to check that the AC power cable is connected to an outlet and the display.• Make sure that the power outlet is receiving power.• Try pressing POWER button on the display to make sure the problem is not the remote.• If the display turns on, refer to “Remote Control Not Working” troubleshooting.
Remote Control Not Working	<ul style="list-style-type: none">• Make sure that there are working batteries in the remote and in the correct polarity.• Make sure there are no obstacles in between the IR receiver and the remote.• Try pointing the remote directly at the display from 5 feet away.
Signal Issue	<ul style="list-style-type: none">• Check cable connections to ensure they are connected.• Plug the video source directly into the display which will remove any potential issues associated with an extender or matrix switch device. (if applicable).• Replace cables with known working cables.• Make sure the connected devices are powered on.• Make sure that the source is on the correct input.• Power cycle the video source device by unplugging the device and plugging the device back in.
No Sound	<p>Soundbar</p> <ul style="list-style-type: none">• Make sure your cables are connected properly.• Make sure the display is not on MUTE / turn up the volume.• Make sure the soundbar is connected to the power supply. <p>External Sound System</p> <ul style="list-style-type: none">• Make sure your cables are connected properly.• Make sure the display is not on MUTE / turn up the volume.• Make sure the Digital Audio Settings within the display is not set to OFF.• Test the external sound system with another device to ensure that it is working.

Troubleshooting

Challenge	Possible Solution
Picture is cut off with sidebar screen	<ul style="list-style-type: none">• Are screen mode adjustments such as picture size made correctly? See pages 24 to 26 in this document.
Strange color, light color, or color misalignment	<ul style="list-style-type: none">• Adjust the picture tone. See pages 24 to 26 in this document.• Is the environment too bright or too dark? The picture may look different depending on outside lighting conditions.
Power is suddenly turned off.	<ul style="list-style-type: none">• Check if the sleep timer is activated. Using your TV remote, navigate to Menu > System > Time > Sleep Timer, and then select the amount of time you would like the TV to stay on.• Check the power control settings. See page 42 in this document.• The unit's internal temperature may have increased above the allowable range. Remove any objects blocking the vent or clean the vents.

For additional technical support, please contact Séura at **1-800-957-3872** during regular business hours: M-F 8:00 am - 4:30 pm, Central Time.

Product Dimensions: Model UB4-50

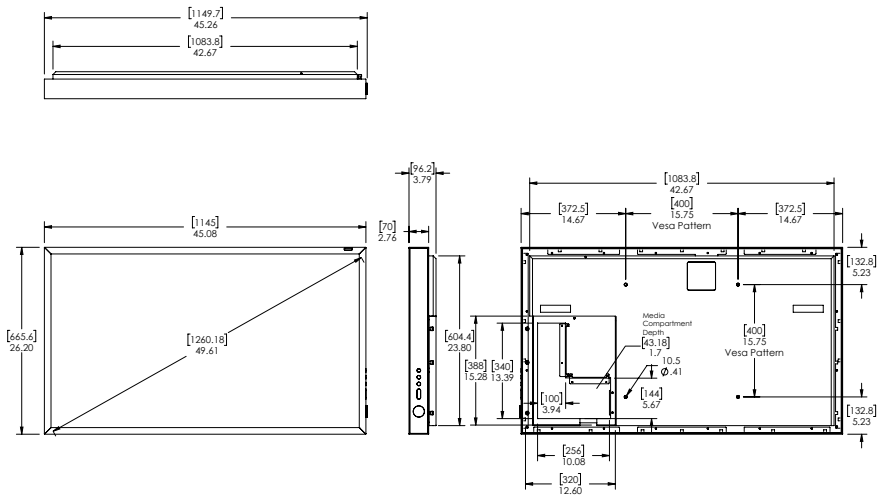

Product Dimensions: Model UB4-65

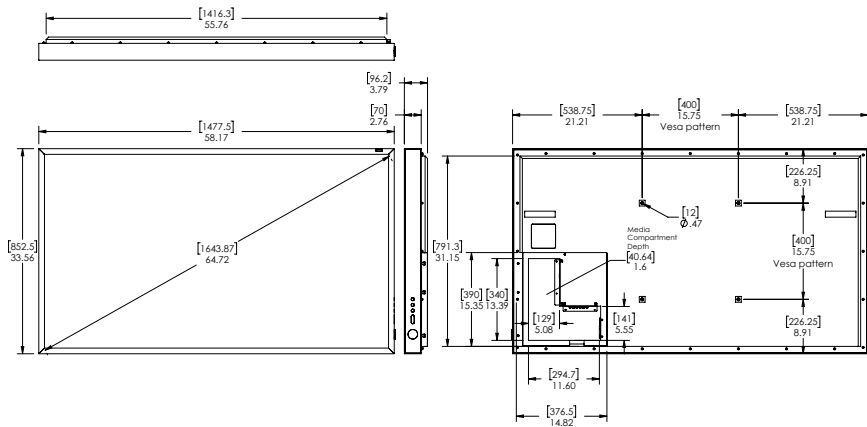

Product Dimensions: Model UB4-85

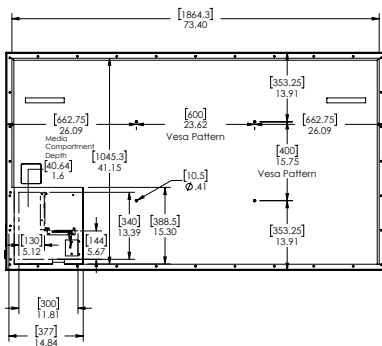
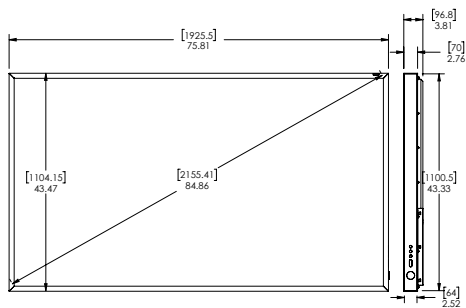
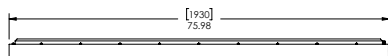

Control Documentation

To access current control documents, please visit www.seura.com/download-center

LIMITED PRODUCT WARRANTY

For information regarding Séura's warranty policy, please visit our website: www.seura.com/warranty. If the current Séura warranty policy is after your product purchase date, please contact Séura Customer Support to request warranty documentation from the date of your purchase.

For additional customer support, please contact Séura.
Toll Free: 1-800-957-3872 (Monday - Friday 8:00 am – 4:30 pm, Central Time)

Website: www.seura.com/support

For responsible recycling information, please contact Séura or visit the following URL:

www.seura.com/support/recycling/



1230 Ontario Road Green Bay, Wisconsin 54311
1-800-957-3872 contacts@seura.com
www.seura.com

Publish date: May 5, 2023
Information is subject to change without notice.

© 2022 Séura