

WARRANTY REGISTRATION

**REGISTER FOR
EXTRA BENEFITS**

Activate within 30 days of purchase:
seura.com/activate

OUTDOOR 80W SOUNDBAR



MODELS
SSB-1
SSB-2

Welcome

Thank you for purchasing a Séura Outdoor 80W Soundbar. Please read these instructions carefully before operating your new product.

Contents

Specifications.....	3
Safety Warnings.....	4
Get to know your Séura® Outdoor Soundbar	9
Parts and Tools	11
Installation Option 1: Mount to Bottom of Séura Outdoor TV.....	12
Installation Option 2: Mount to a Wall	17
Operating Instructions	20
Caring for your Séura Soundbar	20
Troubleshooting.....	21

Specifications

	Model: SSB-1	Model: SSB-2	
GENERAL	SÉURA TV COMPATIBILITY	TV Models SHD2-43, SHD2-55, UB4-50	TV Models SHD2-65, SHD2-75, UB4-65, UB4-85
	OPERATING TEMP. RANGE	-40°F to 140°F*	
	OPERATING HUMIDITY RANGE	10–90% Relative Humidity, Non-Condensing	
	WATERPROOF RATING	IP55	
INTEGRATION	POWER CONSUMPTION	100–240V, 50–60Hz, 80W Peak	
	OPTICAL AUDIO INPUT	1 (fixed)	
	ANALOG AUDIO INPUT	1 (3.5 mm, variable)	
AUDIO	DRIVERS	(4) 3-inch 8.0Ω Drivers	
	FREQUENCY RESPONSE	40Hz-20kHz	
	CHANNELS	2	
	SPEAKER OUTPUT	Internal Amplifier, 4x15W RMS	
INSTALLATION	GRILL TYPE	Plated Steel	
	PRODUCT DIMENSIONS	37.8" w x 5.5" h x 3.5" d	57.0" w x 5.5" h x 3.5" d
	PRODUCT WEIGHT	13.0 lbs	20.0 lbs
	VESA PATTERN	300mm x 60mm, 400mm x 60mm	400mm x 60mm, 600mm x 60mm
	MOUNTING	Mounting brackets and hardware included for mounting to a wall or Séura Outdoor TV	
OTHER	CERTS. AND COMPLIANCE	UL, FCC	
	WARRANTY	Séura warrants Outdoor Soundbars with respect to labor and parts for one (1) year.	

*Installation in sunlight reduces the maximum permitted air temperature.

WARNING: READ ALL INSTRUCTIONS BEFORE ATTEMPTING TO INSTALL OR SERVICE THIS PRODUCT.



This symbol is intended to alert the user to the presence of uninsulated "dangerous voltage" within the product's enclosure that may be of sufficient magnitude to constitute a risk of electric shock to persons.



This symbol is intended to alert the user to the presence of important operating and maintenance instructions in the literature accompanying the appliance.

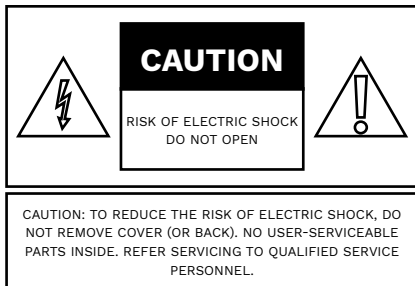

Warnings:

Do not submerge Séura® Outdoor Soundbar in water: The Séura® Outdoor Soundbar will resist water exposure from normal rain, sprinklers, snow, etc.; however, it is not designed to be submerged in water.

Do not wash with garden hose or pressure-wash: Séura® Outdoor Soundbar will resist water exposure from normal rain, sprinklers, snow etc.; however, it is not designed to withstand pressure washers, high-pressure water jets, projected snow from a blower, or hurricane-type weather.

Do not let metal pieces or objects of any kind fall into the soundbar. High voltage flows in the product, and inserting an object can cause electric shock and/or short internal parts.

To prevent fire, never place any type of candle or flames on the top or near the soundbar.

Warnings

To reduce the risk of fire, electrical shock and other injuries, keep these safety precautions in mind when installing, using, and maintaining your outdoor soundbar. The socket-outlet should be installed near the equipment and be easily accessible. The soundbar should be connected to a grounded GFCI protected main socket outlet.

WARNING: If you manipulate against the recommended usage, serious injury or death to user may result.

AVERTISSEMENT: LIRE TOUTES LES INSTRUCTIONS AVANT D'INSTALLER OU SERVICE CE PRODUIT.



Ce symbole est destiné à alerter l'utilisateur de la présence d'une «tension dangereuse» non isolée à l'intérieur de l'enceinte du produit qui peut être d'une amplitude suffisante pour constituer un risque de choc électrique pour les personnes.



Ce symbole est destiné à alerter l'utilisateur de la présence d'instructions importantes d'utilisation et de maintenance dans la documentation accompagnant l'appareil.

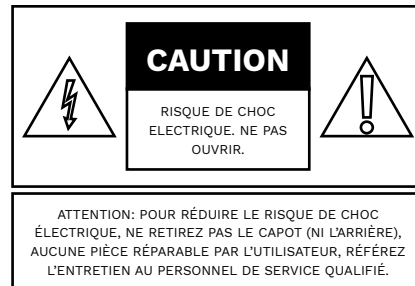

Avvertissements:

N'immergez pas la barre de son d'extérieur Séura® dans l'eau : la barre de son d'extérieur Séura® résistera à l'exposition à l'eau de la pluie normale, des arroseurs, de la neige, etc. ; cependant, il n'est pas conçu pour être immergé dans l'eau.

Ne pas laver avec un tuyau d'arrosage ou un lavage à pression : la barre de son d'extérieur Séura® résistera à l'exposition à l'eau de la pluie normale, des arroseurs, de la neige, etc. ; cependant, il n'est pas conçu pour résister aux nettoyeurs haute pression, aux jets d'eau à haute pression, à la neige projetée par une souffleuse ou aux intempéries de type ouragan.

Ne laissez pas de pièces métalliques ou d'objets de quelque nature que ce soit tomber dans la barre de son. Une haute tension circule dans le produit et l'insertion d'un objet peut provoquer un choc électrique et/ou un court-circuit des pièces internes.

Pour éviter les incendies, ne placez jamais de bougies ou de flammes sur le dessus ou à proximité de la barre de son.

AVERTISSEMENTS

Pour réduire le risque d'incendie, de choc électrique et d'autres blessures, garder ces consignes de sécurité à l'esprit lors de l'installation, l'utilisation et l'entretien de votre moniteur en plein air. La prise de courant doit être installée près de l'équipement et être facilement accessible. Le moniteur doit être relié à une prise de courant avec terre protégé par disjoncteur différentiel.

ATTENTION: Si vous manipulez contre l'utilisation recommandée, des blessures graves ou la mort à l'utilisateur peuvent en résulter.

Important Safety Instructions

1. Read these instructions.
2. Keep these instructions.
3. Heed all warnings.
4. Follow all instructions.
5. Do not use this product for other than intended use.
6. Close adult supervision is necessary when any product is used by or near children.
7. Only use the attachments/accessories specified by the manufacturer.
8. Use only with the bracket specified by the manufacturer or sold with the apparatus.
9. To prevent injury, this apparatus must be securely attached to a TV or wall in accordance with the installation instructions.
10. This Séura product is intended for use indoors and outdoors.
11. This product is water resistant. Do not immerse this product in water.
12. To reduce the risk of fire or electric shock, do not expose the inside of this apparatus to rain or moisture.
13. Do not use or place any combustible or flammable substances near the product.
14. Unplug this apparatus during lightning storms or when unused for long periods of time. Do not touch this apparatus, antenna, power cables, or power plugs during a thunder or lightning storm.
15. Do not touch the power plugs with wet hands.
16. Protect the power cord from being walked on or pinched particularly at plugs, convenience receptacles, and the point where they exit from the apparatus.
17. Inspect the desired location for installation and be aware of all electrical wiring pathways, water pipes, gas lines, or other potentially hazardous conditions that may exist to protect from accidental damage during creation of on-site conditions.
18. Do not install the device near any heat sources such as radiators, heating pipes, heaters, furnaces or other devices (including amplifiers) that produce heat.
19. Adequate ventilation must be maintained to ensure reliable and continued

operation and to protect the product from overheating.

20. Do not mount this product near a motor or transformer where strong magnetism is generated.



21. Do not place the product on an unstable place. Improper installation may cause the product to fall, resulting in potential serious personal injuries, as well as damage to the product. Follow mounting instructions properly for safe operation of the product.
22. Do not move or transport the product with any cables (power cables, content connectivity cables) plugged in to the source devices. Damages may occur to the cables, plugs, or joining connectors of the cables due to forcible bending and stress, which may cause damages to the waterproof seal of the product, making it subject to fire, electric shock, or shorted circuit.
23. It is REQUIRED that this product is plugged into an electrical outlet protected by a Ground Fault Circuit Interrupter (GFCI) to protect against electric shock, fire, and/or injury. Failure to do so will void any warranty for this product.
24. The cable distribution system should be grounded (earthed) in accordance with ANSI/NFPA 70, the National Electrical Code (NEC), Section 820.93, Grounding of Outer Conductive Shield of a Coaxial Cable.
25. The apparatus shall be connected to a MAINS socket outlet with a protective earthing connection. Where the MAINS plug or an appliance coupler is used as the disconnect device, the disconnect device shall remain readily operable.
26. The disconnect device shall remain readily operable.
27. The socket-outlet shall be installed near the equipment and shall be easily accessible.
28. Do not defeat the safety purpose of the polarized or grounding type plug. A polarized plug has two blades with one wider than the other. A grounding

type plug has two blades and a third grounding prong. The wide blade or the third prong is provided for your safety. When the provided plug does not fit into your outlet, consult an electrician for replacement of the obsolete outlet.

29. Use properly rated power voltage. Use of non-rated voltage may cause fire, electric shock and severe damages to the product.
30. Do not overload AC outlets or extension cords. Overloading can cause fire or electric shock.
31. Ensure all required electrical specifications are adhered to and have been installed by the appropriate individuals and are code approved.
32. Ensure all framing requirements, if needed, have been completed to building code and pose no structural issues.
33. Do not operate any product with a damaged cord or plug or operate it after the appliance malfunctions or has been damaged in any manner.
34. To electrically disconnect the product, turn OFF the product, then remove the electrical power plug from the outlet.
35. Any severe physical impact on the product may cause certain components to fall out of place within and break, which may cause fire or electric shock. In such event, do not operate the product. Contact the manufacturer for support.
36. If you notice any smoke or scorched smell near the product, immediately turn off and unplug the power cord and refer to qualified personnel for service and/or repair.
37. Only qualified individuals should attempt to service the product. Removing covers can expose you to high voltage and other dangerous conditions.
38. Refer all servicing to qualified service personnel. Servicing is required when the apparatus has been damaged in any way, such as objects have fallen into the apparatus, the apparatus does not operate normally, or the apparatus has been dropped.

Consignes De Sécurité Importantes

1. Lisez ces instructions.
2. Conservez ces instructions.
3. Tenez compte de tous les avertissements.
4. Suivez toutes les instructions.
5. N'utilisez pas ce produit pour un usage autre que celui prévu.
6. La surveillance étroite d'un adulte est nécessaire lorsqu'un produit est utilisé par ou à proximité d'enfants.
7. N'utilisez que les pièces jointes/accessoires spécifiés par le fabricant.
8. Utiliser uniquement avec le support spécifié par le fabricant ou vendu avec l'appareil.
9. Pour éviter les blessures, cet appareil doit être solidement fixé à un téléviseur ou à un mur conformément aux instructions d'installation.
10. Ce produit Séura est destiné à une utilisation en intérieur et en extérieur.
11. Ce produit est résistant à l'eau. Ne plongez pas ce produit dans l'eau.
12. Pour réduire le risque d'incendie ou de choc électrique, n'exposez pas l'intérieur de cet appareil à la pluie ou à l'humidité.
13. Ne pas utiliser ou placer de substances combustibles ou inflammables à proximité du produit.
14. Débrancher cet appareil pendant les orages ou lorsqu'il n'est pas utilisé pendant de longues périodes. Ne touchez pas cet appareil, l'antenne, les câbles d'alimentation ou les prises d'alimentation pendant un orage ou un orage.
15. Ne touchez pas les fiches d'alimentation avec les mains mouillées.
16. Protégez le cordon d'alimentation contre tout piétement ou pincement, en particulier au niveau des fiches, des prises de courant et du point de sortie de l'appareil.
17. Inspectez l'emplacement souhaité pour l'installation et soyez conscient de tous les chemins de câblage électrique, conduites d'eau, conduites de gaz ou autres conditions potentiellement dangereuses qui peuvent exister pour protéger contre les dommages accidentels lors de la création de conditions sur site.
18. N'installez pas l'appareil à proximité de sources de chaleur telles que des radiateurs, des tuyaux de chauffage, des radiateurs, des fours ou d'autres appareils (y compris des

amplificateurs) qui produisent de la chaleur.

19. Une ventilation adéquate doit être maintenue pour assurer un fonctionnement fiable et continu et pour protéger le produit contre la surchauffe.
20. Ne montez pas ce produit à proximité d'un moteur ou d'un transformateur où un fort magnétisme est généré.
21. Ne placez pas le produit sur un endroit instable. Une mauvaise installation peut provoquer la chute du produit, ce qui peut entraîner des blessures graves potentielles, ainsi que des dommages au produit. Suivez correctement les instructions de montage pour un fonctionnement sûr du produit.
22. Ne déplacez ou ne transportez pas le produit avec des câbles (câbles d'alimentation, câbles de connectivité de contenu) branchés sur les périphériques sources. Des dommages peuvent survenir aux câbles, aux fiches ou aux connecteurs de jonction des câbles en raison d'une flexion forcée et d'une contrainte, ce qui peut endommager le joint étanche du produit, le rendant sujet à un incendie, un choc électrique ou un court-circuit.
23. Il est OBLIGATOIRE que ce produit soit branché sur une prise électrique protégée par un disjoncteur de fuite à la terre (GFCI) pour se protéger contre les chocs électriques, les incendies et/ou les blessures. Ne pas le faire annulera toute garantie pour ce produit.
24. Le système de distribution par câble doit être mis à la terre conformément à la norme ANSI/NFPA 70, National Electrical Code (NEC), Section 820.93, Grounding of Outer Conductive Shield of a Coaxial Cable.
25. L'appareil doit être connecté à une prise de courant SECTEUR avec une connexion à la terre de protection. Lorsque la prise SECTEUR ou un coupleur d'appareil est utilisé comme dispositif de déconnexion, le dispositif de déconnexion doit rester facilement utilisable.
26. Le dispositif de déconnexion doit rester facilement utilisable.
27. La prise de courant doit être installée à proximité de l'équipement et doit être facilement accessible.



28. N'allez pas à l'encontre de l'objectif de sécurité de la prise de type polarisée ou mise à la terre. Une fiche polarisée à deux lames dont l'une est plus large que l'autre. Une prise de type mise à la terre à deux lames et une troisième broche de mise à la terre. La lame large ou la troisième broche est fournie pour votre sécurité. Lorsque la fiche fournie ne rentre pas dans votre prise, consultez un électricien pour le remplacement de la prise obsolète.
29. Utilisez une tension d'alimentation correctement évaluée. L'utilisation d'une tension non nominale peut provoquer un incendie, un choc électrique et de graves dommages au produit.
30. Ne surchargez pas les prises secteur ou les rallonges. Une surcharge peut provoquer un incendie ou un choc électrique.
31. Assurez-vous que toutes les spécifications électriques requises sont respectées et ont été installées par les personnes appropriées et sont approuvées par le code.
32. Assurez-vous que toutes les exigences de charpente, si nécessaire, ont été remplies conformément au code du bâtiment et ne posent aucun problème structurel.
33. N'utilisez pas un produit avec un cordon ou une fiche endommagés ou ne l'utilisez pas après un dysfonctionnement de l'appareil ou a été endommagé de quelque manière que ce soit.
34. Pour déconnecter électriquement le produit, éteignez le produit, puis retirez la fiche d'alimentation électrique de la prise.
35. Tout impact physique grave sur le produit peut entraîner le déplacement et la rupture de certains composants, ce qui peut provoquer un incendie ou un choc électrique. Dans un tel cas, n'utilisez pas le produit. Contactez le fabricant pour obtenir de l'aide.
36. Si vous remarquez de la fumée ou une odeur de brûlé à proximité du produit, éteignez et débranchez immédiatement le cordon d'alimentation et contactez un personnel qualifié pour l'entretien et/ou la réparation.
37. Seules les personnes qualifiées devraient essayer de réparer le produit. Le retrait des couvercles peut vous exposer à haute tension et d'autres conditions dangereuses.
38. Adressez-vous à un personnel qualifié. Un entretien est nécessaire lorsque l'appareil a été endommagé de quelque manière que ce soit, comme des objets sont tombés dans l'appareil, l'appareil ne fonctionne pas normalement ou l'appareil est tombé.

FCC Supplier's Declaration of Conformity

Séura Outdoor 80W Soundbar
SSB-1, SSB-2



This device complies with part 15 of the FCC Rules. Operation is subject to the follow two conditions: (1) This device may not cause harmful interference, and (2) this device must accept any interference received, including interference that may cause undesired operation.

Séura
Address: 1230 Ontario Road, Green Bay, WI 54301 United States
Phone number: 920-857-9069

Caution: The user is cautioned that changes or modifications not expressly approved by the party responsible for compliance could void the user's authority to operate the equipment.

Note: This equipment has been tested and found to comply with the limits for a Class B digital device, pursuant to part 15 of the FCC Rules. These limits are designed to provide reasonable protection against harmful interference in a residential installation. This equipment generates uses and can radiate radio frequency energy and, if not installed and used in accordance with the instructions, may cause harmful interference to radio communications. However, there is no guarantee that interference will not occur in a particular installation. If this equipment does cause harmful interference to radio or television reception, which can be determined by turning the equipment off and on, the user is' encouraged to try to correct the interference by one or more of the following measures:

- Reorient or relocate the receiving antenna.
- Increase the separation between the equipment and receiver.
- Connect the equipment into an outlet on a circuit different from that to which the receiver is connected
- Consult the dealer or an experienced radio/TV technician for help.

This equipment complies with FCC radiation exposure limits set forth for an uncontrolled environment. This equipment should be installed and operated with a minimum distance of 20 cm between the radiator and any part of your body.



WARNING: Cancer and Reproductive Harm: www.p65warnings.ca.gov.

Specifications of this product are subject to unannounced changes; this manual may thus not reflect the current technical status.

Spécifications de ce produit sont sujettes à modifications sans préavis; ce manuel ne peut donc pas tenir compte de l'état de la technique actuelle.

Get to know your Séura® Outdoor Soundbar

Audio Sources

The Séura 80W Outdoor Soundbar is an amplified soundbar that has been designed to provide best-in-class sound for Séura Outdoor TVs. The soundbar uses a 3.5mm input jack dependent on a variable audio input similar to a standard headphone jack. Since there is no independent volume control on the soundbar, the audio output device requires volume control. Devices such as cell phones, MP3 players, etc. that would normally have a connection for headphones would also be capable of connecting to the Séura soundbar. Other audio sources that have fixed audio outputs and would typically be connected to an audio amplifier are not compatible.

Power Source

The 80W Outdoor Soundbar is designed for use with 100-240 volt, 50-60 Hz, 80W peak AC current.

WARNING: The power cable connection does not have a watertight seal and cannot be connected to an outlet exposed to the outdoors. The power cable from the soundbar may be connected to the power outlet inside of a Séura TV's weatherproof media compartment or to a GFCI protected AC outlet with an "in-use" waterproof cover.

Get to know your Séura® Outdoor Soundbar

Selecting the Installation Location

Installation over a gas fireplace is acceptable if the distance from the heat source is such that the air temperature surrounding the display does not exceed the maximum operating temperature. A mantle or other heat shield is recommended to further protect the display from heat. Installation over a wood fireplace or near heaters or blowers is not recommended and may result in damage to the electronics. The soundbar is not for installation in a sauna or directly above a hot tub where extreme heat and steam could damage the electronics. If you have questions about your situation, you may call Séura at 1-800-957-3872 to speak to a design expert.

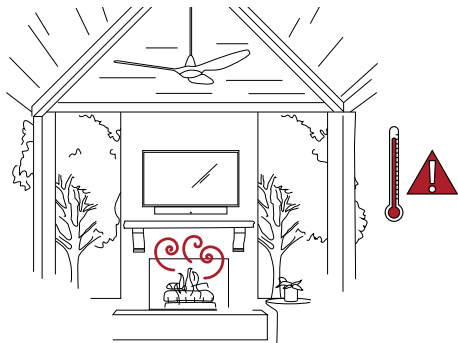

Operation and Storage Requirements

The temperature range for operating the device is -40°F to 140°F. Installation in sunlight may make the product temperature higher than the outdoor air temperature. The required storage temperature is -40°F to 140°F at an air humidity of 10 - 90% RH non-condensing. The device must be stored in the complete packaging, as delivered. The product must have proper, correct and sufficient AC supply voltage.

Parts Included

- Soundbar
- Power Cable (pre-installed to soundbar)
- 3.5mm RCA Cable (pre-installed to soundbar)
- Two soundbar mounting brackets – short (for 50-inch and smaller Séura TVs)
- Two soundbar mounting brackets – long (for 55-inch and larger Séura TVs)
- Two 4-inch strips of VHB tape (for optional use)
- Ten M6 screws (includes six extras)
- Two wall mounting brackets (only needed if mounting soundbar to a wall)
- Six 6-32 screws, 5/16-inch in length (only needed if mounting soundbar to a wall)
- Ten 6-32 screws, 11/32-inch in length (extra screws for mounting gasket plate over the input bay on the soundbar); the plate is pre-installed, so these screws are extra replacements if needed
- 5mm Allen Wrench
- Resource Information

Parts NOT Included

- TV mounting brackets (sold separately)
- Four M8 screws (for attaching Soundbar Mounting Brackets to Séura Full Sun Series Outdoor TVs) Note: VESA screws to mount the soundbar to the TV are included with Séura Shade Series 2™ Outdoor TVs and Séura outdoor mounts.
- Screws and anchors (for mounting soundbar to a wall via keyhole slot on wall mounting brackets)

Tools Needed

- Philips #2 Screwdriver
- Level (for mounting soundbar to a wall)
- Pencil (for mounting soundbar to a wall)

Installation Option 1

Mount to Bottom of Séura Outdoor TV

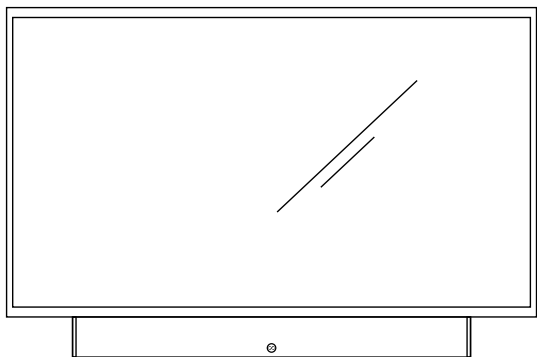

Step 1: Prep for Installation

- Lay the TV face down on a soft, clean surface. Position the soundbar face down along the bottom edge of the TV. Take caution not to lay the TV on a surface that will scratch or damage the screen.

WARNING: Ensure the Séura display is properly supported on a flat surface at least as large as the display. Pressure on the front of the panel may damage the unit.

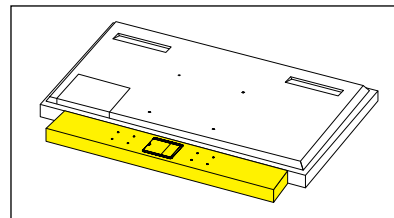

- The Very High Bond (VHB) adhesive strips provide additional stability between the soundbar and the TV. This bond is permanent and optional to use. On both VHB strips, remove the backing from one side and attach the tape to the bottom of the television. Each strip should be placed on the thin bottom edge of the TV and positioned a few inches from the side of the TV.

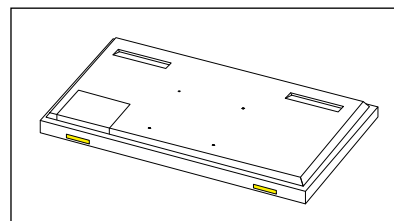

- Included in each of the four VESA holes on the back of the TV are factory screws. Use a Philips #2 screwdriver to remove these screws.

Note: The VESA screws on Full Sun Series TVs are not long enough to attach the soundbar brackets (in step 2). If mounting the TV with a Séura Outdoor Mount, then use the screws provided with the mount and you can save these VESA screws for a future project as you won't need them for this installation.

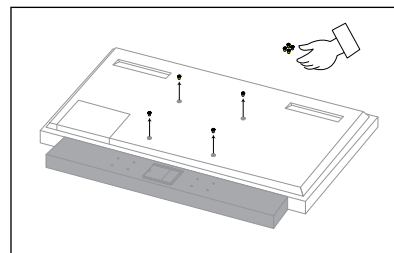

Step 2: Attach the soundbar mounting brackets to the TV

- Lay the soundbar mounting brackets on the back of the TV and soundbar. Use the shorter set of soundbar mounting brackets for 50-inch and smaller Séura TVs. Use the longer set of soundbar mounting brackets for 55-inch and larger Séura TVs. The VESA holes on the TV and holes on the soundbar should line up with the holes on the soundbar mounting brackets. Extra holes on the back of the soundbar are for mounting to other TV sizes and will be unused.

Helpful hint: Each soundbar mounting bracket is labeled with one side that says “This Side Away From TV” which is the side that does not touch the TV. Reference the arrows on the label that indicates the direction the bars should face.

- Use four M6 screws and the Allen wrench to loosely screw the soundbar mounting brackets to the soundbar. Lift the soundbar up slightly to align it when doing this. Do not tighten. Leave the screws loose so you can properly align the soundbar later.
- Place the TV mounting brackets (sold separately) on top of the soundbar mounting brackets. Reference your TV mount installation instructions to ensure proper placement. Use four M8 screws or the VESA screws that came with your TV mount (see note) and a Philips #2 screwdriver to screw the TV mount brackets and soundbar mounting brackets tight to the TV.

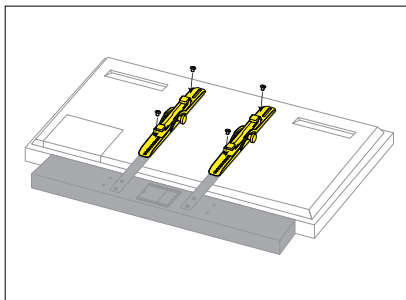
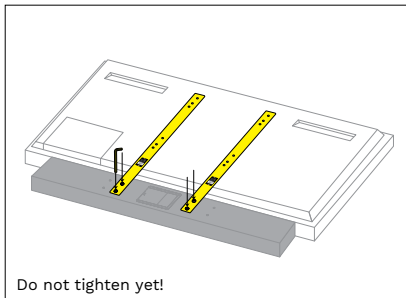

NOTE: If using a Séura Outdoor Mount, use the hardware included with the Séura mount. If using a competitor's mount, use screws that are long enough to fit through the TV mount brackets and soundbar mounting brackets and into the VESA holes, but not too long where it won't tighten the brackets to the TV.

Step 3: Attach the soundbar to the TV

- (Optional) Remove the backing on the VHB tape.

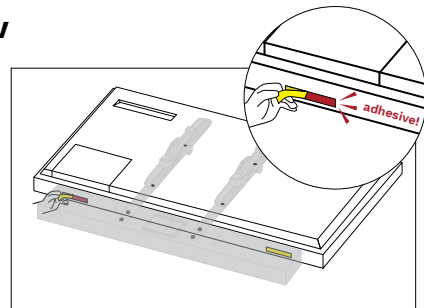

- Slide the soundbar so it touches the bottom of the TV and is flush with the vertical bars.
- (Optional) Firmly apply pressure to the soundbar against the TV edge to fully engage the VHB tape.

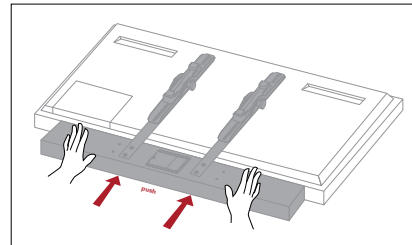

- Use the Allen wrench to fully tighten the four M6 screws to hold the soundbar to the soundbar mounting brackets.



Step 4: Make AV connections

1. Unscrew the thumb screws on the AV compartment on the back of the TV to open it. Plug the 3.5mm RCA cable from the soundbar into the Line Out port on the TV. Plug the power cable from the soundbar into the power outlet on the TV.

WARNING: The power cable from the soundbar must be connected to the power outlet inside of the TV's weatherproof media compartment. The power cable connection does not have a watertight seal and cannot be connected to an outlet exposed to the outdoors.

2. Neatly coil up any excess wires into the AV compartment of the TV. Route the wires so they exit the media compartment by the foam gasket.
3. Close the AV compartment lid and tighten the screws.

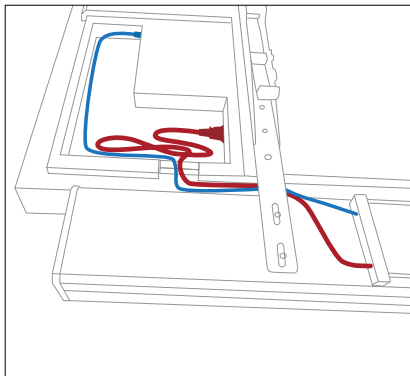

Installation Option 2 Mount to a Wall

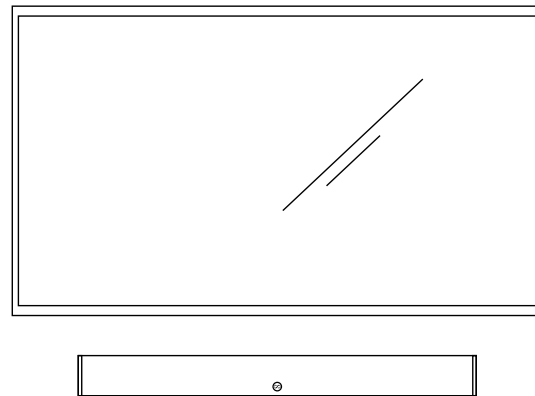

Congratulations! Your soundbar is attached and connected to the TV!
Please refer to the mount installation instructions to complete mounting your TV.

Step 1: Identify wall mounting location.

Mark the wall where you want to hang the soundbar. Using a level and a pencil, mark two holes 23.9" apart for soundbar model SSB-1 or 30.2" apart for soundbar model SSB-2. When installed, the top of the soundbar will sit approximately 2.5" higher than the screw location. The bottom of the soundbar will be approximately 3.0" lower than the screw location.

Step 2: Attach wall mounting hardware.

Wall mounting hardware is not included. Drill anchors and screws that support the weight of the soundbar into the wall. The keyhole slots on the two wall mounting brackets will be used to hang the soundbar on the wall.

Step 3: Attach the two wall mounting brackets to the soundbar.

Each bracket has three tiny holes to screw through. Use the provided six 6-32 screws and Philips #2 screwdriver to tighten the wall mounting brackets to the soundbar.

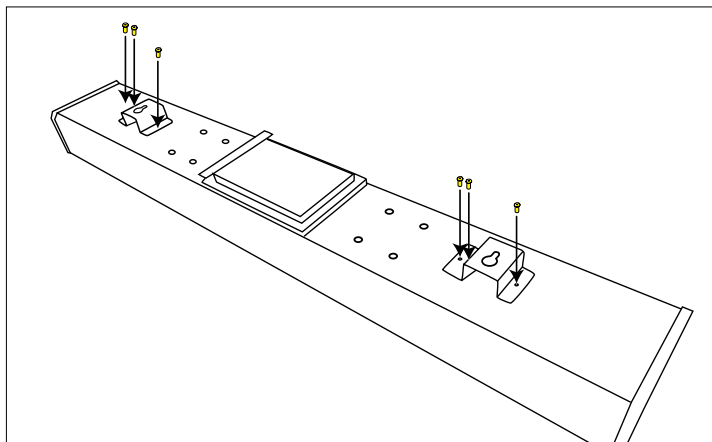

Step 4: Make AV connections.

Connect the 3.5mm RCA cable from the soundbar to the Line Out port on the TV. Connect the power cord from the soundbar to a GFCI protected AC outlet with an "in-use" waterproof cover. The 80W Outdoor Soundbar is designed for use with 100-240 volt, 50-60 Hz, 80W peak AC current.

WARNING: The power cable connection does not have a watertight seal and cannot be connected to an outlet exposed to the outdoors.

Operating Instructions

The Séura Outdoor Soundbar powers on and off with the TV. Seamlessly integrated with display controls, the TV remote control operates all features via the display menu including volume, mute, sound profiles, etc.

Caring for your Séura Soundbar

Use of a Séura Outdoor Cover when not in use is recommended to keep your outdoor TV and soundbar clean and dry.

To care for the soundbar, clean regularly by gently wiping the surface of the front grill and cabinet with a clean, damp microfiber cloth. A water and mild detergent solution can be used to remove dust and debris when rinsed with a clean damp microfiber cloth. Gently dry the soundbar by wiping the surface of the front grill and cabinet with a clean, dry microfiber cloth to prevent water staining.

Cleaning with an abrasive cloth or using strong force may scratch the surface of the cabinet and grill. Do not use solvents or chemical cleaners as they may damage the cabinet or grill. Do not apply insecticides or other volatile liquids on the soundbar. Do not use a garden hose or pressure washer on the unit. Do not use higher pressure air to blow out the speaker grill or cabinet.

Troubleshooting

If the product is not working properly, please check the following troubleshooting solutions before you contact customer service:

Challenge	Possible Solution
No Sound	<ul style="list-style-type: none">• Make sure the soundbar is connected to the power supply• Make sure your cables are connected properly• Make sure the TV connected to the Soundbar is powered on• Make sure the display is not on MUTE / turn up the volume
Distorted Sound	<ul style="list-style-type: none">• Ensure the 3.5mm audio plug is fully inserted

For potential issues related to the TV, such as no TV power, remote control not working, and TV signal issues, reference your TV product manual for troubleshooting solutions.

For additional technical support, please contact Séura at **1-800-957-3872** during regular business hours: M-F 8:00 am – 4:30 pm, Central Time.

Control Documentation

To access current control documents for compatible Séura products, please visit www.seura.com/download-center

LIMITED PRODUCT WARRANTY

For information regarding Séura's warranty policy, please visit our website: www.seura.com/warranty. If the current Séura warranty policy is after your product purchase date, please contact Séura Customer Support to request warranty documentation from the date of your purchase.

For additional customer support, please contact Séura.
Toll Free: 1-800-957-3872 (Monday - Friday 8:00 am – 4:30 pm, Central Time)

Website: www.seura.com/support

For responsible recycling information, please contact Séura or visit the following URL:

<https://www.seura.com/support/recycling/>



1230 Ontario Road Green Bay, Wisconsin 54311
1-800-957-3872 contacts@seura.com
www.seura.com

Publish date: July 24, 2023
Information is subject to change without notice.

© 2021 Séura