



USER MANUAL

Hydra™ Indoor Waterproof Television

19-INCH AND 27-INCH TVS

MODEL NUMBER

IWT-19.6
IWT-27.6

WARRANTY REGISTRATION

**REGISTER FOR
EXTRA BENEFITS**

Activate within 30 days of purchase:
seura.com/activate

WWW.SEURA.COM

CONTENTS

Specifications	3
Safety Warnings.....	4-5
2-Part Product Anatomy.....	6
Display Requirements	7
Setup	8
Input/Output Overview	8
Remote Control Functions.....	8
Installation.....	9-12
Making Connections	13
On Screen Display Menu (OSD).....	14-17
Input Source Selection.....	14
Video Settings.....	14
Advanced Video Settings.....	15
Audio Settings.....	15
TV Settings.....	16
Setup Menu	16
Parental Menu.....	17
Media Support	18
Troubleshooting.....	18
Control.....	19
RS-232 Settings and IR Commands.....	19
Warranty.....	19

Specifications

		19 INCH TV Model: IWT-19, Version: 6	27 INCH TV Model: IWT-27, Version: 6
GENERAL	PROTECTIVE GLASS	Tempered safety glass	
	STORAGE TEMPERATURE RANGE	32°F to 140°F	
	OPERATING TEMPERATURE RANGE	41°F to 122°F	
	STORAYGE HUMIDITY RANGE	5–85% RH, non-condensing	
	OPERATING HUMIDITY RANGE	0–100% RH, non-condensing	
VIDEO	VIEWABLE SCREEN SIZE	15.9" w x 9.8" h	23.4" w x 13.1" h
	SCREEN SIZE (DIAGONAL)	18.7"	26.8"
	DISPLAY TYPE	LED Backlit TN/TFT LCDX	
	BRIGHTNESS	450 cd/m2	450 cd/m2
	DISPLAY RESOLUTION	1440 x 900	1920 x 1080
	ASPECT RATIO	16:10	16:9
	CONTRAST RATIO	3000:1	3000:1
	REFRESH RATE	60Hz	60Hz
	VIEWING ANGLE	178° Horiz/Vert	178° Horiz/Vert
	RESPONSE TIME	5ms	5ms
TUNER	Digital: ATSC / ATV: NTSC	Digital: ATSC / ATV: NTSC	
INTEGRATION	HDMI	2 x Type A HDMI 2.0 HDCP 2.2	2 Type A x HDMI 2.0 HDCP 2.2
	COMPONENT YPBPR	1 x Component YPbPr (RCA plugs), dongle included†	1 x Component YPbPr (RCA plugs), dongle included†
	COMPOSITE (AV)	1 x Composite Video, Audio L, Audio R (RCA plugs), dongle included†	1 x Composite Video, Audio L, Audio R (RCA plugs), dongle included†
	VGA	1 x VGA 15-pin D-sub Female	1 x VGA 15-pin D-sub Female
	S-VIDEO	1 x S-Video Mini 4-pin DIN	1 x S-Video Mini 4-pin DIN
	RF COAXIAL ANTENNA	1 x 75 Ohm Coaxial Antenna	1 x 75 Ohm Coaxial Antenna
	USB	1 x Type A, Firmware & 5V Only	1 x Type A, Firmware & 5V Only
	RS-232	1 x 9-pin DB9 Female, 2.5mm connector, dongle included†	1 x 9-pin DB9 Female, 2.5mm connector, dongle included†
IR	1 x 3.5mm Input (Mono), 4 x 3.5mm Output (Mono)	1 x 3.5mm Input (Mono), 4 x 3.5mm Output (Mono)	
AUDIO	PC AUDIO IN	1	1
	LINE OUT	2 x 3.5mm Jack (1 powered, 1 unpowered*)	2 x 3.5mm Jack (1 powered, 1 unpowered*)
	PHOENIX TYPE SPEAKER OUTPUT	2 x 5W @ 8Ω/channel	2 x 5W @ 8Ω/channel
	AMPLIFIED OUTPUT	Terminal Block	Terminal Block
	INTERNAL SPEAKERS	None	None
INSTALLATION	PRODUCT DIMENSIONS	19" w x 13 1/4" h x 3 3/16" d	28" w x 17 3/4" h x 3" d
	ROUGH OPENING SIZE	18 1/2" w x 12 7/8" h	27 1/8" w x 16 7/8" h
	COMPATIBLE BACK BOX AND POWER CABLE	BB-19 with 50' Low-Voltage Power Cable	BB-27 with 50' Low-Voltage Power Cable
OTHER	CERTIFICATIONS AND COMPLIANCE	FCC, CEC, UL and cUL listed,	
	WARRANTY	Séura's labor for three (3) years; glass, structure, frame, and assembly for three (3) years; TV including remote and power supply for two (2) years	
	REMOTE	Séura IR Remote Control	
	INPUT POWER	110-240 VAC, 50-60HZ, 1.5A Type A NEMA plug, requires GFCI protected outlet	
	POWER CONSUMPTION, DISPLAY	DC 19V 40W / .33A	DC 19V 50W / .42A
	COMPATIBLE BACK BOX AND POWER CABLE	BB-19	BB-27

* The unpowered audio variable line out will cut audio from the speaker output.
† Mini jack connection on TV, product includes adapter cables

Back box and power cable sold separately. Back box and cable are required for all Hydra Indoor Waterproof TVs.

Thank you for selecting a Séura Indoor Waterproof Television. This product has been inspected and packaged carefully before shipment. Please read this guide before beginning installation.

Please keep this manual for future reference.

Information in this manual is subject to change without prior notice.

FCC Information

This equipment has been tested and found to comply with limits for a class B digital device, pursuant to Part 15 of the FCC Rules. These limits are designed to provide reasonable protection against harmful interference in a residential installation.

This equipment generates, uses, and radiates radio frequency energy and, if not installed and used in accordance with the instructions, may cause harmful interference to radio communications.

There is no guarantee that interference will not occur in a particular installation. If this equipment causes unacceptable interference to radio and television reception, which can be determined by turning the equipment off and on, the user is encouraged to try to correct the interference by one or more of the following measures.

- Reorient or relocate the receiving antenna.
- Increase the separation between the equipment and receiver.
- Connect the equipment into an outlet on a circuit different from that to which the receiver is connected.

Consult the dealer or an experienced Radio/TV technician for additional help.



ETL LISTED

CONFORMS TO
UL STD. 60065.

CERT. TO CAN/
CSA STD. C22.2
NO. 60065.



WARNINGS

To reduce the risk of fire, electrical shock and other injuries, keep these safety precautions in mind when installing, using, and maintaining your television. The socket-outlet should be installed near the equipment and be easily accessible. The TV should be connected to a grounded GFCI protected main socket outlet.

WARNING: If you manipulate against the recommended usage, serious injury or death to user may result.

To protect against electric shock, do not immerse the power cord, power plug, or product in water or other liquid.

Do not overload AC outlets or extension cords. Overloading can cause fire or electric shock.

Close adult supervision is necessary when any product is used by or near children.

Do not operate any product with a damaged cord or plug or operate it after the appliance malfunctions or has been damaged in any manner.

Do not use the product close to any heat sources such as radiators, heat registers, stoves, or other products that produce heat.

Do not let the power cord come in contact with hot surfaces.

If you notice any smoke or scorched smell near the product, unplug power cord and refer to qualified personnel for service and/or repair.

Do not use or place any combustible or flammable substances near the product.

To electrically disconnect the product, turn OFF the product, then remove the electrical power plug from the outlet.

Do not place heavy articles on or step on the product.

Do not place the product on an unstable cart, stand, tripod or table.

Do not use this product for other than intended use.

This Séura product is only intended for use indoors.

For added safety during a lightning storm, or when this product is left unattended and unused for long periods of time, unplug it from the wall outlet and disconnect the antenna.

NOTE: THE POWER SUPPLY MUST NOT BE MOUNTED INSIDE A WALL CAVITY.

Specifications of this product are subject to unannounced changes; this manual may thus not reflect the current technical status.



WARNING: READ ALL INSTRUCTIONS BEFORE ATTEMPTING TO INSTALL OR SERVICE THIS PRODUCT.

When installing and during use of this product, basic safety precautions should always be followed to reduce the risk of fire, electric shock and/or injury to persons including the following:

- Inspect the desired location for installation and be aware of all electrical wiring pathways, water pipes, gas lines, or other potentially hazardous conditions that may exist to protect from accidental damage during creation of on-site conditions.
- Ensure all required electrical specifications are adhered to and have been installed by the appropriate individuals and are code approved.
- Ensure all framing requirements, if needed, have been completed to building code and pose no structural issues.
- It is REQUIRED that this product is plugged into an electrical outlet protected by a Ground Fault Circuit Interrupter (GFCI) to protect against electric shock, fire, and/or injury. Failure to do so will void any warranty for this product.
- Only qualified individuals should attempt to service the product. Removing covers can expose you to high voltage and other dangerous conditions.
- Retain this manual in a safe place for future reference.

Safety Warning

Never place a television set in an unstable location. A television set may fall, causing serious personal injury or death. Many injuries, particularly to children, can be avoided by taking simple precautions such as:

- Using cabinets or stands recommended by the manufacturer of the television set.
- Only using furniture that can safely support the television set.
- Ensuring the television set is not overhanging the edge of the supporting furniture.
- Not placing the television set on tall furniture (for example, cupboards or bookcases) without anchoring both the furniture and the television set to a suitable support.
- Not placing the television set on cloth or other materials that may be located between the television set and supporting furniture.
- Educating children about the dangers of climbing on furniture to reach the television set or its controls.

If your existing television set is being retained and relocated, the same considerations as above should be applied.

2-Part Product Anatomy

BACK BOX

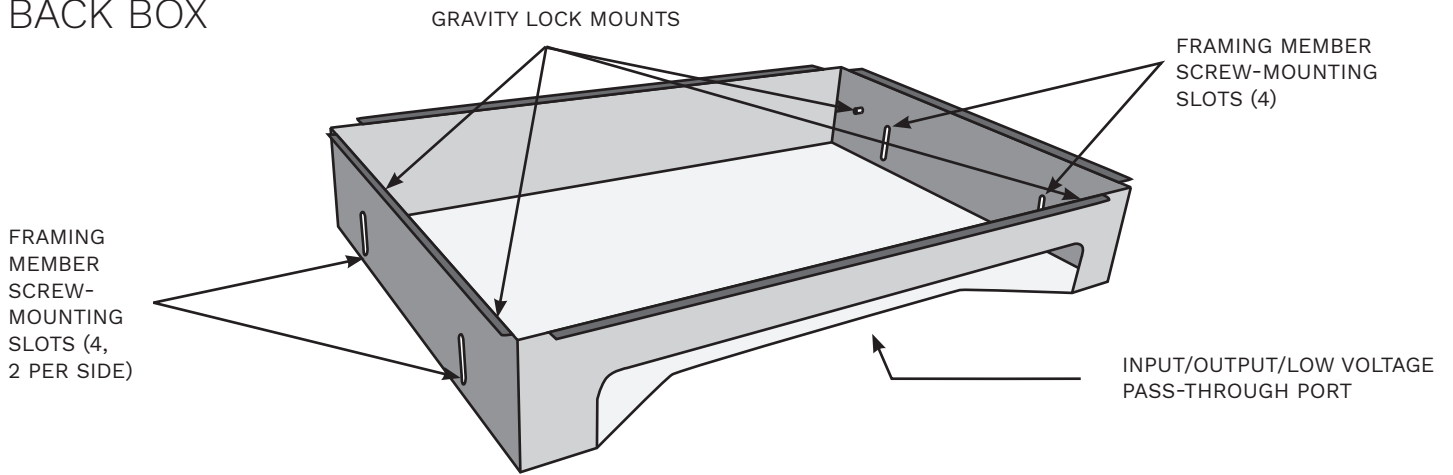

TV ASSEMBLY

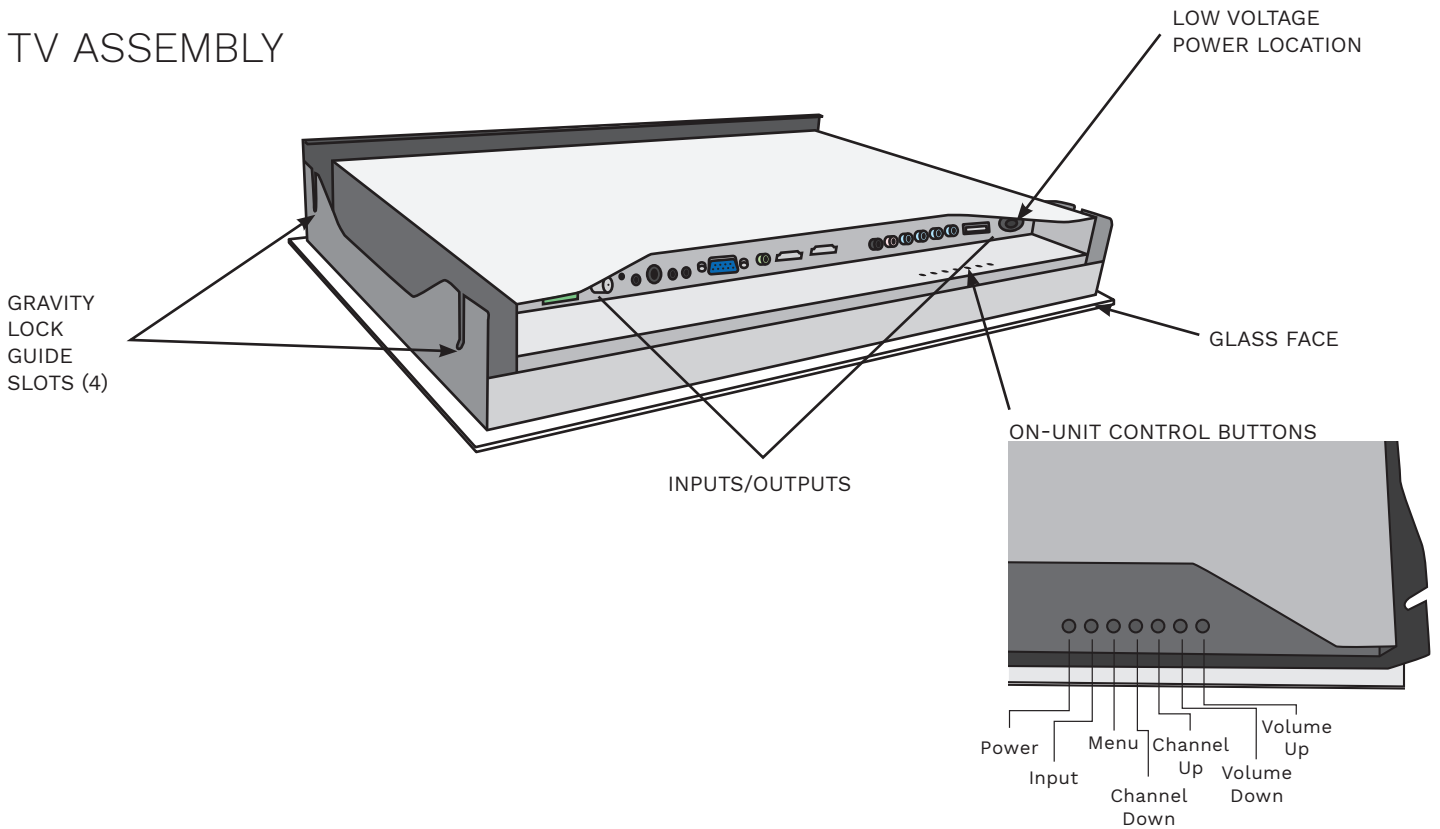

Note: Buttons are labeled on product. 19" shown. Buttons are located on the side of the unit on the 27" model.

Display Requirements

Operation and Storage Requirements

The temperature range for operating the device is 41° F to 122° F. Do not install the device in the proximity of heat sources, such as heating pipes, heaters, furnaces or other devices that radiate heat. Mount the device in such a way that it is protected against moisture. Trouble free operation is ensured up to 100% air humidity. To prevent fire or electric shock, never allow liquids to enter the unit. The product must be stored in dry and well-ventilated rooms, without extreme temperature fluctuations. Heat sources and aggressive active substances may not be stored in the proximity of the device. The required storage temperature range is 32° F to 140° F at an air humidity of 5% to 85% RH non-condensing. The device must be stored in the complete packaging, as delivered. The product must not operate on average more than twelve (12) hours per day on a permanent or extended periodic basis. The product must have proper, correct and sufficient AC supply voltage.

Installation Environment

Avoid direct light or sun exposure, direct proximity to heat sources, and outdoor installation. The product is specifically designed for indoor use only. There is the danger of fire and of electric shock and damage to the device if it is operated outdoors. Do not place any heat sources such as radiators and heat registers, etc. near the monitor. To reduce eye strain, avoid installing the Séura television against a bright background such as a window. Position the monitor at the height of your eye level. Position the monitor directly in front of you at a comfortable viewing distance.

Installation

Have this product installed by qualified personnel only. Use the mounting systems which are specified or recommended by Séura. Install the product in a way that it is fixed properly and take care that children are not exposed to danger. Please take extra care during installation to avoid impacts. Before cabling your monitor, check that the power is off. To avoid any possibility of electric shock, always connect your equipment to properly grounded outlets. Use of power cords or adapters other than those provided may cause fire or malfunction. Place this product as close to the power socket as possible. Leave enough space to insert and remove the power plug on demand. Even if you switch off the product with your remote control, power is not cut off unless the power cord is unplugged.

The device may only be operated with the provided power adapter. The rated voltage is indicated on the product label. The device is factory-set to the optimal operating voltage (see Technical Specification). Use only power cords and plugs that are suitable for your local electrical outlets. Install the power cords in such a way that it does not obstruct anyone. Ensure that the cable is not clamped and that it cannot be pulled out accidentally from the power adapter. Do not install the power cords in the proximity of heating elements and never place heavy items on the cable or power adapter. Do not modify or arbitrarily repair the power cords.

CAUTION

Do not use any power cords or adapters other than those provided with this product. Use of power cords or adapters other than those provided with this product may cause fire, electric shock, or malfunction. If several kinds of power cords are provided with this product, use the one that fits your power socket. Do not let the adapter hang down while using. Do not cover or wrap the adapter. Leave space around the adapter to prevent overheating. The individual components can be destroyed if the polarity is reversed or an incorrect connection is used. A goodwill replacement is not possible in such cases, since each device is submitted to meticulous quality inspections prior to shipping. The connecting plugs must be attached in such a way that the connector is held firmly. Have trained technical personnel install the electrical facilities necessary for mounting. The power adapter must be installed in a ventilated area due to heat emission. Connect the power cord to a grounded outlet. Never cut or damage the power cord.

Please disconnect the device from the power adapter in the following cases:

1. The device is out of use for a lengthy period.
2. The device malfunctions or displays other unusual features, necessitating maintenance work.
3. During a thunderstorm.

Please plan the positioning of the power adapter and the source cables before proceeding with the structural measures and positioning of the Séura television. Observe the protection zones when placing the power adapter. Please bear in mind that the power adapter has to be placed beyond the inset due to heat emission.

NOTE

The power cable should be adequately secured to prevent it from becoming unstable and/or falling. Make sure the power source circuits are properly grounded. Use the supplied power cord in order to connect it to the power source. If your installation requires a different power cord, be sure to use an officially approved power cord displaying the mark of the safety agency that defines the regulations for power cords in your country.

Ensure that your installation complies with your national and local safety rules. Any servicing, adjustment, maintenance or repair must be performed only by service-trained personnel.

Setup

Before using the device please check the following contents of the box for completeness:

Sold separately:

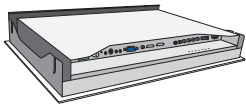

TV Assembly



Low-Voltage Power Adapter and Cable



IR Remote Control



Resource Information



Mounting Hardware

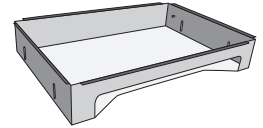

Back Box



50' Low-Voltage Power Cable



YPbPr Adapter



Composite Adapter



RS-232 Adapter

Input/Output Overview (Bottom View)

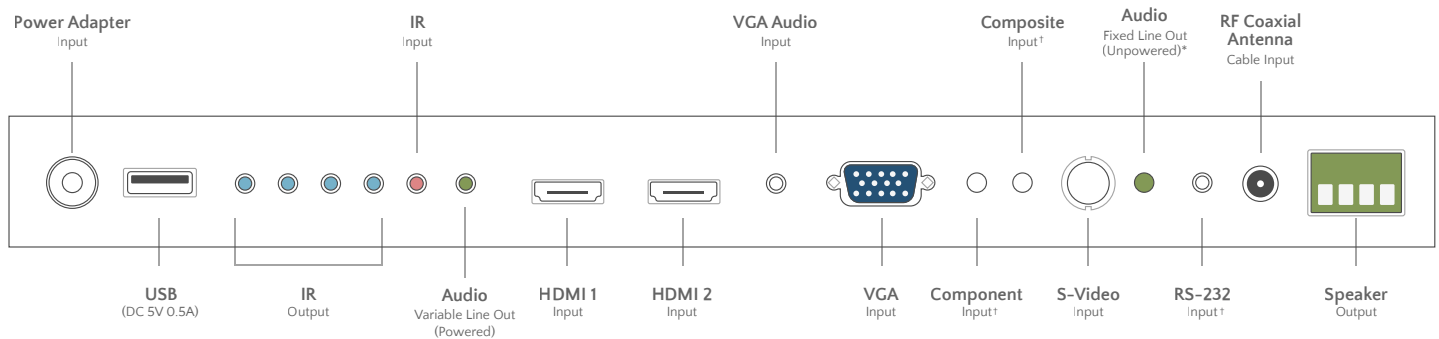

* The unpowered audio variable line out will cut audio from the speaker output.
 † Mini jack connection on TV, product includes adapter cables

Waterproof Remote Functions

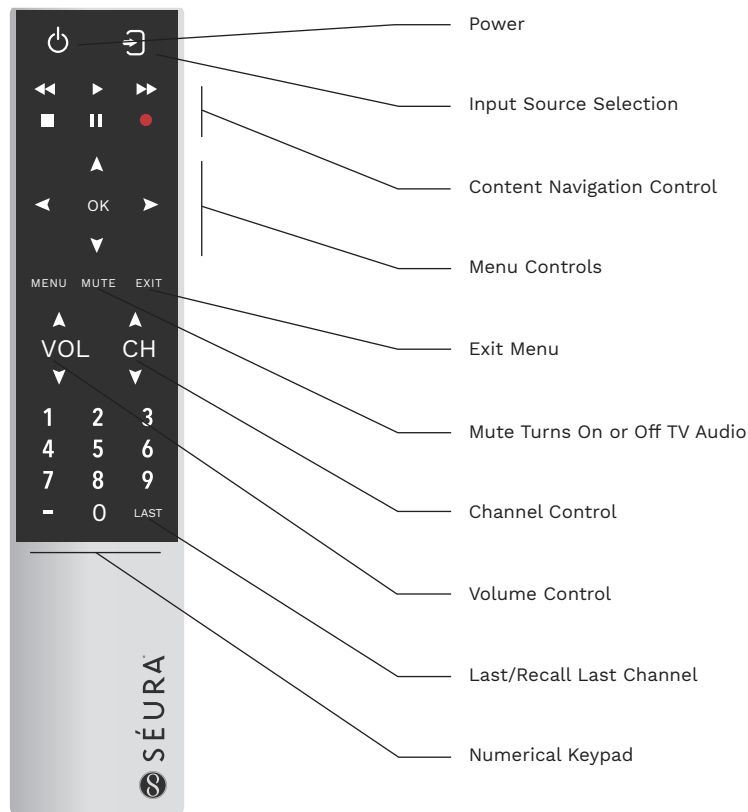

Installation



NOTE:

All Séura installation instructions indicate generalized nominal residential wood framing construction and are not indicative of any particular building code. It is the installers responsibility that all electrical, audio/visual, and framing construction are code compliant to the municipality in which the product is being installed. Modifications made to Séura recommendations are at the sole discretion of the installer and release Séura of all liability.

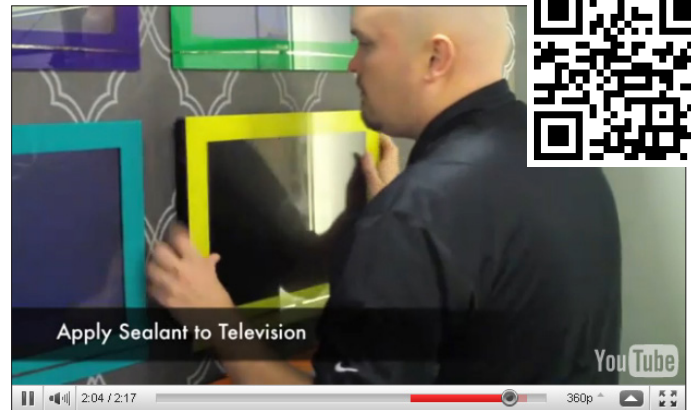

Scan to watch the 2-minute installation video

Read all installation instructions before beginning installation.

Step 1

Create rough opening in wall.

See diagram below for exact wall opening dimensions. The glass dimensions include the frame around the TV.

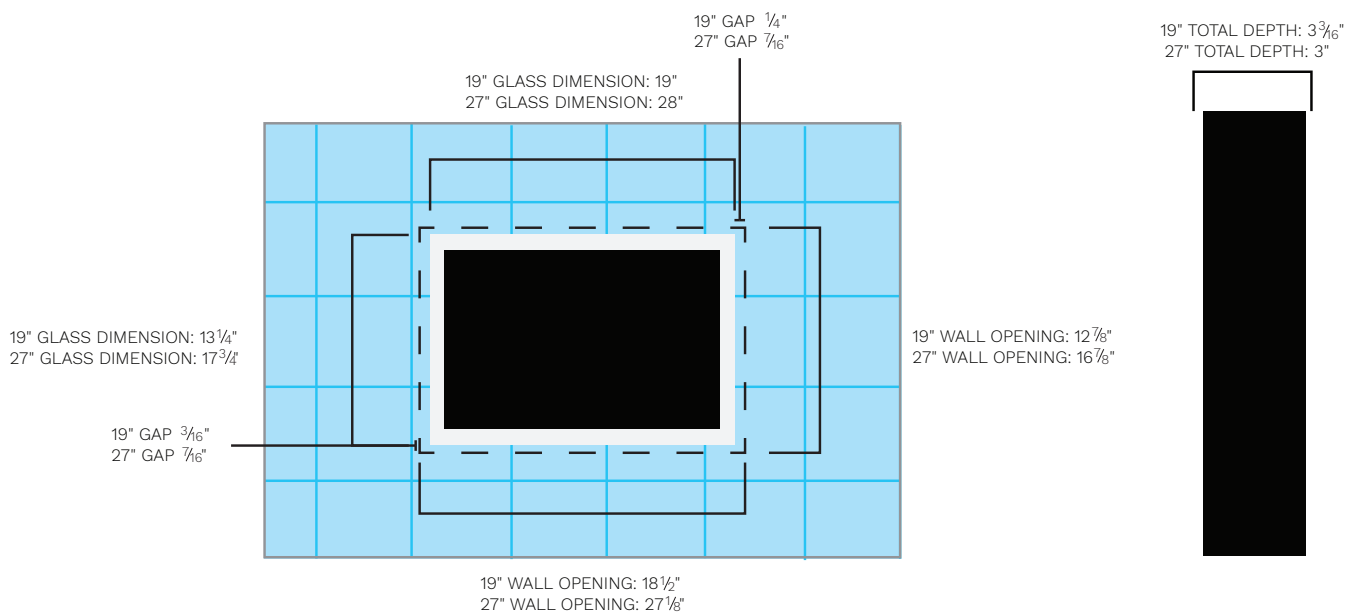

Installation

Step 2

Install back box into rough opening.

Using the provided four screws and washers, mount the back box tight to the finished wall surface by screwing through the screw-mounting slots in the back box. Ensure the front of the box is flush with the wall, and mounting tabs rest on the finished wall surface.

Note: Do not overtighten mounting hardware. Back box should fit snugly between framing members. If the fit is poor and overtightening occurs, the back box may deform, resulting in a poorly sealed installation. If the back box doesn't fit well between framing members, shim the framing members for a square and stable fit.

Feed power and other desired A/V and electrical cords through the pass-through port from inside the wall cavity prior to installing the TV.

While keeping cord ends outside the back box pass-through port, finish the wall tight to the edges of the back box, removing any gap. Once complete, the final wall surface should be flush with the front edge of the back box.

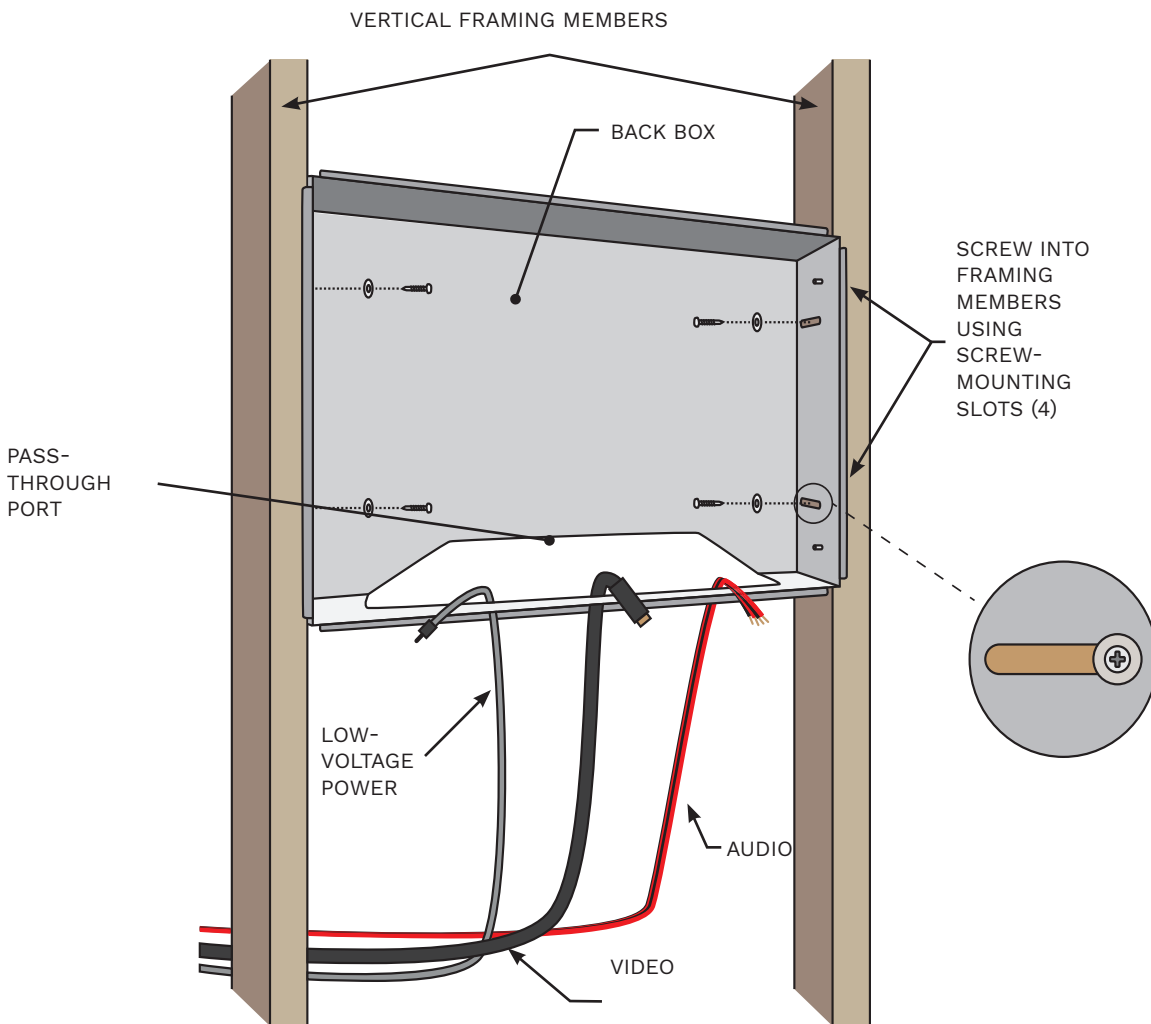

Installation

Step 3

Verify functionality.

Place TV assembly face down on a clean, dry surface near the installed back box. Make all necessary A/V and electrical connections and ensure full functionality of the TV, remote and any other A/V connections.

Before applying adhesive, test-fit the TV assembly in back box. Notice that the gravity lock mounts engage. Ensure functionality in installed position.

Remove TV assembly from back box. Do not disconnect any wires. Clean any residue from glass and remove debris.

Step 4

Apply sealant and install TV assembly.

Generously apply 1/8" bead of supplied waterproof sealant to the outer lip of the glass face that surrounds the black metal housing. Apply the sealant as close to the edge as possible.

With the sealant around the glass, insert the TV assembly into the back box mounting that has been already installed. Ensure gravity lock mounts fully engage. Slowly compress the adhesive until the back of the glass is tight against the wall surface. Sealant should seep out the front on all edges to provide the best seal. Verify that sealant is surrounding the entire perimeter of the glass face.

Immediately after TV assembly is installed and sealed, again verify functionality of TV and remote. If operation has been compromised by the installation, corrections can easily be made before the sealant has cured.

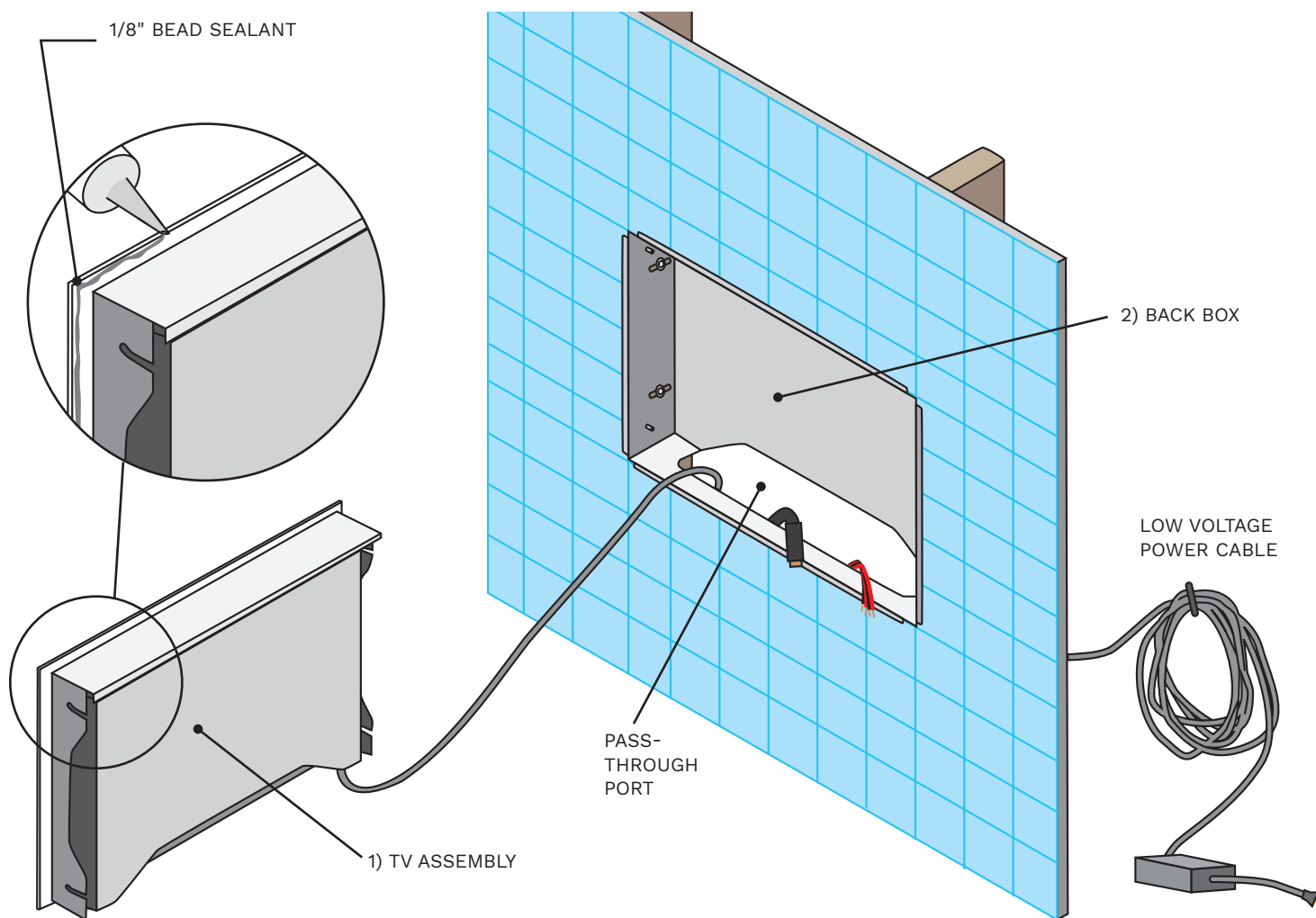

NOTE: THE POWER SUPPLY MUST NOT BE MOUNTED INSIDE A WALL CAVITY.

Installation

Step 5

Remove excess sealant.

Wipe dripping or excessive sealant. Allow waterproof sealant 24 hours to cure at 72 degrees Fahrenheit before exposing to moisture, or follow recommended time and temperature designated by sealant instructions.

Once fully cured, use a razor blade or utility knife to carefully remove excess sealant.

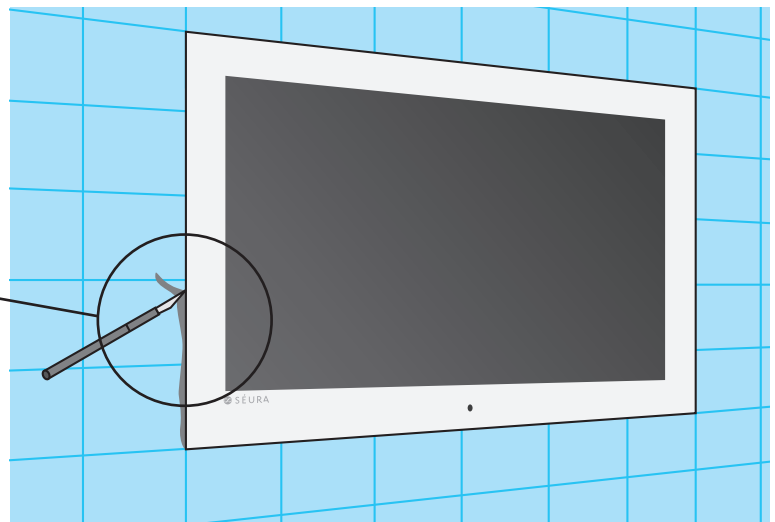
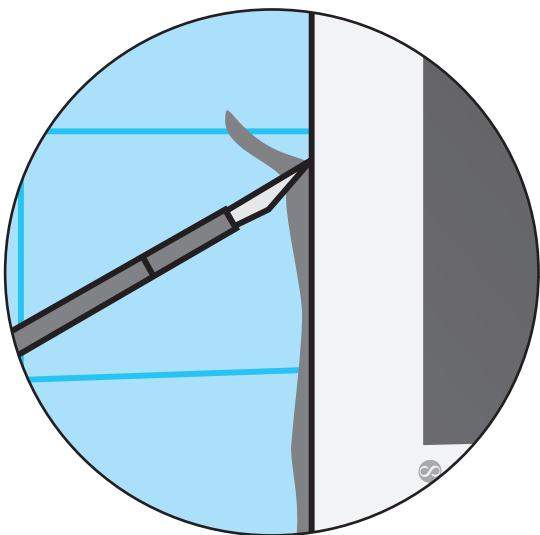
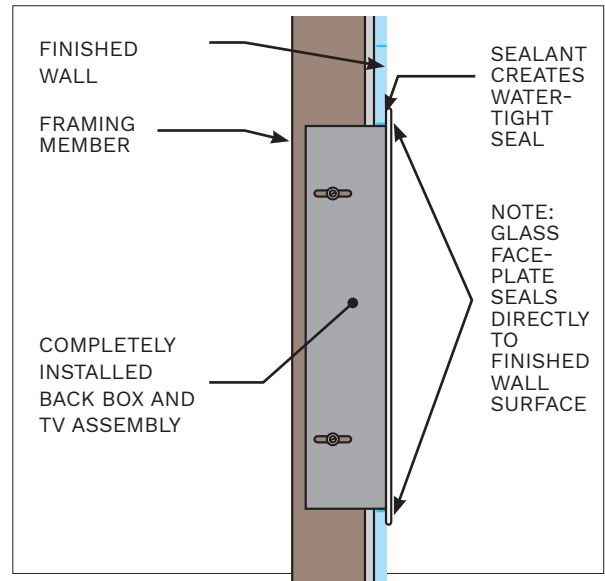
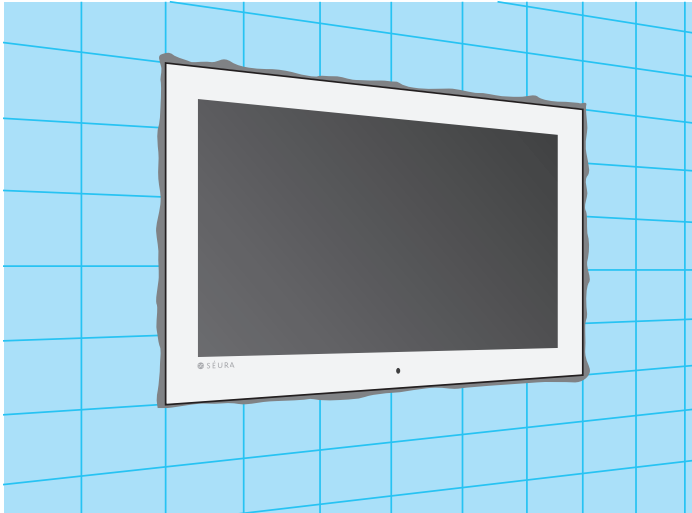

Removing the Unit

If the unit needs to be removed from the wall, essentially reverse the installation steps, starting with cutting the sealant. We recommend breaking the seal by side-cutting the sealant with a thin and durable line (such as a braided fishing line) and sawing back-and-forth between the glass face and wall. Then remove the TV from the back box. Disconnect all wires from the TV. Feed the power and other A/V electrical cords back through the pass-through port on the back box. Unscrew the framing members holding the backbox in place. Remove the back box from the wall opening.

Making Connections

Connecting Video

The television features one Component, one Composite, one VGA, one coaxial Cable/Antenna input, and two HDMI inputs. We recommend using the HDMI inputs for best video and sound quality.



Connecting Audio

Two passive loudspeakers can be connected to the speaker output socket with speaker cables. Observe the polarity (+ and -) of the connections to avoid phase errors (= incorrect stereo playback).

Note: This product is not equipped with built-in speakers.

Euroblock Connector

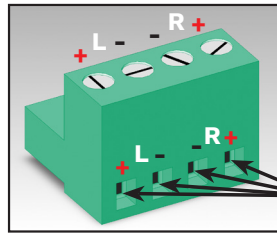

Speaker Wire Input



Connecting a USB Media Source

Connect an external USB media source to the USB socket to display photos, play music or install a software update.

In order to have access to the USB port after installation we recommend installing a USB extension cable.



Connecting a Home Automation System

With the RS-232 interface (9 pin d-subminiature connector female) you can connect a serial cable for communication with a home automation system, PC, etc. The baud rate is 115200.



Connecting IR Output (blue)

Using the IR (infrared) output terminals on the TV, you can operate components of your audio video system that are not in the line of sight of the remote control. The IR sensor on the TV will receive IR commands from a remote and distribute them to the 3.5mm IR output terminals located on the TV. For most devices, use an IR emitter with a 3.5mm mono plug. Attach the IR emitter side to the IR receiver of the device to be controlled and attach the 3.5mm mono plug to the TV's IR output. Alternately, if the device being controlled has 3.5mm IR input, simply use a male-to-male 3.5mm mono plug to connect the TV and device.

IR output tip is signal and sleeve is ground.

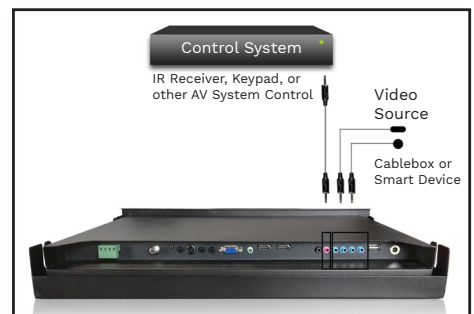

Connecting IR Input (pink)



Using the IR (infrared) input terminal on the TV, you can control the TV using IR commands sent from a keypad, IR receiver, or other AV control system. Attach a 3.5mm mono plug into the TV's IR input and use the discrete IR codes provided at seura.com/download-center.

IR input tip is signal and sleeve is ground.

On Screen Display Menu (OSD)





On Screen Display Menu (OSD)

In the on screen display menu (OSD) you can adapt the characteristics of your display based on personal preferences. OSD menus include **Video, Audio, TV, Setup, and Parental**.

1. Press  on your remote control to open the OSD menu
2. Navigate within the OSD with the left/right and up/down arrows
3. Change settings with the left/right arrows
4. Go back one step with 
5. Confirm selection with the OK button
6. Press  to exit the OSD menu.

Input Source Selection

In the Input Source menu, you may select from the available input sources.

1. Press  to power the television on
2. Press  to display the Input Source list OR use the quick input controls on the remote to directly designate the input source.
3. Press the up or down arrows until the desired Input Source is highlighted.
4. Press OK to confirm selection of the chosen input and clear the Input Source list from the screen or press  again to switch through the signal inputs.
5. Press  to close the Input Source list without selecting an alternative source.



Video Settings

The Video Settings menu offers options to enhance and refine the image characteristics of your Séura television. These settings are based on ambient conditions of illumination and personal preferences.

Adjustment options include:

Picture Mode

Brightness

Contrast

Saturation

Hue

Sharpness

Back Light

Advanced Video

Reset Picture Mode



PICTURE MODE

Within the **Picture Mode** menu you can customize the image display according to your preferences.

Your options: **Home, Vivid, User, Cinema, Sport**

The **Home** setting is recommended for most viewing environments. Select the **User Mode** to adjust your preferred settings manually.

OSD (cont.)

Advanced Video Settings

The Advanced Video Settings menu offers further options to refine the image characteristics of your Séura television.

Adjustment options include:

- DNR**
- MPEG NR**
- Adaptive Luma Control**
- Flesh Tone**
- DI Film Mode**
- Blue Stretch**
- Game Mode**
- Blue Mute**
- Gamma**
- Color Temperature**

COLOR TEMPERATURE

Within the **Color Temperature** menu you can customize the **Color Temperature** of the picture according to your preferences.

Your options: **Standard, Warm, User, Cool**



Audio Settings

The Audio Settings menu offers options to enhance and refine the sound characteristics of your Séura television based on personal preferences.

Adjustment options include:

- Balance**
- Bass**
- Treble**
- Sound Surround**
- Sound Mode**
- MTS**
- Audio Language**
- SPDIF Type**



OSD (cont.)

Setup Menu

The Setup Menu offers options to determine fundamental settings of your Séura television based on personal preferences.

Adjustment options include:

OSD Language

Caption

Time Setup

Reset Default



TIME SETUP

Options within the Time Setup selection include **Time Zone, Time, and Sleep Timer.**

TIME ZONE

The local time zone may be selected using the graphical map of North America

SLEEP TIMER

Within the **Sleep Timer** menu you can determine a timespan after which the Séura television will turn off automatically.

Your options: **Off, 10, 20, 30, 40, 50, 60, 90, 120 minutes**

 The Sleep Timer can also be activated and deactivated directly with the remote control.

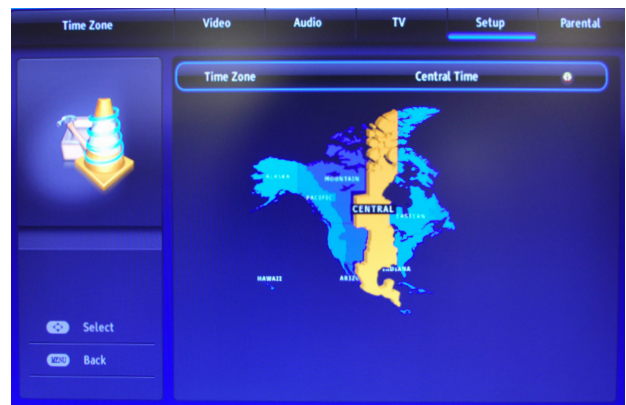

OSD (cont.)

Parental Menu

The Parental Menu offers options to restrict program viewing based on various national rating systems.

To access the menu, enter the 4-digit Password using the keypad on the remote. The factory default password is "0000".

Adjustment options include:

Program Block

Change Password

Clean All (or reset settings)

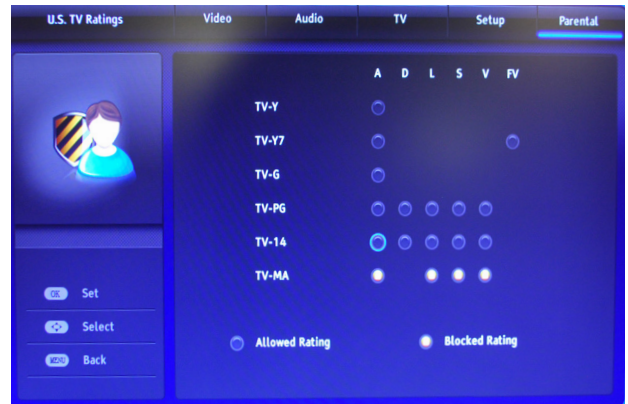
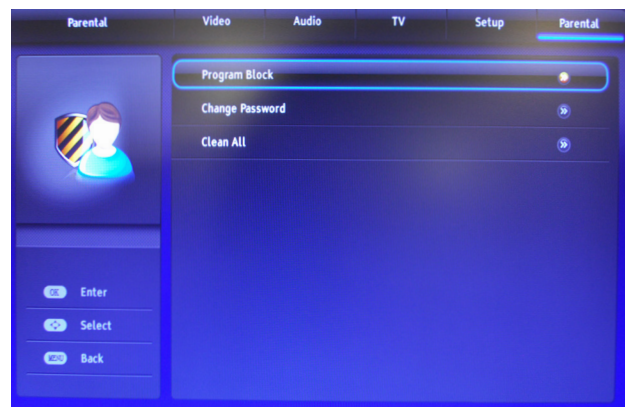
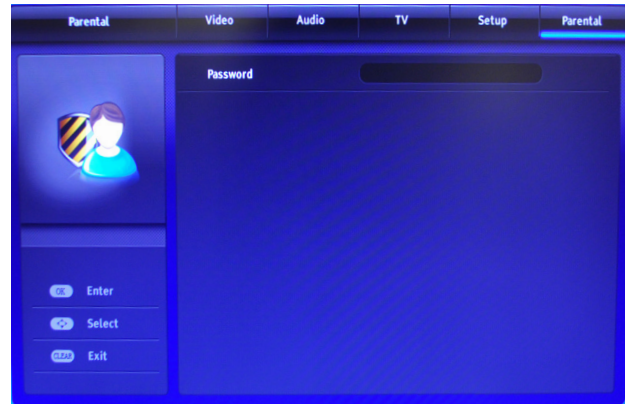

Media Support

Special Features

Multimedia Player	USB
Software Update	USB
Signal Scan	Yes
RS-232	Yes
Noise Reduction	3D

USB Media Support

USB Media Support	File Extension	Video	Audio
Movie	.avi	DivX, XviD, MPEG-4	MP3, WMA, AAC
	.mpg	MPEG-1, MPEG-2	
	.dat	MPEG-1	
	.mov / .mkv	H.264	
Music	.mp3	--	MP3
	.wma	--	WMA
	.m4a / .aac	--	AAC
Photo	.jpg / .jpeg	Progressive JPG	
		Baseline JPEG	
	.bmp	BMP	
	.png	Non-Interlaced	
		Interlaced	

NOTE: Above specification may be changed without prior notification for quality improvement.

Troubleshooting

If the product is not working properly, please check the following troubleshooting hints before you contact customer service:

Symptoms	Possible Solution
Blank screen	Check the status LED. If the status LED is red, the television is in standby and the monitor is black, this is normal. If the status LED is green and the monitor is black, the television might perform an input scan with no available signal. Please check if an input source is available and that the port of the device has been connected correctly in the Service Settings/ Input Ports menu. Press “Menu” on your remote control: you should see the OSD menu. Check your settings for misconfigurations and adjust accordingly. Alternatively, perform a factory reset to restore the television to its default settings. If the problem still exists contact customer service.
Color defects	Check that the signal cable connector is properly connected and that the connection pins are not bent or damaged.
The image is unsatisfactory	Adjust the picture characteristics as described in the above-mentioned section “Video Settings”. Image is not stable Check that the display resolution and frequency from your media source is compatible with the television.
Error message: “No Signal”	Check that the connected media sources are switched on. Check that the signal cable connector is properly connected and that the connection pins are not bent or damaged. Press “Menu” on your remote control: you should see the OSD menu. Check your settings for misconfigurations and adjust accordingly. Alternatively, perform a factory reset to restore the television to its default settings. If the problem still exists contact customer service.
Low or no sound	Press “Volume Up” and/or “Volume Down” on your remote control and check the audio connection cable(s). Make sure that the Volume Limit setting in the Service Settings menu has been set to an audible value.
Remote control doesn't work	Press a button on the remote control and check that the status LED of the television flashes briefly. If it doesn't, replace the batteries of the remote control.
Pixel errors	Pixel errors outside of Séura's specified and permitted area are covered under Séura's limited product warranty. Please inquire directly with Séura Technical Support regarding Séura's Pixel Policy.

NOTE: If the above troubleshooting hints do not help you to find a solution, please contact Séura.

CONTROL DOCUMENTATION

To access current control documents, please visit www.seura.com/download-center.

- RS-232 Protocol
- IR Commands

LIMITED PRODUCT WARRANTY

For information regarding Séura's warranty policy, please visit our website: www.seura.com/warranty. If the current Séura warranty policy is after your product purchase date, please contact Séura Customer Support to request warranty documentation from the date of your purchase.

For additional customer support, please contact Séura.

Toll Free: 1-800-957-3872 (Monday - Friday 8:00 am – 4:30 pm, Central Time)

Website: www.seura.com/support