

LUD36-D DMX Driver User Data

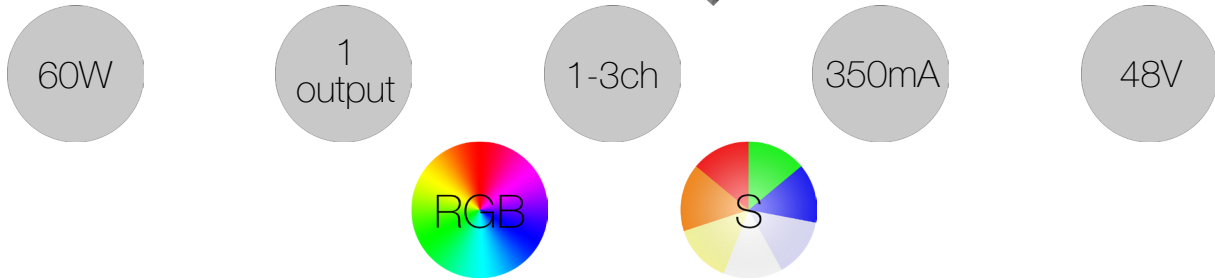

110-240VAC
Input Voltage

350mA
Output Current

8-48V
Voltage Range

60W
Max Power Consumption

1-3 Channel
Single Output

IP20
Ingress Protection

RJ45
Output Connectivity

-10°C / +40°C
Operating Temp

Cooling System:
Convection



Tel: +44 (0) 116 278 8078
Email: sales@abstractavr.com
Website: www.abstractavr.com



User Data - Specifications
Date: 01/11/2016
Page 1/4

LUD36-D DMX Driver User Data

Dimensions

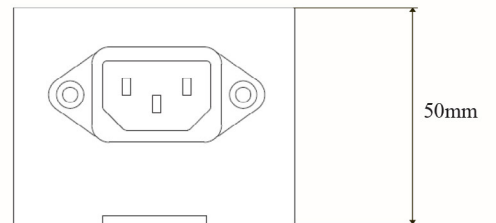
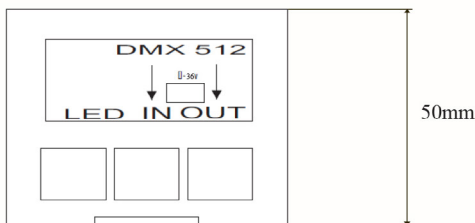
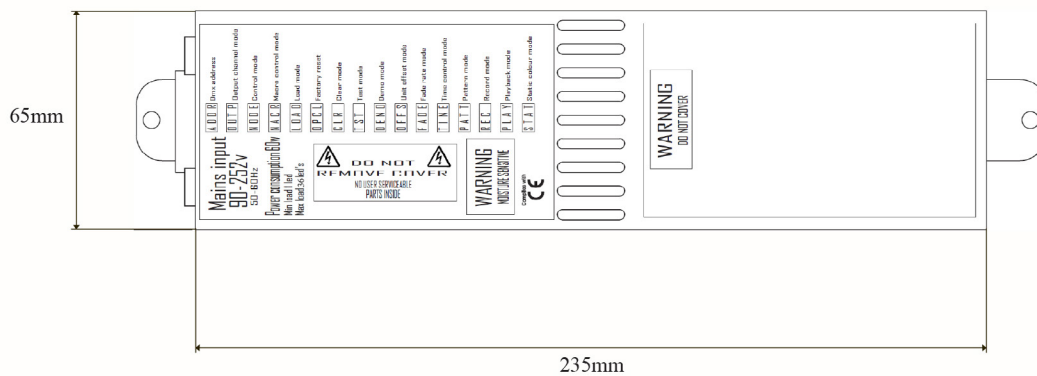

LUD36-D DMX Driver User Data

Wiring Connections

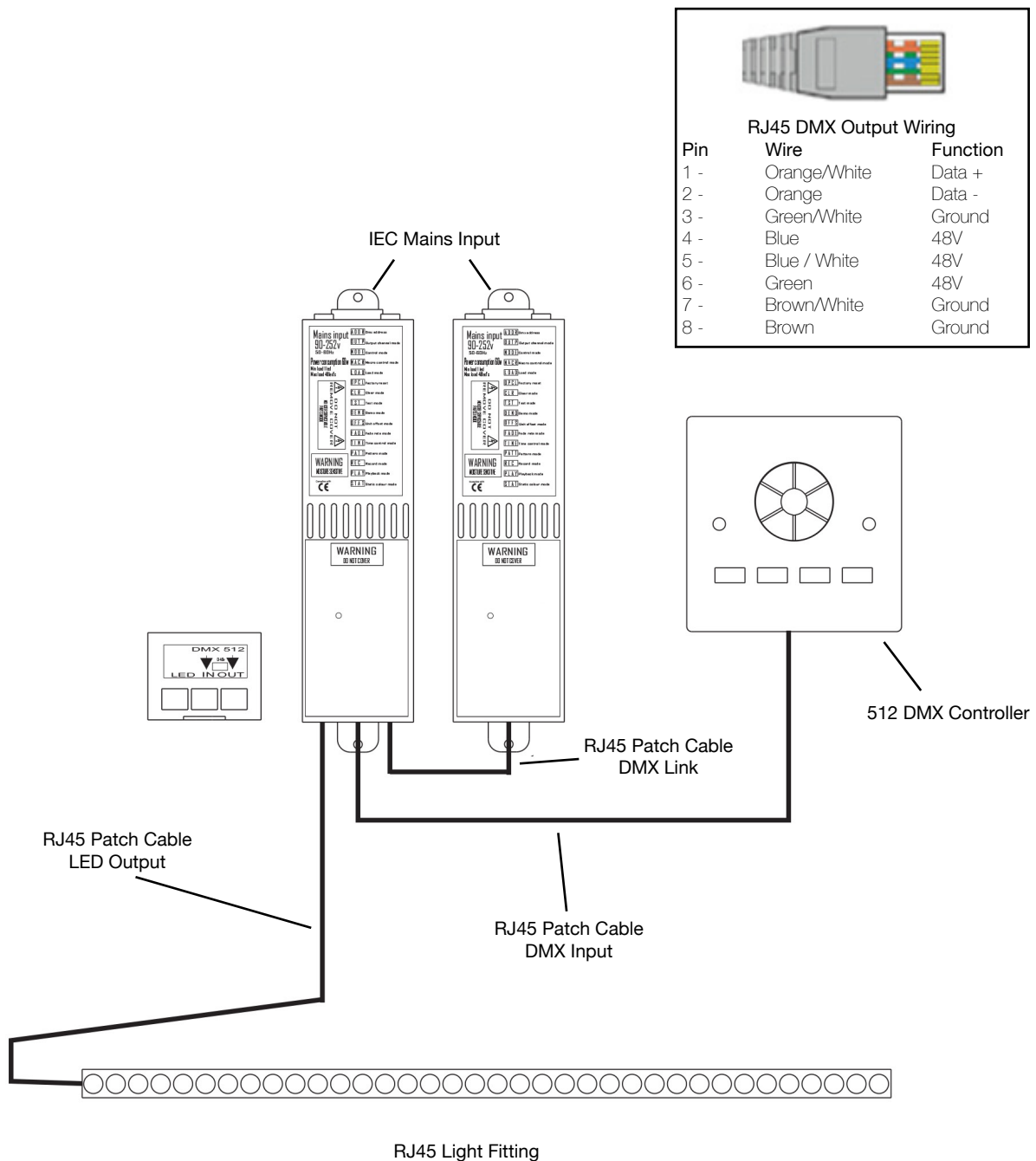

RJ45 LED Output Wiring

Pin	Wire	Function
1 -	Orange/White	Red +
2 -	Orange	Green +
3 -	Green/White	Blue +
4 -	Blue	White +
5 -	Blue / White	Red -
6 -	Green	Green -
7 -	Brown/White	Blue -
8 -	Brown	White -

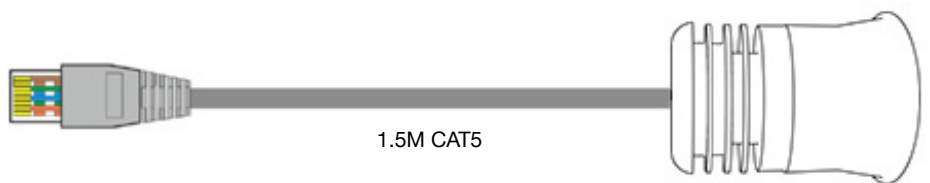

RJ45 System Wiring

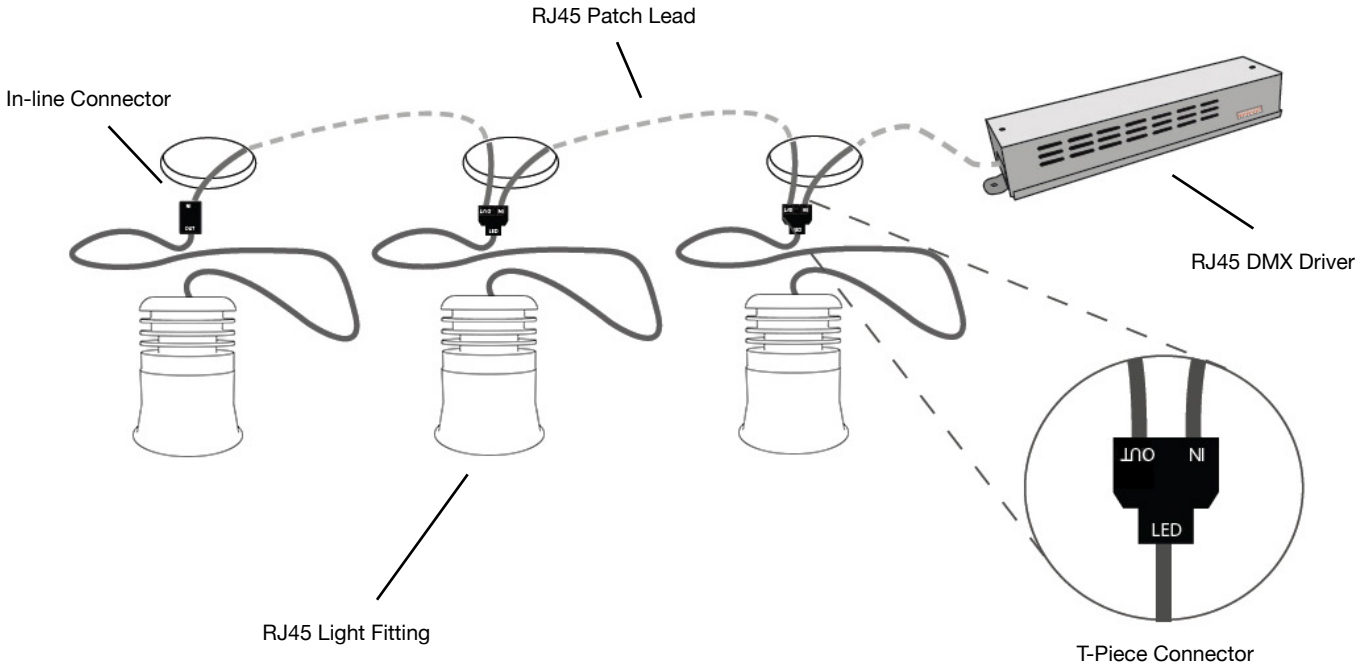

WARNING! Example diagram only. Please read this section carefully before any installation work is carried out. All work should be carried out as per our instructions. Failure to do so may void any warranty. These instructions are to be used in addition to the Driver manuals.

IMPORTANT

All work involving electrical components should be carried out by a competent qualified electrical professional in accordance to IET BS 7671 and any local by-laws.

All mains power **MUST** be turned off before starting installation or maintenance; and **MUST** remain off for the duration of installation or maintenance.

Equipment may become hot to the touch when used for periods of time. Ensure equipment is off and cooled before carrying out maintenance.

DO NOT connect or disconnect light fittings while mains power is connected. All RJ45 connections **MUST** be made before mains power is connected. Failure to do so may result in catastrophic failure of the LED.

You can install any combination of RJ45 fittings from a single 'LED' output on the Driver, ensuring the total combined forward voltage of the fittings connected to any single 'LED' output **DOES NOT EXCEED 48V** and is **NO LESS THAN 8V**.

TESTING

You should test each fitting in isolation before continuing installation.

1. Disconnect the Driver from mains power.
2. Connect RJ45 light fitting to the 'LED' socket of the Driver in isolation.
3. Power up the Driver.
4. Select dipswitch settings for Red, Green and Blue to ensure each LED lights up correctly.
5. Repeat steps 1 to 4, for each fitting.

If each fitting lights up and displays each colour you can continue with your installation.

If a fitting does not light up or display each colour please contact us for help. Do not continue your installation.

INSTALLATION

Ensure you have carried out the testing before installation.

1. Disconnect the Driver from mains power.
2. Using a RJ45 patch lead connect from 'LED' socket of the Driver to 'IN' socket of T-Piece.
3. Connect the RJ45 of fitting to 'LED' socket of T-Piece (1x 'LED' socket, 1x 'IN' socket, 1x 'OUT' socket).
4. Connect a RJ45 patch lead from 'OUT' socket of T-Piece to 'IN' socket of next T-Piece.
5. Repeat steps 3. and 4 for each fitting, ensuring you do not exceed a total forward voltage of 48V to each 'LED' output of the Driver.
6. The last fitting should be terminated with an In-line connector in place of the last T-Piece. (1x 'IN' socket, 1x 'OUT' socket).

Pin	Wire	Function
1 -	Orange/White	Red +
2 -	Orange	Green +
3 -	Green/White	Blue +
4 -	Blue	White +
5 -	Blue / White	Red -
6 -	Green	Green -
7 -	Brown/White	Blue -
8 -	Brown	White -

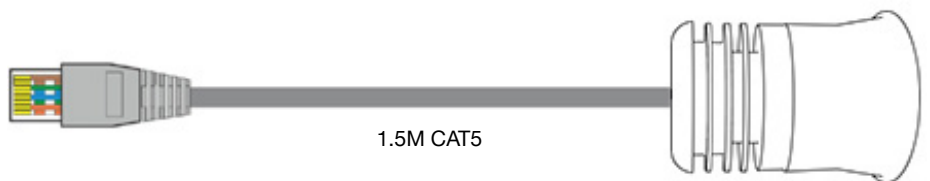

Tel: +44 (0) 116 278 8078
 Email: sales@abstractavr.com
 Website: www.abstractavr.com



User Data - RJ45 Wiring
 Date: 01/11/2016
 Page 4/4