

Model: Kyra

lēvoit

Natural Himalayan Salt Lamp

Questions or Concerns?

Please contact us Monday - Friday 9:00am - 5:00pm PST
at **(888) 726-8520** or email **support@levoit.com**

Thank You.

Thank you for purchasing your Natural Himalayan Salt Lamp by Levoit. At Levoit, we believe your living space plays a key role in developing a happier and healthier lifestyle. Himalayan Salt Lamps create a soothing environment by emitting warm lighting and releasing negative ions into the air. Along with their holistic benefits, a Levoit Himalayan Salt Lamp adds style and an artisanal touch to your home. Levoit Himalayan Salt Lamps are the highest quality on the market and we are proud to offer unique and inspiring designs.



Safety Information

IMPORTANT: Please read, understand, and comply with all of the instructions provided in this manual before using the device. Failure to comply with the instructions given in this manual and/or using the device in ways other than the ones mentioned in this manual may result in serious injury and/or damage the product.

Safety Use & Care

- Keep out of reach of children.
- The lamp is for indoor use only. Avoid exposure to high-temperature sources, direct sunlight and moisture.
- **DO NOT** strike or drop the lamp.
- To avoid damage, move and handle with care.
- **DO NOT** wash with water or detergents. Do not immerse in any form of liquid.
- Due to the nature of salt, each crystal varies in color, shape, size, and weight.
- To protect the surface in which the lamp is placed, place a cloth or coaster under the lamp's base.
- If the salt crystal surface becomes moist, set the lamp to high and leave the lamp on to allow the salt crystal to dry.
- **DO NOT** replace the bulb while the salt crystal is damp.



Main Functions

Function Diagram

1. Salt crystal
2. Lamp base
3. Base screws
4. Lighting control
5. Base pegs
6. Bulb
7. Screw slots
8. Power cord

NOTE: Each salt crystal is unique in shape and size.

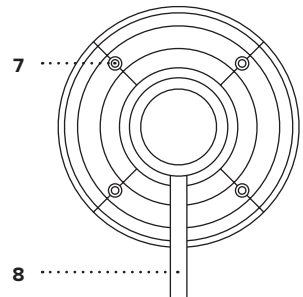
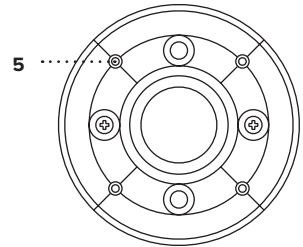
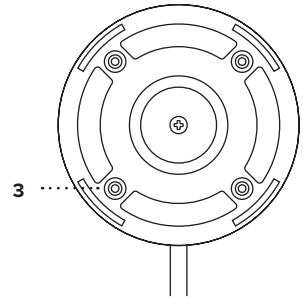
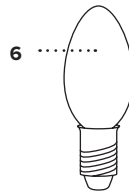
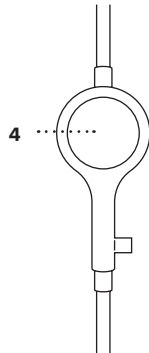
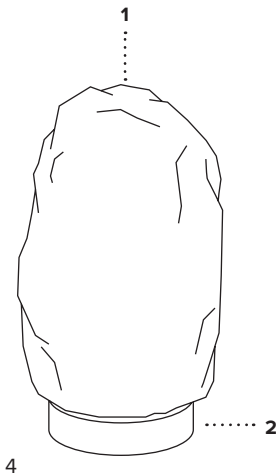



Operation

1. Place the salt lamp on a hard, flat surface.
2. Plug the power cord into a powered socket.
3. Tap the lighting control button to turn on the lamp.
4. Press and hold the lighting control button to adjust the lamp brightness. Release at the desired brightness setting.
5. Press the power button once again to turn off the lamp.

NOTE: The lamp will remember the last mode and brightness level when turned on and off; however, this memory function will not work if the power source is interrupted.

Action	Command
Turn on	Press once. The default level is its brightest setting.
Dim Light	Press and hold, then release at desired level (while light is on).
Brighten Light	Press and hold, then release at desired level (while light is dim).
Turn off	Press once.

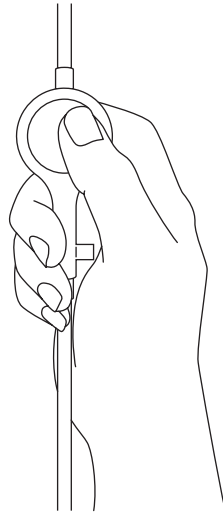



Lightbulb Replacement

NOTE: It is best to complete this process seated at a table or nearby surface to place the small screws.

1. Unplug the salt lamp's power cord.
2. Carefully flip over the lamp, supporting the lamp by the crystal.
3. With a small screwdriver, remove the four base screws, rotating counter-clockwise.

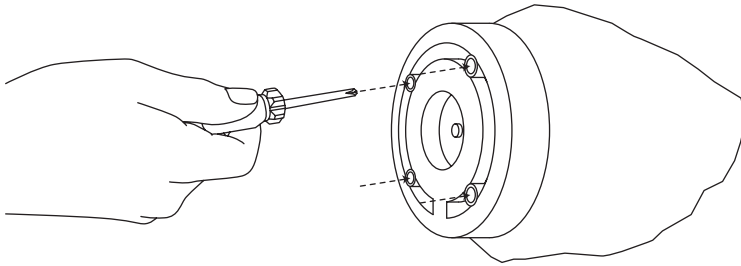

NOTE: DO NOT remove the center screw.

4. Gently slide off the base while holding the lamp (upside-down or sideways).

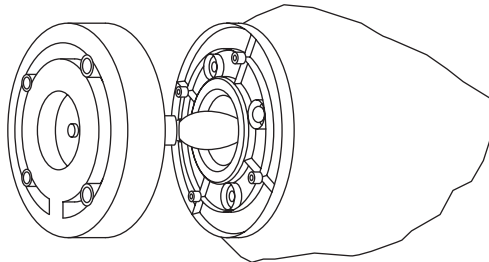

- Carefully set aside the salt crystal on a flat and stable surface and remove the bulb from the base socket, gently rotating it counter-clockwise.
- Install a new C7 15W bulb, gently rotating it clockwise.

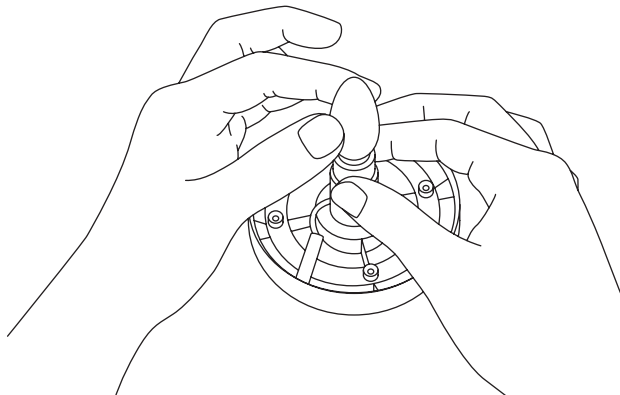

- Gently slide the base back onto the crystal, making sure the screw slots and base pegs are aligned.

NOTE: You may test to see if the screw slots and base pegs are aligned by attempting to twist the base while in place. If the base doesn't rotate, the crystal and base are properly locked in.

- With a small screwdriver, reinstall the screws in each of the four outer slots, making sure they are tightly screwed in.
- Place the lamp on a flat surface right side up, holding your hand under the base until placed under the table so as to avoid the possibility of losing any loose screws.



Cleaning & Maintenance

- Regularly dust off the salt crystal with a dry clean cloth.
- **DO NOT** wash or clean with water or liquid detergents.
- If not in use for a long period of time, store the lamp in a cool and dry environment, covering the crystal with a plastic bag.
- The lamp may naturally moisten in humid environments. If used in a humid environment, keep the lamp lit for several hours for it to naturally dry out.
- If the salt crystal becomes moist, gently pat down the crystal surface with a dry cleaning cloth.



Specifications

Input:	120V / 60Hz
Light Color:	Orange
Power:	2.5W ≤ P15 ≤ W
Length of Power Cord:	6.56 ft

Due to the nature of salt, each crystal varies in color, shape, size, and weight.

Package Contents

1 x Kyra Himalayan Salt Lamp
3 x C7 15W Bulb (1 pre-installed)
1 x User Manual



Warranty Information

Terms & Policy

Levoit warrants all products to be of the highest quality in material, craftsmanship and service for a minimum of 1 year, effective from the date of purchase. Warranty lengths may vary between product categories. Levoit will replace any product found to be defective due to manufacturer flaws based on eligibility; refunds are available within the first 30 days of purchase. This warranty extends only to personal use and does not extend to any product that has been used for commercial, rental, or any other use in which the product is not intended for. There are no warranties other than the warranties expressly set forth with each product.

This warranty is non-transferrable. Levoit is not responsible in any way for any damages, losses or inconveniences caused by equipment failure or by user negligence, abuse, or use noncompliant with the user manual or any additional safety, use, or warnings included in the product packaging and manual.

This warranty does not apply to the following:

- Damage due to abuse, accident, alteration, misuse, tampering or vandalism.
- Improper or inadequate maintenance.
- Damage in return transit.
- Unsupervised use by children under 18 years of age.

Levoit and its subsidiaries assume no liability for damage caused by the use of the product other than for its intended use or as instructed in the user manual. Some states do not allow this exclusion or limitation of incidental or consequential losses so the foregoing disclaimer may not apply to you. This warranty gives you specific legal rights and you may also have other rights which may vary from state to state.

ALL EXPRESSED AND IMPLIED WARRANTIES, INCLUDING THE WARRANTY OF MERCHANTABILITY, ARE LIMITED TO THE PERIOD OF THE LIMITED WARRANTY.

Should your product prove defective within the specified warranty period, please return the defective unit in its original packaging with (1) an original copy of the invoice, (2) your order confirmation number, (3) and your warranty ID number.

To find out more about extending your warranty, visit www.levoit.com/warranty or contact customer support.

Date of Purchase: _____

Purchased From: _____

Order Number: _____



Customer Support

Should you encounter any issues or have any questions regarding your new product, feel free to contact our helpful Customer Support Team.

We're here for you.

Levoit Corporation

1202 N Miller Street, Suite A
Anaheim, CA 92806

Toll-Free: (888) 726-8520

Email: support@levoit.com

Support Hours

Monday - Friday: 9:00am - 5:00pm PST

**Please have your order confirmation number ready before contacting customer support.*



The logo for Levoit features the word "levoit" in a bold, lowercase, sans-serif font. A red, curved shape resembling a smile or a stylized 'e' is positioned above the letter 'e'.

levoit

www.levoit.com