

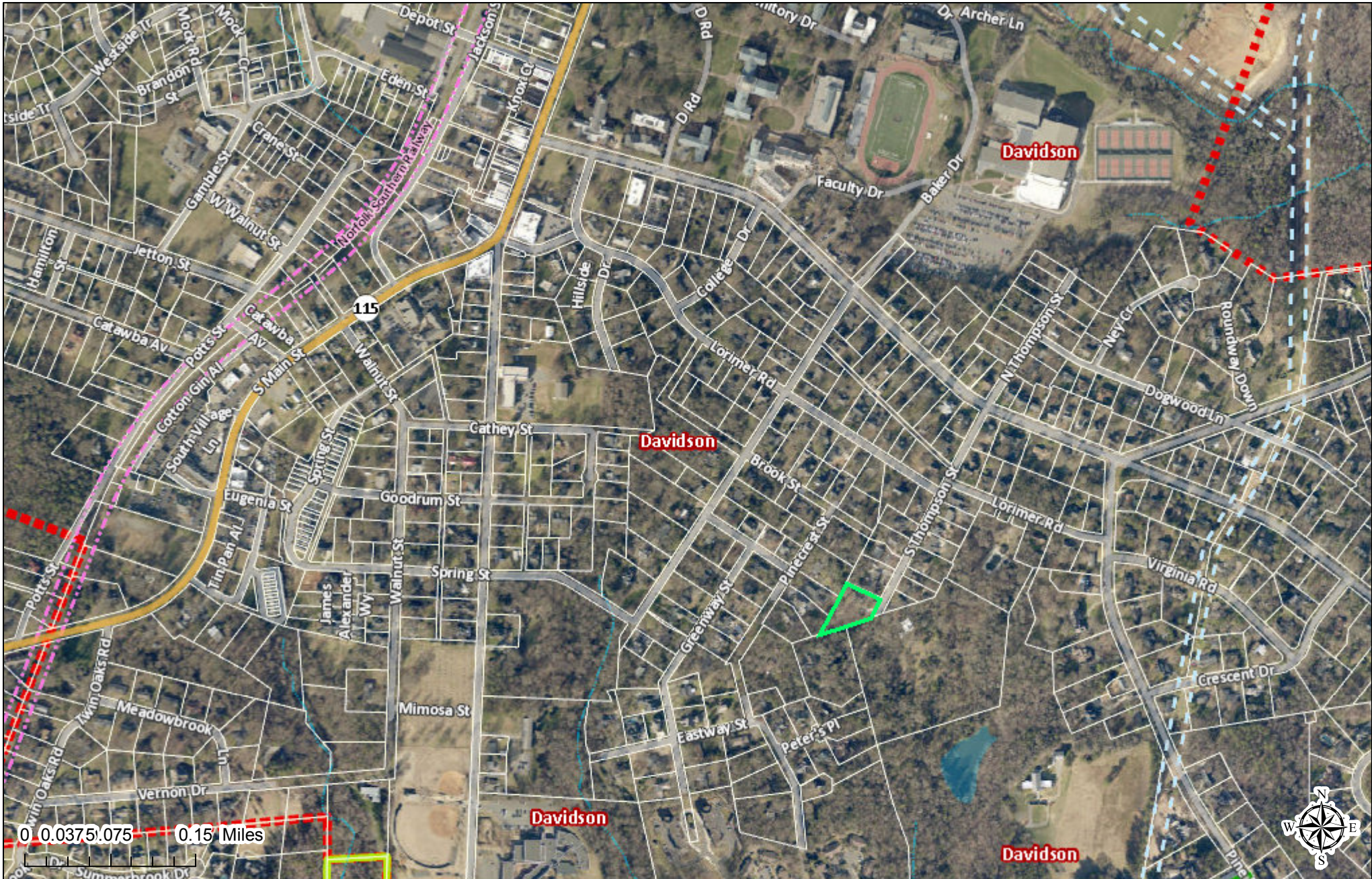

Polaris 3G Map – Mecklenburg County, North Carolina

Date Printed: 4/21/2017 3:13:32 PM



This map or report is prepared for the inventory of real property within Mecklenburg County and is compiled from recorded deeds, plats, tax maps, surveys, planimetric maps, and other public records and data. Users of this map or report are hereby notified that the aforementioned public primary information sources should be consulted for verification. Mecklenburg County and its mapping contractors assume no legal responsibility for the information contained herein.

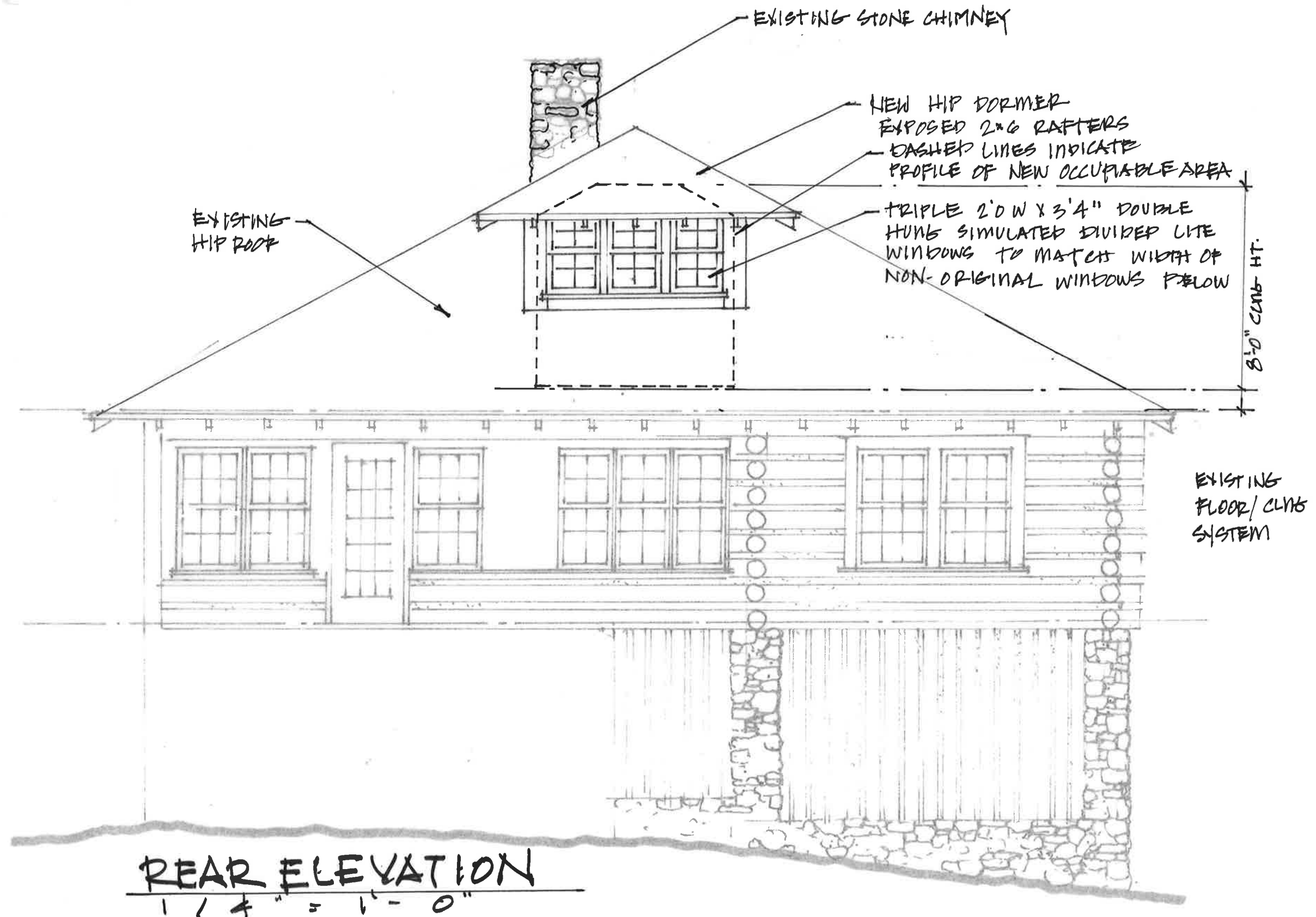

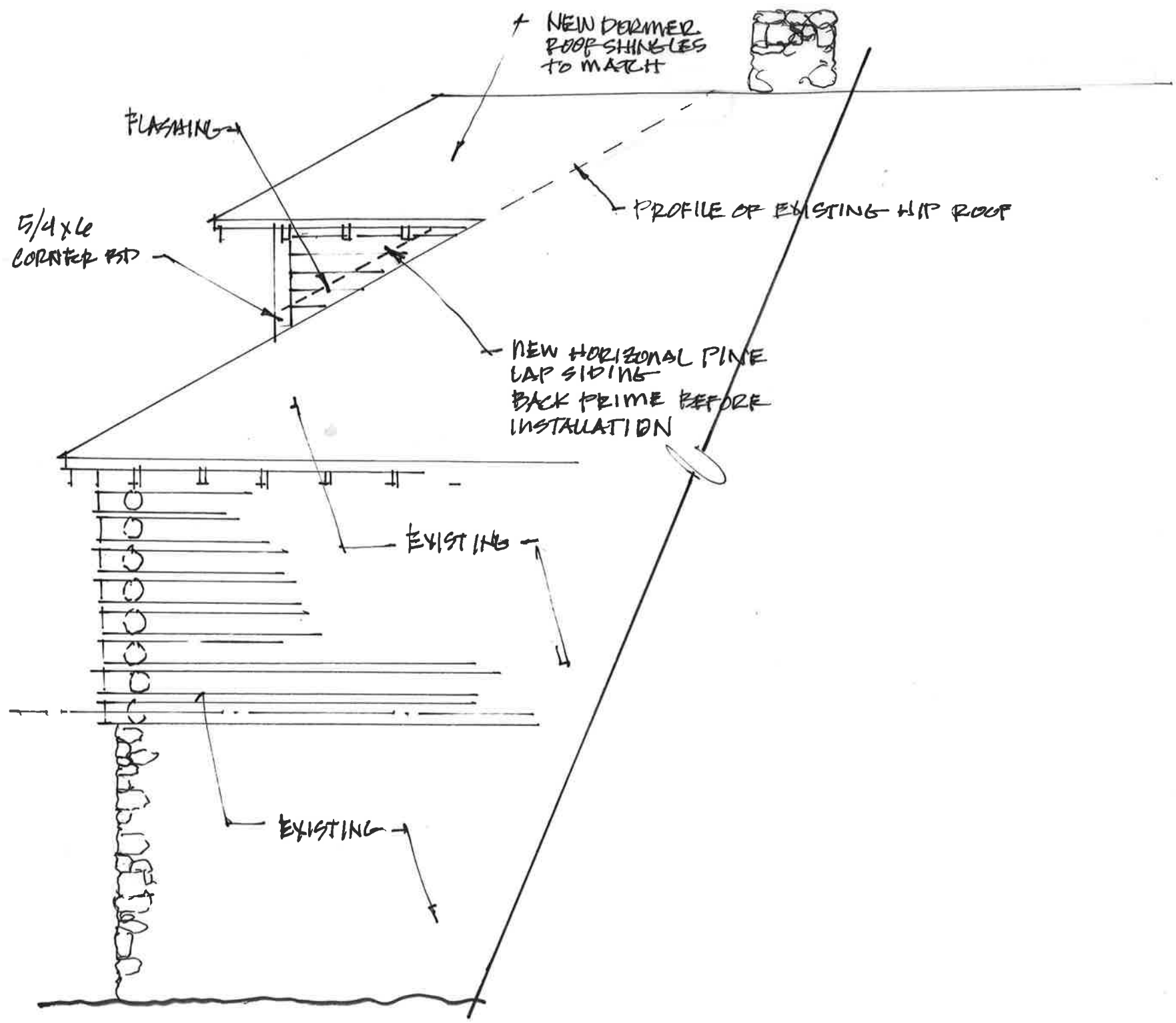

PARTIAL SIDE ELEVATION
 1/4" = 1'-0"







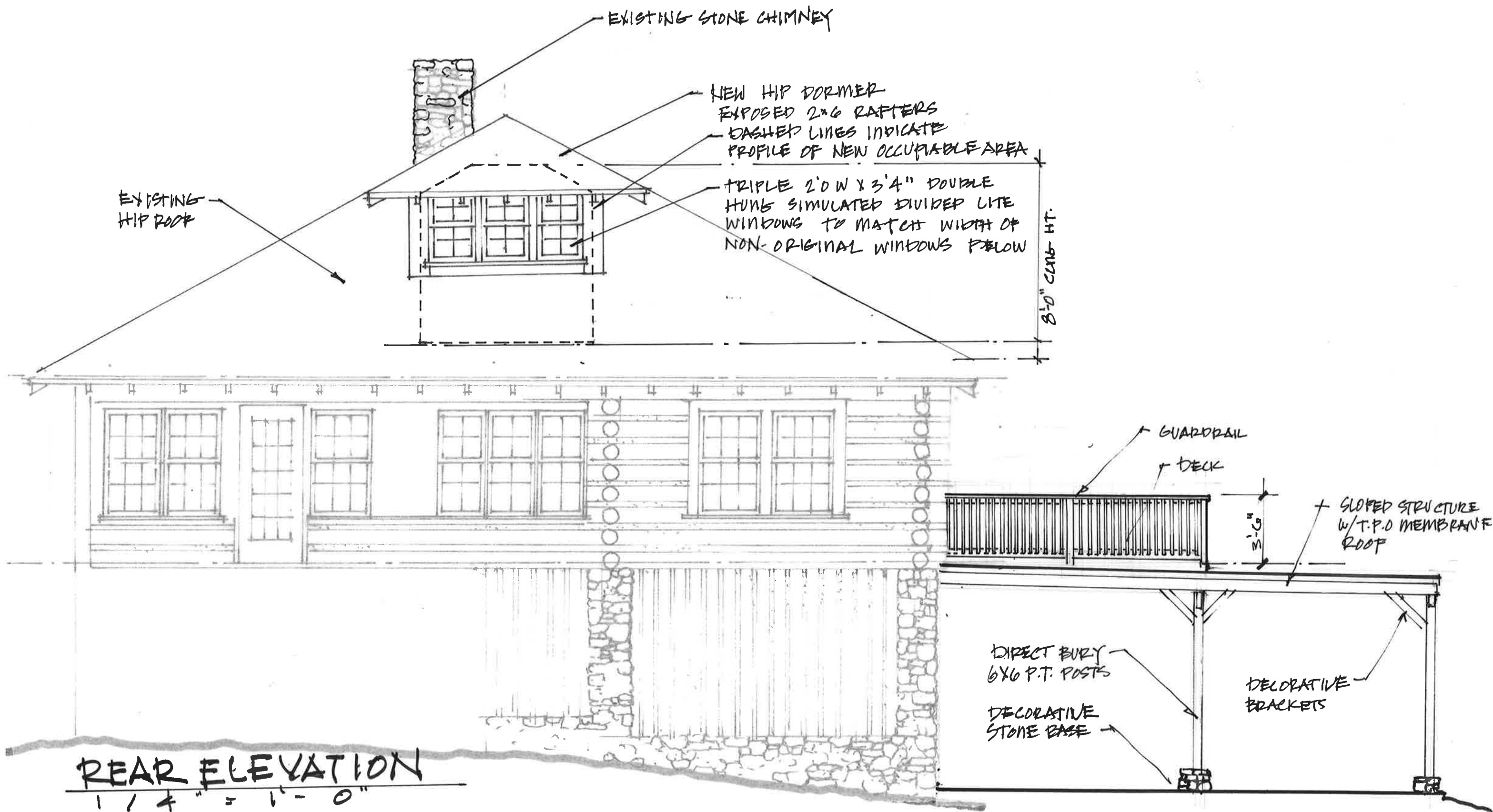





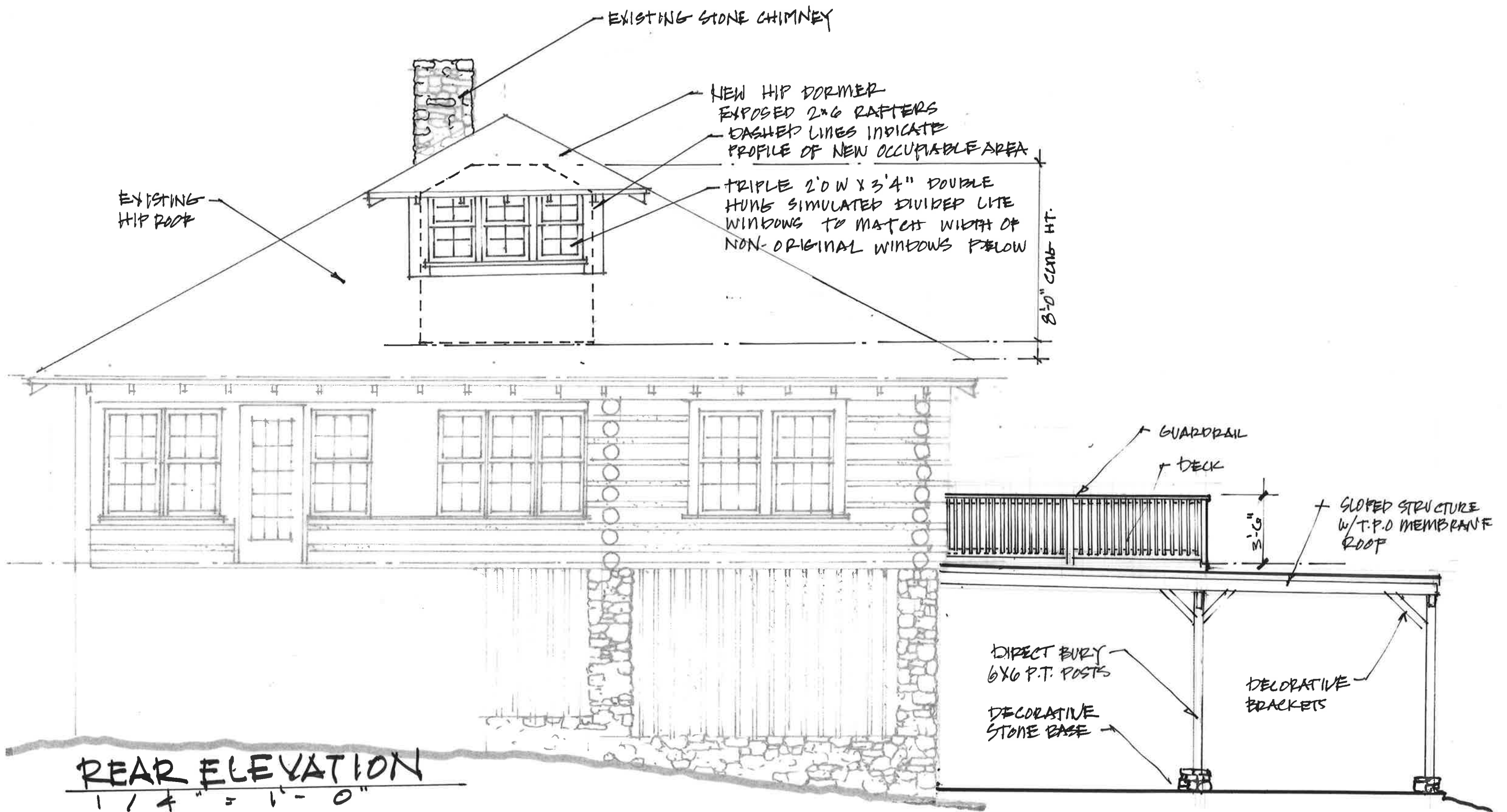

EXISTING BASEMENT

REBUILD DECK

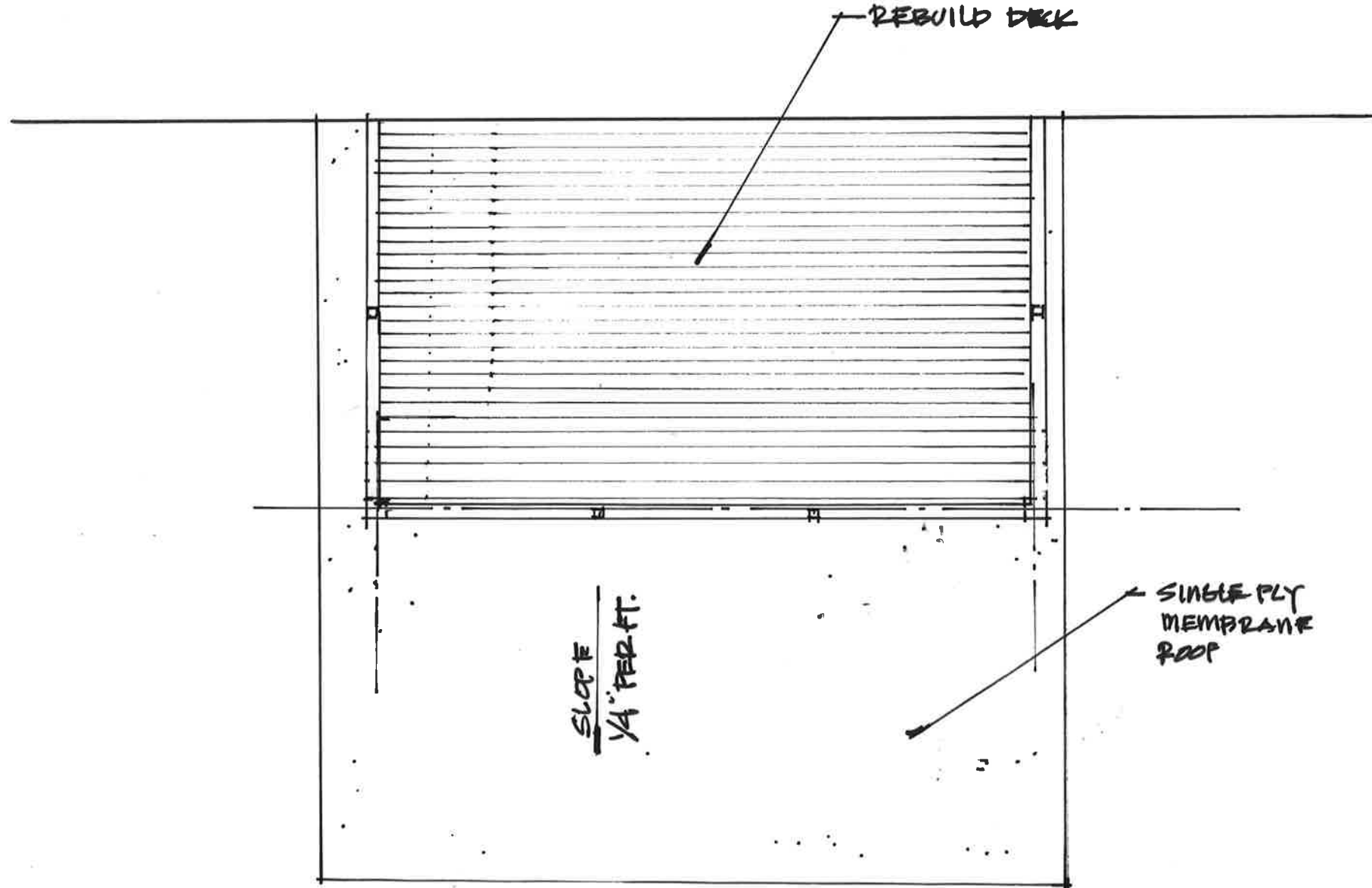

SINGLE PLY
MEMBRANE
ROOF

SLOPE
1/4"
PER FT.

ROOF / DECK
1/4" = 1'-0"

EXISTING BASEMENT

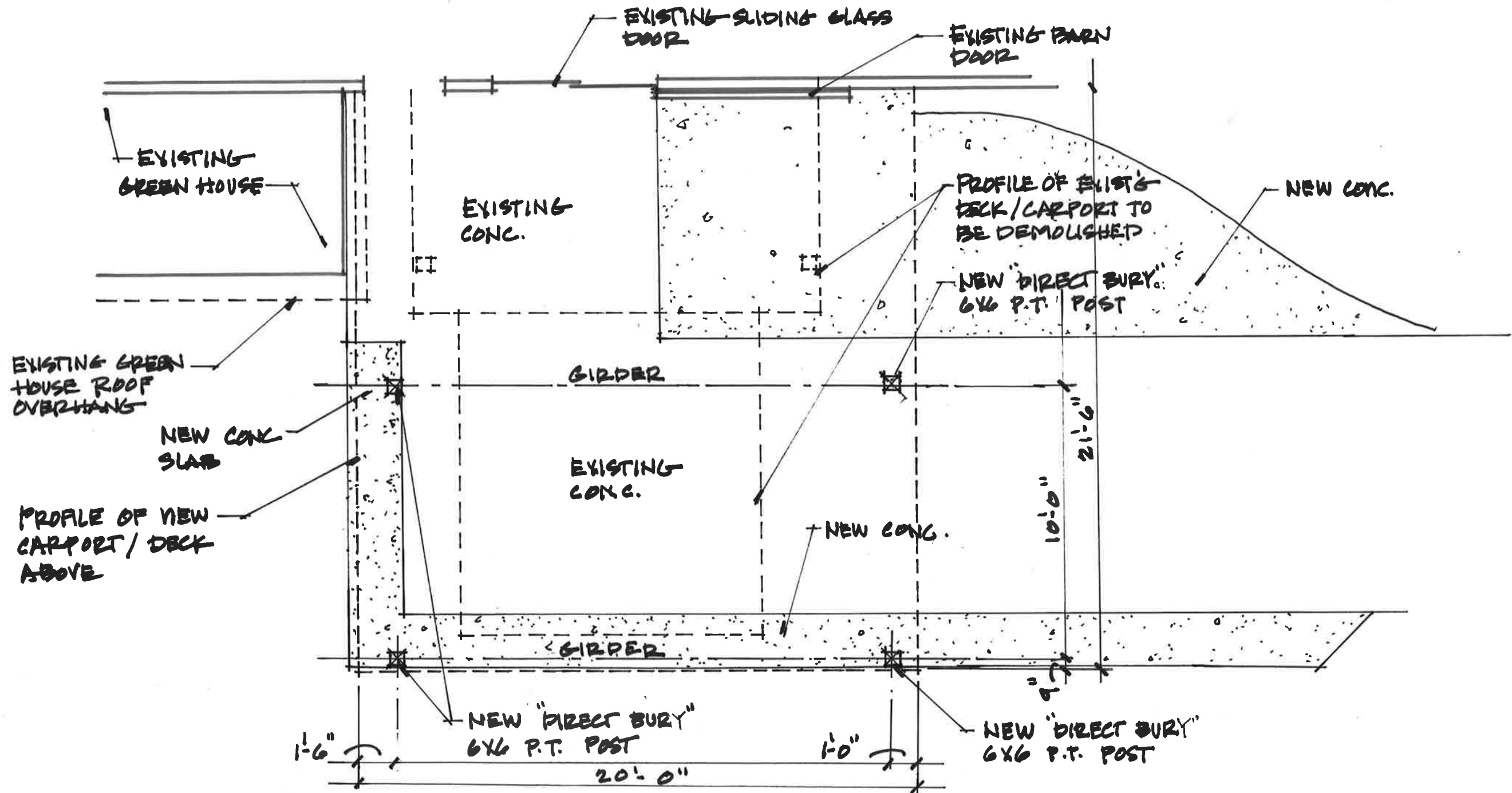

PLAN
1/4" = 1'-0"



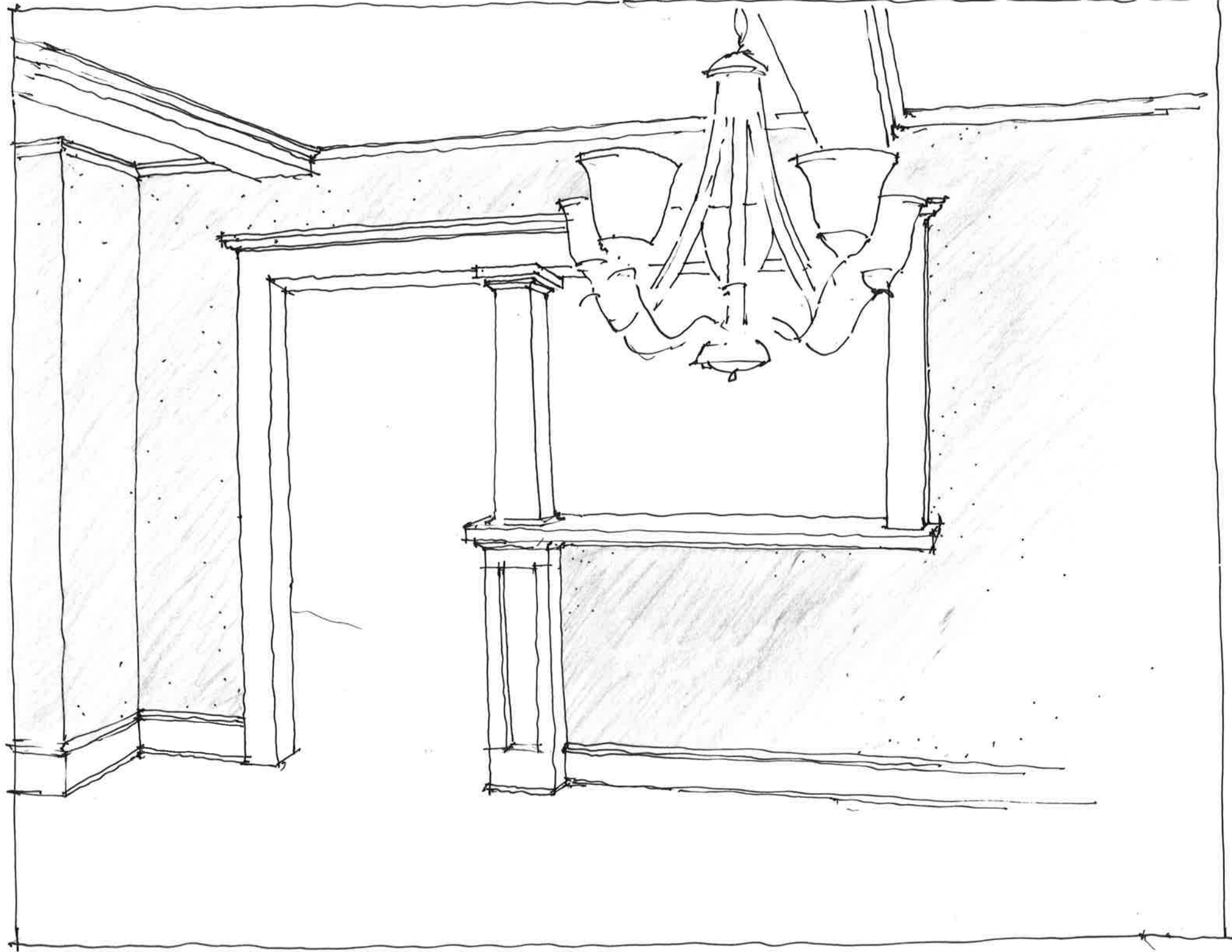

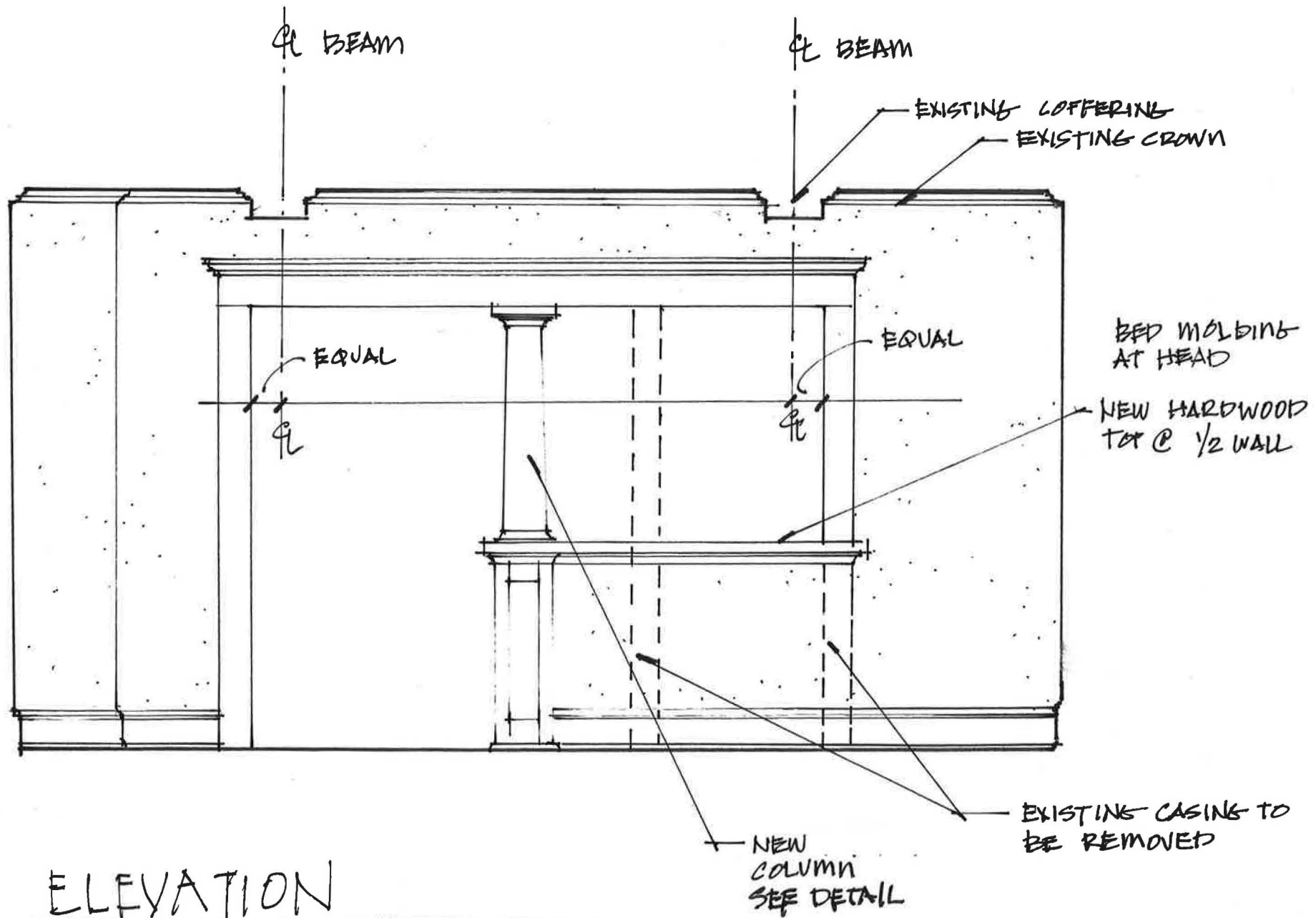

ELEVATION

1/2" = 1'-0"

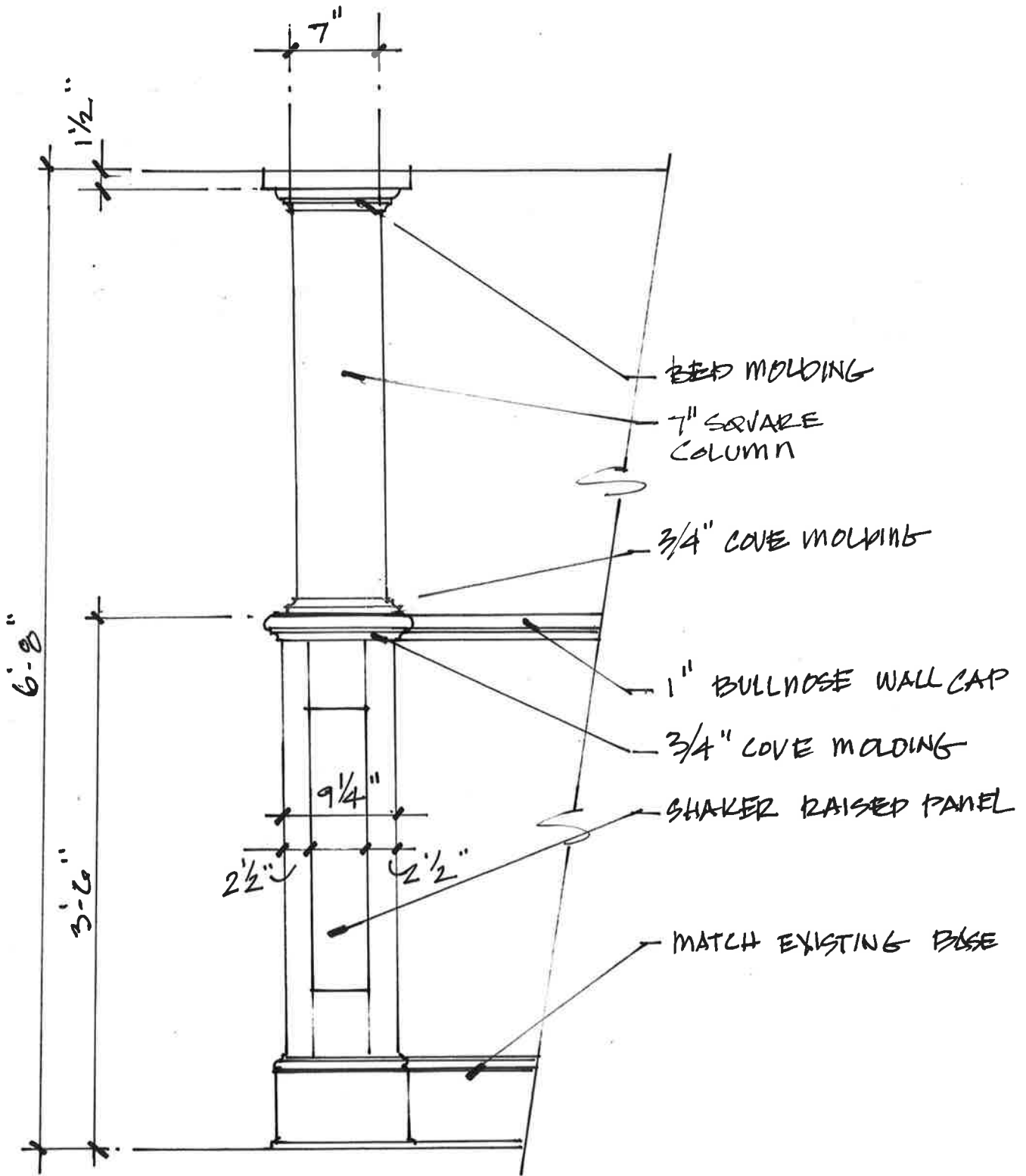

COLUMN DETAIL

1" = 1'-0"