

MEADE CONCRETE COMPANY LLC

W10440 Cty Rd K, P.O. Box 167 Lodi, WI 53555

(608) 592-3803 FAX (608) 592-3804

info@meadeconcrete.com

2000 GALLON SEPTIC/PUMP/SIPHON/HOLDING

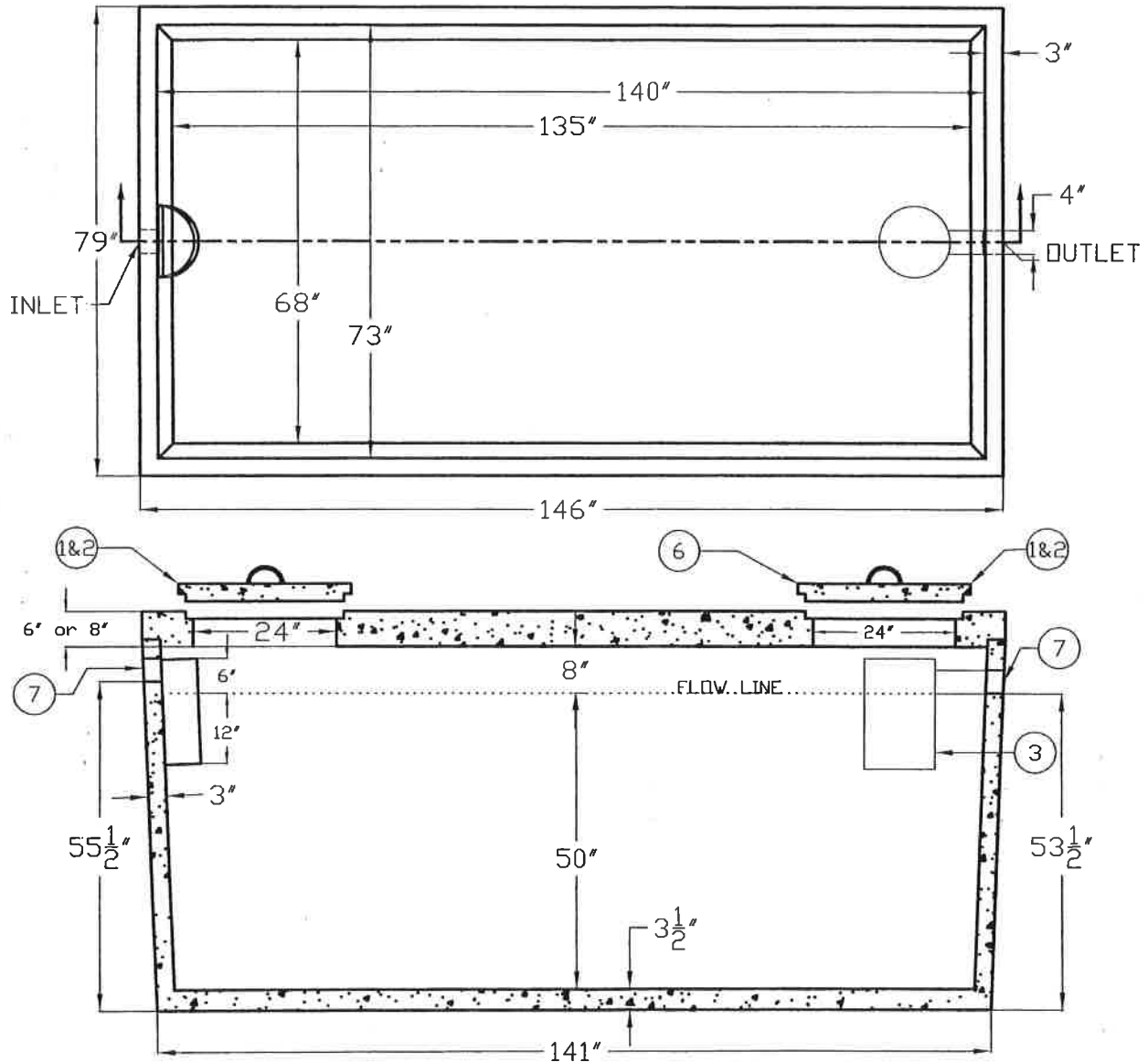

Note:

- 1) 24" manhole opening over inlet and 4" opening over outlet only for holding tanks.
- 2) 4" opening over inlet and 24" manhole opening over outlet for pump and siphon tanks.
- 3) Baffle or filter are not required for pump, siphon, or holding tanks.
- 4) Tank can only be used as septic tank when it is not the first unit in a series of tanks.
- 5) Inlet is taken in thru a 1 foot manhole rise pipe with 4" press-seal gasket.
- 6) 4" Sch 40 pipe cast into manhole cover for venting on pump, siphon and holding tanks.
- 7) 4" Press-seal gasket on inlet and outlet.