

Service 2 unit | BG3

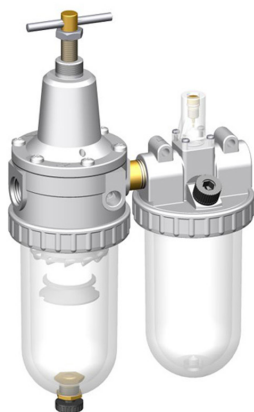

Image shows:
9.3133.00.005.0V

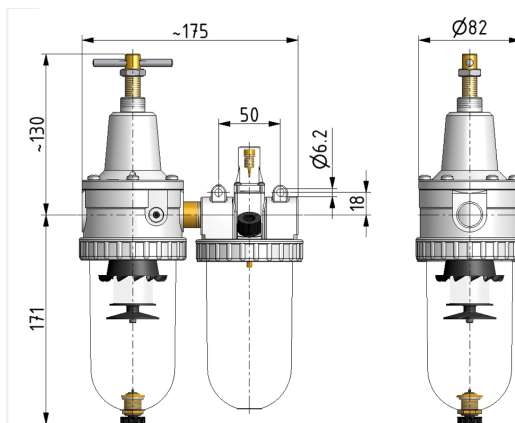
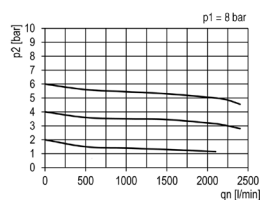
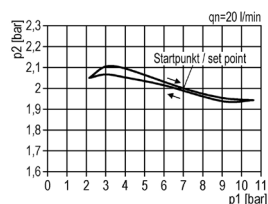

Image shows:
9.3133.00.005.0V

flow characteristic



pressure characteristic



lubricator operating limit

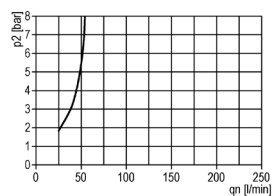

symbol

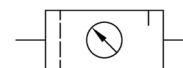

technical data

description: sinter filter centrifugal principle, diaphragm-type pressure with relieving feature, proportional oiler
medium: compressed air, neutral gases
supply pressure P1 min.: 1,5 bar
supply pressure P1 max.: 16 bar
temperature range: -10°C - +60°C
bowl: PC
drain: HA3
mounting: vertical
filter element: 5 µm
bowl volume lubricator: 135 cm³
oil metering qv=1.000l/min: 1 - 2 drops/min
oil type: CL 32 DIN 51517 - ISO VG 32

accessories

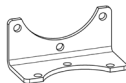

mounting bracket: [BW.30](#)

control panel mounting: nut
DR.11-7

type	part-number	description
FDO.33 HA3	9.3133.00.005.0V	Service 2 unit G1/2 0,5-10 5µm with PC bowl and semi automatic drain
FDO.33 M HA3	9.3133.00.007.0V	Service 2 unit G1/2 0,5-10 5µm with metal bowl and semi automatic drain
FDO.33 HA3 B	9.3133.00.008.0V	Service 2 unit G1/2 0,5-10 5µm with PC bowl, bowl guard and semi automatic drain
FDO.33 AM10	9.3133.00.010.0V	Service 2 unit G1/2 0,5-10 5µm with PC bowl and automatic drain

Service 3 unit

Service 2 unit

Filter regulator

Filter

Pressure regulator

Lubricator

System extensions

Accessories

Special products