

# COMMERCIAL HOSPITALITY FURNITURE

Available for immediate dispatch





YOUR PARTNERS IN HOSPITALITY FURNITURE



# Designed to entice Created to perform

Using the combination of creativity, functionality, quality and indisputable style... the following furniture will offer you long-lasting, practical enjoyment.

This seating collection displays a variety of furniture suitable for all commercial applications including:

- Cafes / Restaurants
- Hotels / Motels
- Clubs
- Offices / Cafeterias
- Churches
- Schools/Universities
- Caterers
- Function Centres / Conference Venues
- Aged Care / Community Centres
- Domestic

And limited only by your imagination!

Whether it's a traditional style café scene or a modern, alfresco setting you wish to create, we have the perfect selection to choose from... achieve the look you desire!

It's the style and superior quality that make our products so unique and special.

## Contents

Chairs .....	4
Stools .....	11
Resin Rattan Seating .....	16
Sunloungers .....	22
Table Tops .....	23
Table Bases .....	27
Tables .....	33
Function Tables and Chairs .....	34





INDOOR/OUTDOOR CHAIRS





## Air Chair



5 YEAR WARRANTY



- Stackable up to 4 high
- Suitable for indoor and outdoor commercial use
- Made of UV stabilised polypropylene reinforced with glass fibre
- Dimensions: 500W x 600D x 820H x 450 Seat Height
- Unit Weight: 3.7kg
- SWL: 150kg
- Supplied assembled
- Weather resistant, UV Stabilised, Glass fibre reinforced
- Stocked In: Anthracite, Black, White, Red, Orange, Green, Taupe, Mango
- Replaceable feet
- CATAS Tested
- Matching Products: Air XL Armchair, Air Barstool
- Made in Europe



## Air XL Armchair



5 YEAR WARRANTY



- Stackable up to 4 high
- Suitable for indoor and outdoor commercial use
- Made of UV stabilised polypropylene reinforced with glass fibre
- Dimensions: 570W x 600D x 815H x 450 Seat Height
- Arm Height: 680H
- Unit Weight: 3.8kg, SWL: 150kg
- Supplied assembled
- Weather resistant, UV Stabilised, Glass fibre reinforced
- Stocked In: Anthracite, Black, White, Red, Orange, Green, Taupe, Mango
- Replaceable feet
- CATAS Tested
- Matching Products: Air Chair, Air Barstool
- Made in Europe



## Ares Chair



5 YEAR WARRANTY



- Stackable
- Suitable for indoor and outdoor commercial use
- Made of UV stabilised polypropylene reinforced with glass fibre
- Dimensions: 475W x 580D x 830H x 450 Seat Height
- Unit Weight: 4.5kg, SWL: 150kg
- Supplied assembled
- Weather resistant, UV Stabilised, Glass fibre reinforced
- Stocked In: Anthracite, Black, White, Chocolate, Taupe
- Replaceable feet
- CATAS Tested
- Matching Products: Artemis Armchair, Ares Barstool
- Made in Europe



## Artemis Armchair



5 YEAR WARRANTY



- Stackable
- Suitable for indoor and outdoor commercial use
- Made of UV stabilised polypropylene reinforced with glass fibre
- Dimensions: 565W x 580D x 830H x 450 Seat Height
- Arm Height: 675H
- Unit Weight: 5kg, SWL: 150kg
- Supplied assembled
- Weather resistant, UV Stabilised, Glass fibre reinforced
- Stocked In: Anthracite, Black, White, Chocolate, Taupe
- Replaceable feet
- CATAS Tested
- Matching Products: Ares Chair, Ares Barstool
- Made in Europe



## Avoca Chair



2 YEAR WARRANTY

DURAFURN.

- Stackable
- Suitable for indoor commercial use only
- Seat: 10mm Basswood veneer bentwood shell with lacquer finish
- Frame: Heavy duty DIA22.2 x 1.8mm tube chrome legs
- Dimensions: 515W x 550D x 860H x 450 Seat Height
- Unit Weight: 4kg
- SWL: 120kg
- Supplied unassembled - easy to assemble
- Stocked In: Black, White, Beech
- Replaceable feet
- Matching Products: Avoca Barstool
- Made in China



## Avoca PVC Chair



- Stackable
- Suitable for indoor commercial use only
- Seat: 10MM Basswood veneer bentwood shell, foam lined with PVC finish and stitched edge
- Frame: Heavy duty DIA22.2 x 1.8MM tube chrome legs
- Dimensions: 515W x 550D x 860H x 450 Seat Height
- Unit Weight: 4kg
- SWL: 120kg
- Supplied unassembled - easy to assemble
- Stocked In: Black
- Replaceable feet
- Matching Products: Avoca PVC Barstool
- Made in China



## Corio Mk2 Chair



- Stackable
- Suitable for indoor commercial use only
- Seat: Quality PU vinyl
- Frame: Heavy duty welded tubes chrome legs
- Dimensions: 430W x 600D x 930H x 500 Seat Height
- Unit Weight: 5kg
- SWL: 120kg
- Supplied unassembled - easy to assemble
- Stocked In: Black, Chocolate
- Replaceable feet
- Matching Products: Corio Mk2 Barstool
- Made in China



## Diva Chair



- Stackable
- Suitable for indoor and outdoor commercial use
- Made of UV stabilised polypropylene reinforced with glass fibre
- Dimensions: 575W x 520D x 850H x 470 Seat Height
- Arm Height: 650H
- Unit Weight: 5kg, SWL: 150kg
- Supplied assembled
- Weather resistant, UV Stabilised, Glass fibre reinforced
- Stocked In: Anthracite, Black, Green, Silver Grey, Red, White
- Special Order Colours: Light Blue
- Replaceable feet, Drainage hole available at an extra cost
- CATAS Tested
- Made in Europe



## Dolce Chair



- Stackable
- Suitable for indoor and outdoor commercial use
- Seat: Made of UV stabilised polypropylene
- Legs: Strong DIA25MM anodized aluminium legs - Will not rust
- Dimensions: 555W x 570D x 800H x 450 Seat Height
- Arm Height: 655H
- Unit Weight: 4kg, SWL: 150kg
- Supplied assembled, Weather resistant, UV Stabilised
- Stocked In: Anthracite, Black, Green, Orange, Red, White
- Special Order Colours: Beige
- Replaceable feet, Drainage hole available at an extra cost
- Matching Products: Vita Chair, Gio Barstool
- Made in Europe



## Florence Chair - Timber Seat



- Suitable for indoor commercial use only
- Seat: Stain finish solid European beech
- Frame: Quality stain finish solid European beech
- Dimensions: 440W x 440D x 850H x 460 Seat Height
- Unit Weight: 8kg
- SWL: 120kg
- Chair frame comes assembled - seat is to be installed with screws supplied (Chair can be supplied assembled at extra cost)
- Stocked In: Chocolate, Natural
- Matching Products: Florence Barstool - Timber Seat
- Made in China





## Florence Chair - Vinyl Seat



- Suitable for indoor commercial use only
- Seat: Quality foam and vinyl (Chocolate and Black)
- Frame: Quality stain finish solid European beech
- Dimensions: 440W x 440D x 850H x 480 Seat Height
- Unit Weight: 8kg
- SWL: 120kg
- Chair frame comes assembled - seat is to be installed with screws supplied (Chair can be supplied assembled at extra cost)
- Stocked In: Chocolate, Natural
- Matching Products: Florence Barstool - Vinyl Seat
- Made in China



## Genoa Chair - Timber Seat



- Suitable for indoor commercial use only
- Seat: Stain finish solid European beech wood
- Frame: Quality stain finish solid European beech wood with Steel bracing
- Dimensions: 425W x 425D x 810H x 450 Seat Height
- Unit Weight: 9kg
- SWL: 120 kg
- Supplied unassembled - easy to assemble (Chair can be supplied assembled at extra cost)
- Stocked In: Antique Walnut
- Matching Products: Genoa Stool - Timber Seat, Genoa Barstool - Timber Seat
- Made in China



## Genoa Chair - Vinyl Seat



- Suitable for indoor commercial use only
- Seat: Vinyl Seat
- Frame: Quality stain finish solid European beech wood with Steel bracing
- Dimensions: 425W x 425D x 810H x 480 Seat Height
- Unit Weight: 8kg
- SWL: 120 kg
- Supplied unassembled - easy to assemble (Chair can be supplied assembled at extra cost)
- Stocked In: Antique Walnut Stain & Dark Tan Vinyl
- Matching Products: Genoa Stool - Vinyl Seat, Genoa Barstool - Vinyl Seat
- Made in China



## Lagoa Chair



- Stackable
- Suitable for indoor and outdoor commercial use
- Seat & Back: DIA4MM wire reinforced UV stabilized PE Wicker
- Frame: Fully welded heavy duty DIA30 x 1.8MM aluminium tubes legs
- Dimensions: 530W x 620D x 710H x 460 Seat Height
- Arm Height: 590 to 660
- Unit Weight: 4kg
- SWL: 120kg
- Supplied assembled
- Stocked In: Black & Honey with polished anodized aluminium legs
- Replaceable feet
- Made in China



## Madrid Aluminium Chair



- Stackable
- Suitable for indoor and outdoor commercial use
- Seat & Back: Riveted aluminium slat
- Frame: Fully welded heavy duty aluminium legs
- Dimensions: 565W x 630D x 720H x 435 Seat Height
- Arm Height: 590 to 660
- Unit Weight: 3kg
- SWL: 120kg
- Supplied assembled
- Stocked In: Polished anodized aluminium finish
- Replaceable feet
- Made in China



# Madrid Wicker Chair



- Stackable
- Suitable for indoor and outdoor commercial use
- Seat & Back: DIA4MM wire reinforced UV stabilized PE Wicker
- Frame: Fully welded heavy duty aluminium legs
- Dimensions: 560W x 615D x 720H x 430 Seat Height
- Arm Height: 590 to 660
- Unit Weight: 4kg
- SWL: 120kg
- Supplied assembled
- Stocked In: Blue with polished anodized aluminium legs
- Replaceable feet
- Made in China



# Maya Chair



- Stackable
- Suitable for indoor and outdoor commercial use
- Made of UV stabilised polypropylene reinforced with glass fibre
- Dimensions: 460W x 535D x 815H x 450 Seat Height
- Unit Weight: 4kg
- SWL: 150kg
- Supplied assembled
- Weather resistant, UV Stabilised, Glass fibre reinforced
- Stocked In: Anthracite, Black, Orange, Silver Grey, White, Green
- Replaceable feet
- CATAS Tested
- Matching Products: Maya Barstool
- Made in Europe



# Ottoman



- Suitable for indoor commercial use only
- Seat: Quality vinyl
- Frame: Strong timber frame
- Dimensions Cube: 430W x 430D x 450 Seat Height
- Dimensions Rectangle: 1200W x 430D x 450 Seat Height
- Cube Unit Weight: 6kg
- Rectangle Unit Weight: 13kg
- SWL: 120kg
- Cube Stocked In: Black, Chocolate, Red, Orange & Green
- Rectangle Stocked In: Black, Chocolate, Red
- Replaceable feet
- Made in China



# Palm Armchair



- Stackable up to 6 high
- Suitable for indoor and outdoor commercial use
- Seat & Back: Flat wire reinforced UV stabilized PE Wicker
- Frame: Fully welded heavy duty aluminium legs
- Dimensions: 560W x 550D x 880H x 450 Seat Height
- Arm Height: 665
- Unit Weight: 5kg
- SWL: 120kg
- Supplied assembled
- Stocked In: Chocolate
- Replaceable feet
- Matching Products: Palm Chair, Palm Barstool
- Made in China



# Palm Chair



- Stackable up to 6 high
- Suitable for indoor and outdoor commercial use
- Seat & Back: Flat wire reinforced UV stabilized PE Wicker
- Frame: Fully welded heavy duty aluminium legs
- Dimensions: 460W x 570D x 900H x 460 Seat Height
- Unit Weight: 5kg
- SWL: 120kg
- Supplied assembled
- Stocked In: Chocolate
- Replaceable feet
- Matching Products: Palm Armchair, Palm Barstool
- Made in China





## Plus Chair



5 YEAR WARRANTY



- Stackable
- Suitable for indoor or outdoor use
- Made of UV stabilised polypropylene reinforced with glass fibre
- Dimensions: W580 x D550 x H840 Seat Height 470
- Unit Weight: 4.5kg
- SWL: 150Kg
- Supplied assembled
- Weather resistant, UV Stabilised, Glass fibre reinforced
- Stocked in: Black, Red, White
- Made in Europe



## Snow Chair



5 YEAR WARRANTY



- Stackable
- Suitable for indoor or outdoor use
- Made of UV stabilised polypropylene reinforced with glass fibre
- Dimensions: W520 x D560 x H830 Seat Height 470
- Unit Weight: 4.4kg
- SWL: 150Kg
- Supplied assembled
- Weather resistant, UV Stabilised, Glass fibre reinforced
- Level 4 AFRDI Approved - Black
- Stocked in: Black, Red, Anthracite, Taupe, Mango, White
- Made in Europe



## Vetro Chair



2 YEAR WARRANTY

DURAFURN.

- Stackable
- Suitable for indoor commercial use only
- Seat: Quality vinyl
- Frame: Strong durable fully welded aluminium frame with timber look legs
- Dimensions: 470W x 570D x 940H x 480 Seat Height
- Unit Weight: 6kg
- SWL: 120kg
- Supplied assembled
- Stocked In: Black Vinyl - Brown Legs, Chocolate Vinyl - Brown Legs
- Made in China



## Vienna Chair - Timber Seat



2 YEAR WARRANTY

DURAFURN.

- Suitable for indoor commercial use only
- Seat: Stain finish solid European Beech
- Frame: Quality stain finish solid European beech wood
- Dimensions: 390W x 420D x 780H x 460 Seat Height
- Unit Weight: 6kg
- SWL: 120kg
- Chair frame comes assembled - seat is to be installed with screws supplied (Chair can be supplied assembled at extra cost)
- Stocked In: Chocolate, Natural
- Matching Products: Vienna Barstool - Timber Seat
- Made in China



## Vita Chair



5 YEAR WARRANTY



- Stackable up to 6 high
- Suitable for indoor and outdoor commercial use
- Seat: Made of UV stabilised polypropylene
- Legs: Strong DIA25MM anodized aluminium legs - Will not rust
- Dimensions: 485W x 570D x 800H x 450 Seat Height
- Unit Weight: 3kg, SWL: 150kg, Supplied assembled
- Weather resistant, UV Stabilised
- Stocked In: Anthracite, Black, Green, Orange, Red, White
- Special Order Colours: Beige
- Replaceable feet, Drainage hole available at an extra cost
- Level 4 AFRDI Approved - Black
- Matching Products: Dolce Armchair, Gio Barstool
- Made in Europe



# Zeb Chair

2 YEAR WARRANTY DURA FURN.

- Stackable
- Suitable for indoor commercial use only
- Seat: Quality vinyl
- Frame: Strong durable fully welded steel frame
- Dimensions: 460W x 570D x 960H x 460 Seat Height
- Unit Weight: 7kg
- SWL: 120kg
- Supplied assembled
- Stocked In: Black Vinyl - Black Legs
- Made in China



# Chair Trolley



2 YEAR WARRANTY

- Suitable for Vita, Dolce, Diva, Maya, Ares, Artemis, Verona, Capri, Florida & Ibiza Chairs.
- Made with a strong durable fully welded steel frame and foam filled tyres
- Unit Weight: 30kg
- Supplied assembled
- Stocked In: Black hammer tone
- Replaceable tyres and stacking crates



# Seating Guide

## Circle

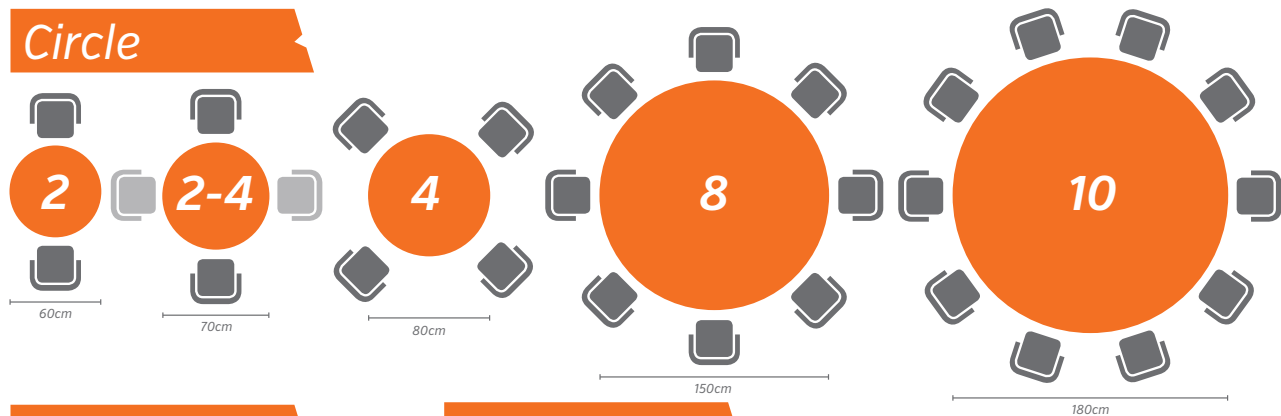

## Rectangle

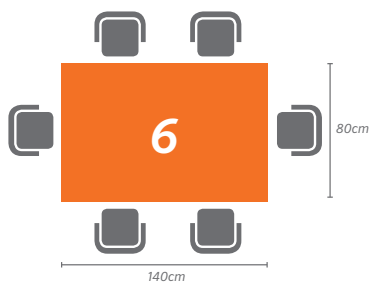

## Square

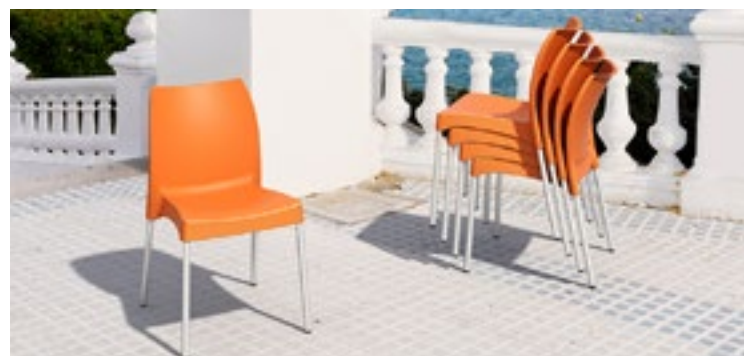
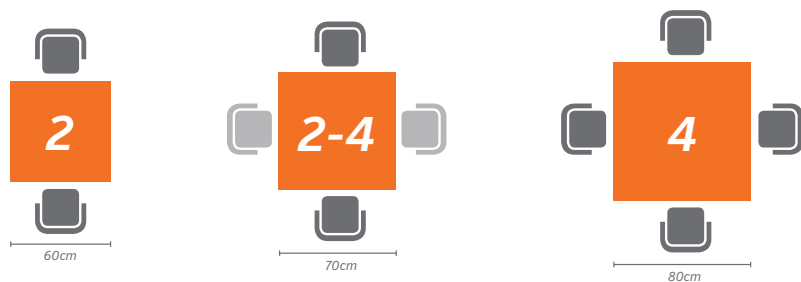





INDOOR/OUTDOOR STOOLS



## Air Barstool 65/75



5 YEAR WARRANTY



- Suitable for indoor and outdoor commercial use
- Made of UV stabilised polypropylene reinforced with glass fibre
- Dimensions:  
65: 440W x 540D x 950H x 650 Seat Height  
75: 440W x 540D x 1050H x 750 Seat Height
- Unit Weight: 5kg
- SWL: 135kg
- Supplied unassembled - easy to assemble
- Weather resistant, UV Stabilised, Glass fibre reinforced
- Stocked In: Anthracite, Black, White, Red, Orange, Green, Taupe
- Replaceable feet
- CATAS Tested
- Matching Products: Air Chair, Air XL Armchair
- Made in Europe



## Ares Barstool



5 YEAR WARRANTY



- Stackable
- Suitable for indoor and outdoor commercial use
- Made of UV stabilised polypropylene reinforced with glass fibre
- Dimensions: 480W x 580D x 820H x 750 Seat Height
- Unit Weight: 6.2kg
- SWL: 135kg
- Supplied assembled
- Weather resistant, UV Stabilised - Will not fade under direct sunlight
- Stocked in: Anthracite, Black, White, Chocolate, Taupe
- Made in Europe



## Avoca Stool



2 YEAR WARRANTY

DURAFURN.

- Stackable
- Suitable for indoor commercial use only
- Seat: 10MM Basswood veneer bentwood shell with lacquer finish
- Frame: Fully welded heavy duty DIA19 x 1.8MM tube chrome legs
- Dimensions: 440W x 540D x 1050H x 750 Seat Height
- Unit Weight: 6kg
- SWL: 120kg
- Supplied unassembled - easy to assemble
- Stocked In: Black, White, Beech
- Replaceable feet
- Matching Products: Avoca Chair
- Made in China



## Avoca Stool - PVC



2 YEAR WARRANTY

DURAFURN.

- Stackable
- Suitable for indoor commercial use only
- Seat: 10MM Basswood veneer bentwood shell, foam lined with PVC finish and stitched edge
- Frame: Heavy duty DIA19 x 1.8MM tube chrome legs
- Dimensions: 485W x 470D x 960H x 750 Seat Height
- Unit Weight: 6kg
- SWL: 120kg
- Supplied unassembled - easy to assemble
- Stocked In: Black
- Replaceable feet
- Matching Products: Avoca PVC Chair
- Made in China





## Block Stool



- Suitable for indoor commercial use only
- Seat: Quality vinyl
- Frame: Fully welded heavy duty 25x25x1.5MM 304 grade stainless steel frame
- Dimensions: 390W x 390D x 820 Seat Height
- Unit Weight: 5kg
- SWL: 120kg
- Supplied assembled
- Stocked In: Black Vinyl - Brushed Stainless Steel Frame
- Replaceable feet
- Made in China



## Corio Mk2 Barstool



- Stackable
- Suitable for indoor commercial use only
- Seat: Quality vinyl
- Frame: Fully welded heavy duty tube chrome leg frame
- Dimensions: 470W x 510D x 1025H x 765 Seat Height
- Unit Weight: 6kg
- SWL: 120kg
- Supplied unassembled - easy to assemble
- Stocked In: Black, Chocolate
- Replaceable feet
- Matching Products: Corio Mk2 Chair
- Made in China



## Cruza Stool



- Suitable for indoor and outdoor commercial use
- Supplied Frame Only: Fully Welded Heavy Duty Brushed 304 Grade Stainless Steel
- Optional Featured Seat: Werzalit by Gentas Stool Top DIA340 - See page 24
- Dimensions: 380W x 380D x 760 Seat Height
- Unit Weight: 8kg
- SWL: 120kg
- Frame supplied assembled (seat can be attached at extra cost)
- Replaceable feet
- Frame made in Australia
- Seat made in Europe



## Florence Stool - Timber Seat



- Suitable for indoor commercial use only
- Seat: Stain finish solid European beech
- Frame: Quality stain finish solid European beech
- Dimensions: 440W x 440D x 1100H x 750 Seat Height
- Unit Weight: 10kg
- SWL: 120kg
- Chair frame comes assembled - seat is to be installed with screws supplied (Chair can be supplied assembled at extra cost)
- Stocked In: Chocolate, Natural
- Matching Products: Florence Chair - Timber Seat
- Made in China



## Florence Stool - Vinyl Seat



- Suitable for indoor commercial use only
- Seat: Quality foam and vinyl (Chocolate and Black)
- Frame: Quality stain finish solid European Beech
- Dimensions: 440W x 440D x 1100H x 780 Seat Height
- Unit Weight: 10kg
- SWL: 120kg
- Chair frame comes assembled - seat is to be installed with screws supplied (Chair can be supplied assembled at extra cost)
- Stocked In: Chocolate, Natural
- Matching Products: Florence Chair - Vinyl Seat
- Made in China



## Genoa Stool & Barstool - Timber Seat



- Suitable for indoor commercial use only
- Seat: Stain finish solid European beech wood
- Frame: Quality stain finish solid European beech wood with Steel bracing
- Barstool Dimensions:  
65: 425W x 425D x 1010H x 650 Seat Height  
75: 425W x 425D x 1090H x 730 Seat Height
- Stool Dimensions:  
45: 425W x 425D x 450 Seat Height  
65: 425W x 425D x 650 Seat Height  
75: 425W x 425D x 730 Seat Height
- Barstool Unit Weight: 10kg
- Stool Unit Weight: 8kg
- SWL: 120 kg
- Supplied unassembled – easy to assemble
- Stocked In: Antique Walnut
- Made in South East Asia



## Genoa Stool & Barstool - Vinyl Seat



- Suitable for indoor commercial use only
- Seat: Vinyl Seat
- Frame: Quality stain finish solid European beech wood with Steel bracing
- Barstool Dimensions:  
65: 425W x 425D x 1010H x 680 Seat Height  
75: 425W x 425D x 1090H x 760 Seat Height
- Stool Dimensions:  
45: 425W x 425D x 480 Seat Height  
65: 425W x 425D x 680 Seat Height  
75: 425W x 425D x 760 Seat Height
- Barstool Unit Weight: 9kg
- Stool Unit Weight: 7kg
- SWL: 120 kg
- Supplied unassembled – easy to assemble
- Stocked In: Antique Walnut
- Made in South East Asia



## Gio Stool



- Stackable
- Suitable for indoor and outdoor commercial use
- Seat: Made of UV stabilised polypropylene
- Legs: Strong 25x25MM anodised aluminium legs - Will not rust
- Dimensions: 470W x 490D x 955H x 765 Seat Height
- Unit Weight: 4kg
- SWL: 135kg
- Supplied assembled
- Weather resistant, UV Stabilised
- Stocked In: Black, Green, Red, Orange, White
- Special Order Colours: Beige
- Replaceable feet
- Matching Products: Vita Chair, Dolce Armchair
- Made in Europe





# Maya Barstool 65/75



5 YEAR WARRANTY



- Stackable
- Suitable for indoor and outdoor commercial use
- Made of UV stabilised polypropylene reinforced with glass fibre
- Dimensions: 440W x 500D x 980H x 650 Seat Height
- Unit Weight: 5kg
- SWL: 135 kg
- Supplied assembled
- Weather resistant, UV Stabilised
- Stocked in: Black, Anthracite, Taupe, White
- Matching product to the Maya Chair
- Made in Europe



# Palm Stool



2 YEAR WARRANTY

DURAFURN

- Suitable for indoor and outdoor commercial use
- Seat & Back: Flat wire reinforced UV stabilized PE Wicker
- Frame: Fully welded heavy duty aluminium legs
- Dimensions: 470W x 530D x 1100H x 780 Seat Height
- Unit Weight: 5kg
- SWL: 120kg
- Supplied assembled
- Stocked In: Chocolate
- Replaceable feet
- Matching Products: Palm Chair, Palm Armchair
- Made in China



# Vienna Stool - Timber Seat



2 YEAR WARRANTY

DURAFURN

- Suitable for indoor commercial use only
- Seat: Stain finish solid European beech
- Frame: Quality stain finish solid European beech
- Dimensions: 390W x 420D x 1070H x 760 Seat Height
- Unit Weight: 6kg
- SWL: 120kg
- Chair frame comes assembled - seat is to be installed with screws supplied (Chair can be supplied assembled at extra cost)
- Stocked In: Chocolate, Natural
- Matching Products: Vienna chair - Timber Seat
- Made in China



## HOW TO CHOOSE

# The Right Stool Height

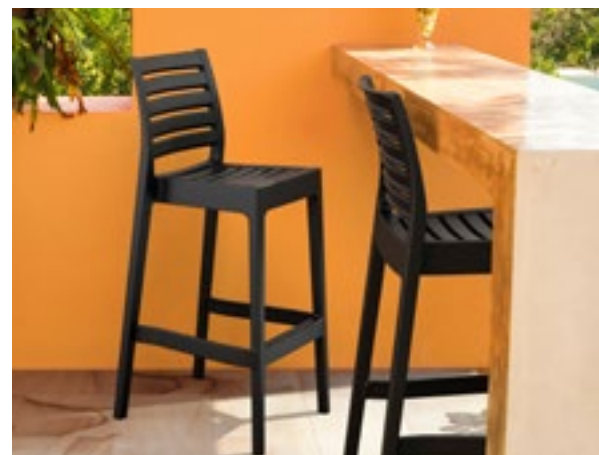
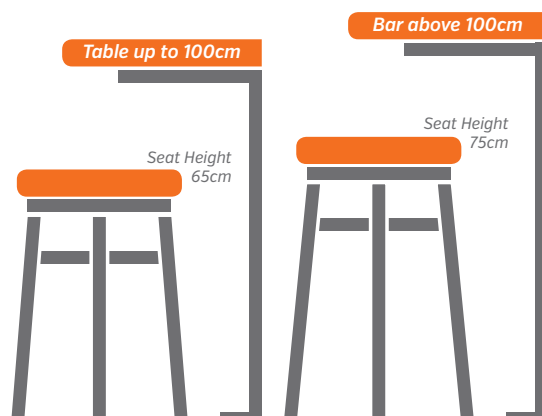

RESIN RATTAN RANGE





## Aruba Armchair



5 YEAR WARRANTY



- Stackable
- Suitable for indoor and outdoor commercial use
- Made of UV stabilised polypropylene reinforced with glass fibre
- Seat: Beige cushion available at an extra cost - 50mm thick cushion covered with polyester fabric & finished with piping, washable & suitable for outdoor use
- Dimensions: 740W x 750D x 800H x 440 Seat Height
- Arm Height: 650 up to 750 H
- Unit Weight: 7.5kg, SWL: 150kg, Supplied assembled
- Weather resistant, UV Stabilised, Glass fibre reinforced
- Stocked In: Anthracite, Chocolate - Special Order Colours: White
- Replaceable feet, CATAS Tested
- Matching Products: All Resin Rattan Range Products
- Made in Europe
- 3 Month warranty on cushions



## California Tub Chair



5 YEAR WARRANTY



- Suitable for indoor and outdoor commercial use
- Made of UV stabilised polypropylene reinforced with glass fibre
- Seat: Beige cushion available at an extra cost - 50mm thick cushion covered with polyester fabric & finished with piping, washable & suitable for outdoor use
- Dimensions: 590W x 630D x 900H x 420 Seat Height
- Arm Height: 650H
- Unit Weight: 10kg, SWL: 150kg, Supplied unassembled - easy to assemble
- Weather resistant, UV Stabilised, Glass fibre reinforced
- Stocked In: Anthracite, Chocolate - Special Order Colours: White
- Replaceable feet
- CATAS Tested
- Matching Products: All Resin Rattan Range Products
- Made in Europe
- 3 Month warranty on cushions



## Capri Chair



5 YEAR WARRANTY



- Stackable
- Suitable for indoor and outdoor commercial use
- Made of UV stabilised polypropylene reinforced with glass fibre
- Dimensions: 560W x 600D x 840H x 450 Seat Height
- Arm Height: 660H
- Unit Weight: 4kg, SWL: 150kg, Supplied assembled
- Weather resistant, UV Stabilised, Glass fibre reinforced
- Stocked In: Anthracite, Chocolate - Special Order Colours: White
- Replaceable feet
- CATAS Tested
- Matching Products: Verona Chair, All Resin Rattan Range Products
- Made in Europe



## Daytona Chair



5 YEAR WARRANTY



- Stackable
- Suitable for indoor and outdoor commercial use
- Made of UV stabilised polypropylene reinforced with glass fibre
- Dimensions: 550W x 610D x 810H x 450 Seat Height
- Unit Weight: 3.5kg, SWL: 150kg
- Supplied assembled
- Weather resistant, UV Stabilised, Glass fibre reinforced
- Stocked In: Anthracite, Chocolate
- Special Order Colours: White
- Replaceable feet
- CATAS Tested
- Matching Products: Panama Armchair, All Resin Rattan Range Products
- Made in Europe



## Florida Chair



5 YEAR WARRANTY



- Stackable
- Suitable for indoor and outdoor commercial use
- Made of UV stabilised polypropylene reinforced with glass fibre
- Dimensions: 450W x 550D x 880H x 460 Seat Height
- Unit Weight: 4kg, SWL: 150kg
- Supplied assembled
- Weather resistant, UV Stabilised, Glass fibre reinforced
- Stocked In: Anthracite, Chocolate
- Special Order Colours: White
- Replaceable feet
- CATAS Tested
- Matching Products: Ibiza Armchair, Jamaica Barstool, All Resin Rattan Range Products
- Made in Europe



## Ibiza Armchair



5 YEAR WARRANTY



- Stackable
- Suitable for indoor and outdoor commercial use
- Made of UV stabilised polypropylene reinforced with glass fibre
- Dimensions: 570W x 550D x 880H x 460 Seat Height
- Arm Height: 650H
- Unit Weight: 5.5kg, SWL: 150kg, Supplied assembled
- Weather resistant, UV Stabilised, Glass fibre reinforced
- Stocked In: Anthracite, Chocolate
- Special Order Colours: White
- Replaceable feet
- CATAS Tested
- Matching Products: Florida Chair, Jamaica Barstool, All Resin Rattan Range Products
- Made in Europe



## Jamaica Barstool



5 YEAR WARRANTY



- Stackable
- Suitable for indoor and outdoor commercial use
- Made of UV stabilised polypropylene reinforced with glass fibre
- Dimensions: 430W x 490D x 110H x 750 Seat Height
- Unit Weight: 5kg, SWL: 135kg
- Supplied assembled
- Weather resistant, UV Stabilised, Glass fibre reinforced
- Stocked In: Anthracite, Chocolate
- Special Order Colours: White
- Replaceable feet
- CATAS Tested
- Matching Products: Florida Chair, Ibiza Armchair, All Resin Rattan Range Products
- Made in Europe



## Panama Armchair



5 YEAR WARRANTY



- Stackable
- Suitable for indoor and outdoor commercial use
- Made of UV stabilised polypropylene reinforced with glass fibre
- Dimensions: 580W x 640D x 800H x 450 Seat Height
- Arm Height: 680 - 780H
- Unit Weight: 5kg, SWL: 150kg, Supplied assembled
- Weather resistant, UV Stabilised, Glass fibre reinforced
- Stocked In: Anthracite, Chocolate
- Special Order Colours: White
- Replaceable feet
- CATAS Tested
- Matching Products: Daytona Chair, All Resin Rattan Range Products
- Made in Europe



## Verona Chair



5 YEAR WARRANTY



- Stackable
- Suitable for indoor and outdoor commercial use
- Made of UV stabilised polypropylene reinforced with glass fibre
- Dimensions: 470W x 600D x 840H x 455 Seat Height
- Unit Weight: 3.6kg, SWL: 150kg, Supplied assembled
- Weather resistant, UV Stabilised, Glass fibre reinforced
- Stocked In: Anthracite, Chocolate
- Special Order Colours: White
- Replaceable feet
- CATAS Tested
- Matching Products: Capri Armchair, All Resin Rattan Range Products
- Made in Europe



## Bali Table - 940x940



5 YEAR WARRANTY



- Suitable for indoor and outdoor commercial use
- Top: 5MM dark tempered glass top
- Frame: Aluminium frame covered with UV stabilised polypropylene
- Dimensions: 940W x 940D x 750H
- Unit Weight: 22kg
- Supplied unassembled - easy to assemble
- Weather resistant, UV Stabilised
- Stocked In: Anthracite, Chocolate - Special Order Colours: White
- 4 x adjustable Feet
- Replaceable feet
- CATAS Tested
- Matching Products: Tahiti Table, All Resin Rattan Range Products
- Made in Europe



## Ibiza Table



5 YEAR WARRANTY



- Suitable for indoor and outdoor commercial use.
- Available Sizes: 800x800SQ, 1400x800RCT, 1800x900RCT
- Unit Weights: 800x800 - 18kg, 1400x800 - 31kg, 1800x900 - 41kg
- Supplied unassembled - easy to assemble
- Weather resistant, UV Stabilised
- Stocked In: Anthracite, Chocolate - Special Order Colours: White
- Made in Europe
- Matching Products: All other products in the Resin Rattan Range



## Tahiti Table - 1800x940



5 YEAR WARRANTY



- Suitable for indoor and outdoor commercial use
- Top: 5MM dark tempered glass top
- Frame: Aluminium frame covered with UV stabilised polypropylene
- Dimensions: 1800W x 940D x 750H
- Unit Weight: 32kg
- Supplied unassembled - easy to assemble
- Weather resistant, UV Stabilised
- Stocked In: Anthracite, Chocolate - Special Order Colours: White
- 4 x adjustable Feet
- Replaceable feet
- CATAS Tested
- Matching Products: Bali Table, All Resin Rattan Range Products
- Made in Europe



## Orlando Table - 800x800



5 YEAR WARRANTY



- Suitable for indoor and outdoor commercial use
- Made with an aluminium frame covered with UV stabilised polypropylene
- Dimensions: 800W x 800D x 750H
- Unit Weight: 14kg
- Supplied unassembled - easy to assemble
- Weather resistant, UV Stabilised
- Stocked In: Anthracite, Chocolate
- Special Order Colours: White
- 4 x adjustable Feet
- Replaceable feet
- Matching Products: Orlando Table 1400x800, All Resin Rattan Range Products
- Made in Europe



## Orlando Table - 1400x800



5 YEAR WARRANTY



- Suitable for indoor and outdoor commercial use
- Made with an aluminium frame covered with UV stabilised polypropylene
- Dimensions: 1400W x 800D x 750H
- Unit Weight: 23kg
- Supplied unassembled - easy to assemble
- Weather resistant, UV Stabilised
- Stocked In: Anthracite, Chocolate - Special Order Colours: White
- 4 x adjustable Feet
- Replaceable feet
- Matching Products: Orlando Table 800x800, All Resin Rattan Range Products
- Made in Europe



## Riva Table & Bar Bases



5 YEAR WARRANTY



- Suitable for indoor and outdoor commercial use
- Made with an aluminium frame (painted) covered with UV stabilised polypropylene
- Table - Maximum Suitable Table Top Size: 800x800 - 15kg  
Dimensions: 450W x 450D x 710H  
Unit Weight: 8kg
- Bar Table - Maximum Suitable Table Top Size: 700x700 - 12kg  
Dimensions: 450W x 450D x 1040H  
Unit Weight: 11kg
- Supplied unassembled - easy to assemble
- Weather resistant, UV Stabilised
- Stocked In: Anthracite, Chocolate
- Special Order Colours: White
- Replaceable feet
- Matching Products: All Resin Rattan Range Products
- Made in Europe





# Monaco Lounge Table



5 YEAR WARRANTY



- Made of durable weather-resistant resin reinforced with glass fibre- will never unravel or rust!
- UV Protected
- Suitable for indoor and outdoor commercial use
- Dimensions: 930L x 550D x 470H
- Stocked in: Anthracite, Chocolate
- Special order colour: White
- Supplied unassembled
- The Monaco Lounge Table is designed for self assembly.
- See assembly video at [www.youtube.com/watch?v=sUikbLgctew](http://www.youtube.com/watch?v=sUikbLgctew)
- Made in Europe



# Monaco Lounge Armchair



5 YEAR WARRANTY



- Made of durable weather-resistant resin reinforced with glass fibre- will never unravel or rust!
- UV Protected
- Suitable for indoor and outdoor commercial use
- Dimensions: 820W x 790D x 790H x 350 Seat Height
- Optional cushions available (seat & back) in Beige only - 7 cm thick cushion covered with polyester fabric and finished with piping
- 3 Month warranty on cushions
- Stocked in: Anthracite, Chocolate
- Special order colour: White
- Supplied unassembled
- The Monaco Lounge Armchair is designed for self assembly.
- See assembly video at [www.youtube.com/watch?v=4QDF06rt6BK](http://www.youtube.com/watch?v=4QDF06rt6BK)
- Made in Europe



# Monaco Lounge Extension



5 YEAR WARRANTY



- Fits with Monaco Lounges
- Made of durable weather-resistant resin reinforced with glass fibre- will never unravel or rust!
- UV Protected
- Suitable for indoor and outdoor commercial use
- Stocked in: Anthracite, Chocolate
- Special order colour: White
- Supplied unassembled
- Made in Europe



# Monaco Lounge Set



5 YEAR WARRANTY



Includes:

- 2 x Monaco Lounge Armchairs (cushions optional)
- 1 x Monaco Lounge Sofa (cushions optional)
- 1 x Monaco Lounge Coffee Table
- Made of durable weather-resistant resin reinforced with glass fibre- will never unravel or rust!
- UV Protected
- Suitable for indoor and outdoor commercial use
- Optional cushions available (seat & back) in Beige only - 7 cm thick cushion covered with polyester fabric and finished with piping - 3 Month warranty on cushions
- Stocked in: Anthracite, Chocolate



- Special order colour: White
- Supplied unassembled
- Made in Europe

# Monaco Lounge Set XL



5 YEAR WARRANTY



Includes:

- 2 x Monaco Lounge Armchairs (cushions optional)
- 1 x Monaco Lounge Sofa XL (cushions optional)
- 1 x Monaco Lounge Coffee Table
- Made of durable weather-resistant resin reinforced with glass fibre- will never unravel or rust!
- UV Protected
- Suitable for indoor and outdoor commercial use
- Optional cushions available (seat & back) in Beige only - 7 cm thick cushion covered with polyester fabric and finished with piping - 3 Month warranty on cushions
- Stocked in: Anthracite, Chocolate



- Special order colour: White
- Supplied unassembled
- Made in Europe

## Tequila Lounge Set



Includes:

- 2 x Tequila Lounge Armchairs (cushions optional)
- 1 x Tequila Lounge Sofa (cushions optional)
- 1 x Tequila Lounge Coffee Table
- 2 x Tequila Side Coffee Tables

- Stocked In: Anthracite, Chocolate



## Tequila Lounge Armchair



- Stackable up to 3 high
- Suitable for indoor and outdoor commercial use
- Made of UV stabilised polypropylene reinforced with glass fibre
- Seat: Beige cushion available at an extra cost - 50mm thick cushion covered with polyester fabric & finished with piping, washable & suitable for outdoor use
- Dimensions: 720W x 760D x 890H x 380 Seat Height
- Arm Height: 670H
- Unit Weight: 9.3kg, SWL: 150kg, Supplied assembled
- Weather resistant, UV Stabilised, Glass fibre reinforced
- Stocked In: Anthracite, Chocolate - Special Order Colours: White
- Replaceable feet, CATAS Tested
- Matching Products: Tequila Lounge Sofa, All Resin Rattan Range Products
- Made in Europe
- 3 Month warranty on cushions



## Tequila Lounge Sofa



- Stackable up to 3 high
- Suitable for indoor and outdoor commercial use
- Made of UV stabilised polypropylene reinforced with glass fibre
- Seat: Beige cushion available at an extra cost - 50mm thick cushion covered with polyester fabric & finished with piping, washable & suitable for outdoor use
- Dimensions: 1280W x 770D x 890H x 380 Seat Height
- Arm Height: 670H
- Unit Weight: 12.5kg, SWL: 150kg, Supplied assembled
- Weather resistant, UV Stabilised, Glass fibre reinforced
- Stocked In: Anthracite, Chocolate - Special Order Colours: White
- Replaceable feet, CATAS Tested
- Matching Products: Tequila Lounge Armchair, All Resin Rattan Range Products
- Made in Europe
- 3 Month warranty on cushions



## Tequila Lounge Side Table - 450x450



- Suitable for indoor and outdoor commercial use
- Made of UV stabilised polypropylene
- Dimensions: 450W x 450D x 450H
- Unit Weight: 2.5kg
- Supplied unassembled - easy to assemble
- Weather resistant, UV Stabilised
- Stocked In: Anthracite, Chocolate
- Special Order Colours: White
- Replaceable feet
- Matching Products: Tequila Lounge Coffee Table, All Resin Rattan Range Products
- Made in Europe



## Tequila Lounge Coffee Table - 920x530



- Suitable for indoor and outdoor commercial use
- Made of UV stabilised polypropylene
- Dimensions: 920W x 530D x 450H
- Unit Weight: 4.6kg
- Supplied unassembled - easy to assemble
- Weather resistant, UV Stabilised
- Stocked In: Anthracite, Chocolate
- Special Order Colours: White
- Replaceable feet
- Matching Products: Tequila Lounge Side Table, All Resin Rattan Range Products
- Made in Europe





# SUNLOUNGERS

## Fiji Sunlounger



5 YEAR WARRANTY



- Stackable
- Suitable for indoor and outdoor commercial use
- Made of UV stabilised polypropylene reinforced with glass fibre
- Seat: Beige cushion available at an extra cost - 50mm thick cushion covered with polyester fabric & finished with piping, washable & suitable for outdoor use
- Dimensions: 730W x 187D x 440H
- Unit Weight: 14kg, SWL: 150kg, Supplied assembled
- Weather resistant, UV Stabilised, Glass fibre reinforced
- Stocked In: Anthracite, Chocolate, White
- Replaceable feet
- CATAS Tested
- Matching Products: All Resin Rattan Range Products
- Made in Europe
- 3 Month warranty on cushions



## Pacific Sunlounger



- Stackable
- Weather resistant, UV Stabilised, Glass fibre reinforced
- Suitable for indoor and outdoor commercial use
- Frame: Made of UV stabilised polypropylene reinforced with glass fibre
- Seat: Made of breathable synthetic fabric
- Dimensions: 680W x 1930D x 350H
- Unit Weight: 16.5kg, SWL: 150 kg
- Supplied assembled
- Stocked In: White / White, White / Taupe, White / Turquoise, White / Blue, Dark Grey / Black, Black / Black
- Replaceable feet and fabric
- Made in Europe
- Matches with Ocean Side Table on page 33

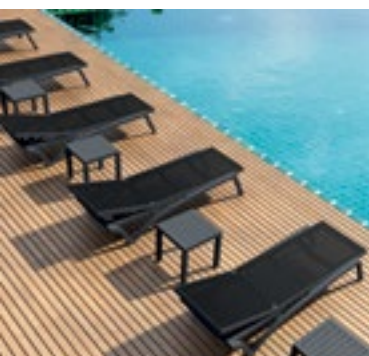





INDOOR/OUTDOOR TABLE TOPS





# Gentas Table Tops **GENTAŞ**

These table tops are manufactured in Turkey by Gentas, using the renowned resin moulding process. Available in a select range of sizes and finishes, these tops are durable, weatherproof, inexpensive and attractive.

The foundation of each Gentas table top is a mix of quality hardwoods and softwoods, kiln-dried and blended with synthetic resins as well as anti-rot and anti-moisture agents. This mixture is compressed at 140°C under high pressure before the hardwearing and decorative layers are applied and inseparably moulded together.

This method produces high quality table tops which are seamless, hygienic, functional and suitable for indoor or outdoor use.

It is advisable to select light finishes (White, Stratos, Marble and Travertine) for use in direct sunlight conditions. Dark colours used in direct sunlight can heat up and become hot. The core material can expand and result in warping at the edges. The manufacturer does not accept this as a warranty claim.

## FEATURES

- Suitable for indoor and outdoor commercial use
- 2 year indoor structural warranty
- 1 year outdoor structural warranty
- Surface: High impact joint less laminate surface resistant to wear, heat & burns from cigarettes. Hygienic & easy to clean
- Foundation: Mix of quality hardwoods and softwoods, kiln-dried and blended with synthetic resins as well as anti-rot and anti-moisture agents
- Available Sizes: 340R, 600R, 700R, 800R, 600x600SQ, 700x700SQ, 800x800SQ, 1400x800RCT
- Indent size: 1200x800RCT
- Edge Profile and Thickness: (refer to website)
- Unit Weights: (refer to website)
- Supplied unassembled - Flat pack form
- Stocked In: Anthracite, Black, Chocolate, Light Beech, Marble, Nova Pine, Rustic Block Wood, Rustic Dark Oak, Shesman, Stratos, Travertine, Walnut, Wenge, White

## Sizes and Shapes available

Top Size mm	340 Dia	600 Dia	700 Dia	800 Dia
Weight (Kg)	2	4	5	7
Edge Profile (mm)	25	25	25	25
Core (mm)	18	18	18	18

Top Size (mm)	600x600	700x700	800x800	1400x800
Weight (Kg)	7	10	12	21
Edge Profile (mm)	35	35	35	29
Core (mm)	20.5	20.5	20.5	21

Anthracite

Black

Chocolate

Light Beech

Marble

Nova Pine

Rustic Block Wood

Rustic Dark Oak

Shesman

Stratos

Travertine

Walnut

Wenge

White





# Compact Laminate Duratop 2 YEAR WARRANTY

Born out of innovation, excellent materials and cutting-edge technology, the Compact Laminate Duratop offers great value for commercial venues. Its durable construction and sleek 12mm profile makes it a perfect table top for both indoor and outdoor applications.

Offered in Black, Rustic Block Wood, Shesman, Wenge and White, the Compact Laminate Duratop is constructed with layers of Kraft paper, dipped in resin and dried. These layers are then sandwiched between laminated top and bottom sheets, compressed and baked. A process called polymerisation melds them all together creating a solid-core panel that is an extra tough durable laminate.

Each colour is available in a range of different sizes in square, rectangle and round. The underside of each top has grooves that have been routed to be used as predrilling holes. This makes installation of Compact Laminate Duratops with most table bases simple and easy.



It is advisable to select white for use in direct sunlight conditions. Dark colours used in direct sunlight can heat up and become hot. Dark coloured tops are vulnerable to warping in high heat. The manufacturer does not accept this as a warranty claim.

Stocked in:



- Black
- Rustic Block Wood
- Shesman
- Wenge
- White

Available Sizes: 600R, 690R, 800R, 600SQ, 690SQ, 800SQ, 600x800RCT & 1390x800RCT



## Sizes and Shapes available

			
Top Size mm	600 Dia	690 Dia	800 Dia
Weight (Kg)	4.7	6.5	9
Edge Profile / Core (mm)	12	12	12

			
Top Size (mm)	600x600	690x690	800x800
Weight (Kg)	6.5	8.5	11
Edge Profile / Core (mm)	12	12	12

		
Top Size (mm)	600x800	1390x800
Weight (Kg)	8	19
Edge Profile / Core (mm)	12	12



Black



Rustic Block Wood



Shesman



Wenge



White



Routed grooves to be used as predrilling holes



## Air Table Top 2 YEAR WARRANTY

- Suitable for indoor/outdoor use
- Made from Compact Laminate
- Available Sizes: 1800x900RCT, 1400x800RCT, 800x800SQ
- Edge Profile and Thickness: 12MM
- Unit Weights: 800x800 - 12 kg, 1400x800 - 21kg, 1800x900 - 30kg
- Stocked In: Black and White
- Matching Products: Only suits Air Legs
- Made in Europe



## Tuscany Timber Table Top 2 YEAR WARRANTY **DURAFURN**

- Suitable for indoor commercial use only
- Available in Chocolate and Natural finish
- Made from Solid European Beech
- Available Sizes: 700mmx700mm (13kg), 800mmx800mm (16kg)
- Edge Profile and Thickness: 32MM
- Unit Weights: 10 - 13kg
- Supplied unassembled - Flat pack form
- Metal support struts underneath for added strength
- Made in South East Asia



## Genoa Table Tops 2 YEAR WARRANTY **DURAFURN**

- Made in South East Asia
- Made from 38mm thick solid European Beech
- Available sizes 600mmx600mm (10kg), 700mmx700mm (14kg), 800mmx800mm (20kg)
- Quality stained finish in Antique Walnut
- Suitable for indoor use only
- 2 year structural warranty
- Metal support struts on underneath for added strength







# INDOOR/OUTDOOR TABLE BASES





## Air Legs

5 YEAR WARRANTY



- Suitable for indoor and outdoor commercial use.
- Available In: Black and White
- Made of polypropylene
- Matching Products: Air Tables, Air chair
- Dimensions:
 

Small	725H x 530W x 580D
Medium	725H x 1120W x 580D
Large	725H x 1530W x 580D
- Replaceable feet
- Supplied unassembled
- Unit Weight: 8.3 kg
- Made in Europe



## Alexi Table and Bar Base

2 YEAR WARRANTY

DURAFURN

- Suitable for indoor and outdoor commercial use
- Top Plate: Pressed steel top plate with 8 x fastening points
- Pole: 75DIA 304 grade stainless steel pole
- Base: 304 grade stainless steel wrapped over a cast iron disc base
- Brushed stainless steel finish
- 5 x adjustable Feet
- Supplied unassembled - easy to assemble
- Replaceable feet
- Standard Height: 450Dia base at 720H  
Unit Weight: 22kg  
Maximum Suitable Table Top Size: 800x800mm square - 15kg
- Bar Height: 450Dia base at 1070H  
Unit Weight: 24kg  
Maximum Suitable Table Top Size: 800mm round - 15kg
- Standard Height: 600Dia base at 720H  
Unit Weight: 30kg  
Maximum Suitable Table Top Size: 1100mm round - 18kg
- Made in China



## Astoria Aluminium Table and Bar Base

2 YEAR WARRANTY

DURAFURN

- Suitable for indoor and outdoor commercial use
- Top Plate: Cast aluminium top plate with 8 fastening points
- Pole: 60DIA aluminium pole
- Base: Cast aluminium 4 star base
- Stock In: Anodized aluminium finish, Black powder coat finish
- 4 x adjustable Feet
- Supplied unassembled - easy to assemble
- Notes: Anodized aluminium base does not have lead weights, Replaceable feet
- Base Span: 650mm Diagonal
- Standard height: 720H  
Unit Weight: Anodized Base 3kg - Black Base 6kg  
Maximum Suitable Table Top Size: 800x800mm square - 15kg
- Bar height: 1090H  
Unit Weight: Anodized Base 4kg - Black Base 7kg  
Maximum Suitable Table Top Size: 700mm square - 12kg
- Made in China



## Astoria Aluminium Twin Bar Table and Table Base

2 YEAR WARRANTY

- Suitable for indoor and outdoor commercial use
- Top Plates: Cast aluminium top plates with 8 fastening points
- Poles: 60DIA aluminium poles
- Bases: Cast aluminium bases
- Stock In: Anodized aluminium finish, Black powder coat finish
- 4 x adjustable Feet
- Supplied unassembled - easy to assemble
- Notes: Anodized aluminium base does not have lead weights, Replaceable feet
- Base Span: 600mm Pole Centre to Pole Centre: 600mm
- Standard height: 720H  
Unit Weight: Anodized Base 5kg - Black Base 9kg  
Maximum Suitable Table Top Size: 1400x800mm rectangle - 22kg
- Bar height: 1090H  
Unit Weight: Anodized Base 6kg - Black Base 10kg  
Maximum Suitable Table Top Size: 1200x800mm rectangle - 20kg
- Made in China



## Avila Table and Bar Base 2 YEAR WARRANTY DURAFURN.

- Suitable for indoor and outdoor commercial use
- Top Plate: Cast aluminium top plate with 8 fastening points
- Pole: 60DIA aluminium pole
- Base: Cast aluminium 4 star base
- Stock In: Anodized aluminium finish
- 4 x adjustable Feet
- Supplied unassembled - easy to assemble
- Replaceable feet
- Base Span: 650mm Diagonal
- Standard height: 720H  
Unit Weight: 8kg  
Maximum Suitable Table Top Size: 800x800mm square - 15kg
- Bar height: 1090H  
Unit Weight: 10kg  
Maximum Suitable Table Top Size: 700 x 700mm square - 12kg
- Made in China



## Avila Twin Table and Bar Base 2 YEAR WARRANTY DURAFURN.

- Suitable for indoor and outdoor commercial use
- Top Plates: Cast aluminium top plates with 8 fastening points
- Poles: 60DIA aluminium poles
- Bases: Cast aluminium bases
- Stock In: Anodized aluminium finish
- 4 x adjustable Feet
- Supplied unassembled - easy to assemble
- Replaceable feet
- Base Span: 600mm Pole Centre to Pole Centre: 600mm
- Standard height: 720H  
Unit Weight: 11kg  
Maximum Suitable Table Top Size: 1400x800mm rectangle - 22kg
- Bar height: 1090H  
Unit Weight: 15kg  
Maximum Suitable Table Top Size: 1200x800mm rectangle - 20kg
- Made in China



## Bistro Table and Bar Base 2 YEAR WARRANTY DURAFURN.

- Suitable for indoor commercial use only
- Top Plates: Cast iron top plates with 8 fastening points
- Poles: 60DIA Iron poles
- Bases: Cast Iron bases
- Stock In: Black finish
- 4 x adjustable Feet
- Supplied unassembled - easy to assemble
- Replaceable feet
- Standard height: 720H  
Unit Weight: 11kg  
Maximum Suitable Table Top Size: 800x800mm square - 15kg
- Bar height: 1090H  
Unit Weight: 15kg  
Maximum Suitable Table Top Size: 700x700mm square - 12kg
- Made in China



## Blitz Folding Table and Bar Base 2 YEAR WARRANTY DURAFURN.

- Suitable for indoor and outdoor commercial use
- Top Plate: Powder coated steel folding top plate with 8 fastening points
- Pole: 60DIA aluminium pole
- Base: Cast aluminium 4 star stacking base
- Stock In: Anodized aluminium finish
- 2 x adjustable Feet
- Supplied unassembled - easy to assemble
- Replaceable feet
- Base Span: 650mm Diagonal
- Standard height: 720H  
Unit Weight: 6kg  
Maximum Suitable Table Top Size: 800x800mm square - 15kg
- Bar height: 1090H  
Unit Weight: 8kg  
Maximum Suitable Table Top Size: 700x700mm square - 12kg
- Made in China



## Coral Round Table and Bar Base

10 YEAR  
STRUCTURAL  
WARRANTY

DURAFURN.



- Suitable for indoor and sheltered outdoor commercial use only
- Made from zinc coated steel
- Top Plate: Heavy duty steel top plate with 8 fastening points
- Pole: Heavy duty steel pole - Base: Heavy duty steel disc base
- Stock In: Anthracite, Black, White, Chocolate, Orange, Red, Green, Blue, Silver
- 5 x adjustable Feet
- Supplied unassembled - easy to assemble
- Replaceable feet
- Base Span: 600DIA
- Standard height: 720H, Unit Weight: 22kg  
Maximum Suitable Table Top Size: 800x800mm square - 15kg
- Bar height: 1090H, Unit Weight: 24kg  
Maximum Suitable Table Top Size: 700x700mm square - 12kg
- Twin bolt locking the top and base to prevent pole rotation
- Can be supplied in raw

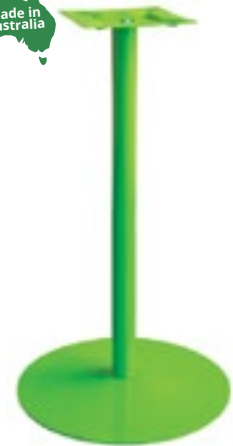

## Coral Star Table and Bar Base

10 YEAR  
STRUCTURAL  
WARRANTY

DURAFURN.



- Suitable for indoor and sheltered outdoor commercial use only
- Made from zinc coated steel
- Top Plate: Heavy duty steel top plate with 8 fastening points
- Pole: Heavy duty steel pole - Base: Heavy duty steel 4 star base
- Stock In: Anthracite, Black, White, Chocolate, Orange, Red, Green, Blue, Silver
- 5 x adjustable Feet
- Supplied unassembled - easy to assemble
- Replaceable feet
- Base Span: 650mm Diagonal
- Standard height: 720H, Unit Weight: 12kg  
Maximum Suitable Table Top Size: 800x800mm square - 15kg
- Bar height: 1090H, Unit Weight: 14kg  
Maximum Suitable Table Top Size: 700x700mm square - 12kg
- Twin bolt locking the top and base to prevent pole rotation
- Can be supplied in raw



## Disco Table Base

2 YEAR  
WARRANTY

DURAFURN.

- Description: Stylish cast iron table base. Aluminium pole. Cast iron top plate. Table base suitable for Gentas table tops up to 800mm square/800mm round. Black powder coat with stipple finish Made in China
- Recommend table top max weight and size: 12kg, 800mmx800mm
- Specifications: Total height 720mm, Pole Dia. 75mm, Top plate is cast iron 450mm wide including 8 x fastening points. Base span 590mm diameter.
- Adjustable levelling feet x 5.
- Suitable for indoor commercial use only
- Supplied unassembled
- Unit Weight: 20kg



## Genoa Table and Bar Base

2 YEAR  
WARRANTY

DURAFURN.

- Made in South East Asia
- Made from solid European Beech
- Standard height: 705mm, Unit Weight: 17kg
- Bar height: 1020mm, Unit Weight: 18kg
- Supplied unassembled
- Quality stained finish in Antique Walnut
- Metal Base
- Suitable for indoor use only
- Metal Base: 460 x 460mm
- 4 x Adjustable feet





## Marlo Table Base - Single and Twin

2 YEAR  
WARRANTY

DURAFURN.

- Description: Stylish cast iron table base. Aluminium pole. Cast iron top plate. Table base suitable for Gentas table tops up to 800mm square/800mm round. Black powder coat with stipple finish Made in China
- Recommend table top max weight and size: 12kg, 800mmx800mm
- Specifications: Total height 720mm, Pole Dia. 75mm, Top plate is cast iron 450mm wide including 8 x fastening points. Base span 590mm x 590mm.
- Adjustable levelling feet.
- Suitable for indoor use only
- Supplied unassembled
- Unit Weight: 8kg



## Metz Table Base - Single and Twin

2 YEAR  
WARRANTY

DURAFURN.

- Suitable for indoor/outdoor commercial use
- Cast Aluminium table base with a black powder coat finish
- Single - Recommend table top max weight: 12kg - 800mmx800mm
- Twin - Recommended table top max weight and size: 18kg - 1200mmx800mm & 21kg - 1400mmx800mm
- Adjustable levelling feet
- Supplied unassembled - comes in 4 easy to assemble segments.
- Unit Weight: 4kg
- Made in China



## Riva Table and Bar Base



2 YEAR  
WARRANTY



- Suitable for indoor and outdoor commercial use
- Made with an aluminium frame (painted) covered with UV stabilised polypropylene
- Table - Maximum Suitable Table Top Size: 800x800 - 15kg  
Dimensions: 450W x 450D x 710H  
Unit Weight: 8kg
- Bar Table - Maximum Suitable Table Top Size: 700x700 - 12kg  
Dimensions: 450W x 450D x 1040H  
Unit Weight: 11kg
- Supplied unassembled - easy to assemble
- Weather resistant, UV Stabilised
- Stocked In: Anthracite, Chocolate
- Special Order Colours: White
- Replaceable feet
- Matching Products: All Resin Rattan Range Products
- Made in Europe



## Rega Table Base

2 YEAR  
WARRANTY

DURAFURN.

- Suitable for indoor and outdoor commercial use
- Top Plates: 403 grade stainless steel top plate with 8 fastening points
- Pole: 60DIA 304 grade stainless steel pole
- Base: 304 grade stainless steel fixed base with shroud
- Stock In: Brushed stainless steel finish
- Bolt down base
- Supplied unassembled
- Standard height: 720H
- Unit Weight: 5kg
- Maximum Suitable Table Top Size: 800x800mm square - 15kg
- Made in China



## Roma Table and Bar Base 2 YEAR WARRANTY DURAFURN.

- Suitable for indoor and outdoor commercial use
- Top Plate: Cast aluminium top plate with 8 fastening points
- Pole: 60DIA aluminium pole
- Base: Cast aluminium 4 star base wrapped with 304 grade stainless steel cover
- Stock In: Anodized aluminium finish and shiny stainless steel finish
- 4 x adjustable Feet
- Supplied unassembled - easy to assemble
- Replaceable feet
- Base Span: 630mm Diagonal
- Standard height: 720H  
Unit Weight: 8kg  
Maximum Suitable Table Top Size: 800x800mm square - 15kg
- Bar height: 1090H  
Unit Weight: 10kg  
Maximum Suitable Table Top Size: 700x700mm square - 12kg
- Made in China



## Roma Twin Table and Bar Base 2 YEAR WARRANTY DURAFURN.

- Suitable for indoor and outdoor commercial use
- Top Plates: Cast aluminium top plates with 8 fastening points
- Poles: 60DIA aluminium poles
- Bases: Cast aluminium bases wrapped with 304 grade stainless steel covers
- Stock In: Anodized aluminium finish and shiny stainless steel finish
- 4 x adjustable Feet
- Supplied unassembled - easy to assemble
- Replaceable feet
- Base Span: 570mm Pole Centre to Pole Centre: 600mm
- Standard height: 720H  
Unit Weight: 12kg  
Maximum Suitable Table Top Size: 1400x800mm rectangle - 22kg
- Bar height: 1090H  
Unit Weight: 16kg  
Maximum Suitable Table Top Size: 1200x800mm rectangle - 20kg
- Made in China



## Stirling Mk2 Table Base - Single and Twin 2 YEAR WARRANTY DURAFURN.

- Suitable for indoor and outdoor commercial use
- Top Plate: 304 grade stainless steel top plate with 8 fastening points
- Pole: 60DIA 304 grade stainless steel pole
- Base: 304 grade stainless steel base
- Stock In: Brushed stainless steel finish
- 4 x adjustable feet - 1 top adjuster on each base
- Supplied unassembled - easy to assemble
- Replaceable feet
- Single Standard Height: 720H  
Unit Weight: 6kg  
Maximum Suitable Table Top Size: 800x800mm square - 15kg
- Twin Standard Height: 720H  
Unit Weight: 8kg  
Maximum Suitable Table Top Size: 1400x800mm rectangle - 22kg
- Base Span: 600mm Pole Centre to Pole Centre: 620mm
- Made in China



## Titan Folding Table and Bar Base 2 YEAR WARRANTY DURAFURN.

- Suitable for indoor and outdoor commercial use
- Top Plate: Plastic folding top plate with 8 fastening points
- Pole: 60DIA aluminium pole
- Base: Cast aluminium 4 star stacking base
- Stock In: Anodized aluminium finish
- 2 x adjustable Feet
- Supplied unassembled - easy to assemble
- Replaceable feet
- Base Span: 650mm Diagonal
- Standard height: 720H  
Unit Weight: 8kg  
Maximum Suitable Table Top Size: 800x800mm square - 15kg
- Bar height: 1090H  
Unit Weight: 10kg  
Maximum Suitable Table Top Size: 700x700mm square - 12kg
- Made in China





# INDOOR/OUTDOOR TABLES





## Air Table



2 YEAR WARRANTY



- Suitable for indoor and outdoor commercial use.
- Available Sizes: 800x800SQ, 1400x800RCT, 1800x900RCT
- Unit Weights: 800x800 - 18kg, 1400x800 - 31kg, 1800x900 - 41kg
- Table height: 725mm
- Available In: Black and White
- Made of polypropylene
- Matching Products: Air chair
- Replaceable feet
- Supplied unassembled
- Made in Europe



## Bali Table - 940x940



5 YEAR WARRANTY



- Suitable for indoor and outdoor commercial use
- Top: 5MM dark tempered glass top
- Frame: Aluminium frame covered with UV stabilised polypropylene
- Dimensions: 940W x 940D x 750H
- Unit Weight: 22kg
- Supplied unassembled - easy to assemble
- Weather resistant, UV Stabilised
- Stocked In: Anthracite, Chocolate - Special Order Colours: White
- 4 x adjustable Feet
- Replaceable feet
- CATAS Tested
- Matching Products: Tahiti Table, All Resin Rattan Range Products
- Made in Europe



## Ibiza Table



2 YEAR WARRANTY



- Suitable for indoor and outdoor commercial use.
- Available Sizes: 800x800SQ, 1400x800RCT, 1800x900RCT
- Unit Weights: 800x800 - 18kg, 1400x800 - 31kg, 1800x900 - 41kg
- Table height: 725mm
- Supplied unassembled - easy to assemble
- Weather resistant, UV Stabilised
- Stocked In: Anthracite, Chocolate - Special Order Colours: White
- Made in Europe
- Matching Products: All other products in the Resin Rattan Range



## Monaco Lounge Table



5 YEAR WARRANTY



- Made of durable weather-resistant resin reinforced with glass fibre- will never unravel or rust!
- UV Protected
- Suitable for indoor and outdoor commercial use
- Dimensions: 930L x 550D x 470H
- Stocked in: Anthracite, Chocolate
- Special order colour: White
- Supplied unassembled
- The Monaco Lounge Table is designed for self assembly.  
See assembly video at [www.youtube.com/watch?v=sUikbLgctew](http://www.youtube.com/watch?v=sUikbLgctew)
- Made in Europe



## Ocean Side Table



5 YEAR WARRANTY



- Suitable for indoor and outdoor commercial use
- Dimensions: 450W x 450D x 460H
- Unit Weight: 3kg
- Supplied unassembled - easy to assemble
- Weather resistant, UV Stabilised
- Stocked In: Anthracite, Black, Silver Grey, Taupe and White
- Made in Europe



## Orlando Table



5 YEAR WARRANTY



- Suitable for indoor and outdoor commercial use
- Made with an aluminium frame covered with UV stabilised polypropylene
- Available Sizes: 800W x 800D x 750H , 1400W x 800D x 750H
- Unit Weights: 800x800 - 14kg, 1400x800 - 23kg
- Supplied unassembled - easy to assemble
- Weather resistant, UV Stabilised
- Stocked In: Anthracite, Chocolate - Special Order Colours: White
- 4 x adjustable Feet
- Replaceable feet
- Matching Products: All Resin Rattan Range Products
- Made in Europe



## Tequila Lounge Side Table - 450x450



5 YEAR WARRANTY



- Suitable for indoor and outdoor commercial use
- Made of UV stabilised polypropylene
- Dimensions: 450W x 450D x 450H
- Unit Weight: 2.5kg
- Supplied unassembled - easy to assemble
- Weather resistant, UV Stabilised
- Stocked In: Anthracite, Chocolate
- Special Order Colours: White
- Replaceable feet
- Matching Products: Tequila Lounge Coffee Table, All Resin Rattan Range Products
- Made in Europe



## Tequila Lounge Coffee Table - 920x530



5 YEAR WARRANTY



- Suitable for indoor and outdoor commercial use
- Made of UV stabilised polypropylene
- Dimensions: 920W x 530D x 450H
- Unit Weight: 4.6kg
- Supplied unassembled - easy to assemble
- Weather resistant, UV Stabilised
- Stocked In: Anthracite, Chocolate
- Special Order Colours: White
- Replaceable feet
- Matching Products: Tequila Lounge Side Table, All Resin Rattan Range Products
- Made in Europe



## Tahiti Table - 1800x940



5 YEAR WARRANTY



- Suitable for indoor and outdoor commercial use
- Top: 5MM dark tempered glass top
- Frame: Aluminium frame covered with UV stabilised polypropylene
- Dimensions: 1800W x 940D x 750H
- Unit Weight: 32kg
- Supplied unassembled - easy to assemble
- Weather resistant, UV Stabilised
- Stocked In: Anthracite, Chocolate - Special Order Colours: White
- 4 x adjustable Feet
- Replaceable feet
- CATAS Tested
- Matching Products: Bali Table, All Resin Rattan Range Products
- Made in Europe



# FUNCTION TABLES AND CHAIRS

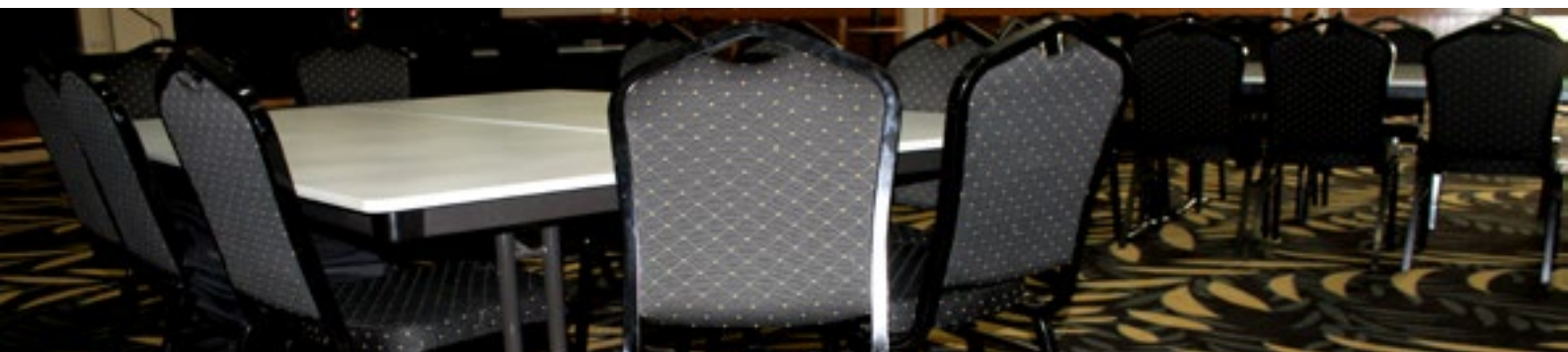



## Function Chair - Fabric

2 YEAR WARRANTY

DURAFURN.

- Stackable
- Suitable for indoor commercial use only
- Seat & Back: Cushion made with high resiliency foam. Quality fire retardant fabric
- Heavy duty 25mm square steel tube frame
- Dimensions: 440W x 530D x 930H x 460 Seat Height
- Unit Weight: 7kg
- SWL: 150kg
- Supplied assembled
- Chair trolley available
- Stocked In: Dark Blue Fabric with Gold Fleck or Black Fabric with Gold Fleck
- Replaceable feet
- Made in China



Black Fabric-Black Frame    Blue Fabric-Black Frame



## Function Chair - Vinyl

2 YEAR WARRANTY

DURAFURN.

- Stackable
- Suitable for indoor commercial use only
- Seat & Back: Cushion made with high resiliency foam. Quality fire retardant vinyl
- Heavy duty 25mm square steel tube frame
- Dimensions: 440W x 530D x 930H x 460 Seat Height
- Unit Weight: 7kg
- SWL: 150kg
- Supplied assembled
- Chair trolley available
- Stocked In: Black Vinyl with Silver or Black Frame
- Replaceable feet
- Made in China



Black Vinyl-Black Frame



## Chair Trolley

2 YEAR WARRANTY



- Suitable for Duraseat Function Chairs
- Made with a strong durable fully welded steel frame and foam filled tyres
- Unit Weight: 15kg
- Supplied assembled
- Stocked In: Black hammer tone
- Replaceable tyres



## Manhattan Banquet Table **DURAFURN.**



- Suitable for indoor commercial use only
- Top: High density durable polyethylene blow moulded top
- Frame: Heavy duty steel frame
- Dimensions: 1520DIA and 1800DIA x 740H
- Unit Weight: 1520DIA: 25kg 1800DIA: 32kg
- Supplied assembled
- Easy folding leg system
- Stocked In: White with powder coated grey frame
- Replaceable feet
- Storage trolley available - holds 12 tables
- Made in China



## Manhattan Banquet Table Trolley

- Suitable for indoor commercial use only
- Frame: Heavy duty steel frame
- Unit Weight: 35kg
- Supplied unassembled - easy to assemble
- Replaceable castors
- Holds 12 Manhattan Banquet Tables
- Made in China
- Assembly at extra cost



## Manhattan Trestle Table **DURAFURN.**



- Suitable for indoor commercial use only
- Top: High density durable polyethylene blow moulded top
- Frame: Heavy duty steel frame
- Dimensions: 1830x760 and 2420x760 x 740H
- Unit Weight: 1830x760: 18kg 2420x760: 24kg
- Supplied assembled
- Easy folding leg system
- Stocked In: White with powder coated grey frame
- Replaceable feet
- Storage trolley available - holds 20 tables
- Made in China



## Manhattan Trestle Table Trolley

- Suitable for indoor commercial use only
- Frame: Heavy duty steel frame
- Unit Weight: 30kg
- Supplied unassembled - easy to assemble
- Replaceable castors
- Holds 20 Manhattan Trestle Tables
- Made in China
- Assembly at extra cost









**DURAFURN.**