



GOOD LOOKING. WELL WORKING.

FULL LINE BROCHURE





- 04 Kitchen Spaces
- 28 Other Rooms
- 34 Mouldings & Embellishments
- 36 Smart Solutions™
- 39 Lighting
- 40 Door Styles
- 47 Finishing Touches
- 48 Finishes
- 50 Construction

### GOOD LOOKING. WELL WORKING.

Our cabinetry is not just good looking. It's priced right and well working too. We invite you to explore Schrock® Entra™, a semi-custom entry line of cabinetry built for quick delivery and outstanding value, for the latest in creative cabinetry solutions – all backed with the same great craftsmanship and warranty the Schrock brand has always offered. Whether you're looking for contemporary allure or traditional elegance, you'll find a style perfectly suited to your taste.



BEAUTY. FUNCTION. STRENGTH. PERFORMANCE.



Kitchen Cabinet Manufacturers Association  
Environmental Stewardship Program  
All products impact the environment.  
For ESP program criteria, visit [greencabinetsource.org](http://greencabinetsource.org).

**Kittrell** PureStyle™ Limestone

**Rivali** Laminate Alabaster

1. 6" Wide Full Height Base Cabinet
2. Two Drawer 48" Wide Base Cabinet
3. Wall Vertical Lift Cabinet





**Lormand** Hickory Riverwood with Alabaster accents



1.



2.

1. Base cabinet with Pots and Pans Pull-Out  
2. Utility Cabinet with Roll Trays

# Ingalis Maple Brie



- 1. Power Pod
- 2. Shaker Starter and Large Shaker Crown Moulding



# Amira Cherry Tuscan



1. Full Height Base Wastebasket Cabinet\*
2. Two Drawer Base Cabinet with Roll Tray
3. Oven Cabinet with Deep Drawer



*\*Cabinet design has been enhanced for improved performance (shown on page 55). Request additional information from your dealer.*

# Cavett PureStyle™ Alabaster



1. Chrome Tray Divider Cabinet
2. Light Baffle Moulding & Art Corbel
3. Base Cabinet with Roll Trays



# Colefax Cherry Dark Ale



- 1. Furniture Drawers
- 2. Wall Message Center Cabinet







# Kempton Cherry Sandstone



- 1. Wall Top Hinge Cabinet
- 2. Chrome Tray Divider Cabinet
- 3. Full Depth Shelf

# Ludlow Maple Limestone with Brown Sugar Glaze & Cherry Dark Ale



- 1. Base Super Lazy Susan Cabinet
- 2. Mission Rosette



# Luray Maple Dark Ale



1. Appliance Garage Cabinet
2. Art Corbel
3. Arched Canopy Wood Hood



# Amira Maple Brie



1. Toekick Drawer with Push-To-Open Guides
2. Base Double Wastebasket Cabinet\*
3. Wall Microwave Cabinet



*\*Cabinet design has been enhanced for improved performance (shown on page 55). Request additional information from your dealer.*

# Berwick Oak Barley & Dark Ale with Barn Wood Glaze



- 1. 30" SuperCabinet™
- 2. Wall Lazy Susan Cabinet



# Henrickson Cherry Amber Suede



1. Furniture Drawers

2. Base Double Wastebasket Cabinet\*



*\*Cabinet design has been enhanced for improved performance (shown on page 55). Request additional information from your dealer.*

# Walton PureStyle Scone



1. Tall Crown Moulding
2. Cut for Glass Door



# Guthrey Oak Dark Ale



1. Metro Bar Column
2. Utility Cabinet with Roll Trays





# Raglan PureStyle Bluff

1. Wall Vanity Mirror with Cut for Glass Door and Installed Mirror
2. Linen Closet Cabinet with Removable Hamper
3. Tilt-Out Tray



1.



2.



3.



## Mouldings & Embellishments

- 1. Floating Shelves
- 2. Art Corbel
- 3. Wood Hood Square
- 4. Arched Canopy Wood Hood
- 5. Shaker Baseboard Moulding

- 6. Tulip Foot
- 7. Victorian Crown Moulding and Fluted Filler
- 8. Wine Storage Cabinet
- 9. Mission Rosette



# Smart Solutions™

- 1. Utility Organizer Cabinet
- 2. Base Super Lazy Susan Cabinet
- 3. Two Drawer Base with Roll Tray Cabinet
- 4. Two Drawer 48" Wide Base Cabinet
- 5. Sink Base Cleaning Caddy
- 6. Base Cabinet with Rollout Tray Divider

- 7. Base Double Wastebasket Cabinet and Toekick Drawer\*
- 8. Base Cabinet with Roll Trays
- 9. Wall Message Center
- 10. Cooking Utensil Divider

*\*Cabinet design has been enhanced for improved performance (shown on page 55). Request additional information from your dealer.*

# Lighting



1. LED Rigid Strip
2. LED Puck Light
3. LED Flexible Strip
4. Quattro Zoned Lighting Controller\*

\*Create and control up to four separate lighting zones in your space with Quattro Lighting.



1. Toekick Drawer
2. 36" SuperCabinet™
3. Sink Base SuperCabinet™ with CabMat™
4. Base Utensil Pantry Pull-Out Cabinet
5. Vanity Wall Mirror with Cut for Glass Door and Installed Mirror



The lighting controller can be wall mounted or hand-held.

# Door Styles

## MAPLE



**Amira**  
full overlay



**Amira**  
full overlay  
5-piece drawer front option



**Berwick**  
full overlay



**Broxton**  
full overlay

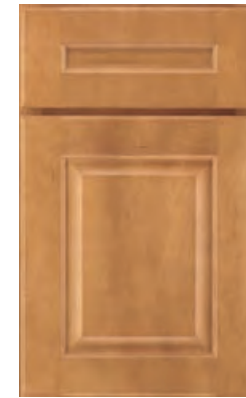

**Broxton**  
full overlay  
5-piece drawer front option



**Ludlow**  
full overlay



**Luray**  
partial overlay



**Luray**  
partial overlay  
5-piece drawer front option



**Raglan**  
full overlay



**Raglan**  
full overlay  
5-piece drawer front option

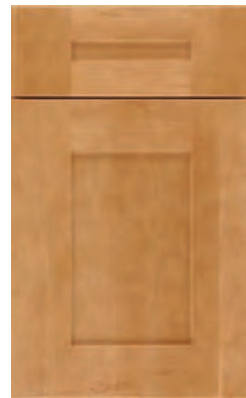

**Colefax**  
full overlay



**Colefax**  
full overlay  
slab drawer front option



**Glenridge**  
partial overlay



**Guthrey**  
partial overlay



**Henrickson**  
partial overlay



**Walton**  
partial overlay

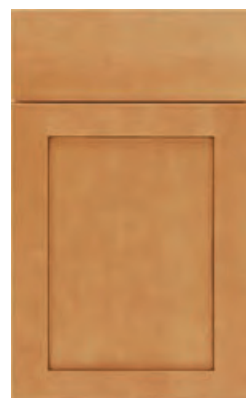

**Ingalis**  
full overlay



**Ingalis**  
full overlay  
5-piece drawer front option



**Kempton**  
full overlay



**Kittrel**  
full overlay



**Lormand**  
partial overlay

# Door Styles

## CHERRY



**Amira**  
full overlay



**Amira**  
full overlay  
5-piece drawer front option



**Berwick**  
full overlay



**Broxton**  
full overlay



**Broxton**  
full overlay  
5-piece drawer front option



**Ludlow**  
full overlay



**Luray**  
partial overlay



**Luray**  
partial overlay  
5-piece drawer front option



**Raglan**  
full overlay



**Raglan**  
full overlay  
5-piece drawer front option



**Colefax**  
full overlay



**Colefax**  
full overlay  
slab drawer front option



**Glenridge**  
partial overlay



**Guthrey**  
partial overlay



**Henrickson**  
partial overlay



**Walton**  
partial overlay



**Ingalis**  
full overlay



**Ingalis**  
full overlay  
5-piece drawer front option



**Kempton**  
full overlay



**Kittrel**  
full overlay



**Lormand**  
partial overlay

# Door Styles

## OAK



**Amira**  
full overlay



**Amira**  
full overlay  
5-piece drawer front option

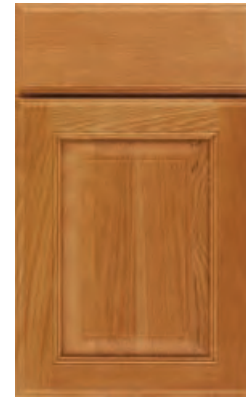

**Berwick**  
full overlay



**Broxton**  
full overlay



**Broxton**  
full overlay  
5-piece drawer front option



**Glenridge**  
partial overlay



**Guthrey**  
partial overlay



**Henrickson**  
partial overlay



**Lormand**  
partial overlay



**Luray**  
partial overlay



**Luray**  
partial overlay  
5-piece drawer front option

# Door Styles

## HICKORY



**Berwick**  
full overlay



**Colefax**  
full overlay



**Colefax**  
full overlay  
slab drawer front option



**Glenridge**  
partial overlay



**Guthrey**  
partial overlay



**Ingalis**  
full overlay



**Ingalis**  
full overlay  
5-piece drawer front option



**Lormand**  
partial overlay

## PURESTYLE AND LAMINATE\*

## TEXTURED GLASS INSERTS



**Cavett**  
full overlay

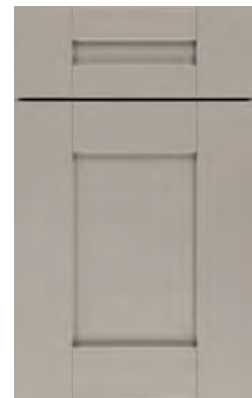

**Colefax**  
full overlay



**Colefax**  
full overlay  
slab drawer front option



**Ingalis**  
full overlay



**Ingalis**  
full overlay  
5-piece drawer front option



**Kittrel**  
full overlay



**Luray**  
partial overlay



**Raglan**  
full overlay



**Raglan**  
full overlay  
5-piece drawer front option

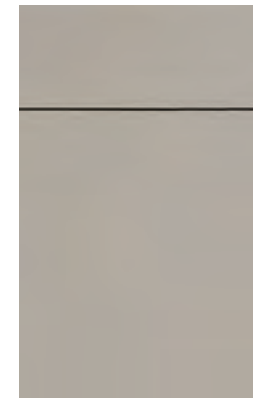

**Rivali\***  
full overlay



**Walton**  
partial overlay



**Antique**



**Bevel**

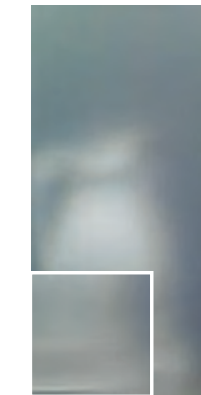

**Frost**



**Reeded**



**Seeded**

Clear glass also available

## HARDWARE





# Finishes

\* The door and/or drawer front center panel may be constructed of Medium Density Fiberboard (MDF).  
 ◊ Unfinished also available.

## MAPLE

### STANDARD FINISHES◊



### BARN WOOD GLAZE



### BROWN SUGAR GLAZE



### OPAQUES\*

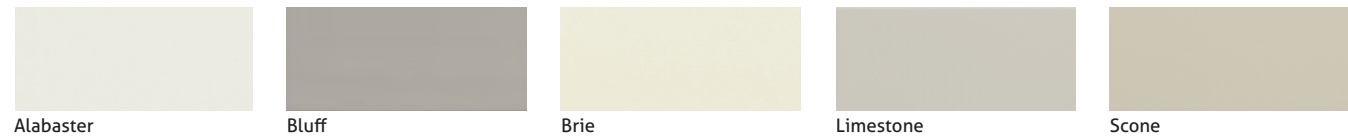

### BARN WOOD GLAZE\*



### BROWN SUGAR GLAZE\*



## HICKORY

### STANDARD FINISHES◊

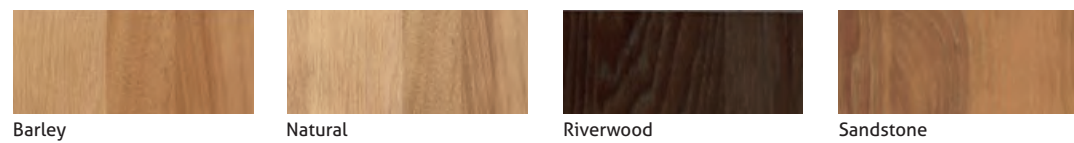

### BARN WOOD GLAZE

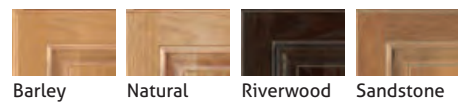

### BROWN SUGAR GLAZE

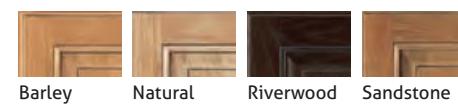

## OAK

### STANDARD FINISHES◊

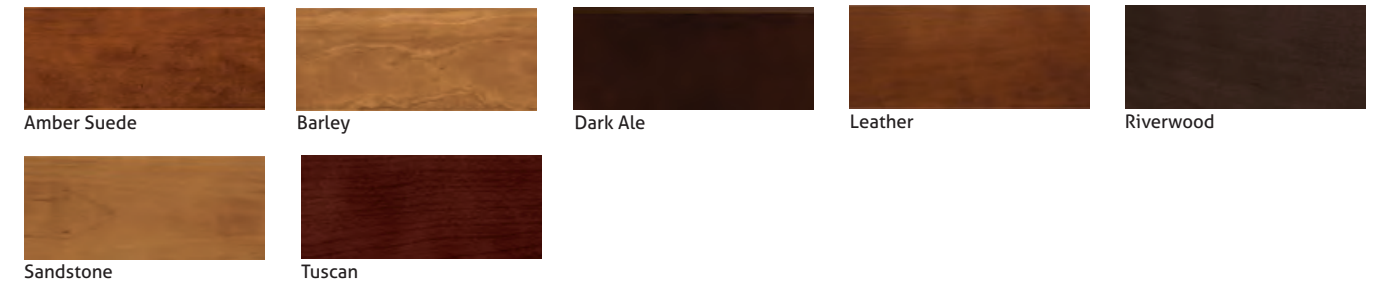

### BARN WOOD GLAZE



### BROWN SUGAR GLAZE



## OAK

### STANDARD FINISHES◊

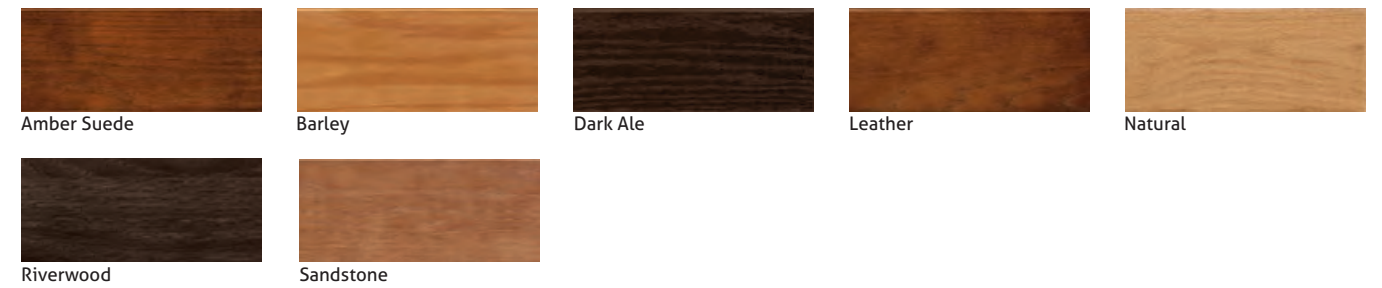

### BARN WOOD GLAZE



### BROWN SUGAR GLAZE



## PURESTYLE AND LAMINATE

### STANDARD FINISHES



## STANDARD CABINET

- 3/8" Furniture board end panels
- 1/2" Furniture board top and bottom
- 1/2" I-beam braces dadoed into face frame, end panels and back
- 3/8" Furniture board integrated back
- 3/4" Solid hardwood face frame
- Fully concealed, 6-way adjustable hinge
- Cabinet interior laminated natural maple or white

## STANDARD DRAWER

- 3/4 extension, side-mounted, epoxy-coated guides
- 1/2" laminated furniture board sides; 3/8" bottom



## ROLL TRAY OPTIONS



### STANDARD FURNITURE BOARD ROLL TRAYS

- 3/4 extension, side-mount guides
- 3/8" natural maple laminated furniture board bottom
- 1/2" natural maple laminated furniture board sides



### UPGRADE SOLID WOOD DOVETAIL ROLL TRAYS WITH SMART STOP™ (SP)

- Smart Stop™ full extension guides
- 4-sided, clear-coated, solid wood
- 3/4" nominal thick dovetail sides with 5.2mm laminated plywood\* bottom

## CABINET BOX OPTIONS



- UPGRADE 1**  
ALL PLYWOOD\* WITH LAMINATE ENDS (EPL)
- All standard features. Replaces standard cabinet construction with plywood
  - 3/8" Plywood end panels and back
  - 1/2" Plywood top, bottom, and I-beam braces
  - Exterior end panels laminated to match the selected finish



- UPGRADE 2**  
ALL PLYWOOD\* WITH FINISHED ENDS (EPF)
- All standard features. Replaces standard cabinet construction with plywood
  - 3/8" Plywood end panels and back
  - 1/2" Plywood top, bottom, and I-beam braces
  - Finished veneer exterior end panels to match the selected finish



- UPGRADE 3**  
FURNITURE FINISHED PLYWOOD\* END PANELS (FPFB)
- All standard features. Replaces standard 3/8" end panels with 3/4" plywood
  - Finished veneer exterior end panels to match the selected finish

## SMART STOP™ UPGRADES



- DRAWER UPGRADE**  
SOLID WOOD DOVETAIL DRAWER WITH FULL EXTENSION GUIDE WITH SMART STOP™ (PG)
- Full extension, undermount guides with Smart Stop™ and fast-clip removal system
  - 4-sided, clear-coated, solid wood drawer box
  - 3/4" nominal thick dovetail sides with 5.2mm laminated plywood\* bottom

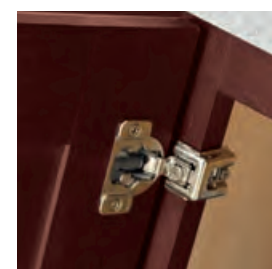

- DOOR HINGE UPGRADE**  
SMART STOP™ CABINET DOOR HINGE (INTGH)
- This innovative hinge provides a gentle, controlled self-closing feature that engages when the door nears the cabinet face frame.

## SHELF OPTIONS

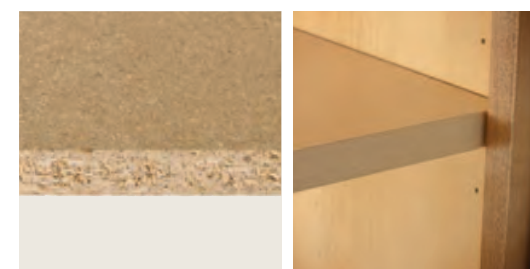

- STANDARD**  
FURNITURE BOARD SHELVES
- 3/4" adjustable furniture board shelving

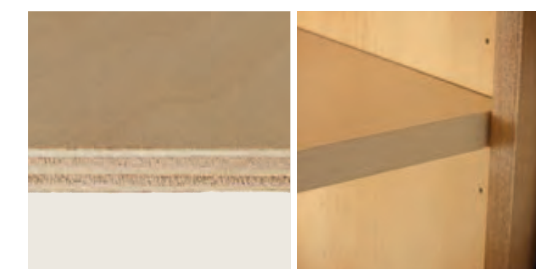

- UPGRADE**  
PLYWOOD\* SHELVES
- All standard features. Replaces standard shelves with laminated plywood shelves
  - Must upgrade to all plywood construction (EPL or EPF)

\* All plywood components meet ANSI/HPVA HP-1 standards, and may contain MDF or particleboard.



### CABINET NOMENCLATURE

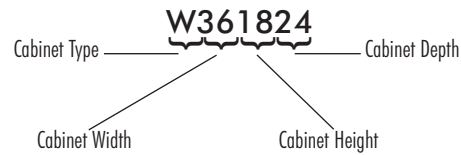

The cabinets listed below, and in the following pages, represent a sampling of our most popular cabinets. See your kitchen and bath designer for our full-line of cabinets and their specifications.

**Here are some things to keep in mind when choosing your cabinets:**  
For Single Door Cabinets, specify L or R hinging.

#### Standard Depths and Heights (unless otherwise noted):

Wall Cabinet Depth is 12".  
Base Cabinet Depth is 24", Height 34 1/2".  
Tall Cabinet Depth is 12" or 24".  
Vanity Cabinet Depth is 18" or 21", Height 32" or 34 1/2".

#### CUT FOR GLASS SPECIALTY DOORS\*

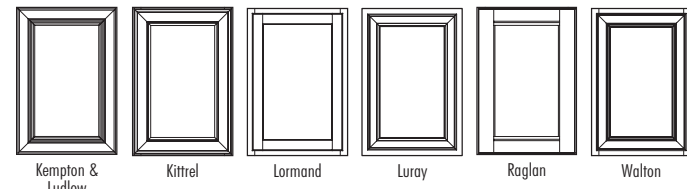
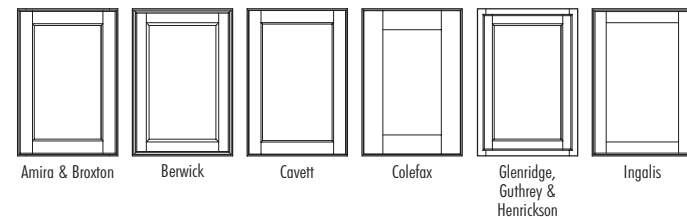

\*Glass not included, but available to order separately.

#### MULLION SPECIALTY DOORS\*

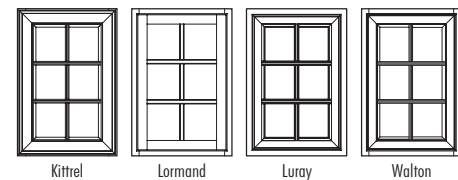
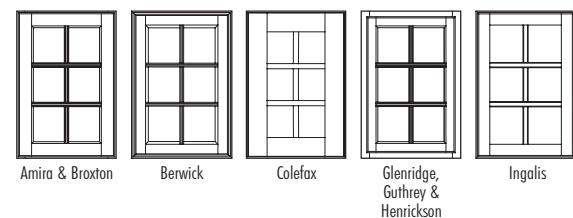

\*Glass not included, but available to order separately.

#### WALL SINGLE DOORS

<b>A Wall Single Door</b>	<b>B Wall Top Hinge Single Door</b>	<b>C Wall Vertical Lift</b>
W9** L or R W12** L or R	W15** L or R W18** L or R	W21** L or R W24** L or R
	WTH30** WTH36**	WVL30** WVL36**

#### WALL DOUBLE DOORS

<b>A Wall Double Door</b>	W21** W24** W27**	W30** W33** W36**	W39** W42** W45**

#### WALL REFRIGERATOR OPTIONS

<b>A Wall Refrigerator</b>	<b>B Wall Refrigerator w/Shelf</b>	<b>C Wall Top Hinge Refrigerator Single Door</b>	<b>D Wall Refrigerator Vertical Lift</b>
W****24	W**23.524 W**27.524	WTH30**24 WTH36**24	WVL30**24 WVL36**24

#### WALL THREE DRAWER

<b>A Wall Three Drawer Single Door</b>	<b>B Wall Three Drawer Double Door</b>
W3D15** L or R W3D18** L or R	W3D24** L or R W3D24**

TIP: Great for plastics container storage. Store bowls above and organize lids in drawers below.

#### WALL CORNER OPTIONS

<b>A Wall Corner</b>	<b>B Easy Reach Wall Corner</b>
WC**** L or R	ER** L or R

#### DIAGONAL WALL CABINETS

<b>A Diagonal Wall</b>	<b>B Diagonal Wall w/ Lazy Susan</b>
DW***** L or R	DW**2424LS L or R DW**2424S L or R

#### WALL END OPTIONS

<b>A Wall End Cabinet</b>	<b>B Wall Transition Cabinet</b>	<b>C Wall Message Center</b>	<b>D Wall Quarter Round End Shelves, Square Top &amp; Bottom Panels</b>
WE12** L or R WTC1230** WTC1233** WTC1236** WTC1239** WTC1242**	WTC1230** WTC1233** WTC1236** WTC1239** WTC1242**	WMC12** L or R	WQRES6**STS

#### WALL MICROWAVE CABINETS

<b>A Wall Microwave Cabinet</b>	<b>B Wall Microwave Double Door Cabinet</b>	<b>C Wall Built-In Microwave Cabinet</b>
MW**18	MW**36	WBMW24**** WBMW27****

#### WALL SPICE RACKS/ORGANIZERS

<b>A Wall Spice Rack Cabinet</b>	<b>B Wall Organizer</b>	<b>C Wall Spice Drawer</b>
WSR18** L or R WSR21** L or R	WO**	WSD**

#### WALL APPLIANCE GARAGE/CORNER DOOR

<b>A Wall Appliance Garage</b>	<b>B Wall Appliance Garage Vertical Lift Door</b>	<b>C Corner Door</b>
WAGD24 L or R WAGD24	WAGVLD24	CD**** L or R

#### WALL/BASE PULL-OUT STORAGE

<b>A Base Pantry Pull-Out</b>	<b>B Base Utensil Pantry Pull-Out</b>	<b>C Base Box Column Pull-Out w/Overlay</b>	<b>D Wall Box Column Pull-Out w/Overlay</b>	<b>E Wall Spice Pull-Out</b>
BPP**	BUPP**	BBCPO*OL	WBCPO*300L	WSP9** WSP12**

#### WALL CHINA & WINE CABINETS

<b>A Wall China Display</b>	<b>B Wall Wine Rack</b>	<b>C Wall Wine Cubby</b>	<b>D Wine Storage Cabinet</b>
WCD**15	WNR****	W6**	WSC1818**

#### RACKS & SHELVES

<b>A Wine Glass Holder</b>	<b>B Floating Shelves</b>
WGH**	FS**

#### WALL WOOD HOODS

<b>A Wood Hood Square</b>	<b>B Wood Hood Chimney</b>	<b>C Tapered Wood Hood</b>	<b>D Wood Hood Canopy Arched</b>	<b>E Wood Hood Canopy Square</b>
WHS**	WHC**	TWH**	WHCA**	WHCS**

#### BASE SHELF CABINETS

<b>A Base Cabinet</b>	<b>B Full Height Base Cabinet</b>
B** L or R B**	B6FH L or R B**FH L or R B**FH

#### BASE POTS, PANS, & BAKING DISHES CABINETS

<b>A Base w/Cutlery Insert Wood Organizer</b>	<b>B Base w/Wood Tiered Cutlery Divider Drawer</b>	<b>C Base w/Tray Divider</b>	<b>D Base Full Height Door w/Tray Divider</b>	<b>E Base w/Roll-Out Tray Divider</b>	<b>F Base w/Roll Trays</b>	<b>G Base w/Cutlery Insert Wood Organizer and Roll Trays</b>	<b>H Base w/Wood Tiered Cutlery Divider Drawer and Roll Trays</b>	<b>I Base Pots and Pans Pull-Out</b>	<b>J Pots &amp; Pans Organizer Base w/Drawer</b>	<b>K Floating Island Base</b>
B**CIW L or R B24CIW	B**WTCD L or R B24WTCD	TD** L or R	TD**FH L or R	B**TDRO L or R B**PS	B**RT L or R B**RT	B**RTCIW L or R B24RTCIW	B**RTWCD L or R B24RTWCD	BPPP24 L or R BPPP24	B24PS L or R B**PS	FI**

(Accommodates up to 2 extra roll trays.)

(Accommodates up to 2 extra roll trays.)

\*Order extra roll trays separately.

## BASE & SINK BASE SUPERCABINET™

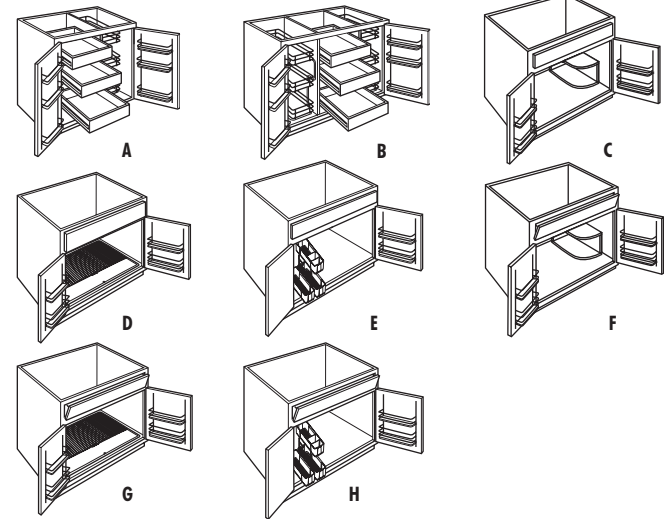

<b>A</b> 30" SuperCabinet™	BSC30RP
<b>B</b> 36" SuperCabinet™	BSC36PRP
<b>C</b> Sink Base SuperCabinet™	SB36S
<b>D</b> Sink Base SuperCabinet™ w/CabMat™	SB36SCM
<b>E</b> Sink Base SuperCabinet™ w/Caddy	SB36SCDY L or R
<b>F</b> Sink Base SuperCabinet™ w/Tilt-Out Trays	SB36STS
<b>G</b> Sink Base SuperCabinet™ w/Tilt-Out Trays and CabMat™	SB36STSCM
<b>H</b> Sink Base SuperCabinet™ w/Tilt-Out Trays and Caddy	SB36STSCDY L or R

## SINK BASES

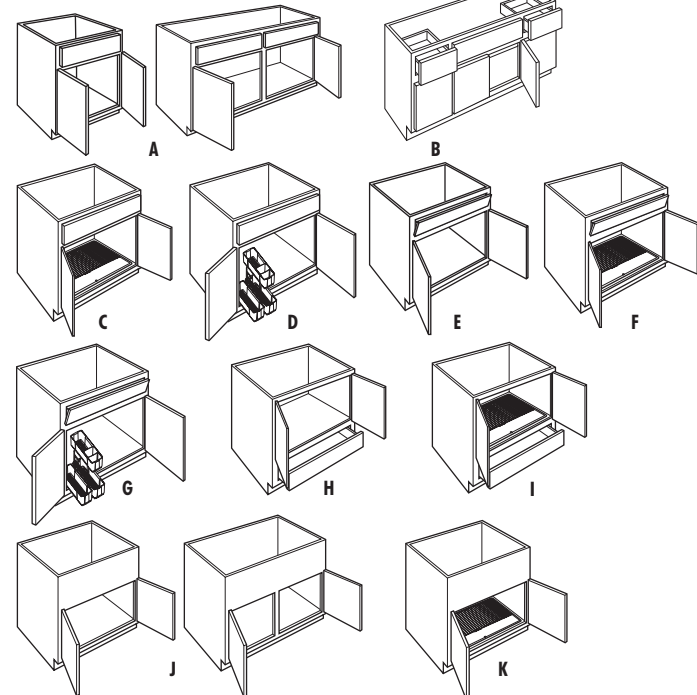

<b>A</b> Sink Base	SB24 L or R	SB**
<b>B</b> Sink Base w/Drawers		2SBD**
<b>C</b> Sink Base w/CabMat™		SB**CM
<b>D</b> Sink Base w/Caddy		SB36CDY L or R
<b>E</b> Sink Base w/Tilt-Out Trays		SB**ST
<b>F</b> Sink Base w/Tilt-Out Trays and CabMat™		SB**STCM
<b>G</b> Sink Base w/Tilt-Out Trays and Caddy		SB36STCDY L or R
<b>H</b> Sink Base w/Drawer Below		SB36D
<b>I</b> Sink Base w/Drawer Below and CabMat™		SB36DCM
<b>J</b> Country Sink Base		CNTYSB**
<b>K</b> Country Sink Base w/CabMat™		CNTYSB**CM

## CORNER SINK BASES

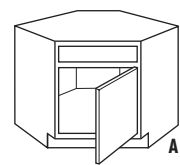

<b>A</b> Angled Corner Sink Base	ACS** L or R	ACS42
----------------------------------	--------------	-------

## BASE CORNER OPTIONS

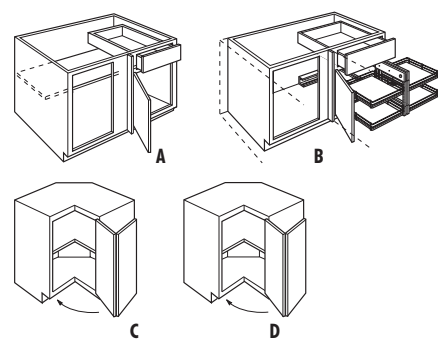

<b>A</b> Base Corner	BC** L or R
<b>B</b> Base Corner w/Pull-Out	BC**PO L or R
<b>C</b> Base Easy Reach	BER** L or R
<b>D</b> Asymmetrical Base Easy Reach	BER*** L or R

## BASE LAZY SUSANS

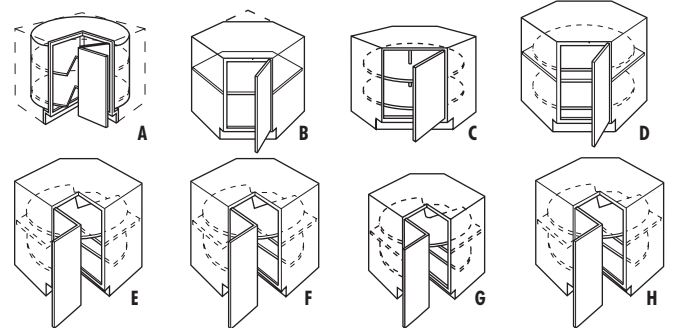

<b>A</b> Base Lazy Susan Corner w/Full Height Center Hinged Door	BLS36 L or R
<b>B</b> Diagonal Base w/Full Height Door	DAB36FS L or R
<b>C</b> Diagonal Base w/Full Height Door and Lazy Susan	DAB36S L or R
<b>D</b> Diagonal Base w/Full Height Door and Super Lazy Susan	DAB36SLS L or R
<b>E</b> Asymmetrical Super Lazy Susan	SLS*** L or R
<b>F</b> Asymmetrical Solid Wood Super Lazy Susan	SLSW*** L or R
<b>G</b> Super Lazy Susan	SLS** L or R
<b>H</b> Solid Wood Super Lazy Susan	SLSW** L or R

## BASE END OPTIONS

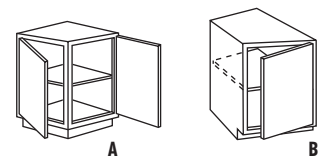

<b>A</b> Base End Cabinet	BEC24
<b>B</b> Base Transition Cabinet	BTCT12**

## DRAWER BASE CABINETS

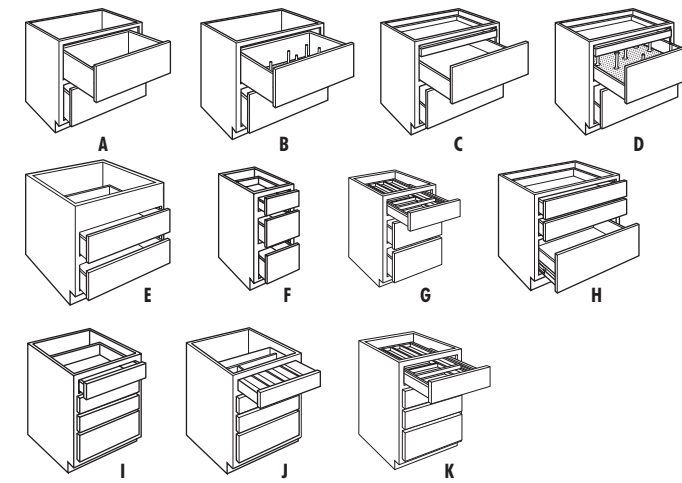

<b>A</b> Two Drawer Base	2DB**
<b>B</b> Two Drawer Base w/Pegged Dish Organizer	2DB36PDO
<b>C</b> Two Drawer Base w/Roll Tray	2DB**RT
<b>D</b> Two Drawer Base w/Roll Tray and Pegged Dish Organizer	2DB36RTPDO
<b>E</b> Two Drawer Base, Drop-In Range	2DB36DR
<b>F</b> Three Drawer Base	3DB**
<b>G</b> Three Drawer Base w/Wood Tiered Cutlery Divider Drawer	3DB**WTCD
<b>H</b> Three Drawer Base w/Deep Drawer	3DB**DD
<b>I</b> Four Drawer Base	4DB**
<b>J</b> Four Drawer Base w/Cutlery Insert Wood Organizer	4DB**CIW
<b>K</b> Four Drawer Base w/Wood Tiered Cutlery Divider Drawer	4DB**WTCD

## BASE WASTE CABINETS

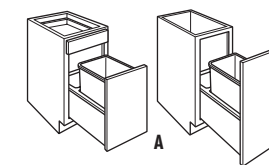

<b>A</b> Base Wastebasket w/Full Height Door	BWB**
	BWB**FH

## BASE END OPTIONS

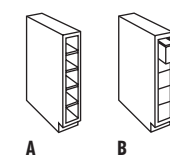

<b>A</b> Base Wine Cubby (Holds 5 bottles.)	BWC6
<b>B</b> Base Spice Cabinet w/Drawers	BSD6

## BASE OVEN & MICROWAVE CABINETS

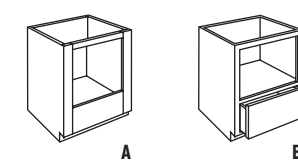

<b>A</b> Base Oven Cabinet	BO**
<b>B</b> Base Microwave Cabinet w/Drawer	BMWD**34

## BASE CORNER PENINSULA OPTIONS

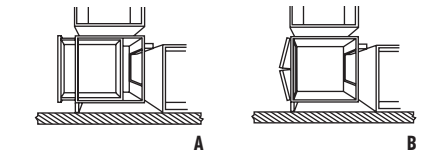

<b>A</b> Base Corner Peninsula w/Shelf and Drawer	BCP24
<b>B</b> Base Corner Peninsula w/Shelf and Full Height Doors	BCP24FH

## TALL UTILITY CABINETS / TALL PANTRY PULL-OUT

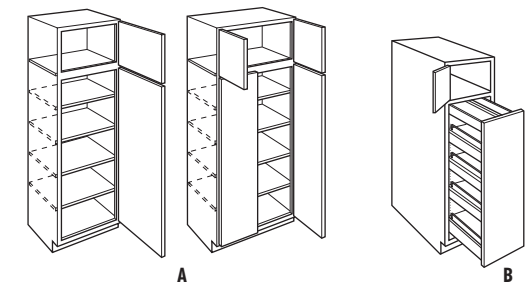

<b>A</b> Utility Cabinets	U***** L or R	U*****
<b>B</b> Tall Pantry Pull-Out		TPP*****24 L or R

## UTILITIES WITH ROLL TRAYS / UTILITY ORGANIZER

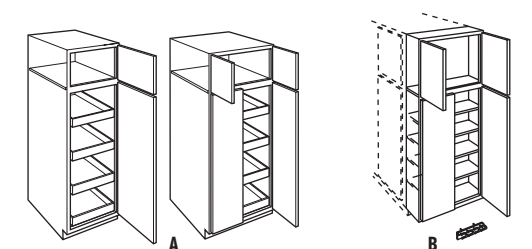

<b>A</b> Utility w/Roll Trays	U12**24RT L or R	U24**24RT L or R	U30**24RT
	U15**24RT L or R	U24**24RT	U33**24RT
	U18**24RT L or R	U27**24RT	U36**24RT
<b>B</b> Utility Organizer Cabinet	U21**24RT L or R		UOC24**6

## TALL OVEN & MICROWAVE CABINETS

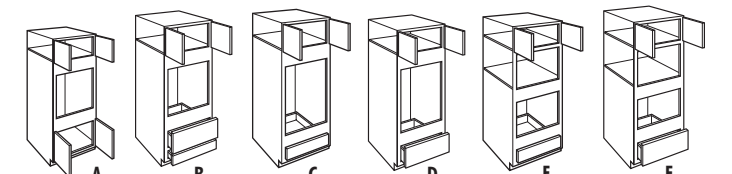

<b>A</b> Single Oven Cabinet	OCS***24
<b>B</b> Single Oven Cabinet w/Deep Drawer	OCS***24DD
<b>C</b> Double Oven Cabinet	OCDD***24
<b>D</b> Double Oven Cabinet w/Deep Drawer	OCDD***24DD
<b>E</b> Oven Microwave Cabinet	OMC***24
<b>F</b> Oven Microwave Cabinet w/Deep Drawer	OMC***24DD

## WALL BOOKCASES WITH VALANCE

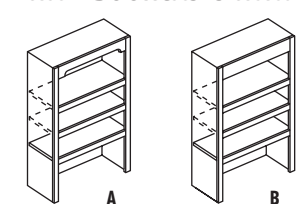

Specify valance type by adding appropriate letters to end of model number.		
Wall Bookcase w/Valance	W****BC	
	<b>A</b> with Furniture Valance	<b>B</b> with Straight Valance
	FV	WV

## TALL BOOKCASES WITH VALANCE

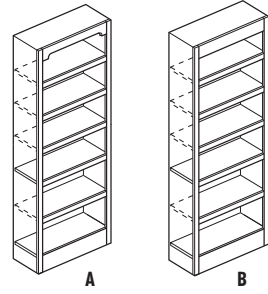

Specify valance type by adding appropriate letters to end of model number.	<b>A</b> with Furniture Valance	<b>B</b> with Straight Valance
Tall Bookcase w/Valance	T***12BC FV	WV

## BASE OFFICE FURNITURE

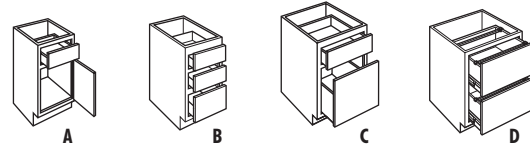

<b>A</b> Desk Door Drawer Base	DDO**29** L or R	DDO**29**
<b>B</b> Desk Drawer Base	DDR**2921	DDR**2924
<b>C</b> Desk File Drawer Base	DFD**2921	DFD**2924
<b>D</b> Desk Double File Drawer Base	DDFD**2921	DDFD**2924

## FURNITURE DRAWERS & WOOD TOPS

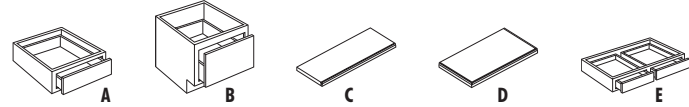

<b>A</b> Furniture Drawers	FD**06.7524	FD**1224
<b>B</b> Furniture Drawer Window Bench		FDWB**1824
<b>C</b> Wood Tops, One Sided	1TWT7221	1TWT7224
<b>D</b> Wood Tops, Three Sided	3TWT**21	3TWT**24
<b>E</b> Under Counter Drawer		UCD**21

## VANITY SINK BASES

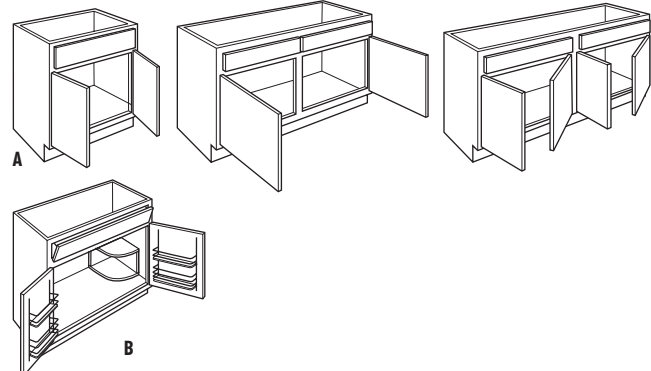

<b>A</b> Vanity Sink Base w/False Panels	VSB24*** L or R	VSB***18 VSB***21
<b>B</b> Vanity Sink Base SuperCabinet™ w/Tilt-Out Trays		VSSB**3421ST

## VANITY DRAWER BASE CABINETS

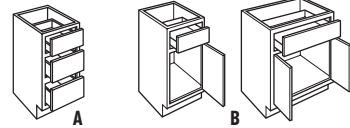

<b>A</b> Vanity Drawer Base		VDB***21
<b>B</b> Vanity Base w/Drawer	VB***21 L or R	VB***21

## VANITY PULL-OUT

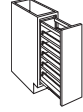

<b>A</b> Vanity Pull-Out	VP93421
--------------------------	---------

## VANITY SINK DRAWER BASES

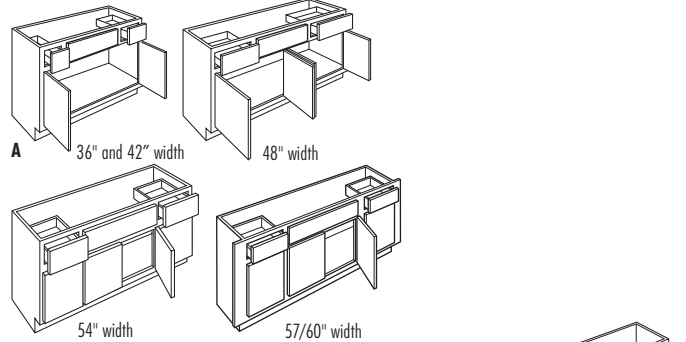

<b>A</b>	36" and 42" width	48" width		
<b>B</b>	24" and 30" width	36" width	42" and 48" width	60" width
<b>C</b>	54" width	57/60" width		

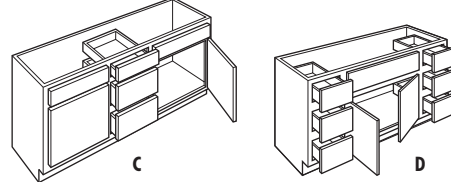

<b>A</b> Vanity Sink Drawer Base	2VSD***21	2VSD54**21FP 2VSD57/60**21FP
<b>B</b> Vanity Sink Drawer Base w/False Panels	VSD***21FP DL or DR	VSD60**21FP
<b>C</b> Vanity Sink Three Drawer Base	VS3D54**21	VS3D60**21
<b>D</b> Vanity Sink Drawer Base w/Six Drawers & False Panel		6VSD***21FP

## LINEN CLOSETS & VANITY UTILITY

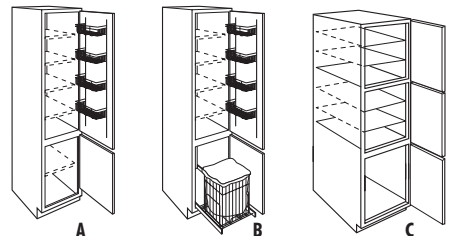

<b>A</b> Linen Closet	LC188421 L or R
<b>B</b> Linen Closet w/Removable Hamper	LCRH188421 L or R
<b>C</b> Vanity Utility	VU188421 L or R

## WALL CABINETS, VANITY MIRROR, & MEDICINE CABINET

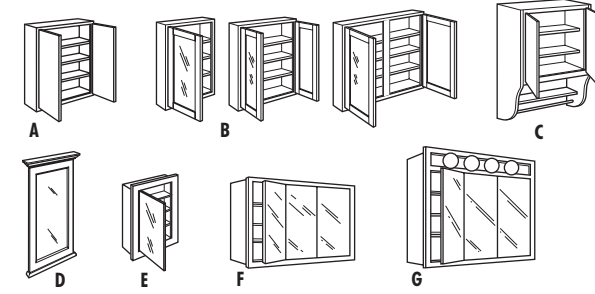

<b>A</b> Vanity Wall Cabinet		W24306
<b>B</b> Vanity Wall Mirror Cabinet	VWM**30 L or R	VWM**30
<b>C</b> Vanity Wall Towel Bar		VWTB24
<b>D</b> Vanity Mirror		VM**35
<b>E</b> Single Door Medicine Cabinet		MC16
<b>F</b> Tri-View Medicine Cabinet		TV**
<b>G</b> Tri-View Medicine Cabinet Lighted w/Chrome Face Plate		TMLC****

## PLAIN FILLERS

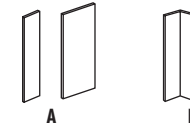

<b>A</b> Filler	F**	TF**	TF**FH
<b>B</b> Corner Filler			CF330

## OVERLAY FILLERS

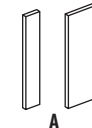

<b>A</b> Overlay Filler	OL**	VOL**
-------------------------	------	-------

## ORNATE FILLERS

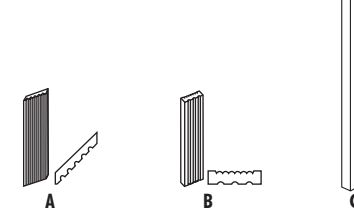

<b>A</b> Angled Fluted/Plain Reversible 3" Filler	BLVDF**	BLVDTF96
<b>B</b> Fluted/Beaded Reversible 3" or 6" Filler	FBF**	TFBF96
<b>C</b> Spore Filler		S96X1*

## BOX COLUMN FILLERS

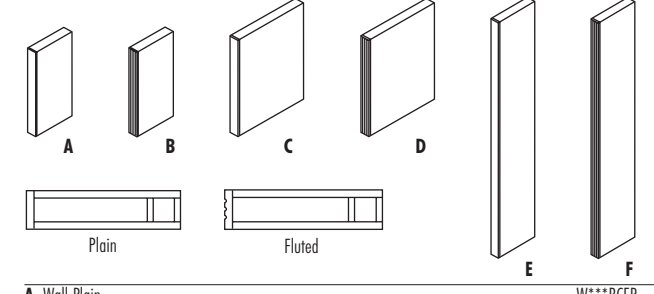

<b>A</b> Wall Plain	W***BCFP	
<b>B</b> Wall Fluted	W***BCFF	
<b>C</b> Base Plain	B334.527BCFP	
<b>D</b> Base Fluted	B334.527BCFF	
<b>E</b> Tall Plain	T3**15BCFP	T3**27BCFP
<b>F</b> Tall Fluted	T3**15BCFF	T3**27BCFF

## DECORATIVE APPLIANCE PANELS

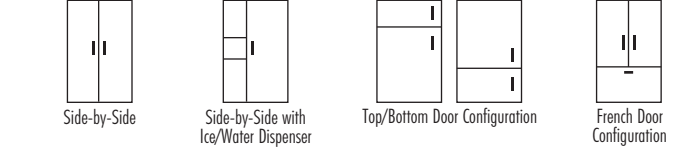

NOTE: Please see designer for complete listing of availability and sizes for customizable decorative appliance panels.

<b>A</b> Custom Panels	DAPNL1/4	DAPNL3/4	DAPNL3/4APF
------------------------	----------	----------	-------------

## PANELS & SKINS

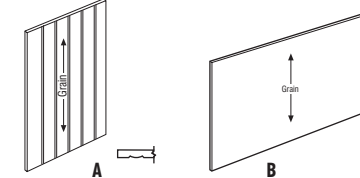

<b>A</b> Wood V-Grooved Panel Skin	BP4834.5VG	BP4896VG
<b>B</b> Cross Grain Veneer Back Panel Skin	BP9634.5CRSGR	BP9648CRSGR

## PANELS W/FILLER ATTACHED

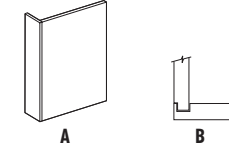

<b>A</b> Panels w/Filler Attached	BEPF1.5LAM BEPF1.5WD BEPF3LAM BEPF3WD	TEP24**F1.5LAM TEP24**F1.5WD TEP24**F3LAM TEP24**F3WD
<b>B</b> Panels w/Filler Attached & Furniture Ends	BEPF1.5FPE BEPF3FPE	TEP24**F1.5FPE TEP24**F3FPE

## CROWN MOULDINGS

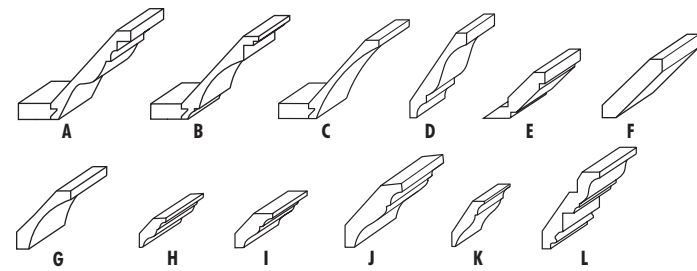

<b>A</b> Classic Tall Crown	CLTCROWN8
<b>B</b> Cornice Tall Crown	COTCROWN8
<b>C</b> Cove Crown	COVECROWN8
<b>D</b> Tall Crown	MTCROWN8
<b>E</b> Shaker Crown	SHKRCRM8
<b>F</b> Large Shaker Crown	LSHAKER8
<b>G</b> Small Cove Crown Moulding	SMCOVECROWN8
<b>H</b> Small Crown	SCM8
<b>I</b> Solid Wood Crown	SWCRM8
<b>J</b> Solid Wood Large Crown	SWLCRM8
<b>K</b> Solid Wood Tall Crown	SWTCRM8
<b>L</b> Solid Wood Victorian Crown	SWVCRM8

## MOULDING INSERTS

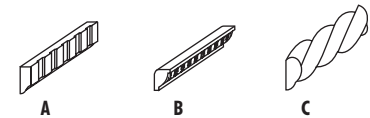

<b>A</b> Dentil	DE8
<b>B</b> Egg & Dart	EGD8
<b>C</b> Rope	RPM8

## STARTER MOULDINGS

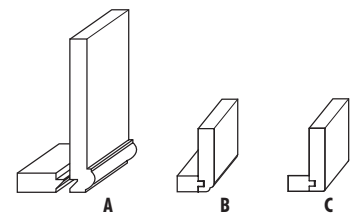

<b>A</b> Soffit Filler Moulding	SFM8
<b>B</b> Starter Moulding	STR8
<b>C</b> Starter Moulding, Shaker	STRS8

## ACCENT MOULDINGS

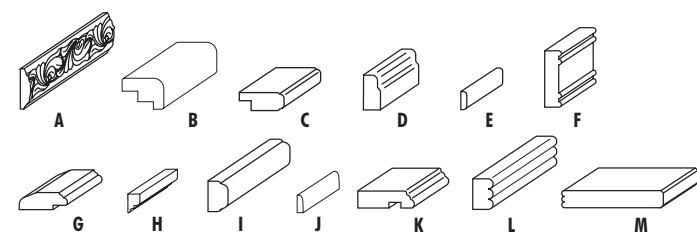

<b>A</b> Acanthus	ACAM
<b>B</b> Back Panel Moulding	BPM8
<b>C</b> Cabinet Panel Edge	CPE8
<b>D</b> Countertop Edge-Traditional	TCM8
<b>E</b> Flat Scribe	SM8
<b>F</b> Library	LBRM
<b>G</b> Mirror Frame	WMF8
<b>H</b> Ogee Edge	OGEM
<b>I</b> Single Bead Edge	SBE8
<b>J</b> Small Scribe	SSM8
<b>K</b> Soffit Trim	TSTM8
<b>L</b> Triple Bead Edge	TBEM
<b>M</b> Triple Bead Pilaster	TBP8

## TOE MOULDINGS

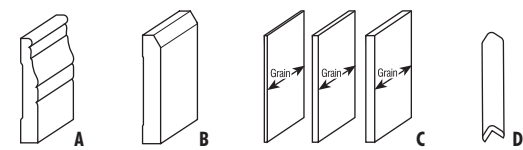

<b>A</b> Baseboard	BBM8
<b>B</b> Baseboard - Shaker	BBMSH8
<b>C</b> Toeboard	TB8WD14
<b>D</b> Toekick Cap	TB8LAM**
	TKC

## WINDOW CASING



<b>A</b> Window Casing - Traditional	WCT7
--------------------------------------	------

## LIGHT RAILS

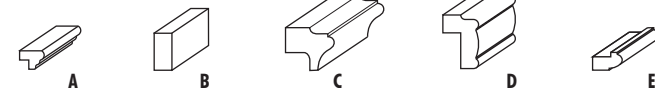

<b>A</b> Cap Moulding	CAPM
<b>B</b> Light Baffle (Square)	LB2
<b>C</b> Small Light Rail Moulding	SMLR
<b>D</b> Light Rail Moulding	LRM
<b>E</b> Valley Forge Moulding	VFR8

## CORNER MOULDINGS

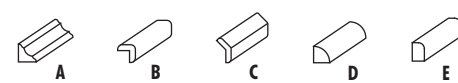

<b>A</b> Inside Corner	ICM8
<b>B</b> Outside Corner	OCM8
<b>C</b> Outside Corner 135°	OC135
<b>D</b> Quarter Round	QRM
<b>E</b> Shoe - Convex Inside Corner	SHM8

## VALANCES

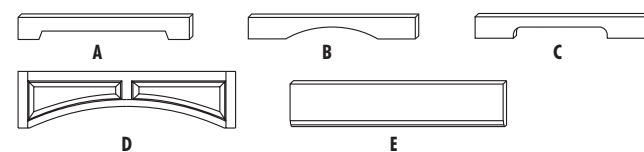

<b>A</b> Angled Furniture Toekick Valance	AVTOE**
<b>B</b> Arched Valance	AV**
<b>C</b> Furniture Valance	FV**
<b>D</b> Raised Panel Arch Valance	RPV**
<b>E</b> Straight Valance	VV**

## DECORATIVE ORNAMENTS



<b>A</b> Mission Rosette	ROSETTEMIS
<b>B</b> Corner Rosette - Fluted Beaded	FFRC3X3
	BFRC3X3

## DECORATIVE SUPPORTS

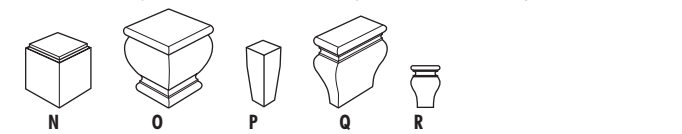
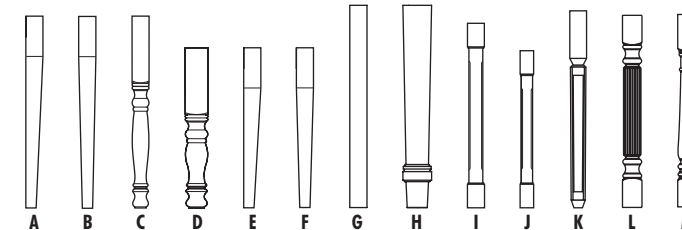

<b>A</b> Bar Leg, 2-Sided	2SBARLEG
<b>B</b> Bar Leg, 4-Sided	4SBARLEG
<b>C</b> English Bar Column	ENGBARCOLUMN
<b>D</b> English Island Column	ENGLISLCOLUMN
<b>E</b> Island Leg, 2-Sided	2SISLLEG
<b>F</b> Island Leg, 4-Sided	4SISLLEG
<b>G</b> Island Leg Straight	ISLEGST
<b>H</b> Island Leg Tapered	ISLEGTPRD
<b>I</b> Metro Bar Column	METBARCOLUMN
<b>J</b> Metro Island Column	METISL COLUMN
<b>K</b> Mission Leg	DLEGMISSION
<b>L</b> Reed Leg	RDLEG
<b>M</b> Spool Leg	SPLEG
<b>N</b> Large Square Foot	LGSQFOOT
<b>O</b> Lille Foot	LIFOOT
<b>P</b> Tapered Leg	TAPLG
<b>Q</b> Toekick Tulip Foot	TKTLFOOT
<b>R</b> Tulip Foot	TLFOOT

## DECORATIVE SPLIT TURNINGS



<b>A</b> End Split Turning	SPTRINGEND
<b>B</b> Spool Split Turning	SPTRINGSPPOOL**

## DECORATIVE CORBELS & SHELF SUPPORTS

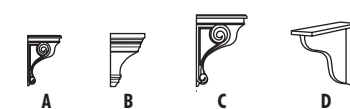

<b>A</b> 9" Small Corbel	SMCORBEL
<b>B</b> 9" Art Corbel	CORBELART9
<b>C</b> 13" Large Corbel	LGCORBEL
<b>D</b> Snack Bar Support	SBS

## WALL ACCESSORIES



<b>A</b> Cookbook Rack	CBR
<b>B</b> Tablet Holder	TABLEHLDR

## BASE / TALL / VANITY ACCESSORIES

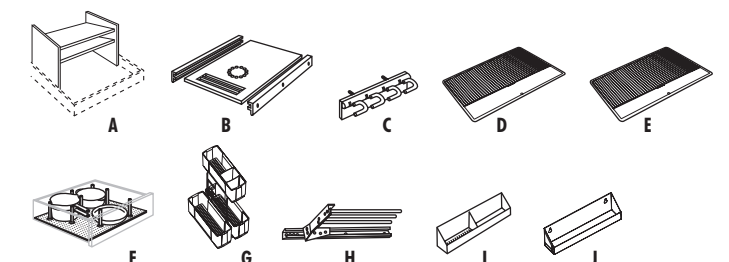

<b>A</b> Base Pan Storage	BPS**
<b>B</b> Bread Box Lid	BBX**
<b>C</b> Broom Clip	BRMCLP
<b>D</b> CabMat™	CABMAT**
<b>E</b> CabMat™ Vanity	CABMATV**
<b>F</b> Pegged Dish Organizer	PDO
<b>G</b> Sink Base Caddy	SBCADDY
<b>H</b> Sliding Towel Rack	STR
<b>I</b> Tilt-Out Trays, Plastic	TOT**
<b>J</b> Tilt-Out Trays, Stainless Steel	TOTSS**

## BASE CUTLERY, ORGANIZERS, & DIVIDERS

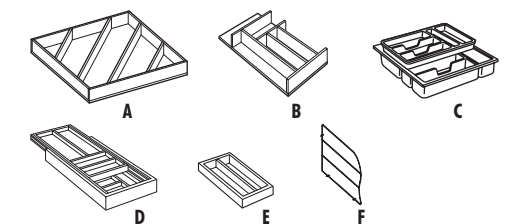

<b>A</b> Cooking Utensil Divider	CUDD**
<b>B</b> Cutlery Insert Wood Organizer	CIW**
<b>C</b> Cutlery Divider, Tiered	TCD**
<b>D</b> Wood Tiered Cutlery Divider Drawer	WTCD**
<b>E</b> Lid Organizer	LO
<b>F</b> Tray Divider Kit	CTDK

## ROLL TRAY KITS & SHELVES

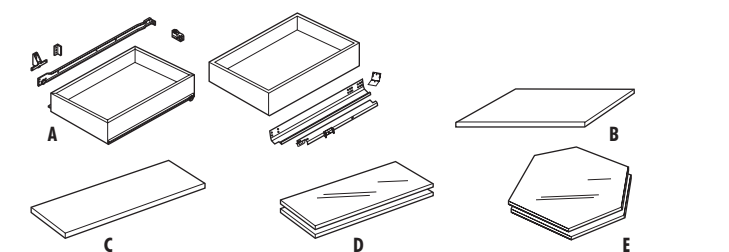

<b>A</b> Roll Tray Kits	RT**
<b>B</b> Exterior Shelf	ES****
<b>C</b> Full Depth Shelves	SK****
<b>D</b> Glass Shelf Kit	GSK****
<b>E</b> Glass Shelf Kit, Diagonal	GSKDW**



## LOOKING FOR MORE SCHROCK OPTIONS?

Need more options, finishes, and features for your home's evolving lifestyle? View our Full Line of Schrock Cabinetry® at [schrock.com](http://schrock.com) for more ideas and inspiration. Our mix of cabinetry has all the semi-custom options needed to further enhance your home with warmth, texture and personality. Schrock Cabinetry. Beautiful on the outside. Smart on the inside®.

EXPERT CRAFTSMANSHIP

SMART SOLUTIONS™

SIGNATURE DETAILING



Front Cover Image: Kittrell PureStyle Limestone

Schrock is a certified brand in the Kitchen Cabinet Manufacturers Association (KCMA) Environmental Stewardship Program. The program recognizes companies that demonstrate an ongoing commitment to environmental practices and sustainability.

Styles, product availability and construction may vary slightly from those shown in this catalog due to material availability and/or design evolution. Specifications are subject to change without notice. For more details check with your designer.

Supersedes prior versions.

Product photography and illustrations have been reproduced as accurately as printing technologies permit. To ensure highest satisfaction, we strongly recommend you view an actual sample for best color, wood grain and finish representation.

MasterBrand Cabinets © 2016, 1123829930 Printed in U.S.A. 2016-07/QUAD/9M

