

TOMMY GATE®



2016

LIFTGATE GUIDE

PRODUCTS • OPTIONS • APPLICATIONS



CONTENTS

10 PICKUP LIFTGATES

- 10 G2 Series
- 12 Original Series

18 SERVICE BODY LIFTGATES

- 18 G2 Series
- 20 Original Series

26 FLATBED, STAKE, & VAN BODY LIFTGATES

- 26 Tuckunder Series — TKT Models
- 30 Railgate Series — High-Cycle, Bi-Fold Models
- 32 Railgate Series — High-Cycle, Fixed-Platform Models
- 36 Railgate Series — Standard, Dock-Friendly Models
- 38 Railgate Series — Standard, Fixed-Platform Models
- 42 G2 Series
- 44 Original Series

46 DUMP BODY LIFTGATES

- 46 G2 Series — Lift-N-Dump

52 CARGO VAN LIFTGATES

- 52 Cantilever Series
- 54 650 Series

55 APPLICATIONS & BRACKETS

A large, white, three-dimensional sign is mounted on a brick wall. The sign features the text 'The original TOMMY GATE hydraulic lift' in blue and red. A red arrow icon points upwards from the word 'original'. The sign is set against a cloudy sky.

The original
TOMMY GATE
hydraulic lift

50
1965 - 2015
YEARS



THE ORIGINAL HYDRAULIC LIFT

Woodbine Manufacturing Company is the developer of Tommy Gate, a premier brand of private, commercial, and industrial hydraulic lifts. Established in Woodbine, Iowa in 1965 by Delbert "Bus" Brown, Tommy Gate has experienced steady growth in each of the past five decades and is widely celebrated as the industry leader.

Now sold in every corner of the world, Tommy Gate's strong reputation for quality has been built through a strict adherence to the highest standards of engineering, craftsmanship, and customer service.



PICKUP



SERVICE BODY

G2 SERIES

1500 LBS. CAPACITY

A dual-cylinder, parallel-arm design liftgate. Versatile, popular, and modern. [PAGE 10](#)

G2 SERIES

1600 LBS. CAPACITY

A dual-cylinder, parallel-arm design liftgate. Versatile, popular, and modern. [PAGE 18](#)

ORIGINAL SERIES

1000 LBS. CAPACITY

A single-cylinder liftgate based on a cable and pulley system. The classic Tommy Lift. [PAGE 12](#)

ORIGINAL SERIES

1000 LBS. CAPACITY

A single-cylinder liftgate based on a cable and pulley system. The classic Tommy Lift. [PAGE 20](#)

LIFTGATE OVERVIEW

Tommy Gate offers a full line of liftgates for any personal, commercial, or industrial application. Depending on your particular cargo-handling needs and your vehicle, certain liftgates may be more suitable than others. This guide is intended to help you most easily identify which Tommy Gate hydraulic lift is right for you.

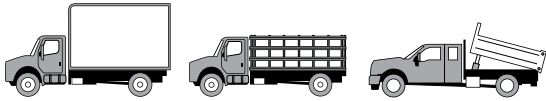

FLATBED, STAKE, & VAN

G2 SERIES

1600 LBS. CAPACITY

A dual-cylinder, parallel-arm design liftgate. Versatile, popular, and modern. [PAGE 42](#)

ORIGINAL SERIES

1600 LBS. CAPACITY

A single-cylinder liftgate based on a cable and pulley system. The classic Tommy Lift. [PAGE 44](#)

TUCKUNDER SERIES

3000 LBS. CAPACITY

Wide-arm, self-leveling, dual-cylinder liftgates that store underneath the vehicle bed. [PAGE 26](#)

RAILGATE SERIES

HIGH-CYCLE MODELS

3000 LBS. CAPACITY

A level-ride liftgate ideal for handling heavy, sensitive, wheel-based cargo. [PAGE 30](#)

STANDARD MODELS

2000 LBS. CAPACITY

A level-ride liftgate ideal for handling heavy, sensitive, wheel-based cargo. [PAGE 36](#)

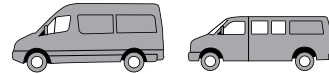

CARGO VANS

CANTILEVER SERIES

1300 LBS. CAPACITY

A modern lift that is specifically designed to operate seamlessly with commercial vans. [PAGE 52](#)

650 SERIES

650 LBS. CAPACITY

Low-capacity, compact, and internally-mounted; an ideal liftgate for lightweight vans. [PAGE 54](#)

TOMMY GATE







THE NEXT GENERATION

The Tommy Gate G2 Series is a dual-cylinder, parallel-arm design which utilizes a pair of hydraulic cylinders to lower and raise the lift by applying direct power to both sides of the platform. G2 Series liftgates for pickups are versatile, popular, and modern.

◀ **G2-60-1542 EA38**

Shown with optional rubber platform bumpers and discontinued recessed light kit. Recessed lights have been replaced by a bolt-on kit.

Frames and platforms on every G2 Series liftgate are hand assembled and hand welded, while precision parts are laser cut and/or robotically welded.



DUAL DRIVE ADVANTAGES

Dual-drive liftgates provide increased durability for rigorous cycling and have low maintenance requirements. A paint-before-assembly process also increases the longevity of the lift's aesthetics.

G2 SERIES LIFTGATE FEATURES

- Dual hydraulic cylinders
- Virtually maintenance-free components
- Recessed control
- Larger platforms
- Fully-enclosed hydraulic system located within the lift mainframe



SPECS

PICKUP — G2 SERIES

AVAILABLE MODELS

TWO-YEAR STANDARD WARRANTY

| | Model Number | Load Area | Taper | Travel | Platform Fold | Application ¹ | Gate Weight |
|--|-------------------------------------|-----------|-------|--------|---------------|--------------------------|-------------|
| 1300 lb. Capacity | <u>Treadplate Platforms</u> | | | | | | |
| | G2-60-1342 TP27 | 55 x 27 | 4 | 42 | No | A,B | 438 |
| | G2-60-1342 TP38 | 55 x 38 | 4 | 42 | Yes | A,B | 478 |
| | G2-60-1342 TP42 | 55 x 42 | 7 | 42 | Yes | A,B | 503 |
| | <u>TommyTraction™ Platform</u> | | | | | | |
| | G2-60-1342 TT27 | 55 x 27 | 4 | 42 | No | A,B | 439 |
| | <u>Aluminum Platforms</u> | | | | | | |
| | G2-60-1342 EA27 | 55 x 27 | 6 | 42 | No | A,B | 395 |
| | G2-60-1342 EA38 | 55 x 38 | 6 | 42 | Yes | A,B | 421 |
| | G2-60-1342 EA48 ² | 55 x 48 | 6 | 42 | Yes | A,B | 442 |
| <u>Bar Grate Platform</u> | | | | | | | |
| G2-60-1342 BG27 | 55 x 27 | 4 | 42 | No | A,B | 445 | |
| 1500 lb. Capacity | <u>Treadplate Platforms</u> | | | | | | |
| | G2-60-1542 TP27 | 55 x 27 | 4 | 42 | No | B | 438 |
| | G2-60-1542 TP38 | 55 x 38 | 4 | 42 | Yes | B | 478 |
| | G2-60-1542 TP42 | 55 x 42 | 7 | 42 | Yes | B | 503 |
| | <u>TommyTraction™ Platform</u> | | | | | | |
| | G2-60-1542 TT27 | 55 x 27 | 4 | 42 | No | B | 439 |
| | <u>Aluminum Platforms</u> | | | | | | |
| | G2-60-1542 EA27 | 55 x 27 | 6 | 42 | No | B | 395 |
| | G2-60-1542 EA38 | 55 x 38 | 6 | 42 | Yes | B | 421 |
| | G2-60-1542 EA48 ² | 55 x 48 | 6 | 42 | Yes | B | 442 |
| <u>Bar Grate Platform</u> | | | | | | | |
| G2-60-1542 BG27 | 55 x 27 | 4 | 42 | No | B | 445 | |
| G2 MODELS FOR MID-SIZED PICKUPS | | | | | | | |
| 750 lb. Capacity | <u>Treadplate Platforms</u> | | | | | | |
| | G2-54-7542 TP38 NEW | 49 x 38 | 4 | 42 | Yes | G | 421 |
| | <u>Aluminum Platforms</u> | | | | | | |
| G2-54-7542 EA38 NEW | 50 x 38 | 6 | 42 | Yes | G | 369 | |

G2 SERIES DIMENSIONS ³

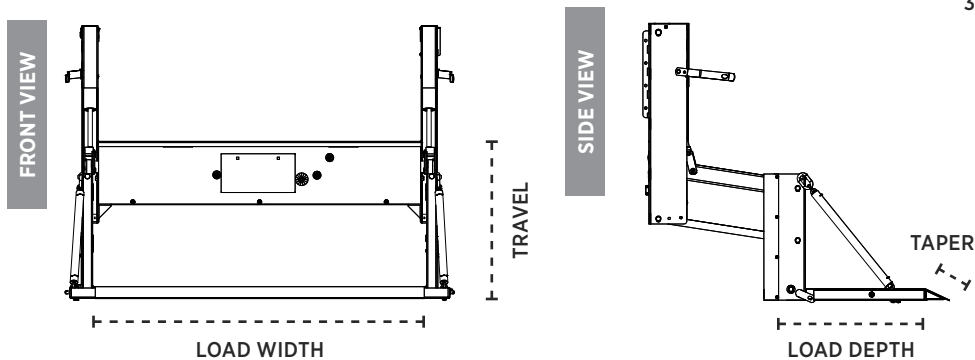

1. See applications on page 55.
2. EA48 platform extends 10" above top of liftgate mainframe. See image on page 15.
3. For detailed dimensions, visit www.tommygate.com

**ORIGINAL SERIES****THE ORIGINAL TOMMY LIFT**

The Original Series is a single-cylinder, parallel-arm design based on a cable and pulley system. The classic pickup lift.

ORIGINAL SERIES ADVANTAGES

Tried and true reliability. Original Series models have been used by a wide variety of commercial industries over the past fifty years. Constructed with the same high-quality pumps and motors found in all other Tommy Gate lifts, Original Series liftgates use military aircraft-grade cable for added strength.



Throughout the last 50 years the Original Series has been a staple in the liftgate industry. Invented by Delbert “Bus” Brown, and first sold for pickups in 1965, the assembly process used in constructing Original Series liftgates has not changed much over the years. Although components have been upgraded, the basic design is essentially the same. Built by hand, by master welders, machinists, and quality control experts, the exceptional quality of Tommy Gate hydraulic lifts is seen in every liftgate that leaves the Woodbine, Iowa factory.

ORIGINAL SERIES FEATURES

- Durable, military aircraft quality lifting cables
- Fully-enclosed hydraulic system safely encased within liftgate mainframe
- Pressure bypass prevents overloading
- Fold-down platform for dock or forklift loading
- Timed inactivity switch



SPECS PICKUP — ORIGINAL SERIES

AVAILABLE MODELS

ONE-YEAR STANDARD WARRANTY

| | Model Number | Load Area | Taper | Travel | Platform Fold | Application ¹ | Gate Weight |
|--------------------------|-------------------------|-----------|-------|--------|---------------|--------------------------|-------------|
| 1000 lb. Capacity | Treadplate Platforms | | | | | | |
| | 60-1040 TP27 | 58 x 27 | none | 40 | No | A, B | 365 |
| | 60-1040 TP38 | 58 x 38 | 4 | 40 | Yes | A, B | 420 |
| | TommyTraction™ Platform | | | | | | |
| | 60-1040 TT27 | 58 x 27 | none | 40 | No | A, B | 360 |
| | Aluminum Platform | | | | | | |
| 60-1040 EA39 | 55 x 39 | 6 | 40 | Yes | A, B | 385 | |

ORIGINAL SERIES DIMENSIONS²

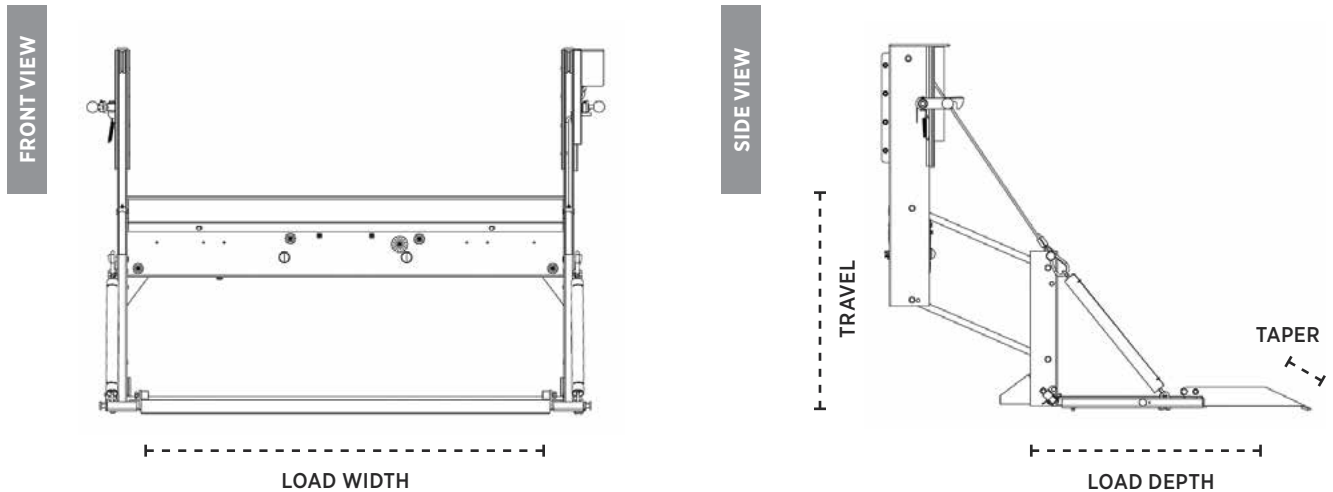

COMPACT PICKUP LIFTGATES

Tommy Gate Original Series liftgates fit many compact pickup trucks, not shown above. Visit www.tommygate.com to learn more about model “MINI” liftgates.

1. See applications on page 55.
2. For detailed dimensions, visit www.tommygate.com

FEATURES & OPTIONS

PICKUP

STANDARD FEATURES



| | | | |
|--|-------------------------------------|----------------|----------------|
| | Fixed and Timed Toggle Control | ● | ● |
| | Recessed Control | ● | - |
| | Vehicle-specific Mounting Brackets | ● | ● |
| | Power Cable with Full-length Ground | ● | ● |
| | Spare Tire Access | ● | ● |
| | 150-amp Circuit Breaker | ● | ● |
| | Maintenance-free Pins and Bushings | ● | - |
| | Drop-away Platform | ● | - |
| | Hitch Compatible | ● ¹ | ● ¹ |

AVAILABLE OPTIONS



| | | | |
|--|---|----------------|----------------|
| | Remote Pendant Control | ● | ● |
| | Dual Controls | ● | ● |
| | Rubber Platform Bumpers | ● | ● |
| | Bolt-on Light Kit (Incandescent or LED) | ● | - |
| | Bolt-on Light Kit (incandescent or LED) | - | ● |
| | Folding Tire Rack | ● ² | ● ² |
| | Galvanized Frame and Platform | ● ³ | - |
| | Rear Camera and Sensor Bar | ● | ● |

- Standard
- Optional
- Not Available

1. Compatible with many hitches. Visit www.tommygate.com to view complete hitch chart.
2. Not compatible with folding platforms. See spec charts.
3. Galvanized option not available with Steel Treadplate platforms. Call factory for ordering details.

PLATFORMS PICKUP

PLATFORM MATERIALS



| | | | |
|--|-------------------|---|---|
| | Steel Treadplate | ● | ● |
| | Extruded Aluminum | ● | ● |
| | TommyTraction | ● | ● |
| | Steel Bargrate | ● | - |

EXTRUDED ALUMINUM (G2 SERIES MODELS SHOWN)

EA27 - 27" Loading Depth



EA38 - 38" Loading Depth



EA48 - 48" Loading Depth (EXTENDS ABOVE TRUCK BOX)



STEEL PLATFORMS (G2 SERIES MODELS SHOWN)

TP27 - 27" Loading Depth



TP38 - 38" Loading Depth



TP42 - 42" Loading Depth



G2-SERIES GALVANIZING OPTION

A high-quality galvanized finish supports long-lasting performance and appearance in even the most extreme climate conditions.

NOT AVAILABLE WITH STEEL TREADPLATE PLATFORMS. CALL FACTORY FOR ORDERING DETAILS.



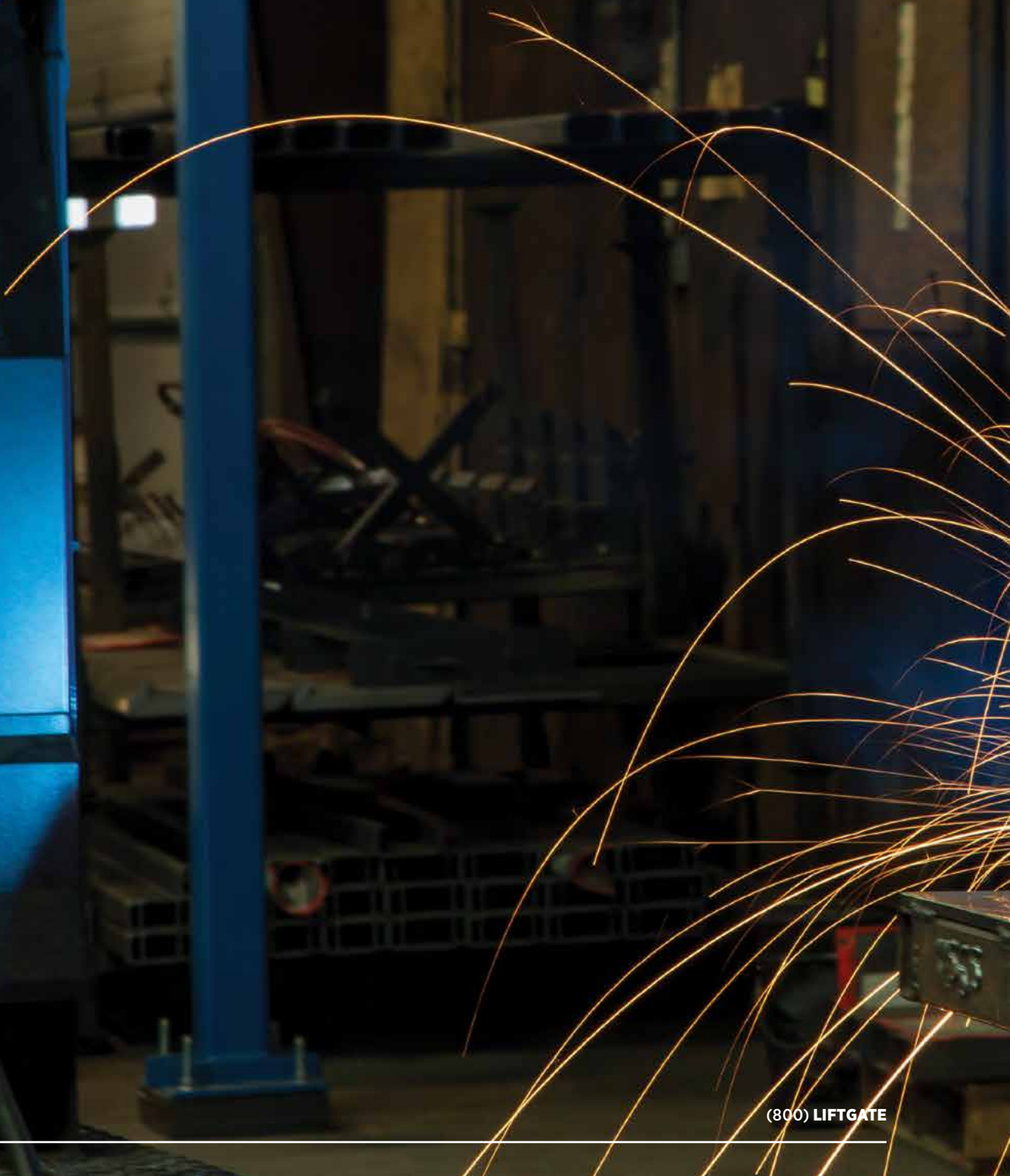

ESTD 1965



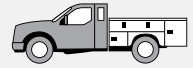

THE SECOND GENERATION

The Tommy Gate G2 Series is a dual-cylinder, parallel-arm design which utilizes a pair of hydraulic cylinders to lower and raise the lift by applying direct power to both sides of the platform. With forty-two inches of vertical travel, the G2 Series is a great fit for most any service body.

◀ **G2-54-1642 TP38**

Shown with discontinued recessed light kit. Recessed lights have been replaced by a bolt-on kit.

Hydraulic cylinders are built in-house. Precision cylinder welds are executed by robotic machines, while assembly and testing are done by hand.



G2 SERIES LIFTGATE FEATURES

- Dual hydraulic cylinders
- Virtually maintenance-free components
- Recessed control
- Larger platforms
- Fully-enclosed hydraulic system located within the liftgate mainframe



Dual-drive liftgates provide increased durability for rigorous cycling and have low maintenance requirements. A paint-before-assembly process also increases the longevity of the lift's aesthetics.



MODELS FOR SERVICE BODIES WITH 48" OPENING

TWO-YEAR STANDARD WARRANTY

| | Model Number | Load Area | Taper | Travel | Platform Fold | Gate Weight |
|--------------------|------------------------------|-----------|-------|--------|---------------|-------------|
| 1300 lb. Capacity | Treadplate Platforms | | | | | |
| | G2-54-1342 TP27 | 49 x 27 | 4 | 42 | No | 415 |
| | G2-54-1342 TP38 | 49 x 38 | 4 | 42 | Yes | 453 |
| | G2-54-1342 TP42 | 49 x 42 | 7 | 42 | Yes | 477 |
| | TommyTraction™ Platform | | | | | |
| | G2-54-1342 TT27 | 50 x 27 | 4 | 42 | No | 416 |
| | Aluminum Platforms | | | | | |
| | G2-54-1342 EA27 | 49 x 27 | 6 | 42 | No | 375 |
| | G2-54-1342 EA38 | 49 x 38 | 6 | 42 | Yes | 399 |
| | G2-54-1342 EA48 ¹ | 49 x 48 | 6 | 42 | Yes | 419 |
| Bar Grate Platform | | | | | | |
| G2-54-1342 BG27 | 50 x 27 | 4 | 42 | No | 422 | |
| 1600 lb. Capacity | Treadplate Platforms | | | | | |
| | G2-54-1642 TP27 | 49 x 27 | 4 | 42 | No | 415 |
| | G2-54-1642 TP38 | 49 x 38 | 4 | 42 | Yes | 453 |
| | G2-54-1642 TP42 | 49 x 42 | 7 | 42 | Yes | 477 |
| | TommyTraction™ Platform | | | | | |
| | G2-54-1642 TT27 | 50 x 27 | 4 | 42 | No | 416 |
| | Aluminum Platforms | | | | | |
| | G2-54-1642 EA27 | 49 x 27 | 6 | 42 | No | 375 |
| | G2-54-1642 EA38 | 49 x 38 | 6 | 42 | Yes | 399 |
| | G2-54-1642 EA48 ¹ | 49 x 48 | 6 | 42 | Yes | 419 |
| Bar Grate Platform | | | | | | |
| G2-54-1642 BG27 | 50 x 27 | 4 | 42 | No | 422 | |

ADDITIONAL BODY SIZES

| Body Opening | Model | Description |
|--------------|-------|---------------------|
| 54" | 60SB | 55" Load Area width |

1. See applications on page 55.
2. EA48 platform extends 10" above top of liftgate mainframe. See image on page 23.
3. For detailed dimensions, visit www.tommygate.com

G2 SERIES DIMENSIONS ³

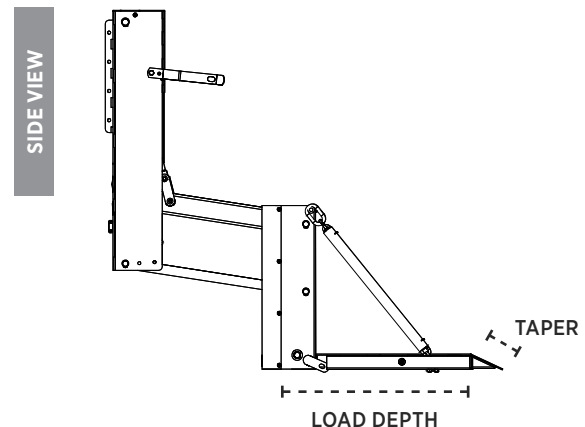
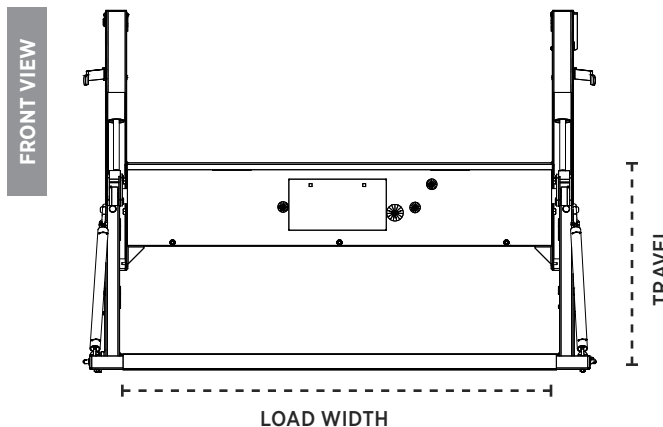



ORIGINAL SERIES



THE ORIGINAL TOMMY LIFT

The Original Series is a single-cylinder, parallel-arm design based on a cable and pulley system. The classic pickup lift.

ORIGINAL SERIES ADVANTAGES

Tried and true reliability. Original Series models have been used by a wide variety of commercial industries over the past fifty years. Constructed with the same high-quality pumps and motors found in all other Tommy Gate lifts, Original Series liftgates use military aircraft-grade cable for added strength.



The state-of-the-art Tommy Gate factory houses six different assembly lines as well as developmental engineering and testing departments and is located on the same piece of ground where every Tommy Gate hydraulic lift has been produced for over 50 years.

ORIGINAL SERIES FEATURES

- Durable, military aircraft quality lifting cables.
- Fully-enclosed hydraulic system safely encased within liftgate mainframe
- Pressure bypass prevents overloading
- Fold-down platform for dock or forklift loading
- Timed inactivity switch



SPECS

SERVICE BODY — ORIGINAL SERIES

MODELS FOR SERVICE BODIES WITH 48" OPENING

ONE-YEAR STANDARD WARRANTY

| | Model Number | Load Area | Taper | Travel | Platform Fold | Gate Weight |
|--------------------------|-------------------------|-----------|-------|--------|---------------|-------------|
| 1000 lb. Capacity | Treadplate Platforms | | | | | |
| | 54-1040 TP27 | 52 x 27 | none | 40 | No | 335 |
| | 54-1040 TP38 | 52 x 38 | 4 | 40 | Yes | 385 |
| | TommyTraction™ Platform | | | | | |
| | 54-1040 TT27 | 52 x 27 | none | 40 | No | 330 |
| | Aluminum Platform | | | | | |
| | 54-1040 EA39 | 49 x 39 | 6 | 40 | Yes | 355 |

ADDITIONAL BODY SIZES

| Body Opening | Model | Description |
|--------------|-------|---------------------|
| 54" | 60SB | 55" Load Area width |

ORIGINAL SERIES DIMENSIONS ²

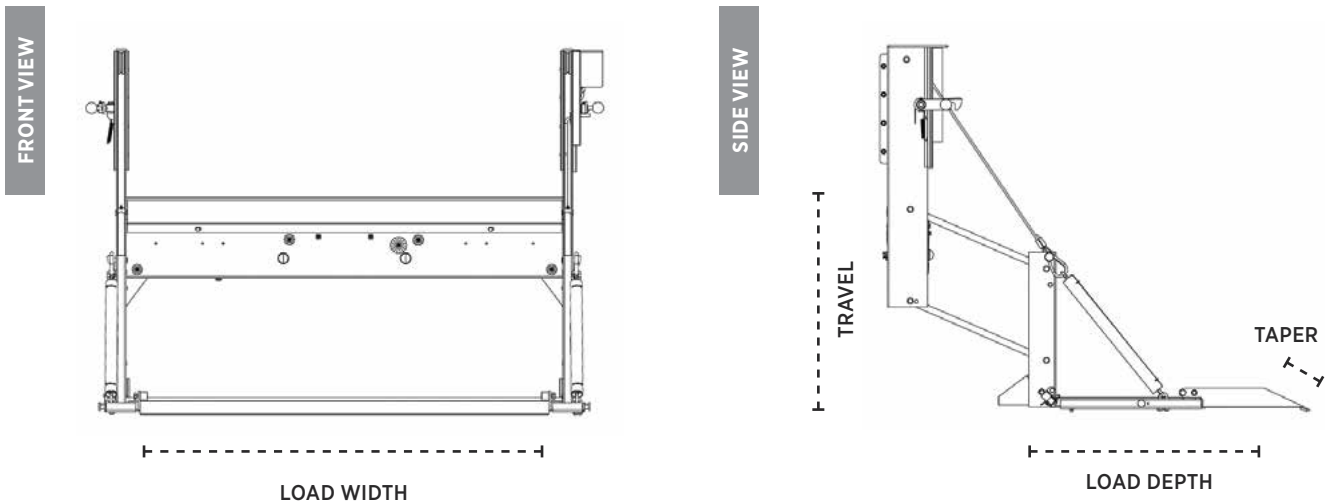

1. See applications on page 55.
 2. For detailed dimensions, visit www.tommygate.com

FEATURES & OPTIONS

SERVICE BODY

STANDARD FEATURES



| | | | |
|--|-------------------------------------|----------------|----------------|
| | Fixed and Timed Toggle Control | ● | ● |
| | Recessed Control | ● | - |
| | Vehicle-specific Mounting Brackets | ● | ● |
| | Power Cable with Full-length Ground | ● | ● |
| | 150-amp Circuit Breaker | ● | ● |
| | Maintenance-free Pins and Bushings | ● | - |
| | Drop-away Platform | ● | - |
| | Hitch Compatible | ● ¹ | ● ¹ |

AVAILABLE OPTIONS



| | | | |
|--|---|----------------|----------------|
| | Remote Pendant Control | ● | ● |
| | Dual Controls | ● | ● |
| | Rubber Platform Bumpers | ● | ● |
| | Bolt-on Light Kit (Incandescent or LED) | ● | - |
| | Bolt-on Light Kit (incandescent or LED) | - | ● |
| | Folding Tire Rack | ● ² | ● ² |
| | Galvanized Frame and Platform | ● ³ | - |

- Standard
- Optional
- Not Available

1. Compatible with many hitches. Visit www.tommygate.com to view complete hitch chart.

2. Not compatible with folding platforms. See spec charts.

3. Galvanized option not available with Steel Treadplate platforms. Call factory for ordering details.



PLATFORMS

SERVICE BODY

PLATFORM MATERIALS



| | | | |
|--|-------------------|---|---|
| | Steel Treadplate | ● | ● |
| | Extruded Aluminum | ● | ● |
| | TommyTraction | ● | ● |
| | Steel Bargrate | ● | - |

EXTRUDED ALUMINUM (G2 SERIES MODELS SHOWN)

EA38 - 38" Loading Depth



EA48 - 48" Loading Depth (EXTENDS ABOVE TRUCK BOX)

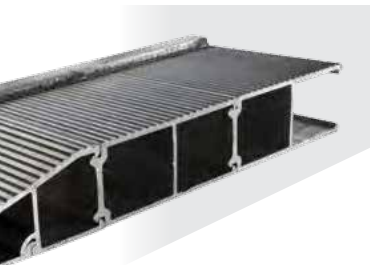

ALUMINUM PLATFORMS ARE COMPRISED OF INTERLOCKING, 6061-T6 AIRCRAFT-QUALITY EXTRUSIONS.

STEEL PLATFORMS (G2 SERIES MODELS SHOWN)

TP27 - 27" Loading Depth



TP38 - 38" Loading Depth



PLATFORM DROP-CHAIN COVERS PROVIDE A QUIETER RIDE.



G2-SERIES GALVANIZING OPTION

A high-quality galvanized finish supports long-lasting performance and appearance in even the most extreme climate conditions.

NOT AVAILABLE WITH STEEL TREADPLATE PLATFORMS. CALL FACTORY FOR ORDERING DETAILS.







FLATBED, STAKE, & VAN BODY

2500 & 3000 LBS CAPACITY

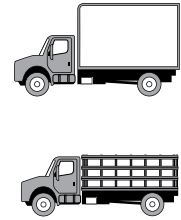

**TUCKUNDER
SERIES**

TKT MODELS

TKT models address all the concerns a liftgate operator faces. With self-leveling and power down functions, the lift is simple to use and reliable. The large platforms easily accommodate pallet-sized loads. And, the wide-arm, dual-cylinder design assures sturdy and consistent lifting action.



TKT Models are outfitted with numerous design features including hydraulic power-down and self-leveling actions for optimal control, a molded-plastic power unit cover that protects vital parts from outside elements, and a low-profile control with 5-minute inactivity shut-off to guard against unauthorized usage.



TKT-80-30 EA60

BED EXTENSIONS

All Tuckunder Series liftgates come with a separate bed extension. Both “standard” strength, 3/16-inch, steel construction bed extensions and “heavy duty” strength, 3/8-inch, versions are available.

All Tommy Gate Tuckunder Series bed extensions come with standard 24-inch, rubber dock bumpers and bolt-on adjustable steps.



SPECS

FLATBED, STAKE, & VAN — TUCKUNDER SERIES

AVAILABLE MODELS (DUAL-CYLINDER, POWER-DOWN, SELF-LEVELING)

TWO-YEAR STANDARD WARRANTY

| | Model Number | Load Area | Bed Heights ¹ | Gate Weight ² |
|--------------------------|-----------------------|-----------|--------------------------|--------------------------|
| 2500 lb. Capacity | Treadplate Platforms | | | |
| | TKT-80-25 TP50 | 80 x 50 | 40-54 | 887 |
| | TKT-80-25 TP60 | 80 x 60 | 45-54 | 980 |
| | Aluminum Platforms | | | |
| | TKT-80-25 EA50 | 80 x 50 | 40-54 | 816 |
| | TKT-80-25 EA60 | 80 x 60 | 45-54 | 866 |
| 3000 lb. Capacity | Treadplate Platforms | | | |
| | TKT-80-30 TP50 | 80 x 50 | 40-54 | 887 |
| | TKT-80-30 TP60 | 80 x 60 | 45-54 | 980 |
| | Aluminum Platforms | | | |
| | TKT-80-30 EA50 | 80 x 50 | 40-54 | 816 |
| | TKT-80-30 EA60 | 80 x 60 | 45-54 | 866 |

AVAILABLE BED EXTENSION OPTIONS

| Body Size | Extension Type | Extension Weight | Description |
|-----------|----------------|------------------|---|
| 96" | Standard | 276 | "standard" strength 3/16-inch thick steel construction |
| 96" | Heavy Duty | 334 | "heavy duty" strength 3/8-inch thick steel construction |
| 102" | Standard | 283 | "standard" strength 3/16-inch thick steel construction |
| 102" | Heavy Duty | 341 | "heavy duty" strength 3/8-inch thick steel construction |

TKT MODEL DIMENSIONS ³

1. Minimum bed heights (laden), Maximum bed heights (unladen).
2. Must add bed extension weight for total gate weight.
3. For detailed dimensions, visit www.tommygate.com

ABOVE VIEW

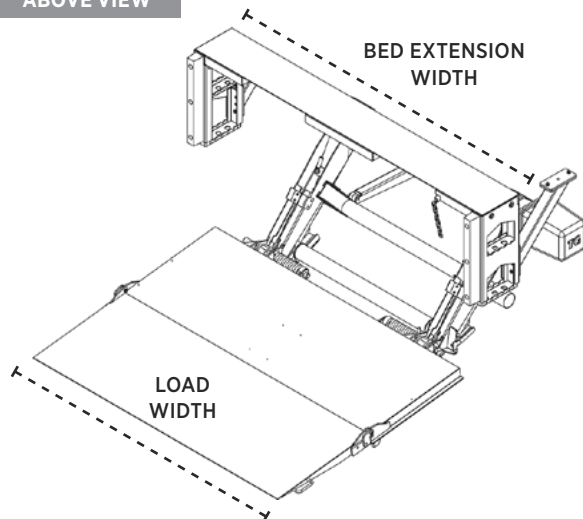



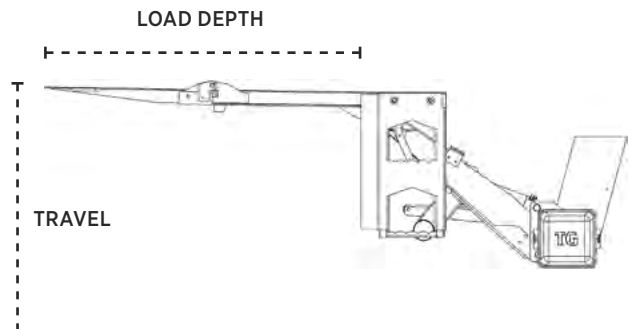



SIDE VIEW









FEATURES & OPTIONS

FLATBED, STAKE, & VAN — TUCKUNDER SERIES

STANDARD FEATURES

| | |
|---|---|
|  | Power Down |
|  | Underride Impact Guard |
|  | Low-profile, Fixed Toggle Control |
|  | Snubber Kit |
|  | Standard, 38 ft., Power Cable with Full-length Ground |
|  | 24-inch, Rubber Dock Bumpers |
|  | Bolt-on Adjustable Steps |

AVAILABLE OPTIONS

| | |
|--|---|
|  | Split Cart Stops ¹ |
|  | 2-Light, LED Light Kit |
|  | Dual Controls |
|  | Extended, 41 ft., Power Cable with Full-length Ground |
| <i>NO IMAGE</i> | 24-volt System |
|  | In-Line Power Shut-Off |
|  | License Plate Mount |

1. Extruded Aluminum platforms lose 10 inches of loading depth when cart stops are deployed.

Like all Tommy Gate hydraulic lifts, the main assembly of the Tuckunder Series is cut from raw steel, formed into precision parts, and hand-welded. TKT models are then **painted before assembly** to reduce exposure and corrosion. This entire process is completed on site at the Tommy Gate factory in Woodbine, Iowa.



PLATFORMS

FLATBED, STAKE, & VAN — TUCKUNDER SERIES

PLATFORM MATERIALS



Steel Treadplate



Extruded Aluminum

PLATFORMS

Both the extruded aluminum and treadplate steel platforms have clean, flat loading areas. Aluminum platforms also utilize a flat platform hinge for maximum convenience.



SPLIT CART STOPS

Aluminum platforms are available with foot-activated, dual cart stops. Platform loses 10 inches of loading depth when the cart stops are deployed.



EASY-TO-HANDLE PLATFORMS

All TKT Models are equipped with coiled torsion springs in both the main platform and “flipper” hinge points to make the folding and unfolding of Tuckunder Series platforms as easy as possible.

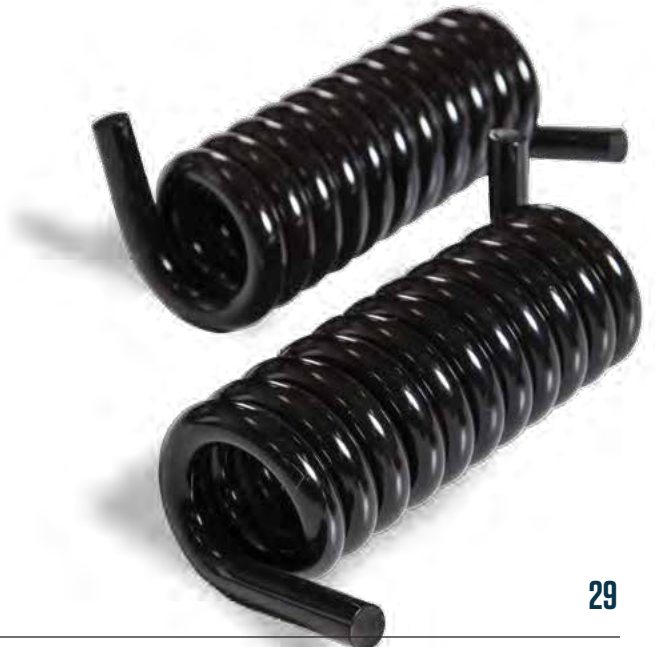



**RAILGATE SERIES
HIGH-CYCLE MODELS WITH BI-FOLD PLATFORMS**



BI-FOLD RAILGATE MODELS

The most versatile, dependable liftgates ever seen in a loading bay, Bi-Fold, High-Cycle models support large steel platforms and high lifting capacities while still remaining completely dock-compatible. The platform drop-down function allows work vehicles to load and unload in any manner at any location.

◀ 89-30 BF TP70

In the drop-away position, Bi-Fold Railgate platforms rest at bed height, allowing seamless dock compatibility.

The Low-Profile Control, a standard feature on all High-Cycle Railgates, includes an inactivity shut-off to guard against unauthorized use.



BI-FOLD RAILGATE FEATURES

- A SAFETY-TRIP BAR** disengages the lift when an object is detected between the rising platform and the liftgate mainframe
- B LOW-PROFILE CONTROL** reduced size simplifies operation
- C SELF-CLOSE ARM** cam-arm system opens/closes the platform automatically

SPECS

FLATBED, STAKE, & VAN — RAILGATE SERIES

BI-FOLD, HIGH-CYCLE MODELS FOR 96- & 102-INCH WIDE BODIES¹

TWO-YEAR STANDARD WARRANTY

| | Model Number | Body | Load Area | Taper ² | Bed Heights ³ | Gate Weight |
|--------------------------|----------------------|------|-----------|--------------------|--------------------------|-------------|
| 2500 lb. Capacity | Treadplate Platforms | | | | | |
| | 89-25 BF TP60 | 96 | 83 x 60 | 13 | 34 - 54 | 1320 |
| | 89-25 BF TP70 | 96 | 83 x 70 | 13 | 38 - 54 | 1378 |
| | 95-25 BF TP60 | 102 | 89 x 60 | 13 | 34 - 54 | 1362 |
| | 95-25 BF TP70 | 102 | 89 x 70 | 13 | 38 - 54 | 1420 |
| 3000 lb. Capacity | Treadplate Platforms | | | | | |
| | 89-30 BF TP60 | 96 | 83 x 60 | 13 | 34 - 54 | 1320 |
| | 89-30 BF TP70 | 96 | 83 x 70 | 13 | 38 - 54 | 1378 |
| | 95-30 BF TP60 | 102 | 89 x 60 | 13 | 34 - 54 | 1362 |
| | 95-30 BF TP70 | 102 | 89 x 70 | 13 | 38 - 54 | 1420 |

BI-FOLD, HIGH-CYCLE RAILGATE DIMENSIONS

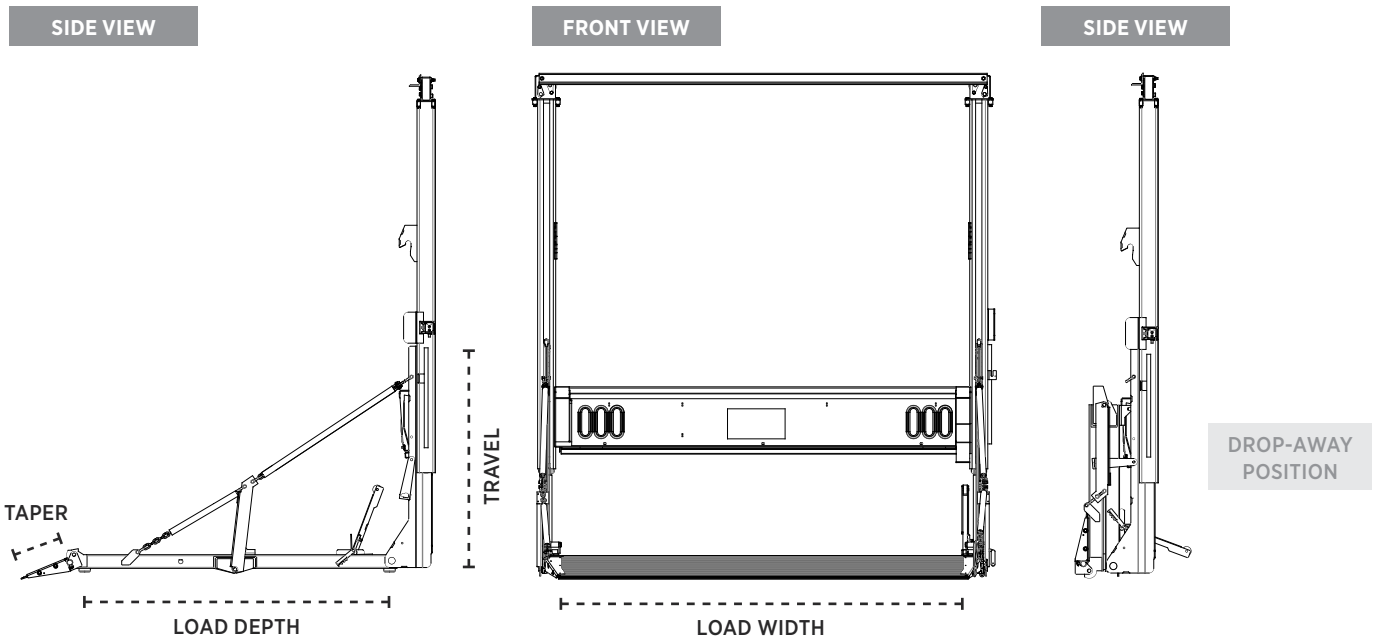

IMPORTANT

High-cycle railgate models are intended for use on medium-duty trucks only.

1. Bi-Fold, High-Cycle configurations for additional body widths may be available. Contact factory for details.
2. Standard, aluminum retention ramp serves as 13-inch, folding, platform taper on Bi-Fold Railgate models.
3. Minimum bed heights (laden), Maximum bed heights (unladen).

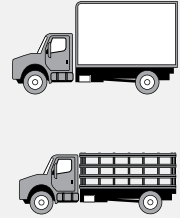

**RAILGATE SERIES
HIGH-CYCLE MODELS WITH FIXED PLATFORMS**

HIGH-CYCLE RAILGATE MODELS

High-cycle models apply a steel roller and leaf-chain pulley system to maximize smoothness of motion, endurance, and strength. This medium-duty railgate is ideal for high-cycle applications in any environment. These lifts are built with the highest quality components and place a priority on function and safety.

89-30 EA55 ▶

Shown with discontinued control box. High-cycle railgate models now come standard with low-profile control. See page 34.



High-cycle railgates come standard with safety trip bar, auto open and close, and recessed lights. Taper-integrated cart stops are optional on extruded-aluminum platform models.

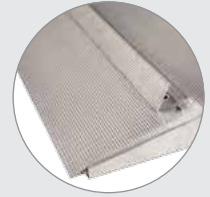

ROLLERS

Steel rollers guide the platform vertically within the rail track and are designed to withstand intensive cycling. Dual sealed, maintenance-free ball bearings ensure the rollers are long-lasting and perform consistently in all climate conditions.



SPECS

FLATBED, STAKE, & VAN — RAILGATE SERIES

FIXED-PLATFORM, HIGH-CYCLE MODELS FOR 96" WIDE BODIES

TWO-YEAR STANDARD WARRANTY

| | Model Number | Body | Load Area | Taper | Bed Heights | Gate Weight |
|-------------------|---------------------------------|------|-----------|-------|-------------|-------------|
| 2500 lb. Capacity | Treadplate Platforms | | | | | |
| | 89-25 TP36 | 96 | 89 x 36 | 12 | 32 - 54 | 1040 |
| | 89-25 TP42 | 96 | 89 x 42 | 12 | 32 - 54 | 1094 |
| | 89-25 TP48 | 96 | 89 x 48 | 12 | 32 - 54 | 1147 |
| | Aluminum Platforms ¹ | | | | | |
| | 89-25 EA55 | 96 | 89 x 55 | 12 | 32 - 54 | 968 |
| 3000 lb. Capacity | Treadplate Platforms | | | | | |
| | 89-30 TP36 | 96 | 89 x 36 | 12 | 32 - 54 | 1040 |
| | 89-30 TP42 | 96 | 89 x 42 | 12 | 32 - 54 | 1094 |
| | 89-30 TP48 | 96 | 89 x 48 | 12 | 32 - 54 | 1147 |
| | Aluminum Platforms ¹ | | | | | |
| | 89-30 EA55 | 96 | 89 x 55 | 12 | 32 - 54 | 968 |

ADDITIONAL BODY SIZES

| Body Size | Model | Load Width |
|-----------|-------|------------|
| 90" | 85 | 85 |
| 102" | 95 | 95 |

IMPORTANT

High-cycle railgate models are intended for use on medium-duty trucks only.



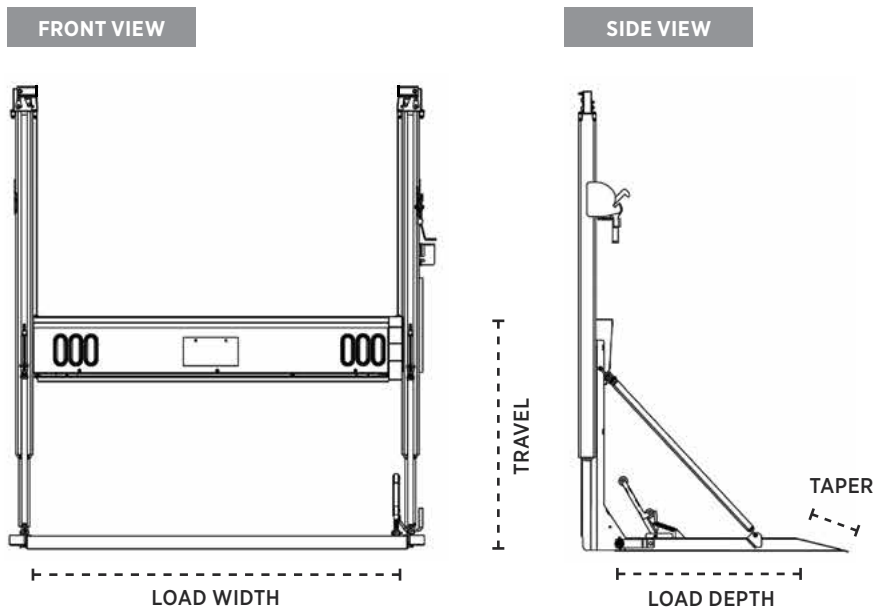

1. See additional aluminum platform depths on page 35.
2. For detailed dimensions, visit www.tommygate.com





HIGH-CYCLE RAILGATE DIMENSIONS ²

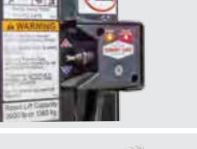
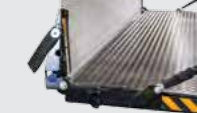

FEATURES & OPTIONS

HIGH-CYCLE RAILGATE MODELS

| STANDARD FEATURES | | BI-FOLD MODELS | FIXED PLATFORM MODELS |
|---|---------------------|----------------|-----------------------|
|  | Steel Rollers | ● | ● |
|  | Safety-trip Bar | ● | ● |
|  | Self-close System | ● | ● |
|  | Recessed Lights | ● | ● |
|  | Low-profile Control | ● | ● |
|  | 13" Retention Ramp | ● | - |

| AVAILABLE OPTIONS | | BI-FOLD MODELS | FIXED PLATFORM MODELS |
|--|----------------------------|----------------|-----------------------|
|  | Above Bed Travel | ● | ● |
|  | Recessed LED Lights | ● | ● |
|  | Dual Controls (w/ pendant) | ● | ● |
|  | Split Cart Stops | - | ● |
| NO IMAGE | In-cab Shut Off | ● | ● |

- Standard
- Optional
- Not Available

Tommy Gate's engineering and quality control programs uphold the highest standards at each stage of the assembly process: every new product undergoes strenuous cycle testing, every pump and motor is tested before it is sent into production, and all welding and assembly processes are checked, double checked, and must pass a final inspection according to strict quality assurance guidelines.



PLATFORMS

HIGH-CYCLE RAILGATE MODELS

PLATFORM MATERIALS

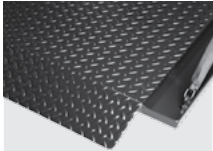
| | | BI-FOLD MODELS | FIXED PLATFORM MODELS |
|---|-------------------|----------------|-----------------------|
|  | Steel Treadplate | ● | ● |
|  | Extruded Aluminum | - | ● |

ALUMINUM PLATFORM DEPTHS

Extruded aluminum platforms (on fixed platform models) are available in any depth, 35" - 70", in 5" increments. Platforms are comprised of interlocking extrusions of 6061-T6 aircraft-quality aluminum.



RETENTION RAMP

Bi-Fold, High-Cycle models come standard with a 13" tapered, retention ramp.

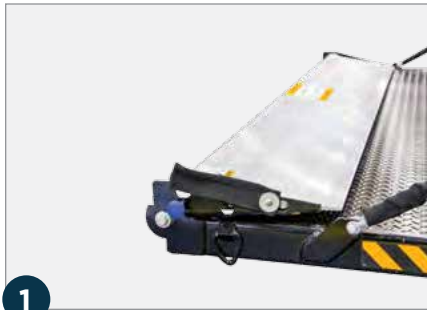

1 ramp closes for storage

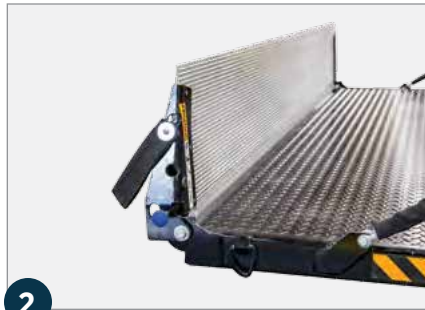

2 ramp locks at 90-degrees for cart retention

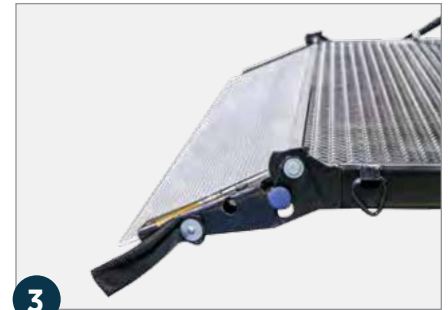

3 extended ramp hangs beyond platform level for smooth ground every time

SPLIT CART STOPS

All railgate models with Extruded Aluminum platforms are available with taper-integrated, foot-activated, dual cart stops.



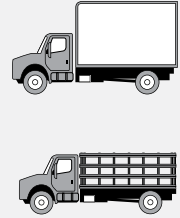

RAILGATE SERIES
STANDARD MODELS WITH DOCK-FRIENDLY PLATFORMS



DOCK-FRIENDLY RAILGATE MODELS

Dock-friendly models feature folding RF platforms able to achieve non-obstructing positions for forklift or dock loading. Also included are a closure-assist torsion bar and maintenance-free bushings, making them some of the best liftgates ever seen in a loading bay.

◀ 89-20 RF 45-12

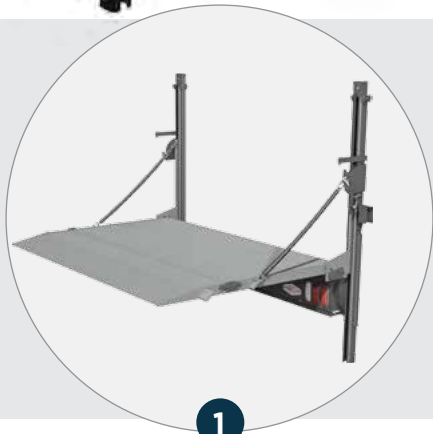

1



2



3

PLATFORM DESCRIPTIONS

- RF 45-6** Two-piece Extruded Aluminum w/ 45" loading depth (15" flipper) + 6" taper **(30" base height)**
- RF 45-12** Two-piece Extruded Aluminum w/ 45" loading depth (10" flipper) + 12" taper **(35" base height)**
- RF 50-6** Two-piece Extruded Aluminum w/ 50" loading depth (15" flipper) + 6" taper **(35" base height)**

Dock-friendly platforms fold and can be lowered in the vertical position to allow for easy dock or forklift loading.

SPECS

FLATBED, STAKE, & VAN — RAILGATE SERIES

DOCK-FRIENDLY, STEEL-FRAME MODELS FOR 96" WIDE BODIES

ONE-YEAR STANDARD WARRANTY

| | Model Number | Load Area | Taper | Travel | Gate Weight |
|--------------------------|----------------------------|-----------|-------|---------|-------------|
| 1600 lb. Capacity | Folding Aluminum Platforms | | | | |
| | 89-16 RF 45-6 | 89 x 45 | 6 | 32 - 54 | 674 |
| | 89-16 RF 45-12 | 89 x 45 | 12 | 32 - 54 | 688 |
| | 89-16 RF 50-6 | 89 x 50 | 6 | 32 - 54 | 695 |
| 2000 lb. Capacity | Folding Aluminum Platforms | | | | |
| | 89-20 RF 45-6 | 89 x 45 | 6 | 32 - 54 | 674 |
| | 89-20 RF 45-12 | 89 x 45 | 12 | 32 - 54 | 688 |
| | 89-20 RF 50-6 | 89 x 50 | 6 | 32 - 54 | 695 |

DOCK-FRIENDLY, ALUMINUM-FRAME MODELS FOR 96" WIDE BODIES¹

| | Model Number | Load Area | Taper | Travel | Gate Weight |
|--------------------------|----------------------------|-----------|-------|---------|-------------|
| 1600 lb. Capacity | Folding Aluminum Platforms | | | | |
| | A89-16 RF 45-6 | 89 x 45 | 6 | 32 - 54 | 550 |
| | A89-16 RF 45-12 | 89 x 45 | 12 | 32 - 54 | 564 |
| | A89-16 RF 50-6 | 89 x 50 | 6 | 32 - 54 | 571 |
| 2000 lb. Capacity | Folding Aluminum Platforms | | | | |
| | A89-20 RF 45-6 | 89 x 45 | 6 | 32 - 54 | 550 |
| | A89-20 RF 45-12 | 89 x 45 | 12 | 32 - 54 | 564 |
| | A89-20 RF 50-6 | 89 x 50 | 6 | 32 - 54 | 571 |

ADDITIONAL BODY SIZE

| Body Size | Model | Load Width |
|-----------|-------|------------|
| 90" | 85 | 85 |
| 102" | 95 | 95 |

- Aluminum frame railgates require mounting flanges which affect installation dimensions, visit www.tommygate.com for additional information.
- For detailed dimensions, visit www.tommygate.com

DOCK-FRIENDLY RAILGATE DIMENSIONS²

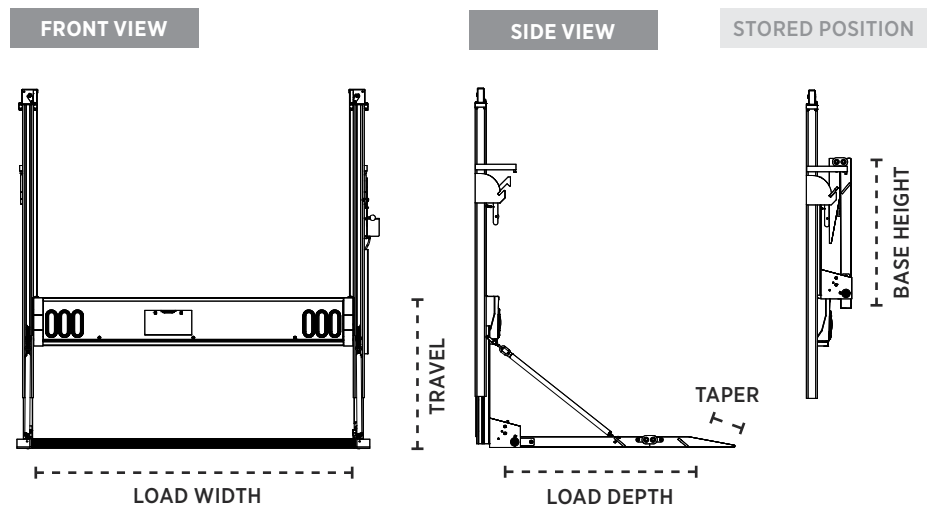

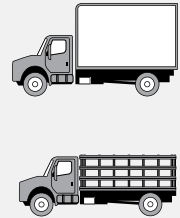

RAILGATE SERIES

STANDARD MODELS WITH FIXED PLATFORMS

STANDARD RAILGATE MODELS

The Tommy Gate Railgate Series consists of expertly-engineered lifts that allow for higher weight capacities and deeper platform loading areas. Standard model railgates employ a padded-slider system and are offered in both steel and aluminum frames.



1600 and 2000 lb. capacity railgates come standard with safety trip bar, auto close, and recessed lights.

(Optional LED light kit shown)



ABOVE-BED OPTIONAL CAPABILITY

On standard models, optional above-bed capability allows the platform to rise above the liftgate mainframe for dock loading.



ALL-ALUMINUM MODELS

A corrosion-resistant, lightweight, all-aluminum frame is available for most models.

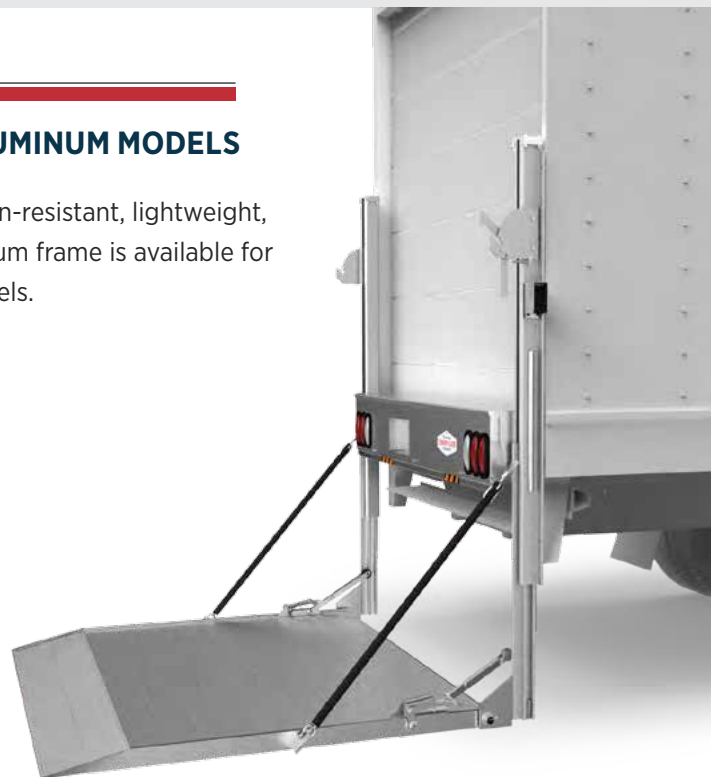

STANDARD, STEEL-FRAME MODELS FOR 96" WIDE BODIES

ONE-YEAR STANDARD WARRANTY

| | Model Number | Load Area | Taper | Travel | Gate Weight |
|-------------------|---------------------------------|-----------|-------|---------|-------------|
| 1600 lb. Capacity | Treadplate Platforms | | | | |
| | 89-16 TP37 | 89 x 37 | 6 | 32 - 54 | 810 |
| | 89-16 TP42 | 89 x 42 | 6 | 32 - 54 | 860 |
| | Aluminum Platforms ¹ | | | | |
| | 89-16 EA55 | 89 x 55 | 12 | 32 - 54 | 715 |
| 2000 lb. Capacity | Treadplate Platforms | | | | |
| | 89-20 TP37 | 89 x 37 | 6 | 32 - 54 | 810 |
| | 89-20 TP42 | 89 x 42 | 6 | 32 - 54 | 860 |
| | Aluminum Platforms ¹ | | | | |
| | 89-20 EA55 | 89 x 55 | 12 | 32 - 54 | 715 |
| | Gas Bottle Rack Platform | | | | |
| | 89-20 GBR | 89 x 30 | 12 | 32 - 54 | 805 |

STANDARD, ALUMINUM-FRAME MODELS FOR 96" WIDE BODIES ²

| | Model Number | Load Area | Taper | Travel | Gate Weight |
|-------------------|---------------------------------|-----------|-------|---------|-------------|
| 1600 lb. Capacity | Aluminum Platforms ¹ | | | | |
| | A89-16 EA55 | 89 x 55 | 12 | 32 - 54 | 600 |
| 2000 lb. Capacity | Aluminum Platforms ¹ | | | | |
| | A89-20 EA55 | 89 x 55 | 12 | 32 - 54 | 600 |

ADDITIONAL BODY SIZES





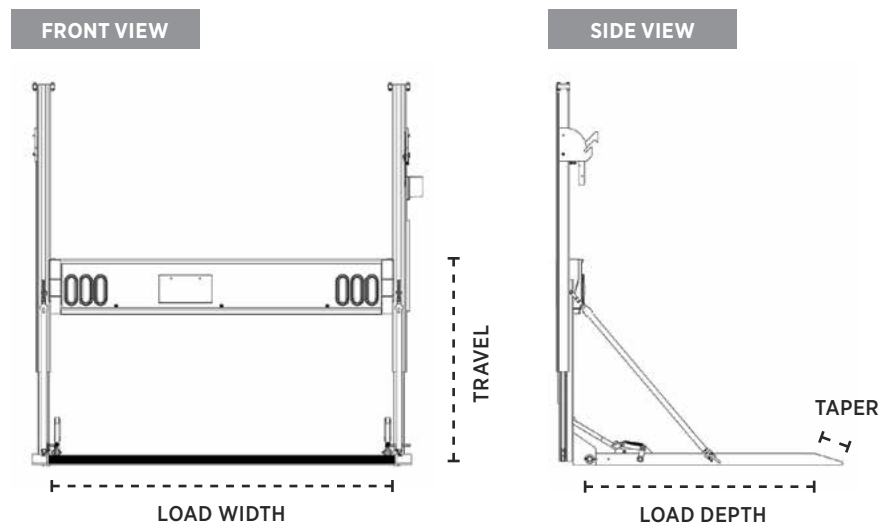

| Body Size | Model | Load Width |
|-----------|-------|------------|
| 80" | 73 | 73 |
| 85" | 79 | 79 |
| 90" | 85 | 85 |
| 102" | 95 | 95 |







- See additional aluminum platform depths on page 41.
- Aluminum frame railgates require mounting flanges which affect installation dimensions, visit www.tommygate.com for additional information.
- For detailed dimensions, visit www.tommygate.com

STANDARD RAILGATE DIMENSIONS ³

FEATURES & OPTIONS

STANDARD RAILGATE MODELS

| STANDARD FEATURES | | DOCK-FRIENDLY MODELS | FIXED PLATFORM MODELS |
|--|-------------------------------------|----------------------|-----------------------|
|  | Recessed Light Kit | ● | ● |
|  | Safety-trip Bar | ● | ● |
|  | Self-close System | - | ● |
|  | Aluminum Sliders | ● | ● |
|  | Power Cable with Full-length Ground | ● | ● |
|  | Circuit Breaker | ● | ● |
|  | Fixed and Timed Toggle Control | ● | ● |

| AVAILABLE OPTIONS | | DOCK-FRIENDLY MODELS | FIXED PLATFORM MODELS |
|--|-----------------------------|----------------------|-----------------------|
|  | Recessed LED Light Kit | ● | ● |
|  | Above-bed Travel | ● | ● |
|  | Dual Controls (w/ pendant) | ● | ● |
|  | Taper-integrated Cart Stops | ● | ● |
|  | Split Retention Ramps | - | ● |
|  | Rubber Platform Bumpers | ● | ● |

- Standard
- Optional
- Not Available

Every pump and motor that goes into any Tommy Gate hydraulic lift must pass an assembly floor test in addition to quality control inspections by the vendor.

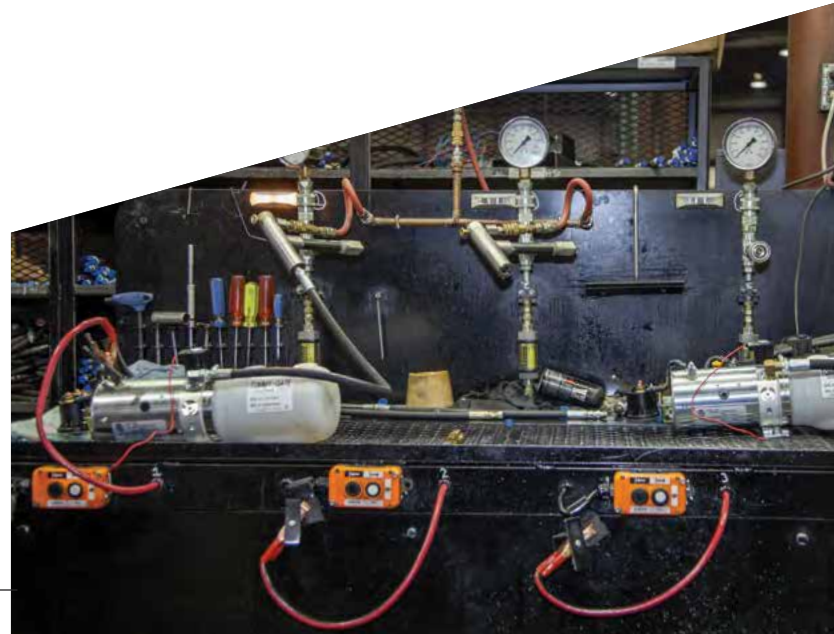

PLATFORMS

STANDARD RAILGATE MODELS

PLATFORM MATERIALS

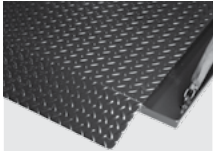
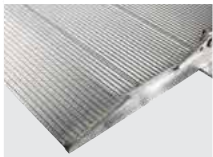
| | | DOCK-FRIENDLY MODELS | FIXED PLATFORM MODELS |
|---|-------------------|----------------------|-----------------------|
|  | Steel Treadplate | - | ● |
|  | Extruded Aluminum | ● | ● |

SPLIT CART STOPS

All railgate models with Extruded Aluminum platforms are available with taper-integrated, foot-activated, dual cart stops.



SPLIT RETENTION RAMPS

Steel-platforms (standard models 89 & 85 only) are available with add-on retention ramps.



ALUMINUM PLATFORM DEPTHS

Extruded aluminum platforms (on fixed platform models) are available in any depth, 35"-70", in 5" increments. Platforms are comprised of interlocking extrusions of 6061-T6 aircraft-quality aluminum.



GAS-BOTTLE RACK PLATFORM

GBR - 30" Loading Depth



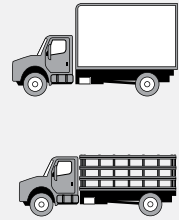

MORE THAN A PICKUP LIFT

The Tommy Gate G2 Series is a dual-cylinder, parallel-arm design which utilizes a pair of hydraulic cylinders to lower and raise the lift by applying direct power to both sides of the platform. Supporting larger platforms, G2 Series models are compatible with flatbed, stake and van bodies and offer a wide selection of platform materials to accommodate almost any industry application.

G2-92-1650 TP41 ▶

Shown with discontinued recessed light kit. Recessed lights have been replaced by a bolt-on kit

The G2 Series features only two grease points and the hard-chrome pins are virtually maintenance free.

Hydraulic cylinders are built in-house. Precision cylinder welds are executed by robotic machines, while assembly and testing are done by hand.

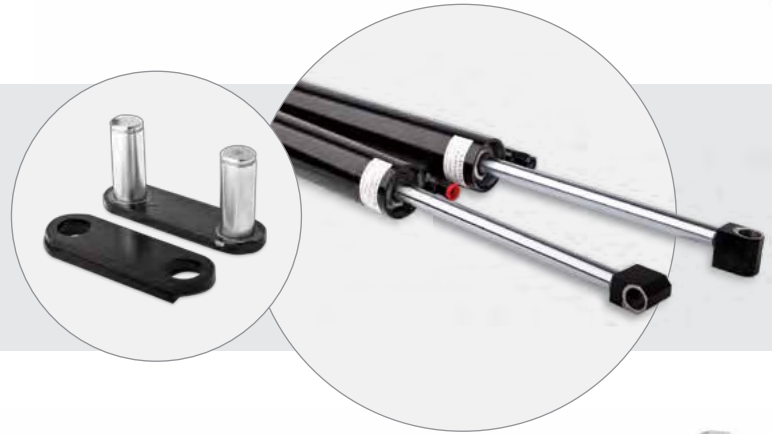

G2 SERIES LIFTGATE FEATURES

- Dual hydraulic cylinders
- Virtually maintenance-free components
- Recessed control
- Hitch compatibility
- Larger platforms
- Fully-enclosed hydraulic system located within the liftgate mainframe



SPECS

FLATBED, STAKE, & VAN — G2 SERIES

MODELS FOR 96" WIDE BODIES

TWO-YEAR STANDARD WARRANTY

| | Model Number | Load Area | Taper | Travel | Platform Fold | Gate Weight |
|---------------------------|-----------------------------------|-----------|-------|--------|---------------|-------------|
| 1300 lb. Capacity | <u>Treadplate Platforms</u> | | | | | |
| | G2-92-1350 TP35 | 87 x 35 | 6 | 50 | No | 628 |
| | G2-92-1350 TP41 | 87 x 41 | 6 | 50 | No | 655 |
| | <u>TommyTraction™ Platform</u> | | | | | |
| | G2-92-1350 TT33 | 87 x 33 | 6 | 50 | No | 612 |
| | <u>Aluminum Platforms</u> | | | | | |
| | G2-92-1350 EA37 | 85 x 37 | 6 | 50 | No | 561 |
| | G2-92-1350 EA41 | 85 x 41 | 6 | 50 | No | 577 |
| 1600 lb. Capacity | <u>Bar Grate Platform</u> | | | | | |
| | G2-92-1350 BG33 | 87 x 33 | 6 | 50 | No | 637 |
| | <u>Treadplate Platforms</u> | | | | | |
| | G2-92-1650 TP35 | 87 x 35 | 6 | 50 | No | 628 |
| | G2-92-1650 TP41 | 87 x 41 | 6 | 50 | No | 655 |
| | <u>TommyTraction™ Platform</u> | | | | | |
| | G2-92-1650 TT33 | 87 x 33 | 6 | 50 | No | 612 |
| | <u>Aluminum Platforms</u> | | | | | |
| G2-92-1650 EA37 | 85 x 37 | 6 | 50 | No | 561 | |
| G2-92-1650 EA41 | 85 x 41 | 6 | 50 | No | 577 | |
| LOW-PROFILE MODELS | <u>Bar Grate Platform</u> | | | | | |
| | G2-92-1650 BG33 | 87 x 33 | 6 | 50 | No | 637 |
| | G2-92-1642 TP38 NEW | 85 x 38 | 4 | 42 | YES | 609 |
| 1600 lb. Capacity | <u>Aluminum Platforms</u> | | | | | |
| | G2-92-1642 EA38 NEW | 85 x 38 | 6 | 42 | YES | 523 |

NEW Low-profile G2 models feature **folding platforms** and are specifically designed to increase driver visibility and greater compatibility with additionally installed equipment.

ADDITIONAL BODY SIZES

| Body Size | Model | Load Width |
|-----------|-------|------------|
| 90" | 87 | 80 |
| 85" | 81 | 75 |
| 80" | 73 | 66 |
| > 67" | 65 | 60 |

G2 SERIES DIMENSIONS ¹

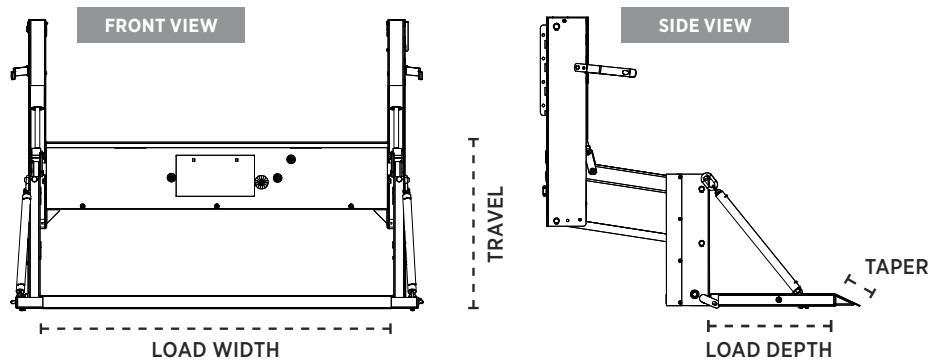

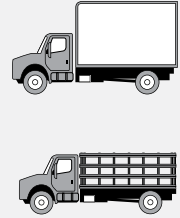

ORIGINAL SERIES

THE ORIGINAL TOMMY LIFT

The Original Series is a single-cylinder, parallel-arm design based on a cable and pulley system. This classic design is compatible with flatbed, stake and van bodies and offers a wide selection of platform materials to accommodate almost any industry application.

91-1650 TP42 ▶
Shown with optional light kit.



The Tommy Gate facility includes a 40,000-square-foot warehouse and shipping department. Specific models are always kept in stock and ready to ship the day they are ordered. The most popular models are also kept in stock at one or more of five Tommy Gate warehouses nationwide.



ORIGINAL SERIES FEATURES

- Durable, military aircraft quality lifting cables.
- Fully-enclosed hydraulic system safely encased w liftgate mainframe
- Pressure bypass prevents overloading
- Fold-down platform for dock or forklift loading
- Timed inactivity switch



SPECS

FLATBED, STAKE, & VAN — ORIGINAL SERIES

MODELS FOR 96" WIDE BODIES

ONE-YEAR STANDARD WARRANTY

| | Model Number | Load Area | Taper | Travel | Platform Fold | Gate Weight |
|--------------------------|--------------------------------|-----------|-------|--------|---------------|-------------|
| 1000 lb. Capacity | <u>Treadplate Platforms</u> | | | | | |
| | 91-1050 TP36 | 87 x 36 | 6 | 50 | No | 585 |
| | 91-1050 TP42 | 87 x 42 | 6 | 50 | No | 610 |
| | <u>TommyTraction™ Platform</u> | | | | | |
| | 91-1050 TT34 | 87 x 34 | 6 | 50 | No | 570 |
| | <u>Aluminum Platforms</u> | | | | | |
| | 91-1050 EA37 | 85 x 37 | 6 | 50 | No | 525 |
| | 91-1050 EA42 | 85 x 42 | 6 | 50 | No | 540 |
| 1300 lb. Capacity | <u>Treadplate Platforms</u> | | | | | |
| | 91-1350 TP36 | 87 x 36 | 6 | 50 | No | 585 |
| | 91-1350 TP42 | 87 x 42 | 6 | 50 | No | 610 |
| | <u>TommyTraction™ Platform</u> | | | | | |
| | 91-1350 TT34 | 87 x 34 | 6 | 50 | No | 570 |
| | <u>Aluminum Platforms</u> | | | | | |
| | 91-1350 EA37 | 85 x 37 | 6 | 50 | No | 525 |
| | 91-1350 EA42 | 85 x 42 | 6 | 50 | No | 540 |
| 1600 lb. Capacity | <u>Treadplate Platforms</u> | | | | | |
| | 91-1650 TP36 | 87 x 36 | 6 | 50 | No | 585 |
| | 91-1650 TP42 | 87 x 42 | 6 | 50 | No | 610 |
| | <u>TommyTraction™ Platform</u> | | | | | |
| | 91-1650 TT34 | 87 x 34 | 6 | 50 | No | 570 |
| | <u>Aluminum Platforms</u> | | | | | |
| | 91-1650 EA37 | 85 x 37 | 6 | 50 | No | 525 |
| | 91-1650 EA42 | 85 x 42 | 6 | 50 | No | 540 |
| 1600 lb. Capacity | <u>Bar Grate Platform</u> | | | | | |
| | 91-1050 BG34 | 87 x 34 | 6 | 50 | No | 585 |
| | <u>Bar Grate Platform</u> | | | | | |
| | 91-1350 BG34 | 87 x 34 | 6 | 50 | No | 585 |
| | <u>Bar Grate Platform</u> | | | | | |
| | 91-1650 BG34 | 87 x 34 | 6 | 50 | No | 585 |

ADDITIONAL BODY SIZES

| Body Size | Model | Load Width |
|-----------|-------|------------|
| 90" | 86 | 80 |
| 85" | 80 | 75 |
| 80" | 72 | 66 |

1. For detailed dimensions, visit www.tommygate.com

ORIGINAL SERIES DIMENSIONS ¹

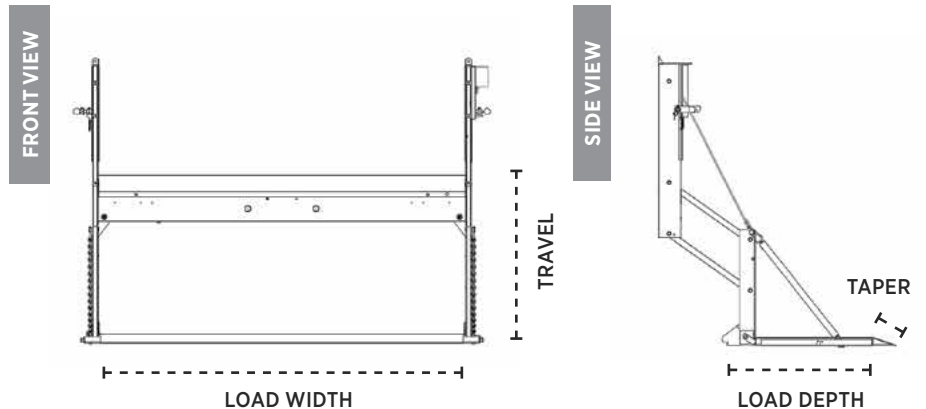



DUMP BODY

1600 LBS CAPACITY



LIFT-N-DUMP™



DUMP-THROUGH VERSATILITY

The Tommy Gate G2 Series is a dual-cylinder, parallel-arm design which utilizes a pair of hydraulic cylinders to lower and raise the lift by applying direct power to both sides of the platform. G2 Series Lift-N-Dump models include all the same features and functions of other G2 Series liftgates, but also offer a unique dump-through capability to be used with dump bodies.

◀ G2-92-1650 LD33



Dual hydraulic cylinders, like all G2 Series models.

Lift-N-Dump models feature pins to lock the platform in place when not in dump-through mode.

Platform latch activates the liftgate's dump-through position.

SPECS

DUMP BODY — G2 SERIES

MODELS FOR BODIES WITH 83" - 88" WIDE OPENINGS

TWO-YEAR STANDARD WARRANTY

| | Model Number | Load Area | Taper | Platform Fold | Travel | Gate Weight |
|-------------------|--|-----------|-------|---------------|--------|-------------|
| 1600 lb. Capacity | Treadplate Platform G2-92-1650 LD33 | 83 x 33 | 6 | No | 50 | 682 |

ADDITIONAL BODY SIZES

| Body Openings | Model | Load Width |
|---------------|-------|------------|
| 78" - 83" | 87 | 78 |
| 69" - 78" | 81 | 73 |
| 64" - 69" | 73 | 64 |

IMPORTANT

Use of a double-acting hoist is recommended. Using a single-acting hoist requires tie-down clamps.

Dimensions similar to Flatbed, Stake, & Van - G2 Series.









FEATURES & OPTIONS

FLATBED, STAKE, & VAN / DUMP BODY

STANDARD FEATURES









| | | | |
|---|-------------------------------------|----------------|----------------|
|  | Fixed and Timed Toggle Control | ● | ● |
|  | Recessed Control | ● | - |
|  | Power Cable with Full-length Ground | ● | ● |
|  | 150-amp Circuit Breaker | ● | ● |
|  | Maintenance-free Pins and Bushings | ● | - |
|  | Hitch Compatible | ● ¹ | ● ¹ |

- Standard
- Optional
- Not Available

1. Compatible with many hitches.
2. Not available for Lift-N-Dump models.
3. Lift-N-Dump models only available with dump-through steel treadplate platform.
4. Galvanized option not available with Steel Treadplate platforms or for Lift-N-Dump models. Call factory for ordering details.

AVAILABLE OPTIONS



| | | | |
|--|---|----------------|----------------|
|  | Remote Pendant Control | ● | ● |
|  | Dual Controls | ● | ● |
|  | Rubber Platform Bumpers | ● | ● |
|  | Bolt-on Light Kit (Incandescent or LED) | ● | - |
|  | Bolt-on Light Kit (incandescent or LED) | - | ● |
|  | Folding Tire Rack | ● ² | ● ² |
|  | Galvanized Frame and Platform | ● ⁴ | - |

PLATFORMS

FLATBED, STAKE, & VAN / DUMP BODY

PLATFORM MATERIALS



| | | | |
|--|-------------------|---|---|
| | Steel Treadplate | ● | ● |
| | Extruded Aluminum | ● | ● |
| | TommyTraction | ● | ● |
| | Steel Bargrate | ● | ● |

DROP-CHAIN COVERS

Platform drop-chain covers provide a quieter ride.



EXTRUDED ALUMINUM (G2 SERIES MODELS SHOWN)

EA37 - 37" Loading Depth



STEEL PLATFORMS (G2 SERIES MODELS SHOWN)

TP36 - 36" Loading Depth



BG34 - 34" Loading Depth



TT34 - 34" Loading Depth (SHOWN W/ OPTIONAL TIRE RACK)







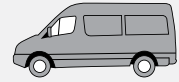

CANTILEVER SERIES



THE CANTILEVER SERIES

The Tommy Gate Cantilever Series is a modern hydraulic lift that is specifically designed to operate seamlessly with commercial vans.

The culmination of years of engineering, Cantilever Series models are highly versatile and include numerous desirable features. A bolt-on underside mount is compatible with most modern vans and eliminates the need for any welding. The platform is constructed from corrosion-resistant aluminum and folds laterally, allowing for access to the rear of the vehicle without operating the lift. Platforms support a large loadable area and come standard with dual cart stops.

The Cantilever Series features internal bridges, dual cart stops, remote pendant control, and maintenance-free components.



Easy to use and highly efficient, Cantilever Series models are aesthetically pleasing as well as logistically practical.

LEFT: the larger platform (EF71) features 60 inches of loading depth and is recommended for higher-roof vans only.

RIGHT: the smaller platform (EF52) features 40 inches of loading depth and is ideal for low-roof vans



SPECS

CARGO VAN — CANTILEVER SERIES

AVAILABLE MODELS ¹

TWO-YEAR STANDARD WARRANTY

| Model Number | | Load Area | Depth | Travel | Gate Wt. |
|---|---|-----------|-------|--------|----------|
| 1300 lb. Lifting Capacity | MB SPRINTER [®] 2007-2016 2500 All Styles / 3500 170" WB & 170" WB Ext. ² | | | | |
| | CVL-AA-1330 EF71 | 53 x 60 | 71 | 30 | 610 |
| | CVL-AA-1330 EF52 | 53 x 40 | 52 | 30 | 570 |
| | MB SPRINTER [®] 2007-2016 3500 144" WB. ² | | | | |
| | CVL-AB-1330 EF71 | 53 x 60 | 71 | 30 | 610 |
| | CVL-AB-1330 EF52 | 53 x 40 | 52 | 30 | 570 |
| | Nissan NV [®] 2011-2016 | | | | |
| | CVL-AC-1330 EF71 | 53 x 60 | 71 | 30 | 610 |
| | CVL-AC-1330 EF52 | 53 x 40 | 52 | 30 | 570 |
| | Chevrolet / GMC EXPRESS [®] /SAVANA [®] 2011-2016 | | | | |
| | CVL-AD-1330 EF52 | 53 x 40 | 52 | 30 | 570 |
| | Ram Promaster [®] 2014-2016 1500/2500/3500, 118", 136", & 159"WB | | | | |
| | CVL-AE-1330 EF71 | 53 x 60 | 71 | 30 | 610 |
| | CVL-AE-1330 EF52 | 53 x 40 | 52 | 30 | 570 |
| | Ram Promaster [®] 2014-2016 3500, 159"WB Extended Body (ONLY) | | | | |
| | CVL-AH-1330 EF71 | 53 x 60 | 71 | 30 | 610 |
| | CVL-AH-1330 EF52 | 53 x 40 | 52 | 30 | 570 |
| | Ford Transit [®] 2015-2016 150/250/350, 130", & 148"WB ³ | | | | |
| | CVL-AF-1330 EF71 | 53 x 60 | 71 | 30 | 610 |
| | CVL-AF-1330 EF52 | 53 x 40 | 52 | 30 | 570 |
| Ford Transit [®] 2015-2016 350, 148"WB Extended Body (ONLY) ³ | | | | | |
| CVL-AG-1330 EF71 | 53 x 60 | 71 | 30 | 610 | |
| CVL-AG-1330 EF52 | 53 x 40 | 52 | 30 | 570 | |

1. Installation may affect specific vehicle features such as rear sensors and back-up cameras. Installation also requires the spare tire to be relocated and is not compatible with any form of towing hitch.
2. Mercedes-Benz requires the use of an auxillary battery for all liftgates installed on SPRINTER[®] vans.
3. Ford Transit[®] "medium-height" models are compatible with EF71 platform. Some Ford Transit[®] installations may require a separate connection point kit to be ordered from Ford. See Install Instructions or contact customer service.

CANTILEVER SERIES DIMENSIONS

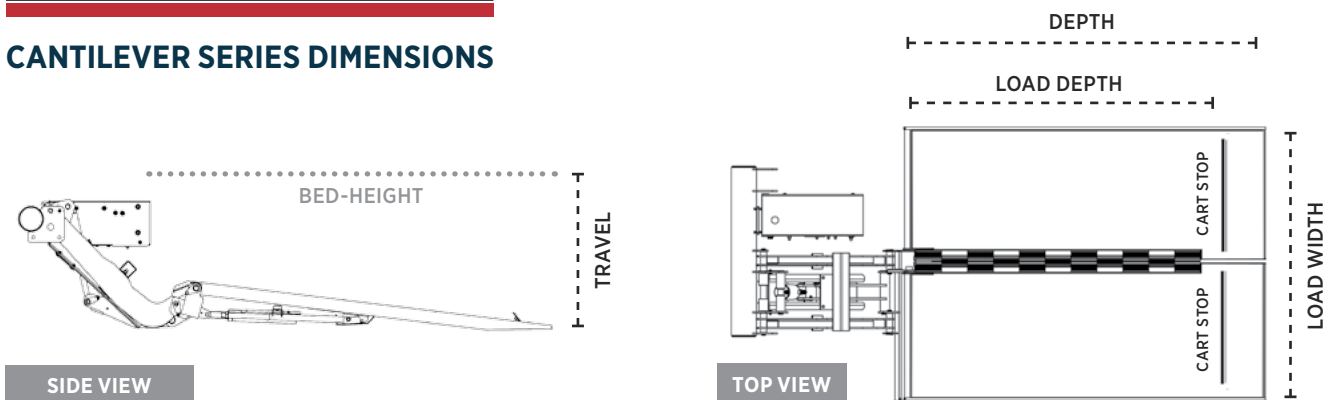

CARGO VAN

↑ **650 LBS CAPACITY**

650 SERIES

THE INTERNAL VAN LIFT

Low-capacity, compact, and internally-mounted, the 650 Series is the ideal liftgate for lightweight van applications. 650 Series models fold up and store out of the way of ordinary tasks or flat against the inside of the rear door.

Fold-away interior mount offers two secure storage positions and easy access to the rear of the van.



AVAILABLE MODELS

ONE-YEAR STANDARD WARRANTY

| | Model Number | Load Area | Taper | Travel | Applications ¹ | Gate Weight |
|-------------------------|-------------------------------------|-----------|-------|--------|---------------------------|-------------|
| 650 lb. Capacity | Smooth Steel Platform 650 | 30 x 39 | 4 | 31.5 | A, B, C | 345 |

STANDARD FEATURES

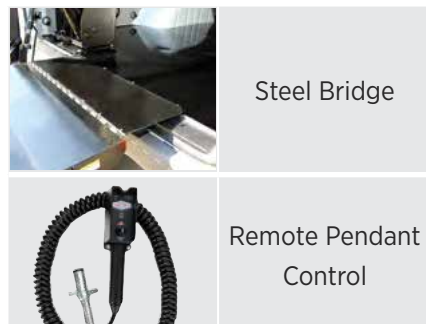

650 SERIES DIMENSIONS

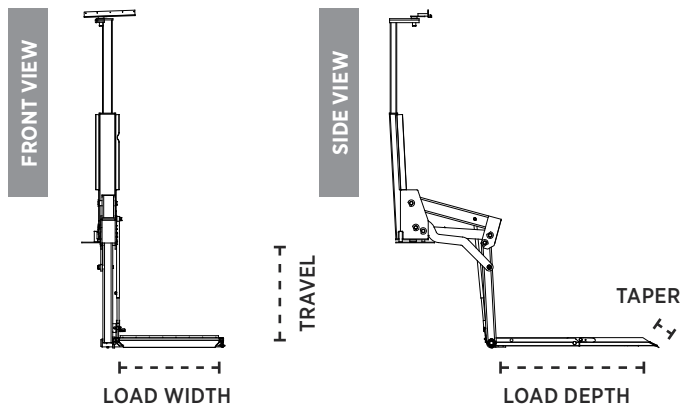

1. See applications on opposite page.
2. For detailed dimensions, visit www.tommygate.com

APPLICATIONS & BRACKETS

FULL-SIZE PICKUP LIFTGATES

| Code | Manufacturer | Model Year | Body Style | Bracket, Painted | Bracket, Galvanized |
|------|-----------------|------------|---------------------------------------|------------------|---------------------|
| A | Chevrolet / GMC | 2007-2016 | 1500 | T-170 | G-170 |
| B | Chevrolet / GMC | 2007-2016 | 2500 | T-170 | G-170 |
| B | Chevrolet / GMC | 2007-2016 | 3500 | T-170 | G-170 |
| A | Chevrolet / GMC | 2007 | 1500 Classic | T-160 | G-160 |
| B | Chevrolet / GMC | 2007 | 2500 Classic | T-160 | G-160 |
| B | Chevrolet / GMC | 2007 | 3500 Classic | T-160 | G-160 |
| A | Chevrolet / GMC | 2002-2006 | 1500 | T-160 | G-160 |
| B | Chevrolet / GMC | 2002-2006 | 2500 | T-160 | G-160 |
| B | Chevrolet / GMC | 2002-2006 | 3500 | T-160 | G-160 |
| A | Dodge / Ram | 2002-2016 | 1500 | T-330 | G-330 |
| B | Dodge / Ram | 2003-2016 | 2500 | T-330 | G-330 |
| B | Dodge / Ram | 2003-2016 | 3500 (does not include 2013-2014 DRW) | T-330 | G-330 |
| B | Dodge / Ram | 2013-2016 | 3500 (Dual Rear Wheel models only) | T-340 | G-340 |
| A | Ford | 2002-2016 | F-150 ² | T-250 | G-250 |
| B | Ford | 2002-2016 | F-250 | T-260 | G-260 |
| B | Ford | 2002-2016 | F-350 | T-260 | G-260 |
| A | Nissan | 2004-2016 | TITAN ^{® 3} | T-420 | G-420 |
| A | Toyota | 2007-2016 | TUNDRA [®] | T-500 | G-500 |

CARGO VAN - 650 SERIES LIFTGATES

| Code | Manufacturer | Model Year | Body Style | Bracket |
|------|-----------------|-------------|------------------------------|---------|
| C | Dodge / Ram | 2014 - 2016 | Promaster (High-roof) | 13498 |
| C | Dodge / Ram | 2014 - 2016 | Promaster (Standard Roof) | 13080 |
| C | Dodge / Ram | 2015 - 2016 | Promaster City | 14502 |
| A | Dodge / Ram | 2002 - 2003 | B-Series - Standard Body | 2417 |
| A | Dodge / Ram | 2002 - 2003 | B-Series - Extended Body | 2417 |
| A | Ford | 2002 - 2014 | E-Series | 2408 |
| C | Ford | 2010 - 2013 | TRANSIT CONNECT | 10179 |
| C | Ford | 2014 - 2016 | TRANSIT CONNECT ³ | 13694 |
| C | Ford | 2015 - 2016 | TRANSIT (high-roof) | 13914 |
| C | Ford | 2015 - 2016 | TRANSIT (medium roof) | 14012 |
| C | Ford | 2015 - 2016 | TRANSIT (low-roof) | 13821 |
| B | SPRINTER | 2002 - 2006 | Standard Roof | 2397 |
| B | SPRINTER | 2002 - 2006 | High Roof | 2398 |
| D | SPRINTER | 2007 - 2016 | Standard Roof | 2632 |
| D | SPRINTER | 2007 - 2016 | High Roof | 2633 |
| C | Nissan | 2013 - 2016 | NV200 | 13319 |
| E | Chevrolet / GMC | 2002 - 2005 | ASTRO / SAFARI | 2400 |
| E | Chevrolet / GMC | 2002 - 2016 | EXPRESS / SAVANA | 2410 |
| E | Chevrolet / GMC | 2015 - 2016 | City Express | 13319 |

COMPACT PICKUP LIFTGATES

Tommy Gate Original Series liftgates fit many compact pickup trucks, not shown above. Visit www.tommygate.com to learn more about model "MINI" liftgates.

1. Last 14 model years shown. For additional applications, visit www.tommygate.com
2. 2002-2003 SUPERCREW[®] requires special Model 48 and T-105 bracket. Not compatible with G2 Series.
3. Requires special liftgate. Specify when ordering.
4. 650 can not store against inside wheel well on this application.

TOMMY GATE





TOMMY GATE: YESTERDAY AND TODAY

Woodbine Manufacturing Company was founded in 1965, in Woodbine, Iowa by Delbert “Bus” Brown. Working alone, Bus designed and constructed the original Tommy Lift, which he named after his son.

Early stories often recount Bus loading his pickup trailer with up to five liftgates at a time and driving off into the neighboring counties (where he would sell and install them himself), only to return once that trailer was empty.

This was Woodbine Manufacturing Company in its earliest days: a grassroots liftgate manufacturer that was created to ease the work of the local farmers.

Today, the Woodbine factory stands at over 200,000 square feet on the same piece of ground where every Tommy Gate liftgate has been manufactured and assembled for over 50 years. It is a state-of-the-art manufacturing plant that embraces a combination of modern technology fused with old-fashioned, hands-on welding and tooling.

Very much alive and well in the twenty-first century, Tommy Gate liftgates are sold by over 1000 distributors in every corner of the world.

Woodbine Manufacturing Company is one-hundred percent family-owned and operated, and has been since its inception. The company takes great pride in the work ethic, history, and traditions of its employees and strives to continue providing jobs and opportunities to the community it calls home.

It is a testament to the spirit of American manufacturing that Tommy Gate began with a single man, in a small, brick machine shop in rural Iowa.

IMPORTANT NOTES

- Trademarks are property of their respective owners.
- Installation may affect specific vehicle features such as rear sensors, back-up cameras, and trailer hitches.
- All measurements in inches and pounds, unless otherwise specified.
- “Gate Weight” equals the approximate installed liftgate weight.
- “Load Area” is the liftgate platform’s flat, loadable area and is given as width x depth.
- Detailed liftgate dimensions are available at www.tommygate.com.

LEGAL

SPECIFICATION CHANGES Woodbine Manufacturing Company, Inc. reserves the right to make changes in manufacturing to comply with current or new engineering specification changes where applicable.

INSTALLATION COMPLIANCE & PROCEDURES Before installing any liftgate, please observe the Vehicle Loading Limitations. These loading limitations are outlined in the Vehicle Owner’s Manual and the Safety Compliance Certification Label located on the driver’s door pillar.

Liftgate installers are to treat vehicles as incomplete and are therefore responsible for vehicle compliance with all local, state, and federal regulations, including but not limited to all lighting Regulations (see FMVSS 108) and all rearview visibility requirements (see FMVSS 111). Installers must also follow the procedures and specifications as detailed in Tommy Gate installation instructions, including ensuring the proper placement of all warning decals.

In view of the responsibility of altered-stage vehicle manufacturers to comply with FMVSS 111, Tommy Gate offers its “Camera and Sensor Bar” as a possible solution. However, it is the sole responsibility of the upfitter/final stage manufacturer to determine if the Tommy Gate Camera and Sensor Bar meets FMVSS 111 and/or any other applicable vehicle certification - and it is not the responsibility of Tommy Gate/Woodbine. Any information made available by Tommy Gate regarding its Camera and Sensor Bar is not intended to be, and shall not be, relied upon as a final determination of compliance with FMVSS 111 and/or any other vehicle certification. Each distributor must, on its own, make each such required determination for each vehicle it offers to a customer.

WARNING Tommy Gate liftgates are industrial products FOR MATERIAL HANDLING ONLY and are not to be used as a personnel or wheelchair lift. For safe handling and operating instructions, visit www.tommygate.com

TOMMY GATE LIFTGATE STANDARD WARRANTY Tommy Gate G2 Series, Tuckunder Series, High-Cycle Railgates Series, and Cantilever Series liftgates have a two (2) year limited warranty from the date of user purchase against faulty material and workmanship. Tommy Gate Original Series, 650 Series, and standard Railgate Series liftgates have a one (1) year limited warranty from date of purchase. Pump and motor units have a two (2) year limited warranty. Normal usage requirements apply. All affected parts must be returned to the factory prepaid, with full credit issued for those found to be defective. Warranty replacement parts will be shipped from the factory prepaid. THERE ARE NO WARRANTIES, EXPRESS OR IMPLIED, INCLUDING THE WARRANTY OF MERCHANTABILITY OR A WARRANTY OF FITNESS FOR A PARTICULAR PURPOSE, EXTENDING BEYOND THAT SET FOR THE ABOVE.

WARRANTY LIMITATIONS, LIMITATIONS ON WOODBINE’S LIABILITY AND INDEMNIFICATION The modification of any Tommy Gate product in any manner not approved by Woodbine Manufacturing Company, Inc. immediately voids all warranties. Woodbine Manufacturing Company, Inc. shall not be held responsible for any damage resulting from the use of a modified Tommy Gate product, or one that was not properly maintained. The maximum liability of Woodbine Manufacturing Company, Inc. resulting from anything it did or did not do with respect to a Tommy Gate product shall be the price paid for that Tommy Gate product. Woodbine Manufacturing Company, Inc. will not be responsible for any loss of profits, goodwill, business opportunity or consequential damages. Recipients accepting shipments of any Tommy Gate product agree to indemnify, defend, protect, and hold Woodbine Manufacturing Company, Inc. harmless from and against any and all losses, damages claims or expenses of whatever form or nature, including attorneys’ fees and other costs of defense that Woodbine Manufacturing Company, Inc. may incur in connection with any acts or omissions related to the use or misuse of a Tommy Gate product and/or the unauthorized modification of a Tommy Gate Product.

TOMMY GATE®



WOODBINE MANUFACTURING COMPANY, INC.

83 Bus Brown Drive
Woodbine, Iowa 51579
www.tommygate.com

TOLL FREE (800) LIFTGATE
MAIN (712) 847-8000
FAX (712) 647-2417