



**TEREX®**

**RT 100US**

100 US capacity class

Rough terrain crane

Datasheet

imperial



























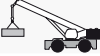



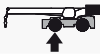

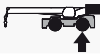



















# RT 100US

**DTI**  
DEMAG TECH INSIDE

**WORKS FOR YOU.™**

	Page:
<b>Key</b> .....	3
<b>Highlights</b> .....	4
<b>Weights</b> .....	5
<b>Dimensions</b> .....	6-7
<b>Steering Radii</b> .....	8-9
<b>Range Diagram</b>	
Main Boom .....	10
Jib .....	14
<b>Load Chart</b>	
Main Boom .....	11-13
Jib .....	15
On Tires .....	16-17
<b>Technical Specifications</b>	
Hydraulic Boom .....	18
Hoist .....	18
Cab and Controls .....	19
Carrier .....	19
Vehicle Performance .....	19
Tires .....	19
Options .....	20
<b>Notes to lifting capacity</b> .....	20









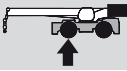
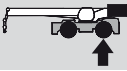
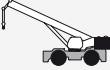
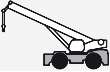

	Counterweight		Performance
	Main boom		Tip height
	Boom length		Boom elevation angle
	Boom extension		Working radius
	Angular offsets		Auxiliary head
	Telescoping		Minimum distance between hook block and boom head
	Outriggers / Lifting on outriggers		Crane / Crane in standard configuration
	Slewing brake		Removable counterweight system
	Slewing / Allowable range		Lifting on wheels / Pick & Carry
	Slewing locked		Gross vehicle weight
	Slewing gears		Weight on front axle
	Hoist speed		Weight on rear axle
	Rope		Hook block
	Rope diameter		Electric circuit
	Rope length		Operation temperature
	Line pull		Speed
	Main hoist		Engine
	Auxiliary hoist		Mechanical transmission
	Lights		Cab
	Gradeability		Operator aid
	Heating / Air conditioning		Rated weight on hook block
	Hydraulics		No. of sheaves
	Steering		Single hook
	Tires		Rams-horn hook
	Controls		No. of lines
	Lubrication system		Differential lock

- ▶ **Rated capacity:**  
100 USt at 8 ft working radius
- ▶ **Maximum main boom length:**  
154.2 ft
- ▶ **Maximum tip height with jib:**  
216.5 ft
- ▶ **Maximum hook height with jib:**  
209.9 ft



# WEIGHTS

# RT 100US

			
 Without hook block Tires 26.5R25	115,919 lb	57,421 lb	58,498 lb
 Without counterweight	93,873 lb	63,368 lb	30,505 lb
<b>Add / Subtract for main optional equipment</b>			
 Removable counterweight system	+ 331 lb	- 89 lb	+ 420 lb
 29.5-25	+ 1,146 lb	+ 573 lb	+ 573 lb
 55.8 ft Jib stowed	+ 3,086 lb	+ 5,959 lb	- 2,872 lb
 Auxiliary sheave	+ 176 lb	+ 503 lb	- 327 lb
 2 Auxiliary winch	+ 2,425 lb	- 451 lb	+ 2,876 lb
 6 100 USt hook block, 6 sheaves	+ 2,094 lb	+ 3,945 lb	- 1,851 lb
 3 55 USt hook block, 3 sheaves	+ 1,102 lb	+ 2,076 lb	- 974 lb
 1 22 USt hook block, 1 sheave	+ 661 lb	+ 1,246 lb	- 584 lb
 11 USt headache ball	+ 397 lb	+ 748 lb	- 351 lb

NOTE: Values are subject to 2% variation

# DIMENSIONS

# RT 100US

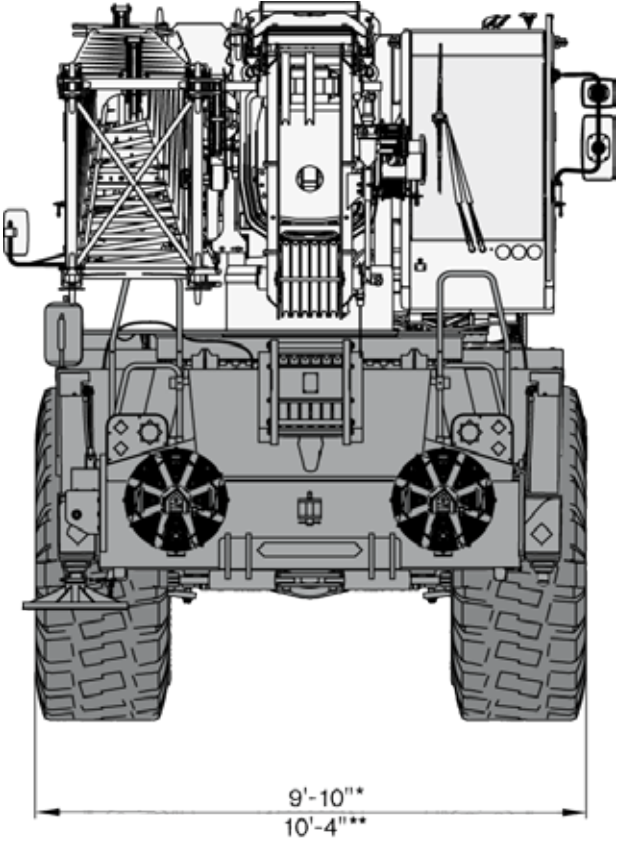

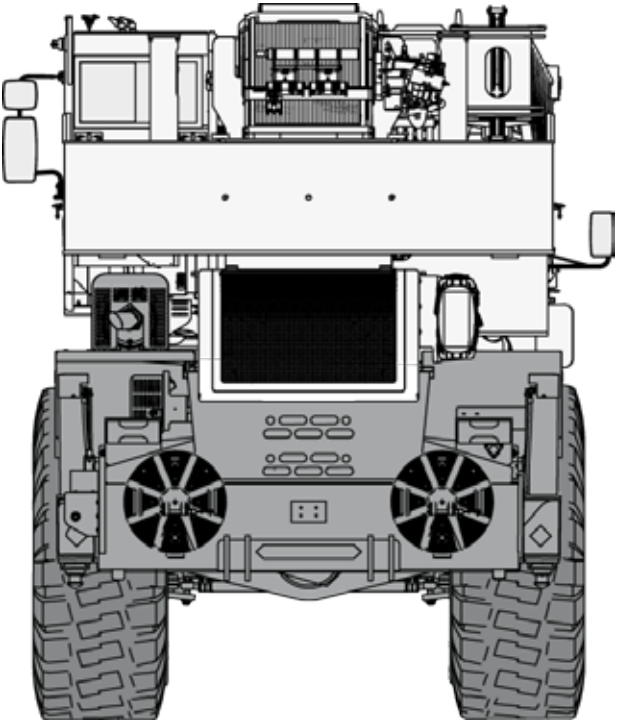

⊙ \* 26.5R25  
\*\* 29.5-25

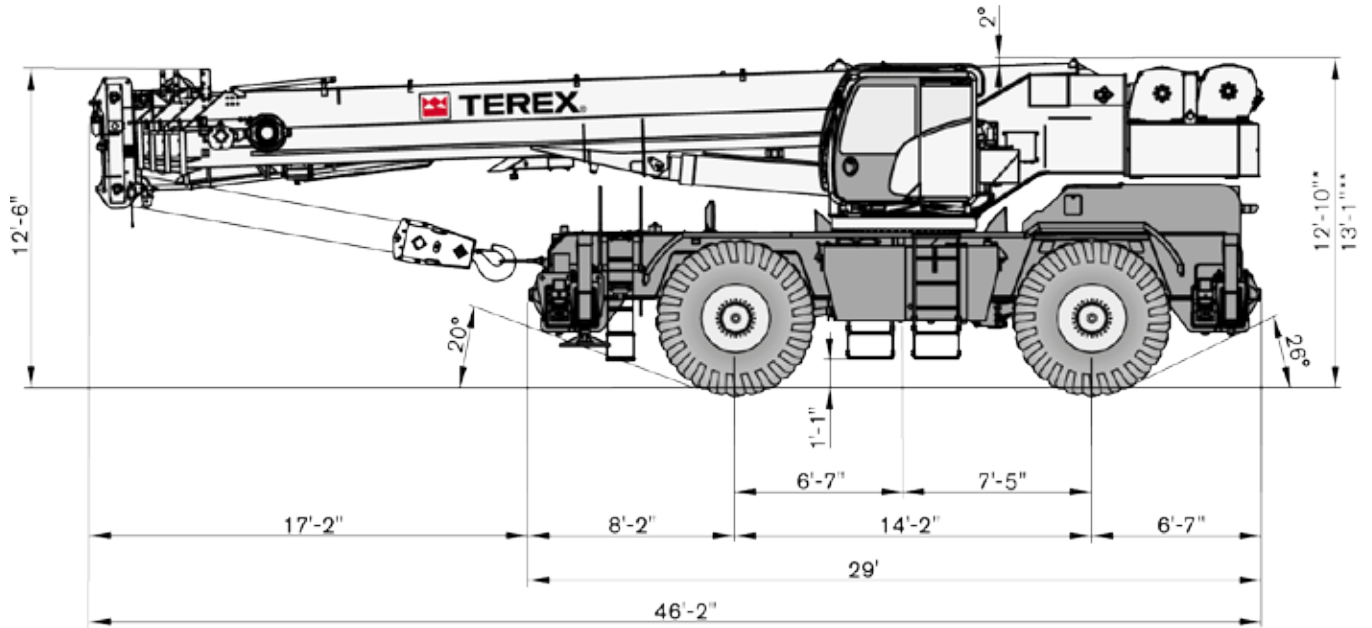

# DIMENSIONS

# RT 100US



 \* 26.5R25  
 \*\* 29.5-25

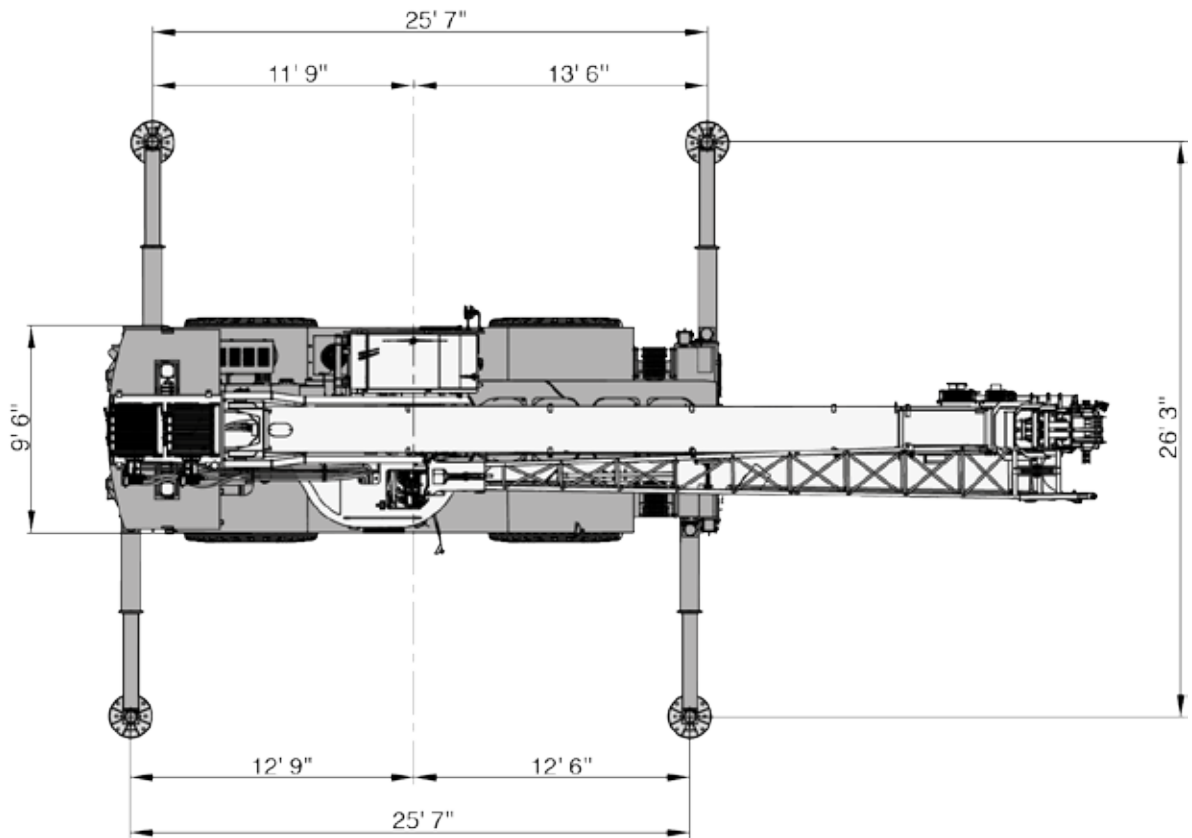

Drawings show optional rooster sheave

# STEERING RADII

**RT 100US**

with 26.5R25 tires

Two wheel steer

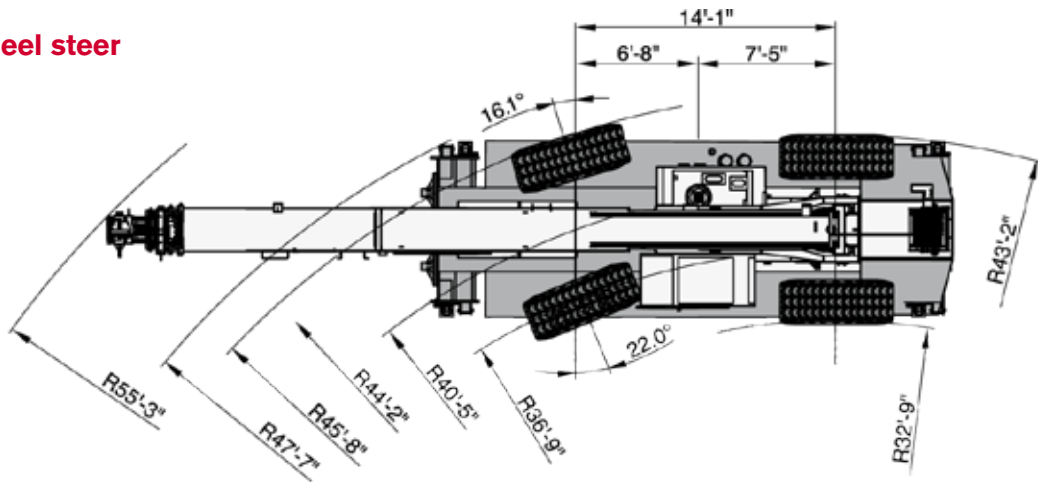

Four wheel steer

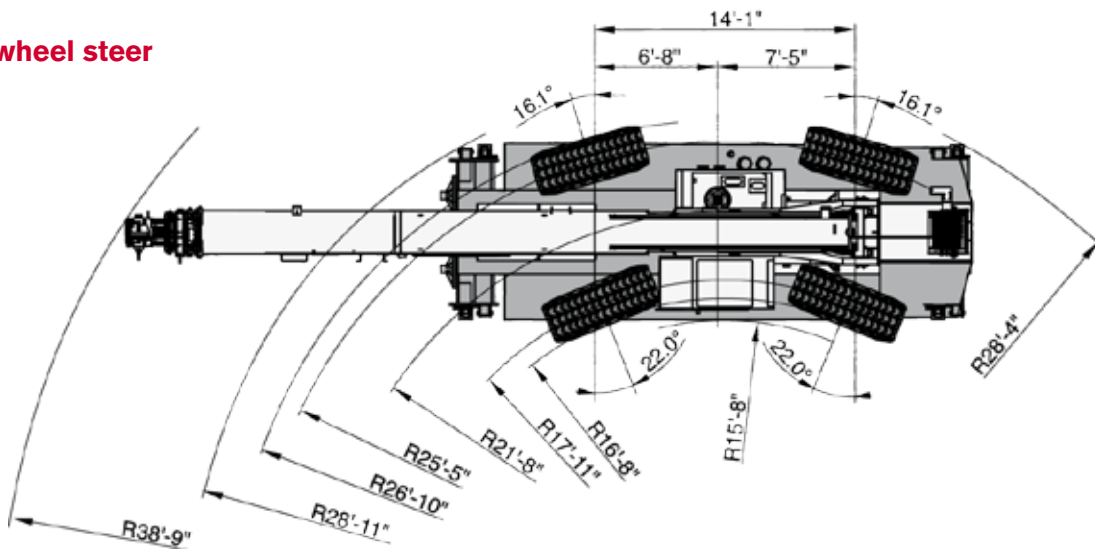

Rear

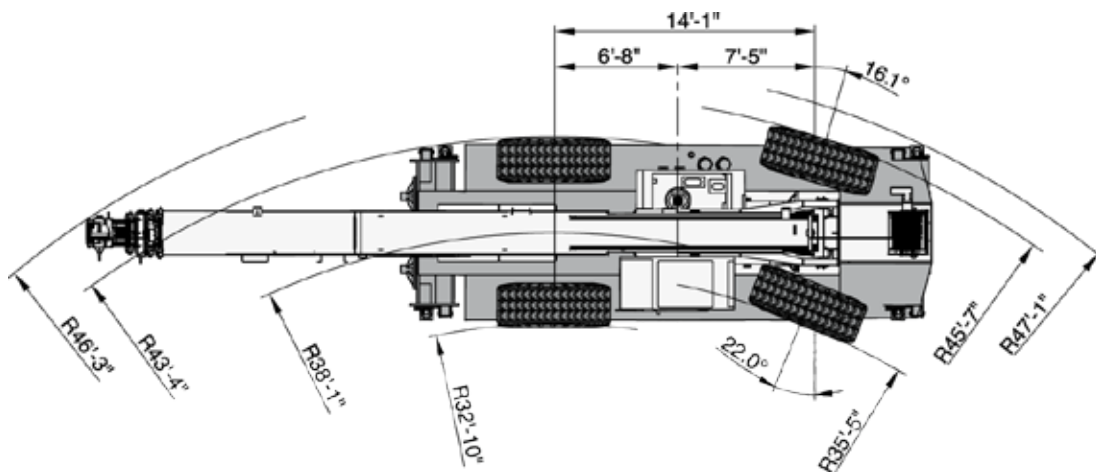



# STEERING RADII

RT 100US

with 29.5-25 tires

Two wheel steer

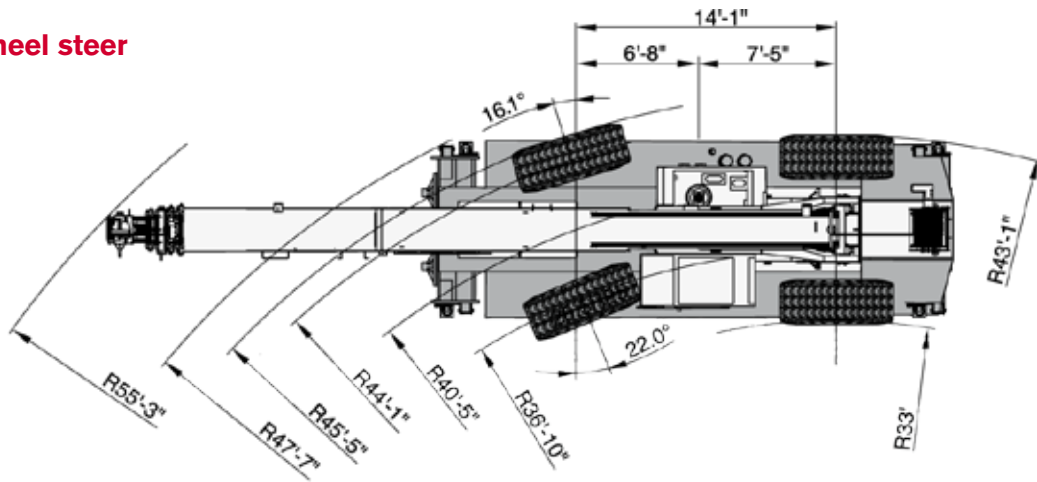

Four wheel steer

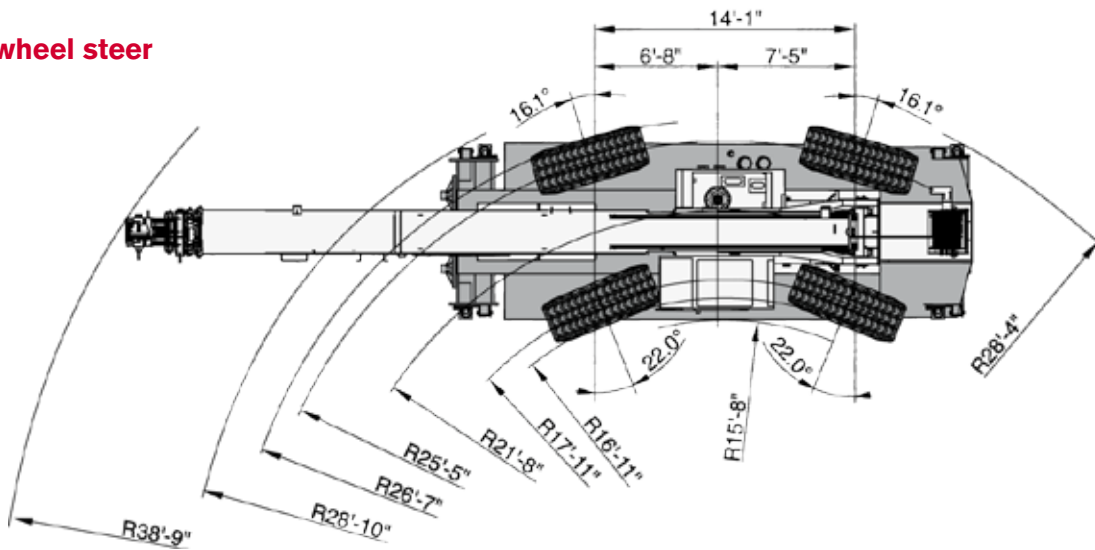

Rear

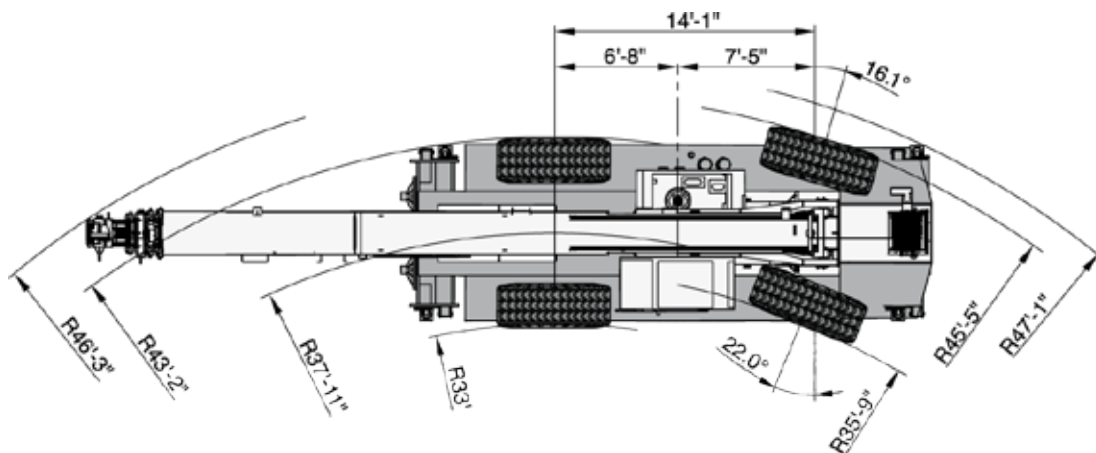

# RANGE DIAGRAM – MAIN BOOM

**RT 100US**

**Outriggers Fully Extended (100%), 3 Modes**

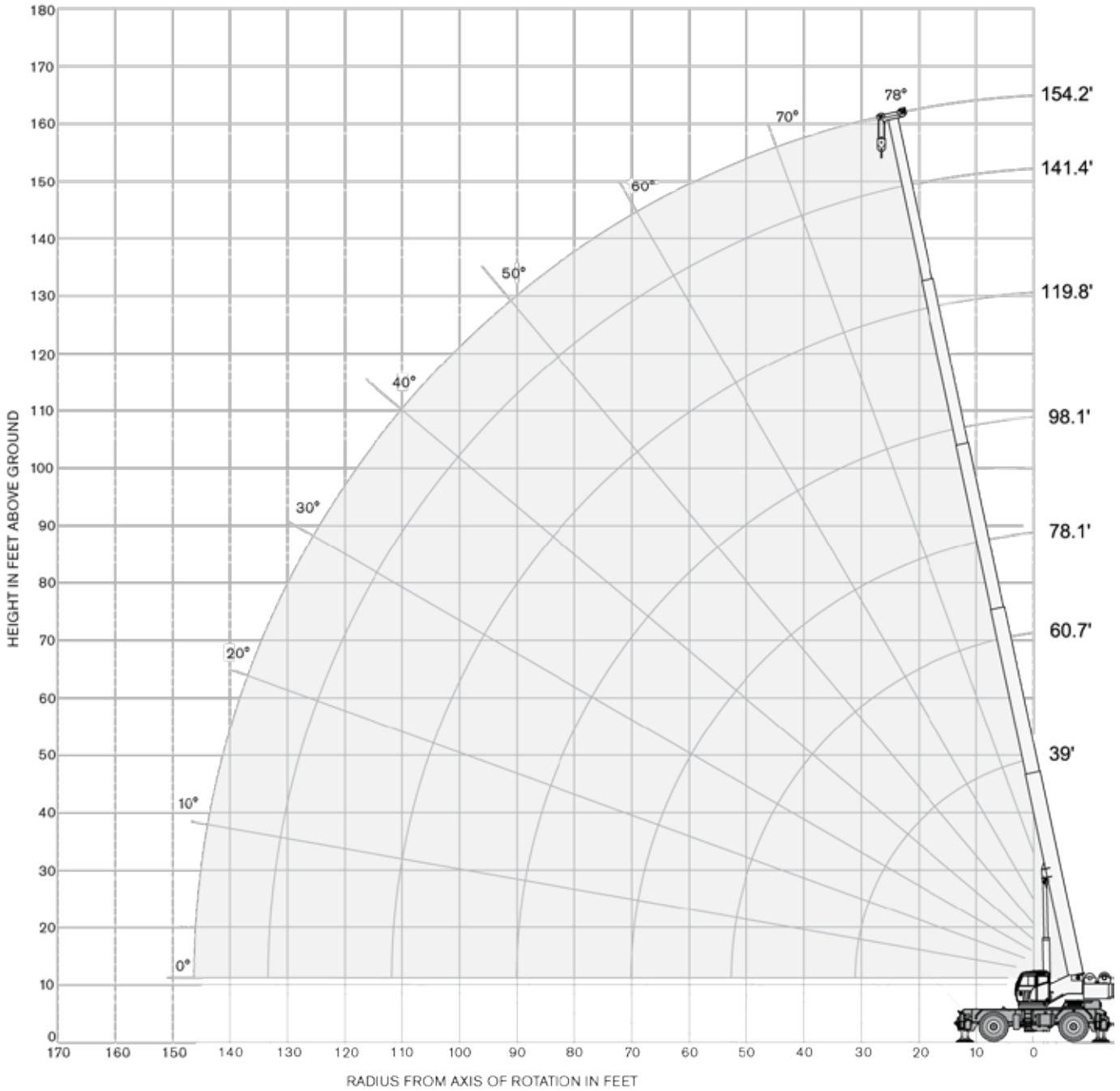
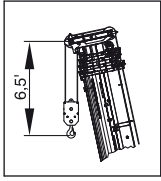
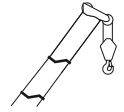



# LOAD CHART – MAIN BOOM

**RT 100US**

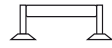

**Outriggers Fully Extended (100%), 3 Modes**

 22,000 lb

 25.6 x 26.2 ft  
(100 %)

 360°

Standard ASME  
B30.5

	Boom Length							
	39.0 ft	60.7 – 62.0 ft	78.1 – 82.3 ft	98.1 – 102.4 ft	119.8 – 121.1 ft	141.4 – 142.7 ft	154.2 ft	
ft	lb	lb	lb	lb	lb	lb	lb	ft
	200,000*							
8.2	191,800							8.2
10	174,900	101,500						10
15	135,800	79,600	78,700					15
20	99,100	79,600	78,300					20
25	76,000	75,500	73,600	50,500				25
30		62,200	61,300	47,100	33,200			30
35		50,900	50,000	42,200	31,800			35
40		40,300	41,400	37,200	28,900	23,400	19,600	40
45		32,700	33,600	31,500	25,900	20,700	19,400	45
50		27,200	28,000	26,300	23,300	19,800	17,500	50
55			23,500	22,400	21,000	18,300	15,400	55
60			20,000	20,400	18,600	16,700	13,600	60
65			17,300	17,700	15,800	15,200	12,100	65
70			15,100	15,400	13,400	13,800	10,700	70
75				13,300	11,700	12,200	9,600	75
80				11,500	10,600	10,400	8,600	80
85				10,000	9,800	8,900	7,600	85
90				6,800	8,900	7,700	6,700	90
95					8,000	6,500	5,700	95
100					7,000	5,500	4,600	100
105					6,200	4,600	3,700	105
110					5,300	3,800	2,900	110
115						3,100	2,200	115
120						2,400		120

\* special equipment needed

Notes to lifting capacity:

see page 20

# LOAD CHART – MAIN BOOM

**RT 100US**



## Outriggers Half Extended (50%), 3 Modes

 22,000 lb

 25.6 x 17.4 ft  
(50 %)

 360°

Standard ASME  
B30.5

	Boom Length							
	39.0 ft	60.7 – 62.0 ft	78.1 – 82.3 ft	98.1 – 102.4 ft	119.8 – 121.1 ft	141.4 – 142.7 ft	154.2 ft	
ft	lb	lb	lb	lb	lb	lb	lb	ft
8.2	175,700							8.2
10	156,000	101,500						10
15	112,700	79,600	75,600					15
20	65,600	64,400	58,300					20
25	43,000	45,300	43,900	41,100				25
30		32,500	33,300	32,700	27,900			30
35		25,200	25,900	26,300	25,200			35
40		19,600	20,300	20,700	20,900	18,100	16,600	40
45		15,900	16,600	17,000	17,200	15,100	13,800	45
50		13,200	13,700	14,100	14,300	12,600	11,300	50
55			11,300	11,800	12,000	10,500	9,300	55
60			9,400	9,900	10,100	8,800	7,700	60
65			7,900	8,300	8,600	7,200	6,300	65
70			6,800	7,100	7,300	6,000	5,100	70
75				6,000	6,300	4,900	4,100	75
80				5,100	5,300	4,000	3,100	80
85				4,200	4,500	3,100	2,300	85
90					3,800	2,500		90
95					3,100			95
100					2,400			100

Notes to lifting capacity:

see page 20





# LOAD CHART – MAIN BOOM

**RT 100US**

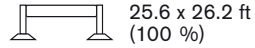
**Outriggers Fully Extended (100%), 3 Modes**



Standard ASME  
B30.5

	Boom Length							
	39.0 ft	60.7 – 62.0 ft	78.1 – 82.3 ft	98.1 – 102.4 ft	119.8 – 121.1 ft	141.4 – 142.7 ft	154.2 ft	
ft	lb	lb	lb	lb	lb	lb	lb	ft
8.2	191,800							8.2
10	172,700	101,500						10
15	123,000	79,600	76,500					15
20	86,600	78,600	74,600					20
25	59,300	60,700	54,100	46,500				25
30		41,600	41,300	37,600	32,500			30
35		30,800	31,800	31,200	26,500			35
40		23,000	23,800	24,500	23,100	20,300	18,700	40
45		17,900	18,800	19,500	19,600	16,800	15,200	45
50		14,200	15,000	15,600	16,200	13,800	12,200	50
55			12,000	12,600	13,200	11,200	9,600	55
60			9,600	10,200	10,600	8,900	7,400	60
65			7,700	8,200	8,600	7,100	5,700	65
70			6,200	6,600	7,100	5,500	4,300	70
75				5,300	5,600	4,100	3,100	75
80				4,200	4,400	2,900		80
85				3,100	3,400	2,000		85
90					2,500			90

Notes to lifting capacity:

see page 20

# RANGE DIAGRAM - JIB

**RT 100US**

**55.8 ft offset, 3 Modes**

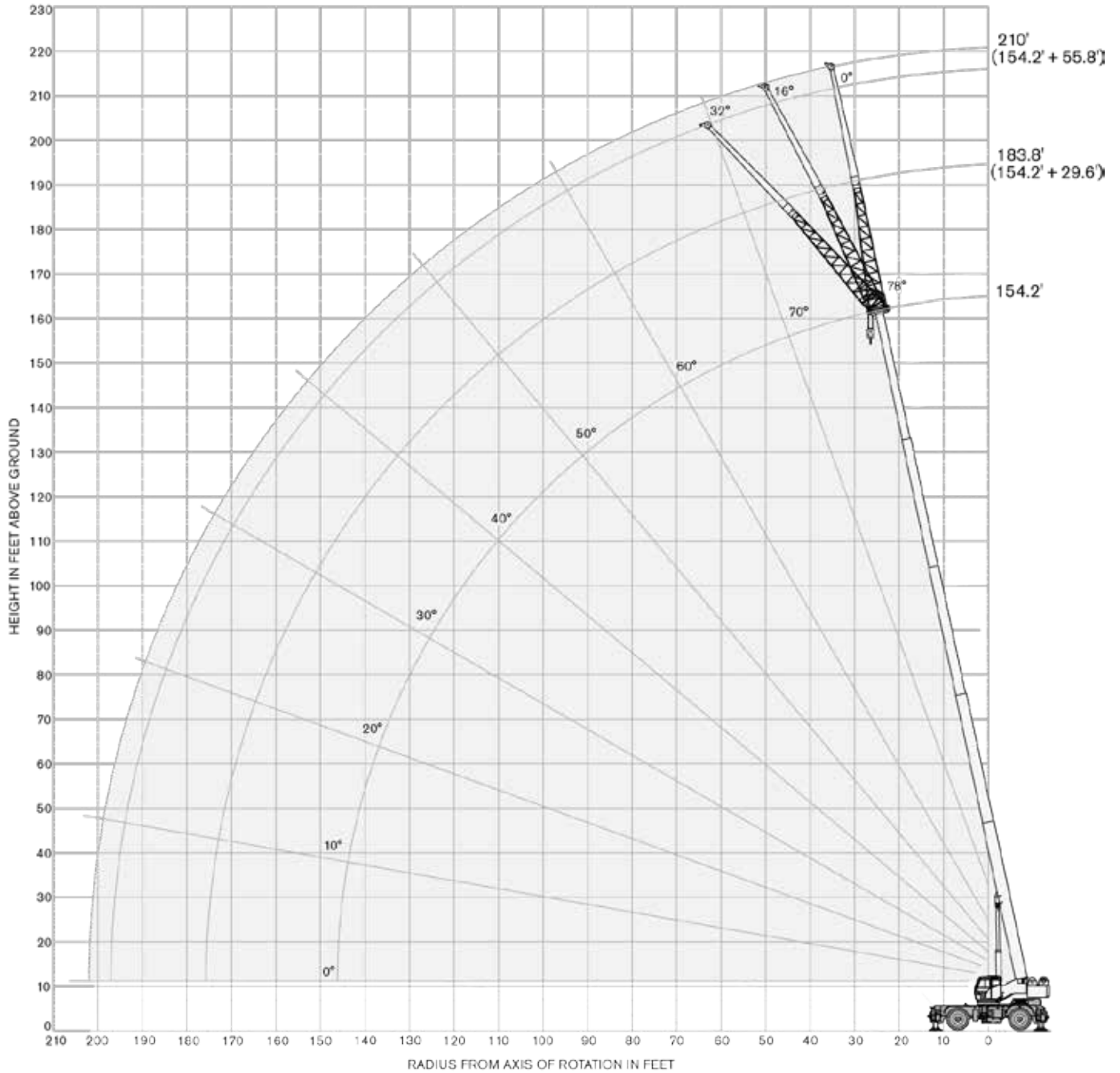
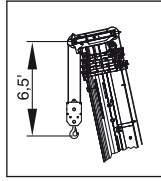
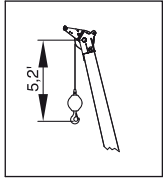
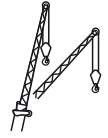

# LOAD CHART – JIB

**RT 100US**



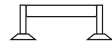

## Outriggers Fully Extended (100%)

 22,000 lb

 25.6 x 26.2 ft  
(100 %)

 360°

Standard ASME  
B30.5

Boom Length 154.2 ft							
	 29.5 ft			 55.8 ft			
	0°	16°	32°	0°	16°	32°	
ft	lb	lb	lb	lb	lb	lb	ft
50							50
55	11,000						55
60	11,000	10,900		6,800			60
65	11,000	10,400	9,500	6,800			65
70	10,400	9,800	9,000	6,800			70
75	9,600	9,200	8,500	6,700	5,500		75
80	8,600	8,600	8,100	6,600	5,500		80
85	7,600	8,000	7,700	6,400	5,300	4,600	85
90	6,500	7,300	7,200	6,200	5,300	4,500	90
95	5,500	6,300	6,700	5,600	5,200	4,400	95
100	4,500	5,200	6,000	4,800	5,000	4,400	100
105	3,500	4,400	4,800	4,000	4,800	4,400	105
110	2,700	3,600	4,000	3,300	4,500	4,200	110
115	2,000	2,700	3,200	2,600	3,900	4,200	115
120			2,400	2,000	3,300	4,000	120
125					2,600	3,500	125
130					1,900	2,800	130
135						2,100	135

Notes to lifting capacity:

see page 20

# LOAD CHART – MAIN BOOM

**RT 100US**

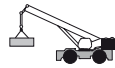

## On Tires, Mode 3

 22,000 lb

 On tires  
26.5 R 25 / 29.5-25

 360°

Standard ASME  
B30.5

	Boom Length								
	39 ft	44.9 ft	50.5 ft	56.4 ft	62.0 ft	67.9 ft	73.5 ft	79.4 ft	
ft	lb	lb	lb	lb	lb	lb	lb	lb	ft
15	27,300	25,600	24,000	22,500	21,400	20,100	19,000	17,900	15
16	24,000	22,500	21,200	20,100	19,000	17,900	17,000	15,900	16
20	19,000	17,900	16,800	15,900	15,000	14,300	13,400	12,800	20
23	15,000	14,100	13,400	12,800	12,100	11,500	10,800	10,400	23
26	12,100	11,500	10,800	10,100	9,700	9,300	8,600	8,200	26
30	9,700	9,300	8,600	8,200	7,700	7,300	6,800	6,400	30
33		7,500	6,800	6,400	6,200	5,700	5,300	5,100	33
39			4,200	3,700	3,500	3,300	3,100	2,600	39
46				2,000	1,800				46

Notes to lifting capacity:

see page 20







# LOAD CHART – MAIN BOOM

**RT 100US**

## On Tires, Mode 3

 22,000 lb

**Boom straight over front  
Creep**

 On tires  
26.5 R 25 / 29.5-25





Standard ASME  
B30.5

	Boom Length								
	39 ft	44.9 ft	50.5 ft	56.4 ft	62.0 ft	67.9 ft	73.5 ft	79.4 ft	
ft	lb	lb	lb	lb	lb	lb	lb	lb	ft
8	54,500								8
10	48,100	48,500	48,700	48,700	48,900	48,900			10
12	42,800	43,200	43,400	43,400	43,700	43,700			12
13	38,400	38,800	39,000	39,000	39,000	39,200	39,200		13
15	34,400	35,100	35,300	35,300	35,300	35,500	35,500	35,500	15
16	31,100	31,700	32,000	32,000	32,000	32,200	32,200	32,200	16
20	25,800	26,500	26,500	26,700	26,700	26,700	26,900	26,900	20
23	21,600	22,000	22,300	22,500	22,500	22,500	22,700	22,700	23
26	18,300	18,700	19,000	19,000	19,200	19,200	19,200	19,200	26
30	15,400	15,900	16,100	16,300	16,300	16,300	16,500	16,500	30
33		13,700	13,700	13,900	14,100	14,100	14,100	14,100	33
39			10,100	10,100	10,400	10,400	10,400	10,400	39
46				7,500	7,500	7,700	7,700	7,700	46
53					5,300	5,500	5,500	5,500	53

**Notes to lifting capacity:**

see page 20

## Hydraulic Boom

	5 sections	
	Triple mode	<b>Mode 1:</b> Optimized for best capacity on longer radius <b>Mode 2:</b> Optimized for best capacity on short radius <b>Mode 3:</b> Full proportional
	Min. / Max.	39 ft / 154.2 ft
	Max. tip height main boom	164.0 ft
	Boom luffing angle range (min. / max.)	-2° / +78°
	Boom raising / lowering time <sup>(1)</sup>	50 s / 55 s
	Boom extension / retraction time <sup>(1)</sup>	120 s / 125 s

## Hoist

	Hydraulic motor Rope roller device Normally engaged brake	
	2 speeds	
	Max. <sup>(1)</sup>	502 ft / min (6th layer)
	Rotational resistant	
		3/4 in
		820 ft
	Permissible line pull	16,000 lb

## Upper Structure

		22,000 lb
	Non stop Maximum speed <sup>(1)</sup>	360° 1.0 rpm
	Hydraulic motor Planetary reducer	

## Cab and Controls



### S-pace cab:

- Sliding door
- Wide visibility
- Front and upper window with windscreen wiper
- Upper windows can be opened
- Tiltable cab
- Fully adjustable seat onto shockproof suspensions
- Equipped with tiltable arm rests with integrated hand controls for crane operation
- Radio with CD player
- Seat belts



- Climatized cab
- Air-conditioning



- Electro-proportional joysticks
- IC-1 control system – Load indicator with graphic interface



- Adjustable working light outside the cab

## Carrier



### Cummins QSB6.7 Stage 4 - Tier 4F

- No. of cylinders 6
- Gross power 225 hp @ 2200 rpm
- Maximum gross torque 770 lb-ft @ 1500 rpm
- Fuel tank capacity 79 gallons
- Diesel Exhaust Fluid (DEF) 10 gallons



- Rear axle differential lock

## Vehicle Performance



- Max.<sup>(2)</sup> 76 %



- Max.<sup>(2)</sup> Tires 29.5-25 19.3 mph  
Tires 26.5R25 18.0 mph









- Min. / Max. -20° / 45 °C  
(-20 °C with special fluids and options)

## Tires



- Earth moving style 29.5-25

## Options

	<b>Cummins QSB6.7 Stage IIIA - Tier 3</b>	
	No. of cylinders	6
	Gross power	220 hp @ 2200 rpm
	Maximum gross torque	700 lb-ft @ 1500 rpm
	Fuel tank capacity	79 gallons
	<b>2</b> Auxiliary winch	
		26.5 R 25
	Bi-fold extension	29.5 ft / 55.8 ft
	Rooster sheave	
	Auxiliary diesel heater	
	Centralized lubrication system	

Note: refer to your local dealer for a full list of options.

(1) Indicative value only for reference.

(2) Standard crane in travelling configuration – value calculated with nominal tire radius and max power delivered to the wheels.

## NOTES TO LIFTING CAPACITY

### Notes page 11-13 + 15-17

Weight of hook blocks and slings is considered part of the load and must be subtracted from the capacity ratings. Consult operation manual for further details.

Note: Data published herein is intended as a guideline only and shall not be construed to warrant applicability for lifting purposes. For actual crane operation refer to the computer charts and the operating manual, both of which are supplied with the crane.

## When Quality & Reliability meet Innovation.

We combine two strong crane brands, Terex and Demag, known for quality and reliability and worldwide service.

Associating the two brands gives us the unique opportunity to capitalize on the technological innovation of Demag. With „**Demag Tech Inside**”, we put the power of innovation to work for you as your Terex crane now incorporates Demag components and technology.

With „**Demag Tech Inside**”, we bring performance and productivity to another level: the Terex RT 100US features the **Demag IC-1 control system**, designed specifically for ease of use in the RT market.

Available in 17 languages, the Demag IC-1 control system can be monitored on a color touch screen for intuitive use. Proven on the Demag cranes, the IC-1 control system brings improved quality and reliability as well as easy cross training between product lines. Its advanced diagnostics allow easy service.

With „**Demag Tech Inside**”, we support you on the road to success. This is Terex Cranes.

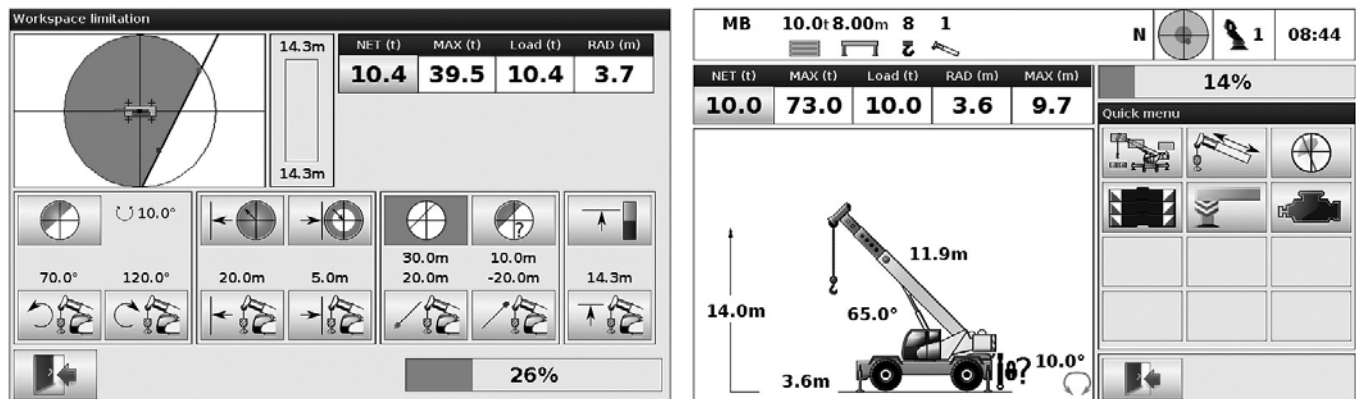

Lined area for notes.

A large rectangular area with horizontal lines, intended for taking notes. The lines are evenly spaced and cover the majority of the page's width and height.

January 2018. Product specifications and prices are subject to change without notice or obligation. The photographs and/or drawings in this document are for illustrative purposes only. Refer to the appropriate Operator's Manual for instructions on the proper use of this equipment. Failure to follow the corresponding Operator's Manual when using our equipment or to otherwise act responsibly may result in serious injury or death. The only warranty applicable to our equipment is the standard written warranty applicable to the particular product and sale and Terex makes no other warranty, express or implied. Products and services listed may be trademarks, service marks or trade-names of Terex Corporation and/or its subsidiaries in the USA and other countries. All rights are reserved. Terex, the Terex Crown design and Works For You are trademarks of Terex Corporation or its subsidiaries.

© Terex Cranes 2018

Terex Cranes, Global Marketing, Dinglerstraße 24, 66482 Zweibrücken, Germany  
Tel. +49 (0) 6332 830, Email: [info.cranes@terex.com](mailto:info.cranes@terex.com), [www.terex.com/cranes](http://www.terex.com/cranes)



[www.terex.com/cranes](http://www.terex.com/cranes)

Brochure Reference: TC-DS-I-E-RT100US-01/18



**WORKS FOR YOU.™**