



PDG 102MN

Natural Gas Gyro Machine



Top Motor, 2 Double Burners

Atlantic Supermarket Equipment

849 Newark Turnpike, Suite 101, Kearny, NJ 07032

Tel: 201-467-8222 | Fax: 201-624-7444 | info@inoksanUSA.com | www.inoksanUSA.com

PDG 102MN

DRAWING

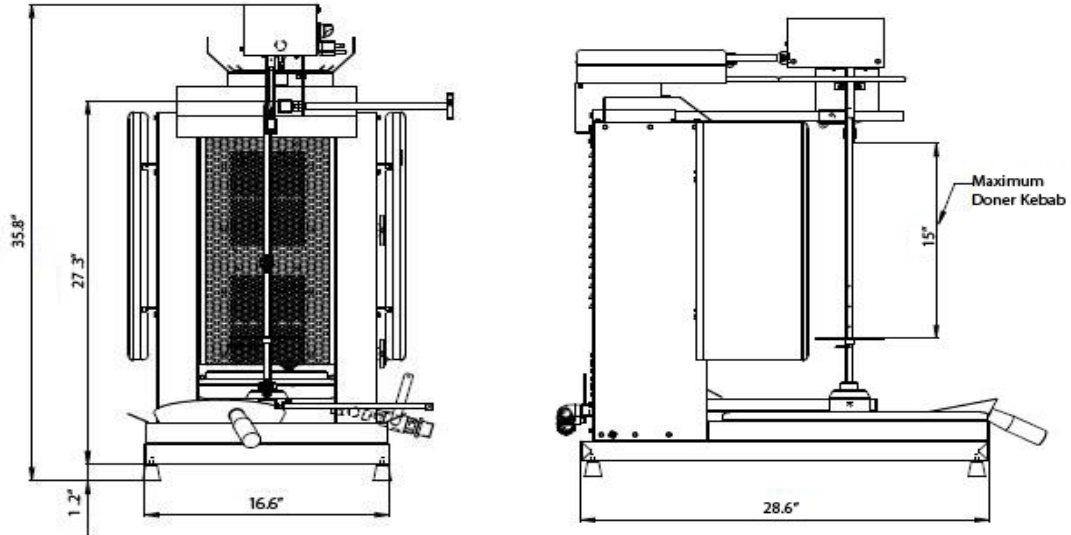

SPECIFICATIONS

Burners	2 Double
Width	16.6"
Depth	28.6"
Height	35.8"
Power	20,472 BTU
Electrical	120V/1P/60Hz/1A
Meat Cap.	66-99 lb.
Skewer Length	21.4"
Skewer Length in Use	15"
Gas Inlet	½"
Net Weight	79 lb.

FEATURES

- ✓ The motor is very well insulated to avoid any water or grease contact.
- ✓ The skewer can be leaned towards or away from the burners to cook top or bottom of the cone faster.
- ✓ Provides easy cleaning, excellent look, healthy and uniform cooking experience.
- ✓ Unique design allows the motor to keep rotating during slicing without any stress on the motor.
- ✓ The motor can be rotated in either clockwise or counter-clockwise directions.
- ✓ Heat shields on both sides helps to preserve heat and save energy.
- ✓ The meat base on the skewer is adjustable to allow cooking small or large cones.