



**JTC-1011 CRANKSHAFT PULLY HOLDER**

- For removal and replacement of the crankshaft bolt, M112 and M113, as found on E320, E430, etc.
- Applicable: BENZ M112, M113, M137, M155, M156, M275, and M288.



**JTC-1115 BMW BUSH REMOVER / INSTALLER**

- Removal and replacement tool for metallic bushes on rear axles.
- Applicable: BMW E38, E39, E53, E60, E61, E 63, E64, E65, E66, E67, E70, F01, F02, F04, F07 , F10, F11, F18.

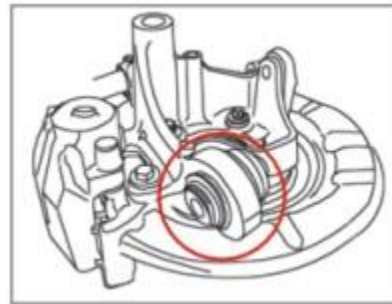

**JTC-1123 IGNITION LOCK REMOVER**

- For removal and replacement of the ignition switch retaining ring fitted to Mercedes types W129, W140, W202, W210, W220, W203, W209, W211, W204.



**JTC AUTO TOOLS USA**

678 - 876 - 3470

2600 NORTHLAKE DR., SUITE F,  
SUWANEE, GA, 30024



**JTC-1124 WHEEL STUD ALIGNMENT GUIDE TOOL (M14)**

- Assists when mounting wheels, especially late models with long lug bolts.
- Size: M14 x 1.5
- Applicable: All Mercedes models with lug bolts.



**JTC-1215 BMW REAR AXLES BUSH REMOVER / INSTALLER**

- Removal and replacement tool for metallic bushes on rear axles BMW type E36, E46.
- Replacement of the mounting bushes without removing the complete rear axle assembly.
- Applicable: BMW E36, E46, E85.



VIDEO OF INSTRUCTION



**JTC-1231 MB TRANSMISSION DIPSTICK 722.6**

- The tool is designed to measure the oil level of transmission.
- Full length: 1220mm
- Applicable: transmission type 722.6



**JTC AUTO TOOLS USA**

678 - 876 - 3470

2600 NORTHLAKE DR., SUITE F,  
SUWANEE, GA, 30024

**JTC-1232 MB TRANSMISSION DIPSTICK**

- The tool is designed to measure the oil level of transmission.
- Full length: 920mm
- Applicable: transmission type 722.7, 716.5, 722.8

**JTC-1233 MB TRANSMISSION DIPSTICK (STRAIGHT END)**

- Full length: 930mm, balance the top of the oil gauge.
- Applicable: Engine model: 103, 943/984/985, 104, 111, 119, 120, 137, 603, 913/963/97, 604, 605, 606, 611, 612, 613, and 626.

**JTC-1234 MB TRANSMISSION DIPSTICK (VOLUTE END)**

- Full length: 930mm, the top of the oil gauge can turn back to 90 degrees.
- Applicable: Engine model: 112, 113, 646, 647, and 648.

**JTC AUTO TOOLS USA**

678 - 876 - 3470

2600 NORTHLAKE DR., SUITE F,  
SUWANEE, GA, 30024



**JTC-1306 BENZ SUB-FRAME BUSH REMOVER / INSTALLER**

- Special design for removing and installing the frame on the car.
- Applicable: W211, W220, W203.



**JTC-1307 BENZ SEAL TOP AIR SUSPENSION STRUT W220**

- Special design to remove the seal cap easily and replace the seal within a short time.
- Application: Mercedes cars W220.



**JTC-1308 SPARK PLUG ELECTRIC WIRE REMOVER FOR BENZ V6**

- Special angle with 17mm wrench to be a lever for removing and installing the wire easily.
- Applicable: Benz engine models V6.



**JTC AUTO TOOLS USA**

678 - 876 - 3470

2600 NORTHLAKE DR., SUITE F,  
SUWANEE, GA, 30024



**JTC-1309 BMW CAMSHAFT ALIGNMENT TOOL**

- Use with JTC-1807 to fix on the camshaft
- Special design for using before installing the accurate engine.
- Applicable: BMW engine models M52TW, M54, and M56.



**JTC-1313 FAN CLUTCH TOOLS SET**

- Contents: JTC-1701, 1702, 1703, 1713, 1714, 1715, 1832
- Application: Most of Mercedes Benz and BMW vehicles.



**JTC-1331 BENZ CAMSHAFT ALIGNMENT TOOL**

- Holds the camshaft in 40 degree. TDC position (left / right side)
- Applications: Benz M111, M119.

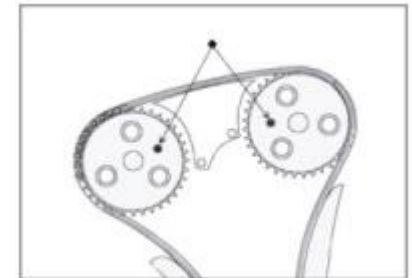

**JTC AUTO TOOLS USA**

678 - 876 - 3470

2600 NORTHLAKE DR., SUITE F,  
SUWANEE, GA, 30024



**JTC-1332 BENZ CAMSHAFT ALIGNMENT TOOL**

- Holds the camshaft in 40 degree. TDC position (left / right side).
- Applications: Benz M112, M113.



LEFT

RIGHT



**JTC-1338 BENZ STRUT NUT SOCKET W220**

- Use for removing and installing the top shock retaining nut.
- Applications: Benz W220



**JTC-1339 BENZ STRUT NUT SOCKET W203**

- Use for removing and installing the top shock retaining nut.
- The function is same as #1338.
- Applications: Benz W203



**JTC AUTO TOOLS USA**

678 - 876 - 3470

2600 NORTHLAKE DR., SUITE F,  
SUWANEE, GA, 30024



**JTC-1415 BENZ ML BALL JOINT SOCKET**

- Pin wrench socket 3/4" drive, to secure retaining ring for ball joint replacement.
- Applicable: 163 M-Class front and rear axles.
- Retaining ring is torqued to 300 Nm /226 ft. /lbs.



**JTC-1419 BMW REAR SUB-FRAME DIFFERENTIAL BUSH EXTRACTOR / INSTALLER**

- To extract and install the rear sub-frame and differential bush.
- Applicable: BMW E46, E85.



**JTC-1420 BENZ TRANSMISSION OVERFLOW PIPE REMOVER**

- Drift for unclipping the overflow pipe in the oil pan when draining the oil.
- Applicable: BENZ 722.9 model transmission.



**JTC AUTO TOOLS USA**

678 - 876 - 3470

2600 NORTHLAKE DR., SUITE F,  
SUWANEE, GA, 30024



**JTC-1433 BMW SPROCKET EXTRACTOR / INSTALLER**

- For turning sprockets when removing and installing VANOS unit.
- Applicable: BMW m50 / m52 / s50 / s52



**JTC-1533 CRANKSHAFT PULLY HOLDER (M271)**

- For removal and replacement of the crankshaft bolt.
- Applications: BENZ M271.



**JTC-1549 BENZ STEERING TORQUE ROD JOINT INSTALLER / REMOVER**

- Application: W171, W203, W209.
- Special design with self-locking nut to remove and install the torque strut at front axle.
- Bore size: M14 x 1.5



**JTC AUTO TOOLS USA**

678 - 876 - 3470

2600 NORTHLAKE DR., SUITE F,  
SUWANEE, GA, 30024





**JTC-1550 BENZ / BMW FUEL TANK LID WRENCH**

- The tool is designed to remove the plastic fuel tank lid.
- Applicable:  
BMW: MODEL 211/ 203  
BMW: E36, E46



**JTC-1552 BENZ SUB-FRAME BUSH INSTALLER / REMOVER (ML)**

- Removal and replacement tool for metallic bushes on rear axles.
- Applicable: BENZ W164

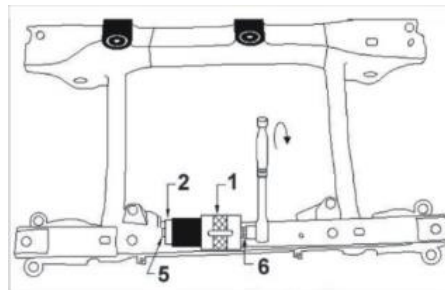

**JTC-1556 BMW REAR SUB-FRAME DIFFERENTIAL END BUSH INSTALLER / REMOVER**

- On car maintenance.
- For replacement of the rear suspension differential bush.
- Applicable: BMW E46, E85



**JTC AUTO TOOLS USA**

678 - 876 - 3470

2600 NORTHLAKE DR., SUITE F,  
SUWANEE, GA, 30024



**JTC-1701 FAN CLUTCH TOOLS 32mm**

- Removes lock nuts on the thermo-Viscous fans found on Ford, BMW...many vehicles.
- Length: 380mm
- Size: 32mm



**JTC-1702 FAN CLUTCH TOOLS 36mm**

- Removes lock nuts on thermostats and viscous fans found on Ford, Mercedes, BMW, etc.
- Made from tempered pressed steel.



**JTC-1703 FAN CLUTCH HOLDER**

- Allow the technician to hold the water pump pulley in place while loosening the radiator fan.
- BMW engine models M10, M20 and M30, and late cars.



**JTC AUTO TOOLS USA**

678 - 876 - 3470

2600 NORTHLAKE DR., SUITE F,  
SUWANEE, GA, 30024



**JTC-1712 GUIDE RAIL PIN PULLER**

- Can remove even the most stubborn pins from the cylinder head.
- Applicable: Mercedes engine M102, 110, 115, 116, 117, 130, OM601, 602, 603, 615, 616, and 617.



**JTC-1713 FAN CLUTCH HOLDER L-TYPE**

- Used for R & R viscous fan coupling with radiator in place.



**JTC-1714 FAN CLUTCH HOLDER 3-HOLES**

- Specially designed 3-holes to hold the stud on fan clutch assembly.
- Designed for cars such as Mercedes-Benz.
- Slim handle for tight space operation.



**JTC AUTO TOOLS USA**

678 - 876 - 3470

2600 NORTHLAKE DR., SUITE F,  
SUWANEE, GA, 30024



**JTC-1725 DASHBOARD SERVICE TOOL KIT**

- Kit includes ignition lock remover, radio set remover, and instrument cluster removing hooks.
- Suitable for most Mercedes-Benz series.



**JTC-1801 BENZ SPRING COMPRESSOR**

- Types: 116/ 123 / 124 / 126 / 129 / 140 / 201 / 202 and 4-matic include.
- Advantage: Newly developed automatic 3-point safety interlock and automatic freewheel at end of stroke.



**JTC-1807 BMW CAMSHAFT ALIGNMENT TOOL – M50**

- Includes: 2 blocks, swivel lock and locking pin, for setting camshaft timing.
- Applicable: BMW engine models M42 and M50.



**JTC AUTO TOOLS USA**

678 - 876 - 3470

2600 NORTHLAKE DR., SUITE F,  
SUWANEE, GA, 30024



**JTC-1808 BMW CAMSHAFT ALIGNMENT TOOL – M60**

- Includes: 2 blocks, swivel lock and locking pin, for setting camshaft timing.
- Applicable: BMW engine models M60 and M62.



**JTC-1832 FAN BELT SERVICE WRENCH**

- This universal tool has been designed service Mercedes Benz, Nissan Quest, Mercury Villager Radiator fans and pulley belts.
- This special wrench can be used for loosening the A/C idler pulley tension lock-nut for A/C belt adjustment or replacement.
- 8m/m and 10m/m bit included.



**JTC-1837 BUSH REMOVER / INSTALLER**

- Removal and replacement tool for metallic bushes on rear axles.
- Applicable: W140, W124, W201, W202, W129, W210, 220.



**JTC AUTO TOOLS USA**

678 - 876 - 3470

2600 NORTHLAKE DR., SUITE F,  
SUWANEE, GA, 30024



**JTC-1842 BMW GUIDE RAIL PIN PULLER**

- Can remove even the most stubborn pins from the cylinder head, unlike the short slide hammer previously used to attempt this job.
- This puller incorporates a thrust bearing to ease the pulling action.



**JTC-1844 FUEL TANK LID WRENCH W210**

- The tool is designed to remove the plastic fuel tank lid.
- Applicable: W210



**JTC-1851 FUEL TANK CUP WRENCH W202**

- The tool is designed to remove the plastic fuel tank lid.
- Applicable: W202



**JTC AUTO TOOLS USA**

678 - 876 - 3470

2600 NORTHLAKE DR., SUITE F,  
SUWANEE, GA, 30024



**JTC-1852 BRAKE SPRING INSTALLER**

- For pressure spring of packing brake.
- Applicable: All Mercedes models.



**JTC-1853 WHEEL STUD ALIGNMENT GUIDE TOOL (M12)**

- Assists when mounting wheels, especially late models with long lug bolts.
- Size: M12 x 1.5
- Applicable: All Mercedes models with lug bolts.



**JTC-1858 BMW BUSH EXTRACTOR**

- Used for R & R of rear wheel bearing located in wheel carrier.
- Applicable: E36, E30, E46



**JTC AUTO TOOLS USA**

678 - 876 - 3470

2600 NORTHLAKE DR., SUITE F,  
SUWANEE, GA, 30024



**JTC-4005 BMW CAMBER ADJUSTING TOOL E60**

- Use to adjust front camber.
- Applicable : BMW E60, E61, E63, E64.



**JTC-4006 BMW CAMBER ADJUSTER E38**

- Use this fixture to adjust the front camber on late model 3 series.
- Applicable : BMW E38, E39, E46, E53, E65, E66, E67, E81, E83, E85, E86, E87, E90, E91, E92, E93



**JTC-4028 BMW A/C COMPRESSOR CLUTCH REMOVER**

- To remove the plate of clutch on BMW.
- Applicable : Most BMW cars.
- Size : M26 X P1.5



**JTC AUTO TOOLS USA**

678 - 876 - 3470

2600 NORTHLAKE DR., SUITE F,  
SUWANEE, GA, 30024





**JTC-4046 OIL FILTER WRENCH 46mm**

- The special socket is suitable for the operation of the filter housing cap when replacing the AD blue filter on MERCEDES-BENZ commercial vehicles with blue TEC engines.
- Suitable for these vehicles as below :  
ACTROS, ATEGO, AXOR, ECONIC



**JTC-4047 BENZ ALIGNMENT TOOL SET (M275)**

- This retaining device is designed for positioning the camshaft in 30 degree TDC position.
- Applicable:  
M275, M285: The set C only used for left bank of cylinder and set A&B used for right bank.  
M137: Use the set A&B to loosen and tighten mounting screws for the camshaft sprocket and adjusting the timing.

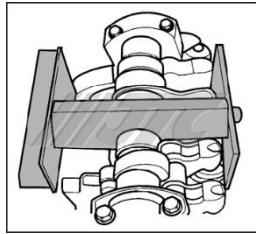

VIDEO OF INSTRUCTION



**JTC-4048 BMW STRENGTHEN BUSH INSTALLER TOOL**

- Special designed tool to compress the strengthen bush before stalling into sub-frame.
- Use with JTC-4820 or other install tool.
- Applicable : BMW E87, E90, E92, E93



**JTC AUTO TOOLS USA**

678 - 876 - 3470

2600 NORTHLAKE DR., SUITE F,  
SUWANEE, GA, 30024



**JTC-4059 BMW CRANKSHAFT ROTATING TOOL**

- Special designed to rotate the BMW diesel engine crankshaft.
- Applicable :  
 2.5D: M57N256D2  
 3.0D: M57306D3, M5736D5, M57D30A, M57N206D3, M57N2306D3, M57N306D2, M57N306D3, M57N306D5, N57N306D2, N57N306D3



**JTC-4060 BENZ FLYWHEEL LOCKING TOOL M112**

- Used to fix the flywheel gear to remove and install crankshaft pulley center bolt.
- Applicable : BENZ M112, M113, M137, M155, M156, M272, M273.

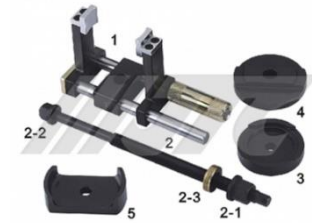

**JTC-4096 BMW SUSPENSION BUSH EXTRACTOR / INSTALLER (E39)**

- Operation on car
- Extractor for replacement of the rear suspension mounting bushes.
- Replacement of the mounting bush without completely lowering the rear axle assembly.
- Applicable: BMW E39



**JTC AUTO TOOLS USA**

678 - 876 - 3470

2600 NORTHLAKE DR., SUITE F,  
 SUWANEE, GA, 30024



**JTC-4097 BMW SUSPENSION BUSH EXTRACTOR / INSTALLER (E53)**

- Operation on car
- Extractor for replacement of the rear suspension mounting bushes.  
Replacement of the mounting bush without completely lowering the rear axle assembly.
- Applicable: BMW E53



**JTC-4101 BENZ SUB-FRAME BUSH INSTALLER / REMOVER W221**

- Removal and installation of rear rubber mounts of axle suspension.
- Applicable: BENZ W216, W221, and W222.
- MM number: 221589004300, 221589034300.



**JTC-4110 BENZ FUEL TANK LID WRENCH (W164)**

- The tool is designed to remove the plastic fuel tank lid.
- Applicable: BENZ W164, W251
- MM number: 164589010700.



**JTC AUTO TOOLS USA**

678 - 876 - 3470  
2600 NORTHLAKE DR., SUITE F,  
SUWANEE, GA, 30024



**JTC-4111 BMW, VOLVO FUEL TANK LID REMOVER**

- Special designed to remove fuel tank lid for diesel and petrol cars.
- Applicable:  
BMW: F01, F02, F10, F12  
VOLVO T4, T5 engine, 2010 later



**JTC-4114 BENZ FLYWHEEL LOCKING TOOL (M166)**

- Used to fix the flywheel gear to remove & install crankshaft pulley center bolt.
- Applicable:  
BENZ : A class W169 (M166)  
B class W245 (M266, OM640)
- MM number: 166589004000.



**JTC-4117 BMW N63 TIMING TOOL SET**

- Special designed to located and turn the camshaft in correct TDC position.
- The 4117-7 holding tool is designed to hold the camshaft pulley for turning the central bolt.
- Applicable: BMW N63 engine.

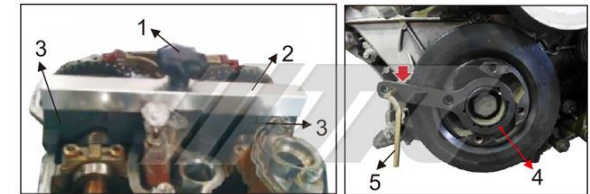

VIDEO OF INSTRUCTION



**JTC AUTO TOOLS USA**

678 - 876 - 3470  
2600 NORTHLAKE DR., SUITE F,  
SUWANEE, GA, 30024



**JTC-4132 BMW BALANCE AXLE ALIGNMENT TOOL (LARGE)**

- Plug in the tool for fixing the angle when you adjust the balance axle to the correct angle.
- Applicable : BMW-N40, N42, N45, N46.
- Groove size: 9mm (extra-large).



**JTC-4143 BMW TIMING TOOL SET (N43)**

- Installing and removal of camshaft and variable camshaft timing unit.
- Checking and adjustment of timing.
- Applicable :
  - E87 : 118i/ 120i-N43
  - E90 : 316i/ 318i-N43
  - E92/ E93 : 320i-N43
  - E60/ E61 : 520i

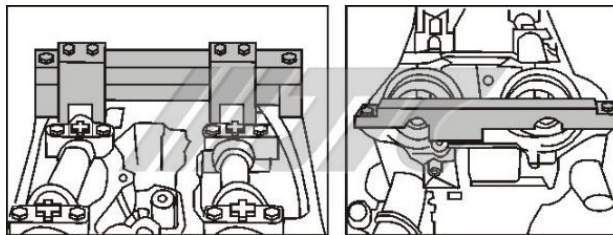

**JTC-4145 BMW HIGH PRESSURE PUMP REMOVER (N47)**

- Special designed to remove the BMW high pressure pump.
- Applicable : BMW N47 diesel engine

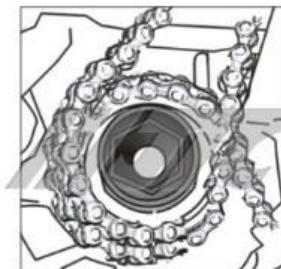

**JTC AUTO TOOLS USA**

678 - 876 - 3470

2600 NORTHLAKE DR., SUITE F,  
SUWANEE, GA, 30024



**JTC-4146 BMW FLYWHEEL HOLDER**

- Specially designed to fix the flywheel when replacing timing chain.
- It helps to release and tighten the central bolts on vibration damper.
- Applicable :  
BMW M47T2/ M47TU/ M57T2/ M57TU / M67/ N45/ N45T/ N46/ N46T/ N51/ N52/ N53/ N54/ W17

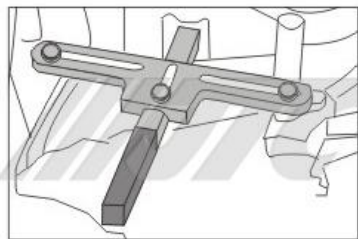

**JTC-4154 BENZ SUSPENSION COMPRESSOR TOOL SET**

- Special designed to disassemble and assemble the suspension nut.
- Use with JTC-1941.
- Applicable: W172, W203, W204, W207, W209, W211, W212, W218, W230, W242, W246
- MM number: 204589006300.



VIDEO OF INSTRUCTION



**JTC-4157 BMW CRANKSHAFT LOCKING TOOL (N42, N45)**

- Special designed to lock crankshaft when releasing / tightening central bolt.
- Applicable: BMW N12, N14, N40, N42, N45, N46, N52



**JTC AUTO TOOLS USA**

678 - 876 - 3470

2600 NORTHLAKE DR., SUITE F,  
SUWANEE, GA, 30024



**JTC-4161 BENZ SUB – FRAME BUSH INSTALLER / REMOVER (W210)**

- Extractor for replacement of the front and rear metallic rear sub-frame mounting bushes.
- Applicable: BENZ W210.



**JTC-4162 BENZ AIR SUSPENSION PIPING SOCKET**

- Special open end designed to remove the nut and keep away from air suspension pipe.
- Applicable: BENZ W211, W221, and W164.
- Weight: approx. 180g.
- Jaw opening diameter: 12.5mm.



**JTC-4169 BMW ENGINE TIMING TOOL SET (N62, N73)**

- Special designed master timing kit includes Crankshaft Wrench, Angle Indicator, 27mm Socket, Chain tensioner, and Camshaft Alignment holder and locking pin for BMW N62, N73.
- Applicable: BMW N62, N73.



**JTC AUTO TOOLS USA**

678 - 876 - 3470

2600 NORTHLAKE DR., SUITE F,  
SUWANEE, GA, 30024



**JTC-4177 1/2" X 17MM BENZ WHEEL SOCKET**

- Specially designed socket to remove and install the Mercedes wheel nut without get damaged.
- Size: 1/2" X17mm 6PT.
- Length: 78mm.



**JTC-4181 BENZ CAMSHAFT PULLEY SOCKET (T100H)**

- 1/2 Dr. x T100H Length: 78L.
- Special designed for correcting the position on camshaft pulley.
- Applicable: BENZ M133, M157, M270, M271, M276, and M278.
- MM number: 27158900100009/ 11CW.



**JTC-4183 BMW V-BELT INSTALLATION TOOL (M47, M57)**

- Special designed for installing the V-belt without causing damage.
- Applicable: BMW M47T2, M47TU, M57T2, M57TU, N47, N57TU
- BM No: 110330.



**JTC AUTO TOOLS USA**

678 - 876 - 3470

2600 NORTHLAKE DR., SUITE F,  
SUWANEE, GA, 30024





**JTC-4189 BMW MINI COOPER WINDOW GENERATOR  
ADJUST WRENCH**

- Special designed to adjust the window seal tightness from the window generator.
- Applicable :  
BMW Mini Cooper (R50 / R52 / R53 / R55 / R56).  
BMW 1'Car (E81 / E82 / E88).
- BM No: 513240.



**JTC-4198 BENZ CRANKSHAFT OIL SEAL INSTALLER**

- Used to install the front and rear crankshaft oil seal in good shape.
- OM NO.: 119589011400, 111589084300
- Applicable:  
BENZ: M102, 111, 112, 113, 137, 156, 159, 272, 275, 285,  
601, 602, 603, 604, 605, 606, 628, 629.



**JTC-4202 BENZ CRANKSHAFT PULLEY HOLDING TOOL  
(M272/ M273)**

- Removal and replacement of the crankshaft bolt.
- Applicable: BENZ M272, M273



**JTC AUTO TOOLS USA**  
678 - 876 - 3470  
2600 NORTHLAKE DR., SUITE F,  
SUWANEE, GA, 30024

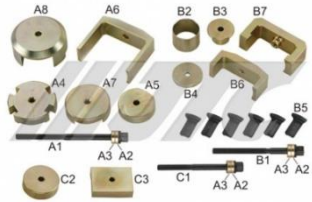

**JTC-4203 BENZ SUB-FRAME BUSH INSTALLER / REMOVER (W211)**

- Extractor for replacement of the front and rear metallic rear sub-frame mounting bushes.
- Applicable: BENZ W211, W219, and W230.

**JTC-4209 BMW CRANKSHAFT REAR OIL SEAL REMOVAL / INSTALL KIT**

- Install and remove the rear oil seal on crankshaft.
- Applicable: BMW N40, N42, N45, N45T, N46, N46T, N52, N53, N54.
- BM number: 119181, 119182, 119183, 119184.

**JTC-4210 BMW CRANKSHAFT FRONT OIL SEAL REMOVAL / INSTALLATION KIT**

- Specially designed to install and remove the front oil seal of crankshaft.
- Applicable: BMW N40, N42, N45, N45T, N46, N46T, N52, N53, N54.
- BM Number: 119220, 119230.

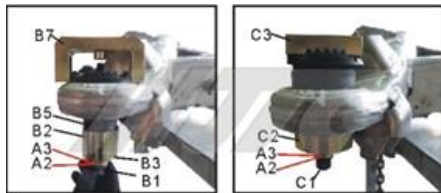

INSTALL FRONT BUSH

REMOVE FRONT BUSH

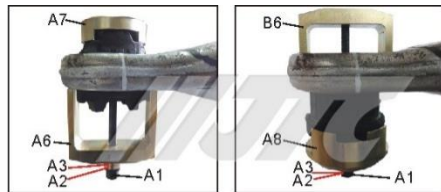

INSTALL REAR BUSH

REMOVE REAR BUSH



VIDEO OF INSTRUCTION

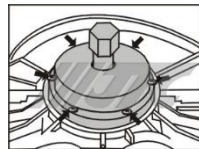

REMOVE

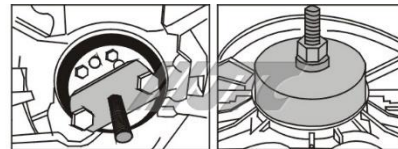

INSTALL

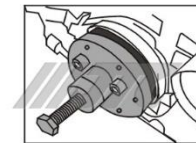

REMOVE

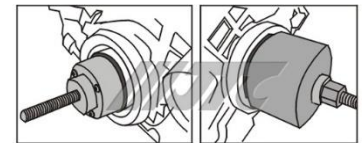

INSTALL



**JTC AUTO TOOLS USA**

678 - 876 - 3470

2600 NORTHLAKE DR., SUITE F,  
SUWANEE, GA, 30024



**JTC-4213 BENZ REAR BUMPER SOCKET**

- Specially designed to install and remove the rear bumper fixing screw.
- Size: 3/8" Dr. x 10mm x 120L x 6PT.
- Applicable: BENZ W204, W212, W221, etc.



**JTC-4214 BENZ TIMING TOOL SET (M276)**

- Special designed to align the camshaft timing angle for correct position.
- Applicable: BENZ M157, M276, M278 engine
- MM number: 276589014000

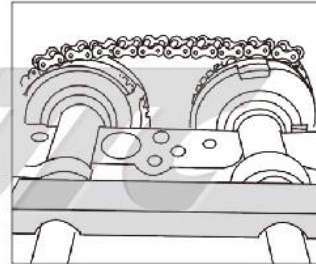

VIDEO OF INSTRUCTION



**JTC AUTO TOOLS USA**

678 - 876 - 3470  
2600 NORTHLAKE DR., SUITE F,  
SUWANEE, GA, 30024



**JTC-4221 BMW TRANSMISSION RUBBER MOUNT BUSH INSTALLER & REMOVER (X3, X5, X6)**

- Special tool to replace the rubber mount of BMW X5 transmission.
- Applicable: BMW X3/ E83, X5/ E53, X5/ E70, X6/ E71



E53 X5 2000-2003



E53 X5 2003-2007



E70 X5 2007-2013  
E71 X6 2008-2013



E83 X3 2004-2010  
(E46 4WD)(E90 4WD)  
(E60 4WD)



VIDEO OF INSTRUCTION



**JTC-4228 BENZ ENGINE TIMING TOOL SET (M651)**

- The retaining device makes it possible to position the camshafts in the installed position.
- Also for turning, installing, and removing the crankshaft pulley.
- Applicable: BENZ M651 engine (07 ~)
- MM number: 651589014000, 651589004000



**JTC-4235 BMW ENGINE TIMING TOOL SET (S54)**

- For checking and setting camshaft timing when installing VANOS adjustment unit on S54 engines.
- BM number: 119140, 119130, 119170, 117340, 115100, 117160, 112300
- Applicable: M3 cabriolet (00 ~ 06), sports coupe (99 ~ 06), CSL sports coupe (03 ~ 04)

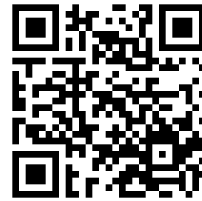

**JTC-4239 BENZ FLYWHEEL LOCKING TOOL (M651)**

- Used to hold the flywheel gear for removing and installing the crankshaft pulley center bolt.
- Applicable: BENZ M651.
- MM number: 651589024000.



**JTC AUTO TOOLS USA**

678 - 876 - 3470

2600 NORTHLAKE DR., SUITE F,  
SUWANEE, GA, 30024



**JTC-4241 BMW FUEL INJECTOR INSTALL & REMOVE TOOL (N55)**

- Special designed to install and remove the injector in N55 engine.
- Applicable: BMW N55 engine.



**JTC-4242 BMW REAR SUSPENSION BUSH REMOVER / INSTALLER KIT (E87, E90)**

- Extractor for replacement of the rear suspension mounting bushes.
- Replacement of the mounting bush without completely lowering the rear axle assembly.
- Applicable: BMW E87, E90



**JTC-4243 BENZ AMG ENGINE TIMING TOOL SET (M156)**

- Used to fix and align the camshaft in correct timing angle when replacing the timing belt.
- Applicable: BENZ AMG 156.ML 63, S63L, S63, R63, E63, CLS63, and CLK63
- MM number: 156589006100, 156589003200



**JTC AUTO TOOLS USA**  
 678 - 876 - 3470  
 2600 NORTHLAKE DR., SUITE F,  
 SUWANEE, GA, 30024



**JTC-4263 BENZ GLOW PLUG REMOVAL & REPAIR SET**

- Design to pull out the broken head glow plug on the engine.
- Applicable: Mercedes CDI engine OM 611, 612, 613, 646, 647 and 648 etc.



**JTC-4264 BENZ, BMW GUIDE RAIL PIN SLIDE HAMMER PULLER SET**

- Designed for extracting the rail pins with slide hammer from cylinder head while out of the car.
- Applicable:  
M102.92/93/96/98, 103, 104, 110/92/98/99, 111, 116, 117, 119, 120, 155, 156, 272, 275, 285, 601, 602.91/93/94/96, 603.91/93/96/97, 602.983, 615, 616, 617.91/95, 606, 602.981, 612.965, 628, 640, 642.

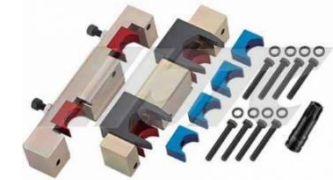

**JTC-4266 BENZ TIMING TOOL SET (M270)**

- Special designed to position the camshafts in TDC position.
- Applicable: 1.6L, V4 engine, A class and B class.

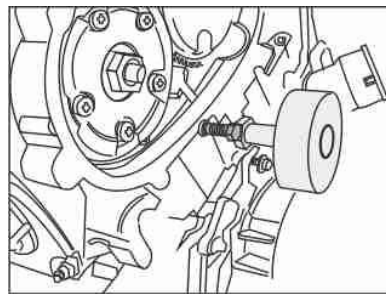

**JTC AUTO TOOLS USA**

678 - 876 - 3470

2600 NORTHLAKE DR., SUITE F,  
SUWANEE, GA, 30024



**JTC-4271 BMW ELECTRICAL FUEL PUMP REMOVAL AND ASSEMBLE TOOL SET**

- Special designed for releasing electrical fuel pumps from their mountings, and the easy insertion into their sleeve.
- Applicable: BMW E39 (520i, 523i, 525i, 528i, 530i, 535i, 540i) fuel pump.



**JTC-4276 BMW EXHAUST CAMSHAFT BEARING STRIP LOCKING TOOL**

- For locating upper and lower bearing strip when installing exhaust camshaft.
- Contents:
  - 6 pcs thrust tool
  - 2 pcs m7 screws
  - 1 pc press tool
- BM number: 114460



**JTC-4280 BMW TIMING TOOL SET (N20)**

- Designed for fixing the camshaft in TDC position.
- Use the tool to dismantle and assemble intake and exhaust camshaft.
- Applicable: BMW N20, N26 engine
- BM number: 83 30 2 212 831, 83 30 2 212 830, 83 30 2 219 548, 119340

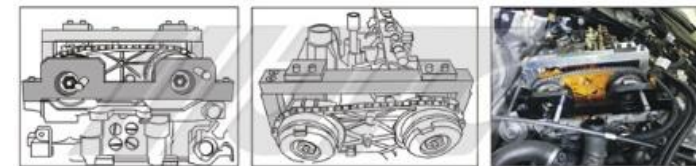

VIDEO OF INSTRUCTION



**JTC AUTO TOOLS USA**

678 - 876 - 3470  
 2600 NORTHLAKE DR., SUITE F,  
 SUWANEE, GA, 30024



**JTC-4281 BMW TIMING TOOL SET (N13, N18)**

- Designed for fixing the camshaft in TDC position.
- Use the tool to dismantle and assemble intake and exhaust camshaft.
- Applicable: BMW N13, N18 engine
- BM number: 117440, 119340, 496709, 119590



**JTC-4293 BMW MINI TIMING BELT PULLEY INSTALLER / REMOVER**

- Special designed to install and extract the crankshaft pulley.
- Applicable: BMW MINI COOPER R53 / W11



**JTC-4298 BMW VALVE PRESSURE SPRING INSTALLER / REMOVER (N20 / N55)**

- Special designed to remove and install the pressure spring on intermediate lever.
- Applicable: BMW N13, N20, N26, N55.
- BM number: 117110

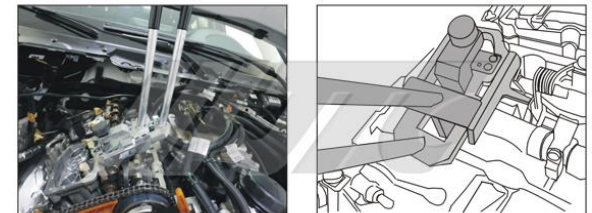

VIDEO OF INSTRUCTION



**JTC AUTO TOOLS USA**

678 - 876 - 3470  
 2600 NORTHLAKE DR., SUITE F,  
 SUWANEE, GA, 30024





**JTC-4299 BMW ENGINE TIMING TOOL SET (S85)**

- Designed for fixing the camshaft in TDC position.
- Use the tool to dismantle and assemble intake and exhaust camshaft.
- Applicable: BMW: S85 engine on E60/ M5, E63/ M6.
- BM number: 115300, 115320, 118380, 115410, 115100.

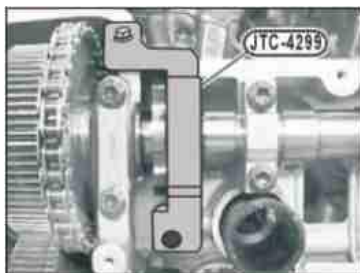

**JTC-4301 BMW REAR LOWER CONTROL ARM BUSH INSTALLER / REMOVER (E90)**

- On car maintenance.
- Specially designed for replacement of the rear suspension differential bush.
- Applicable: BMW: E87, E90, E93, and M3.
- Rubber mount number: 33326763092, 110867-10.
- Bush number: 26643676.



INSTALL



REMOVE



**JTC-4318 BMW WHEEL SCREW LOCK SOCKET SET**

- Operate with 17mm socket.
- Contents: #30(13PT), #31(15PT), #32(16PT), #33(17PT), #34(18PT), #35(19PT), #36(20PT), #37(21PT), #38(22PT), #40(23PT).
- Applicable for installing and removing locks of most BMW models.



**JTC AUTO TOOLS USA**

678 - 876 - 3470

2600 NORTHLAKE DR., SUITE F,  
SUWANEE, GA, 30024



**JTC-4333 BENZ INJECTOR REMOVER (M271)**

- Specially designed for removing the injector by slide hammer or the T bar.
- Applicable: BENZ M271 engine after 2007.
- MM number: 271589023300

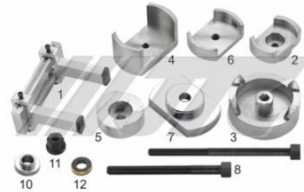
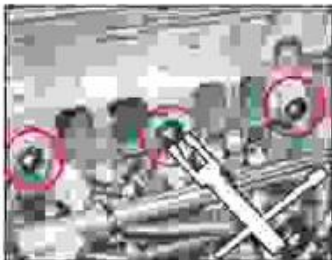

**JTC-4334 BENZ SUB-FRAME BUSH INSTALLER / REMOVER (W204)**

- Removal and installation of rear rubber mounts of axle suspension.
- Applicable: BENZ W204, W207, W212, W218, W231
- MM number: 2045890043



VIDEO OF INSTRUCTION



INSTALL



REMOVE



**JTC-4335 BMW TIMING TOOL SET(S65)**

- To locate the camshaft in TDC position and correct the VANOS angle.
- Applicable: BMW E90/M3, E92/M3, with S65 engine.
- BM number: 119970, 115290, 115320, 115370.

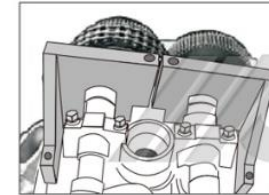

VIDEO OF INSTRUCTION



**JTC AUTO TOOLS USA**

678 - 876 - 3470

2600 NORTHLAKE DR., SUITE F,  
SUWANEE, GA, 30024



**JTC-4336 BMW FUEL INJECTOR INSTALL & REMOVAL TOOL (N20, N55)**

- Special designed to install and remove the injector in N20, and new N55 engine
- Applicable: BMW N20, N52.
- BM number: 130320



**JTC-4337 BENZ DIFFERENTIAL BUSH INSTALLER / REMOVER (W212)**

- For replacement of the rear sub-frame differential metallic bush.
- Applicable: BENZ: W204, W207, W212, W216, and W218.
- MM number: 204589014300, 221589014300.



**JTC-4338 BENZ BRAKE SOCKETS (H11)**

- Special designed to replace the brake lining.
- Size: 1/2" DR x H11 x 90L.
- Applicable: BENZ, W166.

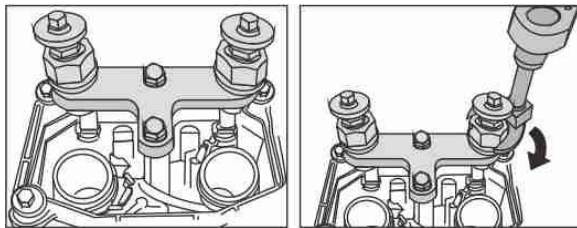

INSTALL

REMOVE



**JTC AUTO TOOLS USA**

678 - 876 - 3470

2600 NORTHLAKE DR., SUITE F,  
SUWANEE, GA, 30024



**JTC-4345 BMW VALVE PRESSURE SPRING INSTALLER / REMOVER (N42 / N46)**

- Specially designed for removing and installing pressure spring on intermediate lever.
- Applicable: BMW N42, N46
- BM number: 119390.

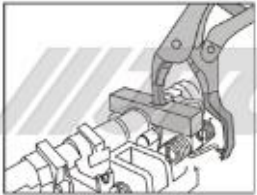

VIDEO OF INSTRUCTION



**JTC-4350 BMW TIMING TOOL SET (N51, N52, N53, N54, N55)**

- Installing and removal of camshaft/ variable camshaft timing unit.
- Checking and adjustment of timing.
- Applicable: BMW N51, N52, N53, N54, N55 engine.



**JTC-4368 BMW CRANKSHAFT SEAL INSTALL / REMOVAL (N55)**

- Specially designed to install and remove the front crankshaft seal in BMW N55 engine.
- Applicable: BMW N55 engine.
- BM number: 110370/119230
- Oil seal number: 7593353-05



Oil seal



**JTC AUTO TOOLS USA**

678 - 876 - 3470

2600 NORTHLAKE DR., SUITE F,  
SUWANEE, GA, 30024



**JTC-4373 BENZ SUBFRAME BUSH REMOVER / INSTALLER  
ACCESSORY KIT**

- Adding accessory M1 ~ M14 to apply with JTC-4820.
- It must operate with JTC-4820 series products.
- Increase the applicable for BENZ W204, W209, W212 and W221.



**JTC-4374 BENZ SUB-FRAME BUSH REMOVER / INSTALLER  
(HYDRAULIC)**

- Removing/installing safely and labor-saving by using hydraulic.
- The cylinder capacity will reach 15T when the pump with 10000psi (700lbs) power.
- With the adapter JTC-CP350.
- Pump is optional. (Proposal: JTC-HB600).
- Applicable: BENZ W203 / W204 / W209 / W211 / W212 / W220/W221.



**JTC-4375 BMW SUB-FRAME BUSH EXTRACTOR  
ACCESSORY KIT**

- Adding accessory B1~B15 to apply with JTC-4820.
- Must operate with JTC-4820 series products.
- Additional applicable vehicles: BMW E70 (front), E70 (rear), F01, F02, F07, F10, F11, F12, F13, F18, F20, F21, F22, F25, F30, F31, F32, F33, and F34.



**JTC AUTO TOOLS USA**

678 - 876 - 3470

2600 NORTHLAKE DR., SUITE F,  
SUWANEE, GA, 30024



**JTC-4376 BMW SUB-FRAME BUSH REMOVER / INSTALLER (HYDRAULIC)**

- Removing/ installing safely and labor-saving by using hydraulic.
- The cylinder capacity will reach 15T when the pump with 10000psi (700lbs) power.
- With the adapter JTC-CP350.
- Pump is optional. (Proposal: JTC-HB600).
- Applicable: BMW E31 / E32 / E34 / E39 / E53 / E60 / E65 / E66 / E70 / E87 / E90 / E91 / E93 / M3 / F01 / F02 / F07 / F10 / F11 / F12 / F13 / F18 / F20 / F21 / F22 / F25 / F30 / F31 / F32 / F33 / F34.



**JTC-4377 BMW TIMING CHAIN ADJUSTER (N63)**

- Specially designed to adjust the chain tightness for engine timing.
- Applicable: BMW N63, N74 engine.
- BM number: 83300496384

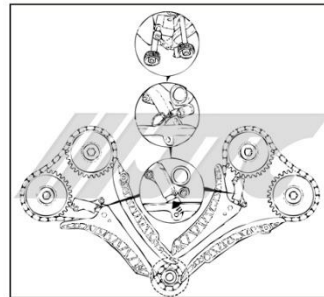

**JTC-4378 BMW CAMSHAFT ALIGNMENT TOOL (S63)**

- Specially designed to locate the camshaft in TDC position.
- Checking and adjusting the timing chain tensioner.
- Applicable: BMW S63 engine on F10/M5 (10 ~), F06/M6 (11 ~), F12, 13/M6 (11 ~), E70/X5M (08 ~ 13), E71/X6M (08 ~ 13).
- BM number: 2249117, 2249140, 2249144, 2249159, 2249162, 118570, 119190

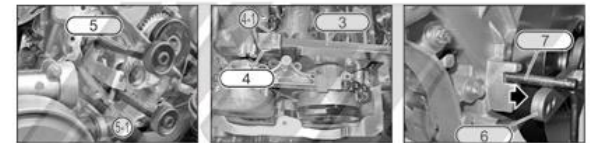

**JTC AUTO TOOLS USA**

678 - 876 - 3470

2600 NORTHLAKE DR., SUITE F,  
SUWANEE, GA, 30024



**JTC-4384 BMW V-BELT INSTALLATION TOOL (N52K)**

- Specially designed for installing the V-belt without causing damage.
- Applicable : BMW N52K engine (2006 ~ 2010)
- BM number : 111241, 111242



**JTC-4392 BMW WHEEL SCREW LOCK SOCKET SET (20 PCS)**

- This tool enables you to permit servicing of customer vehicles, even customer has lost the key.
- Applicable for installing and removing locks of most BMW models.
- Contents: #41, #42, #43, #44, #45, #46, #47, #48, #49, #50, #51, #52, #53, #54, #55, #56, #57, #58, #59, #60.



**JTC-4395 BMW DUAL CLUTCH INSTALLER / REMOVER**

- Specially designed to remove and install the dual clutch.
- Applicable for BMW GS7D36SG (DKG) transmission.
- BM No.: 230400.



VIDEO OF INSTRUCTION



**JTC AUTO TOOLS USA**

678 - 876 - 3470  
 2600 NORTHLAKE DR., SUITE F,  
 SUWANEE, GA, 30024



**JTC-4396 BMW MINI VALVE PRESSURE SPRING  
INSTALLER / REMOVER (N18)**

- Specially designed to remove and install the pressure spring on intermediate lever.
- Applicable:  
BMW MINI N12, N16, N18; PEUGEOT 207, 308, EP6 engine.
- BM No.: 119571/ 119572.



**JTC-4404 BMW INJECTOR REMOVER / INSTALLER (NEW N63)**

- Specially designed to install and remove the injector in N63 engine
- Applicable: BMW S63, N63 engine after 2012.
- BM number: 83302249115.

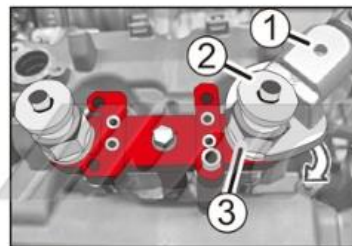

**JTC-4410 BENZ DIESEL INJECTION PUMP SOCKET**

- For installing and removing the pressure value holder of the MRSF-ERE injection pump Mercedes-Benz diesel engine: 601, 602, 603, 605, 606, 615, 616, and 617.
- Size: 1/2" DR x 33 PT, 56L.



**JTC AUTO TOOLS USA**

678 - 876 - 3470  
2600 NORTHLAKE DR., SUITE F,  
SUWANEE, GA, 30024





**JTC-4413 BENZ TIMING TOOL SET (M274)**

- Specially designed to position the camshaft in TDC position.
- Applicable: 1.6L, V4 engine, A class and B class.
- Applicable: NEW M270, M133, M274 engine.
- MM number: 270 589 01 6100.



**JTC-4414 BENZ DIESEL COMBUSTOR SOCKET (58T)**

- Applicable: MERCEDES BENZ C, E, G, S, V class. SPRINTER, T1. PORSCHE, RENAULT, SSANGYONG, TOYOTA, VOLKSWAGEN, VOLVO, ALFA ROMEO, AUDI, CITROEN, JEEP, LANCIA, etc.



**JTC-4415 BMW INJECTOR REMOVER (N53, N54)**

- Specially designed to install and remove the injector in N53, N54, and N43 engine.
- Use with M8 x 1.25 slide hammer. Optional JTC-4893 slide hammer set is available.
- Applicable: BMW N53, N54, N43 engine.
- BM number: 130180.

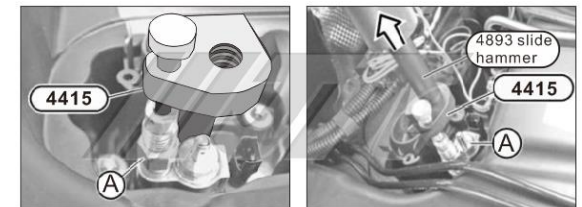

A:injector

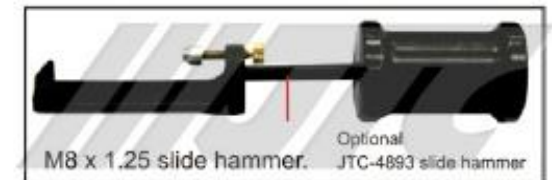

**JTC AUTO TOOLS USA**

678 - 876 - 3470  
2600 NORTHLAKE DR., SUITE F,  
SUWANEE, GA, 30024



**JTC-4416 MINI COOPER SERPENTINE BELT TOOL  
(N12, N14, N16, N18)**

- Each set comes with a one large and one small 12 point wrench.
- Size: 30mm/12PT, 21mm/12PT.
- Applicable: all 2007 and newer Mini Cooper N12, N14, N16 and N18 engines.
- BM number: 116210.

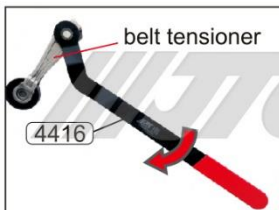
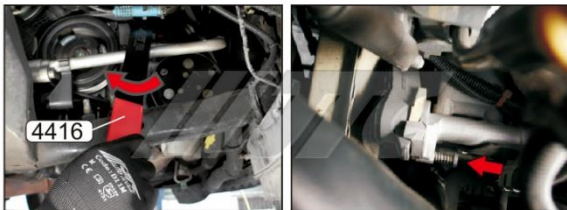

VIDEO OF INSTRUCTION



**JTC-4419 BMW, LAND ROVER FUEL TANK LID REMOVER**

- Used to remove the fuel tank lid.
- Used with 1/2" Dr. tool or 21 mm wrench.
- Applicable:  
BMW and Mini Cooper Model: 1988-2011 E31, E34, E36, E38, E39, E46, E53, E60, E63, E64, E65, E83, E85, E90, R50, R52, R53, R55, R56 and R57.  
Land Rover Model: LT - Discovery 2, LP - Range Rover, LN - Freelander, LM - New Range Rover, LJ - Discovery series 1, LD - Defender 07MY.
- BM number: 161028.
- LM number: 310-118.



**JTC-4429 BENZ DIESEL TIMING TOOL SET (M642)**

- Specially designed to align the camshaft timing angle for correct position.
- Applicable: BENZ M642 CDI engine.
- MM number: 642 589 00 31 00.



**JTC AUTO TOOLS USA**

678 - 876 - 3470  
2600 NORTHLAKE DR., SUITE F,  
SUWANEE, GA, 30024



**JTC-4430 BMW CRANKSHAFT PULLEY HOLDER (N47)**

**JTC-4431 BMW EXHAUST CAMSHAFT HOLDER INSTALLER / REMOVER (N54)**

**JTC-4432 BMW DIFFERENTIAL REAR BUSH EXTRACTOR (F01, F06, F10)**

- Use for aligning and holding the angle of the crankshaft and pulley while installing and removing the crankshaft pulley.
- Applicable: BMW N47, N57 engine.
- BM number: 117220.

- For locating upper and lower bearing strip when installing exhaust camshaft.
- Applicable: BMW N53, N54, N54T.
- BM number: 118550

- On car maintenance.
- To extract and install rear sub-frame and differential bush.
- Applicable: BMW 5, 6, 7 series F01, F02, F04, F06, F07, F10, F11, F12, F13, F18.
- BM number: 330 030 (330 031, 330 032, 330 033, 330 034, 330 035, 330 036).

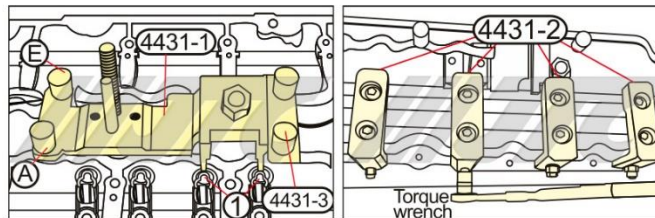

**JTC AUTO TOOLS USA**  
 678 - 876 - 3470  
 2600 NORTHLAKE DR., SUITE F,  
 SUWANEE, GA, 30024



**JTC-4441 BMW DIFFERENTIAL FRONT BUSH EXTRACTOR** **JTC-4442 BMW SUB-FRAME BUSH INSTALLER / REMOVER (F SERIES)**  
(F01, F06, F10)

- On car maintenance.
- To extract and install the front sub-frame and differential bush.
- Applicable: BMW 5, 6, 7 series F01, F02, F04, F06, F07, F10, F11, F12, F13, F18.
- BM number: 330 020.



- Replacement of the mounting bush without completely removing the rear axle assembly.
- Pump is optional. (Suggest JTC-HB600)
- The cylinder capacity will reach 13T when the pump with 10000psi (700lbs) power.
- Applicable: BMW 5, 6, 7 series F01, F02, F04, F06, F07, F10, F11, F12, F13, F18.
- BM number: 330011, 330012, 334140, 330000, 2208577, 2208574.

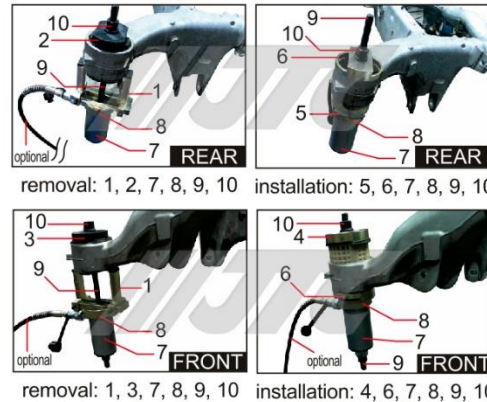

**JTC-4443 BMW INJECTOR REMOVER (N63)**

- Use for removing the BMW injector.
- Applicable: BMW S63, N43 engine, N63 (2008 ~ 2012).
- BM No.: 130300.



**JTC AUTO TOOLS USA**  
678 - 876 - 3470  
2600 NORTHLAKE DR., SUITE F,  
SUWANEE, GA, 30024



**JTC-4444 BMW VALVE SLIDER HOLDING PLIER (N18)**

**JTC-4447 BMW EXHAUST CAMSHAFT HOLDER (GENERAL TYPE)**

**JTC-4448 BMW CRANKSHAFT TIMING TOOL SET (N47)**

- Use for installing the valve slider.
- Applicable :  
BMW MINI N12, N16, N18.  
PEUGEOT 207, 308, EP6 engine.
- BM number: 119573.

- For locating upper and lower bearing strip when installing exhaust camshaft.
- Applicable: BMW N51, N52, N53, N54, N54T, N55.
- BM number: 114462, 114463, 118550, 117100.

- Use to align the balance shaft and crankshaft timing position.
- Applicable: BMW N47/N47S/N57 diesel engine.
- BM number: 118750, 118790.

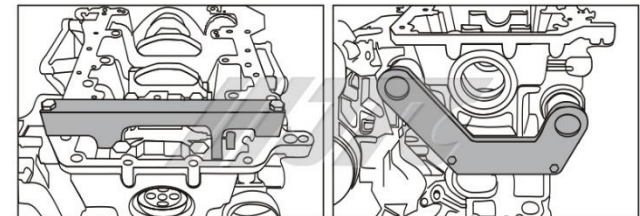
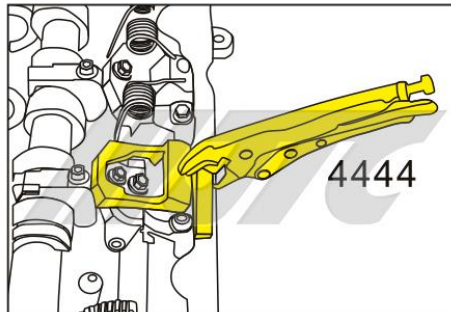

**JTC AUTO TOOLS USA**

678 - 876 - 3470  
2600 NORTHLAKE DR., SUITE F,  
SUWANEE, GA, 30024



**JTC-4451 BENZ FUEL NOZZLE REMOVER (M276)**

- Specially designed for removing the injector by slide hammer or the T bar.
- Applicable: BENZ M133, 152, 157, 270, 274, 276, 278 engine.
- MM number: 278 589 00 33 00.



**JTC-4463 BMW REAR DRIVE AXLE DIFFERENTIAL INSTALLER / REMOVER SET**

- This tool is designed for installing and removing the screw nut between rear drive axle and the differential, also can be used to replace the seal of the differential shaft.
- Applicable: BMW RWD and 4WD series.
- BM number: 335040. 335050. 335060. 335080.230020.
- Patented.



**JTC-4464 BMW COMBINATION FUEL INJECTOR REMOVER**

- Designed for removing the fuel injector.
- Applicable: BMW N55 (old), N55 (new), N63 (new), N20, N53, N54, N47, N57.
- BM number: 130180, 130270, 130320, 135250, 83302249115.



**JTC AUTO TOOLS USA**

678 - 876 - 3470

2600 NORTHLAKE DR., SUITE F,  
SUWANEE, GA, 30024



**JTC-4476 BENZ INTERIOR CHAIN LINK REMOVER / INSTALLER (DUAL SIZE)**

- Specially designed for replacing the interior chain, can install and feed the new chain to replace the broken chain and also revert.
- This tool can be used on single or dual row interior chain, the connecting hole can be both  $\varnothing$  3.1 and  $\varnothing$  4.4.
- Applicable for BENZ petrol and diesel engine.



**JTC-4481 BMW MINI FUEL LINE TUBE REMOVER**

- Specially designed to remove the fuel line from the high pressure fuel pump.
- Use this tool with caution; misuse could result in damage to the quick connect coupler.
- BM number: 130250



**JTC-4496 BMW TRANSMISSION CLUTCH CENTER ALIGNER**

- For centering the clutch disc on the flywheel when installing SAC.
- Also can be used on aligning new or pretension SAC clutches.
- Applicable:  
BMW transmission:  
S5D/ 200G, 250G, 260Z, 310Z.  
S6S/ 420G, 560G.  
GS6/37BZ, 37DZ, 53BZ, 53DZ.
- BM number: 212140, 212200, 212250, 212230.

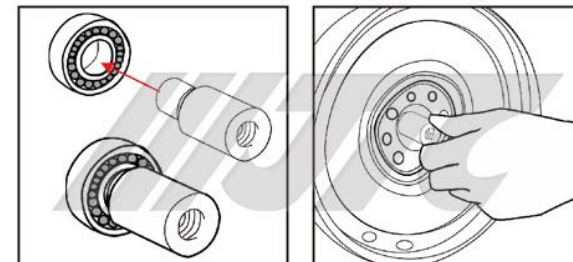

**JTC AUTO TOOLS USA**

678 - 876 - 3470  
2600 NORTHLAKE DR., SUITE F,  
SUWANEE, GA, 30024



**JTC-4498 BMW CRANKSHAFT REAR OIL SEAL KIT  
(N54, N55)**

- Must use with JTC-4209.
- Use for installing the crankshaft new rear oil seal.
- Applicable: BMW N54 (after Sep. 2008), N55 engine.
- BM number: 119185.

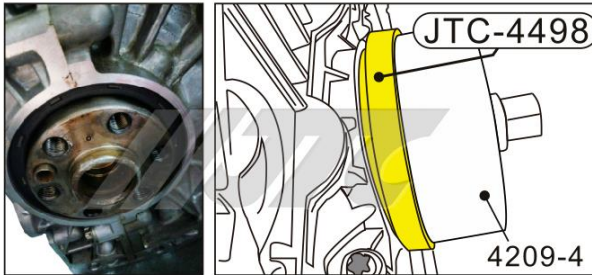

**JTC-4512 BENZ DISTANCE SENSOR SOCKET**

- Specially designed for removing and replacing the distance sensors in the front and rear bumpers.
- Can also be used to mount the sensor with the correct tightening torque.
- Applicable: BENZ S-class (W140) and E-class (W210).
- Size: 3/8" DR x PCD 45mm x Ø 6mm/ 4PT



**JTC-4521 BENZ CAMSHAFT HOLDING TOOL (M272, M273)**

- Specially designed to hold the camshaft and prevent it from rotating.
- Applicable: BENZ M272 and M273 engine.



**JTC AUTO TOOLS USA**

678 - 876 - 3470

2600 NORTHLAKE DR., SUITE F,  
SUWANEE, GA, 30024





**JTC-4527 BMW EXHAUST CAMSHAFT HOLDER INSTALLER / REMOVER (N55)**

- For locating upper and lower bearing strip when installing exhaust camshaft.
- Applicable: BMW N55, S55.
- BM number: 117100



**JTC-4529 10 PCS DIESEL INJECTOR REMOVAL ADAPTER SET**

- Specification of the screw connection tooth: M18 x 1.5
- Recommend to use with the JTC-4530 sliding hammer set.
- Contents :
  - 6 pcs Adaptor: M14 x 1.5 for Delphi, M17 x 1.0 for Bosch, M18 x 1.5 for universal, M20 x 1.0 for Denso, M25 x 1.0, M27 x 1.0 for Siemens.
  - 1 pc Socket: 1/2"Dr. x H10.
  - 3 pcs Puller: 12mm for Mercedes CDI (A class, Sprinter, Vito).
  - 13mm for Mercedes CDI engine OM 611,612, 613, etc.
  - 16mm for Citroen, Fiat, and Peugeot.



**JTC-4530 SLIDING HAMMER TYPE REMOVER**

- Front screw: M 18 x 1.5P
- Length: 480mm.
- Hammer weight: 4kg.
- Use with JTC-4529.



**JTC AUTO TOOLS USA**

678 - 876 - 3470

2600 NORTHLAKE DR., SUITE F,  
SUWANEE, GA, 30024



**JTC-4531 BMW MINI DIESEL TIMING TOOL SET (W16D)**

- Specially designed for replacing the timing belt on W16D engine.
- Applicable: BMW MINI, CITROEN, PEUGEOT (1.6 diesel engine).
- BM number: 119790, 110300, 119851, 119852.



**JTC-4543 BENZ COMBINATION TIMING TOOL SET (M651)**

- Specially designed for aligning the camshaft, loosen and insert the sprocket, and rotating the crankshaft.
- Applicable: BENZ M651.



**JTC-4546 BENZ BELT RELEASE TOOL**

- Designed to relieve pressure on the timing belt by pushing back the automatic idler pulley.
- Capable to use in the limited space to change the belt.
- Applicable: BENZ OM601 , OM602

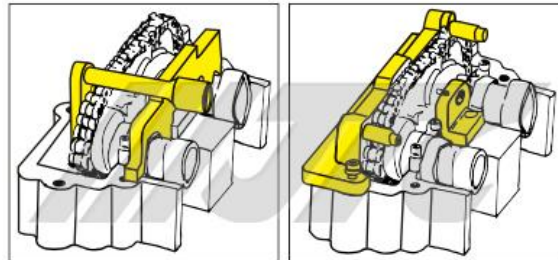

**JTC AUTO TOOLS USA**

678 - 876 - 3470

2600 NORTHLAKE DR., SUITE F,  
SUWANEE, GA, 30024



**JTC-4549 BMW RADIATOR LID WRENCH**

- Designed to remove the BMW radiator lid.
- By using this tool can prevent damage to the lid when install or remove it.
- Applicable: BMW vehicle since 2006.
- Size: 3/8" Dr. x 3PT



**JTC-4552 2 PCS BMW OIL TUBE DISCONNECTORS**

- Made of anodized aluminum.
- Applicable:  
 Red: BMW 3-series and X5 from 1995 - 2005.  
 Blue: BMW 3-series from 2006 - 2011, and X3 from 2006 - 2009. (E90 & E83)

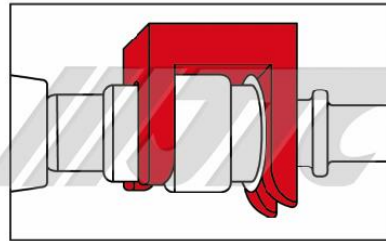

**JTC-4558 BMW CRANKSHAFT OIL SEAL COMBINATION KIT**

- Use for removing and installing the front & rear oil seal of the crankshaft.
- Applicable: BMW N40, N42, N45, N45T, N46, N46T, N52, N53, N54, N55.
- BM number: 119181 ~ 119185, 119220, 119230, 110370.



**JTC AUTO TOOLS USA**  
 678 - 876 - 3470  
 2600 NORTHLAKE DR., SUITE F,  
 SUWANEE, GA, 30024



**JTC-4618 CAMSHAFT ALIGNMENT TOOL (M47)**

- Distinctive design for correcting timing to be made when servicing BMW M47, M57 diesel engines.
- Applicable: BMW M47, M57 engines.



**JTC-4620 BMW SUSPENSION DIFFERENTIAL BUSH INSTALLER & REMOVER – E38 & E39**

- Special design to remove and install the front differential bush of E39 engine and rear differential bush of E38 & E39 engines.
- Applicable: BMW E39/E38 engines.

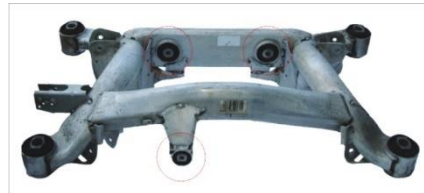

**JTC-4624 BMW TRANSMISSION RUBBER MOUNT BUSH INSTALLER & REMOVER X5**

- Special tool to replace the rubber mount of BMW X5 transmission.
- Applicable: BMW X5 3.0 before 2003.

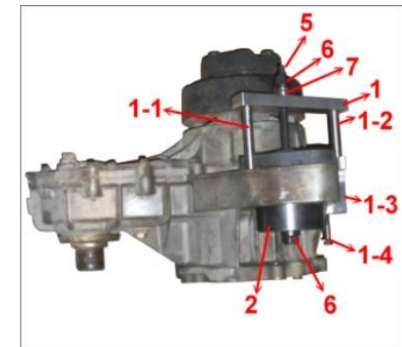

**JTC AUTO TOOLS USA**

678 - 876 - 3470

2600 NORTHLAKE DR., SUITE F,  
SUWANEE, GA, 30024



**JTC-4690 OIL DIPSTICK FOR BENZ TRUCK**

- Designed to measure the oil level of transmission.
- Applicable: BENZ truck.



**JTC-4691 IGNITION LOCK REMOVER**

- For removal & replacement of the ignition switch retaining.
- Applicable: W116, W123, W124, W126, W163, W170, W202, W210, etc.



**JTC-4692 BENZ REAR CRANKSHAFT RADIAL SEALING RING INSTALLER**

- The crankshaft radial sealing ring has both a lip and a protective lip.
- They cannot be damaged when assemble the cover to the crankshaft flange.
- This tool is designed to prevent damage when assemble the cover to the crankshaft flange.
- Applicable: BENZ M272, M271



1. Guide seal on the cover.



2. Take off the front part, and push the cover into the flange.



**JTC AUTO TOOLS USA**

678 - 876 - 3470  
 2600 NORTHLAKE DR., SUITE F,  
 SUWANEE, GA, 30024



**JTC-4693 BENZ ENGINE FIXING SCREWS WRENCH (16mm)**

- Special angle designed to remove the nuts from engine fixing screw without block.
- Use with 3/8" Dr. wrench, go-through type.
- Size: 16mm/12PT.
- Applicable: W220, 210, 203, 219, 221, 211, 204
- Patented.



**JTC-4694 BENZ ENGINE FIXING SCREWS WRENCH (17mm)**

- Special angle designed to remove the nuts from engine fixing screw without block.
- Use with 3/8" Dr. wrench, go-through type.
- Size: 17mm/12PT.
- Applicable: W140, 210, 202, 126, 124, 201, 170
- Patented.



**JTC-4709 BMW BALANCE AXLE ALIGNMENT TOOL**

- Plug in the tool for fixing the angle when you adjust the balance axle to the correct angle.
- Applicable : BMW-N40, N42, N45, N46.

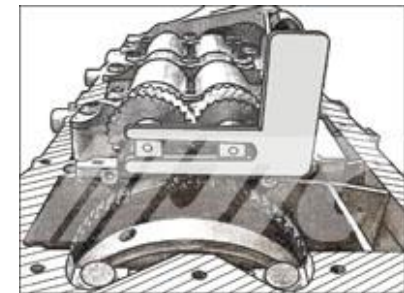

**JTC AUTO TOOLS USA**

678 - 876 - 3470

2600 NORTHLAKE DR., SUITE F,  
SUWANEE, GA, 30024



**JTC-4711 BENZ CONDENSER RESERVOIR SOCKET**

- This socket is used for screw plug removal and installation in fluid reservoir of condenser.
- Applicable: BENZ (W171.4 / W203 / W209)
- Size: 1/2" DR. HEX. 27mm
- MM number: 203589001000



**JTC-4720 BMW DIESEL INJECTION PUMP PULLER**

- This tool is specifically designed for holding the sprocket/ chain in place when disassembling the VP44 Injection pump and high-pressure pump common rail fitted to BMW engines.
- Applicable: BMW M47 / M47(TU) and M57 / M57(TU)
- Diesel engines in:  
 E46: 318D,320D,330.  
 E39: 525D,530D.  
 E38: 730D.  
 E60: 525D,530D,535D.  
 E61: 525D,530D,535D.  
 E53: X5 3.0D.

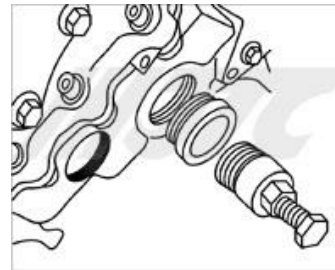

**JTC-4728 BENZ FRONT LOWER CONTROL ARM BALL JOINT REMOVER / INSTALLER**

- To remove and install front lower control arm ball joint with the special C clamp.
- Using on car.
- Applicable: BENZ W220, W211



**JTC AUTO TOOLS USA**

678 - 876 - 3470  
 2600 NORTHLAKE DR., SUITE F,  
 SUWANEE, GA, 30024



**JTC-4729 BENZ A/C LOW SIDE COUPLER REMOVER**

- Special designed to remove the low side coupler.
- Applicable: BENZ W221, W211, W204, W219.



**JTC-4732 BENZ FLYWHEEL LOCKING TOOL (M102)**

- Used to fix the flywheel gear to remove & install crankshaft pulley centre bolt.
- Applicable: BENZ M102, M103, M104, M111, M601, M602, M603, M605, M606, M611, M612, M613.



**JTC-4741 BMW TIMING TOOL N52**

- Special design for locking flywheel in TDC position.
- Turns crankshaft to TDC position while central bolt moves, and put the plug into calibrate hole to fix the crankshaft.
- Applicable: BMW N52.



**JTC AUTO TOOLS USA**

678 - 876 - 3470

2600 NORTHLAKE DR., SUITE F,  
SUWANEE, GA, 30024





**JTC-4759 BMW ENGINE TIMING TOOL SET**

- Installing and removal of camshaft / variable camshaft timing unit.
- Checking and adjustment of timing.
- Applicable:  
 Petrol: M40, M43  
 Twin camshaft: M42, M44, M50, M52, M52TU, M54, M56

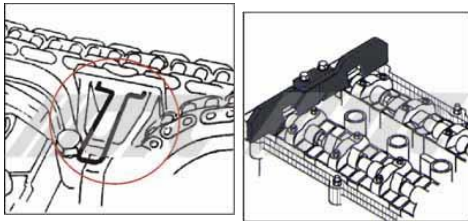

**JTC-4760 BMW DIESEL TIMING TOOL SET**

- Installing and removal of camshaft/variable camshaft timing unit.
- Checking and adjustment of timing.
- Applicable: M41, M51, M47 TU/T2, M57 TU/T2: 2.0L / 3.0L 1998 later.

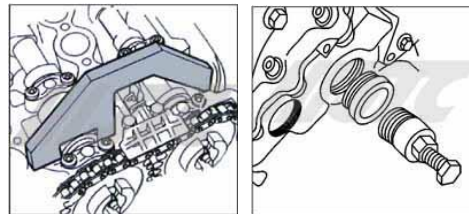

**JTC-4762 BMW, MINI TIMING TOOL W10, W11**

- Installing and removal of camshaft / variable camshaft timing unit.
- Checking and adjustment of timing.
- Engine code:  
 W10B16AA - 2001-06 Cooper  
 W10B16BA - 2001-06 Cooper S  
 W11B16AA - 2001-06 One



**JTC AUTO TOOLS USA**

678 - 876 - 3470

2600 NORTHLAKE DR., SUITE F,  
 SUWANEE, GA, 30024



**JTC-4803 MINI COOPER SERPENTINE BELT TOOL KIT**

- Use this wrench to loosen the camshaft pulley, and use the pin to lock the camshaft pulley tensioner at the same time, then remove the parts under the oil pan and the pulley.
- Applicable: BMW MINI COOPER (R50/R53), BMW engine W10/W11



**JTC-4804 MINI COOPER SERPENTINE BELT TOOL KIT**

- This tool is used on MINI COOPER serpentine belt.
- Applicable: BMW MINI COOPER S/W11 Engine.

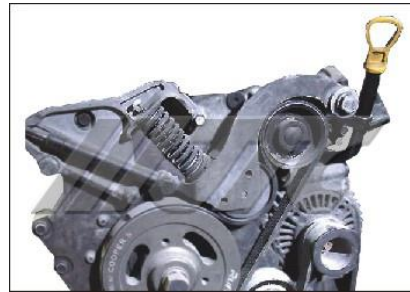

**JTC-4820 BENZ & BMW SUB-FRAME BUSH REMOVER / INSTALLER (HYDRAULIC)**

- Removing / installing safely and labor-saving by using hydraulic.
- Various parts for widely use.
- Pump is optional. (proposal: JTC-HB600)
- Applicable:  
 BENZ: W220, W211, W203  
 BMW: E31, E32, E34, E38, E39, E53, E60, E65, E66, E70
- The cylinder capacity will reach 15T when the pump with 10000psi(700lbs) power.
- With the adapter JTC-CP350.

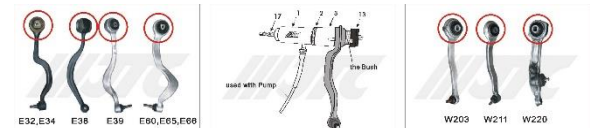

**JTC AUTO TOOLS USA**  
 678 - 876 - 3470  
 2600 NORTHLAKE DR., SUITE F,  
 SUWANEE, GA, 30024



**JTC-4822 BENZ UNIVERSAL HOSE CLAMP REMOVER**

- Special larger clamp capacity design for lower water hose clamp of BENZ serious etc.
- Max clamp capacity: 60 mm
- Hose clamp with flexible 600mm wire.
- Patented.



**JTC-4848 ENGINE TIMING TOOL SET – BENZ, CHRYSLER, JEEP**

- A timing tool set which covers a large of models in the Mercedes range including Petrol and Diesel engines.
- Set includes Flywheel Plate Locking Tools and Camshaft Locking Pin Set.
- Suitable for Chrysler PT Cruiser 2.2 CRD and Jeep Grand Cherokee 2.7CRD.



**JTC-4861 BMW OIL COOLER LINE PLIERS**

- Release the hydraulic cooling lines that connect to the transmission.
- Front clips fixed by screw could adjust the angle for use.
- Applicable: BMW E46, E53, E60, E61, E63, E64, E65, E66, E70, E81, E83, E85, E86, E87, E90, E91, E92, E93, R50, R52, R53, Rr1.

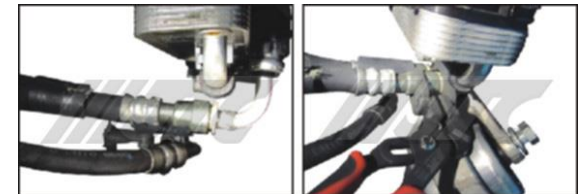

**JTC AUTO TOOLS USA**

678 - 876 - 3470

2600 NORTHLAKE DR., SUITE F,  
SUWANEE, GA, 30024



**JTC-4878 CDI-GLOW PLUG TOOL**

- For unscrewing and disassembly of glow plugs in the cylinder head, especially for glow plugs that are stuck because of carbonization remains.
- Cylinder does not need to be removed any more.
- Fits all Mercedes 10mm glow plugs, engine codes 611-612-613, etc.



**JTC-4889 BMW BALL JOINT SEPARATOR (E39)**

- Short main screw with inclined design to meet narrow space in BMW E39
- For splitting track-rod end, anti-roll bar mountings, and ball joints... etc.
- Jaw open: 24mm



**JTC-4894 BMW OUTPUT SHAFT PRYBAR 4WD**

- Special designed to remove the output shaft from the front transaxle assembly on 4WD vehicles.
- Applicable: BMW 525ix, X3, X5, etc.



**JTC AUTO TOOLS USA**

678 - 876 - 3470

2600 NORTHLAKE DR., SUITE F,  
SUWANEE, GA, 30024



**JTC-4896 BMW SELF ADJUSTING CLUTCH INSTALLER**

- Special designed to install and set self-adjusting clutches (SAC).
- Applicable: BMW E34, E36, E38, E39, E46, E52, E53, E85, and Z3.



**JTC-4897 BMW SELF ADJUSTING CLUTCH CENTERING TOOL**

- Special designed to reset and center the centering ring on self-adjusting clutches (SAC).
- Use with JTC-4896.
- Applicable: BMW E34, E36, E38, E39, E46, E52, E53, E85.



**JTC-4902 BMW WIPER LINKAGE ASSEMBLY SOCKET BIT (T80H)**

- Windshield wiper must be removed first.
- Size : 1/2"DR. x T80H; Length : 78mm
- Removal and install BMW wiper linkage assembly.
- Used in conjunction with JTC-4910.
- Applicable : E12, E21, E23, E24, E28, E30, E31, E32, E34, E36, E38, E39, E46, E52, E53, E60, E65, E66, E67, E85, PR1, etc.

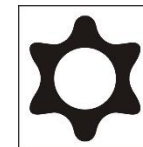

**JTC AUTO TOOLS USA**

678 - 876 - 3470

2600 NORTHLAKE DR., SUITE F,  
SUWANEE, GA, 30024



**JTC-4906 BMW (N53 / N54) CAMSHAFT FIXING BASE**

- Used to align the camshaft
- Applicable : BMW (N53/N54)



**JTC-4909 BMW SECONDARY CHAIN TENSIONER LOCKING TOOL SET (M62)**

- For fixing the camshaft chain tensioner.
- Applicable : BMW M60, M62 (VANOS)

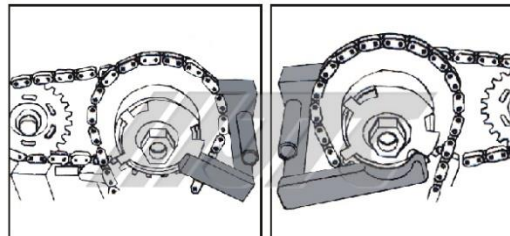

**JTC-4915 BMW MINI TIMING TOOL (N12, N14, N16)**

- The kit designed to set the twin camshaft on petrol engine of BMW MINI.
- Applicable:
  - BMW MINI COOPER 1.4, 1.6, 16V.
  - CITROEN C4, C4 Picasso.
  - PEUGEOT 207, 308.
  - BMW: N12 (1.4/1.6), N14 (1.6), and N16.
  - PAS: EP3, EP6 and EP6DT/DTS



VIDEO OF INSTRUCTION



**JTC AUTO TOOLS USA**

678 - 876 - 3470

2600 NORTHLAKE DR., SUITE F,  
SUWANEE, GA, 30024



**JTC-4924 BENZ, BMW BRAKE SOCKETS**

- Special designed to replace the brake lining.
- Applicable : BENZ, BMW, VW, AUDI, FORD, MAZDA, etc.
- 4924-1 : 3/8"DR x H7, Length : 36 mm
- 4924-2 : 3/8"DR x H9, Length : 92 mm



**JTC-1310A BENZ BALL JOINT INSTALLER / REMOVER**

- Specially design to remove and install the ball joint on car without removing any parts.
- Applicable: W220, W211, W203, W215.
- Patented.

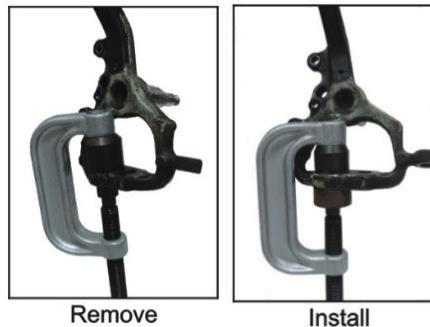

**JTC-1435A BMW CAMSHAFT ALIGNMENT TOOL (N62 / N73)**

- Applicable: BMW engine models N62 & N73.
- Use the tool to fix on the input/output crankshaft to adjust the interval of crankshaft.
- It could check the crankshaft interval (smaller than 0.5mm).
- Content:
  - Fixture A for input crankshaft x 1
  - Fixture B for output crankshaft x 1
  - Support with screw x 1



**JTC AUTO TOOLS USA**

678 - 876 - 3470  
 2600 NORTHLAKE DR., SUITE F,  
 SUWANEE, GA, 30024



**JTC-1555B BENZ ALIGNMENT TOOL SET (M271)**

- This retaining device makes it possible to position the camshafts in the installed position.
- Retainer to draw in the timing chain. To retain timing chain with camshaft sprockets in mesh.
- Part #2 is used for alignment, not for fixing the camshaft. After alignment, please use a 32mm wrench to fix the camshaft.
- Applicable: BENZ M271
- MM number:  
271589014000, #1  
271589006100, #2  
271589001500, #3  
271589003100, #4  
271589001600, #5



**JTC-1558A BMW TIMING TOOL SET 8 PCS (N42, N46, N46T)**

- Installing and removal of camshaft/variable camshaft timing unit.
- Checking and adjustment of timing.
- Applicable:  
E87:118i/120i-N46  
E46:316i/316ti/318i-N42  
E90/E91:318i/320i-N46  
E85:Z4,2.0L-N46

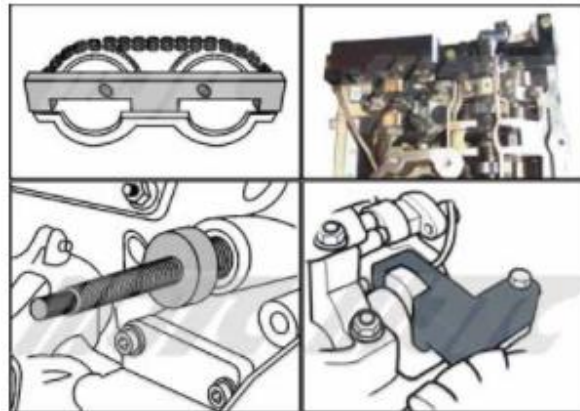

**JTC-4001A MINI COOPER CONTROL ARM BUSH REMOVER / INSTALLER (R50 / R53)**

- Specially designed for replacing the rubber mount (hydro-mounts) in left or right control arm.
- Applicable :  
BMW MINI COOPER R50, R53; engine model W10, W17, W11.

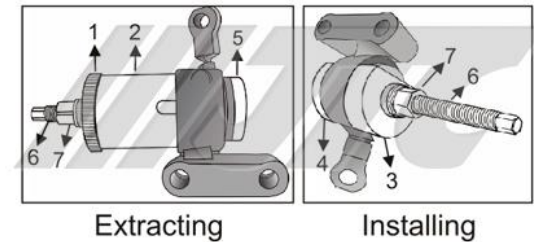

**JTC AUTO TOOLS USA**  
678 - 876 - 3470  
2600 NORTHLAKE DR., SUITE F,  
SUWANEE, GA, 30024





**JTC-4011A BMW A/C COMPRESSOR BELT INSTALLER N62**

- Designed to advance the belt into pulley of the compressor on BMW.
- Applicable : BMW N62/ W17
- BM number: 641040



**JTC-4187A BMW VALVE PRESSURE SPRING REMOVER / INSTALLER (N52 / N54)**

- Specially designed for removing and installing pressure spring on intermediate lever.
- Applicable: BMW N51, N52, N53, N54.
- BM number: 114270.

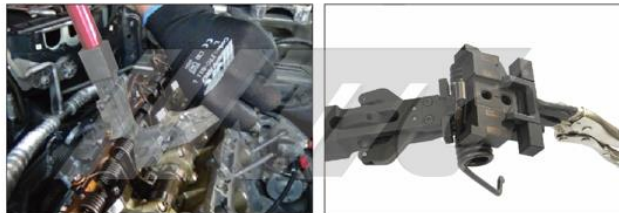

VIDEO OF INSTRUCTION



**JTC AUTO TOOLS USA**  
 678 - 876 - 3470  
 2600 NORTHLAKE DR., SUITE F,  
 SUWANEE, GA, 30024



**JTC-4231A BENZ, BMW FREE WHEEL TIRE AID**

- For inactive intelligent servo module (ISM) cause transmission failure actuation, also for tires which unable to be rotated.
- Install between the wheel and tire, so the tire can be rotated freely.
- Manpower push only, not driving or towing (limited to 5 km/h).
- Applicable:  
 BENZ- W164, W197, W204, W212, W221, W251  
 BMW-F01, F02, F07, F10, F11, F12, F13, F25, F30, F31, F32, F33, F34.
- MM Number: 164589036300.
- Patented.

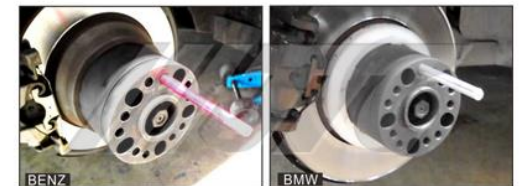



**JTC-4374A BENZ SUB-FRAME BUSH EXTRACTOR (SCREW)**

- The same function as JTC-4374 but with screw pivot.
- Change: JTC-4374 from #1 to #1A, from #17 to #17A
- Applicable: BENZ W203 / W204 / W209 / W211 / W212 / W220 / W221.



**JTC-4376A BMW SUB-FRAME BUSH REMOVER / INSTALLER (SCREW)**

- Change JTC-4376 #1 to 1A, #16 to #16A
- The same function as JTC-4376 but with screw pivot.
- Applicable:  
BMW E31 / E32 / E34 / E39 / E53 / E60 / E65 / E66 / E70 / E87 / E90 / E91 / E93 / M3 / F01 / F02 / F07 / F10 / F11 / F12 / F13 / F18 / F20 / F21 / F22 / F25 / F30 / F31 / F32 / F33 / F34.



**JTC-4413S BENZ TIMING TOOL SET (M270, M274)**

- Specially designed to position the camshaft in TDC position.
- Applicable: 1.6L, V4 engine, A class and B class.
- Applicable: Old/New M270, M133, M274 engine.
- MM number: 270 589 00 6100, 270 589 01 6100.



**JTC AUTO TOOLS USA**

678 - 876 - 3470

2600 NORTHLAKE DR., SUITE F,  
SUWANEE, GA, 30024



**JTC-4619A BMW CAMSHAFT ALIGNMENT TOOL (N52)**

- Specially design to locate camshaft in TDC position.
- Applicable: BMW N51, N52 engines.
- Engine N53, N54 needs another part JTC-4906.
- Engine N55 needs another part JTC-4347.

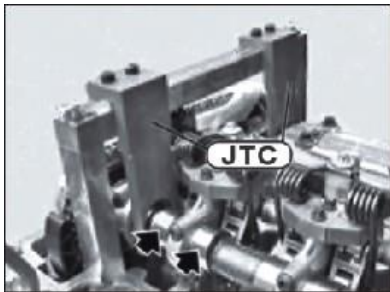

**JTC-4718A BENZ COMMON RAIL INJECTOR PULLER**

- For removing adapted tight common rail injectors without having to disassemble the cylinder head.
- Injection puller with impact hammer, injection nozzles that do not fit very tightly can be pulled out without needing to take them apart or remove the cylinder.
- Applicable: BENZ CDI 611, 612, 613, 646, 647, 648, etc. diesel engines.
- Contents: 3 adapters M17 x 1.0, M27 x 1.0 (Bosch), and M12 x 1.75.



**JTC-4727A BENZ COMPRESSOR BELT PULLEY WRENCH**

- Special tool for using on removing/ installing compressor belt.
- Special three-point design for suitable using on parts of the vehicles.
- Applicable: BENZ M112, M113, M272M M273.



**JTC AUTO TOOLS USA**

678 - 876 - 3470  
 2600 NORTHLAKE DR., SUITE F,  
 SUWANEE, GA, 30024



**JTC-4923S BMW COMBINATION TIMING TOOL SET (N47)**

**JTC-4941A BENZ, BMW, VOLVO FUEL TANK LID REMOVER**

- A combination tool set for installing and removing camshaft and variable camshaft timing unit, also for aligning the balance shaft and crankshaft timing position.
- Applicable: BMW N47 / N47S / N57 2.0 diesel engines.
- BM number: 115320, 116480, 118760, 118740, 113340, 114320, 118750, 118790.

- Special designed to remove fuel tank lid for diesel and petrol cars.
- Applicable :  
 BENZ: W204, 207, 212  
 BMW: F01, F02, F10, F12  
 VOLVO T4, T5 engine, 2010 later

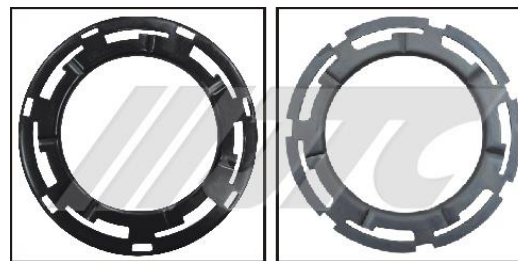
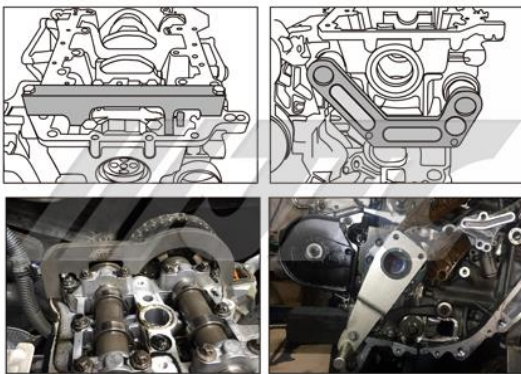

BENZ

BMW, VOLVO



**JTC AUTO TOOLS USA**

678 - 876 - 3470

2600 NORTHLAKE DR., SUITE F,  
 SUWANEE, GA, 30024