

REVISIONS				
ZONE	REV	DESCRIPTION	DATE	APPROVED

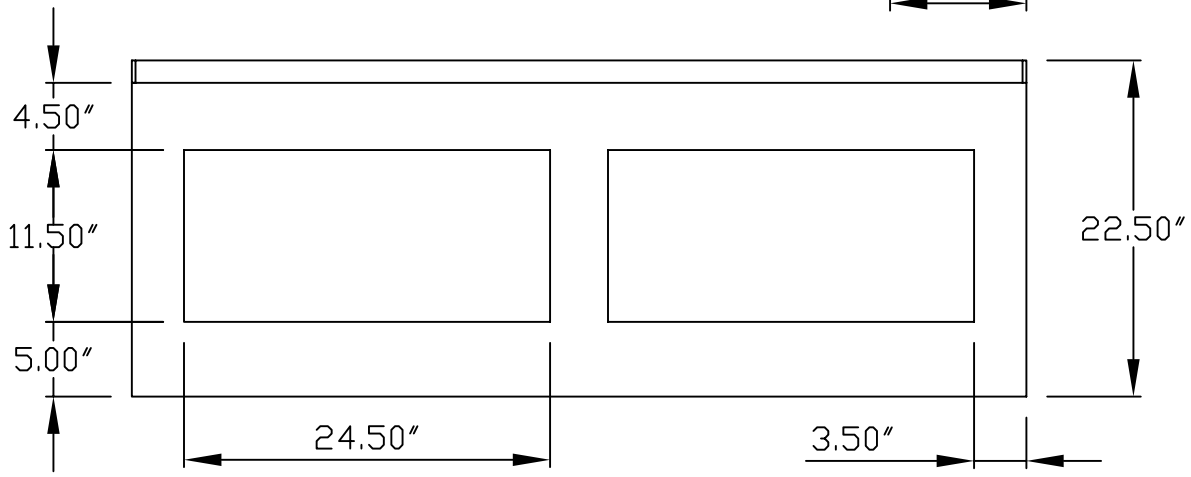
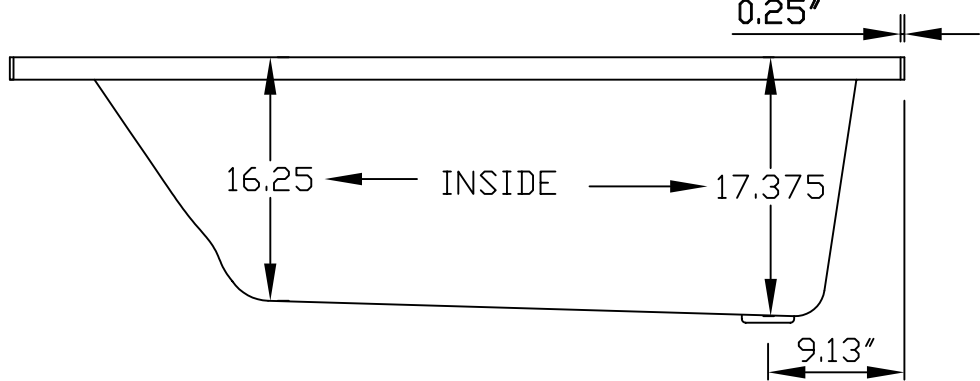
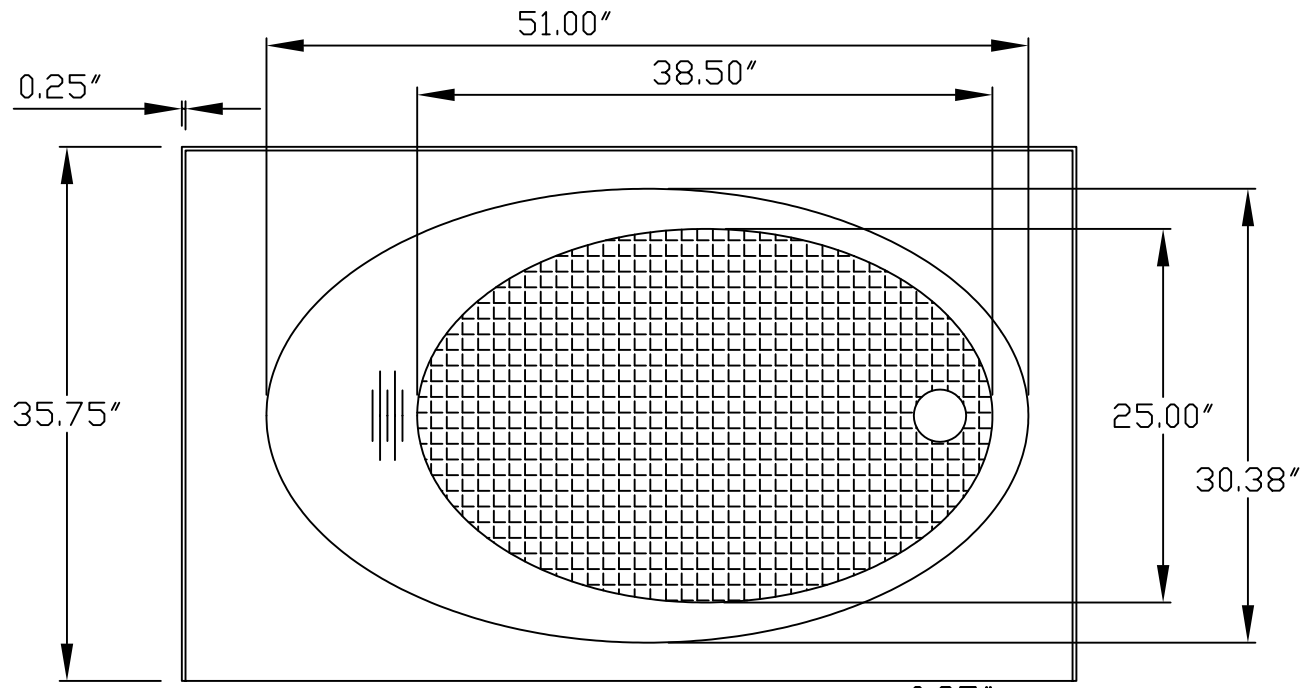

Quality Acrylic Baths

SIZE A	FSCM NO.	DWG NO. QAB MODEL 36-R	REV IR
SCALE		SHEET 1 OF 1	