

REVISIONS				
ZONE	REV	DESCRIPTION	DATE	APPROVED

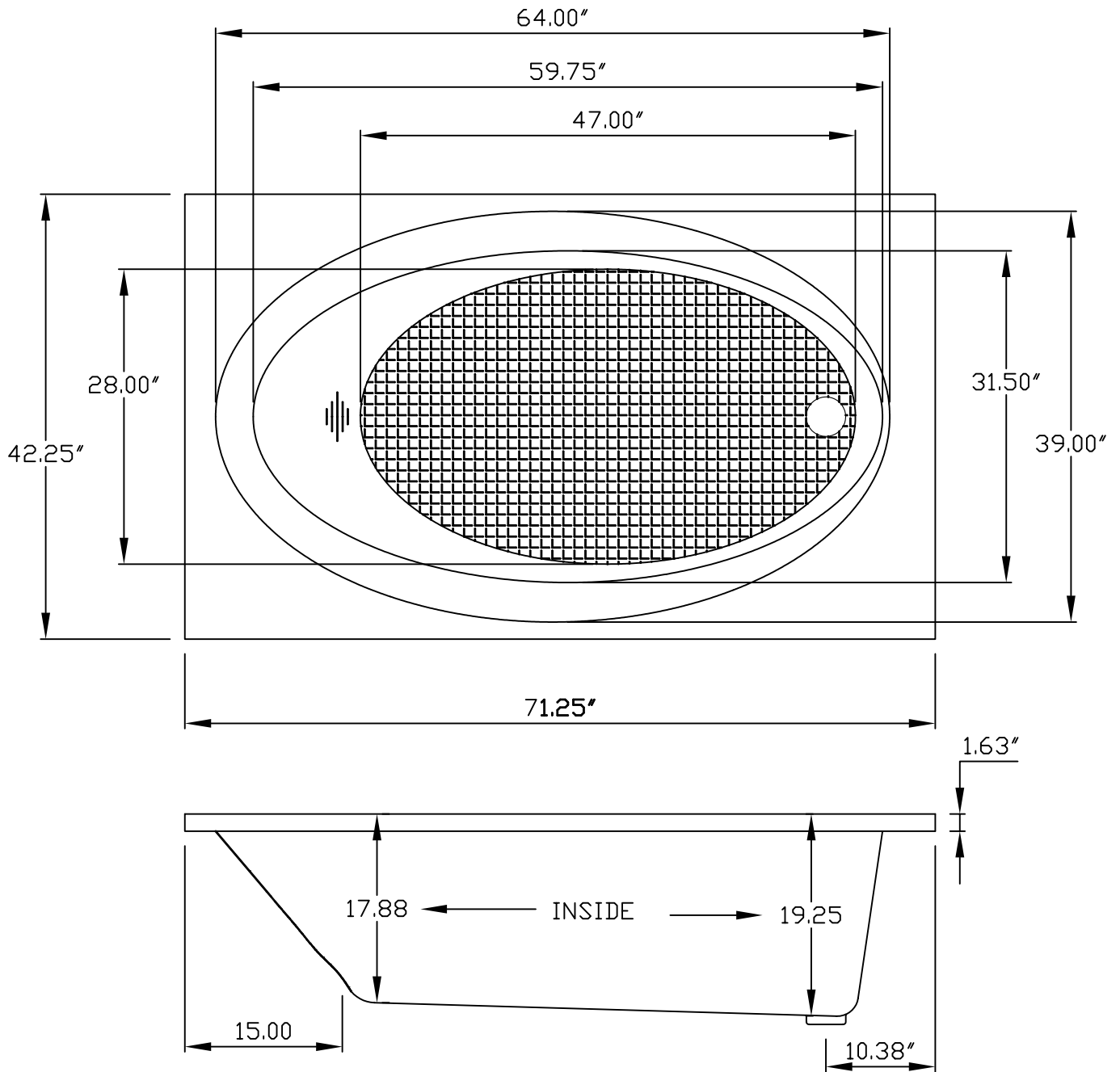

		<h1>Quality Acrylic Baths</h1>		
		SIZE A	FSCM NO.	DWG NO. <b>QAB MODEL 205</b>
		SCALE	SHEET 1 OF 1	