

**DWENGER/HESSLER
HISTORY BOOK**

INCLUDING HISTORIES ON THE
HAHN, NEINABER, RAVER, RUTT, SEIBEL,
STAHL, AND THOLE FAMILIES

Researched and Compiled by
Patty Carson

© Patty Carson, 1993. All rights reserved by the Author.

Patty Carson
5660 N. Finks Rd.
Osgood, IN 47037-8736
(812) 852-4948
pcarson@nalu.net

Digitized by Jesse W. Abell, 2009.
jesseabell@cantab.net

Second Printing by
Lulu, Inc.
Morrisville, North Carolina
www.lulu.com

HESSLER/DWENGER HISTORY BOOK

This book has been conceived through the combined efforts of many people who have put many hours of time into research, phone calls, typing and writing letters, and much more. I would like to thank everyone who has helped with the continuing research for information, and put up with my endless questions and letters. THANK YOU!

It was hard to decide exactly how to arrange the histories in this book, They cover such a wide span through history. The book is divided into two sections. they are Hessler's and Dwenger's. The family members from both families will be listed under their birth name.

The family histories are separated by the family graph chart for that name. I have tried to keep each family name together, but some will be in the book in two different places, but will be done in depth from the husbands family name.

The book is fully indexed, by last name, then first.

I sincerely apologize for any errors or omissions in the histories or in the typing, and I am sure there will be many. We also had a few reprinting errors by the computer when adjusting the fonts. I apologise for all these errors

I hope that everyone who reads this book enjoys the glimpse into the past, which is a part of each of our histories, whoever we are.

Patty Carson

compiled by Patty Carson
printed at T.J. printing in
Greensburg 1993

People and references and researchers, without whose help this book would never have been possible.

Charles hessler	Harold Dwenger
Robert Arrol, M.D.	Joe Dwenger
Anna McCullough	Clarence & Bessie Dwenger
Lucille Braun	Helen Stuhrenberg
Sister Margaret Mary	Mary(Hessler)Dwenger
Adele Porteck	Mary Ann Niese
Marie Monter	Mary Taylor
Mary Ellen Menkedick	Ralph Dwenger
Ferol Stahl	Ralph & Maxine Seibel
Juanita Dwenger	Dorothy schwegman
Debra McCullough	Donna Swinford
Steve Richards	Carolyn Richards
Patty Carson	Mark Carson
Ruth Griffith	Esther Martin
Debra Peetz	Harry McCullough
Bobbie Koors	Charles Thole
Margie Hahn	Paul Thole
Martha Stier	Moorman Church Lib.
Harold Peters	Betty Harris
Bill BarnHarst	Greg Harris
Joleen Conner	

TO FUTURE FAMILY HISTORY RESEARCHERS

No family History is ever totally complete. This book is the result of compiling together the work of many family researchers throughout the years. There is still much yet to be researched. So to all you future researchers, I do hope that this book will give you a good source from which to begin.

Patty Carson
5660 N. Finks Rd.
Osgood, Indiana 47037

<i>GRAPHS</i>	
<i>name</i>	<i>page</i>
<i>DWENGER</i>	<i>7, 8</i>
<i>DWENGER HARRY J.</i>	<i>91</i>
<i>HAHN</i>	<i>199</i>
<i>HESSLER</i>	<i>205, 206</i>
<i>HESSLER FRANK J.</i>	<i>257</i>
<i>LAMPING</i>	<i>335</i>
<i>MCCULLOUGH JOHN D.</i>	<i>135</i>
<i>MENKEDICK/WENNING</i>	<i>242</i>
<i>NIENABER</i>	<i>173</i>
<i>RAVER</i>	<i>159</i>
<i>RÜTT</i>	<i>352</i>
<i>SEIBEL</i>	<i>178</i>
<i>STAHL</i>	<i>320</i>
<i>STEFFENS</i>	<i>361</i>
<i>THOLE</i>	<i>334</i>

Germany

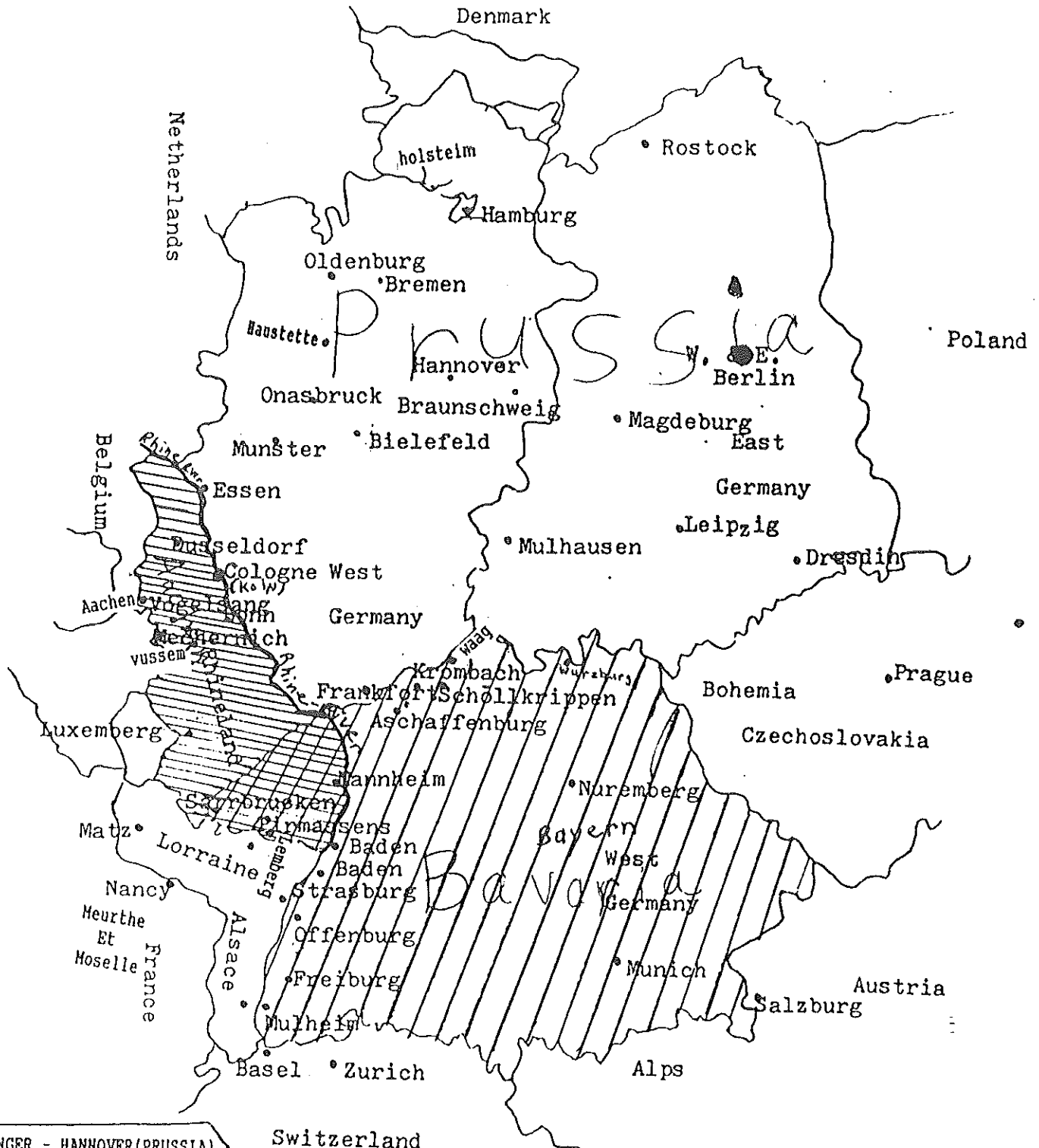

- DWENGER - HANNOVER (PRUSSIA)
- HESSLER - KROMBACH, SCHOLLKRIPPEN, WAAG (BAVARIA)
- THOLE - OLDENBURG, HAUSTETTE (PRUSSIA)
- STAHL - LEMBERG, PIRMASSENS (BAVARIA)
- RUTT - AACHEN, RHINELAND (PRUSSIA) VUSSEM
- STEFFENS - MECHERNICH, RHINELAND (PRUSSIA)
- LAMPING - ESSEN (PRUSSIA)
- RAVER - (PRUSSIA)
- NIENABER - HANNOVER (PRUSSIA)
- SEIBEL - RHINELAND (PRUSSIA)
- HAHN - BAVARIA (Bavaria) also some Heurthe-et-Moselle

HISTORY OF EARLY GERMAN SETTLERS IN INDIANA

Much of this information was taken from the book called "Enochsburg and St. John's church" notes of father Joseph Thie

Also some information from the Hamburg church book

In researching the histories on the Hesslers and Dwengers and their branches we find that they are nearly all of German decent, with only shades of French, Dutch, or other nationalities blended in.

Germany had a history of turbulence all through history. Wars and division within itself made life very difficult at times. Germany of old was broken into many small States or dictatorships within itself. In the days when Napoleon Bonapart conquered Germany and gave it a semblence of unity.

It is to Napoleon that we can be grateful for the records of births and deaths ect. He required that this information be recorded and saved as civil records. It is through these records that much information on our ancestors can be found.

There was a surge of German inmagation from Germany to the United States all during the 1800's.

Our early ancestors came mostly up through Ohio and Ky. then on into Indiana. Some settled for a short time in Cincinnati, most crossed the Ohio river into the Indiana counties of Franklin, Dearborn, and Decatur.

Those Franklin settled in the Oldenburg area first then in Hamburg. For a long time Oldenburg had the only Catholic church, and nearly all of our ancestors were of this denomination.

The early American "Yankee", settlers called "Pollacken" by the Dutch German settlers, were sure that the Dutch were awful people. An old well established Yankee custom demanded that when a man butchered a hog, he should hang the liver, heart, and lungs of the animal on the gatepost of his house yard (For what reason is not clear.) for an indefinite period of time. Instead of honoring this time honored custom, these "Dutch foreigners" cooked these things, ground them up, mixed them with salt and pepper and all kinds of outlandish spices, then ate the "devilish mixture". They dished up the feet and ears, and even used the intestines as caselings for their sausages. "Such people!" Worse than that even, they used the very blood of the animal to make their blood pudding. In the spring they would manure their garden plot, and plant and raise cabbage, then cut it up, put it in a cask or stone jar, let it get "rotten spoiled" then eat that.

These early settlers built crude homes, just one room, no ceilings even. Many were only about 12x15x8 ft. in size. If a ceiling was put in, it consisted of 8x10 poles like chickens often roost on, punched in between the logs above the door. On these poles were laid a layer of loose boards. A square opening was left, and an ordinary ladder served as a stairway to the garret this formed. Chimneys were often made of little logs, covered on the inside with a heavy coat of clay.

There was an incredible scarcity of money in the backwoods districts, what cash was had when they arrived was spent on land, farming implements, a few head of livestock, and some house furniture such as cooking stove, chairs, and bedsteads. Other articles such as benches, tables, wardrobes and cipboards were mostly made homemade of boards brought from a far off sawmill, or maybe split off an oak tree and trimmed down with a drawn knife and a jackplane. Walnut and oak trees 75 to 100 feet up to the first limbs, as straight as a ramrod, and from 5 to 6 feet in diameter, had to be cleared away. Two and three years were required to burn these forrest giants. Such splendid timber

would have been gladly given away for hauling it off the ground, but there was no one to do it.

For their agricultural products they had no convenient market. As late as 1853 they made regular trips to Cincinnati with a load of pork, butter, eggs and lard, in order to procure money for taxes and other expenses. They would out on this journey to the city on Monday and return on Saturday night. That gave them two days for going, two days to dispose of their products, and two days to return home. These trips had to be made in the spring of the year.

The next thing to be done was to fence the little patch of corn and wheat to protect it from hogs and cattle, which in those days and even long afterwards were roaming at large all summer straying away from home for miles. Only the milk cows were looked after and were kept the habit of returning home at night. The other livestock was marked with a legally recorded mark, usually a peculiar cut or hole, in the ear of the animal.

The town of Oldenburg, in Ray twp. in Franklin Co. was first settled around 1840. The Catholic element centered in Millhousen in 1834, St. Nicholas in 1836, Oldenburg in 1837. At first people from Oldenburg, Morris, Batesville, Enochsburg, St. Maurice, and Hamburg attended there. Enochsburg divided from Oldenburg and became a parish in 1844.

The first Catholic church "St. John's" at Enochsburg was built in spring of 1843. It was 47ft. long, 26ft. wide, and 30ft. high. It was made of logs and the roof of clapboards. This was the first in the district.

Millhousen in Decatur Co. was first settled by Maxililian Schneider, who also helped establish the first Catholic church there around 1840. It was a log building 20x24 ft. The first marriage there was that of Francis Link and Mary Hessler. The chapel was without pews and without heat. Parishioners brought their own stools and during winter months stomped the rough floor with wooden shoes to keep their feet from complaining too much. Some of the parishners who lived a fair distance from the chapel used to bend branches and twigs as they struggled through the pathless forest to be sure they could find their cabins when they returned from mass.

Their cabins were one-room with a bare earth floor. A fireplace furnished the only heat and served as the family stove. Light at night was from the embers in the fireplace or by a smoky tallow lamp. Even by day the light was dim because the windows were small and built high for protection against wolves and other wild animals.

The town of Hamburg is situated on the line of Ray and Salt Creek twps. in Franklin Co. The first log church, post office and school were in Salt Creek. Along the creek. The oldest Cem. is at Stipp's Hill. The town plat of Hamburg was laid out by Wesley Marlin in 1864. Mr. Martin offered people of the area five acres of land for \$1.00 per acre, providing a church and a school were built on the land. The land was deeded in 1861.

INTERESTING FINDINGS

Franklin County was formed in 1811 from Clark, Dearborn, and Jefferson County. Most emigrants first came to the eastern seaboard, then usually moved westward. A spot check in 1840 shows more Declaration of Intentions in Franklin County and begins in 1826. Franklin County formation was effective on 1-1-1811 Laws 1810 Eubank p. 108-111. Dearborn County formation by Governor's proclamation 3-7-1803.

Enochsburg is oldest platting in Ray township on 3-18-1836 in extreme west part. Population of thirty in the part not in Decatur County. In 1914, it had a general store, public school of both low and high grades (1-8), and the Catholic Church, St. John the Evangelist. It lies six miles directly west of Oldenburg.

Huntersville was platted in 1841 by hunters. It is directly north of Batesville on Indiana 229 and has Evangelical Lutheran Church.

Hamburg is located six miles northwest of Oldenburg on what is known as Six Mile Road, one-half in Ray township and one-half in Saltcreek township. It was platted in 1864 by Wesley Marlin, whose family was among the pioneer settlers. In 1914, there were fifty inhabitants, two stores, garage, St. Anne Catholic Church, and public school.

There were trainloads of orphans brought into Indiana years ago: Ages, infants and on up.

The 1827 Census of Brookville: Population, White 430; Black 13

In 1930, Oldenburg had a census of 575. It lies eighteen miles southwest of Brookville.

SOME OF THE BUSINESS ESTABLISHMENTS

Hamburg, Indiana

1882 W. Dwenger Dealer Dry Goods, Groceries, and all kinds of Merchandise

H. Seibel Dealer in Dry Goods, General Merchandise, and all kinds of Grain

John G. Holtel Carpenter, Architect, and House Builder

John Fisher Blacksmith

Rev. Eberhard Catholic Priest

Oldenburg, Indiana

F. B. Fischer Farmers Home & Restaurant

Vincent Welling Teacher and Farmer

WWII Norbert H. Dwenger PFC U.S. Army 12-23-1943 died of pneumonia in State Hospital at Presque Isle, Maine. Burial St. Ann Catholic Cemetery, Hamburg, Indiana. Born 1-11-1919, Hamburg, to Mr. and Mrs. Henry B. Dwenger, Hamburg, Indiana.

Kenneth Bernard Luttel, Cpl Co. A 501st Signal Battalion 101st Airborne Division killed 6-2-1970 Vietnam. Burial St. John, Enochsburg. Born 1-10-1949 to Mr. and Mrs. Alphonse Bernard Luttel, R. #6, Greensburg. Batesville High School 1968. Medals: Bronze Star, Purple Heart, Good Conduct Medal.

John W. Nienaber A1/c U.S. Air Force B-29 Bomber Flight Engineer killed 4-29-53 B-29 Bomber crash near Randolph Air Force Base, San Antonio, Texas. Burial St. Mary's Catholic, Greensburg. Born 2-17-1927, Greensburg, Indiana. Parents: Anthony A. Nienaber, Sr., and Mary K. Nienaber, Greensburg, Indiana.

Dwenger

M/ Bernard Dwenger B/1806Germany → hadbrother: Gerhart Dwenger Child
 Ankum, Hanover M/1836 ^{1. Joseph}
 Anna M. Catherine Wilmering b/1807Germany Marie Cath. Wirtz ^(Wirtz)

- | | | | |
|--|--|--|--|
| 1. William B. b/1839
m/1860 d/1909
Catherine Raver
Child:
1. John m/Eliz. Weibold
2. Will m/Lena Weimer
3. Frank m/Anna Seibel
4. Bernard m/Eliz. Haskamp
5. Carrie m/Henry Seibel
6. Henry m/Anna Ruth
7. Francis m/not marr.
8. Vincent m/not marr. | 2. Mary Catherine b/1841
m/1860
Vincent Welling
Child:
1. Cath. m/Bill Ricke
2. Wm. m/Eliz. Ricke
3. Henry m/ not m.
4. Joseph m/not m.
5. Philomena m/not m.
6. Maria Joes. m/Al Goldsmith
7. Martha E. m/Steve Johanningman
8. Cecelia m/
9. Anna Marion | 3. Bernard b/1843
m/1863 d/1925
Elizabeth Nienabor
Child:
1. Frank m/1 Mary Ruth
M/2 Amanda Holms
2. Joseph d/age 1
3. Philomena m/ Ben Haskamp
4. George d/died young
5. Henry/M/1 Ann Simmeyer
6. Ann Ameila m/ Peter Ruth | 4. Henry b/1846
m/
d/1927
Catherine Wanstrath
Child:
1. Rose
2. Joseph
3. Henry
4. Theodore
5. Gregor |
|--|--|--|--|

- | | | | | | | | |
|---|--|--|---|---|--|--|---|
| ch. <u>John</u> of <u>Wm. Dwenger</u>
1. John m/Elizabeth Weibold
Child:
1. John m/Ann Hessler
2. Elizabeth m/? | 2. William m/Magdalena Weimer
Child:
1. John
2. Caroline
3. Harold | 3. Frank John m/Anna Seibel
Child:
1. Raymond
2. Hilmer
3. Harry
4. Stella
5. Martha
6. Ellen | 4. Bernard m/Elizabeth
Child:
1. Joseph
2. Edwin
3. Maurice
4. Roman
5. Loretta
6. Alma
7. Mary
8. Elizabeth | 5. Mary Caroline m/Henry Seibel
Child:
1. Eleanor
2. Mable
3. Arthur
4. Rosemary | 6. Henry Bernard m/Anna M. Ruth
Child:
1. Leo
2. Victor
3. Hilda
4. Olivia
5. Norbert
6. Emma
7. Eddie | 7. Mary Francis b/1874
d/1883
died young | 8. Vincent b/1876
d/1879
died young |
|---|--|--|---|---|--|--|---|

- | | | | | | |
|--|--|--|--|--|--|
| John and Elizabeth Dwenger child:
1. John m/Anna Hessler
No Children
2. Elizabeth ? | William & Magdalena Dwenger child:
1. John Dwenger m/Margaret Cahill
1. William
2. Mary
3. John
4. Shirley
2. Caroline not married
3. Harold
1. Jean
2. Ruth
3. Martha
4. Joe
5. Linda | Frank John & Anna Dwenger child:
1. Raymond m/Flora Rolfes
1. Robert
2. Ralph
3. Edna
4. Helen
5. Donald
6. Russel
7. Mary Jane
8. Patricia
2. Hilmer m/
Nora Walke
1. Hilmer
2. Dorothy
3. Carol
3. Harry m/
Mary Hessler
1. Kathy
2. Esther
3. Rosie
4. Ruth
5. Anna
6. Dick
7. Betty
8. Leonard
9. Mary E.
10. Edward J.
4. Stella died young
5. Martha m/
Bernard Stier
1. Harold
2. Margie
3. Phyllis
6. Ellen m/
Joe Ries
1. Jo Ann
2. Jim
3. Marion
4. Evelyn | Bernard & Elizabeth Haskamp child:
1. Joseph m/Ada Sagel
1. Margaret
2. Jean
3. Virginia
4. Ruth
5. Joseph
2. Edwin m/
Marg. Theising
1. Sally
2. Georganna
3. Jane
4. Marilyn
5. Richard
3. Maurice m/
Nita O'Mara
1. Susan
2. Karen
4. Roman m/
Bernadine Schroader
1. Mary
2. Louise
5. Johanna m/
Ed Meyer
1. William
6. Loretta m/
Elmer Sherman
1. Thomas
7. Alma m/
Clarence Lehmann
1. Jim
2. Joan
3. Rita
8. Mary m/
John Schulte
died in childbirth
9. Betty m/
Charles Ulm
1. Charles
2. Frank
3. Virgil
4. Orman
5. Jack
6. Betty | Carrie & Henry Seibel child:
1. Elenor m/Ed Peters
1. Helen
2. Carl
3. Arthur
2. Mable m/
Sam Allen
1. Clarence
2. Rodney
3. Thelma
3. Arthur m/
died young
4. Rosemary m/
Cliff Kersker
1. Sandra
2. Linda
3. Carolyn | Henry & Anna Dwenger child:
1. Leo - died young
2. Victor - died young
3. Hilda - died young
4. Olivia - died young
5. Norbert - killed in service
6. Emma - not married
7. Eddie m/1 Romilda Recr m/2 Rose Fasbinder
1. stepchild- Jerry Fasbinder
8. Alvina m/ Bill Nobbe
1. John
2. Richard
3. Rosemary
4. Ambrose
5. Jim
6. Harold
7. Eileen
8. Lucy
9. Ray
9. Alfred m/#1 Mary m/2 Gladys Wirth
1. Earl
10. Clarence m/ Bessie Wirth
1. Betty
2. Bob
3. Donald
4. William
5. James
6. Doris
7. Rita
8. Adolph
9. Mable
10. Tom
11. Lloyd
11. Waldo m/ Anna Wood
1. Paris
2. Waldo
3. Hazel
4. Emma
5. Henry
12. Clara m/ Bill Neise
1. Eugene
2. Jerry
3. Joe
4. Bob
5. Greg
6. David
7. William
8. Sharon
9. Dennis
13. Stella m/John Tokelvo
1. Mary Taylor
2. Ronald
3. Jemmy
4. Marlene
5. Kathleen
14. Paul m/Florence Mattingly
1. Janice
2. Ken
3. Debbie
4. Rick
5. Randy |
|--|--|--|--|--|--|

Descendants of William Bernard Dwenger

The son of Bernadi and Katherine Dwenger, who were from Germany. Married Catherine Raver, and had five sons and one daughter. This list prepared from notes from Harold Dwenger.

12-14-81

- ① John (Elizabeth Weibold)
John (Anna Hessler) - no children
Elizabeth - on file
- ② William Bernard (Mary Magdalena Welmer)
John Edwin (Margaret Cahill) - William, Mary Catherine, John, Shirley
William - never married
Mary Catherine - (Jerry Vincent) - Kathy Ann, Danny
(Sam Douglas)
John (Lynn Owens) - John, Richard
Shirley - never married
Anna Caroline - never married
Harold Bernard (Leone Elizabeth Hahn)
Jean Therese (Donald Bohn) - Donald, Susan, Sandra, Elizabeth
Ruth Ann - Died at age 4
Martha Mary (James C. Curd) - James, Steven, Barbara, Michael, Thomas, Karen
Joseph Harold (Victoria Mascari) - Ellen, Kristen, Sara, Emily
Linda Maria (Michael Lytle) - Brittany, Brandon
- ③ Frank (Anna Seibel)
Raymond (Flora Rolfes) - Robert, Donald, Ralph, Russell, Edna, Mary Jane, Helen, Patricia
Hilmar (Kora Walker) - Hilmar, Dorothy, Carol
Martha (Bernard Stier) - Harold, Margie, Phyllis
Ellen (Joe Ries) - Joann, James, Marion, Evelyn
Harry (Mary Hessler)
Mary Catherine (Paul Scheidler) - 6 children
Esther (William Martin) - 5 children
Rosella (Harold Powers) - 12 children
Ruth (Charles Hamilton) - 12 children
Anna Mae (John McCullough) - 12 children
Richard (Joan Lawrence) - 4 children
Martha Elizabeth (Frank Harris) - 7 children
Leonard (Janet Burgmeier) - 2 children
Mary Ellen (Carl Veerkamp) - 5 children
Edward (Janet Griewe) - 2 children
(Brenda McIntyre) - 3 children
- ④ Bernard (Elizabeth Haskamp)
Joseph (Ada Sagel) - Margaret, Jean, Virginia, Ruth, Joseph
Edwin (Margaret Thiesing) - Georgianne, Sally, Jane, Marilyn, Richard
Maurice (Waneta O'Mara) - Susan, Karen
Rosam (Bernadine Schroeder) - Mary, Louise
Johanna (Ed Meyer) - William
Loretta (Elmer Sherman) - Thomas
Alta (Clarence Lehmann) - Jim, Joan, Rita
Mary (John Schulte)
Betty (Charles Uhn) - Charles, Frank, Virgil, Jack, Ornan, Betty
- ⑤ Carrie (Henry Seibel)
Eleanor (Ed Peters) - Helen, Carl, Howard
Helen (Vivian Linn) - 4 children Carl - SHIRLEY - RICHARD JERRY
Carl (Rosemary)
Howard (Joyce Hill) - Michael, Susan, Carol, David
Arthur - died in youth
Mabel (Sam Allen)
Clarence (Edna Bradbury) - Kathleen, Rebecca
Thelma (Ralph Eckhart) - Debbie, Dennis
Rodney (Bonnie Sager) - Scott Dean, Kenneth, Holly Lynn, Brian
Rosemary (Cliff Kirschner) - Sandra, Carolyn, Linda
- ⑥ 4-2-1872 - 1-5-1953
Henry (Anna Huth)
Leo - died in youth
Victor - died in youth
Hilda - died in youth
Olivia - died in youth
Norbert - killed in service
Emma Johanna - never married
Eddie (Romulda Reer)
(Rose Forbender) - 1 stepchild
Alvina (Bill Nobbe) - John, Richard, Rosemary, Ambrose, Jimmy, Harold, Eileen, Lucilla, Raymond
Alfred (Mary)
(Gladys Wirth) - Earl
Clarence (Bessie Wirth) - Betty Ann, Robert, Donny, William, Doris Jean, Rita, Adolph, Mabel, Tommy, Jimmy, Lloyd
Waldo (Anna Woods) - Paris, Waldo, Hazel, Emma Rose, Henry Joe
Clara (Bill Niese) - Eugene, Jerry, Joseph, Robert, Gregory, David, William, Sharon, Dennis
Stella (John Tokulve) - Mary, Honni ?, Jenny ?, Marlene, Kathleen
Paul (Florence Mattingly) - Janice, Kenneth, Debbie, Rick, Randy

BERNARD H. AND MARY CATHERINE(WILMERING) DWENGER

Bernard Henry Dwenger was born on Oct. 1, 1806 in Hanover, Germany (Prussia). He and his brothers emigrated to America from Hanover in March of 1835. They landed in Baltimore, Maryland in May of 1835. We do not know the name of Bernard Dwenger's father. We do know that Bernard was one of three brothers who came to America from Germany. One went to St. Mary's in Ohio. The other brother, a Gerhart Dwenger who emigrated to America with him, settled in Ohio.

Gerhart Henry Dwenger was married to Maria Catherine Wirdt in 1836 at Ohio. They moved to Mariastein, Ohio. Gerhart and Maria had a son Joseph Gerhard, born on Sept. 7, 1837 at Mariastein, Ohio. Gerhart Dwenger died suddenly in 1840. After her husband's death Maria moved to Cinn., but after a short time in 1847 she returned to Mariastein. Maria Dwenger came down with Cholera and died suddenly in 1849. This left their young son an orphan. He was taken in and raised at the Mt. St. Mary's Seminary, in Ohio. He chose the priesthood as his vocation, and was ordained at 22 years of age, on Sept. 4, 1859. He became a Bishop at age 35, and was known by the family as Bishop Dwenger.

The brothers traveled to the State of Ohio. Bernard settled in the city of Cinn. Ohio, in Hamilton County, where he was employed for a time in a tile factory. Bernard Henry Dwenger was married to Anna Mary Catherine Wilmering. While in Cincinnati, a son, William Bernard Dwenger was born on Jan. 3, 1839, Cinn. Ohio.

On April 23, 1837 Bernard H. Dwenger (spelled in book as Dwinger) purchased 80 acres of Land (section 23, Range 11, township 11 - West half of the Northwest corner.) from the Government, in Franklin county Indiana, Ray township. In 1839 he purchased an additional eighty acres of land, for the price of \$50.00, from a Muckerheid, in Ray township in Franklin County Indiana. (section 25, township 11) This was near the town of Hamburg in Franklin Co. Indiana. The land at this time was all in woods. Bernard with only his ax and saw cleared a spot and put up a house and cleared much of the wilderness.

There was no church at Hamburg at that time and those who were Catholic attended the Oldenburg Catholic Church. Most, did not have a fancy buggy. They would all load themselves into the old work wagons and ride together to Oldenburg for church services.

Bernard and Catherine Dwenger had a daughter Catherine Dwenger, born on July 30, 1841. On August 14, 1841 Bernard Dwenger applied for American Citizenship in Franklin County, Indiana. Their son J. Bernard Dwenger was born on Aug. 30, 1843 at Hamburg Indiana. Another son Henry Dwenger was born on Feb. 20, 1846 at Hamburg, Indiana.

On Aug. 8, 1853 Bernard Dwenger purchased additional land bringing his land holdings up to 300 acres. He was a farmer, and taught his sons in this trait.

Bernard Dwenger in his later years lived with his son Bernard, in the town of Hamburg, and this is where he was found in the 1870 census at the age of around age 65.

Bernards wife, Mary Catherine (Wilmering) Dwenger, died on July 28, 1878 at Hamburg, Indiana.

He became ill and died of the Bronchial pulmonary grip on Dec. 21, 1909, and is buried in Hamburg.

Bernard and Catherine Dwenger were the parents of four children that we know of:

1. William Bernard Dwenger, born in 1839 and who married Catherine Raver and had seven children: John, William, Frank, Bernard, Carrie (Seibel), Henry, Francis.

2. Mary Catherine Dwenger, born in 1841 and married Vincent Welling. They had nine children: Catherine (Ricke), William, Henry, Joe, Philomena, Maria (Goldsmith), Mary Elizabeth (Johanningman), Cecilia, Anna.

3. J. Bernard Dwenger was born in 1843 and was married to Mary Elizabeth Nienaber. They were the parents of six children: Frank, Charles, Catherine (Meyer), Philomena (Haskamp), Amilia (Huth), Joseph.

4. Henry Dwenger was born in 1846 and was married to Catherine Wansrath. They were the parents of five children: Rosa, Joseph, Henry, Theodore, Gregor.

Bernard and Catherine Dwenger were both members of the St. Anne's Catholic Church at Hamburg. They are both buried at the Catholic Cemetery there.

State of Indiana }
Franklin County } Sept

Personally appeared before me Robert John Gure of the Franklin Circuit Court in and for said County on the 14 day of August A.D. 1840 Bernard Dwenger an alien and makes the following report and declaration to wit: That he was born in the Kingdom of Hanover in Germany in the year 1806 that he is about 34 years of age that he left Hanover in March 1835 and landed at Baltimore in the State of Maryland on the 14th day of May 1835 on a free there he came to Cincinnati in 1835 and from thence he came to Franklin County in the State of Indiana in September 1837 when he had previously decided and that said Franklin County is the place of his usual abode and that he in truth declares that it is bona fide his intention to become a citizen of the United States of America and to renounce forever all and every claim of ability to enjoy foreign privilege jurisdiction or sovereignty whatever and to adhere only to the King of Great Britain to be admitted before me at my office in and for said County on the 14 day of August 1840

D. Dwenger
Robert John Gure

"O, Sweet Jesus, through Thy holy agony
Grant eternal rest to Thy faithful departed."
Jesus! Mary! Joseph.

Sacred to the Memory of

William Dwenger

Born in Cincinnati, O., January,
18, 1889. Died at Hamburg, Ind.,
December 21, 1909, aged 70 years,
11 months and 18 days, fortified
with the last sacraments of the
church.

Johs Us, Dear Friends, in Solemn Prayer.

O, most gentle heart of Jesus, ever present
in the blessed Sacrament, ever consumed with
burning love for the poor captive souls in Pur-
gatory, have mercy on the soul of Thy servant
William, bring him from the shadows of exile
to the bright home of Heaven, where, we trust,
Thou and Thy Blessed Mother, have woven
for him a crown of unfading glory. Amen.

We miss thee from our home;
A shadow o'er our life in cast,
We miss the sunshine of thy face,
Thy fond and earnest care,
Our home is dark without thee—
We miss thee everywhere.

Ich bitte euch, meine Freunde, daß ihr mir helfen
wollt mit euren Gebeten.

Selbst! Maria! Joseph!

Sehr frommen Erinnerung an

William Dwenger

geboren zu Cincinnati, O., am 18ten
Januar 1889. Gestorben zu Hamburg,
Ind., am 21ten December 1909, im Al-
ter von 70 Jahren, 11 Monaten und
18 Tagen, wohlversehen mit den hl.
Sterbesakramenten.

Wir empfehlen dir, O. Gott, die Seele Deines Zie-
lers, William, der im christlichen Glauben und in der
Scheidung auf Deiner Barmherzigkeit aus dieser Welt
schieden ist. Nimm ihn gnädig auf in den Chor
Deiner Auserwählten, damit er selig in Deiner Ver-
söhnung auch für uns fürbitte, die wir fern von
einer geübten, durch Christus unfernen Herrn, Amen
Engel hast du überreichten
Kranke schwerer, heilige Stunden,
Klang des Lob und mancher Nacht
Sollst du in Schmerzen jugtbracht.
Gottlob! hast du sie ertragen,
Denn Schmerzen, keine Wunden,
Sich der Tod kein Fluch bricht,
Doch beissen wir dich nicht.

Sehr frommen Erinnerung an

Maria Katharina Welling

(geborene Nienaber)
geboren zu Hamburg am 20. Juli, 1841.
ber 1916, im Alter von 75 Jahren, 4 Mo-
naten und 2 Tagen, wohlversehen mit den
hl. Sterbesakramenten.

Du Herr, gib ihr die ewige Ruhe, und
lass' deine Licht spende ihr.
Süßes Aery Maria, in meine Rettung!
(900 Jahre Maria)
Bleib unter uns Maria.



Sacred to the Memory of

Mary Catherine Welling

(nee Dwenger)
Born at Hamburg, Ind., July
30th, 1841. Died near Hamburg,
Ind., December 2nd, 1916, aged 75
years, 4 months and 2 days fortif-
ied with the last sacraments of
the church.

Sweet heart of Mary, be my sat-
vation!
Our Father, Hail Mary,
May he rest in peace. Amen.

Catherine (Dwenger) Welling
wife of Vincent Welling

DWENGER DEATH CARDS

Children of Bernard Dwenger

William Dwenger
(Grandfather to
Harry J. Dwenger)

owned store in Hamburg

Catherine (Raver) Dwenger
grandmother of Harry J.
Dwenger

(Wife of William Dwenger)

Bedenket meine Freunde,
denk an meine Freunde!

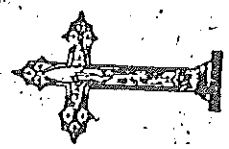

Erinnerung an

Katharina Dwenger
(Wife of Hamburg, Ind., am
6. März 1891, im Alter von
48 J. 10 M. und 21 Tagen.)

bleibe treu der Todten, die lebend dich gelich
bleibe treu der Todten, die lebend du betrüb
andere du dich herzlich,
In Lebenslust verfaßt
Wife schneet sie sich schmerzlich,
Hast Ehre du gedehst

Have pity on me, at least you my
friends. Job XIX—21.

JESUS! MARY! JOSEPH!

O Holy Cross

Under Thy Shadow I Will Rest
Sacred to the Memory of

BERNARD DWENGER

Born at Hamburg, Indiana,
August 30, 1843. Died at
Hamburg, Indiana, Septem-
ber 8, 1925, age 82 years and
8 days, fortified by the last
sacraments of the church.

PRAYER.

O, sweet Jesus, we implore Thee
grant Thy servant, who departed
this life rest, sweet rest, and what
ever sin he may have committed
through human frailty, do Thou in
Thy most merciful goodness for-
give. Amen.

My sweet Jesus, be not my
Judge, but my Saviour.—50 days.

Sweet Heart of Mary, be my sal-
vation!—100 days.

Bernard and Elizabeth (Nienaber) Dwenger
of Hamburg, IN.

Have pity on me, at least you my
friends. Job XIX—21.

JESUS! MARY! JOSEPH!

O Holy Cross

Under Thy Shadow I Will Rest
Sacred to the Memory of

HENRY DWENGER

Born at Hamburg, Ind.,
February 20, 1846. Died at
Hamburg, Ind., August 7,
1927, age 81 years, 5 months
and 17 days, fortified by the
last sacraments of the
church.

Absolve, we beseech thee, O
Lord, the soul of Thy servant, that
being dead to this world, he may
live to thee, and whatever sins he
may have committed in this life
through human frailty, do Thou, of
Thy most merciful goodness, for-
give, through Jesus Christ our
Lord, Amen.

My sweet Jesus, be not my
Judge, but my Saviour.—50 days.

Our Father, Hail Mary.

Henry and Catherine (Wanstrath) Dwenger
of Hamburg, IN.

Have pity on me, at least you my
friends. Job XIX—21.

JESUS! MARY! JOSEPH!

O Holy Cross

Under Thy Shadow I Will Rest
Sacred to the Memory of

CATHERINE DWENGER

(Nee Wanstrath)
Born at Enochsburg, Ind.,
April 2, 1851. Died at Ham-
burg, Ind., November 8, 1927,
age 76 years, 7 months and
6 days, fortified by the last
sacraments of the church.

O God, the Creator and Redeem-
er of all the faithful, grant to the
soul of Thy servant departed the
remission of all her sins, that
through the devout prayers of Thy
church on earth, she may obtain
that remission of pain, which she
has ever desired, who lived and
reigned, world without end. Amen

My sweet Jesus, be not my
Judge, but my Saviour.—50 days.

Our Father, Hail Mary.

My sweet Jesus, be not my
Judge, but my Saviour.—50 days.

HAMBURG INDIANA -- FRANKLIN CO.

SE 1/4 OF SW 1/4 OF

Section: 24

Township: 11

Range: 11 E 40 acres

4/27/1864 recorded in plat book 1 pg. 25
platted in 1864

Lots: Lots are 4 rods in front
and 12 rods deep

1, 2, 3, owned by Kate Gigrich 1906
then by Leo & Alma 1957

- 4.
- 5.
6. twins Niehoff
7. C. D.
8. Clarence Dwenger
9. C. D.
10. Starost
11. Bedal (site of William Dwenger store 1887)
13. D. Dwenger
- 14.
15. D. Dwenger
- 16.
17. store
18. Frank Brickner (Old)
19. & 20. Peter Hittel
- 21.
- 22.
- 23-30.?
- 31, 32, 33. Albert Dwenger
- 34, 35, 36, Theresa Holtel
37. Amanda Senft (Hotel earlier)
- 38.
39. Blacksmith (later-sport Dwenger)
40. DAN Volk

lots: 19, 20, 21, 31, 32, 33, 34, 35, 36 owned by John Seibel

lots: 20, 21, 37 owned by Henry Seibel (1885)

lots: owned by William Dwenger

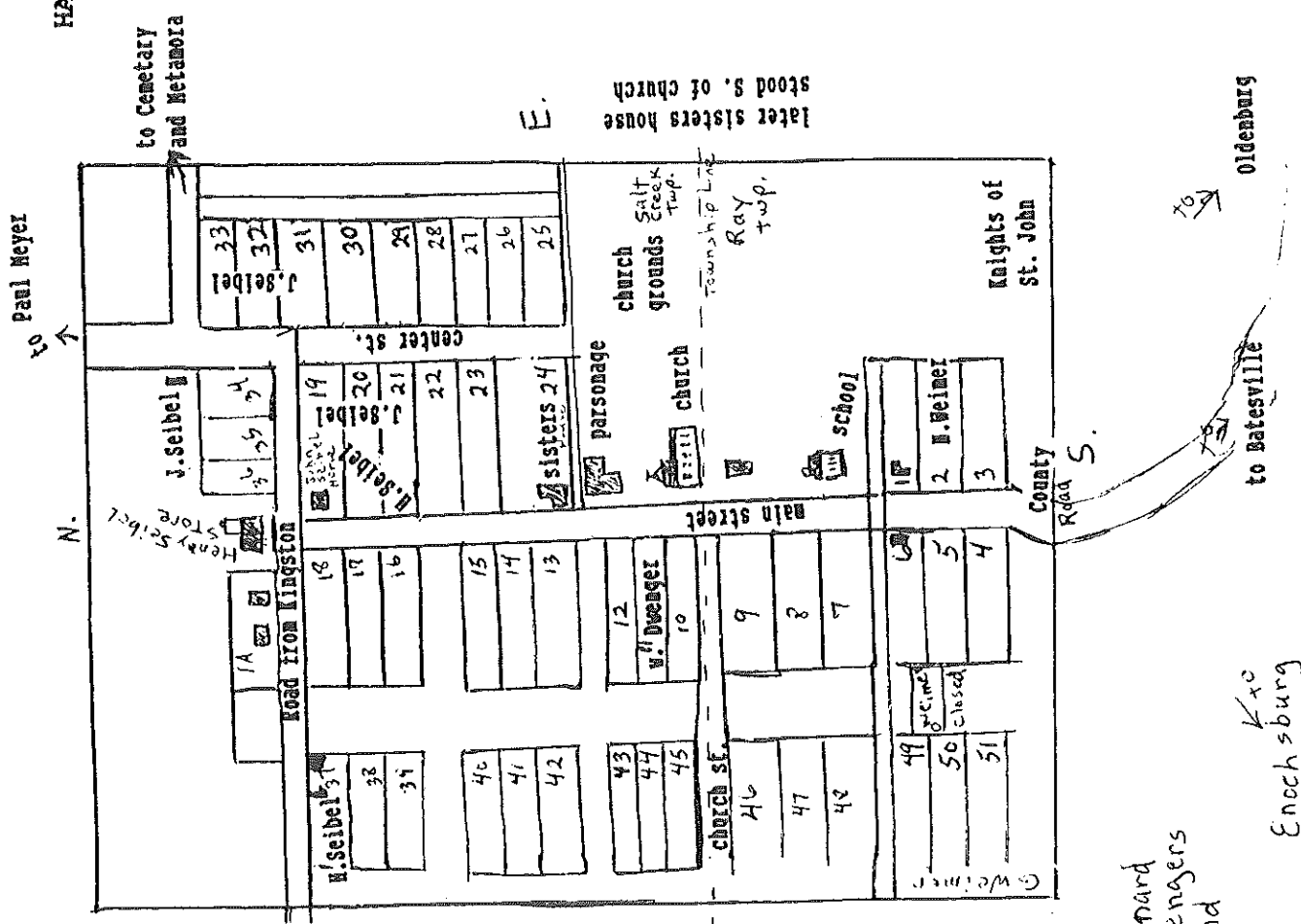

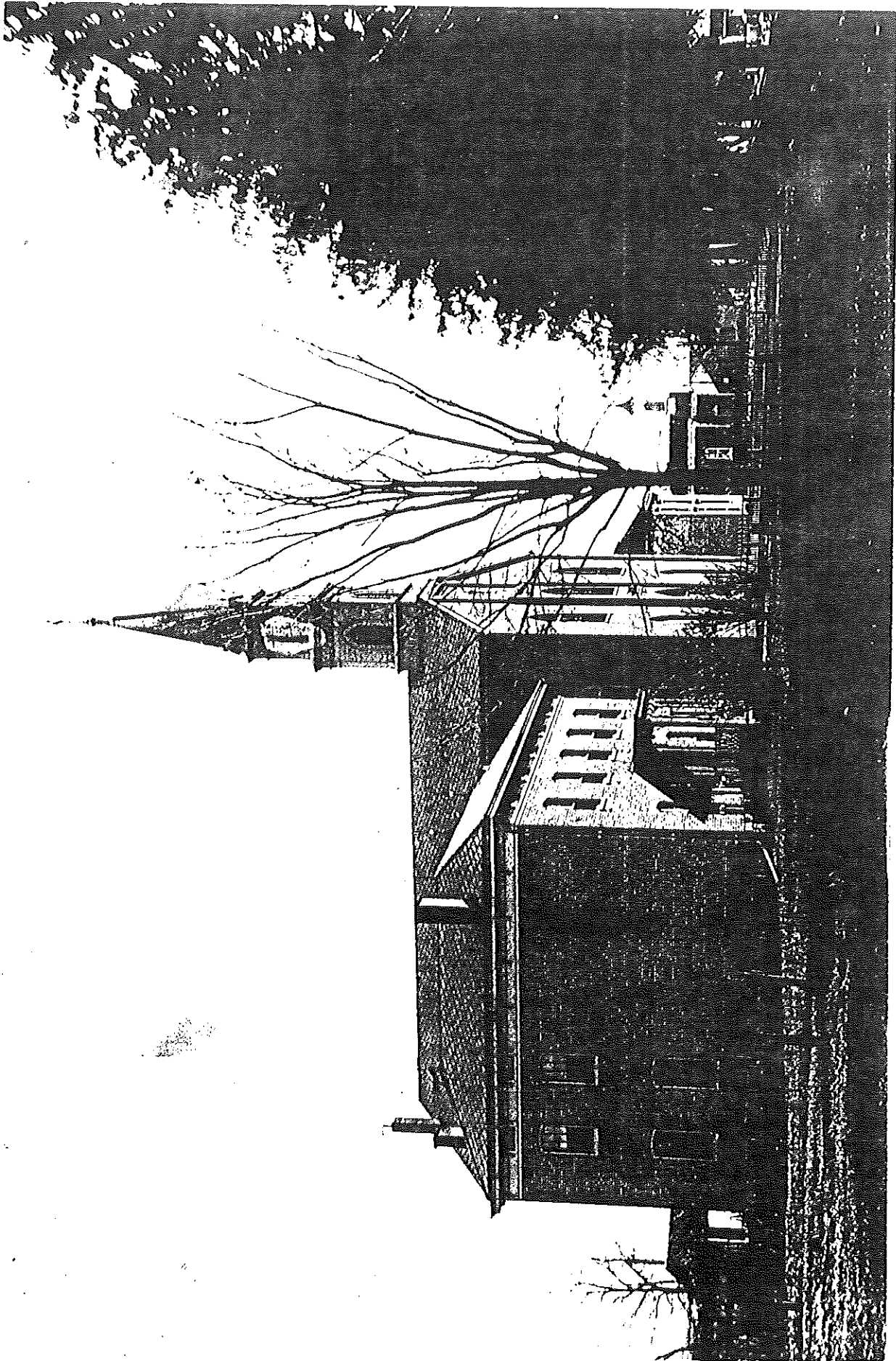

St. Anne's Rectory, St. Anne's Church 1869 - 1954,
Sisters Convent and St. Anne's School, Giggick home, Kinnally St. 1870-1900

Hawahoe, I.R.

1900/1901

1870/1873



VINCENT WELLING and CATHERINE(DWENGER) WELLING
(b.9-12-1840 d.11-16-1891) (b.7-30-1841 d.12-2-1916)

Catherine Dwenger was born on July 30,1841 at Franklin County Indiana, Ray yownship. She was the daughter of Bernard H. and Catherine(Wilmering) Dwenger. She was one of four children: William, Catherine*, Bernard, Henry.

The Dwenger family were members of the Catholic church. In the early years there was no church at Hamburg, and the people would travel to the Catholic church in Hamburg on Sunday Mornings. They had no fancy buggy's, and they would all pile into their work wagons to ride to Oldenburg.

Catherine Dwenger was married on May 15,1862 at Franklin County Indiana, St. Anne's church, to Vincent Welling.

Vincent Welling was born on Sept. 12,1840. Not too much is known about the early history of Grandfather Welling. We do know that the was born in the United States, and lived as a young man in Franklin County, Indiana. He was educated by the Christian Brothers and lived with them in St. Maurice, Indiana. He was a school teacher and for a time. He taught school in Franklin County at Hamburg and near Oldenburg. He was also a Notary Public and specialized in writing last will and testaments. He also had some talent as a musician. He played the violin for county dances. For 35 years he taught at Placke School near Oldenburg and rode a white horse each day from hamburg to and fro, distance of some five or six miles each way. for his day and age he was considered an educated man. He was intelligent, highly respected and frequently consulted by neighbors on legal matters. He married Catherine (Dwenger) in St.Anne Church, Hamburg,Indiana about 1860. They lived on a small farm near Hamburg. To them were born 7 children Elizabeth;Josephine;Catherine(our mother);William;Henry;Cecelia and Mary.All are deceased.

Grandfather Welling died November 16,1891 at the age of 51 yrs.2 mo.,4 days. He is buried in the Catholic Cemetery at Hamburg, Indiana. After his death, grandmother continued to live on the farm, until her death December 2,1916. She is buried beside her husband.

Grandmother Welling was a very sweet, gentle person, loved by all who knew her. She not only made a good home for her husband and family but also did considerable farm work, especially after the death of her husband. She died of a broken hip and complications after a fall on the ice. She was near the barn when it happened and scooted all the way to the house, a considerable distance. She lived to be 75 years, 4 mo.,and 2 days. One of her family became a Catholic Bishop - Bishop Dwenger. He was a bishop of the diocese of Ft.Wayne, Indiana for a number of years. He was very competent and a highly respected clergyman.

R.C.R. Nov.1966

Bernard and Mary Elizabeth (Nienaber) Dwenger

Bernard (Barney) Dwenger was born August 30, 1843 at Hamburg, Indiana. He was the son of Bernard H. and Catherine (?) Dwenger. He was one of four children: William born in 1839; Catherine born in 1841; Bernard born in 1843, and Henry born in 1846.

Bernard was married on October 26, 1863 to Mary Elizabeth (Liza) Nienabor. Mary Elizabeth was born on February 8, 1842.

Bernard and Mary Elizabeth made their home at Hamburg, Indiana, in Franklin County. They were the parents of seven children: John Frank, Mary Philomena (Minnie); George William; Henry Carl (Charles); Anna Mary Amelia (Minnie); John Joseph; Mary Catherine (Katie).

A. JOHN FRANK (called Frank all his life) was born on July 23, 1867 at Hamburg, Indiana. On October 9, 1894, Frank married Amanda Holmes. They had seven children:

1. Bernard Edward, born August 4, 1895 and died October 23, 1895.
2. Harry Herman, born December 31, 1896. He married Alice Peters on November 14, 1917. They lived in Hamburg all their lives, first on a farm and then they moved to town. He ran a blacksmith shop; he owned and operated a truck, hauling livestock and grain; ran a small garage for repair work; owned the grocery store in Hamburg from 1953 until 1961. Harry died on May 30, 1964. Harry and Alice had seven children:

Theresa married to John Esslinger (deceased). They had 11 children. Judith, Thomas (killed in car accident at 21); Barbara, David, Mary Alice, James, Edward (twin of James and deceased), Dennis, Larry, Jerry and Terry (twins). There are 18 grandchildren and 3 great-grandchildren.

Albert married to Rose Marie Smith). They have 10 children. Margaret Rose, Pamela, Kevin, Mary Beth, Joseph, Theresa, George (adopted), Kathy, Angela, and Holly. There are 10 grandchildren and 1 great-grandchild.

Irene married to Bob Tepe. They have 7 children. Robert, Richard, Arnold, Patricia, Helen, Anne, and Anthony. They have 13 grandchildren (1 deceased).

Irwin who is deceased.

Mary Agnes married to Richard Flick. They have 6 children. Kathy, Anita, Dennis, Patrick, Brian, and Greg. They have 7 grandchildren.

Rosina married to Everett Lodge. They have five children. Curtis, Deanna, Gerald and Carol (twins), and Mark. They have 7 grandchildren.

Bertha married to Robert Patterson. They have 4 children. Cindy, Dan, Mike and Bill. They have 7 grandchildren.

3. Carl (Charles) Dwenger; born 8/15/1889; married Francis Lette; divorced and married Elsie Baylis 1925
 4. Leonard (Lonnie) born 5/30/1902; married Nan. No children
 4. Peter Edgar born 10/8/1904; married Helen Elder 4/23/30; Helen died and he married Ann. From his marriage to Helen, he had two children:
Franklin and Robert Eugene
 5. Laura married Carl Ricke.
They had two children, Rita (Chastein) and Richard.
- B. MARY PHILOMENA (Minnie) born 2/23/1870, married Ben Haskamp 2/27/1887.
1. Carl Joseph (Joe) born 4/15/1890, married Eleonara Fehrman - 9/9/19
 2. Anna Marie Bernadine born 6/16/1892; married Bernard Struewing 11/8/11.
 3. Edward Henry (Ed) born 6/3/1896; married Louise Meyer - 2/7/1923
 4. Bernard Frank (Frank) born 1/28/1899; married Regina Macke - 4/7/1926
 5. Bernard Edgar born 8/13/1902 - died 8/13/1902
 6. Martha born 8/7/1905 (deceased)
 7. Cora born 7/24/1909; married Alva Mauer 8/19/1931
 8. Sarah born 4/14/1914; married Frank Moeller
- C. GEORGE WILLIAM born 2/1/1874; died in infancy
- D. HENRY CARL (CHARLES) born 7/10/1875; died 1/11/43; married Anna Marie Simmermeyer who died. Then married Anna Stapelton who died 1/17/1935.
1. Matilda - 5/10/1901 - married Matt Nobbe - 4/19/22
(raised by grandparents)
 2. Clarrisa born 3/11/15 married Jerry Mollaun
 3. Bertram
 4. Stanley
 5. Severus
- E. ANNA MARY AMELIA (MILLIE) born 9/27/1877; married Peter Huth, Jr. 11/7/1894.
1. Veronica Clara (Fronnie) born 5/12/1897; married Eldon Campbell 4/10/1920.
 2. Peter Leo (Leo) born 9/18/1899; married Bertha Otto - 4/23(?)
 3. John Peter born 5/14/1902; married Blanca Baker 1920
 4. Frank Alphonse, born 5/16/1904
 5. Philomena Henrietta born 3/25/1907; married Ray Kriech
 6. Carl Elmer born 5/15/1909; married Katherine _____
 7. Thelma *of James Allen Sr. and James Coets*
 8. Howard (is a priest) *ordained June 20, 1946 Indianapolis*
- F. JOHN JOSEPH born 5/4/1880; died 1881.

FOR MORE INFORMATION SEE: NIENABER HISTORY

G.

HENRY & MARY CATHERINE (KATE) (DWENGER) MEYER

Mary Catherine (Kate) Dwenger was born on Aug. 27, 1882 at Hamburg Indiana, in Franklin Co. She was the daughter of Bernard and Elizabeth (Nienaber) Dwenger. She lived at Hamburg and attended the Catholic School there. Her family were members of the St. Anne's Catholic Church of Hamburg Indiana. She married Henry Meyer Nov. 8, 1899 in Hamburg Indiana. They had 8 children;

1. Leona born Jan. 4, 1902; married William Oesterling on June 16, 1926. They had 5 children; Helen Rose who married Emel Ennekily; Cathlene who married John Pullman; Herbert who married Joann Stenger; John; Clare who married Tom Moorman.

2. Louise born May 27, 1904; married Ed Ricke on May 31, 1927. They had 6 children; Anna Mae who married Ryan; Clifford who married Ann Mae Hallard; Willard who married Dorothy Koor; Gilbert Gilbert who married Linda; and twins Marilyn who married Justin Schoader and Marlene who married Bob Walter.

3. Ursula born June 2, 1910; married Christian Brinkman on June 16, 1934. They had 2 children; Lucillie; William.

4. Emilia Meyer born Aug. 12, 1913, Died young from whooping cough in 1917.

5. Albert born March 11, 1907; deceased; married Martha Schebler June 20, 34. They had 15 children; Margie who married Ed Hunter; Howard who married Rita Kramer; Walter who married Jo Ann Bohman; Kenneth died as a infant in 1939; Ronald who married Carmelita Gindling; Ruth who married Charles Lecher; Jean who married Emmanuel Bomben; Doris who married Joe Baker; Catherine who married Steven AmRhine; Francis who married Rita Werner; Mary Frances died in 1943; Joseph single; Mary who married Roger Blanker; Davied single.

6. Ralph born April 27, 1916; deceased.

7. Paul born Feb. 17, 1919; married Alice Stevens Aug. 22, 1944. They had 10 children; Paula who married Dick Bohmen; Richard who married Joyce Cross; Kenneth who married Joan Tekulve; Diane who married Tom Rynn; Patricia who married Steve Kaiser; Donald who married Jennifer Osier; Cynithia; Gary who married Marita Walpe; Steve Paul died as a infant in Oct. 1948.

8. Romilda born Oct. 6, 1921; married Robert Waldman 1947. They had 5 Children; Sheila; Dixie; Robert; Mark; boy.

MARY PHILOMENA DWENGER AND BEN HASKAMP

Mary Philomena (Minnie) Dwenger was born on Feb. 23, 1870 at Hamburg Indiana in Franklin County. She was the daughter of Bernard and Elizabeth (Nienaber) Dwenger, of Hamburg.

Her family were members of the St. Anne's Catholic church in Hamburg, and their children attended the Catholic school there.

Mary Philomena was married to Bernard Haskamp on Feb. 27, 1887 at Hamburg, in Franklin County Indiana. Bernard (Ben) Haskamp was born on Dec. 11, 1866. He was the son of Joe and Mary (Willingber) Haskamp.

His sister Elizabeth was married to Bernard Dwenger, also of Hamburg.

Philomena had a brother Carl Dwenger. His wife Anne passed away young. Philomena's parents Bernard and Elizabeth Dwenger took a daughter, Matilda in to raise. She helped them around the house with the chores and taking care of them in their old age. Sarah Dwenger (Moeller) remembers she and her mother stopping in to visit her grandparents, who, at that time had moved into town, near the school.

The older of Philomena's children were taught in German at the school, but by the time the last two children, Cora and Sarah started, they were teaching in English.

Philomena and Ben Haskamp lived in Franklin County. Ben was a farmer, and owned a 160 acre farm in Ray township in Franklin Co.

They were members of the St. Mary's Catholic church in Hamburg.

Philomena and Ben were the parents of eight children:

1. Carl Joseph (Joe) Haskamp was born on April 15, 1890. He was married to Eleonora Fehrman. Carl was a farmer in the Greensburg area. They had three children. 1. Doreen who d/1946 she was not married. 2. Raymond m/Gwenaveve Thomas (Ray, Tom, Sharon). 3. Eugene m/a widow- Evelyn Frieoling.

2. Anna Marie Bernadine Haskamp was born on June 16, 1892. She was married to Bernard Struewing. She had a daughter Glenora born in 1914. Anna died in childbirth.

3. Edward Henry (Ed) Haskamp was born on June 3, 1896 at Hamburg. He married Louise Meyer. Ed was a farmer. They had five children: 1. (twins) Luella m/Ed Knobbe (Gary, Tim, John, Nancy, Debbie, Norman, Cathey). 2. Lewis m/Ethel Meer (Ethel Sue, Pam) 3. Ruth m/Arthur Cutter. 4. Virgil m/Bertha Daeger, 5. Bernard who m/Janice Firsich (Anita)

4. Bernard Frank (Frank) Haskamp was born on Jan. 28, 1899. He was married to Regina Macke. He was a farmer. Bernard and Regina had five children: 1. Lucille m/Bob Wenning 2. Rosaline m/Wilber Sennt 3. Marjorie m/Paul Hodnert 4. Harold m/Deloras Cramer 5. Robert m/Margaret Hardebeck (He died young).

5. Bernard Edward Haskamp was born and died on Aug. 13, 1902.

6. Martha Haskamp was born on Aug. 7, 1905. She never married.

7. Cora Haskamp was born on July 24, 1909. She married Alva Mauer. They had no children.

8. Sarah Haskamp was born on April 14, 1914. She was married to Frank Moeller on April 27, 1937 at St. Anne's Catholic Church in Hamburg. Frank Moeller was born on Nov. 21, 1912 the son of John and Catherine (Meyer) Moeller. They reside on the homeplace. Their farm is located two and a half miles out of Hamburg, where they presently reside. They are members of St. Anne's Catholic Church. Sarah and Frank are the parents of five children: 1. Richard m/Pat Federle (John, Michael, Laura, Julie, Susan, Beth) 2. Ann m/Clete Westler (Alan, Jean, Lynn) 3. Carol m/Kenny Stier (Gregg, Barb, Pat, Nicole, Bryan) 4. Connie m/Dave Nobbe (Brad, Kristen) 5. Janice m/single.

HENRY AND CATHERINE(WANSTRATH) DWENGER

Henry Dwenger was born on Feb. 20, 1846 at Franklin Co. In. in Ray Township. He was the son of Bernard H. and Anna Mary Catherine (Wilmering) Dwenger.

Henry's father, Bernard Dwenger, was born on Oct. 1, 1806 in Germany, and came to America around 1835. He purchased a farm in Ray Township of Franklin County, where he remained. Bernard and Catherine were Catholic, and since in early days there was not a church at Hamburg, the family traveled to the town of Oldenburg in their old work wagons, while dressed in their Sunday clothes to go to church.

Henry Dwenger was one of four children, that we know of: 1. William, who married Catherine (Raver), 2. Catherine, who married Vincent Welling. 3. Bernard, who married Elizabeth Nienaber. 4. Henry (self) who married Catherine Wanswrath.

Henry grew up on a farm just South East of the town of Hamburg. He attended the St. Mary's Catholic school at Hamburg, in the early days the school was taught in German as Hamburg was a German settlement.

Henry was married around 1870 to Katherine Wanstrath. Katherine Wanstrath was born on April 2, 1851 at Enochesburg, Indiana. She was the daughter of Henry Wanstrath and Mary Gertrude Holthaus.

Henry and Catherine were the parents of six children:

1. Joseph Dwenger was born in 1871 at Franklin County Indiana.
2. Henry J. Dwenger was born in 1873 at Franklin County Indiana, in Ray township.
- *3. Theodore William Dwenger was born on Sept. 11, 1874 at Hamburg Indiana. He was married to Leona Brost on Feb. 7, 1906 Dunnington, Indiana, Theodore passed away on April 15, 1944 Ambia, IN.
4. George H. Dwenger was born in 1879 at Hamburg Indiana. He died on March 9, 1941 St. Elizabeth Hospital Lafayette, In.
5. Vincent Dwenger was born around 1883 at Hamburg, Indiana. 249 McCormick Place Cinn. Ohio (Address in 1941)
6. Rosa Dwenger was born on Jan. 28, 1913 at Hamburg, Indiana in Franklin County, Ray township. She was married to Bernard Nobbe. In 1941 they lived at 2017 Colerain Ave. Cinn. Ohio.

Henry Dwenger passed away on Aug. 7, 1927 from Cancer in Ray township in Franklin Co. He is buried in St. Anne's Cenn. Hamburg

Katherine (Wanstrath) Dwenger passed away on Nov. 8, 1927 and is buried at St. Anne's Cem. in Hamburg.

THEODORE WILLIAM AND LENA (BROST) DWENGER

* Theodore William Dwenger was born on Sept. 11, 1874 at Hamburg, Indiana. He was married on Feb. 7, 1906 at Dunnington Place to Lena Brost. Lena Brost was born on Nov. 4, 1884 in Indiana. She was the daughter of Johann Brost and Angela J. Schons.

Theodore and Lena Dwenger were members of the St. Mary's Catholic Church. Theodore was a farmer.

Theodore Dwenger passed away on April 5, 1944 at home at Ambia, Dunnington. His wife Lena passed away on May 28, 1956 at the Earl

Park Nursing home, Dunnington Indiana.

Theodore and Lena Dwenger were the parents of seven children:

1. Lucille Angela Dwenger was born on Jan. 5, 1909. Not married.
2. Clarence John Dwenger was born on March 20, 1910 at Benton Co. Indiana. He married Agnes Metzinger on June 27, 1935 at Dunnington
3. Urban Henry Dwenger was born on Oct. 28, 1911 at Benton Co. In. He was married to Alice C. Hasser on July 17, 1940 at Fowler, IN. Alice Colette Hasser was born on Dec. 31, 1918 at Richland twp. Benton County, Indiana. She was the daughter of Aloysious Christian Hasser and Mary Elizabeth Pitstick.

Urban was a farmer. He and Alice were the parents of nine children: 1. Linda Kay Dwenger was born on July 3, 1941 Ambia, Benton Co. In. She married Rich Miltz on Nov. 1, 1963 (Div.) Ohio. 2. Janet Marie Dwenger was born on June 16, 1944 at St. E. Hospital. Lafayette, In. She was married to Joseph B. Kult on Sept. 7, 1963 Dunnington. three child: (Joseph B., Jeff David, Cynthia Ann) 3. David Joseph was born on Aug. 19, 1945 at Lafayette, In. He was married to Eileen Moschel Dick, on Oct. 5, 1974 at Connersville. three child: (Ralph Kevin, Bradly Alan, Micah Renee). 4. James Urban Dwenger was born on April 12, 1947 at Lafayette. He married Betty Hislop Bryant on Oct. 25, 1980, Fowler, In. one stepchild: David W. Bryant. 5. Mary Elizabeth Dwenger was born on May 10, 1948 Lafayette, In. She married Tilford R. Cline. children: (Michelle Renee, Todd Robert) 6. Norma Jean Dwenger was born on Feb. 27, 1953 at Lafayette, In. She was married to Kenneth L. McGinnis on Nov. 6, 1971. they have two children: (Philip Leon, Kimberly). 7. Steven Allen Dwenger was born on July 18, 1954 Lafayette, In. He married Diane Lynn Sturgeon on Aug. 28, 1982 Dunnington, In. (no children). 8. Carol Ann Dwenger was born on Dec. 17, 1955 at Lafayette, In. 9. Michael Richard Dwenger was born on June 10, 1962 at St. E. Hospital in Lafayette, In.

4. Mildred Catherine Dwenger was born on Aug. 8, 1913 at Benton Co. In. She died on June 16, 1983 at St. Elizabeth Hospital. Single

5. Marcella Clara Dwenger was born on Nov. 22, 1918 at Benton Co. In. She was not married.

6. George William Dwenger was born on April 6, 1924 at Benton Co. In. He was married to Lois Altepeter on May 1, 1946 at Dunnington, In

7. Donald Raymond Dwenger was born on March 13, 1930 at Benton Co. Indiana. He was married to Margaret E. Albertson Mann on Aug. 29, 1975.

WILLIAM AND CATHERINE (RAVER) DWENGER

William Dwenger was born in Cinn. Ohio on Jan. 3, 1839, the son of Bernard and Catherine Dwenger. His father Bernard was born on Oct. 1, 1806 Bavaria, Germany and his mother Anna Catherine (Wilmering) Dwenger who was born in 1807 Hanover, Germany. He was one of four children that we know of: William (self), Catherine (Welling), Bernard, and Henry.

He lived only a short while in Ohio, and while still an infant, was brought by his parents to Indiana. His parents settled in Franklin Co. Indiana, in Ray Twp. In the small town of Hamburg in 1839.

The Dwenger family were of German decent, and still spoke the German language. They devout Catholic's and attended the Catholic church. In the early years of the settleing of Hamburg, there was not yet a Catholic church, and the families from Hamburg would dress up in their Sunday finery and pile themselves into their old work wagons (they had no fancy buggys) to drive to the town of Oldenburg to Church.

William Dwenger was married to Catherine Raver on Nov. 8, 1860 at Oldenburg, Indiana in Franklin County.

Catherine Raver was born on April 13, 1842 at Cinn. Ohio. She was the daughter of John Raver and Margaret Adelaine (Neinaber) Raver. She was one of seven children: Henry, Maria, Gesina, John, Kate, Elizabeth, and Frank F.

William Dwenger purchased land in Hamburg in Franklin Co. from his father Bernard on Aug. 25, 1863. It was the West half of the N.E. 26-11-11, 80A. for \$1000. DOLLARS. On the Franklin Co. map for 1800's the town of Hamburg is split on two townships. The top half of the town is in salt Creek twp. and the Bottom half is in Ray twp. The census finds the Dwengers residing in Ray twp., however, the map shows that they owned land in both Ray and Salt creek twp.'s. on the Eastern side of the town. In Ray twp. William Dwenger owned 100 acres East of Hamburg Twp. 11, Range 11, sec. 26.

On October 10, 1869 the first Catholic Church at Hamburg was dedicated, St. Ann's Catholic Church. Family pews were rented. Children attended a log school there, it was replaced with a brick school in 1873. This was the St. Anne's Catholic school and in the 1800's until the early 1900's it was taught in the German language.

William built a home and store on lot 11 of Hamburg. He was a merchant in the town of Hamburg, and was listed in the 1880 business directory of Franklin Co. as a dealer in dry goods, groceries, and all kinds of merchandise. An interesting finding in the Franklin County Court records, William Dwenger, was fined in 1888 and 1889 for selling liquor without a license.

He was also a postmaster in Hamburg from 1882-1889. He and Kate were members of the St. Ann's Catholic Church at Hamburg.

William and Catherine were the parents of eight children: John who married Elizabeth Weibold, William B. who married Magdalena Weimer, Frank John who married Anna Seibel, Bernard who married Elizabeth Haskamp, Carrie who married Henry Seibel, Henry (John) who married Margaret Huth, Francis who never married (died young) he was born in 1874 and died in Oct 29, 1883 at the age of nine, and Vincent who also died young, born in 1876 and died in 1879.

Catherine (Kate) [Raver] Dwenger died on March 6, 1891 from Tuberculosis at Hamburg, after a long illness several months.

William Dwenger died at Hamburg on Dec. 21, 1909 from the Bronchial pullmanary gripp. Both are buried at Hamburg.

CHILDREN OF WILLIAM AND CATHERINE DWENGER:

JOHN AND ELIZABETH(WEIBOLD) DWENGER

John Dwenger was born in 1862 in Hamburg, Indiana, the son of William and Catherine(Raver) Dwenger. He was married to Elizabeth Weibold. He was a farmer and owned a farm near Hamburg. He was said to be a tall man.

He and his wife were very religious, they never missed church. He never worked on Sundays. They attended the St. Anne's Catholic church.

They adopted two children: John Dwenger who married Anna Hessler. John Jr. lived at Millhousen, Ind. He smoked a pipe. I have no other information on their dau. Elizabeth.

John and Elizabeth later sold their farm and moved to St. Bernard, Ohio. John got a job working in a piano store. There they worked on Holy days. He told his boss that he didn't work on holy days, his boss said that he had to work, but that he could put all of his pay into collection on Sunday and it would be like he had not really worked.

John and Elizabeth remained in Cinn. They passed away and are buried there.

WILLIAM B. AND MAGDELINA(WEIMER) DWENGER

William B. Dwenger was born in 1865 in Hamburg, Indiana. He was the son of William and Catherine(Raver) Dwenger. He was married to Maria Magdalena Weimer on May 11, 1887. They were the parents of three children: 1. John who married Margaret Cahill and had four children: William, Mary, John, Shirley. 2. Caroline whonever married 3. Harold who married Leona Hahn and had five children: Jean, Ruth, Martha, Joe, Linda. Harold currently resides in Indianapolis, In. (SEE HISTORY FOR MORE INFORMATION)

FRANK JOHN AND ANNA(SEIBEL) DWENGER

Frank John Dwenger was born on Aug. 20, 1868 in Hamburg, Indiana. He was the son of William and Catherine(Raver) Dwenger. He was married to Anna Seibel, (daughter of Henry and Magdalena(Hahn)Seibel) on May 25, 1892. Frank was a farmer. They attended the Oldenburg Catholic church. Frank and Anna were the parents of six children: 1. Raymond who married Flora Rolfes and had eight children. 2. Hilmer who married Nora Walke and had three children. 3. Harry who married Mary Hessler and had ten children. 4. Stella who died at age 13 and never married. 5. Martha who married Bernard Stier and had three children. 6. Ellen who married Joe Ries and had five children. (SEE HISTORY FOR MORE INFORMATION)

BERNARD AND ELIZABETH(HASKAMP) DWENGER

Bernard Dwenger was born in 1863 at Hamburg, Indiana. He was the son of William and Catherine(Raver) Dwenger. He was married on April 29, 1885 to Elizabeth Haskamp. Elizabeth was born on Aug. 17, 1865. They lived for a while at Hamburg then moved to Cinn. Ohio? Bernard died on June 7, 1934 at age 70. Bernard and Elizabeth were the parents of nine children: 1. Joseph who married Ada Sagel and had five children. 2. Edwin who married Margaret Theising and had five children. 3. Maurice who married Wanita O'Mara and had two children. 4. Roman who married Bernadine Schroader and had two children. 5. Johanna who married Ed Meyer and had one son William. 6. Loretta who married Elmer Sherman

and had one child, Thomas Sherman. 7. Alma who married Clarence Lehman and had three children. 8. Mary who married John Schutte and who died in childbirth. 9. Elizabeth (Betty) who married Charles Ulm and had six children.
(SEE HISTORY FOR MORE INFORMATION)

MARY CAROLINE (DWENGER) AND HENRY SEIBEL

Mary Caroline (Carrie) Dwenger was born on 1879? at Hamburg In. the daughter of William and Catherine (Raver) Dwenger. She was married to Henry Seibel (The son of Henry and Magdalena (Hahn) Seibel) on Nov. 15, 1899 at St. Maurice. They were the parents of four children: 1. Eleanor who married Ed Peters and had three children: Howard, Carl, Helen. 2. Mable who married Sam Allen and had three children: Clarence, Rodney, Thelma. 3. Arthur who never married (died young) 4. Rosemary who married a Kirschner and had three children: Sandra, Linda, Carolyn.
(SEE HISTORY FOR MORE INFORMATION)

HENRY B. AND ANNA M. (HUTH) DWENGER

Henry Bernard Dwenger was born on April 2, 1892 at Hamburg, In. He was the son of William and Catherine (Raver) Dwenger. He was married to Anna Margaret Huth on Jan. 18, 1899. Henry and Anna were the parents of 14 children: 1. Leo who died young 2. Victor who died young 3. Hilda who died young 4. Olivia who died young 5. Norbert who never married, (killed in the service.) 6. Emma who never married 7. Eddie who married #1 Romilda Reer, #2 Rose Ferrender and had one stepchild. 8. Alvina who married Bill Nobbe and had nine children. 9. Alfred who married #1 Mary Myrtle #2 Gladys Wirth two children. 10. Clarence who married Bessie Wirth and had Eleven Children. Waldo who married Anna Wood and had five children. 12. Clara who married Bill Niese and had nine children. Stella married John Tekulve and had five children. 14. Paul who married Florence Mattingly and had five children.
(SEE HISTORY FOR MORE INFORMATION)

MARY FRANCIS DWENGER

Mary Francis Dwenger was born in 1874 at Hamburg, Indiana. She was the daughter of William and Catherine (Raver) Dwenger. She died on Oct. 29, 1883 at Hamburg, Indiana, at the age of nine.

VINCENT DWENGER

Vincent Dwenger was born in 1876 at Hamburg In. the son of William and Catherine (Raver) Dwenger. He died in 1879 at the age of three.



Catherine (Raver) Dwenger



William Dwenger



WM. DWENGER STORE IN HAMBURG (1886)
children down front? L to R: William;
Catherine; John; Elizabeth (Weibold);
Bernard; Elizabeth (Haskamp); Henry; &
Frank Dwenger.



William & Catherine (Raver) Dwenger
(m/Nov.8 1860) Hamburg In.

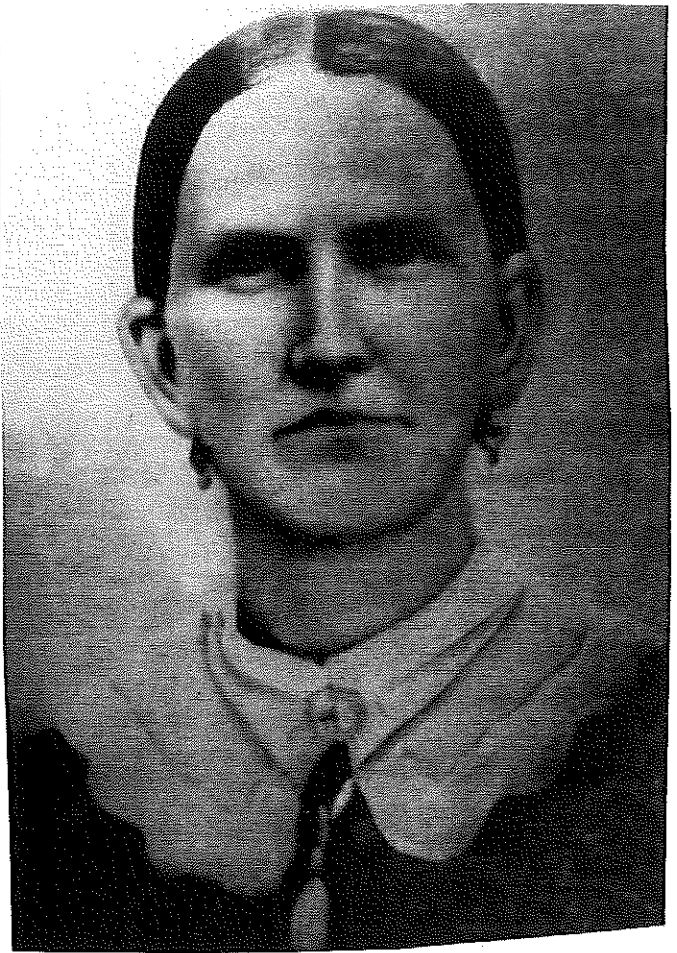

Catherine (Raver) Dwenger
(b/April 13,1842)
dau. of John Raver

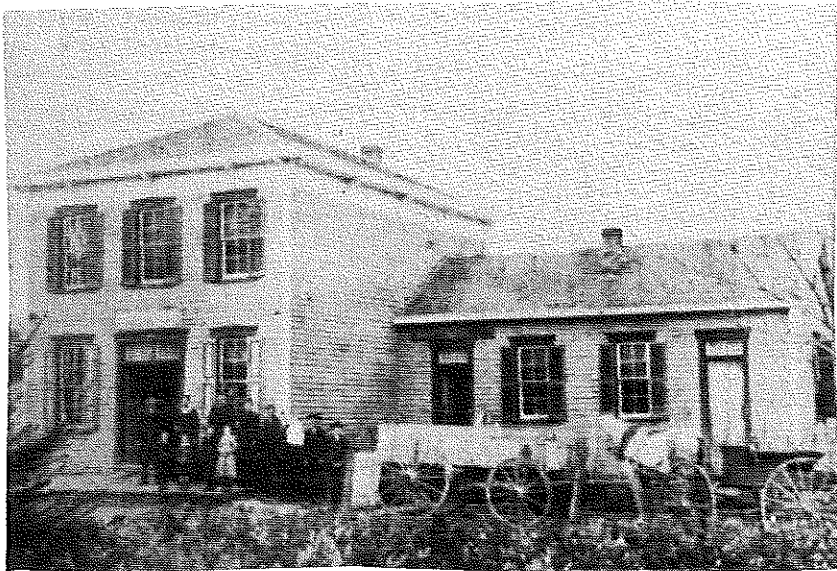

Wm. Dwenger store in Hamburg,
Franklin Co. Indiana lot 11

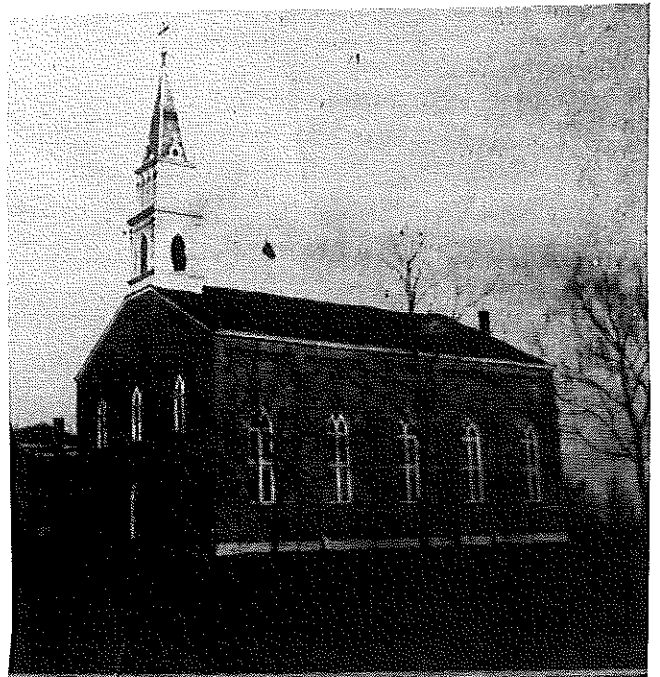

St. Anne's Catholic church
in Hamburg, In. before the
big fire.

WILLIAM BERNARD DWENGER

William Bernard Dwenger was born on May 18, 1866 in Hamburg IN. He was the son of William Bernard (b 1/3/1839; d 12/21/1909) and Anna Katherina (Raver) Dwenger (b 4/15/1842; d 3/6/1891), who were married on 11/8/1860. William was one of 7 children; his siblings were:

John			(m Elizabeth Weibold)
Bernard John	(b 5/13/1864)	(d 6/7/1934)	(m Elizabeth Haskamp)
Frank			(m Anna Seibel)
Henry	(b 4/7/1872)	(d 4/5/1953)	(m Anna Huth)
Francis	(b 1874)	(d 10/29/1883)	
Caroline	(b 1880)	(d 1932)	(m Henry Seibel)

William married Mary Magdalena (Lena) Weimer on May 11, 1887. She also was from Hamburg IN and was born on 1/25/1869 the daughter of Nicholas and Catherine (Clements) Weimer, who were both from Alsace-Lorraine. Nicholas was an undertaker. Lena's siblings were:

Ottilia Catherine	(b 5/2/1871)	(d 11/1/53)	(m John Moeller)
Peter			(n/m)
Mary Marie			(Henry Stahl)
John L.			(m Margaret Zinser?)
Clara			(Ben Kunkel)
Anna			(James Arkins)

William and Lena Dwenger had 3 children:

Anna Caroline	(b 3/22/1898)	(d 3/26/51)	(n/m)
John Edwin	(b 7/28/1900)	(d 8/54)	(m Margaret Cahill)
Harold Bernard	(b 8/5/09)		(m Leone Hahn)

William and Lena farmed in Decatur County and in Rush County near Clarksburg IN before moving in 1916 to Indianapolis IN where they lived at several addresses, eg: 1402 Union St; 2253 S. Meridian St; 109 E. Palmer; Spring Dale Pl (near Holy Cross Catholic Church, where William was custodian); and 1737 S. Talbot. William worked for J.P Michaels wholesale groceries.

William died in Sept 1933 and Lena 11/1/53. They are buried in St Joseph/Holy Cross Cemetery in Indpls.

By J.H. Dwenger
12/22/92

Anna Caroline Dwenger

Anna Caroline (Carrie) Dwenger was born on March 22, 1898 in Indianapolis IN. She was the daughter of William Bernard (b 5/18/1866; d 9/1933) and Mary Magdalena (Weimer) Dwenger (b 1/12/1869; d 11/1/1953), who were married on 5/11/1887 in Hamburg IN. Carrie was one of 3 children; her siblings were:

John Edwin (b 7/28/1900) (d 8/54) (m Maragaret Cahill)
Harold Bernard (b 8/5/09) (m Leone Hahn)

Carrie never married but was a friend of Leo Kuntz for many years. She called Leo "Grandpa" because his idea of a date was to sit and swing on the front porch rather than go somewhere.

She worked in the capsule manufacturing department at Eli Lilly & Co in Indianapolis until she contracted tuberculosis and had to resign. She lived with her Aunt Carrie (Dwenger) Seibel in St Maurice IN for about 1 year while she recuperated from the illness. She returned to Indianapolis, worked at Thomas & Skinner Steel Products, and lived with her mother until she (Carrie) died of cancer on March 26, 1951.

Carrie was very fond of children and frequently brought gifts to her nieces and nephews.

By J.H. Dwenger
9/4/93

1
2
3
4
5
6
7
8
9
10
11
12
13
14
15
16
17
18
19
20
21
22
23
24
25
26
27
28
29
30
31
32
33
34
35
36
37
38
39
40
41
42
43
44
45
46
47
48
49
50
51
52
53
54
55
56
57
58
59
60
61
62
63
64
65
66
67
68
69
70
71
72
73
74
75
76
77
78
79
80
81
82
83
84
85
86
87
88
89
90
91
92
93
94
95
96
97
98
99
100

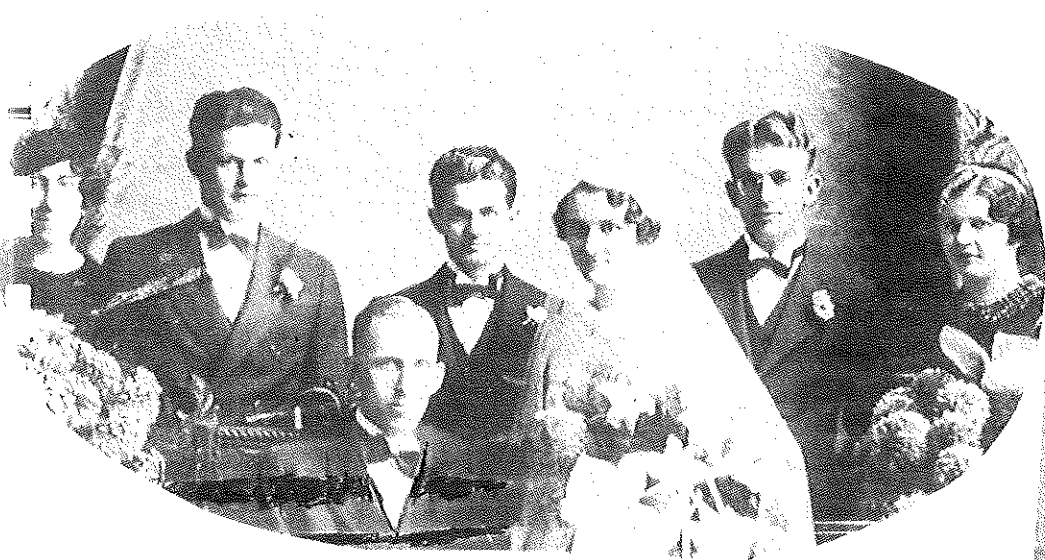

WEDDING OF HAROLD AND LEONE(HAHN) DWENGER
 MARRIED ON: Oct.18,1934 Decatur Co. L to R:
 carrie Dwenger,Felda Hahn,David Hahn,Bill Moeller,Mary Hahn
 sitting: Harold Dwenger, Leone(Hahn) Dwenger

Carrie(Dwenger) Seibel wife of
 Henry Seibel. born/1879
 (daughter of William and Catherine
 (Raver) Dwenger.



Harold and Leona(Hahn) Dwenger
 taken: 1992

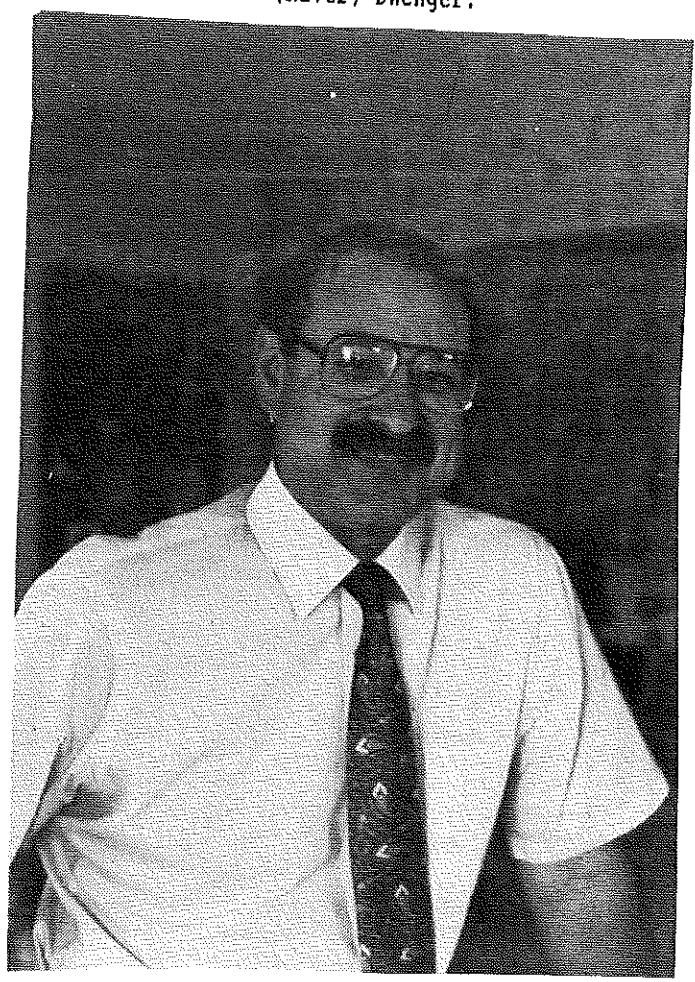

Joseph Dwenger- son of Harold and
 Leona(Hahn) Dwenger 1992

HAROLD BERNARD DWENGER

Harold Dwenger was born on Aug 5, 1909 on a farm near Springhill IN. He is the son of William Bernard and Mary Magdalena (Weimer) Dwenger. His mother said that on the day he was born, she had to get up to cook for the threshers. Harold was one of 3 children; his siblings were:

Anna Caroline (Carrie) Dwenger (b 03/22/1898) (d03/26/1951) (n/m)
John Edwin Dwenger (b 07/28/1900) (d 08/1954) (m Margaret Cahill)

Harold moved with his family to Clarksburg IN when he was very young. They then moved to 1402 Union St in Indianapolis IN when he was in the 2nd grade. The Dwenger family lived at several locations: 2253 S. Meridian, 109 E. Palmer, and 1737 S. Talbot. He met Leone Olive Elizabeth Hahn through cousins, the Moeller family, who lived close to and were friends with the Hahns, who lived at the time on Milhousen Road south of Greensburg IN.

Leone Hahn was the oldest daughter of Albert Daniel and Anna Evangeline (Tucker) Hahn. She was born on Feb 14, 1909 when the Hahn family lived on a farm in Rush County IN. She had 5 siblings:

Leo David	(b 07/24/11) (d 5/2/91)	(m Verna Eichacker)
Valentine Herbert (Feltie)	(b 12/29/13) (d 1/7/91)	(m Constance Campbell)
Mary Gertrude	(b 11/18/15)	(m Clyde Pate)
Alfred Ernest (Fritz)	(b 06/08/24) (d 5/26/92)	(m Elanca Mijeska)
Rollin Wilfred	(b 12/07/29) (d 10/12/89)	(n/m)

Leone lived in Indianapolis while attending Central Business College and was staying with a family (Perrine) whose son contracted scarlet fever, and she needed another place to stay. Harold's sister, Carrie, invited Leone to stay at their house. Harold needed a date for a Demolay dance and asked Leone to go with him, and although they had known each other for some time, this was their first date. The rest is history: Harold and Leone were married at St Mary's Catholic Church in Greensburg IN on Oct 18, 1934.

When they were first married, Harold and Leone lived with his parents at 1737 S. Talbot, in Indianapolis. While on a walk in the neighborhood, Leone noticed an empty house and contacted the owner, who was surprised that the renters had left; he sold the house at 21 E. Caven St to Harold and Leone. They lived in that house until 1954, when they moved to and still live at 102 W. Sumner Ave, Indianapolis.

Harold worked for many years as a salesman for Crutcher Dental Supply Co, Ransom and Randolph, and finally retiring from Ryker Dental Supply Co. Leone worked as a homemaker.

Harold and Leone had 5 children; 4 are still living:

Jean Theresa Dwenger	(b 11/23/35)	(m Donald L. Bohn)
Ruth Ann Dwenger	(b 08/29/37) (d 09/23/41)	
Martha Mary Dwenger	(b 04/30/40)	(m James G. Curd)
Joseph Harold Dwenger	(b 01/23/45)	(m Victoria Mascari)
Linda Maria Dwenger	(b 10/21/54)	(m/d Michael Lytle)

Jean is a secretary in Ft Collins CO and has 4 children and 3 grand children. Ruth Ann died as a child. Martha is a nurse in Indianapolis and has 6 children. Joseph is a pharmacist in Indianapolis and has 4 children. Linda is a sales assistant and lives in Indianapolis; she has 2 children.

Harold and Leone have lived a rich life and have many friends.

By J.H. Dwenger
12/22/92

JOSEPH HAROLD DWENGER

Joseph Dwenger was born January 23, 1945, in St Francis Hospital, Beech Grove IN. Son of Harold Bernard Dwenger (b 8/5/09) and Leone Olive Elizabeth Hahn (b 2/14/09). Joe is one of 5 children; the other 4 are:

Jean Theresa Dwenger	(b 11/23/35)	(m Donald L. Bohn)
Ruth Ann Dwenger	(b 8/29/37) (d 9/23/41)	
Martha Mary Dwenger	(b 04/30/40)	(m James G. Curd)
Linda Maria Dwenger	(b 10/21/54)	(m/d Michael Lytle)

Joe attended Sacred Heart and St Roch Grade schools and Sacred Heart Central High School in Indianapolis IN and graduated from Purdue University School of Pharmacy (BS) in 1968. Hobbies include golf, gardening, and photography.

Joe currently is employed at Eli Lilly and Co.

Joe met Victoria (Vicki) Mascari while attending high school, and they were married July 6, 1968. Victoria is one of 8 children and was born a twin on March 11, 1946 to August and Naomi Ruth (Franks) Mascari in Beech Grove IN. Vicki's brothers and sisters are:

Joan	(b 10/28/44)	(m Terry Shannon)
Michael	(b 3/11/46 twin)	(m/d Vicki Roberts)
Thomas	(b 10/13/48)	(m Therese Butler)
August	(b 4/3/54)	(m Elizabeth Sparks)
Frank	(b 10/4/55)	(m Mary Savage)
Alice Annette	(b 4/5/61)	(m/d Randy Ward)
Victor	(b 11/12/63)	

Vicki works as a physician's assistant in Indianapolis IN. She enjoys shopping.

Joe and Vicki lived in Indianapolis from 1968 to 1972, when they moved to Roanoke VA, where Joe worked with the Elizabeth Arden division of Eli Lilly. In 1979, they moved back to Indianapolis IN.

Joe and Vicki had 5 children; 4 are still living:

David Dwenger	(b/d 5/17/69)
Ellen Marie Dwenger	(b 10/19/70)
Kristen Louise Dwenger	(b 2/19/72)
Sara Elizabeth Dwenger	(b 7/03/73)
Emily Anne Dwenger	(b 4/23/78)

Ellen is a student at IUPUI and has always been talented artistically; she is studying to be an occupational therapist. Kristen is at Purdue Univ studying communications. She is a member of Alpha Chi Omega sorority and has been active in sorority and university activities. Kristen is a talented singer and dancer; she was a cheerleader in high school. Sara is studying biology at Un Dayton. She has sung professionally and climbs mountains for a hobby. She also was a high school cheerleader. Emily is a freshman at Roncalli High School. And, yes, she sings and plays piano and is a cheerleader, also. All four daughters sing (harmonize) well together and won an award at the Marion County fair, but they seldom have time together to practice.

Joe and Vicki currently live at 8530 S. Franklin Road, Indianapolis IN 46259. They are concerned about college expenses and forthcoming weddings for four daughters. But they are excited about the prospect of having grandchildren someday. Both Joe and Vicki were raised in the Catholic Church and attended parochial school systems. Their family continues to be active at Nativity Catholic Church in Indianapolis.

By J.H. Dwenger
12/22/92

BERNARD AND ELIZABETH (HASKAMP) DWENGER

Bernard Dwenger was born in 1863 at Hamburg Indiana in Ray township, Franklin Co. He was the son of William Dwenger b/1839 in Ohio and Catherine (Raver) Dwenger b/1842 in Indiana. He was nicknamed (Ben) by his friends and family, he was one of eight children; John b/1862; William b/1865; Frank b/1868; Bernard b/1863; Carrie (Seibel) b/1878; Henry b.1872; Francis b/1874(died young); Vincent b/1876 (died young).

Bernard parents were devout member of St. Anne's Catholic Church in Hamburg. They were among the early settlers in Franklin Co. in Ind.; they were of German decent and still spoke German frequently. Bernard attended the St. Anne's Catholic school in Hamburg when he wasn't needed to help in the fields. At this time the school was taught in German. Bernard was married on April 29, 1885 at Hamburg Indiana, to Elizabeth Haskamp.

Elizabeth Haskamp was born on Aug,17,1865 at Oldenburg Indiana. She was the daughter of Joseph and Mary (Willinber) Haskamp. She was one of four children; Mary; Henry; Bernard; Elizabeth. Her father, Joseph Haskamp died on Feb.24,1894 in Franklin Co. In. Bernard Dwenger was the owner of a Threshing Machine, he would take it to several farms where they would thresh a farmers wheat, with a whole bunch of friends and neighbors to help. His son Maurice often had to carry water to the working men.

Bernard owned a farm in Franklin County In. near Hamburg. The farm was not a real productive farm and he turned to other sources of revenue also. Bernard established a sawmill on the curve going into Hamburg, which he worked in also.

Bernard and Elizabeth's children attended the Hamburg Catholic School as Bernard had. Some of the children went to the High School at Clarksburg, in Decatur Co. Indiana. Hamburg is not far from the Franklin Co., and Decatur Co. lines ,also the Ripley Co. line isn't far away also. Bernard (Ben) Dwenger passed away on June 7,1934 at the age of 70. Elizabeth (Haskamp) Dwenger continued to live on the farm. Bernard and Elizabeth (Haskamp) Dwenger were the parents of ten children;

1. Joseph B. Dwenger was born in Hamburg Indiana. He was married on Aug.16,1917 to ^(^A^A^A) Adelheide the daughter of Gerhard and Merie Margaret (Heilman) Sagel. They had 5 children; Margaret, Jean Virginia, Ruth, Joseph.

2. Edwin Dwenger was born at Hamburg and married Margaret Thiesing. They had 5 children, Sally, Jane, Georgeann, Marilyn, Richard.

3. Maurice Dwenger was born in 1907 at Hamburg In. He was married to Juanita O'Mara. Juanita is currently living in Indianapolis Indiana. Maurice and Wanita had two children; Susan and Karen.

4. Roman Dwenger was born at Hamburg. He married Bernadine Schroeder in 1926. She was the daughter of William and Maria Agnes (Meyer) Schroeder. They had two children; Louise, Mary Elizabeth b/1936 married in 1957 to Alphonse Koetter and had three children; Andrew, Michael, Jean.

5. JoAnna Dwenger was born at Hamburg and married Ed Meyer in 1916. They had a son William Meyer.

6. Loretta Dwenger was born in Hamburg. She was married to Elmer Sherman. They had a son Thomas Sherman.

7. Alrma Dwenger was born in Hamburg. She was married to Clarence Lehman. They had three children; Jim; Joan; Rita.

8. Mary Dwenger was born on Sept. 1, 1915 at Hamburg. She was married to John Schulte in 1915. She died in childbirth. John Schulte married a second time to Clara Raver. They had two children; Clarence H. Raver and Marhta (Blankman).

9. Elizabeth (Betty) Dwenger was born at Hamburg. She married Charles Byrum Ulm in 1912. They had 6 children; Charles, Frank; Virgil; Orman; Jack; Betty; (*see Charles & Betty Ulm history*).

10. Anna Marie Dwenger was born on April 14, 1870 and died on July 16, 1873 a Hamburg in Franklin Co.

CHARLES AND ELIZABETH(DWENGER)ULM

Elizabeth Henriett Dwenger was born on Feb.14,1912 at Franklin Co. Indiana. She was the daughter of Bernard b/1863 Hamburg, In. and Elizabeth (Haskamp) Dwenger b/1865 Oldenburg, In. (Bernard and Elizabeth Dwenger were married on April 29,1885) She grew up on a farm near Hamburg, Indiana in Franklin Co. Her family attended the St. Anne's Catholic Church in Hamburg. She was one of nine children: Joseph, Edwin, Maurice, Roman, Johanna, Loretta,Alma,Mary,Elizabeth. (she died in an accident on June 9,1948 Cinn.Oh.)

Elizabeth was called by her nickname of "Betty". She attended the Catholic school at Hamburg.

Elizabeth(Betty) Dwenger was married to Charles Byrum Ulm on Feb.14,1912 at Franklin Co. Indiana.

Charles Byrum Ulm was born on Dec. 18,1895, probably at Hamburg, IN. He died on June 9,1948. He was the son of Frank and Ella(Byrum) Ulm. Frank Ulm was born in 1857 in Germany. His family emigrated to the United States in 1865 when Frank was 9 years old. He passed away on Jan.14,1935 at Alexandria, Ky. Ella (Byrum)Ulm was born in 1859 Germany. She died on Aug.8,1938 Ky. They were the parents of five children.

Charles and Elizabeth(Betty) Ulm lived in Cinn. Ohio. They were the parents of six children: 1.Charles,2.Frank,3.Virgil, 4.Elizabeth,5.Arman,6.Jack.

1.CHARLES BERNARD ULM was born on Nov.13,1913. He was married to Goldie Rorig. They were the parents of a son Roger Ulm born in 1934. He and Goldie were divorced and he was remarried to Marie Smith. They were the parents of two sons: 1.Charles b/1941 and 2. Jack Wendall b/1944. He died of gunshot wounds in Aug. 1946 buried in Alexandria, Ky.

2.Frank Joseph Ulm was born on April 15,1915 Ohio. He was married in Aug. of 1939 to Lillian Sanderman b/Dec. 1912. They were divorced and he remarried to Geneva Ulm. He was the father of two children: David Vaughn Ulm, JoAnna Ulm.

1.David Vaughn Ulm was born on Dec. 28,1941. He was the father of two children:A. David Vaughn Jr. b/1963 he had two child:Jamine Ulm and Wesley David Ulm. Ohio B.Cheryl Ulm b/1965 she married J. Hatfield. She had a son John Hatfield b/1988.

2.JoAnna Ulm was born on Oct.15,1946.(Adpt.) She married a man named Fisher. They reside in Florida. She has two children. A. Christopher b/April 7,1973. B.Layla Christina b/Aug. 1,1975.

3.Virgil Edward Ulm was born on Aug.4,1917. He was married in Nov. of 1939 to Alice Porter, Daughter of Earl Porter and Anna(Inza)Porter. Virgil served in the U.S. Military in W.W.II. He passed away on May 6,1978 in Ohio, from Cancer.

1.Leon Charles Ulm was born on July 14,1942.He married Mary Ann Kramer. 3child:Michelle, Karen m/Terry, Matt.,Sarah.

2.Anette Ulm was born on Sept. 8,1953 Cinn. Ohio. She married a Gegner.(Div.) a child: Kimberly Gegner b/1974

3.Pamella Ulm was born on Aug.27,1955. She was married on July 1,1978 to Steve H. Siple. They had a child Christopher Steven Siple b/April 19,1982.

4.Elizabeth(Betty) Charlene Ulm was born on Oct.11,1919. She was married twice. M#1 William Clinton Shaw on April 17,1839. She was divorced on Feb.29,1963. She remarried on Nov.9,1971 to Grover C. Lacy. b/Dec.31,1919. Betty passed away in May of 1986 from lung cancer. She was the mother off two children:Carol and Paula Shaw.

1.Carol Ann Shaw was born Aug.31,1943. She is a registered nurse. She was married to Robert R. Roberts b/July 9,1943. two child: Laurie Ann Roberts b/April 17,1963,Traci Lee Roberts b/Dec.9,1965 2.Paula Kay Shaw was born on June 12,1951. She married Edward Alfring III.They reside in South Carolina.They have four children

Lisa Alfring, Patty Alfring, Edward Alfring !V, Joshua Alfring.

5. Armin Eugene Ulm was born on Feb. 22, 1922 in Ky. He married Jean Ulm. Armin served in the U.S. armed forces in W.W.II. Armin passed away in Aug. of 1979 at El Paso Texas. He had a son Armin Eugene Ulm Jr. b/1949.

6. Jack Christopher Ulm was born on Oct. 13, 1925 in Glendale, Ohio. Jack enlisted in the U.S. Navy. He was a navigator, He was a Navy Bombadeer in W.W.II. He retired from the Navy after 28 years. He also was a truck driver and oil refinery. He was married to Rose Frano an Italian. They divorced. He remarried on March 25, 1958 to Ruth Irene Harris b/Sept. 20, 1922 at Birmingham, Alabama. She was the daughter of Oliver Phlex Harris b/Dec. 15, 1898-d/1973 and Ruby Irene (Robinson) Neil Harris b/April 25, 1903-d/1961. They presently reside in Texas. They are the parents of five children.

1. Mary Ann Ulm (Daughter of Jack and Rose)

2. William Ulm was born on April 15, 1949 son of Jack and Ruth Irene. He was married to Rebecca Ulm.

3. Joseph (Joe) Ulm was born in 1953. He is married to Darlene.

4. Jack Edward Ulm was born on Aug. 24, 1959 at Sanford Florida. He was married on Oct. 14, 1983 in Arizona, to Rhonda Marie Sterges who was born on Dec. 31, 1955. No children

5. Charles Raymond Ulm was born on March 22, 1961 at Oak Harbor Washington, State. He was married on June 10, 1987 in San Marcus Texas to Rhonda Deann Stamps who was born on Sept. 20, 1961. They had two children: Michael Ulm b/June 13, 1981 and Ryan Matthew Ulm b/Feb. 8, 1988.

MAURICE AND JUANITA (O'MARA) DWENGER

Maurice W. Dwenger was born on Feb. 25, 1907 at Hamburg, Indiana, in Franklin County. He was the son of Bernard and Elizabeth (Haskamp) Dwenger. Maurice was one of nine children: Joseph, Edwin, Maurice, Roman, Johanna (Meyer), Loretta (Sherman), Alma (Lehmann), Mary (Schutte), Elizabeth (Betty Ulm).

Maurice's family attended the St. Anne's Catholic church at Hamburg Indiana. He attended the St. Anne's Catholic school there.

Maurice worked in the timber business. They sold logs to the C. H. Marsh Lumber Company. On one trip to deliver logs he met Juanita O'Mara, who worked as a bookkeeper at the Marsh Lumber Co.

Maurice Dwenger was married on July 28, 1934 to Juanita Dwenger.

Maurice and Juanita Dwenger were the parents of two daughters. 1. Susan Dwenger and 2. Karen Dwenger. They resided in the city of Indianapolis, Indiana.

Maurice Dwenger passed away on April 25, 1987. Juanita is presently living on Pennsylvania Street in Indianapolis, In.

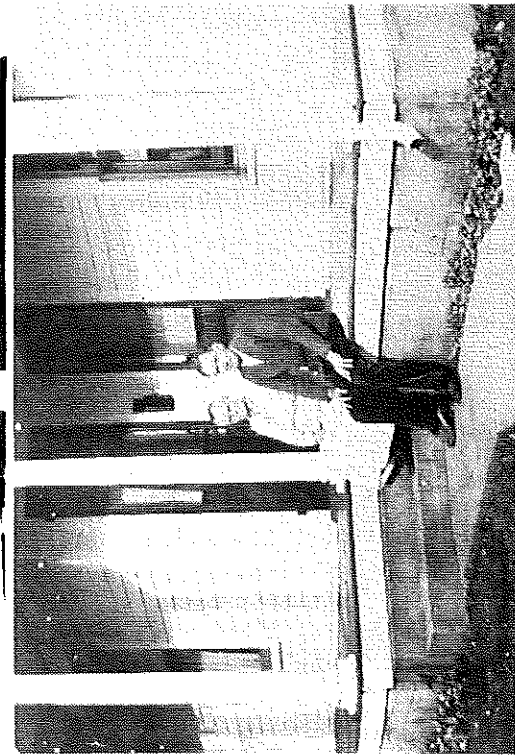

Bernard and Elizabeth (Haskamp) DWENGER
 (parents of Elizabeth (Dwenger) Ulm)

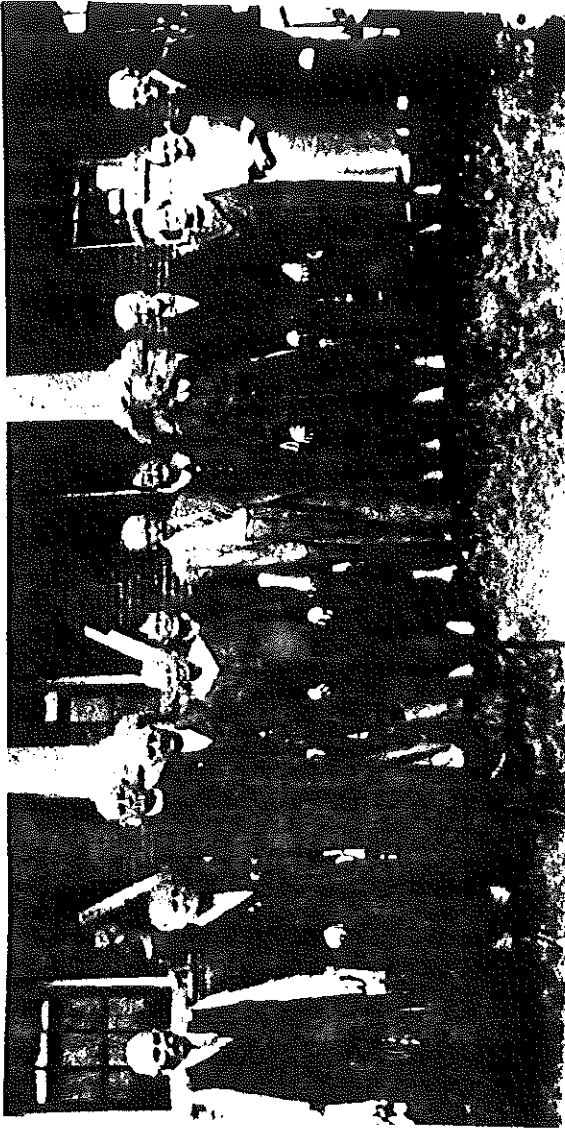

FATHER HASKAMP
 MOTHER GRADINA DWENGER
 (Betty) Group picture of Dwenger's and Haskamps

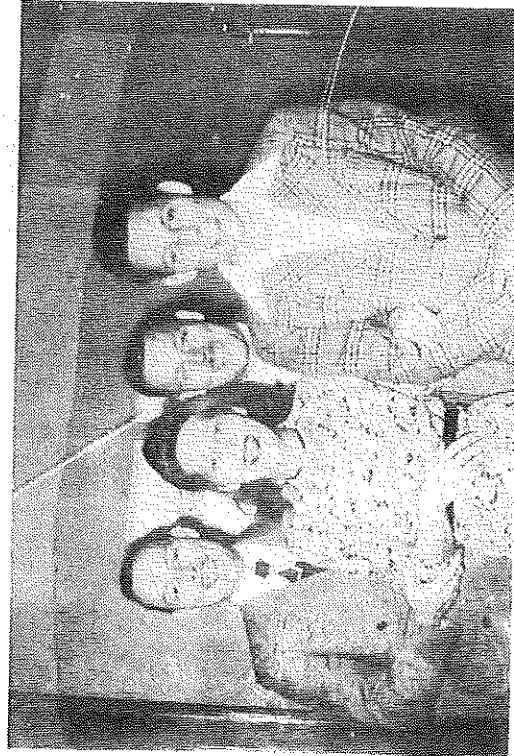

L to R: Virgil E. Ulm, Elizabeth (Ulm) Shaw, Frank Ulm, Jack C. Ulm, taken after the return W.W.II 1940's



William and Betty (Ulm) Shaw
 taken April 7, 1943

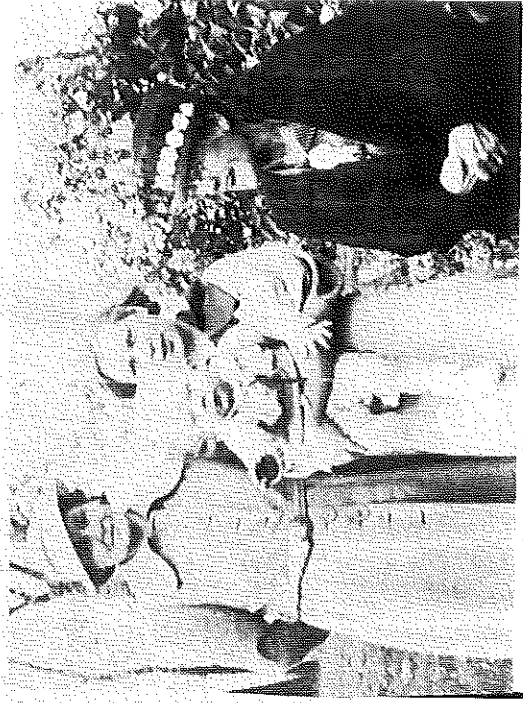

L to R: Elizabeth (Dwenger) Ulm, Goldie H/Roger Ulm, Grandma Ulm 1935

HENRY AND CAROLINE (DWENGER) SEIBEL

Henry Seibel was born in 1874 at Hamburg, Franklin County, Indiana. One of eleven children, he was the son of Heinrich Seibel and Magdalena (Hahn) Seibel.

Caroline (Carrie) Dwenger was the daughter of William Dwenger and Anna Katharina (Raver) Dwenger. Carrie was born in Hamburg, Indiana, the youngest of seven children.

Henry and Carrie were married November 15, 1899 at the Hamburg Catholic Church. They farmed land near Clarksburg, Indiana and on the Kitchen Family farm near Kingston, Indiana. Later, they moved to St. Maurice, Indiana, where Henry used his carpentry and woodworking skills. His skill was such that he made a very realistic three foot high cherry rolltop desk for his daughter, Rosemary.

Henry loved to hunt and was proud of his hunting dogs.

Their eldest daughter, Eleanore, always spoke highly of her parents, although she often recalled one disappointing Christmas. It seems she went snooping (who hasn't) before Christmas, and as her punishment, the very nice doll she had seen never did show up under the tree.

Their apparently happy life in St. Maurice was shocked by Henry's sudden death at age 52 in 1927. He died from a heart attack on the eve of a planned trip to Cincinnati to visit their daughter, Mabel, who had moved there. Carrie continued to live in their St. Maurice home until her death from cancer at age 53 in 1932.

Their four children included:

Eleanore Magdalene (Seibel) Peters, born 8-12-1900, was married November 15, 1921 to Edward Henry Peters. They lived in Decatur County, Indiana, and were the parents of three children, Helen (Peters) Lime, Carl, and Howard. Carl lives at Greensburg, while Helen and Howard live in Indianapolis. Edward and Eleanore died in 1965 and 1990, respectively.

Mabel Elizabeth (Seibel) Allen, born June 7, 1904, was married June 25, 1927 to Samuel James Allen. They lived in Cincinnati, Ohio and were the parents of three children, Thelma (Allen) Eckart, Clarence, and Rodney. all of whom live in the Cincinnati area. Sam and Mabel died in 1985 and 1987, respectively.

Rosemary Bernadette (Seibel) Kersker, born 1918, was married 12-24-1937 to Clifford Kersker. They lived in Cincinnati, and Charlotte, NC. They had three daughters, Sondra (Kersker) Edgar Hudgen, Carolyn (Kersker) Walters, and Linda (Kersker) Elrod, all of the Charlotte area. Rosemary died in the late 1970s, and Cliff died in the mid 1980s.

(See Seibel history for more information)

HENRY BERNARD DWENGER and ANNA MARGARET HUTH

Henry Bernard Dwenger was born on April 2, 1872 at Hamburg Indiana, in Franklin County. He was the son of William Dwenger born in 1839 Cinn. Ohio and Catherine (Raver) Dwenger, born in 1842 Cinn Ohio. He was one of eight children: John, William, Frank J., Bernard, Carrie, Henry*, Francis, Vincent.

His was raised in the small town of Hamburg, where his parents owned and operated a dry goods store.

He attended the Hamburg school to the fifth grade. This was quite common for the time, when children were needed to help out at home and on the farms.

Henry went on to become a highly successful and respected carpenter. He would draw up his own detailed blueprints for the barns, houses, sheds, etc... which he would build. He would draw his blueprints out on the back of rolls of wallpaper, which he would lay out across the kitchen table as he worked.

He was married to Anne Margaret Huth (pronounced Hoot) on Jan. 27, 1899 at the Hamburg Catholic church. Anna was a quiet lady, who stayed at home mostly. always had long hair which she would keep put up. They were Catholics and attended the Catholic church there. (They became the parents of 14 children.)

After they were married Henry went to work on a farm outside of Hamburg, where he worked for his rent, a hog, etc.. On Dec. 16, 1899 their first child, Hilda Elizabeth was born.

The family at this time moved to the nearby town of Oldenburg because of better wages. Their second child, William Edward, was born on Aug. 8, 1900 at Oldenburg Indiana. It was said that Edward helped his dad out with his carpentry from the time that he was old enough to hold a hammer.

Their next baby, Alvina Caroline, was born on April 8, 1901. While Alvina was little yet, their oldest daughter, Hilda, became ill with the diarrhea. She dirtied twenty-four diapers in a row. The doctor told them that it was the milk and that the next day they should get her a different kind, but she died before they were able to get it. It was Jan. 10, 1901, she was three years and 26 days old.

Their next baby, Emma Emilia was born on Nov. 15, 1902. (She had a hip out of joint which made one leg shorter than the other, and had to walk with crutches.)

Olivia Christine was their next child, born on Feb. 29, 1906. Olivia died when she was four months and 1 day old from croup.

On April 19, 1907 Alfred William was born. They were living in the country near Hamburg at this time. Clarence John was born on Feb. 13, 1909. Another son Leo Francis was born in 1911.

The children attended the Hamburg school, and when Emma was the age to begin school, age 7, she could not walk yet or with much pain and difficulty. The family moved into the town of Hamburg so there would not be a long distance for the children to walk to the school. When Emma began school she was fitted with crutches and a special shoe to enable her to walk.

Their son Henry Victor was born on Dec. 9, 1913. On April 3, 1914 Their son Leo was in the high chair and somehow fell out hitting his head. He was crying and so they put him to bed. He fell asleep and never woke up. He was 3 years and 3 months old. Ten days later the baby Victor, came down with croup, and died on April 14, 1914. They were buried at Hamburg.

Son Peter Waldo was born on Nov. 2, 1914 and daughter Clara Anna was born March 29, 1915, and Stella Catherine born July 8, 1919. Their son Norbert Hilmer was born on Jan. 11, 1919 and the youngest child Peter Paul, was born on Oct. 8, 1922.

Henry and Anna always kept chickens. Anna tended the chickens and would sell the eggs at the Bedel store in Hamburg. (Dwenger store was gone.) This gave her her egg money for spending.

Henry owned one of the first cars in Hamburg which he purchased around 1914. It was a new car which he used to get back and forth to his different jobs.

Their daughter Emma attended the academy at Oldenburg, after graduating she went to the city.

Henry altogether owned two houses and two farms, but each at different times, all were in the area near Hamburg. The last house that he owned was in Hamburg, near his son Clarence.

Around 1932, Anna was diagnosed with breast Cancer. The doctors did surgery and removed the left breast and much of the muscle from her left arm. She had always had long hair and she brushed it every day, but after the surgery she was unable to reach up to brush her hair any longer. The Cancer did not return.

Anna was later diagnosed with a goiter. This grew larger and larger making it hard for her to breath. She would sleep by the window to get enough air to breath. She eventually was completely unable to breath, and died from the goiter on April 3, 1935, at her home in Hamburg.

Anna and Henry's sons Norbert and Paul were in the service in 1943, during W.W.2. Norbert died on Dec. 22, 1943 of pneumonia. When he got pneumonia the doctors discovered that he only had one lung. The funeral was held the day after Christmas. Right after the funeral Henry got word that his son Paul had been shot by a sniper and was in a hospital. No word on his condition was given. Henry worried terrible, wondering if he was to loose another son. Paul was transferred to a hospital in Georgia from where he wrote to

his dad informing him that he was doing fine, and he had only been wounded in the arm.

As Henry became older he lived alone for quite a while. After his retirement, his son Ed, took over the business. Henry would walk over to his son Clarence's home, to visit and talk. Henry enjoyed telling stories of the old days.

As Henry became older and required extra care, as he could hardly get around. He went up to Indianapolis to the, 'Little Sisters Of The Poor'. He was only there two weeks before he passed away on April 5, 1953. He was buried at Hamburg.

Henry and Anna Dwenger were the parents of 14 children:

1. Elizabeth Hilda b/Dec. 16, 1899 - died Jan. 10, 1901.
 2. William Edward b/ Aug. 8, 1900 at Oldenburg In. He helped with the family business. He married Romilda Reer in 1944. a second marriage to Rose Brockman Fasbinder in 1948. One stepchild, Jerry Fasbinder.
 3. Caroline C. Alvina b/ April 8, 1901 and attended the Hamburg school. She was married to William Nobbe on Oct. 7, 1927 at Hamburg. They were the parents of 9 children: John, Richard, Rosemary, Ambrose, Jimmy, Harold, Eileen, Raymond, Lucille.
 4. Anna Emilia b/ Nov.15, 1902 near Hamburg. She never married. She was employed at the St. Anthony messenger magazine, for over 40 years. She made her home at the Fontbone, spending much of her spare time with her family in Indiana.
 5. Olivia Christine b/ Feb. 16, 1906 and died at age four months from the croup.
 6. Alfred William b/ April 19, 1907 on a farm near Hamburg. He was married to Myrle Vivian Newkirk in 1931. They had a daughter, Mary Francis. He was married a second time to Gladys Wirth. He has a son: Alfred(Earl) who was a preacher.
 7. Clarence John b/ Feb. 13, 1909 at Hamburg. He attended the Hamburg school. He was married to Bessie Wirth on Thanksgiving Day 1935, at the priests house. They are the parents of eleven children: Betty Ann, Robert, Donny, William, Tom, Doris Jean, Rita, Jim, Lloyd, Adolph, Habel. They reside in Hamburg.
 8. Leo Francis b/1911 and died from a fall on April 3, 1914.
 9. Peter Waldo b/Nov.2, 1914 Hamburg. He was married to Anna Woods. They were the parents of five children: Paris, Waldo, Hazel, Anna Rose, Henry Joe.
 10. Henry Victor b/Dec. 9,1913 and died of the croup on April 14, 1914. buried at Hamburg.
 11. Clara Ann b/ March 29, 1915 at Hamburg. She was married to William Niese in 1939. They were the parents of nine children: Eugene, Jerold, Joe, Robert, Greg, David, Will, Sharon, Dennis.
 12. Stella Catherine b/ July 8, 1917 at Hamburg. She was married to John H. Yekulve in 1941. They were the parents of five children: Mary, Ronald, Virginia, Marlene, Kathleen.
 13. Wordbert Hilmer b/Jan. 11, 1919. died while in the service from pneumonia on Dec. 22, 1943. not married.
 14. Peter Paul b/ Oct. 8, 1922. Fought and was wounded in W.W.2. He was married to Florence Mattingly in 1945. They were the parents of five children: Janice, Kenneth, Debbie, Rick, Randy.
- HISTORIES OF CHILDREN OF HENRY AND ANNA DWENGER:

1. Hilda Elizabeth Dwenger was b/December 16,1899 near Hamburg Indiana. She died at age three.

2. William (Edward) Dwenger

William (Edward) Dwenger was born on Aug. 8, 1900 at Oldenburg Indiana.(son of Henry and Anna(Huth)Dwenger) He attended school at Hamburg in Franklin Co. He was married to Romilda Reer in 1945. A second marriage was to Rose (Brockman) Fasbinder in 1948. He had one stepchild, Jerry Fasbinder, who married Marcia Fehlinger.

W. Edward Dwenger was a carpenter. He helped his father, Henry, with the family business from a very early age. He eventually took over after his father's retirement.

3. Alvina Caroline (Dwenger) and Wm. Nobbe

Alvina Caroline Dwenger was born on April 8, 1901 near Hamburg, the daughter of Henry and Anna (Huth)Dwenger. She was married on April 7, 1927 at the Hamburg Catholic church, to William Nobbe. William was a farmer. They lived on a farm near Kingston, in Decatur Co. In.

Alvina and William Nobbe had nine children- John, Richard, Ambrose, James, Ray, Rosemary, Eileen, Lucille, Harold.

Histories of children of Elvina and Wm. Nobbe:

A. John Nobbe, married Alice (Yeager). They reside at Batesville In. in Ripley Co. Their children are, 1. Ruth Ann who married Ben Starost, their children:(Tom, Gennifer, Michelle, Ben, Amanda). 2. Roy married Debbie(Effing) and have three children:(Jama, Jarod, Stephanie), 3. Arthur married Elaine(Munchel) and have four children (Robert, Todd, Amy, Aaron), 4. Frank married Vicki(Speckman) and have two children,(Angela, Travis), 5. Marjori married Perry Suding and has two children,(James, Glen), 6. Andrew, 7. Bernice, 8. barnard.

B. Richard Nobbe, married Hilly(Meyers). They reside at Greensburg In. They were the parents of five children: 1. Steve Nobbe

married Theresa Hoeing. 2. Marilyn (Hobbe) married Randy Hoeing. 3. Rick Hobbe married Kay (Knarr) and they have two children: Kyle and Stacy. 4. Bob Hobbe 5. Brian Hobbe.

C. Rosemary E. Hobbe was born on Feb. 28, 1932 in Greensburg, In, in Decatur County. She was the daughter of William and Alvina (Dwenger) Hobbe. She grew up on a farm near St. Maurice, and had six brothers and two sisters. She attended the St. Maurice Elementary School for eight years, then attended Clarksburg High for four years of high school. After graduation, she went to work in the office at Margaret Mary Hospital. She worked there for two years, then went to Indiana Bell Telephone Company at Indianapolis, Indiana. She worked there until she married in 1956.

She married Theodore Huber, from Morris Indiana, in October, 1956. They went to Miami, Florida, where he was employed. They lived there all of their married life. He was born Jan. 11, 1933 and died on Thanksgiving day, 1988. However, they had divorced before then. They had four children together. She moved back to Indiana in 1974.

Rosemary married Dale G. Koors, son of Susann and Lawrence Koors, on July 31, 1982. He has five children from a previous marriage. They are now living at Greensburg, Indiana.

Children of Rosemary and Theodore Huber:

1. Anthony Joseph Huber-- born in Miami, Florida on Oct. 5, 1957, and died on Jan. 10, 1991. He married Judy Crothers on June 21, 1987. She was from Paintsville, Ky. They lived in Warsaw, Indiana at the time of his death. He had two children: Natasha Rose Huber, born Jan. 2, 1989 and Craig Anthony Huber, born Dec. 15, 1989. The children presently live with their mother in Paintsville, Ky.

2. Cheryl Ann (Huber) Wulf-- born in Miami, Florida on Oct. 9, 1958. She graduated from North Decatur High School and attended Indiana State College at Terra Haute. She married Greg Wulf from Bloomington, Indiana on June 26, 1982. They are now living in Granger, Indiana. They have two daughters, Lauren Rose Wulf, born March 29, 1985 and Brittney Macole Wulf, born June 18, 1987.

3. Cynthia Marie (Huber) Laker-- born in Miami Florida on July 15, 1960. She graduated from North Decatur High School. She married Gary Laker from Batesville, Indiana on Aug. 26, 1981. They live in Oldenburg, In. They have four children: 1. Bradley Charles Laker, born June 5, 1983, 2. Kyle Robert Laker, born August 10, 1986, 3. Derek Theodore Laker, born Aug. 13, 1988 4. Traci Marie Laker, born Jan. 16, 1991.

4. Robert Francis Huber-- was born in Shelbyville, Indiana on June 29, 1964. He graduated from Greensburg High School. He married Rhoda Powers of Greensburg, Indiana on July 18, 1992. He lives at Lake Sante Greensburg, In. He has a stepson and a son. Jacob William Beasley, born Sept. 26, 1987 and Justin Robert Huber, born Dec. 11, 1992.

D. Ambrose Hobbe, married Anna Mae (Lamping). They reside at Batesville In. in Ripley Co. They are the parents of five children: 1. Dianne Hobbe who married Rick Allgeier. They have two children, Shannon and Keith Allgeier. 2. Karen Hobbe who married Gary Munchel. They have a son Eric. 3. Mark Hobbe 4. Terry Hobbe 5. Lisa Hobbe.

E. James William Hobbe, was married to Theresa (Werner) born April 1956. They reside at Greensburg In. They are the parents of 11 children: 1. William Joseph Hobbe, born June 10, 1961.

2. Deborah Jean Hobbe was born on Aug. 15, 1962. She was married to David Lawrence Schneider on April 24, 1982. He was born on April 19, 1959. Debra and David Schneider are the parents of four children: A. Amanda Marie born Feb. 19, 1983, B. Erin Theresa born May 27, 1984, C. Michael Lawrence born April 21, 1989, D. Kurt James born Feb. 14, 1991.

3. Patricia Deloris Hobbe born Dec. 24, 1964. She married Lawrence Anthony Mauer on Aug. 8, 1987. He was born on Nov. 30, 1958. Patricia and Lawrence Mauer have two children: 1. Emily Margaret born July 27, 1988 and 2. Andrew Jacob born Jan. 9, 1990.

4. Mary Kathleen (Kay) Hobbe was born on Jan. 23, 1966. She was married to John Paul Schwering on April 30, 1988. He was born on June 26, 1966. They are the parents of two children: Ann Theresa born July 9, 1990 and Kelly Lynn, born Dec. 30, 1992.

5. Samuel James Hobbe was born on April 10, 1968.

6. Neal Mathias Hobbe was born May 4, 1969 and died July 29, 1983

7. Janet Sue Hobbe was born on Dec. 20, 1970.

8. Frederick John Hobbe was born on June 2, 1972.

9. Windy Elaine Hobbe born on October 11, 1973.

10. Rebecca Ann Hobbe was born August 6, 1976

11. Joyce Ellen Hobbe was born on Dec. 6, 1978.

F. Harold Clarence Hobbe, was born on February 24, 1938, the sixth son of William Fred and Alvina (Dwenger) Hobbe. Harold grew up in St. Maurice Community of In., living on a farm near Kingston, with his parents and five brothers; John, Richard, Ambrose, James, Raymond, Rosemary, Eileen, and Lucille. He attended the St. Maurice grade school and Clarksburg High School, graduating in 1960. Harold served in the army reserves, and worked on his dad's farm and on other farm jobs nearby.

Harold married Joan Marie (Bedel) Hobbe. She was born on April 15, 1944, the daughter of Kenneth P. and Clara (Fischer) Bedel, on May 26, 1962 in the Holy Name Church at Oldenburg, In. They moved to the original Hobbe family farm where they still reside.

Harold engaged in Dairy farming till 1992 when they sold the family farm to their sons, Daniel and Gregory, and Harold went to work at Vandebur construction and is currently employed at Kova fertilizer. Joan works for North Branch Golf Course.

They have eight children and one grandson. Their oldest daughter, Catherine Marie, was born on April 1, 1963, and graduated from

Indiana Business College. She married David Menkedick on October 26, 1991. She is employed by State farm Insurance. David and Cathy reside in Indianapolis.

Jeffery Harold, their oldest son, born on Jan. 31, 1965, graduated from Ball State University, and is a draftsman for Circle design in Indianapolis. He married Connie Hargitt on Aug. 27, 1988, and they have one son, Jacob Matthew, born Nov. 26, 1990. Jeff and Connie live in Brownsburg, In.

Daniel Frank was born on May 25, 1966. He is a tool and die foreman for RCO in Franklin, In. where he resides during the week; and works on the family farm he purchased on weekends.

Gregory Kenneth was born on Aug. 9, 1967. He is a construction worker for Gauck concrete con. co. and resides on the original Hobbe farm, which Daniel and Gregory purchased in 1992.

Laura Anne was born on December 31, 1969. She is attending Purdue University, and will graduate in May 1993 with a degree in elementary Education and special Education.

Mitchell John was born on May 17, 1973. He graduated with highest Honors from I77 Technical Institute and works for Blue Plane Gas in Batesville, In. He presently resides with his parents.

Christopher David was born on September 15, 1974. He is a senior and an honor student at Batesville High School. He is active in sports and Drama, and was recently awarded the Breedlove award at Boys State; and a trip to Boys Nation; where he met President Bush in Washington, D.C.. He hopes to become a teacher and a football coach.

Susanne Beth was born on February 6, 1976. She is a Junior at Oldenburg Academy, where she is an Honor student. She is active in sports. She hopes to attend College to study physical Therapy and play College Basketball.

G. Eileen Stella Hobbe was born in Greensburg Indiana, on Dec. 2, 1939, the daughter of William Fred and Alvina (Dwenger) Hobbe. She was married to Carl Joseph Moorman, on Oct. 26, 1960 at St. Maurice, Indiana. He is the son of Louis William and Theresa (Menkedick) Moorman and was born on Sept. 26, 1933, in Millhousen Indiana. Eileen and Carl Moorman have always lived in Millhousen and farms approximately 220 acres. They have six children, Joseph Carl, Linda Sue, Carol Ann, Thomas William, Gene Allan, and Donna Marie, and one son Allan Louis, who died at seven weeks.

1. Joseph Carl Moorman --was born on July 25, 1961 in Greensburg, Indiana, the son of Eileen Stella (Hobbe) and Carl Joseph Moorman. He graduated from South Decatur High school in 1979. In 1980, Joe attended Indiana State University, Terre Haute Majoring in accounting. From 1981-1983, he attended Purdue University, West Lafayette and Graduated in 1983, majoring in agricultural finance. Joe currently is a loan officer at Napoleon State Bank. On August 13, 1983, Joe married Valorie Kay (Stucker), in Millhousen, Indiana. They have two sons, Ryan Joseph was born September 4, 1986 and Jeremy Adam was born June 28, 1990, both in Columbus, Indiana. They reside at 3130 E. County Road 300 S. Greensburg, Indiana.

2. Linda Sue (Moorman) Eckel-- was born on July 3, 1962 in Greensburg Indiana, the daughter of Eileen Stella(Hobbe) and Carl Joseph Moorman. She graduated from South Decatur High School in 1980. Linda currently is shift supervisor at A&W Restraunt. On Oct. 2, 1982, she married Ronald Lewis Eckel in Millhousen, Indiana. They have two children, Brandi Lynn Eckel was born on Aug. 7, 1985 in Columbus, Ind. and Randy Alan Eckel was born on Nov. 4, 1987 in Columbus Ind. They reside at 602 S. Ireland, Greensburg, Indiana.

3. Carol Ann Moorman-- was born on March 25, 1964 in Greensburg, Indiana the daughter of Eileen Stella (Hobbe) and Carl Joseph Moorman. She graduated from South Decatur High School in 1982 and Marion College, Indianapolis in 1986, majoring in Math Education. Carol currently is a math Teacher at South Decatur High School and is planning a November, 1993 Wedding to Sam Koester.

4. Thomas William Moorman --was born on August 1, 1965 in Greensburg, Indiana. He is the son of Eileen Stella (Hobbe) and Carl Joseph Moorman. He graduated from South Decatur High School in 1983 and Lincoln Technical Institute in 1984, Majoring in Auto and Diesel Mechanics. Tom currently is an auto Mechanic at Don Meyer Ford. On Sept. 23, 1989, Tom married Beth (Volk) in Napoleon, Indiana. They reside at 4130 E. State Road 46, Greensburg, Indiana.

5. Allan Louis Moorman-- was born on Aug. 3, 1967, the son of Eileen Stella and Carl Joseph Moorman. He died on Sept. 20, 1967.

6. Gene Allan Moorman -- was born on June 25, 1970 in Greensburg Indiana, the son of Eileen Stella (Hobbe) and Carl Joseph Moorman. He graduated from South Decatur High School in 1988. Gene currently is employed as a welder with Hillenbrand Industries, and also helps his father work on the farm.

7. Donna Marie Moorman-- was born on December 13, 1971 in Greensburg, Indiana, the daughter of Eileen Stella (Hobbe) and Carl Joseph Moorman. She graduated from South Decatur High School in 1990. Donna currently is a junior at Marion College, Indianapolis, majoring in Early childhood development.

H. Raymond Hobbe was married to Mary Gentry, they are the parents of seven sons: 1. Mike Hobbe, 2. Larry Hobbe, 3. David Hobbe, 4. Phillip Hobbe, 5. Kenny Hobbe, 6. Roger Hobbe, 7. Patrick Hobbe.

I. Lucille Francis Ann Hobbe(Effinger) was born on January 1, 1945, the daughter of William Fred and Alvina(Dwenger) Hobbe. Lucille attended the St. Maurice Catholic Grade school from 1950- 1958 and she attended the Clarksburg High School 1958- 1962.

She met her spouse, Francis Louis John Effinger on July 4, 1964 at Liberty Park in Batesville, Indiana. They dated for two years. They became engaged on July 4, 1966 and were married on Oct. 29, 1966.

Pran enjoys coaching and playing all different kinds of sports.

Pran was born on Oct. 28, 1941 in Batesville, Indiana. Pran attended St. Louis Catholic grade school from 1947-1955. Attended Batesville high school 1955-1959.

Francis and Lucille(Hobbe) Effinger had two children. Sharon Ann, born Oct. 11, 1967 at Margaret Mary Community Hospital. Sharon attended St. Louis Catholic grade school 1-8 then Batesville High School grade 9-12. She attended Marion College at Indianapolis In., she teaches at North Decatur High 7-12/ learning disability. Sharon is a reserve volley-ball coach and varsity track coach.

Sharon Ann Effinger married Mark A. Dehart on Aug. 8, 1992.

Francis and Lucille's second child is Scott Allen Effinger, who was born on Feb. 27, 1973 at Margaret Mary Community Hospital. Scott attended St. Louis High School grades 9-12. Scott is a junior at Marion College. Scott enjoys golf and softball. He hopes to be a P.E. and Health teacher after graduation.

4. ~~Enna~~ Enllia Dwenger

Enna Enllia Dwenger was born on November 15, 1902 near Hamburg In. She grew up in the town of Hamburg in Franklin Co. and she attended the school there. Enna never married. She was employed at the Messenger for 40 years before she retired. She made her home at the fontbonne, and spent much of her spare time with her family.

5. Olivia Christine Dwenger b/1906 died age 4 --never married

6. Alfred William Dwenger

Alfred William Dwenger was born on April 19, 1907, near Hamburg In. in Franklin Co. He was born the fifth child of Henry B. and Anna(Huth) Dwenger. He was married to Myrtle Vivian Newkirk on Feb. 17, 1931. She was born on July 22, 1920. They had a daughter Mary Francis Dwenger, born on Feb. 18, 1931. Myrtle passed away on Sept. 19, 1933.

Alfred William remarried on April 3, 1937 to Gladys Lillie Wirth. Gladys was born on Oct. 9, 1914. She took five year old Mary to raise. A son Alfred Earl Dwenger was born on Feb. 27, 1942. Alfred William passed away on Feb. 23, 1980.

Gladys(Wirth) Dwenger still lives on the Lorenz Wirth farm that her grandfather Lorenz Wirth bought from the government over 100 years and some years ago. Gladys had lived there most of her life.

A. Mary Francis Dwenger(Dillow) was born on Feb. 18, 1931, the daughter of Alfred Wm. and Myrtle Vivian(Newkirk) Dwenger. She was born at Sandusky, In. on Feb. 2, 1932. She was married to James Arthur Dillow March 7, 1952 at the Huntersville parsonage at 7:00P.M. by Rev. Stroehlein. Jim was in the United States Air Force from 1952-56. He was in the reserves from 1956-60. We were divorced July 15, 1982. After my mother died, I remember going back and forth from my grandma & Grandpa Newkirk and grandma & grandpa Dwenger. I remember my grandma Dwenger rocking me and taking care of me when I was sick. When I was between 2&3, I got to spend quite a bit of time with my grandpa Dwenger because we would go to Aunt Bessie's and Uncle Clarence's and he would come there. I remember Grandma and Grandpa Newkirk & grandma and grandpa Dwenger and Aunt Clara(Dwenger)Niese and Aunt Stella Dwenger(Tekelva) until daddy married again to Gladys Lilly (Wirth) Dwenger.

1a. James Roy Dillow was born at Camp Atterbury, Edinburg, In. on Nov. 3, 1952 and died Nov.11, 1952 at camp atterbury.

2b. David Hearle Dillow was born at Charleston S.C. Nov.3, 1953. He was in the United States Army from 1972 to 1976. He was married to Denise Levell on July 17,1977. They had 3 sons, 1.David Hearle Dillow Jr. was born at Decatur Co. hospital, Greensburg, Decatur Co. In. on March 30, 1977. 2.Joshua Avery Marshall Dillow was born at Decatur Co. Hospital Greensburg, on Feb. 26, 1979.

3. Jeramy James Dillow was born at Charleston, S.C. on Oct. 15, 1980. David and Denise were divorced on July 24, 1981. He lives in Charleston S.C. and is now married to Edith Beacon.

3c. Mary Ann Dillow(Van Arsdale) was born at Charleston, S.C. on Dec. 15, 1954. She married, David Leroy Van Arsdall on Feb. 4, 1974. They have two children. 1. Melissa Ann Van Arsdale was born at Decatur Co. Hospital, Greensburg on Oct. 10, 1974. 2. Micheal David Van Arsdale was born at Major Hospital, in Shelbyville, In. on May 6, 1977. David was in the army at Vietnam 1966-1969.

4d. Allan Earl Dillow was born at Margaret Mary Hospital, Batesville, In. on Nov. 18, 1957. Allan has worked with children from 10-14 yrs. as a coach for basketball, baseball, and hockey since 1975. He works for the park & recreation Dept. at Greensburg now, and is still coaching.

5e. Becky Jean Dillow(Parish) was born at Batesville In. at Margaret Mary Hospital on June 23, 1959. She married Buddy Lee Parish on July 12, 1986. They were married at the Greensburg skating ring which was decorated like a church. They have two children: 1. Bruce Wayne Parish was born at Decatur Co. Hospital, Greensburg on Aug. 24, 1988. 2. James Russell Parish was born at Decatur Co. Hospital, In. on June 21,1991. They call him J.R.

6f. Richard Paul Dillow was born at Batesville, In. on Oct. 7, 1960. He joined the United States Air Force on Nov. 23, 1978. He married Yong Pi, from Seoul, Korea, on June 25, 1983. They have two children: 1. Jennifer Lynn Dillow was born in Seoul, Korea on Sept. 9, 1986. 2. Robert Leon Dillow was born at Colorado Springs, Co. on March 24, 1990.

7g. Daniel Joe Dillow was born on March 27, 1965. He married Norma Jean Schwering on July 25, 1991. He is in the process of getting a divorce and is going to marry Dessie Bowman. May 8, 1993 at Shelbyville, In.

A. Alfred Earl Dwenger was born on Feb. 27, 1942. He was married to Jacquelyn (Jackie) Jean Sanden on June 27, 1964. Jackie was born on Nov. 28, 1944. Earl graduated from Purdue University in 1964, and the Chicago Theological Seminary in 1967. He was ordained in 1967 and has served three United Church of Christ churches. The first was in Geneva, Iowa, the second in Bremen, In. and has served the past 12 years at Immanuel UCC in Highland, In. Jackie has taught school in a number of different situations. She now teaches at Wee Wisdom Pre-school in Whiting, In. They have two sons: 1. Matthew Dwenger was born in Iowa on March 31, 1969 and is now married to Renae. They live in their home in Hammond, In. where Matthew goes to Purdue-Calumet, and manages a sports card supply business. They have no children but do baby 2 dogs, Sam and Dennis. 2. Nathan Dwenger was born in Bremen on March 21, 1976 and is now a Junior in Highland, High School where he plays basketball and runs track and cross country. Girls are among his interest in addition to sports. He is also quite involved at the church.

7. Clarence John Dwenger was born on Feb. 13, 1909 at Hamburg, IN. He was the seventh child of Henry B. and Anna (Huth-pronounced Hoot) Dwenger.

I was born on a farm near Hamburg, and went to school for eight years. I attended the Catholic school at Hamburg. The school taught in German until I was in 3rd grade, then they began teaching English. Had to go back through the eighth grade, as everybody had to go to school until they were 16.

My brother Alfred and I worked on our farm, as father was busy with carpentry work. I also helped different people do farm work. One time I was out late, and had to cut hay the next day. As I was mowing the field, I fell asleep on the mower and when I woke up, I had left the field and cut a strip in another field. At eighteen, I got a job in a factory, (Ron-webers) at Batesville. I got 8 1/2 cents an hour. I stayed over the winter with my sister Alvina and her Husband Bill.

I saw an add in the paper \$25.00 for a Model T Ford, 1926. So I took the train to Indianapolis, bought the car, and got eight miles from town when I had a flat tire, and no spare tire or tools to work with. But with a car I could go. Work got slack, so I was back on the farm helping again. There is where I met Bessie, she was helping her grandmother a few days. I asked to take her to a show. I asked her to a show and took her home. She lived in Batesville. I had my car tore apart making a truck out of it; so I had to borrow a car to take her home. That was it, I went back to factory work and got a car and courted Bessie almost 3 years. I would take her sister Gladys along to Cincinnati when I'd go to see Bessie. She talked so I wouldn't fall asleep on the way home. We took Gladys most every where we went. She was a dare devil, Bessie was quiet. On one occasion, I was trying to show off; we were going across full back slab (A low spot in the creek where people crossed). I stopped the car in the creek and the car wouldn't start. I took my shoes and socks off and stood in the water to crank it. Back then I could get gas for 3 gal for a dollar, and put 4 new tires on for \$7.00 a piece.

I cut the tops off my fingers in a factory accident, and was off work when my mother died. I had talked to my mother and told her that I would get married on Thanksgiving day. Bessie wasn't the girl they had picked out for me, so when I asked Bessie to marry me, she said Thanksgiving was OK.

Henry and Ed were working on a house in Cinn. for one of the Liesing girls on Montanna Ave. Bessie worked for a cousin not too far from there. So they asked Henry and Ed if they would bring the wedding cake home on Wed. Eve, as Bessie's cousin would have it made if she had a way to get it home. Well it rained hard showers, but Henry held a three tier cake of Doves and bride and groom on top all the way to Bessie's home. Thanksgiving day started with sprinkles and got colder and colder before the dance was over there was a light snow which had fallen, then it turned real cold. We were married on Oct. 26, 1935, at the priest's house in Hamburg, the immediate family attending. Dinner and supper at Bessie's folks. We had a dance at St. Clair hall in Batesville. A good friend had a band and played so all the friends, neighbors and relatives had a good time.

Bessie Della Wirth was born on July 25, 1916, the daughter of Adolf and Habel (Swango) Wirth who were married on Sept. 20, 1911. Adolf Wirth was born on March 10, 1882 and died on Feb. 14, 19--. Habel (Swango) Wirth was born on May 5, 1892, and died on March 17, 1973. Adolf and Habel Wirth were the parents of eight children: 1. Gladys b/1915 she married Alfred Dwenger. 2. Bessie Della Wirth b/1916. 3. Lawrence James Wirth b/1918 - d/1980. 4. Edna Leona Wirth b/1921 and married Howard Sarringhouse. 5. Albert William Wirth b/1924 d/1980 married Freda Lamb. 6. Wallace Walter Wirth b/1926. 7. Robert Harvey b/1928 8. Ada Louise b/1932 she married John Heister.

After Bessie and I were married, we stayed at Bessie's folks into spring. Then we moved our things into a rented house in Batesville. This was during the depression, so we know what a wood stove and outside John was. We moved seven times then in Aug. 1940 we rented the house we lived in and bought it a year later.

We were blessed with eleven children. Clarence worked in a factory. He was a janitor at school for 16 years started the fires in the wood stoves. He would milk the cows and do the chores at home. Clarence was a good and loving father. After a days work he would cut his own fire wood. He helped cut corn to have fodder for cows in winter. He also helped his father with carpentry. He never

had time to play, always to work. The sat. the Cath. church in Hamburg burned, I called him to come home from Batesville. Children and I stood by as lightning and thunder roared. Lightning hit the bell ringer in the church and had a good start before smoke came through the roof, so we lost our church to fire in July 3, 1954. We held mass in St. John Hall until we got the new insides added as the brick walls still stood. Clarence was the one that got on top of the roof with a ladder to tear down the chimney which stood 12 feet above the roof.

We had problems with a big family like everyone else. But we had the school and church just across the street. By then Clarence took turns driving to work. We always had a nice garden. I canned food for winter and we had plenty of potatoes to eat. There were no short cuts of freezing. I baked bread every other day, Sewed most of the clothes they wore, even cut their hair. New shoes and eye glasses. Every body got glasses when they started school, but Tom and he doesn't wear any yet.

We didn't go to Greensburg often, but at times to get shoes to fit the children one at a time. So we hurried to town after school, stores didn't stay open late at night then, like today. It was Lloyd's turn, we took him tot own and got his shoes , when we got home he said that they didn't fit. The shoe clerk instead of measuring the childs foot, would look at the shoe and got the next size bigger for a child. Well when we announced that we were going to town, he just thought it was his turn to get to ride to Greensburg and back. He didn't know he was getting new shoes, he couldn't find his shoes, so he put his little brother's shoes on so he would get to go. They were to little for him, so also were the new shoes. So the next night after school we made the trip back.

By Betty being the oldest, we sort of had a hired girl. She read to them, and helped with lessons or whatever she could. I was kept busy. Clarence was never around, but on Sun. he taught them religion. I joined the church in June of 1940. After that it was a baptisma, first communion, solem Communion, graduation, then marriage. We celebrated every occation. We were down to three children living at home. Lloyd was to be married in Aug.

Clarence had retired in on Feb. 13, 1974. It was on April 3, 1974 when the tornado took our house, cars and everything. So we started all over. Our last, Mabel, got married and Adolph was ordained a priest Jan. 6, 1987. We now have 29 grandchildren and nine great grandchildren. But we still miss Donalds wife, Francis, and Lesia, who were killed by the tornado. After Clarence retired he planned to make cabinets and he had made lots oof them. He would build them and on Sat. hang them. The tornado took all of his tools so he started making childrens tables and chairs, rocking chairs, doll beds and toy boxes and wooden play barns. He made lawn swings, wash boards, well barrow. He rode a two wheel bike for a couple of years, then the children got him the three wheeler which he still rides every day. He has 1300 miles on it. He had to cut down in long rides after he had his pacer put in, Sept. 14, 1987. He had new batteries put in Sept. 29, 1992. He lost his right eye in an accident.

Clarence and Bessie reside at their home on main st. in Hamburg, where they rebuilt their home after the tornado. They are the parents of eleven children: Betty Ann(Rogers), Robert Henry, Donald Edward, William Walter, Thomas Clarence, Doris Jean(Biddle), Rita Mae(Livers), James John, Lloyd Richard, Adolph Eugene, Mabel Marie(Hajny/Whittaker).

CHILDREN OF CLARENCE AND BESSIE:

1. BETTY ANN DWENGER was born on Aug. 4, 1936 at Clarence and Bessie's home in Batesville. She was the oldest of their children. "I remember Grandpa Dwenger coming to our home to visit (a couple of times a day, as he just lived several houses and own an ally away.) He enjoyed setting under the tree in our front yard watching my sisters and brothers play. When one of them would fall down while playing he would say "Come here and I'll pick you up!" They would get up and walk over to him (Of course they didn't realize they did it on their own.) Also MoH would take the time to listen to his stories about the old days, etc... When he was unable to walk and was bedfast, I would go to him and set by the bed. He never seemed to tire of my teenage talk as I look back on the situation. I was 15 when he died, and I lost a friend as well as a grandpa." Married to William McKinnely on Oct. 30, 1971. William was born on April 25, 1925.

2. Robert Henry Dwenger was born on May 20, 1939, in a residence on the North side of Hamburg, Indiana. Hamburg is a small, mostly Catholic Community in Franklin County, Salt Creek township, in Indiana. I was baptised at St. Anne's Parish in Hamburg by Rev. Tribble. My Godparents were Henry B. Dwenger, my Grandfather, and Emma Dwenger, my Aunt. I am the second child and the oldest son of Clarence & Bessie(Wirth) Dwenger. My grandparents were Henry B & Anna Dwenger, and Adolph & Mable Wirth. I attended St. Anne's Catholic school in Hamburg, In. This was a small two room school. There were four grades to a room and we were taught by Franciscan Huns. I graduated from St. Anne's school in May of 1954. I then attended Batesville Highschool in Batesville, In. graduating in May of 1958. I was also in the reserves.

On June 18, 1966, I was married to Clara R. Kramer at St. Mary's church in Greensburg, In. We were married by the Rev. George Laugel . We are the parents of five children: 1. Diane Marie Dwenger, born on March 22, 1967. 2. Robert John Dwenger, born on September 8, 1968. 3. Catherine Elizabeth Dwenger, born on Feb. 21, 1970. 4. Jason Stanley Dwenger, born on Feb. 10, 1975. 5. Joshua James Dwenger, born on December 20, 1976.

Our daughter Catherine was married to Christopher Griffin on June 25, 1991. They have one daughter, Jessika Leigh Griffin, born

on March 19, 1991. Diane has one daughter, Blair Alexandra, born on Dec. 21, 1992.

3. Donald Edward Dwenger on Jan. 19, 1942 the third child of Clarence and Bessie Dwenger. He was raised and attended school at Hamburg In, in Franklin Co. He was married on Nov. 26, 1960 at the Holy Family Church at Oldenburg, to Francis Lorlane Suttman born on Jan. 23, 1942. They were the parents of five children: 1. Brian David 1961, Bruce Edward 1964, Wayne Allen 1965, Lisa Ann Feb. 19, 1971, Paula Sue 1972. They owned a trailer home in Hamburg.

On April 3, 1974, a tornado which destroyed most of the town of Hamburg, took the life of little Lisa Ann and her mother Francis. Their daughter Paula, who was also with her mother, miraculously escaped harm. Donald was employed at Hillenbrands?.

Donald remarried on Jan 23, 1975, to Jeanne Elleen Christian(Benz,Fraser). She had six children from her previous marriage to Loe Benz, who passed away. 1. Stephen Benz, 2. Debra A. Benz, 3. Linda Benz, 4. Davis Benz, 5. Mary Benz, 6. Janet Benz. They presently reside at Hamburg Indiana.

Childrens Histories: 1. Brian David Dwenger was born on Sept. 29, 1961. He was married to Kelly. Their children are Dustin David Dwenger, born on April 6, 1987, and Dalas Adam Dwenger born on Dec. 15, 1989, Kelly is also expecting on Sept. 1993. 2. Bruce Edward Dwenger was born on July 9, 1964, 3. Wayne Allen Dwenger was born on June 29, 1965. He was married to Carla Simmerneyer on Oct. 24, 1986. Their children were 1. Eric Wayne Dwenger born on Aug. 1988. 2. Lee Allen Dwenger was born on Nov. 16, 1991. 4. Lisa Ann Dwenger was born on Feb. 19, 1971. died on April 3, 1974. 5. Paula Sue Dwenger was born on April 21, 1972. Paula Sue married Robert Dvenne on June 20, 1992.

4. William Walker Dwenger was the fourth child of Clarence and Bessie Dwenger. He was born on June 24, 1943 in Hamburg In. in Franklin Co. Indiana. He attended the Hamburg grade school in Ray Twp. and graduated from Batesville High School in 1961. He helped Edward Dwenger with his carpenter work the summer of 1960. He was married to Jean A. Stenger, (daughter of Victor J. and Mary Stenger). They were married on Feb. 1, 1964 at St. Michael's at Brookville, In. They were the parents of four children: Mary Rose, Michael Joseph, Karen Beth, William Jessie.

1. Mary Rose Dwenger was born on Dec. 4, 1964, and attended St. Louis grade school. She graduated from immaculate conception academy in 1983. She went to the University of Evansville for two and a half years. She married Robert Lewis Hampson on March 29, 1986. A daughter, Catherine Lynn Hampson was born on April 19, 1987. 2. Michael Joseph Dwenger was born on Dec. 6, 1965. He attended St. Louis grade school and graduated from Batesville High school in 1985. He married to Tracy Ann Harvey on Nov. 28, 1992. She attended St. Louis Batesville school, In. 3. Karen Beth Dwenger was born on Oct. 7, 1971. She attended St. Louis grade school and graduated from Immaculate Conception Academy in 1990. She was married to David Wayne Addison on Feb. 23, 1991. They have a daughter, Hillary Beth Addison, who was born on Jan. 13, 1993. 4. William Jessie Dwenger was born on Feb. 12, 1978. He attended the St. Louis grade school, and is a freshman currently at Batesville High School.

5. Thomas Clarence Dwenger was born on April 28, 1945, at Hamburg, In. the fifth child of Clarence and Bessie Dwenger. He was married to Anne Sue Moor on May 9, 1970 at Greensburg, In. in Decatur Co. Anne Sue was born on May 15, 1945. Thomas was in the army and served nineteen months in Germany. He lives in Gwynnville, Indiana, in Shelby Co. They were the parents of four children: David Allen, Debra Ann, Tanny Sue, Amy Lynn.

Children of Thomas and Anne Sue: 1. David Allen Dwenger was born on Dec. 17, 1966. 2. Debra Ann Dwenger was born on Jan. 25, 1971. She was married to Allen Lee Garrison on Aug. 5, 1988. They have one son Timmy Garrison, who were born on May 4, 1988. 3. Tanny Sue Dwenger was born on Jan. 23, 1973. She is planning a July 3, 1993 wedding. 4. Amy Lynn Dwenger was born on Aug. 14, 1978.

6. Doris Jean Dwenger(Biddle) was born on Jan. 18, 1947, the sixth child of Clarence and Bessie Dwenger. I was the first of the eleven children born at Margaret Mary Hospital in Batesville. I went to the little schoolhouse at Hamburg, where my grandfather and my dad had attended before me. When I went to High School, I rode the school bus from Hamburg to Batesville.

In the summer of 1962, I met Howard Lee Biddle, born on Nov. 7, 1942. In May 1965, I graduated from Batesville High School, and started working at Hillinbrand Casket Co. in Oct. 1965. I married Howard Lee Biddle, in Feb. 12, 1966.

I had one stillborn baby boy on March 7, 1969, we named the little boy Henry Biddle, after Grandpa. Henry is buried between Grandpa and Grandma (Henry and Anna) Dwenger at Hamburg.

I was grandpa(Henry's) favored little girl. We spent many days together. Grandpa had a fit the first time my mother cut my curl off at the age of four. Grandpa Henry went to the sister of the poor. The next day I got chicken Pox and couldn't see grandpa for a week. But when I did get to go, I jumped on his bed, no one else could. He couldn't move, and I took my finger and opened his eye lid, for he was in a coma. But he knew I was his little girl. I was all dressed on Easter morning to go see grandpa, when they called and said he had passed away. I was six years old.

Howard and I took my parents, Clarence and Bessie Dwenger to Canada, Florida, and Tenn. to the caves. We do lots for my parents, because they are wonderful parents. Being seventh out of them and my parents. With seven brothers and three sisters and me being in the middle I always told everyone I was a black Sheep (Not really). Howard and I bought Howards grandparents home in Sunman, In. We have lived there for 23 years.

7. Elta Mae Dwenger was born on Nov. 1, 1948 at Hamburg Indiana. the seventh child of Clarence and Bessie Dwenger. She grew up in the town of Hamburg In Indiana. She made her first communion in the Knights hall, as the church had burned. She graduated from the

batesville High School in 1966.

She was married on June 15, 1968 at St. Anne's Catholic church in Hamburg, to Joseph Carrol Livers. Joseph Livers was born on Jan. 8, 1949. He graduated from Brookville High School in 1967. He was drafted into the Marine Corps in 1968, and spent two years at Camp Pendelton Calif. They are the parents of four sons: Joseph Carrol, Jeremy Dean, John Leonard, Steven William.

Children of Rita and Joseph Livers: 1. Joseph Carrol Livers Jr. was born on March 14, 1969. He graduated from Batesville high school in 1987. He was a member of the wrestling team. He will attend Purdue in fall of 1993. 2. Jeremy Dean Livers was born on Nov. 1, 1970. He graduated Batesville High School in 1989. He was a member of the football and wrestling team. He entered the U.S. army in 1992. He was married on April 25, 1992 to Michelle Lynn Gulfoyle, who was born on April 23, 1975. They have a daughter, Kyla Paige Livers born on Jan. 23, 1992. They also have a baby due in June(Girl). He is presently in the service and stationed in Hawaii. 3. John Leonard Livers was born on Oct. 29, 1975. He attends the Batesville High School. He is a member of the football team. 4. Steven William Livers was born on July 9, 1979. He attends the Batesville Middle school. He is a member of the football team.

8. James John Dwenger was born on March 23, 1950, the eighth child of Clarence and Bessie Dwenger. He grew up at Hamburg In. He was married on April 4, 1970 to Dana Joyce Kencer at St. Anne Church in Hamburg. Dana was born on Nov. 30, 1949. graduated at Milan. Grad. 1968, Lattin School. They have one son, James John Dwenger, born on Aug. 4, 1971. He attended East Central High School, and graduated in 1989.

9. Lloyd Richard Dwenger was born on Feb. 5, 1952 the ninth child of Clarence and Bessie Dwenger. He was married to Joan Rita Walke on Aug. 24, 1974, at the St. Louis Church at Batesville.

They were the parents of six children: Wendy Jo Dwenger born on June 19, 1975, Angela Dawn Dwenger born July 13, 1977, Melissa Sue Dwenger born on Dec. 26, 1979, Scott Richard Dwenger born Oct. 30, 1985, Nicholas Adam Dwenger born June 27, 1987, Philip John Dwenger born March 9, 1990.

10. Adolph Eugene Dwenger was born on May 6, 1955, the tenth child of Clarence and Bessie Dwenger. He attended the two room school across the road, taught by Franciscan Nuns. He graduated from Batesville High School, and got a job at Hillenbrands, at Batesville Casket Co. He had a new car and was in love with a girl. But something kept nagging at him. At night when he prayed, the thought of becoming a priest kept nudging at his heart. "I never knew where it came from, it made me terribly angry because I thought I had achieved everything, I had to give up everything and I wasn't sure I could do it." He decided to go to Duns Scotus College. My mother wasn't so sure about it, my father was very happy. After four years of Duns college(A Franciscan School), He wasn't so sure. He thought he would like to marry and have a family some day. He took a job at K-mart. He did well, but his life still lacked something. At 27, he decided to try the priesthood again, and enrolled in St. Minard Seminary. Friends and relatives gathered at St. Ann's in 1987, for his ordination, to welcome him into the priesthood. Afterwards he told the nieces and nephews, "It's still OK to call him Uncle Shorty."

A cousin remembers him as My cousin Adolf Dwenger was about 12 years younger than myself. My husband and I attended the ordination of Adolph Dwenger at the Cathedral in Indanapolis, and his Mass at St. Ann's church at Hamburg. There was so much beauty & love of Christ, his church alt's members in Father Adolph. What a wonderful human, caring, compassionate priest, father Adolph was, so much like Jesus. In 1988 we visited him at his Parish in Bellville, ill.(Tell City). It was Holloween and Adolph dressed up as a clown, it was apparent that he was loved by all. A few years later he celebrated Mass at St. Bridget's church in Indpls. for deceased members of the Dwenger family. We attended and had lunch together after. Adolph is loved by many and there is a special place in my heart for him. He has been like Jesus to so many especially the poor. God bless you father Adolph in all your future endeavors. God had given you many gifts, and you have been so generous in sharing them with others.

Hary Taylor 1993

11. Habel Marie Dwenger was born on March 16, 1957 the youngest child of Clarence and Bessie Dwenger. She grew up at Hamburg In. She was married to Kevin Hainy on Feb. 5, 1983 at Hamburg In. Kevin was born on Nov. 18, 1956. They had a son, Anthony John Hajny, born on July 29, 1984. He attends Batesville St. Louis Catholic School. Habel and Kevin were divorced in July 1986. Habel remarried on Aug. 25, 1987, to Steve Whittaker who was born on Sept. 22, 1949. Habel and Steve were divorced on March 9, 1992. At this time she took the Hajny name back to be the same as her son's.

Habel graduated from Batesville High School. She works at Will-Rom in Batesville. She lives in the county outside of Batesville, and attends the St. Louis Catholic Church.

8. Leo Francis Dwenger was born in 1911. He died in a fall from his high chair, at the age of three.

9. Henry Victor Dwenger was born on Dec. 9, 1913. He passed away from croup on April 14, 1914.

10. Peter Waldo Dwenger (Wally) was born on Nov. 2, 1914 at Hamburg In. He attended the Catholic school at Hamburg, in Franklin Co. In. He was married to Anna Woods on Nov. 26, 1939 at Andersonville, near Brookville. Anna was born on Feb. 6, 1921 at Manchester, Ky. She was the daughter of Walter and Rose(Woods) Bishop. Wally was employed at the Rom-Weber in Batesville, In. After their retirement, they resided with thier son Paris Wm. at Hamburg, then later at Delaware. Peter Waldo died on Oct. 26, 1979 of a heart

attack.

Wally and Anna were the parents of five children: Paris Wm., Waldo Jr., Hazel, Emma Rose, Henry Joe.

1. Paris William Dwenger- was born on March 15, 1939 at Indianapolis, IN. the son of Waldo and Anna Dwenger. He was married to Phyllis Ann Caudill on May 21, 1977 at Maurice Hill. Phyllis was born on June 29, 1954 at Lecher Ky., the daughter of Hubert and Janice(Ifon) Caudill. Paris and Phyllis lived for a time near Hamburg, then moved to the town of Delaware, in Ripley Co. Paris is employed at the Batesville Casket Company. (This is where Phyllis and Paris first met, at their work.) Phyllis was a brownie leader for the Osgood troop for six years. They attend the Little Memory Baptist Church, at Spades, out of Sunman. Paris and Phyllis are the parents of two daughters: 1. Trisha Ann born on April 24, 1979, and 2. Jodi Lea born on Sept. 3, 1981. They attend the J.C.D. schools.

Paris was previously married to Judy Patterson. They were divorced. They had six children: 1. Candi m/Roger Hobbe and have 3 child.(Amber, Branden, Lindsay). 2. Joe(Paris Arndt). 3. Timothy(died in infancy) 4. Melvin m/Chelsea Heindbers 5. Tanny m/John Fledderman and have 3 child. (Henry, Zachery, Elizabeth Ann.) 6. Casey.

2. Hazel Arlene Dwenger- was born on Nov. 17, 1946 at Batesville In. the daughter of Wally and Anna Dwenger. She was married to Eddie Ison, from Metamora. She was married a second time to Francis Paul. She was the mother of five children: 1. son Gary Lee Ison. Gary married Melissa and they had two children: Shawn and Bryan. 2. Donald Little 3. Debbie Little 4. Angie 5. Paul Michael.

3. Emma Rose Dwenger was born on July 24, 1941 at Batesville In. the daughter of Wally and Anna Dwenger. She was married to Bill Kroner. They were the parents of three children. 1. Bryan Kroner, who married Angie Gillan, 2. David Kroner, 3. Michael Kroner, who attends East Central High School.

4. Henry Joe Dwenger was born on July 31, 1942 at Batesville, In. He was married twice. The first time to Betty Vorheef. Henry was the father of six children: 1. Gayla, who married Larry Sumner. They have a daughter Amanda. 2. Daryl, who married Darlene, from Calif. They have two children: Bryan Colton and Brandie. 3. Roger, who married Lisa. 4. Mark, who married Alisha. 5. Jessica, who attends East Central School. 6. Joseph, who also attends school.

5. Waldo Dwenger Jr. was born on Sept. 17, 1940, at Rush Co. In., the son of Peter Waldo and Anna(Woods) Dwenger. He was married to Nola Davidson, in Oneida Kentucky, on Feb. 11, 1960. Waldo is employed at the Batesville Casket Co. Waldo and Nola moved and bought the old Dwenger home place in Hamburg, on March 1964. Waldo Jr. and Nola were the parents of three sons: 1. Johnny Ray Dwenger, born on Dec. 8, 1963. He was married to Angie Bradley in 1993. They live at Batesville, In. 2. Gregory Scott Dwenger was born on July 1, 1966, was married too Deanna. Lives in Ky. 3. Jeffery A. Dwenger, born July 18, 1970. He was married to Rachel Blum in 1992. They presently live in Hamburg.

11. Clara Ann Dwenger- was born on March 29, 1915 at Hamburg In. the daughter of Henry and Anna Margaret(Huth) Dwenger. Henry Dwenger being the son of William Dwenger and Catherine(Raver) Dwenger. Anna Margaret Huth being the daughter of Domino Peter Huth and Veronica(Kleinfelder) Huth.

Clara attended the Hamburg school until the age of 16, when she was made to quit school. She always enjoyed school and wanted to continue, but was not allowed to. Two weeks after leaving school she moved to Cincinnati, Ohio, where she got a job working in the kitchen at a ladies apartment building that was managed by the sisters of St. Joseph. After two years she quit and moved in with a family and kept house while taking care of their children. She was allowed one afternoon off every other Sunday. There were three Christmas's she was unable to come home because she wasn't allowed off. She recieved \$5.00 a week, and after working for eight years she recieved \$8.00 a week.

In January of 1938 she met William Niese through a friend; and after dating for a year they were married on January 18, 1939 at Hamburg, Indiana. While William worked for .50 a day cutting cord wood Clars stayed home and kept house. On Feb. 27, 1940 their first child Eugene Henry was born at home. On Feb.24, 1942 Jerold Herbert, their second son was also born at home. In april of 1942 the family moved onto William's fathers farm outside of Batesville, In.

Their third son, Joseph William, was born on April 15, 1943. Robert Lawrence, their fourth son, was born on May 4, 1944. January 4, 1946 Dennis Edward, thier fifth son, was born. These first five were all born at home and delivered by Dr. Boghon. The sixth son, Gregory Louis, was born on April 11, 1949 at Margaret Mary Hospital in Batesville by Dr. Hirsch.

In 1951 electricity was put into the house. It was a big change from coal oil lamps. The family purchased their first radio. In the evenings the family would sit and listen to it. In August of 1952 the barn burnt down. Hay and farm machinery were lost.

David Clarence, the seventh son was born on November 16, 1951. William Waldo, born February 8, 1953 was the eighth son. On October 24, 1957 after eight sons, Sharon Stella was born. While Clara was in labor with her daughter, she told the doctor that if it wasn't a girl this time they weren't going to pay him. After giving birth and being told that it was a girl, she didn't believe it and the nurse had to undress the baby so she could see before she would believe it.

In spring of 1954 running water was put into the house. For the first time the family didn't have to go outside to use the bathroom.

William had several different Jobs through the years, but he always farmed while he worked at his other jobs. His eight sons were

a lot of help to him.

On Sept. 9, 1967 tragedy struck when Greg, at age 18, was in a car accident and was killed.

Clara and William had nine children: Eugene born Feb. 27, 1940. He married Evelyn Fletcher on April 8, 1967. They had four children; Patrick, Eugenia, Eva, and Thomas.

Jerold was born Feb. 24, 1942. He married Margarie Hartman on Dec. 28, 1963. They had three children; Andrew, Annette, and Jeffery.

Joseph born April 15, 1943. He married Mary Weekly. They had three children; Brenda, Brian, and Kathern.

Robert was born May 4, 1944. He married Maryann Bedel. They had seven children; Richard, Steven, Donald, Sandra, Jennifer, Teresa, and Patricia.

Dennis was born on Jan. 4, 1946. He married Carol McCann. They had four children; Michael, Cindy, Paul, Linda.

Gregory was born August 11, 1949. He was killed in an automobile accident, on Sept. 9, 1967.

David was born on Nov. 15, 1951. He married Diane Holland. They are the parents of three children; Melanie, Jackie, and Greg.

William Jr. was born on Feb. 8, 1953. He married Shirley Wiesbach on July 27, 1974. They had two children; Daniel and Julie.

Sharon was born on Oct. 24, 1957. She married Toby Lewis. They had three children; Toby Jr., Kenneth Daniel, and Jeremy.

Clara and William Niese are now residing at 333 S. Mulberry at Batesville, Indiana.

CHILDREN OF CLARA AND WILLIAM NIESE:

Eugene Henry Niese

Eugene Henry was born Feb. 27, 1940, the oldest child of eventually 9 children. His parents are William and Clara (Dwenger) Niese. Gene was raised on the family farm during the depression. They always had their own meat, eggs, milk and a garden.

Eugene started first grade at St. Louis Catholic school in the fall of 1946. He graduated from 8th grade in 1954 and from high school in 1958. During his Senior year of High School he was in I.C.F. program. Going to school in the morning and working in the afternoon at Batesville Products Co. He worked there until March, 1959.

Eugene and his brother Jerold went together to join the army. Eugene passed, but his brother Jerold failed the physical. Gene entered the army. He did his basic training at Ft. Leonardwood, Mo. for 8 weeks until June 1959. Then he was sent to Ft. Monmouth, N.J. for field radio repair training. Upon completion in Jan. 1960, he received orders to report to Korea. He took up duties at the Depot Inspection Office. After completion of 13 months duty in Korea, he was put on a troop ship and sent back to the USA. He ended up spending his 21st birthday somewhere in the middle of the ocean. It was nice to be home for the next 30 days. His next assignment was at Ft. Huachuca, Az. upon arrival Eugene had to wait for topsecret clearance, before being assigned duties in radio repair station within a restricted area. When in Arizona, he was only 20 miles from the Mexican border where he took many trips across the border. The last of April 1962 he was released from active duty and drove a 1949 Pontiac back home to Indiana. The car didn't have a heater. He spent the next two months resting, sleeping, and helping neighbors put up hay and straw. The last of June he decided it was time to get a job, so he went to Hillenbrands and was hired. He went to work on June 28th, 1962 at the garage where he worked for the next three months. In Oct. of '62 he was transferred to the company airport where he worked for the next five years. He transferred back to the truck garage at Hillenbrands, in the fall of '67. This is where he is presently employed.

In 1964 Eugene started a Boy Scout Troop 39. He became a Scoutmaster in 1966 and held that position until 1971, when he moved to New Point, IN. The scouts spent a week's summer camp every year.

In 1966 he met Evelyn Pecher from Milhousen and married her in 1967 at St. Louis Catholic in Batesville, IN. Patrick, their first child was born on Feb. 25, 1968. The second child, Eugenia Louise was born Oct. 18, 1969. The family then moved to New Point where they lived the next 8 years. A third child was born, Eva Marie on June 10, 1971. When the fourth child, Tomas was born on Feb. 20, 1978, the house became too small, so the family moved to a larger home at Morris, IN. Tomas is presently in the 8th grade at Batesville Middle School and is on the basketball team.

Patrick and Jeanie both graduated from college at Ball State University, in Muncie, IN. Patrick graduated in 1990 with a degree in Science. Jeanie graduated in Dec. 1992 with a degree in Home Economics. Eva married Gary Lunsford in Cincinnati, Oh. in March 1992. Gene and Evelyn became proud grandparents when Cody Allen Lunsford was born.

Gene's family presently resides at 5109 E. Morris Hill St., Batesville, IN.

Jerold Herbert Niese

Jerold Herbert Niese was born on Feb. 24, 1942. He was the second son of William and Clara (Dwenger) Niese. He was born at home on Twp. Co. line rd, in Batesville, IN. The family moved around the corner to Grandpa Niese's home (the home place), on Yekulve Road, shortly thereafter. Jerold was a chubby little boy who loved to sit by the toy box. When he learned to crawl, he crawled off the back porch. He has always been blamed for the crack in the sidewalk.

There were eleven around the table for meals. Jerold sat where he was passing the bowls instead of getting to eat.

In St. Louis grade school at Batesville, Jerold was a quite shy boy who stuttered. At the age of 16, Jerold was very disinterested in school, so he quit and went to work on a farm in Greensburg, IN. In the fall of 1959 he was hired at Hillenbrand's

In Batesville, IN.

On Sept. 1, 1962, Jerold was introduced to Marjorie Hartman at his cousin Pat Niese and Dennis Schank's wedding, by George Litzinger. They dated for over a year. Jerold proposed marriage in his own way. "When are we going to make the big mistake?" Their date changed many times before finally being set for Dec. 28th 1963.

Jerold and Marjorie had three children in three years, all being born at Margaret Mary Hospital in Batesville, IN. Andrew, Annete, and Jeffery. After five years of renting they found a place of their own on 400s in Decatur co. It was a basic home, no running water, on central heat, but a good home to raise three children. Jerold worked at Hill-Rom co. in Batesville, IN, where he is presently employed. During the first years of marriage, there was several yaers the company only worked 4 days a week, but he managed to make the house payment and feed the family. It took 13 years to remodel their home to meet the changing needs of the family. After 19 years, Jerold wanted to get closer to town. They started looking in July 1987 and by now 1987, they had sold their home in the country and bought the home on 18 wheat St. in Batesville, IN. They are continually making improvements.

Jerold and Marjorie couldn't agree on how to raise their children. They attended a Marriage Encounter weekend and with the grace of god made it through. They found out that deep down they truly loved each other.

Andrew Eugene Sept. 28 1964, and married Ruth Stoll on June 4, 1988 at St. Peter's, IN. Ruth was born Aug. 19, 1963. They have one daughter Sasha Marie who was born on June 30, 1990. Andrew and Ruth lived in Batesville, IN. at Quail Meadows.

Annette Judith was born Sept. 28, 1966, and married Brent Eugene Stinger from Brookville, IN. on Sept. 27, 1986 Brent was born Oct. 7 1961. Annette and Brent have two children; Tiffany Ann, who was born MAY 11, 1988, and Micheal Robert who was born Dec. 12, 1989. They lived in Brookville, IN.

Jeffery Robert was born Aug. 17, 1967. He is at present 'unmarried and living at home.

Joseph William Niese

Joseph was born April 15, 1943, at his home near Batesville, IN. He was raised on a 80a. farm by his parents William and Clara (Dwenger) Niese. Joe has a one sister, Sharon and 7 brothers, Eugene, Jerold, Robert, Gregory, Dennis, David, and Bill. All attending St. Louis grade school for 8 years. Joe graduated from Batesville High School in 1962.

For spending money while in high school Joe did some golf cadieing at the Hillcrest Country Club, and in the winter he sat up bowling pins. After graduating Joe worked on a farm through the summer for Elmer Drapeing. On Sept. 3, 1962 he joined the U.S. Marine Corp. Having basic training at San Diego Calif. and he took infantry training at Camp Pendelton, Calif. After 10 months he was sent on a Far East tour of duty. He spent time in Okinawa, Hawaii, Japan, Hong Kong, the Phillippines, and Taiwan. After 13 months he was sent back to Camp Pendelton, Calif., near Los Angeles. In July the Marines were sent to Viet Nam. Joe spent 6 months at Chu Lae, Viet Nam. He spent another 7 months at WAY in Viet Nam as a forward observer for the 81 millimeter morters. He got out of the Marines in Oct. of 1966 as a Marine Sargent E-5.

Joe lived at home for 4 years while working at varies places. General Eletric, Shelbyville, IN. Also Welding School, Ford Phillico, Connerville, IN. assy. Crown Zellerback, Greensburg, IN, printing press. Cincinnati Incorporated, Screw Machine Helper. He settled at Contintal MGF. as a Service Eng. instructor and repairing Shear Coveyors in the field.

Joe married Mary Rose Weekly from IN Dearborn, County. She,s the daughter of Walter and Bernita Weekly, born on 17th. of Feb. 1947, at Hamilton, Oh. Mary Rose grew up on a farm a few miles from Dover, IN. She has one brother, Joseph Weekly. - Mary Rose and Joe Niese were married at Dover Catholic Church on May 10, 1970. They rented a house in Dover, IN and Joe continued to work at Continental MGF until their first daughter was born Feb. 23, 1972 naming her Brenda Marie. Joe then started working for U.S. Drill Head in the summer of 1973 as a Machine Tool Erector building high indexing machines. Mary and Joe on Jan. 27 1978 during a blizzard had a boy born, they named him Brian Joseph.

They bought the house they were renting the last 10 years in 1980. The house was built in 1874. While remodeling they found a piece of sheeting board in one of the walls that gave the names of the builders and when they started and finished the house.

IN 1986 in April on the 24th Catherin Elizabeth was born to tthe family. As of today Joe is working at the U.S. Drill Head as a lead man and Service Eng. Mary is working part time at Peoples Trust Bank. Brenda is going to Ball State University majoring in Journalism. Brian is in the 9th grade also wrestling, band drummer, and baseball. Katie is in the first grade. The resides at 25880 Old State Road 1 Guilford, IN.

Robert Lawrence Niese

Robert Lawrence Niese was born May 4, 1944 at home near Batesville, IN Ripley County. He is the son of William and Henry Niese and Clara Ann(Dwenger) Niese. Robert was one of nine children; Eugene, Jerold, Joseph, Robert, Dennis, Gergory, David, William J.R., and Sharon.

Robert was raised on the family farm about one mile east of Batesville. He attended St. Louis Catholic School at Batesville and the Batesville High School. At age 18 he started working at Hillenbrand Industries. He worked there four years.

When Bob was 8 years old the barn burned down. He remembers waking up to the sky being red with fire. The barn was located out in the field almost across from the present barn but moer behind where the chicken house used to be. In August 1952 lightning struck a sycamore tree near by the crossing over to the transformer. Because the wiering was doe improperly by a neighbor electrician the lighting came back to the barn starting the fire at about 4:30 in the morning. The barn was relocated.

On Sept. 5th 1964 Robert married Maryann Bebel at Immaulate Coonseption Catholic Church at Millhousen, IN. Bob's old girlfriend was a friend of Maryann's and she set them up. Maryann is the daughter of Edmund Bebel and Virginia (Young) Bebel. She was born of July 22, 1945 at Greensburg Hospital. She is a graduate of Jac-Cen-Del High School, Osgood, In. Then she attended Cosmotology trade school at Indianapolis, In. attaining a beautition license. After their ,narriage they resided at Batesville in a trailor. Both were employed at Hillenbrands at this time.

Their first child, Richard William, was born Dec. 23, 1965 at Greensburg, In. A short time later the family moved their trailor to a trailor court at Greensburg. After selling the trailor they moved into an apartment on Thomas St. for a few months. Robert was employed at BCA. Maryann at Crown Zellerback.

The family after 6 months moved into the country near New Point, renting a house from Allen Cramer. Bob working part time on the Cramer fara along with his job at BCA. Maryann now at Sears.

On Feb. 7th 1968 Steven Edmund was born. Since BCA went on strike with no end in sight, Bob got a job at Wayne Dairy, delivering milk. His wife worked as a bookeeper at the same place. At this time as opportunity to find a better home at Napoleon, In. presented itself, so the family moved once more. The house was rented from Jim Weber. Here their third son, Donald Eugene was born on May 20, 1971, at Greensburg, In. Maryann was now working for the dress factory. She worked there for nine years until they closed down. The need to have a better paycheck brought Bob to seek new employment. He obtained a job at Delta Faucet, Greensburg. This was around 1971. He has been employed there for the last 21 years (1992) he is presently a leader in stock.

In 1973 Bob and Maryann bought five acres from her parents about one mile North of Millhousen. Here they built a house and barn. Bob's brother Joe doing a lot of the outside work including building the kitchen cabinets. Also Bob's brothers and father helped put the siding on the home. Finishing most of it up in one day. In the evening having a grand party.

On Feb. 8th 1974, their first daughter, Sandra Marie was born. A girl had been prayed for by many. Twenty two monthes later their second daughter, Jennifer Helen, was born at Greensburg on Dec. 17th 1975.

Since the dress factory closed down shortly after this, Maryann started working at home sewing for other people. Bob held a part time job for a while working at Porter's furniture store in Greensburg.

On March 30, 1978 their third daughter, Yeresia Ann was born at Batesville, hospital, Ripley Co. Six monthes later the family sold their home and moved to Letts, In. While living in Letts the next nine years their fourth daughter, Patricia Cathleen, was born Feb. 13, 1984.

Wanting to get back to the country, they sold their house at Letts and renovated a basenent one and a half miles North of Millhousen, on a twelve and a half acre plot of woods. This is their present residence at 7558s. Co. R. 200e. Greensburg IN.

Bob and Maryann taught Religious Education at St. Mary's Catholic Church for a number of years. Bob enjoys fishing and Maryann is a 4-H leader.

Bob and Maryann Niese are the parents of 7 children;

*1. Richard William born Dec. 23, 1965 at Greensburg. He married Barbra Colson, a convert, and at present have three children: Virginia, Geraney, Alexis.

2. Steven Edmund born Feb. 7, 1968 at Greensburg. He married Jennifer Wesseler and they have one child: Brant-b/April 26, 1993.

3. Donald Eugene born May 20, 1971 at Greensburg, In.

4. Sandra Marie born Feb. 8th 1974 at Greensburg, In.

5. Jennifer Helen born Dec. 17th 1975 at Greensburg, In.

6. Yeresia Ann born March 30, 1978 at Batesville, In.

7. Patricia Cathleen born Feb. 13th 1984 at Batesville, In.

*Richard William and Barbra(Colson) Niese

Richard William was born on December. 23, 1965 at Decatur Co. Hospital, Greensburg, In. Delivered by Dr. Miller. He is the son of Robert and Maryann(Bedel) Niese, and the oldest of seven children. Richard attended Kindergarten at Osgood, In. He went to Napoleon, In for first grade, and after the family moved to Millhousen, Richard attended Sandcreek elementary School, near Westport. The school was being torn down during his 5th grade. Richard then attended South Decatur Elementary, the new school; graduating from South Decatur High School in May, 1984.

Richard worked for many farmers, putting up hay and other jobs. He also detassled corn during the summer since the age of 13. He was a cub scout and was in 4-H. At the age of 18 he got a job at Hills Dept. store at Columbus, In. He worked there for 3 years

while attending Ivy-Tech School. Richard then got a job at Welding and Therapy at Columbus, In. Where he is presently employed.

Richard married Barbra Colson, a fellow student, four years after graduating. Barb is a convert to the Catholic faith. She was born on 31st of Dec. 1965. Her parents are Ray and Linda Colson of Decatur Co. In. Barb graduated from South Decatur High School in 1984. She then attended Vincennes University for three years, living at Fort Wayne, and working for a nursery. She now has a job at Wal-Mart, Greensburg, as a department head.

Richard and Barbra were married on 23rd June 1988 at St. Mary's Catholic Church, Greensburg, In. The couple rented a house on Hwy. 46 near Barb's parents for a little over a year. Then at a home at 1001 N. East St. Greensburg, In. where they are presently living. They are the parents of three children.

Their first child, Virginia Ann, was born on 26, Feb. 1989. On the 25th April 1991, Geramey Michael was born; and on 11 June 1992 Alexis Nicole was born. All at Bartholmew Co. Hospital in Columbus, In. Barb does some sewing and makes up flowers for Weddings and Proms. Rick likes to fish. Both have been active in church activities. Barb teaching religious Education, and has been in church choir. Rick taught religious Ed. and worked with youth ministry.

Dennis Edward Niese

Dennis Edward Niese was born on Jan. 4, 1946 at the Niese home a few miles from Batesville, In. His parents are William and Clara(Dwenger) Niese. Dennis attended St. Louis grade school at Batesville. He graduated from Batesville High School in 1984.

At the age of eight Dennis had Encephatitis and for 10 days was in the childrens hospital. The doctors thought it was caused by a mosquito bite.

Dennis then enlisted in the Air Force in July 1965, serving 3 and one half years. He was stationed at Lackland AFB for Basic, three monthes at Wichita Falls for Tech School (Aircraft Main) England AFB La. for three years. He was discharged Dec. 31, 1968.

Dennis's dad William Niese was working at Hillenbrands Casket Co. one of the people he worked with was Carol McCann. Carol enjoyed writing to service men and so she picked Dennis to write to. After communicating for five monthes, they finally were able to meet. Dennis and Carol were married on April 19, 1969 at Dover, In.

Carol Elizabeth McCann was born Aug. 10, 1944. She is the daughter of Roy McCann and Lorretta Vogelsang. Carol was born at home near Dover, In. She attended Dover grade school, graduating from North Dearborn in 1962. Carol then went to work at the register and then the Federal Reserve Bank. She was working at Hillenbrands in 1967-1968.

After Carol and Dennis married they lived on the Niese home place. While there their son Joseph was born on Dec. 27, 1969 at Batesville Hospital. Cindy Ann was born Jan. 22, 1971, also at Batesville(Ripley Co.)

The family bought property near Dover, In. in Nov. 1973. Living in a trailer till 1975. The family then put up a house, this is their present residence. It is near East Central High School. Their third child, Paul David was born July 27, 1974. Their fourth child Linda Marie was born Dec. 10, 1976. Dennis works at General Electric in Evandale, Ohio. Carol is a housewife. Together they own an apartment house at Milan, In.

Michael is employed at Club Chef at Lockland, Ohio. Cindy is at home. Paul is employed at Krogers, Harrison, Ohio. Linda is at East Central High school. The family lives at 7980 Schuman Rl. West Harrison, In.

Gregory Louis Niese

Gregory Louis Niese was born, Aug. 11, 1949 at the Batesville hospital. He is the son of William Henry and Clara(Dwenger) Niese. He was raised on the family farm on Tekulve Rd. one mile east of Batesville. He attended St. Louis Catholic school, and later Batesville High School. He got a job at Hillenbrands Ind.

Because of poor eyesight, Greg wore thick glasses. He never wore his glasses while hunting, but always got the most squirrels. Greg had the thickest hair that was blond and wavy.

On Sept. 9th 1967 a tragedy struck. On his way home from a party at Sunman In. Greg was killed in an auto accident. He was 18 years old. There were four cars involved and six people were killed. Greg is buried at St. Louis Catholic Cenn. in Batesville In. He is sadly missed by his beloved family.

Clarence David Niese

David is the son of William and Clara(Dwenger) Niese. He was born Nov. 16, 1951 at Margaret Mary Hospital in Batesville, In. by Dr. Hirsch. David was baptised at St. Louis Church in Batesville, In. the following Sunday. His Godparents are Uncle Clarence and Aunt Bessie Dwenger. He attended St. Louis School recieving his first communion in the second grade and was confirmed in the fifth grade. David was raised on a farm one mile East of Batesville on Tekulve Road; where they raised chickens, Hogs, cows, and sheep. One summer a neighbors dog killed several sheep. David remembers his dad had to kill the neighbors dog, which made the neighbor really mad. Since they raised chickens, they had to gather eggs, one job David hated to do! They planted corn and oats and sometimes wheat. They spent many summer days hoeing weeds out of the corn. They would hoe out the woods and go skinny dipping in the pond;

something they were not supposed to do! In the fall they would haul the corn to be made into fodder. When dad was not with the boys they would jump off the wagon and try to grab hold of the corn shocks. David slipped one time and fell under the wagon and the back wheel ran over him. As dad was walking through the field all the brothers told David not to tell dad because he would spank all of them. Winters were spent cutting wood, sled riding and having snow ball fights.

When they were all still at home the eight boys shared two bedrooms. Gene, Jerold, Bob, and Bill shared one room. Joe, Denny, Greg, and David shared the other room. They remember dad coming up to their rooms many times during the night and telling them to be quiet and go to sleep.

During the summer of 1962 interstate 74 was built. It took part of their farm. The boys used to go to the storage area to play on the piles of sand and the highway equipment. Until the workers came and told them to get off before they got hurt.

When David was eleven years old he got Rheumatic fever in the summer, he spent the whole summer in bed! It was the worst summer he ever had. Then he had his tonsils taken out the following spring.

David graduated from grade school in 1965. He went to Batesville High school next four years, graduating in 1965. He went to Batesville High school the next four years, graduating in 1969. David took a physical for the Air Force in 1969, but didn't pass because of a heart murmur and his nerves.

David was in the Boy scouts from fall of 1963, till 1973, in troop 39, achieving the rank of Life Scout. His first paying job was for Wagner's small engine repair in 1967. In 1968 he started working at Walsman's furniture. He worked there until he was 18, when he went to work at Batesville Casket company. After working there for two years he went to work at Continental Conveyer in 1972. He only worked there 3 months and found employment at Thies Marathon and from there went to work at Ron Weber Furniture. He quit there because it was too boring and went to work at Batesville Casket Co. in 1972, where he is now employed.

David met Diane Pistner Holland at a dance at the Legion in Batesville. After talking with her most of the evening, he asked her out for a date. They were married Nov. 30, 1974. That day was really something, the weather was terrible, first it started to rain and then it turned to sleet, during church it snowed and we had eight inches. He had his car parked in his brothers garage so no one would tamper with it. When they arrived at his house to get the car they were unable to leave because of the weather. They ended up staying at his brothers house watching Underdog and wrestling on TV. The next day the weather was a little better and they went to Cincinnati and stayed there Sunday night. Snow came again so they went home. What a great honeymoon!

Diane had two girls from a previous marriage. Melanie Kaye, born 12 of Aug. 1966. and Jacqueline Regina born 12 of Feb. 1969. David felt they were his own children so he adopted them the spring of 1975. That day he really became their dad. When they got married he bought a house at 215 S. Depot in Batesville and have done some remodeling with the help of his Dad and brothers.

David and Diane had a son born Dec. 6, 1975, Greg Alan Wiese. He attended St. Louis school for four years, Westwood school one year and Batesville Middle school two years. He currently goes to Batesville High School and is a very avid hunter, like his Uncle Greg was. Melanie married Tim Podder, Aug. 26, 1989. They had a son born Jan. 18, 1991, Josh David, which made David and Diane very proud grandparents. Tim has a daughter from a previous marriage, Amanda. Jackie their other daughter moved out on her own in Dec. 1991 and lives close in Greensburg, In.

William Waldo Wiese

William Waldo Wiese was born on Feb. 8, 1953 at Margaret Mary Hospital in Batesville, In. He is the last son born to William and Clara Wiese. Bill attended St. Louis Catholic School at Batesville, for eight grades and then attended Batesville High School where he graduated in 1971. He started working at Batesville Blue Flame in July of 1969, where he is employed. Bill was raised on the family farm about one mile East of Batesville on Tekulve. Later the family moved to his Uncle's farm which his father bought and lived there three years when they moved back to the home place in 1972. In 1973 the family moved again to a new home in Morris, In. Bill's family are still living today except for a middle brother, Greg, killed in an auto accident in 1967.

On July 27, 1974 Bill married Shirley Weisbach, a childhood sweetheart. Bill and Shirley knew each other as children. Bill's mother Clara and Shirley's mother Eleanor knew each other since the teenage years, where they worked together in Cincinnati, Oh. Shirley was from St. Mary's Catholic Church in Greensburg and this is where they were married.

Shirley is the daughter of John Weisbach and Eleanor Koetter. She was born Sept. 11, 1953 at Decatur Co. Hosp. in Greensburg, In. She was the only child. She is a graduate of Greensburg High School in 1971. Shirley is also a graduate of IU-PUI School of Nursing. She passed her State Board and became a registered nurse in Sept. 1973. She is presently employed as an occupational Health Nurse at Millenbrand Industries in Batesville, for the past 15 years.

When William and Shirley were married they buildt their home 5 miles east of Greensburg, where they still currently live. Their first child, a son was born Dec. 29, 1976 at Dec. Co. Memorial Hospital. They named him Daniel John. Two and a half years later their 2nd child was born, a daughter, Julie Marie, May 29, 1979.

Bill was in Boy Scouts when he was a young child. He has followed through in the scouting tradition. He became an ass't scoutmaster in 1971 for troop 39 in Batesville for three years. In 1986 he became Webelos Den Leader and in 1987 Sept. he restarted Troop 574. In Sept. 1992 his son Daniel recieived the Eagle Scout award at the age of 15, which is the highest rank in scouting.

He also recieved outstanding Young Hoosier Award.

Besided Scouting, Bill's interest include White Water rafting and watching his children participate in sports. The family reside at 5102 E. State Road 46, Greensburg, In.

Sharon Stella Niese

Sharon Stella Niese was the ninth child of William and Clara (Dwenger) Niese. She was born Oct. 24, 1957, at Margaret Mary Hospital in Batesville, In. She was raised on the family farm near Batesville, growing up with eight older brothers, which at many times was very adventurous. She attended St. Louis school. Her family moved to Morris, In. and Sharon went to the East Central High School.

When Sharon was nine while playing on the slide with a friend during the church picnic at St. Louis she fell off the slide and was taken to the hospital. The accident left a permanent scar above her right eye. At the age of ten, she underwent surgery to have her appendix removed.

On March 8, 1975, Sharon married Toby M. Lewis at St. Anthony's in Morris, IN. Toby M. Lewis was born Aug. 8, 1955, in Cinn., Oh. He was raised by his grandparents, Katy and Daniel B. Lewis. While Toby was still in grade school, the family moved to a farm in Clinton, In. where he atteded the Milan Schools.

After their marriage, Toby and Sharon lived with her parents for a short time. Then they moved into a mobile home in Sunman, In. Sharon and Toby's first child, a son was born July 29, 1975, Toby Lee Jr. at Margaret Mary Hospital in Batesville, In. Their second child, also a son, Kenneth Daniel, was born Jan. 14, 1979 at Dearborn County Hospital in Lawrenceburg, In. Daniel was admitted to the hospital for Bronchitis twice before his first birthday and once when he was four. A third son was born May 2, 1983, Jeremy William, at Margaret Mary Hospital in Batesville, In. Through the years the boys have had the normal bumps and bruises, and stiches.

In Feb. 1985 the family moved to Tennessee where they lived in Hadison, a small suburb outside the City of Nashville and later moved to a smaller suburb, Westmoreland. In Jan. 1986 after a year in Tenn., the family moved to a house in the City of Sunman, which is where they presently live.

Sharon is presently working at national Gardening, in Lawrenceburg, In. Their children go to school in Sunman-Dearborn School District. Toby Jr. will graduate in May 1992.

Melanie Niese Flodder

Melanie is the daughter of Diane and David Niese. She was born Aug. 12, 1966 at Margaret Mary Hospital by Dr. Hizrich. She lived in St. Peters, In. her first 6 years. She was baptised at St. Peters Catholic church and attended Kindergarten in Brookville, In. She moved to Batesville In. and attended St. Louis Catholic church for 8 years. She made her first communion in second grade, her first confession in fourth grade and confirmed in fifth grade. She attended Batesville High School and graduated in May of 1984. While attending High School and for a while afterwards at Margaret Mary Hospital in the Kitchen. After quitting at the Hospital, she moved to Indianapolis for about 3 months and lived with her best friend and her friend's brother. She moved back home and started working at Hardees Restraunt until she found a full time job about two monthes later. She started working at Cardinal Communications, a cable office in Batesville for almost 6 years. Melanie married Tim E. Flodder, son of Robert and Anna Mae Flodder, on Aug. 26, 1989, at Batesville United Methodist Church by Rev. Charles Flory. Tim had a daughter from a previous marriage. She is now her step-daughter, Amanda K. Flodder. Amanda was born on Feb. 6, 1985, at Margaret Mary in Batesville, In. She was delivered by Dr. Michael Hansen. She worked for Cardinal Communications until she went on maternity leave in Jan. 1991. Tim and Melanie had a son Joshua David Flodder. He was born on Jan. 18, 1991, Margaret Mary Hospital, and delivered by Dr. Stephan Glaser. Tim is employed with fellers Service Station in Batesville. He has worked there for 17 years. Melanie is now employed at Batesville Blue Flame as a secretary/receptionist. Tim is a member of the Batesville Volunteer fire Department and has been for 7 years. Melanie is a member of the Batesville Rescue 10 Life Squad since 1991, and is a certified Emergency Medical Technician. Tim and Melanie with their two children reside at 805 W. Pearl Street, Batesville, In.

12. Stella Catherine Dwenger, was born on July 8, 1917 2:00 a.m., at Hamburg IN. in Franklin County. She was the daughter of Henry and Anna (Huth) Dwenger. (Written by Mary Taylor) Stella had two younger brothers, Norbert and Paul. When stella was 17 her mother died. She had little education, (someone told me that she finished the sixth grade). Before her marriage she did housework for others and cared for Marlene Weber, who was not in good health. She also helped take care of the home, and her dad and brothers. Stella never remembered much of her childhood, so most of what is written here was told to me by Aunt Bessie Dwenger and Aunt Clara Niese.

Stella married John Henry Tekulve, the son of Louis and Elizabeth (Kleine) Tekulve, at St. Ann's church in Hamburg Sept. 1941. The wedding party included Leona Tekulve, sister of John, and Edward Dwenger, the oldest brother of Stella. John worked on the farm for Louis, his father. He lived on the farm all his life. John Henry Tekulve was born July 6, 1910 at home. When he was 16 his family built a new home, and John and Stella's home was very similar, the homes were on opposite sides of Tekulve Ave.

I (Mary(Tekulve)Taylor), was born on Aug. 17, 1942 on the Tekulve Ave. home which was built by my grandfather, Henry Dwenger and Edward Dwenger, my Uncle, in 1941 for my parents, John Henry and Stella Katherine (Dwenger) Tekulve. The Tekulve farm of 80 acres was purchased in 1855 by Catherine Eliz. Bestert Tekulve. The Tekulve family came from Sudlohn, Germany on the ship "Hansa" which left Germany on Sept. 22, 1854 and arrived in New York Oct. 9, 1854. The father of the family, Johann Heinrich Tekulve died at Cinn. Enroute to Batesville Dec. 1854. Catherine Elizabeth Besert was my great great grandmother. After the death of Catherine, the farm went to her son, Johann Heinrich- after his death to his son, Louis Tekulve-- after his death, - to Louis's son John Tekulve, who was my father. My father died July 14, 1984 at Batesville and the farm was sold soon after to the Hillenbrand Industries for part of the golf course.

After John's death on July 14, 1984, Stella moved to Heritage House Senior Citiz. Apt. and she was very happy there. She always liked to be around people and had many friends. In 1990 she moved to Dreyerhouse Nursing Home after a slight stroke and kidney failure, requiring her to be on a kidney dialysis machine. She never complained, and loved her new home at Dreyerhouse too. Once when I drove her by the old homeplace on Tekulve Ave, she said she didn't ever want to go back there, she liked her new home at Dreyerhouse. Dreyerhouse nursing home stands on the original land the Tekulve's purchased in 1855. Around 1960 Stella found out she had been born with only one kidney and her grandchild, Kaitlan Taylor Kinn, born 1989 to my daughter, Yanny(Taylor) Kinn, was also born with one kidney.

I remember going to Hamburg to visit my Grandpa Dwenger - we were always afraid we would run off the road and fall down into the deep valleys on the hill going down to Hamburg, and the old covered bridge was scary, we just knew it was going to fall in when we went through it and none of us could swim. We thought for sure we would drown.

John and Stella(Dwenger) Tekulve had 5 children in 3yrs. 4M. There was no electric in the house and no modern conveniences, we have in 1993. Mom cooked on a stove heated by wood which also heated the two rooms we lived in in the winter months. We slept upstairs under feather beds, and it was so cold when we had to crawl out of those feather beds. We had no indoor plumbing and used an outside toilet with old catalogs for toilet paper. Once a week we took a bath in a tub upstairs in the room that had a vent so the heat went upstairs. There were 4 rooms downstairs and 2 upstairs. On Monday, which was usually wash day, Mom pumped water and heated it on the stove and washed with a washboard. When we got electric (I can't remember exactly, but I think it was around 1950), she had a wringer washer and it took all day to wash and hang it out to dry. In winter we hung clothes on a rack by the stove to dry. We butchered hogs for meat, mom raised chickens to eat and for eggs. I always hated to watch mom kill the chickens. Then she would have to clean them and then fry them. All our vegetables and fruits were raised on the farm and mom would can corn, tomatoes, green beans, peaches, cherries, pears, plums, grapes and blackberries. In the blackberry season we would pick 5 gallon buckets full, and mom would make lots of jelly. We picked blackberries in Benz's woods and sometimes we would see a bull and get real scared. Mom also made a lot of grape jelly. We had a lot of fruit growing on the farm since my great-grandfather, John Heinrich Tekulve, was a nursery man.

We never had a lawn mower, dad and grandpa would just let the cows loose after milking and they would eat the grass. We walked to St. Louis school and I remember my brother once got frost bite on his fingers. Mom baked all her own bread and coffeecakes. We always thought the town kids were so lucky to buy "bakers bread". Mom made the best bread and coffeecakes, I can still remember how good they tasted. Daddy would go to the store and buy just the staples, such as coffee, sugar, flour, yeast, butter. We had meat, mashed potatoes (still my favorite) and a vegetable most every day; never having casseroles or fancy desserts. A treat for us was jello with bananas or lemonade and crackers. We always had a big potato patch and ate lots of potatoes.

John and Stella's five children were all born at home: 1. Mary Elizabeth born Aug. 17, 1942; 2. Ronald Louis born Sept. 1943; 3&4. Marlene Ann and Kathleen Leona (Twins) born July 12, 1944; 5. Virginia Bessie born Dec. 22, 1945.
Histories of the children of John and Stella Tekulve:

1. Mary Elizabeth Tekulve was born on August 17, 1942 at Batesville In. She was married to Robert B. Taylor on July 7, 1962 at Batesville, In. Robert(Bob) Taylor was born on July 6, 1943 at Cincinnati, Ohio. He was the son of Joseph and Pauline (Lewis) Taylor. They later moved to New Point, in Decatur Co. In., when he was four years old. Bob works at AT&T in data processing at Cinn. Ohio. He has worked at AT&T since 1966. In 1986 he joined the St. Louis Church in Batesville, and started going to college at Mt. St. Joseph in Cinn. Ohio., and will graduate in May of 1993 with a degree in accounting and Lay pastoral ministry. He plans to attend college in fall of 1993 to get a masters in Business Adm.

Mary graduated from Batesville H.S. in 1960 and worked in the office at Hillenbrands. After the children were born she worked part time as a waitress and today works part-time at crop-mate fertilizer Co. in New Point. I enjoy geneology and plan to get a book together on the Tekulve family. I like to camp and walk, talk, do volunteer work at St. Louis Church and school and the nursing home. I love people and do love family activities. My mother, Stella Katherine has been a real inspiration to me. Mary and Robert Taylor are the parents of five children: Terrance, Tamara Jo, Timothy, Theodore, Traci.

1. Terrence Joseph Taylor was born Oct. 3, 1962 at Mercy Hosp. in San Diego, California while Bob was in the U.S. Navy. Terry is a graduate of Purdue Univ. and is an Electrical Engineer at Naval Avionics and is currently thinking about going back to school to

study foreign languages. Terry liked acting in plays, music (band, electric guitar and piano) and loved to garden. He had a nice patch of everbearing strawberries that didn't do so well when he left for college.

2. Tamara Jo Tayler was born on Feb. 17, 1964 at Margaret Mary community Hosp. in Batesville. She is a graduate of Marian College and is a clinical dietician at Loyola Univ. Hosp. near Chicago. She married Timothy Michael Kinn on September 12, 1987 on Marian College Campus at Indianapolis In. Their daughter, Kaitlan Taylor Kinn, was born Jan. 17, 1988 in Illinois. Tim works in marketing at Superior Bank in Chicago. They live at La Grange, Illinois, close to Tim's parents, Patrick and Joyce Kinn.

3. Timothy Joseph Taylor was born July 20, 1965 at MHCH at Batesville. He went to Purdue University for a semester and decided college was not for him. He lives at Indianapolis and works as a waiter for Steak and Ale. He is interested in photography and takes some wonderful scenery pictures. In high school he loved band and acting in plays.

4. Theodore Joseph Taylor was born on Dec. 22, 1966 at MHCH. He is a 1985 graduate of North Decatur High School, served in the U.S. Army, including the Saudia Arabia conflict. He currently works at James Rivers factory in Greensburg. He married Heather Denise Garrity on Sept. 16, 1991. Heather is in the respiratory dept. at the Haven Center in Shelbyville. Their daughter, Brittnie Dayton Taylor, was born Jan. 12, 1992 at IU med center at Indianapolis and died shortly thereafter. She is buried at the St. Louis Catholic Cem. at Batesville, Indiana.

5. Traci Jo Taylor was born on July 17, 1981 at MHCH at Batesville, Ind. She is a 6th grade student at St. Louis School in Batesville, which her mother attended from 1948 to 1956. She is interested in acting, writing, and clogging. Once a month her and a friend entertain the patients at Dreyerhaus Nursing home with clogging and piano. She also belongs to the Busy Bees 4-H club where Mary is a leader.

2. Ronald Louis Yekulve was born September 4, 1943 at Batesville, In. Ripley Co. He was married to Sherry Gardner at Harrison, Ohio on July 3, 1965. Sherry was born on Oct. 21, 1947 at Cincinnati, Ohio; the daughter of Harvey and Kitty Gardner. Ronald and Sherry are the parents of Three children:

1. Ronald Louis Yekulve, born May 6, 1966 at Portsmouth, Va.
2. Troy Yekulve, was born Sept. 26, 1972 at Hamilton, Ohio - died 10 days later.
3. Casey Yekulve was born on March 5, 1975 at Hamilton, Ohio.

3. Kathleen Leona Yekulve (Yula) was born on July 12, 1944 at Batesville In. in Ripley Co. She was married to Russell Manuel Wagner on September 7, 1963 at Batesville, In. He was born on June 17, 1942 at Greensburg to Gilbert & Caroline Keeley Wagner. Kathleen and Russell are the parents of two children:

1. Daniel Manuel Wagner was born on July 20, 1964 at Batesville.
2. Sandra Kay Wagner was born on May 6, 1968 at Batesville, In. She was married in Nov. 1986 to Robert Short. He was born the son of Carnell and Ernestine Short. They have two children: 1. Robert Manuel Short, born Dec. 13, 1986, and 2. Ashley Dawn Short, born on April 28, 1992.

4. Marlene Ann Yekulve (Yula) was born on July 12, 1944 at batesville, In. She was married to Stephen Buening on Oct. 3, 1963 at Batesville- he was born Sept. 10, 1939 at Greensburg to Ed & Clara Harpring Buening. They are the parents of four children:

1. A girl, stillborn, buried at St. Mary's Cem. Greensburg.
2. Mark Stephen Buening was born on April 7, 1967 at Greensburg, In. in Decatur Co. He married Tamara Remmler on July 13, 1991 at Greensburg, In.
3. Karen Marie Buening was born on April 24, 1968 at Greensburg.
4. Trina Kay Buening was born on Aug. 3, 1971 at Greensburg.

5. Virginia Bessie Yekulve was born on Dec. 21, 1945 at Batesville In. She was married to Jerome Aloysius Bruns, on April 16, 1966 in Greensburg, In. Decatur County. Jerome was the son of Elmer and Louise(Miller) Bruns. They have two children:

1. Nancy Rene Bruns was born on Aug. 29, 1967 at Greensburg, In. She was married to Brian Lee Mirick on Sept. 3, 1988 in Greensburg. Brian was the son of Don and Deanna(Wagner) Mirick. Nancy and Brian Mirick are the parents of two children: 1. Lauren Mirick, born on May 4, 1990 at Greensburg. 2. Brian Lee Mirick, born on June 30, 1992 at Greensburg.
2. Christopher Jerome Bruns, born Sept. 28, 1970 at Greensburg.
3. Carrie Elizabeth Bruns, born Sept. 23, 1977 Greensburg, In.

14. Peter Paul Dwenger was born on Oct. 8, 1923 at Hamburg, In. the youngest son of Henry and Anna(Huth) Dwenger. He attended the little Hamburg school there. Paul was inducted into the U.S. Army and served in the second World War. He was sent to San Pietro, Italy where he was wounded by enemy sniper fire on Dec. 16, 1943. On Jan. 23, 1944, he was presented the purple heart award. On Feb.

24, 1946, he was honorably discharged from the Army with rank of Corporal.

Peter Paul was married on Aug. 18, 1945 at Indianapolis, In. to Florence Elizabeth Mattingly.

Florence was born on Sept. 17, 1926. She was the daughter of Dowling and Eva (Monte) Mattingly from Loogootee, In. She died of Cancer on Sept. 19, 1982, in the chapel on the base of Fort Benjamin Harrison. Peter and Florence were the parents of five children: Janice Ann, Kenneth Paul, Deborah Joan, Richard Joseph, Randall Mark.

Paul was a purchasing Agent for the Veterans administration Hosp. for over 30yrs. He retired when he was 55. Paul and Florence owned their own home in Indianapolis, In. at 440 N. Boehning where their son Randy still resides. They were members of Holy Spirit Cath. Church.

Peter Paul Dwenger, was married a second time on Jan. 5, 1984, to Patti Ziegler, at the Holy Spirit Church in Indianapolis. Patti was born on Aug. 15, 1926 and died on June 9, 1989. Peter Paul Dwenger died on April 23, 1988 at the Vet. Admin. Hosp. He had a right lower lobectomy of his lung to remove a cancerous tumor. He seemed to be recuperating well when a blood clot lodged in his right lung, he died of this complication.

Histories of Peter P. and Florence's children:

1. Janice Ann Dwenger was born on Aug. 14, 1946 in Indianapolis, In. the daughter of Paul and Florence Dwenger. She was married to Daniel Joe Metz of Swayzee, In. on Nov. 18, 1967 in Indianapolis, IN. They are now residing at their home on 1508 Colonial Drive, Godfrey, Il. 62035. They are the parents of 3 children: 1. Brian Daniel, born on Oct. 9, 1968 in Toledo, Ohio. Now residing in Elshah, Il.

2. Jennifer Ann, born on May 26, 1970, in Toledo, Ohio. She married Ronald L. Davenport of Alton, Il. Now residing in Godfrey, Il. --Two children 1. Adam Edward Paul Davenport, born May 6, 1989 in Alton, Il. 2. Nathan Daniel Davenport, born April 7, 1990 in Alton, Il. Div. Sept. 9, 1991

3. Jodi Lynne, born Nov. 9, 1973 in Kalamazoo, Mi. Now residing at Eastern Illinois University, Charleston, Il. where she is a sophomore.

2. Kenneth Paul Dwenger (Kenny) was born March 5, 1949 in Indianapolis, In. the son of Paul and Florence Dwenger. He was married to Janet Sue (Wolfe) on Aug. 29, 1969 in Indianapolis In. They are now residing at 1131 Birdie Rd. Broomfield Colorado. 80020.

3. Deborah Joan (Debbie) Dwenger was born on July 24, 1951 in Indianapolis In. the daughter of Paul and Florence Dwenger. She was married to Ralph Kenneth Allen in Indianapolis, on Aug. 5, 1972. Now residing at 1765 Woodridge, Place, Greenwood, Ind. 46142. They are the parents of two children:

1. Jeffery Kenneth (Jeff) Allen, born July 15, 1975, in Indianapolis, In. 2. Michelle Elizabeth (Chelle) Allen was born April 22, 1977 in Indianapolis, In.

4. Richard Joseph (Rick) Dwenger was born on Nov. 3, 1954 in Indianapolis, In. the son of Paul and Florence Dwenger. He was married to Lisa Nan (Reichle) in Muncie, In. on Nov. 19, 1977. They now reside at 3005 Grace Lane, Muncie, In. 47304. They are the parents of two children:

1. Kate Anne Dwenger, born Feb. 10, 1982 in Muncie, In. 2. Abbie Lynne Dwenger, was born Dec. 17, 1984 in Muncie, In.

5. Randall Mark (Randy) Dwenger was born on Nov. 21, 1959 in Indianapolis, In. the son of Paul and Florence Dwenger. He was married to Karen Sue Bingham, from Franklin, In., in Indianapolis on May 28, 1983. They are now residing at 440 N. Boehning, St. Indianapolis, In. 46219. Which is the home where Paul and Florence raised their family. They were div. Jan. 1993.



Henry and Anna(Huth)Dwenger

Henry Bernard Dwenger b/1846 Anna
M. Huth b/1851 Wedding picture 1899



Clarence Dwenger of Hamburg

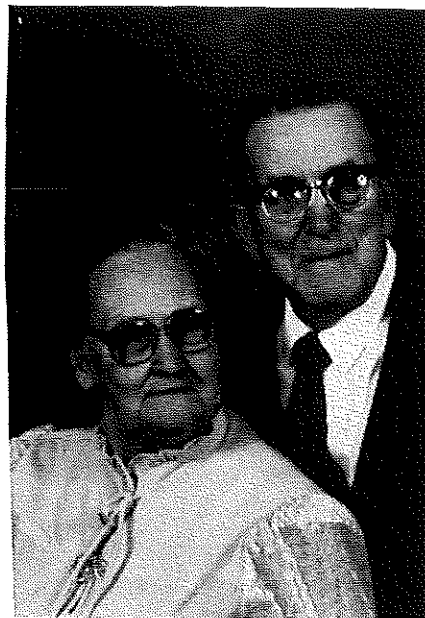

Clarence Dwenger
Bessie(Wirth) Dwenger

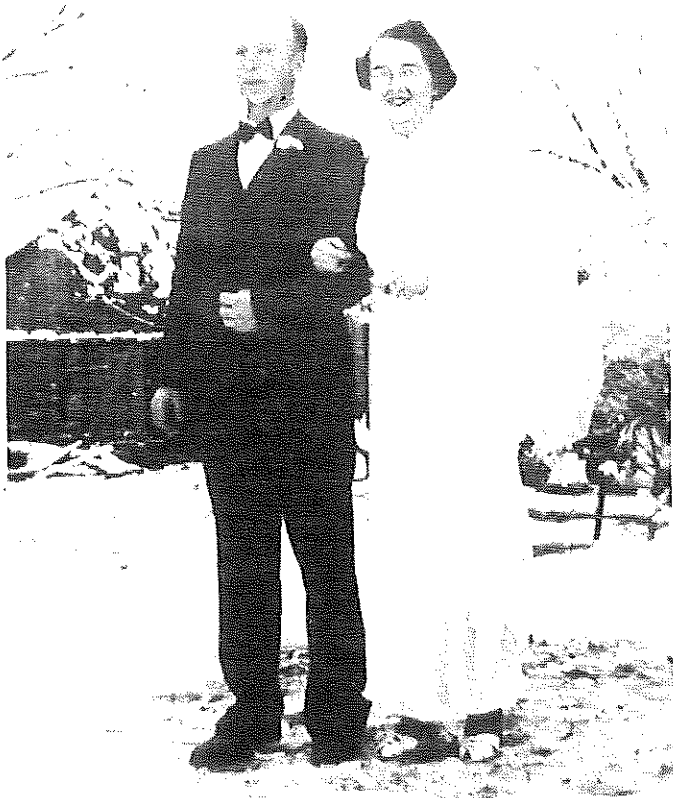

William Niese and Clara Dwenger
Wedding day: Jan.18,1939



Dennis Niese



Joseph Niese
while in Viet Nam



Henry Bernard Dwenger and Anna M. Huth
wedding picture: Jan.27,1899 Hamburg



#73 Henry Dwenger & Grandchildren

Henry Dwenger and Grandchildren



#47 Stella, Emma, Edward, Paul, Bessie, Henry and Clarence Dwenger

Stella, Emma, Edward, Paul, Bessie, Henry & Clarence Dwenger

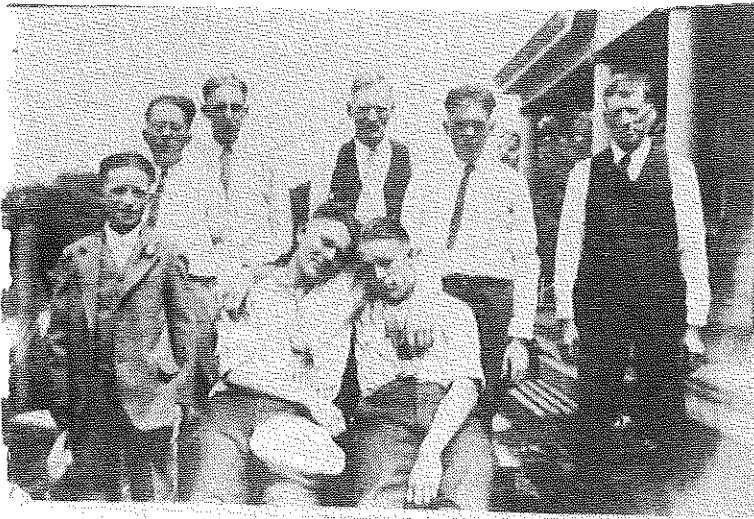

#15 Waldo, Ed, Clarence, Alfred, Henry, William Dwenger and Bill Nobbe

Waldo, Ed, Clarence, Alfred, Henry, William Dwenger and Bill Nobbe.

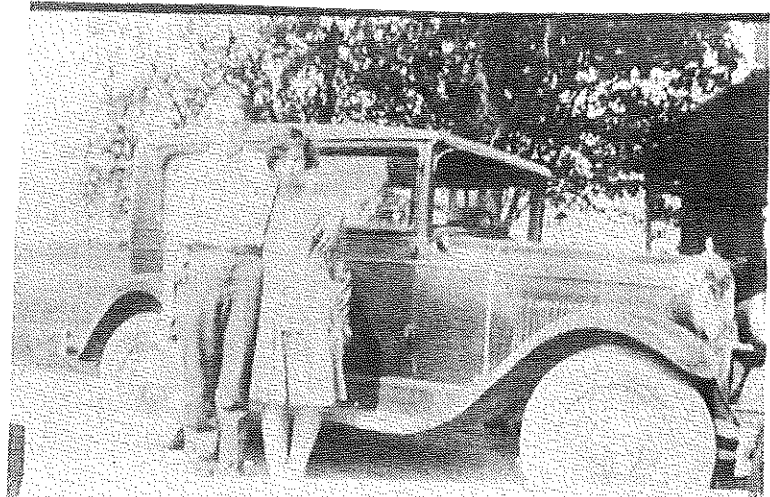

#25 Alfred & Myrle

Alfred and Myrle

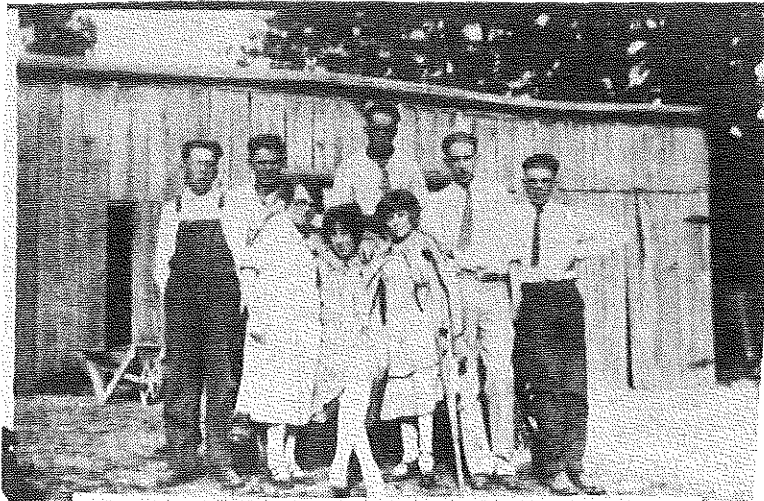

#13 Clarence, Alvina, Carrie, Emma, Ed, Alfred Dwenger and ???
Clarence, Alvina, Carrie, Emma, Ed, Alfred, Dwenger. and ???

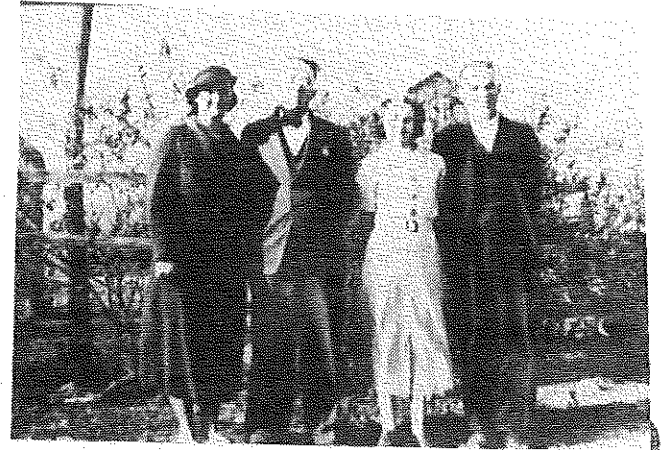

FRANK JOHN AND ANNA (SIBEL) DWENGER

Frank John Dwenger was born on Aug. 20, 1868, at Hamburg Indiana. in Franklin County. He was the son of William Dwenger b/1839 Ohio and Catherine (Raver) Dwenger b/1842. in Indiana.

Frank was one of eight children; John, William, Frank Bernard, Carrie (Ceibel), Henry, Francis, Vincent. Frank was born and raised in the small town of Hamburg. His father had owned and operated a general store there. His family attended the St. Anne's Catholic Church in Hamburg Indiana.

He was married to Anna Magdalena Seibel on May 25, 1892 in Franklin County Indiana, at the Catholic Church. Anna Magdalena Seibel was born on June 13, 1872 in Indiana. She was the daughter of Henry Seibel b/1838 German, Magdalena (Hahn) Seibel b/1843 St. Leon Indiana. Anna was one of eleven children; John, Kate, (Schroader), Margaret, Joseph, Henry, Lena, Felda (Valentine), George, Frank, Bernadette.

Frank and Anna were devoted Catholics. When they were first married, Frank rented a small farm where they lived. Anna and Frank Dwenger were both Catholic, they attended the St. John's Church at Oldenburg for awhile. Their first child was a son, Hilmer John Dwenger, born on March 11, 1893 at Hamburg Indiana. Frank was a member of the Knight of St. John and the Holy Name Society. He was a farmer in Decatur County for most of his life. Their second child John Henry Dwenger (Harry John) was born on Feb. 19, 1898 at Hamburg Indiana. Their first daughter, Stella, was born on Feb. 28, 1904 at home in Decatur County. Their second daughter, the fifth child was Martha, born on Oct. 17, 1908.

Anna (Seibel) Dwenger, had a sense of humor and was known to tease at times. On one occasion, she went to call her sons to get up in the morning. After calling them with no response, she called up to the sleeping boys, the house is on fire! This did get the boys out of bed quickly, and she had a good laugh, this sense of humor was passed on to her children, her son Harry, loved to tease the grandchildren.

Their daughter Stella, at the age of 12, complained one morning of not feeling well, and she stayed home from school for this reason. Her brother Harry teased her that she wasn't really sick and that she was pretending to be sick to stay home from school. She did have hiccups, that wouldn't stop. Stella became rapidly more ill and she died in December of 1916, from appendicitis. Harry felt guilt about having teased her for years, because he hadn't thought that she was really sick. There was a occasion when Harry John and some friends, as a prank, took a neighbors wagon late one evening and placed it atop his barn. They thought it was quite a joke seeing the amazement on the mans face the next morning at finding it there. Frank, who had heard the boys had a real fun time doing that! They all laughed at the great joke, until Frank said "Now you can have just as much fun as taking it back down again, and don't you break one of those wheels doing it", They got it back down, using a hoist, but, "it sure did seem like a lot more work taking it down than putting it

up there". said Harry afterwards.

When Harry was about 21, he was cutting wheat with a scythe and cut his arm badly. They called for the doctor, who came out to their house. The doctor laid him on the kitchen table to sew him up. They must not have hooked up the liter in his arm right. Because his little finger couldn't open up and the others were stiff.

Frank and Anna insisted that the boys get to bed early as they would have a hard days work ahead on the farm. So Harry and his brothers would stay out late(early next morning), then come in and mess up the covers on the bed so it would look like they had slept in their beds.

Frank Dwenger purchased a farm in Decatur County Indiana. The land contained a foreman's house on his farm. His son Harry John and his wife Mary, who were married in 1923, lived in this house when they were first married, and Harry worked for his father on the farm. Frank Dwenger sold his farm and he and Anna moved into a home when they had purchased in the town of Greensburg ,in Decatur Co. Indiana. Anna Seibel became ill and passed away on Sept, 22,1929. She is buried at the Millhousen Catholic Cemetery. Frank Dwenger resided his later years with his daughter Martha Steir and here husband, at their farm in the country, south of Greensburg.

Frank Dwenger passed away on Nov.27,1939, at his daughter Martha Steir's house, near Greensburg Indiana, from heart trouble. He also is buried at millhousen Indiana, in Decatur Co. Frank and Anna were the parents of six children;

1.Hilmer John Dwenger b/1893, married to Nora Walke, they had three children;Hilmer Jr..Dorothy(Jewell),Carol(Unsell).

2.Raymond William Dwenger b/1895, married to Flora Rolfes; they had nine children;Bob,Ralph,Edna(Bruns),Helen(Sullivan), Don, Mary Jane(Sullivan, Russel) Patricia ,Patrick.

3.John Henry(Harry John) Dwenger b/1898, married Harry Hessler;they had ten children;Kathy,Esther,Rosie,Ruth, Anna Dick,Betty, Leonard,Mary Ellen,Edward Joseph.

4.Stella Dwenger b/Feb.28,1904,she died young at the age of thirteen from appendicitis in 1916.

5.Martha Dwenger b/Feb.28,1905 married to Bernard Steir; they had three children;Harold,Margie(Hahn),Phyllis(Laymen).

6.Ellen M.Dwenger b/July 21,1908, married to Joe Ries; they had five children; JoAnn (Haffey), Jimmie, Marion (Dauer), Evelyn (Hoffman).



standing: 1908 Anna Seibel, Kate (Seibel) Schroder
sitting: Magdalena (Hahn) Seibel holding Hilda Schroader

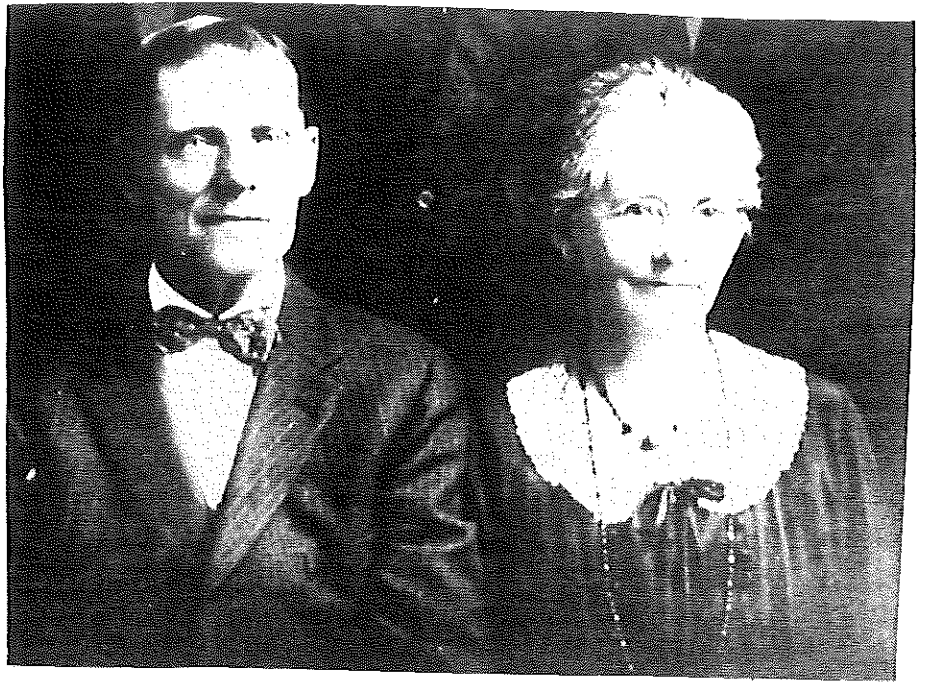

Frank Dwenger and Anna (Seibel) Dwenger
taken around 1926



Martha age 2 Stella age 3
taken Jan. 1908
dau's. of Frank and Anna Dwenger



Frank J. and Anna (Seibel) Dwenger
at home in the early 1900's



DWENGER FAMILY FLORA & RAY DWENGER
 FRONT TO BACK MARTHA & BERNARD STIER
 ELEANOR & HILMER DWENGER
 MARY & HARRY DWENGER
 ELLEN & JOE RIES



Front to Back: Dwenger family
 Flora and Ray Dwenger
 Martha and Bernard Stier
 Elenor and Hilmer Dwenger
 Mary and Harry Dwenger
 Ellen and Joe Ries



Wedding of Raymond and Flora (Rolfes) Dwenger
 Sept. 12, 1917 Millhousen Indiana, Decatur County.
 L to R: Hilda (Rolfes) Votel, Ray Dwenger, Harry Dwenger, Flora



Joe and Ellen (Dwenger) Ries Family 1940
 Joanne Ries Joseph Ries
 Maxine Ries, Ellen and Evie, Jim Ries

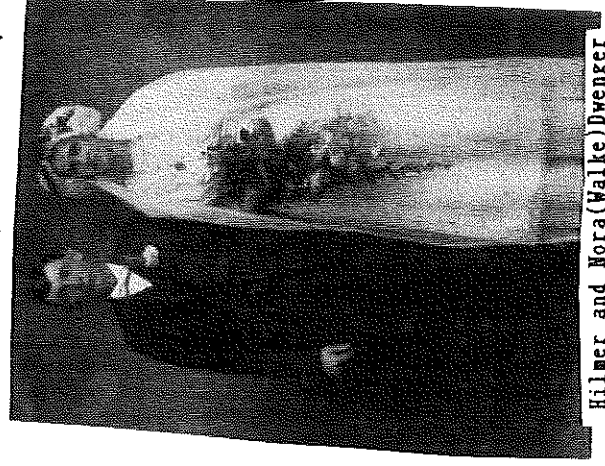

Hilmer and Mora (Walke) Dwenger
 Oct. 27, 1914

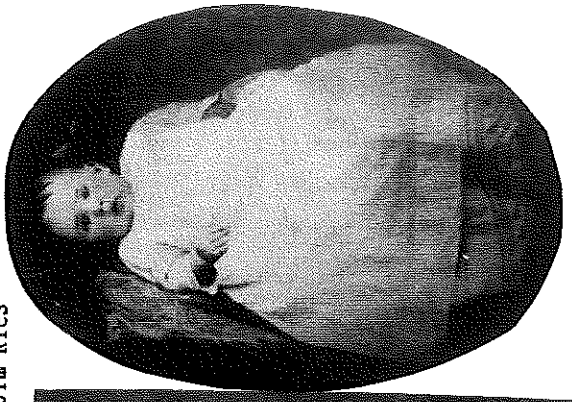

Dorothy (Dwenger) Jewell

RAYMOND AND FLORA(ROLFES)DWENGER

Raymond William Dwenger was born on Jan.14,1895 at Decatur County, Indiana.

He was born the son of Frank J. Dwenger born Aug.20,1868 Hamburg, and Anna (Seibel) Dwenger born June 13,1872.

Raymond was one of six children: Raymond, Hilmer, Harry J., Stella(died at age 13), Martha(Stier), Ellen(Ries).

He attended school until around the 7th grade when he left to help his father on the farm.

The Dwenger family were members of the Catholic Church, they were members of, and attended the Catholic.

Raymond Dwengers father was a farmer and while growing up the Raymond and his brothers helped their father with the work on the farm.

Raymond Dwenger was married to Flora T. Rolfes in 1917. Flora Rolfes was born on Feb.25,1897. She was the daughter of John and Ann (Fry) Rolfes of Millhousen. She was one of six children: Clarence, Richard, Boy(died Young), Flora, Martha(Luken), Hilda.

Raymond Dweger worked as a tenant farmer and the family lived in various places in the early years. They lived on a farm in Decatur County. (I-74 goes through now where the farm was.) By the Sandcreek Baptist Church.

Ray and Flora Dwenger purchased a farm in 1937, consisting of eighty acres, but they didn't make enough from farming and Ray also went to work for the highway department.

They had eight children: Robert, Ralph, Edna(Bruns), Helen (Sullivan), Donald, Mary Jane(Sullivan), Russell, Pauline[Pat] (Mulvaney).

The children went to many different schools until they attended the New Point school. There their father made arrangements for them to go to the school at New Point.

Around 1945 Raymond Dwenger retired, at which time he was employed as the street commissioner, in the city of Greensburg. Ray and Flora had previously sold their farm and purchased a home on 701 East Washington Street, in Greensburg, Decatur County Indiana.

Raymond and Flora were members of the St. Mary's Catholic church in Greensburg. Ray was also a member of "Knights of St. John's" and the "Eagles" Lodge, in Greensburg. Their son Russel Dwenger lived at home.

Raymond Dwenger passed away on November 30,1968. Flora and Russell, continued to live at their home in Greensburg. Flora (Rolfes) Dwenger, passed away on Feb. 10,1990.

ROBERT F. AND DOLORES (KLENE) DWENGER

ROBERT F. DWENGER WAS BORN JULY 14, 1921. HE DIED AUGUST 15, 1979. ON NOVEMBER 20, 1941, HE MARRIED DOLORES (DEE) KLENE. THEIR MARRIAGE PRODUCED TWO CHILDREN; LINDA ANN BORN AUGUST 26, 1942 AND DONNA KAY BORN JULY 12, 1945.

LINDA MARRIED BRUCE KIRKPATRICK OF FLORIDA ON JUNE 3, 1974. THEY NOW LIVE MENA, ARKANSAS. THEY HAVE NO CHILDREN.

DONNA MARRIED MIKE MEYEROSE OF GREENSBURG AUGUST 8, 1964. THEY LIVE IN INDIANAPOLIS, IN. THEY HAVE THREE CHILDREN. JEFFREY BORN FEBRUARY 20, 1965, KEVIN BORN AUGUST 4, 1967 AND MICHELLE BORN MAY 14, 1970.

JEFFREY MEYEROSE MARRIED CINDY SOVERN APRIL 11, 1992 AND THEY LIVE IN INDIANAPOLIS. HIS SON JOSEPH "JOEY" WAS BORN MAY 28, 1993. HIS STEPSON IS MATTHEW NEILGH WHO WAS BORN FEBRUARY 27, 1984.

KEVIN IS NOT MARRIED AND LIVES IN LAREDO, TEXAS.

MICHELLE MARRIED JOHN ROOT AUGUST 8, 1992. THEY LIVE IN GARRETSVILLE, OHIO AND HAVE NO CHILDREN.

EDWARD AND EDNA (DWENGER) BRUNS

Edna Dwenger was born on March 4, 1925 at Greensburg, Indiana. She was the daughter of Raymond and Flora (Rolfes) Dwenger.

Edna graduated from the St. Mary's Catholic school in Greensburg, Indiana (Decatur County)

She was one of eight children: Robert, Ralph, Edna, Helen, Donald, Russel, Mary Jane, Patricia.

Edna Dwenger was married on May 1, 1945 to Edward Bruns at Greensburg, Indiana. Edward was the son of Edward and Helen (Witkemper) Bruns, from Millhousen, Indiana.

Edna and Edward purchased a home in Batesville, Indiana; where they currently reside today. Edward is retired from Texas Eastern transmission Co.

Edward and Edna Bruns are the parents of three children:

1. Robert Bruns b/June 13, 1944. He is married to Shirley Hansen. They are the parents of two children: Gregg and Kirt. They reside in Scottsdale, Ariz.

2. Steve Bruns b/July 29, 1949. He married Candice Marsh. They have two children, Stephanie and Leah. They live in Greenwood.

3. Cindy Bruns b/Nov. 11, 1951. She married Gerald Moeller. They live in Batesville, Indiana. They have two children: Nathan, Josh.

RALPH AND MARY LOU(GINDLING) DWENGER

RALPH RAYMOND DWENGER WAS BORN ON FEBRUARY 26, 1927, THE THIRD CHILD OF NINE CHILDREN. HIS PARENTS WERE RAYMOND W. DWENGER BORN JAN. 14, 1895 AND FLORA T. (ROLFES) DWENGER BORN FEBRUARY 25, 1897. HIS OLDER SIBLINGS WERE EDNA (DWENGER) BRUNS BORN MARCH 4, 1925 AND ROBERT F. DWENGER BORN JULY 14, 1921. TO FOLLOW WERE DONALD J. DWENGER AND MARY JANE (DWENGER) SULLIVAN--TWINS--BORN AUGUST 15, 1929, HELEN M. DWENGER BORN FEB.9,1931, PAULINE (DWENGER) MULVANEY AND PAUL DWENGER BORN JULY 25, 1933, AND RUSSELL DWENGER BORN JULY 8, 1935. PAUL DWENGER ONE OF THE TWINS BORN JULY 25, 1933 DIED JULY 28, 1933. ROBERT F. DWENGER DIED AUGUST 15, 1979 FOLLOWING A MASSIVE STROKE AT THE AGE OF 58.

RALPH'S MOTHER, FLORA T. ROLFES WAS THE DAUGHTER OF JOHN AND ANN (FRY) ROLFES AND HIS FATHER RAYMOND W. DWENGER WAS THE SON OF FRANK AND ANNA (SEIBLE) DWENGER.

RALPH ATTENDED VARIOUS GRADE SCHOOLS IN THE DECATUR COUNTY AREA INDICATED BY HIS PARENTS RESIDENCE. HE ATTENDED AND GRADUATED FROM NEW POINT HIGH SCHOOL. HE SERVED IN THE US ARMY AIR CORPS FROM JUNE 1945--JAN 1947. HE GRADUATED FROM UNITED TELEVISION LABORATORIES IN LOUISVILLE IN 1949.

HE BEGAN HIS WORK CAREER AT CROSLEY MFG. IN CINCINNATI, OHIO. FROM THERE HE MOVED TO RADIO STATION WCSI IN COLUMBUS, INDIANA IN A POSITION AS ENGINEER. WHILE WORKING AT WCSI HE ALSO WORKED FOR HORN'S APPLIANCE MART AS A SERVICE TECHNICIAN. EVENTUALLY HE RESIGNED HIS POSITION AS ENGINEER AT WCSI AND WORKED FULL TIME AT HORN'S APPLIANCE AS A SERVICE TECHNICIAN, SALESMAN AND EVENTUALLY MANAGER. HE WAS EMPLOYED THERE 25 YEARS.

ON JUNE 30, 1951 RALPH WAS MARRIED TO MARY LOU GINDLING OF BATESVILLE, INDIANA. MARY LOU WAS THE OLDEST CHILD OF MICHAEL J. GINDLING AND ROSINA (TEKULVE) GINDLING. MARY LOU WAS BORN FEBRUARY 20, 1931 AND GRADUATED FROM IMMACULATE CONCEPTION ACADEMY IN OLDENBURG, IN--1949.

THERE WERE SIX CHILDREN BORN OF THIS UNION--PAMELA SUE JULY 22, 1952, GREGORY PAUL, FEBRUARY 15, 1955, GWENDOLYN LOU (WENDY), NOVEMBER 25, 1956, RANDALL RALPH (RANDY) JUNE 10, 1958, RICKY MICHAEL (RICK) MAY 12, 1961 AND RONALD RAYMOND (RON), SEPT. 14, 1964.

PAMELA SUE (PAM) DWENGER GRADUATED FROM COLUMBUS HIGH SCHOOL IN 1970. SHE ATTENDED BALL STATE UNIVERSITY 1970--1971. SHE MARRIED DAVID HEATON SON OF HUBERT AND KAY HEATON OF SEYMOUR ON JANUARY 15, 1972. THIS MARRIAGE PRODUCED THREE CHILDREN. BRIAN EUGENE BORN JULY 10, 1973, BRENT DAVID BORN MARCH 12, 1976 AND BARBARA ROSE NOVEMBER 28, 1978. PAM WAS DIVORCED NINE YEARS LATER AND ON OCTOBER 31, 1982 MARRIED STEPHEN MCCLOUD OF TERRE HAUTE, INDIANA WHERE THEY NOW RESIDE. PAM RECEIVED HER DEGREE IN MANAGEMENT INFORMATION SYSTEMS FROM

INDIANA STATE UNIVERSITY IN 1989. SHE IS EMPLOYED BY INDIANA STATE UNIVERSITY AS DATA SYSTEMS MANAGER OF HOUSING AND FOOD SERVICES FOR THE COLLEGE.

GWENDOLYN LOU (WENDY) GRADUATED COLUMBUS EAST HIGH SCHOOL IN 1975 SHE PLAYED TENNIS AND WAS VARSITY CHEERLEADER THREE YEARS. SHE GRADUATED INDIANA STATE UNIVERSITY 1979 WITH A DEGREE IN EDUCATION. HER DEGREE IS IN LD--TEACHING LEARNING DISABLED CHILDREN. SHE TAUGHT 2ND GRADE AT ST. GABRIELS SCHOOL IN CONNERSVILLE UNTIL SHE MARRIED RANDAL BALDWIN OF PERU,INDIANA ON JUNE 12, 1982. RANDAL IS THE SON OF ROBERT AND HELEN BALDWIN OF PERU,INDIANA. HE IS THE DIRECTOR OF CURRICULUM AT MCCONNAQUA HIGH SCHOOL IN MIAMI COUNTY, PERU,INDIANA. WENDY LATER IN DECEMBER, 1989 RECEIVED HER MASTERS DEGREE IN EDUCATION FROM BALL STATE UNIVERSITY.

WENDY AND RANDY HAVE THREE CHILDREN: THOMAS GREGORY, BORN OCTOBER 19, 1987, MOLLY LOUISE, BORN AUGUST 31, 1989 AND ANDREW CHARLES BORN MAY 28,1991.

RANDALL RAYMOND DWENGER (RANDY) GRADUATED COLUMBUS EAST 1976-- TENTH IN HIS CLASS OF APPROX 400. GRADUATED DEPAUW UNIVERISTY IN 1980 WITH DEGREE IN SCIENCE. GRADUATED FROM INDIANA UNIVERSITY SCHOOL OF MEDICINE IN 1984. DID RESIDENCY IN HARTFORD CONNECTICUT AT INSTITUTE FOR LIVING IN PSYCHIATRY. WORKED IN PSYCHIATRIC HOSPITALS BOTH IN NEW JERSEY AND MANHATTAN. IS NOW AT BAYLEY SETON HOSPITAL, STATEN ISLAND, N.Y. WHERE HE IS IN CHARGE OF ALCHOHOL AND DRUG ABUSE PROGRAM. HE IS NOT MARRIED AT THIS TIME

RICKY MICHAEL (RICK) GRADUATED COLUMBUS EAST HIGH SCHOOL 1979 WHERE HE WAS INVOLVED IN VARSITY FOOTBALL--WRESTLING ETC. HE GRADUATED FROM INDIANA STATE UNIVERSITY WHERE HE WAS AWARDED A FOOTBALL SCHOLARSHIP. HE PLAYED VARSITY FOOTBALL FOUR YEARS AT INDIANA STATE AND GRADUATED WITH A DEGREE IN CRIMINOLOGY. HE IS NOW EMPLOYED WITH INDIANAPOLIS POLICE DEPT UNDERCOVER VICE SQUAD. HE MARRIED MARTHA STEIGMEYER OF FORT WAYNE MARCH 12, 1989. MARTHA GRADUATED BISHOP DWENGER HIGH SCHOOL, FORT WAYNE, INDIANA INDIANA UNIVERSITY WITH DEGREE IN MEDICINE AND IS NOW EMPLOYED AS A RADIOLOGIST IN COLUMBUS WITH COLUMBUS RADIOLOGY, INC. RICK AND MARTHA HAVE TWO SONS; ERICH MICHAEL BORN JANUARY 12, 1990 AND MITCHEL DAVID BORN FEBRUARY 18, 1992. THE FAMILY RESIDES IN SOUTHPORT, IN BECAUSE OF THE PROXIMITY TO BOTH WORK SITUATIONS.

RONALD DWENGER GRADUATED COLUMBUS EAST HIGH SCHOOL 1982, GRADUATED DEPAUW UNIVERSITY 1986 WITH A DEGREE IN MUSIC/BUSINESS. WENT TO WORK AT MIDWEST BANK IN INDIANAPOLIS AFTER GRADUATION AND AFTER ABOUT ONE YEAR DECIDED TO SEEK CAREER IN ENTERTAINMENT FIELD IN MANHATTAN, N. Y. AT THIS TIME HE IS NOT MARRIED AND IS HOPING FOR A BREAK IN THE ENTERTAINMENT FIELD.

RALPH DWENGER CHANGED CAREERS IN 1976 AFTER HORN'S APPLIANCE MART WENT OUT OF BUSINESS. HE BEGAN SELLING AUTOMOBILES FOR MAHAN FORD IN COLUMBUS LATER MOVING TO BEHLER PONTIAC FROM WHERE HE

RETIRED IN FEBRUARY OF 1992. HE IS NOW WORKING PART-TIME AT PRACTICAL AUTO SALES IN COLUMBUS. MARY LOU DWENGER BEGAN WORKING FOR IRWIN UNION BANK IN SEPTEMBER, 1969 AS PAYROLL CLERK. SHE LATER BECAME PAYROLL MANAGER AND IN 1985 CONTROL OPERATIONS OFFICER. SHE RETIRED JUNE 30, 1993 BUT CONTINUES TO WORK FOR IRWIN UNION ON A CONSULTING BASIS.

THE RALPH DWENGER FAMILY HAS RESIDED IN COLUMBUS, INDIANA 42 YEARS AND THEIR RESIDENCE IS 3325 CAROLINA STREET WHERE THEY HAVE RESIDED FOR THE LAST 28 YEARS.

HELEN M. (DWENGER) SULLIVAN

My name is Helen M. (Dwenger) Sullivan born Feb. 9, 1931 in Decatur County. My Father was Raymond W. Dwenger born Jan. 14, 1895 died Nov. 30, 1968, Son of Frank & Ann Dwenger. My Mother was Flora T. (Rolfes) Dwenger born Feb. 25, 1897 died Feb. 10, 1990. Daughter of John & Anna Rolfes.

I went to New Point School, New Point Indiana until the seventh grade, we then moved to Greensburg, I went to St. Mary's for two years. I graduated from Greensburg High School in 1950.

On Jan. 28, 1956 I married Bernard E. Sullivan born March 11, 1930 died April 30, 1985. We had two children Jeffrey D. Sullivan born Dec. 28, 1957 in Decatur County, and Theresa R. Sullivan born Aug. 15, 1959 in Decatur County. They both went to grade school at St. Mary's Greensburg Indiana. High School at Greensburg High School, Jeff Graduated in 1976, and Terri in 1977.

They were always interested in sports. They were on the swim team from age 8 until they got out of school. They were life guards during that time, at the local pool. Jeff Graduated from Butler University, Indianapolis, Indiana. Terri went to Ball State Muncie, Indiana. Jeff married Toni L. Alsbaugh on May 12, 1985. She the daughter of David & Sharon Alsbaugh from Batesville Ind. Terri moved to Florida in 1978 to work at Disney World as a life guard. She has lived in Florida ever since. I moved to Florida in 1986, Jeff & his wife Toni moved down in 1992. We all live and work in Fort Myers, Florida.

DONALD J. DWENGER

Born August 14, 1929 the fourth of eight children born to **Raymond William** and **Flora Theresa (Rolfes) Dwenger**. This was a twin birth sister **Mary Jane**.

Married August 13, 1955 to **Peggy Ann Hanson**. They have five children.
Retired February 1, 1992 after 26 years from Continental Insurance. Still working eight to ten hours a week for same company doing what I did before retiring, auditing of company policyholder's records. No plans for any changes in near future.

CHILDREN

Bartholomew Ray (Bart) born Indianapolis, IN on June 1, 1956.

Married **Kimberly Mayville** on May 20, 1983. They have two children;

Danee' born April 10, 1988

Aaron born October 2, 1992.

Present address: 22075 Oakwood, Woodhaven, MI. 48183

Douglas John born Indianapolis, IN on May 24, 1956.

Married **Colleen Geirlack** on February 14, 1981. They have three children;

Nicholas born May 15, 1983

Daniel born September 25, 1984

Richelle born January 12, 1987

Present address: 11895 Amerst Ct., Plymouth, MI 48170

Jayne Ann born Indianapolis, IN. on June 22, 1958.

Married **William Wohlforth** on August 5, 1984. No children

Present address: 3325 Westwood Dr. , Titusville, FL. 32796

Philip Steven born Indianapolis, IN on June 6, 1962.

Married **Lisa Epps** on April 2, 1993 No children

Present address: 3186 Longwood Blvd. Melbourne, FL. 32935

Michael Joseph born Wyandotte, MI on June 30, 1977.

Lives with parents at 4458 Yellowhammer Dr. Westerville, OH 43081.

MOM'S (DWENGER)

DAD'S (SULLIVAN)

ANNA MARY FRY
JOHN ROLFES

ANNA MARY SIEBEL
FRANK DWENGER

ABBY WRIGHT
RONNIE HEACOCK

MARY PATRICK
WILLIAM SULLIVAN

FLORA ROLFER

RAYMOND W. DWENGER

AUDREY HEACOCK

ARCHIE SULLIVAN

8-14-29

MARY JANE DWENGER

MARRIED
10-21-50

1-26-27

VIRGIL SULLIVAN

MICHAEL E. SULLIVAN 4-13-52

MARY A. HUTCHINSON 2-13-53

MARRIED 6-11-76

GEORGE HUTCHINSON (LEEDS, ENGLAND)
MARY E. O'BRIEN (INDPLS, IN)

live in Brownsburg, IN

MICHAEL P. SULLIVAN 8-12-78
SARAH E. SULLIVAN 6-9-81
JENNIFER M. SULLIVAN 5-6-83

REBECCA J. SULLIVAN 3-31-55

UNMARRIED

LIVES IN AUBURN HILLS, MI

SANDRA M. SULLIVAN 12-24-59

MARK A. CHASTAIN 10-2-57

MARRIED 4-8-78

ORAN E. CHASTAIN INDIANA
MATTIE HODGSON ALABAMA

live in Avon, IN

SHANNON M. CHASTAIN 2-15-80
JASON A. CHASTAIN 5-13-83

DR. WILLIAM MULVANEY AND PAULINE(PAT)(DWENGER)MULVANEY

I am Pauline (Pat) Dwenger Mulvaney the seventh child of Raymond and Flora Rolfes Dwenger. Born July 25, 1933. I had a twinbrother, Paul who died July 28, 1933 We were born in Decatur County, Greensburg, Indiana.

I attended New Point Elementary School

1947 Graduated from St. Mary's School, Greensburg

1951 Graduated from Greensburg High School

1955 Graduated from Holy Cross Central School of Nursing
Notre Dame, Indiana

Worked in operating rooms in numerous cities in this country and Zurich, Switzweland.

1968 Graduated from Charity Hospital School of Anesthesia
New Orleans, LA

1971 Married Dr. William P. Mulvaney, Jr.

My husband was the only child of William P. and Elsie Heil Mulvaney, Sr. He was born March 28, 1921.

He is a Urologist and did the first kidney transplants in Cincinnati (20) and the first cadaver transplants. He developed two drugs for the dissolution of kidney stones. Both approved by the FDA. We have a two acre yard with many species of trees this is our main hobby. My husband is a champion bird hunter and skeet shooter. He practices at Good Samaritan Hospital in Cincinnati.

I have 5 stepchildren and 4 grandchildren.

We reside in Cincinnati, Ohio.

HILMER JOHN AND ELENOR(WALKE) DWENGER

Hilmer John Dwenger was born on March 11, 1893 at Decatur Co. Indiana. He was the son of Frank and Anna(Seibel) Dwenger. He was one of five children: Hilmer, Harry, Stella, Martha, Ellen, Ray.

His family attended the Catholic church at Oldenburg. They were farmers and Hilmer grew up doing the usual farm chores.

Hilmer was married to Elenora Elizabeth Walke on Oct. 27, 1914 at Decatur Co. Indiana. Elenora was born on Jan. 2, 1897 at Decatur Co. Ind. the daughter of John and Laura(Little) Walke, of Hamburg, in Franklin Co.

Hilmer was a farmer near Sandusky. He was a member of the Eagles. They moved around 1925 to Mount Pleasant, where he farmed. Around 1926 they moved to North of Sandusky, where he farmed. Around 1951, he bought a farm near lets corner. It was approx. 90 acres. They lived there for many years, until his age made it hard to farm. He retired and, they then moved into a house on Forsythe Street in Greensburg. Their son Hilmer Jr. took over running the farm at this time.

Hilmer lived at their home in Greensburg at the time of his death from a stroke, on March 2, 1967. He had had a stroke and was in the hospital and was ready to come home when he had another stroke and passed away.

Hilmer and Elenor were members of the St. Mary's Catholic church in Greensburg.

After Hilmer's death, Elenor and their daughter Carol, who still lived at home, moved to South Michigan Ave. near the Cemm. They lived there until Carol married Leo Unsel. Then Elenor moved to Bardstown Ky. to live with her daughter Carol and her husband. Leo was a truck driver.

Elenor was a charter member of the ladies auxillary, the Eagles lodge, and a charter member oof the St. Lawrence Aux. of Decatur Co.

Elenor fell and broke her hip in Nov. of 1984 and was in the Hospital for about a month. She left the hospital to stay at a nearby nursing home, and she died unexpectedly that same day, on Dec. 29, 1984 at age 87, of a bloodclot which hit her heart. She was brought back to Greensburg and buried in the Catholic Cemm. with her husband Hilmer. She was buried on her 88th birthday.

Hilmer and Elenor were the parents of three children: Hilmer Jr, Dorothy, and Carol.

HILMAR J. & Lillie(Blanton) DWENGER

Hilmar J. Dwenger Jr. was the youngest of 3 children to Hilmar J. Dwenger Jr. and Elenora E. (Walke) Dwenger born 6/24/25 died 7/8/68. He married Lillie B. (Blanton) Dwenger March 2, 1947. They divorced but remarried July 13, 1952. They had six children ; Jeromy E. born 3/28/48; Virginia L. born 4/20/49, died 2/48; Judith M. born 11/12/50; John R. born 10/5/53; William J. born 4/25/56; Thomas H. born 9/10/59;

Virginia married Ernest R. Johnston 11/18/66 in Three Rivers Michigan, divorced July 7, 1977. They had two boys Ernest R. Johnston born 12/3/67, he has one daughter Brittany born 11/12/88. Michael J. born 1/5/69, married Julie (Evans) Johnston 11/24/87. they have one son Trey E. born 5/12/93. Virginia married Todd E. Colson 8/15/80 divorced 8/30/84. They had two boys Joshua E. born 10/14/83 and Jerry T. born 8/2/85.

Judith married Michael S. Cronin 8/28/70 divorced 10/17/82. They had two children Christina L. born 2/25/70 and Don M. born 2/23/72. Judith married Delmon E. Json 2/14/84. They had two girls Sheylea born 1/26/85 and Genea born 8/26/86. Judith has three step-children Kathy L. (Tson) Perkins, Cecil E. and Everett E. Json, they also have two granddaughters Stacy, Stephanie Perkins.

John R. married Anna (Thompson) Dwenger and divorced, had one child Ginny Ann born 2/18/73, married Nancy A. (Stevenson) Dwenger and divorced had one child Leza M. born 11/18/77; married Sue J. (Colson) Dwenger and divorced, had two children Brandi S. born 11/13/81 and Christina M. 11/23/82; married Pamela Cordray divorced, married Bonnie Stewart 2/14/84 and divorced.

William married Shannon Owens 7/27/91, divorced in 1993.

Thomas H. married Judy S. (Colson) Dwenger 11/17/79. They have two children Steven L. born 2/19/80 and Juliana B. born 2/8/85. All of hilmar's children now live in Greensburg except William he lives in Indianapolis with his mother.

DOROTHY (DWENGER) JEWELL

Dorothy Laura Ruth (Dwenger) Jewell was born on Nov. 27, 1919 at home on a farm near Sandusky, Indiana, in Clinton Twp. She was the daughter of Hilmer and Nora (Walke) Dwenger. She was one of three children: Dorothy b/1919; Carol b/1923, and Hilmer b/1925. Hilmer Dwenger was the son of Frank and Anna (Seilbel) Dwenger, a farmer in Decatur County.

Dorothy attended the Mt. Pleasant grade school, where she walked a half mile to school and back. When she was in the first grade they moved back to Sandusky. She attended there through the tenth grade. Dorothy and her brother Hilmer raised rabbits as a hobbies. She remembered that one time a stray dog got into the rabbits and killed them all.

Their family attended the St. Mary's Catholic Church, in Greensburg, Indiana, in Decatur County. At the age of 18 she got her first job. It was a live in job helping and caring for an old lady. Over the years she worked at several jobs around the Greensburg area.

In 1951 she met Charles E. Jewell, from Greensburg, In. Charles was born on March 19, 1917, at Kentucky. (He died on Jan. 24, 1985) He was employed at Cummins in Columbus, Indiana. They set up housekeeping in Greensburg, In. in Decatur Co.

Their first child, was stillborn in Sept. of 1952. Their daughter, Joyce Ann Jewell, was born April 5, 1954, in Decatur Co. Indiana. Their son, Michael Wayne Jewell, was born on Oct. 25, 1962 in the Decatur Co. Hospital.

Dorothy and Charles were divorced in July of 1967 in Decatur County Indiana. Dorothy continued to work as she raised her children. Joyce and Michael attended the Greensburg, Schools. Joyce graduated in 1972, and Michael graduated in May of 1981. Dorothy enjoys cards and bingo. She plays bingo at the knights of Columbus, Moose, and the Eagles Lodge. Dorothy retired because of her health in 1973. She now resides at 527 W. Washington in Greensburg. The Children of Dorothy and Charles Jewell:

JOYCE ANN (JEWELL) DWENGER

Joyce Ann Jewell was born on April 5, 1954 at Greensburg, In. in Decatur Co. She was the daughter of Charles and Dorothy (Dwenger) Jewell. She grew up in the town of Greensburg, and attended the Greensburg school system. She graduated from Greensburg school system in May of 1972. She married to Larry Wilder on July 7, 1972, in Braderton, Florida at a preacher's home. Larry and Joyce were the parents of Jason Wayne Wilder, born on Oct. 25, 1973. Joyce and Larry were divorced in 1974 at Greensburg. After the divorce Joyce moved back with her mother, Dorothy, who helped her with the baby. Her son *Jerome Anthony Wilder* was born on April 16, 1979 at Decatur Co. In. Another son, *Jeremy Wilder* was born on June 20, 1980, also in Greensburg. Joyce moved to Revera, Ohio around 1989, where she was employed as a waitress in a restaurant. She presently resides there at this time. Joyce's son Jason is employed at a craft factory in Revera, Ohio.

MICHAEL WAYNE JEWELL

Michael Wayne Jewell was born on Oct. 25, 1962 at Greensburg In. in Decatur, Co. He is the son of Charles b/1917 and Dorothy (Dwenger) Jewell b/1919, of Greensburg. Michael was one of two children. He has a sister Joyce Ann (Jewell) Wilder, born 1954. He graduated from Greensburg High School in May of 1981. Michael Jewell was married on May 19, 1984, to Lori Baker. Lori was born on March 27, 1962 in Batesville, Indiana, in Ripley County.

Lori (Baker) Jewell is the daughter of Charles and Donna Baker. She graduated from school in May of 1980. Michael and Lori were the parents of two children: 1. Michael Wayne Jewell II was born on Nov. 4, 1984, in Batesville, In. in Ripley Co. 2. Matthew Charles Jewell was born on March 1, 1987, in Batesville, In. in Ripley, Co. Michael and Lori currently reside in Batesville, In. Lori works at Hampton's in Batesville. Mike works at Batesville Tool & Die, in Batesville Indiana, in Ripley County.

LEO AND CAROL (DWENGER)UNSEL

Carol Noreen Dwenger was born on Sept. 7, 1932, near Sandusky, in Decatur Co. In. She was the daughter of Hilmer and Nora (Walke) Dwenger. She graduated from Sandcreek High School. She lived at home until the death of her father. She was married to Leo Unsel on Feb. 10, 1968 at St. Mary's Catholic Church in Greensburg. Leo Unsel was born on Feb. 25, 1925 in Kentucky. After they were married they moved to Bardstown, Ky. where they reside today. Carol worked most of her time at the Moor's 5&10 on the square and later at G.C. Murphy's. Leo worked for the "Heavenly Hell" in Kentucky, as a truck driver.

Carol and Leo Unsel were the parents of two children; Alan Maurice Unsel, and Janet. Their son Alan Maurice Unsel was born on June 3, 1969 at Bardstown, Ky. He was married on July 11, 1992 to Michelle Moore of Ky. Michelle was born on June 23, 1968. Michelle work in a box factory, and Alan has a disc Jockey band which plays at Weddings and dances and such.

Their daughter Janet Unsel was born on April 29, 1972, at Bardstown Ky. She attended College and is employed as a cashier at a Lumber Company and Hardware store in Kentucky. Janet is engaged to be married to Charles S. Crogham. Charles Crogham was born in Dec. 1971.

BERNARD H. AND MARTHA(DWENGER)STIER

Martha Dwenger was born on Oct.27,1905 at her parents home in Decatur County Indiana. She was the daughter of Frank Dwenger born Aug.20,1868, and Anna(Seibel)Dwenger born June 13,1872.

Martha was one of six children: Raymond, Hilmer, Harry, Stella(died young), Martha(Stier), Ellen(Ries).

Martha's father, Frank Dwenger was a farmer. Martha attended the Kingston school, in Deatur Co.

When Martha was eleven years old, in December of 1916, her sister Stella had become ill. Stella had appendicitus, Martha was frightened by the seriousness of her sisters illness, and was afraid to go into the room, where she was. In later years as she thought back on when her sister had died, she wished that she had went in and talked to her sister at that time when she was so sick.

When Martha was a teenager, there were a number of free dances at this time, often nearly every weekend. Martha had a large crowd of friends with whom she attended these functions. Her brother Harry was also among her group of friends. Two Hessler sisters were also in their group. Mary and Cecila Hessler. Mary Hessler, a good friend of Martha, eventually married Martha's brother Harry. This is how she also met her furture husband Bernard Stier.

Martha was in her eighth year in school when she came down with scarlet fever. She was unable to complete her courses. She worked in Greensburg for a while as a maid. When about 18 she worked as a maid in Cinn. Ohio.

Martha was married to Bernard Stier on August 18,1926 at St.Marys Catholic in Greensburg. Bernard Stier was born on March 12,1901 Decatur Co. Indiana. He was the son of Edward and Catherine(Rolfes) Stier of Decatur Co. Indiana.

Bernards occupation was a farmer.He and Martha owned a farm North of greensburg in Washington Twp. until the interstate went through their farm in the 1960's they then purchased a farm in Marion twp. South of Grensburg in Decatur County. The farm was 80 acres.

They were members of the St. Mary's Catholic Church in Greensburg. Bernard was a member of the 'Nights of Saint Johns', they were both very active in the local 'Senior Citizens Club'. In their later yeras they moved into a home on State Rd.46 on Main Street in Greensburg.

Bernard Stier passed away on Aug.7,1986 from heart trouble. Martha(Dwenger) Stier passed away on May 14,1988 from Cancer.

Bernard and Martha Stier were the parents of three children:
1.Harold Bernard Stier,born Dec.27,1932 married Jane Linkmeyer.
2.Marjorie Ann Stier, born March 2,1928 married Norbert Hahn.
3.Phyllis Jo Stier, born July 17,1938 married James Layman.

Harold Bernard Stier was born at home on December 27, 1932 near Greensburg, Indiana. He was the son of Bernard and Martha Dwenger Stier. Bernard was born March 12, 1901, at Harris City, Indiana and died in August, 1986. Martha was born on October 27, 1905, in Decatur County and died in May, 1988.

Harold was one of three children, the others being Marjorie Stier Hahn, born March 2, 1928, and Phyllis Stier Layman, born July 17, 1938.

Harold attended Greensburg High School, graduating in 1951. In 1955 he graduated from Hanover College with a B.S. degree in Mathematics and Physical Education. He received his M.S. degree in Education from Butler University in 1960. Since 1977, he has been teaching at the School for Creative and Performing Arts, where he serves as mathematics department chairperson.

He met Mary Jane Linkmeyer while teaching at Aurora, Indiana, where she was one of his students in 1961, and they were married in Cincinnati on July 10, 1965. Jane, as she is called, was born on May 18, 1944, in Cincinnati. Her parents were John and Charlotte Linkmeyer. She graduated from The College Conservatory of Music of the University of Cincinnati with a degree in piano performance. She now teaches piano.

Harold and Jane are the parents of two children, Amy Elizabeth, born September 24, 1968, and Zachary Alexander, born August 14, 1973, both born in Cincinnati. Both children were actors in their early years, taking part in two national tours. Amy toured with Oliver! and The King and I, while Zach played the title role in the tour of Oliver! and understudied the role on Broadway in New York.

Amy graduated from Oberlin College in 1991 and works for the Cincinnati Opera Company. Zachary is attending DePaul University in Chicago, majoring in Philosophy.

Harold and Jane are currently residing in Cincinnati, Ohio.

Marjorie Ann Stier was born March 2, 1928 in Dec. Co., In. She was the daughter of Bernard H. (3-12-01) and Martha Dwenger Stier (10-27-05) both of Dec. Co. She had 2 siblings namely Harold Bernard (12-27-32) and Phyllis Jo Stier Layman(7-17-38). I attended St. Mary's School for 8 years. Graduated from Greensburg High School in 1946.

Marjorie married Norbert Valentine Hahn (4-1-27) on May 29, 1948. He was the son of Lawrence John (4-29-1894) and Josephine (Harpring) Hahn (6-22-01) all of Dec. Co.

To this union 7 children were born.

Theodore Lawrence(8-20-50) in Dec. Co. In. married Susan Mary Redelman (10-6-54) on January 6, 1973. Daughter of Irvin and Mary (Letsinger) Redelman of Tipton Co. Parents of Adam Richard (12-9-73) and Audra Noel (12-5-78)

Daniel Bernard (8-20-51) in Dec.Co. married Susan Marie Miller of Dec. Co (9-1-53) on Sept. 29, 1973. Daughter of Carl and Golda(Williams) Miller of Dec.Co. Parents of Anthony Chad (3-2-77) and Dyan Nicole(12-23-79)

Nicolette Therese(12-28-52) married Eugene Anthony Wuestefeld (4-28-51) of Ripley Co. on June 4, 1977. He was the son of August and Veronica Doll Wuestefeld. Parents of Cynthia Ann(8-25-79), Scott Douglas(12-2-81) Amy Lynn (7-16-90), Ashley Renee(7-16-90)

Gordon Harold(4-29-54) married Jacqueline Susan Dutton(11-13-54) of Livonia, Mich. Daughter of Jack and Evelyn Wilkins Dutton. Parents of Timothy Jackson (2-20-79), Kevin Andrew (7-27-82), Susan Elizabeth(6-7-89)

Mark Ralph(5-5-56) married Kimberly Ann O'Mara (1-28-58) of Dec. Co on November 25, 1978. She was the daughter of Edward and Londa Osborne O'Mara of Dec. Co. Parents of Brock Edward(11-2-79), David Norbert(10-24-81) Toni O'Mara (2-8-85)

Andrew Ernest (6-5-61) married Connie Minyard(9-25-56) of Henry Co.In. on July 25, 1987. She was the daughter of Sherron and Christine King Hancock of Henry Co. Parents of Kyle Matthew Minyard(10-30-80), Nathan Allan(7-16-83), Zachary Andrew(5-11-88) Jordon Edward (9-16-92) all of Henry Co. *Minyard*

Patrick Thomas (12-9-62) married Mona Kay Wittkamper (2-24-62) on June 9, 1984. Daughter of Dale and Sandra (Laws Wittkamper all of Dec. Co. Parents of Thomas Jeffrey(9-21-87), Matthew Louis (10-18-88), Michael Lawrence(10-30-90)

Phyllis Jo Stier was born on July 17, 1938 at Greensburg, Decatur County, Indiana. She was the youngest daughter of Bernard and Martha Dwenger Stier.

Bernard was the son of Edward & Catherine Stier and was born on March 12, 1901.

Martha was the daughter of Frank & Anna Dwenger and was born on October 27, 1905.

They were married August 18, 1926.

Bernard passed away in August, 1986 and Martha in May, 1988.

Phyllis was the youngest of three children.

Marjorie Ann Stier Hahn was born on March 2nd, 1928, and

Harold Bernard Stier was born on December 27, 1932.

Phyllis attended St. Mary's grade school and Greensburg High School but actually graduated from Tech High School in Indianapolis. She went to Real Estate School and carries a Brokers License.

She enjoys bowling, quilting, crocheting, craft projects, gardening and traveling.

Phyllis married Thomas Rader Harroll in February, 1956, which later ended in divorce.

She had a son, Richard Edward who was born on October 3, 1966.

While trying to rent a double in Indianapolis, she met James Otis Layman. He was the son of Otis and Margaret Blair Layman of Bloomington, Ind. James was born September 21, 1924.

Phyllis and James were married January 19, 1974.

James had two daughters.

Cindy Lu born August 11, 1954, and

Susan Elaine born April 5, 1959..

Cindy married Richard Walter Borgers from Norris, Tenn. on October 11, 1975. They have a son Richard Wes Borgers born on August 19, 1979.

Susan married Ron Nickols of Brazil, In. and had a son Ronald born on April 16, 1982.

Later they were divorced and she married William White of Riley, Ind. and had a son, Matthew Levi on February 24, 1986.

Richard Layman married Maria Langner of Carmel, Indiana on May 4, 1991.

Jim Layman was a printer for the Indianapolis Star & News and is retired. Phyllis works at Thomson Consumer Electronics, formerly RCA, in the Accounting department and has been there 32 years.

Phyllis & Jim presently reside in New Palestine, Indiana.

Jim plays the piano with a couple bands and is intersted in model trains.

They both love to travel, the west and the mountains being their favorite, although lighthouses have also been a fascination.

JOSEPH AND ELLEN M. (Dwenger) RIES

Ellen M. Dwenger was born on July 2, 1908 at her parents home in Decatur County Indiana. She was the daughter of Frank and Anna (Seibel) Dwenger.

Ellen was one of six children: Raymond, Hilmer, Harry, Stella (who died young), Martha (Stier), Ellen (Ries).

Ellen's father, Frank Dwenger was a farmer, he owned his own farm in Decatur County.

She attended the school at Kingston, in Decatur County, which went only to the eighth grade.

Ellen was only eight years old when her sister Stella passed away from a busted apendicitus.

She worked for a time as a maid in Cincinnati, Ohio. This was the usual custom for young ladies at that time.

Ellen Dwenger was married on February 1, 1927, to Joseph R. Ries. Joseph R. Ries was born on Nov. 5, 1904 in Cincinnati, Ohio at (Bond Hill). They moved to Cincinnati Ohio.

They lived for many years in St. Bernard Ohio. They ran a coffee shop. It was called "Ries Coffee Shop", on Vine street, it was located near the park and people would come there after ball games

Ellen and Joseph Ries were known all over St. Bernard, located just outside of Cincinnati. They loved to entertain company.

In January of 1967 they realized a lifelong dream and moved to Largo Florida, where their children, grandchildren, and friends often visited.

Ellen stayed active into her retirement years with activities at the community center, and the St. Jerome's Church. She was also a volunteer with the Meals-on-wheels program.

Ellen (Dwenger) Reis passed away on January 28, 1982 at Largo, Florida. Joseph R. Reis passed away on December 17, 1988 at Largo Florida. Both are buried in the "Gate of Heaven" Cemetery in Cincinnati, Ohio.

Ellen and Joseph Ries were the parents of five children:

1. A baby who died in infancy.
2. Joanne Martha Ries was born on August 26, 1928. She married Edward John Haffey on May 9, 1953.
3. James Ries was born on July 7, 1930 Cinn. Ohio. He married Lorraine.
4. Marion Ries was born on Nov. 25, 1931. She married Jack Dauer.
5. Evelyn Ries was born on Aug. 12, 1936. She married Jack Hoffman.

JAMES AND LORAINE(BENVIE) RIES

James Ries was born on July 7, 1930 at Cincinnati, Ohio, in Hamilton County. He was the son of Joseph and Ellen(Dwenger) Ries.

He grew up in St. Bernard Ohio. He graduated from Roger Bacon High School in St. Bernard, Ohio.

He was married to Loraine Benvie, at St. Clement Church in Cincinnati, Ohio, in 1952. They live in the town of Bright. (Bright is a suburb of Cinn.)

James and Loraine are members of the St. Clements Church in St. Bernard.

James is retired from Day Precision Wall Company, in Cinn, Ohio. after many years there. Jim and Loraine took their motor home and traveled the United States for eight months.

James and Loraine were the parents of five children:

1. Jim m/ Dodie Lewis they live in Cincinnati, Ohio.
2. Dawn m/ Pat McWilliams - two children(Patrick, Christy)
3. Lori m/ Tim Bill - four children(Keri, Matthew, Hollie, Timmy)
4. Shawna m/ Jerry Nordman - one child Austin.
5. Robert m/ Julie Loos - (Robert)

Edward J. and Joanne (Ries) Haffey

We are the descendants of Anna and Frank Dwenger. They had a daughter named Ellen Dwenger, she was born July 2, 1908. On February 1, 1927 she married Joseph Ries (born Nov. 5, 1904). They had four children of which the oldest was Joanne Marthe Ries born August 26, 1928. The other children were Jim, Marion, and Evie.

Ellen and Joseph Ries were known all over St. Bernard, Ohio. It is just outside of Cincinnati, Ohio. They owned a store named Ries's Coffee Shop. It was located by the park and people came there after baseball games for candy and their famous iceballs. Ellen and Joe Ries retired in Largo, Florida where they enjoyed entertaining whoever came to visit. Ellen Ries died January 28, 1982. Joseph Ries died December 17, 1988.

Joanne Martha Ries married Edward John Haffey (born April 12, 1929) on May 9th, 1953. They met on a blind date. They had 4 children; Beverly Jo; Diane Marie; Cynthia Ann and Edward John Huffy Jr. The family went camping a lot. They traveled from Cincinnati, Ohio to California once taking in all the sites for a month Ed and Joanne still go camping. They will be married 40 years in 1993. Beverly their oldest, was born September 9, 1954. She married Michael David Gilb (born Aug. 30, 1956) on July 26, 1975. They have 3 children, they are Emily Louise Gilb born Oct. 25, 1977; Michael (Buddy) David Gilb Jr. born Nov. 16, 1980; Laura Ann Gilb born Sep. 1, 1989; Emily play soccer, plays the clarinet in the band, and swims on a team in the summer. Buddy plays soccer, plays drums, and swims on a swim team. Laura is busy being a 3 year old teenager. Bev works for the Wizard Cleaning Agency and Michael works for General Electric.

Diane the next child was born Nov. 14, 1955. She married Donald Anthony Berning (born Oct. 13, 1955) on Aug. 14, 1976. They have 2 children. They are; Janet Rose Berning born Jan. 11, 1979; Donald Frank Berning born Oct. 29, 1980. Janet play soccer, basketball, softball, clarinet and recently took a trip to Chicago. Donald plays football, where the team came in 2nd in the nation in a tournament in Florida. He also plays basketball, hardball, and drums in the band. Don work for General Electric and Diane works for the Treasury Dept. of the United States.

Cynthia Ann, the third child was born July 1, 1960. She married Karl Edward Buchholz (born July 23, 1959) on June 20, 1981. They have 3 children. They are; Stephanie Ellen Buchholz born Jan. 20, 1983; Andrew George Buchholz born Mar. 2, 1984; Cory James Buchholz born Feb. 13, 1985. Stephanie is a cheerleader, plays soccer, and softball. Andrew and Cory both play football and hardball. Cindy works in the billing department for a Doctors office. Karl is a policeman.

Their youngest child is Edward John Haffey born Feb. 22, 1964. He married Kim Jean Russell (born Mar. 18, 1966) on April 6, 1991. Ed works for Furrow Building as head of Security. Kim is a computer programmer for Square D Company. They are kept busy with their first home, and if you ever want to know what is going on in Cincinnati they will know. All family member live in Cincinnati.

JAMES AND LORRAINE(BENVIE) RIES

James Ries was born on July 7,1930 at Cincinnati, Ohio, in Hamilton County. He was the son of Joseph and Ellen(Dwenger) Ries.

He grew up in St. Bernard Ohio. He graduated from Roger Bacon High School in St. Bernard, Ohio.

He was married to Lorraine Benvie, in Cincinnati, Ohio. They live in the town of Bright. (Bright is a suburb of Cinn.)

James and Lorraine are members of the St. Clements Church in St. Bernard.

James is retired from Day Precision Wall Company, in Cinn, Ohio. after many years there.

James and Lorraine were the parents of five children:

- 1.Jim m/ Dodie
- 2.Dawn m/ Pat McWilliams - two children(Patrick, Christy)
- 3.Lori m/ Tim Bill - four children(Keri,Matthew,Hollie,Timmy)
- 4.Shawna m/ Jerry - (Boy)
- 5.Robert m/ Julie - (Robert)

EVELYN MARIE RIES HOFFMAN(EVIE)

MY NAME IS EVELYN MARIE RIES HOFFMAN. I WAS BORN IN ST. BERNARD, OHIO (HAMILTON COUNTY) ON AUGUST 12TH.1936. MY FATHERS NAME WAS JOSEPH R. RIES . HE WAS BORN ON NOVEMBER 5th.1904 IN CINCINNATI, OHIO. MY MOTHER WAS ELLEN M. DWENGER BORN ON JULY 21ST.1908 IN INDIANA. SHE HAD THREE BROTHERS,HILMER,RAY AND HARRY AND ONE SISTER MARTHA. SHE MARRIED MY FATHER AND MOVED TO CINCINNATI, OHIO. MY PARENTS OWENED A RESTURANT IN ST. BERNARD,OHIO. WHEN THEY RETIRED, THEY MOVED TO LARGO FLORIDA. MY MOTHER PASSED AWAY ON JANUARY 28TH. 1982 AND MY FATHER DIED ON DECEMBER 17th.1988.THEY ARE BOTH BURRIED IN GATE OF HEAVEN CEMETRY IN CINCINNATI, OHIO.

I HAVE TWO SISTERS, JOANNE AND MARION, AND ONE BROTHER, JIM. I ATTENDED ST. CLEMENT GRAMMER SCHOOL AND OUR LADY OF ANGLES HIGH SCHOOL. UPON GRADUATION I WORKED IN A BANK AS A BOOKKEEPER. ON NOVEMBER 25TH.1954 I MET MY FUTURE HUSBAND JOHN F.(JACK) HOFFMAN AT A WEDDING RECEPTION. WE DATED FOR TWO YEARS AND WERE MARRIED ON SEPTEMBER 15TH.1956 IN ST. CLEMENT CHURCH. HE WAS A SON OF FRANK AND ESTHER HOFFMAN OF DEER PARK, OHIO. HE HAD ONE YOUNGER BROTHER, FRANCIS HOFFMAN. HE WORKED FOR THE PROFESSIONAL PUTTERS ASSOCIATION IN CINCINNATI,OHIO.

ON JUNE 19TH.1958 OUR FIRST SON,STEVEN MICHAEL HOFFMAN, WAS BORN IN GOOD SAMARITAN HOSPITAL,CINCINNATI, OHIO. TWO YEARS LATER WE HAD A DAUGHTER BORN ON DECEMBER 2,1960.SHE WAS GIVEN THE NAME SHARON MARIE HOFFMAN, ALSO BORN IN CINCINNATI.

WE WERE TRANSFERRED TO FAYETTEVILLE,N.C.IN OCTOBER OF 1961.

A YEAR LATER OUR THIRD CHILD WAS BORN ON JULY 25TH.1962 IN CAPE FEAR VALLEY HOSPITAL, FAYETTEVILLE,N.C. WE NAMED THIS CHILD JILL ANN HOFFMAN. IN MARCH OF 1963 WE MOVED TO ASHEVILLE, N.C. TO OPEN UP A PUTT PUTT GOLF COURSE. ON NOVEMBER 19TH 1963 OUR FOURTH CHILD A SON WAS BORN AT MEMORIAL MISSION HOSPITAL, ASHEVILLE,N.C. WITH THE NAME OF JEFFREY THOMAS HOFFMAN.

WE LOVED THE AREA WITH THE BEAUTIFUL MOUNTAINS SURROUNDING US, WE DECIDED TO MAKE THIS OUR HOME. WE WERE VERY ACTIVE IN OUR COMMUNITY, JACK COACHED FOOTBALL, LITTLE LEAGUE BASEBALL, AND LOVED TO PLAY GOLF. WE WERE INVOLVED IN OUR CHURCH, ST. JOAN OF ARC, AND ALSO THE SCHOOL. JACK WAS A SCOUT LEADER, AND I WAS A DEN MOTHER. HE COACHED BASKETBALL AT ST. JOAN OF ARC AND ALSO SERVED AS BOOSTER CLUB CHAIRMAN. WE BOTH SERVED ON PARISH COUNCIL, AND OTHER CHURCH ACTIVITIES.

HE WORKED FOR THE ASHEVILLE CITIZEN TIMES NEWSPAPER AS A ROUTE SUPERVISOR AND ALSO HAD A PAPER ROUTE. I WENT TO WORK AT SKY CITY DEPARTMENT STORE IN 1964 AND WAS BOOKKEEPER THERE UNTIL THEIR CLOSING IN 1991. WE USUALLY SPENT OUR VACATIONS IN FLORIDA, VISITING MY PARENTS AND JACK WOULD GO TO TARPON SPRINGS, AND PLAY IN A GOLF TOURNAMENT EVERY YEAR. IN JULY OF 1986 JACK BECAME ILL AND WAS DIAGNOSED WITH IDIOPATHIC CONGESTED CARDIOMYOPITHY, WHICH MEANT HE NEEDED A HEART TRANSPLANT, BUT WAS NOT A CANDIDATE FOR ONE, DUE TO OTHER MEDICAL PROBLEMS. HE PASSED AWAY ON FEBRUARY 11TH.1991 AT THE AGE OF 58.

I AM PRESENTLY WORKING AS A DATA TRANSCRIBER, FOR THE U.S.A.F.

WITH THE WHEATHER BUREAU. I AM STILL ACTIVE IN SEVERAL CHURCH GROUPS, AND ALSO BELONG TO A CLUB WITH 10 WOMEN. WE MEET ONCE A MONTH AND GO CAMPING, OR TO THE BEACH, OUT TO EAT, OR JUST SIT AROUND AND TALK AND ENJOY EACH OTHERS COMPANY. WE ARE REALLY CLUB SISTERS AND ALWAYS THERE FOR EACH OTHER.

OUR ELDEST SON STEVEN, GRADUATED FROM WESTERN CAROLINA UNIVERSITY. HE MARRIED KIMBERLY DIANE RHINEHART ON SEPTEMBER 10, 1985. SHE ATTENDED ENKA HIGH SCHOOL, AND WAS FROM CANDLER, N.C. HER PARENTS ARE DANNY AND BRENDA RHINEHART. SHE HAS ONE SISTER KAY. STEVE WAS AN ASSISTANT BASKETBALL COACH AT MARS HILL COLLEGE, HE ACCEPTED A JOB AT URBANA COLLEGE, URBANA, OHIO IN 1986. HE WAS NOT SATISFIED AT THIS, SO HE MOVED TO CINCINNATI IN 1987. HE WENT TO WORK FOR NASCO INC. AS A SALES REP. KIM WAS A MANAGER AT BRENDA MOURS SPORTING GOODS STORE IN CINCINNATI. THEY BOUGHT A HOUSE IN BATAVIA, OHIO. KIM IS NOW A HOMEMAKER, SINCE THE BIRTH OF THEIR DAUGHTER DAKOTA JILLIAN HOFFMAN BORN MARCH 10, 1992 IN GOOD SAMARITAN HOSPITAL. STEVE HAS JUST RECENTLY BEEN EMPLOYEED WITH READERS DIGEST.

THE FIRST OF OUR CHILDREN TO MARRY WAS SHARON, TO JEFFERY LANE CRAWFORD. HE WAS A GRADUATE OF PISGAH HIGH SCHOOL. HIS PARENTS ARE JERRY AND JEAN CRAWFORD. HIS MOTHER JEAN DIED OF HODGKINS DISEASE IN 1986. HE HAS ONE BROTHER DERRICK AND TWO SISTERS, JANNELL AND JEWELL. A CHILD WAS BORN OF THIS MARRIAGE ON APRIL 15TH. 1979. THEY NAMED HIM JOSHUA SCOTT CRAWFORD. HE ATTENDS ENKA HIGH SCHOOL. SHARON, JEFF AND JOSH RESIDE IN ASHEVILLE, N.C. SHE IS A HEAD TELLER AT FIRST CITIZENS BANK AND JEFF WORKS IN A TEXTILE MILL.

OUR SECOND DAUGHTER JILL, MARRIED CARL WAYNE STORIE. HE ATTENDED ENKA HIGH SCHOOL. HIS PARENTS ARE CARL AND BRENDA STORIE. HIS MOTHER PASSED AWAY WITH CANCER IN 1991. HE HAS ONE SISTER BECKY. THERE WERE TWO CHILDREN FROM THIS MARRIAGE. CARL WAYNE STORIE JR. (C.J.) BORN OCTOBER 19TH. 1979 AND MATTHEW GREG STORIE BORN APRIL 15TH. 1985. C.J. ATTENDS ENKA MIDDLE SCHOOL AND MATTHEW GOES TO PISGAH ELEMENTARY. WAYNE WORKS AT GERBER BABY FOODS PRODUCTS, AND JILL WAS EMPLOYEED AT SAND HILL PRIMARY SCHOOL. SHE BECAME ILL ON MONDAY JANUARY 28TH. AND ENTERED MEMORIAL MISSION HOSPITAL WITH SIGNS OF HEPATIC DYSFUNCTION. SHE DIED SUDDENLY ON WEDNESDAY JANUARY 30TH, 1991, AT THE AGE OF 28, FROM A VIRUS ASSOCIATED HEMOPHAGOCYTIC SYNDROME. SINCE HER DEATH, HER HUSBAND MARRIED SUSAN CLUBB. THEY HAD A SON JASON BORN SEPTEMBER 10, 1992.

OUR YOUNGEST SON JEFF ATTENDED THE UNIVERSITY OF N.C. AT ASHEVILLE FOR A SHORT TIME. ON AUGUST 6TH. 1983 HE MARRIED JO ANNE GORMAN. HER PARENTS WERE JOHN AND CAROLYN GORMAN. SHE HAD ONE SISTER DEBRA. THEY DIVORCED IN 1988, AT THIS TIME JEFF WAS EMPLOYEED AS A GROCERY AND FROZEN FOODS MANAGER AT A GROCERY CHAIN STORE. IN 1991 HE WENT TO WORK FOR NASCO INC. AS A SALES REP. HE MET AND MARRIED JEAN ELIZABETH HAWKINS (BETH) ON JUNE 12TH. 1992. HER PARENTS ARE TED AND JEAN HAWKINS. SHE HAS ONE SISTER LISA. BETH WAS BORN AND RAISED IN ALEXANDER, N.C. SHE IS A GRADUATE OF WESTERN CAROLINA UNIVERSITY. SHE TEACHES SPECIAL EDUCATION AT ENKA MIDDLE SCHOOL. JEFF RECENTLY BEGAN WORKING AT READERS DIGEST. JEFF AND BETH RESIDE IN ASHEVILLE. JEFF IS AN AVID GOLFER AND ALSO A CERTIFIED REFEREE.

Ellen Dwenger was the daughter of Frank Dwenger and Anna Seibel, and was born in Greensburg, Indiana on July 21, 1908. She married Joseph Ries in February, 1927. Joseph was born in Cincinnati, Ohio (Bond Hill) on November 5, 1904. They had four children. They lived for many years in St. Bernard, Ohio and ran the Ries Coffee Shop on Vine Street. In January, 1967 they realized a lifelong dream and moved to Largo, Florida, where their children, grandchildren and countless other friends and family often visited. Ellen stayed active in her retirement years with activities at the Orange Lake Village Community Center and St. Jerome Church, and was a volunteer with Meals-On-Wheels. Ellen died on Thursday January 28, 1982 in Largo, Florida. Joseph died on December 17, 1988, in Largo, Florida.

Marion Ries Dauer is the daughter of Ellen and Joseph Ries. She was born on November 25, 1931 at Good Samaritan Hospital in Cincinnati, Ohio. She is one of four children (Joanne Ries Haffey, born August 26, 1928, Cincinnati Ohio; James Ries born July 7, 1930, Cincinnati, Ohio; Evelyn Hoffman, born at home, August 12, 1936, Cincinnati, Ohio). Marion attended eight years of grade school at St. Clements in St. Bernard, Ohio, graduated in June, 1945. She attended four years of high school at Our Lady of the Angels in St. Bernard, Ohio and graduated in June, 1949. She met Jack Dauer on December 1, 1954 on a blind date. She worked with Jack's sister, who introduced them, and they were married on June 9, 1956. They now reside at 2313 MacArthur Lane Newport, Kentucky where they have lived for 36 years. Marion's hobbies include playing bridge, bowling, walking for exercise, travel, and singing in the choir at St. Therese Church, Southgate, Ky. Personal Note from Marion: I have been babysitting for my five grandchildren from time to time. I have been in a mixed couples bowling league for 27 years. I have been blessed with being able to go to Rome to see the Pope and to Medjugorie to see the Blessed Mother. I also belong to two bridge clubs which I enjoy because I have made some wonderful friends in the last 15 years. We like to go camping, and I traveled to Florida at least once a year when my parents lived there. We love our grandchildren and they are a joy to us and we are blessed to have our good health and our faith is strong, as passed down from our parents. We look forward to Jack retiring the end of 1993 to play a little golf, putter around the yard and travel whenever the mood strikes us.

Jack Dauer was born in Erlanger, Kentucky on September 10, 1930. He is the son of Norma Geiger Dauer and Robert Dauer. Norma was born in May, 1899, Erlanger, Ky. and died on June 29, 1960. Robert was born on August 24, 1900 in Erlanger, Ky. and died on October 10, 1976 in Ft. Mitchell, Ky. Jack was one of three children. Robert, born January 1, 1924 in Erlanger. Mary Jo Dauer Moffitt born August 2, 1934 in Erlanger. Jack enjoys golf, bowling and other sports. He is a systems analyst for Gibson Greeting Card. Co.

Marion and Jack Dauer have three daughters, Kathleen Donnermeyer, Sandra Albrinck, and Julie Ammerman.

Kathleen Jo Dauer Donnermeyer is the oldest daughter of Jack and Marion Dauer. She was born in Covington, Kentucky on February 16, 1957. She attended St. Therese Grade School, and Notre Dame Academy, and received a B.A. from Northern Kentucky University in 1979. She married Harry Donnermeyer on April 26, 1980. They live in Ft. Thomas, Ky. Kathy works as an editor for a legal publishing company. She also does a lot of sewing for their three children, Molly Elizabeth Donnermeyer, born March 27, 1985, in Ft. Thomas, Ky., Joshua Harrison Donnermeyer, born July 27, 1989 in Edgewood, Ky, and Melissa Rose Donnermeyer, born November 3, 1992, in Edgewood, Ky.

Sandra Lee Dauer Albrinck was born May 3, 1960 in Covington, Kentucky. She attended St. Therese Grade School, Notre Dame Academy, and received a degree from Northern Kentucky University in 1982. She works for L'EGGS. Sandy married Jack Albrinck on May 21, 1988. They live in Reading, Ohio and have a son, Steven Louis Albrinck, born July 11, 1990, in Cincinnati, Ohio.

Julie Dauer Ammerman was born June 27, 1963 in Covington, Kentucky. She attended St. Therese Grade School and Notre Dame Academy. Julie works for DHL. She married Ryan Ammerman in 1990 and they have a son Brandon Michael Ammerman, born November 23, 1990.

HARRY (JOHN HENRY) AND MARY (HESSLER) DWENGER

John Henry Dwenger was born on Feb. 19, 1898 at Hamburg Indiana, in Franklin Co. While Christened, John Henry, he went his whole life by the name of Harry J. Dwenger, and many only know him by that name.

He was born the son of Frank J. (Stands for?) Dwenger, who was born on Aug. 20, 1868 at Hamburg In. and Anna Seibel, who was born on June 13, 1872, also born at Hamburg In. They were devout Catholic's and they attended the St. Maurice Catholic church at St. Maurice, in Decatur Co. Harry was one of six children: Hilmer, Raymond, HARRY J., Stella, Martha, Ellen.

He grew up on a farm near Kingston, in Decatur Co. Harry attended a local one room school house (name?) near Hamburg as a child. He helped his father on the farm when weather was good and when it was bad he attended school. He completed the seventh grade, after which he quit school to get a job.

As a child they would play games such as 'Fox and Geese', run races, and have snowball fights, and also made angels in the snow.

He ran around with an active group of young people, not unprone to youthful exuberance.

They enjoyed rewriting songs with a comical twist to them, such as "My Bonnie lies over the Ocean", came out-- "My Bonnie leaned over the gas tank, the height of it's contents to see; I lighted a match to assist her, Oh, bring back my Bonnie to me"

One Holloween, Harry and some friends took the old neighbor mans buggy and put it on top of the man's barn. The next morning the old man was standing out there looking at it in amazement. Harry's father Frank, who had heard the boys coming in from it the night before, told the boys, "I'll bet you had a lot of fun putting it up there?" They grinned about their joke until he said, "I'll bet your going to have just as much fun when you take it back down, and you had better be careful not to break a wheel!" Harry said that they learned their lesson there. "It was really hard getting it back down without breaking anything."

Harry and his brothers had a large group of friends. One form of entertainment was going to the free dances, which were held on the weekends. Harry's sister Martha was also in this group of friends. One of Martha's girlfriends, was a girl named Mary Hessler. She drew Harry's attention above the other girls that he knew. He began asking her out for dates. He told her on one occation, "You know I'M going to marry you one day!

This seemed to Mary quite brash, and she responded, "Oh, you are, are you."

Harry would pick Mary up for dates with the horse and buggy. At the end of the date after he had dropped Mary off at her parents home, he would tie up the horses reigns, give it it's head? and it would head home on it's own and walk right into the barn, while he could lie down in the back and sleep.

On one occation when he had done this, and it was after a strong rain. It was late at night and pitch dark. Suddenly the horse stopped, would not go any farther, no matter how much he urged it. He got down from the wagon and walked around in front to see what was wrong. They had come to a bridge, or what had been a bridge, and it had been washed away in the swift running water. The horse had saved his life by sensing the danger in the dark night.

Harry J. Dwenger and Mary Cecilia Hessler were married at the St. Mary's? Catholic church at Millhousen, on Aug. 29, 1923.

They first set up housekeeping in a house on his father's farm. Harry helped his father out with his farming. They lived in a small house just across the road from Harry's parents.

Their first child, Mary Kathleen, was born on June 5, 1924. It was a very hot summer, and a very hot June, so Mary would set little Kathy, in her bassinet, on the

front porch while she did her house work, so the baby would be cooler.

Harry's mother saw Mary leaving the baby, apparently unattended on the porch. One day she decided that she would teach Mary a lesson. She would slip onto the porch and take the baby home. This, she thought, would show Mary that she wasn't watching Kathy close enough.

Mary as she worked was listening closely for the baby, in case she cried. She heard a creak of someone stepping onto the porch, and she went immediately to see who it was. She caught Anna as she was stepping off the porch with the child. Anna conceded after this that "I guess you are watching her good after all."

(I could use some information to fill in between children)

Harry and Mary's second child, Esther Ann, was born on Sept. 30, 1925, and followed by Roselia Cecilia on Feb. 21, 1927. A little over a year later, another daughter Ruth Elenora was born on May 27, 1928. (When did they move from his father's farm?)

On Sept. 22, 1929, Harry's mother, Anna(Seibel) Dwenger, passed away. They had a new baby, born on Dec. 14, 1929. She was named Anna Maria Dwenger, after her grandmother. This was also the year of the fall of the stock market and the arrival of the great depression.

On Oct. 1, 1931, their first son, Richard Francis(Dick) was born. Little Anna was in her babybed sleeping when he was born, and after was born he lay crying, Anna stood up in her bed and said, "No wonder he cries!" surprising everyone. Mary wondered that such a little child could even know he was a boy. She must have heard someone in the room say it, and was repeating it.

Their daughter, Martha Elizabeth(Betty), was born on June 27, 1935. Around this time they purchased a home in the country near St. Dennis church. The children attended a one room school house called ' Lehman school'. It was a one mile walk each day to school for the children. Harry was a school bus driver, but he used his car to pick up the children who lived too far away to walk. He could not fit a lot of kids into the car. On very cold days the youngest kids got to ride to school. The boys would sometimes get there early to fire up the stove in the school.

Another son Leonard Joseph, was born on Jan. 15, 1935. When Leonard was six months old, they purchased their farm in Decatur County In. The youngest daughter Mary Ellen Dwenger was born on June 29, 1937.

Around 1941(42?), Mary was ill and was in the hospital to have surgery. Harry had went to the hospital to visit her.

Harry chewed tobacco, and he always carried the packet of tobacco in his back pocket. He left the packet at home on the dresser when he went to visit Mary. While he was gone, Annie and Dick took the open packet of tobacco from mom and dads bedroom. Each took a little piece in their mouth to taste it. It tasted really bad to them, so they took it down and threw it into the slop bucket. About that time their dad came home from the hospital. It was lent, and he had everyone kneel down and pray the rosary for mom. All through the rosary Anna and Dick had the hiccups. After they had finished, Harry asked them, "Whats the matter with you kids, you both have the hiccups?" They both said, "I don't know." He then asked, have you been chewing my tobacco?" They told the truth, and said, they had tried just a little bit of it. He simply told them, "Don't ever do it again!"

He then told them that his sister Stella, had had the hiccups all day before she died.

The family had cattle and livestock, and each of the children had their chores to do each day. Some helped outside feeding and milking cows, and feeding chickens and sheep, and some helped their mother in the house with the cleaning and cooking. They never bought bread, they made it themselves 3 or 4 times a week.

On Saturday nights Harry and Mary would sometimes have baseball games at their house. The neighbor boys would come around to play. Mary would Make homemade

doughnuts, and homemade rootbeer for refreshments.

Harry would take the children to the free dances and he would dance with each of the girls to get them started out dancing on the floor. He taught them each to dance.

Harry and Mary were devout Catholics. They attended St. Dennis Catholic church. Once when Anna was a young child, after they had all kneeled to pray the rosery, after they had finished, Anna asked her mother, "Don't you think that we pray too much". "Oh No," Mary answered, "You can never pray too much."

Around the year 1936 Harry got a job working on roads for the county. He worked on a road gang that halped to build State road 46. He worked for the county on roads until he retired in 196-?

Mary's mother Mary(Rutt) Hessler because of her age, broke up housekeeping around 1942, and lived alternately with each of her daughters until around 1960?, when she stayed permantly with Harry and Mary.

A son, Edward Joseph Dwenger, was born on Sept. 2, 1947.

On Feb. 10, 1961, Mary and her mother, and their youngest son Edward Joseph were at home when they say the lights upstairs flickering off and on. When Eddie went upstairs to investigate he found that a short in the electrical wiring had caused a fire. They were able to get out but were unable to save very many of their possesstions from the area where the fire had burnt.

They then purchased a home outside of Millhousen. A large two story home, with 2 acres of land.

Mary's mother, Mary(Rutt) Hessler passed away shortly after going into the Oddfellows nurseing home on Aug. 3, 1962.

Harry Dwenger was a member of the millhousen nights of St. John's. They attended the Millhousen Catholic church.

Harry Dwenger died unexpectedly in his sleep of a heart attack on Jan. 6, 1966. He is buried at the Millhousen Catholic Cemmetary.

In 1970? Mary Dwenger sold her home near Millhousen and moved in with a friend Ruby Woods. She lived with her for several years before moving in with her daughter Anna MCCullogh in Millhousen in 1975.

She lived there until an illness forced the necessity of moving into a nuring home in 1985? Where she resides at this time. Her memory has been failing for several years now.

Harry and Mary Dwenger were the parents of ten children:

1. Mary Katherine b/1924 married, Paul Schiedler-- six child: Rose Marie, Jerome Paul, Janet, Tim(Billy), Mary Ann, Paul.
2. Esther Ann b/1925 married William Martin-- five child: Michael, Billie Joe, Jackie, Debra, Steven.
3. Rosella Cecilia b/1927 married, Harold Powers-- twelve Child: Mary Rose, Kay, Susan, Harold, Donald, Rita, Raymond, Artie, Angela, Dorothy, Andrew, Jacob.
4. Ruth Elenora b/1928 married, Charles Hamilton-- twelve child: Marilyn, Ann, Charles, James, Linda, Barbra, Helen, Philip, Carol, Joyce, Dale, Joseph.
5. Anna Marie b/1929 married, John David MCCullough-- eleven ch: Donna, Patty, Margaret , Beverly, Davvid John, Sharon, Carolyn, Harry, Ruth, William , Glen.
6. Richard Francis(Dick) b/1931 married, Joan(Sis) Lawrence--- four child: Diane, James, Charles, Lawrence.
7. Martha Elizabeth(Betty) b/1933 married, Frank Ed Harris--- seven child: Nita, Eddie, Ricky, Larry, Kenny, Cindy, Gregory.
8. Leonard Joseph b/1935 married, Janet(Gussy) Burgmeier-- two child: Terrica, Todd.
9. Mary Ellen b/1937 married, Carl Veercamp-- five child: Carl, Shirley, Karen, Robert, Ronald.
10. Edward Joseph b/1947 married, Brenda McIntyre-- five child: Brian, Tracy, Christopher, Joseph, Jason.

Mary(Hessler) Dwenger passed away on Oct.22,1993 at Greensburg in Decatur County, Indiana. She is buried beside Harry in the Millhousen catholic Cemm. 90

children of Harry and Mary Dwenger:

1.b/1924	2.b/1925	3.b/1927	4.b/1928	5.b/1929	6.b/1931	7.b/1933	8.b/1935	9.b/1937	10.b/1947
Kathleen m/ Paul Scheidler Child: 1. Timothy m/ Jane Wonnol Andrew Brian Christopher 2. Mary Ann m/ William Turner William M. 3. Paul m/ Shari Hermish Bradly Paul 4. Jerome m/ Roxann Scheidler Matthew Katie Jonathan Christa 5. Rose Marie m/ William Peters Laura Rachel 6. Mary Janet m/ #1 James Kipper m/ #2 Randy Taylor Jennifer Jo	Esther m/ William Martin child: 1. Michael m/ Betty Hermish (Div.) Daniel Scott Michell Bernice 2. Bill m/ Debbie Coomes William Heather Benjamin 3. Jackie b/1952 d/1959 died young 4. Debra m/ Clifford Peetz Michael Antony Alisha Maggie 5. Steve m/ not married	Rosie m/ Harold Powers child: 1. Mary Rose m/ John Brogan Daniel David Shirley Jennifer 2. Kay m/ Bill Yorn William Nicholas Laura Thomas 3. Susan m/ Casper Wilmer Karon Casper Joyce 4. Tony m/ #1 Narita Ruble m/ #2 Connie Wagner Steve Angela Tonya Sue 5. Donald m/ Joann Dyer Donald Kelly 6. Ray m/ Ritha Boeder m/ #2 Virgi. Andy Adkins Aaron Linsay 7. Rita m/ David Harold Katrina Pamela 8. Arthur m/ Chris Salee Jamie Leo Tanya Stacy Shannon 9. Angela m/ David Miller Amanda Charity David Brandi 10. Dorothy m/ Rick Perkins Robert 11. Andrew m/ Dawn Miller 12. Jacob m/ Pam Collins Jacob	Ruth m/ Charles Hamilton child: 1. Marilyn m/ John Peetz Amanda Julie 2. Ann m/ Marvin Steir Angela Mark Patrick Kevin Paul 3. Charlen m/ #1 Cindy Roasnor Elizabeth Craig 2. Diane Jeff Jenny Jason Jordan 4. James m/ Sue Heater Rena Natalie Samuel Brittany Derflinger 4. Beverly m/ #1 Tony Powers m/ 2 Bill Maggard Jeremy Jeffery Jenny Julie Justin 5. David J. m/ Penny Biddle (Div) John David Kevin 6. Sharon m/ Stephanie 7. Carolyn m/ Steve Richards Jacob Sarah Vicky 8. S. Harry m/ #1 Pam Cordray m/ #2 Mary Ferry-Frazier Coleen Cindy Mark Joe 9. Ruth m/ George Griffith Amanda Ben Carl Alex 10. William m/ Debbie Smith Sean Wm. 11. Glen not married	Annie m/ John McCullough (Sis) child: Lawrence child: 1. Donna m/ #1 Gary Abell m/ #2 Terri Swinford Jesse Matt Aaron Adam baby-94 2. Patty m/ Mark Carson Jodi Christina Elizabeth Craig Rebecca 3. Margaret Combs m/ Ronnie 4. James Derflinger (Div) d/1958 Chris Michelle Brandi (Grandau, Brittany Derflinger 4. Beverly m/ #1 Tony Powers m/ 2 Bill Maggard Jeremy Jeffery Jenny Julie Justin 5. David J. m/ Penny Biddle (Div) John David Kevin 6. Sharon m/ Stephanie 7. Carolyn m/ Steve Richards Jacob Sarah Vicky 8. S. Harry m/ #1 Pam Cordray m/ #2 Mary Ferry-Frazier Coleen Cindy Mark Joe 9. Ruth m/ George Griffith Amanda Ben Carl Alex 10. William m/ Debbie Smith Sean Wm. 11. Glen not married	Dick m/ Joan (Sis) Harris Burgneier child: 1. Terica m/ Will Moorman Jacob 2. Todd m/ not marr. Ben zachery 3. Karen m/ Roger Koors Robert Jennifer Craig Kristen 4. Robert m/ Michelle Diekhoff 5. Ronald m/ Angeline Tucher Tyler Kyle	Betty m/ Ed Harris Burgneier child: 1. Juanita nurse 2. Frank m/ Elaine Walker (Div) Shawn Chad 3. Richard m/ Melanie Richie Katina Kari 4. Larry m/ #1 Jerri Coker m/ #2 Lise Bannister Jamie Theresa William 5. Kenneth m/ Barb Elevins Michael Dan 6. Cindy m/ #1 Ben Kuntz m/ #2 Ivan Waltermire Amanda Deanna Thomas 7. Gregory m/ Peggy Stark Chastlty Matthew	Leonard m/ Janet Burgneier child: 1. Terica m/ Will Moorman Jacob 2. Todd m/ not marr. Ben zachery 3. Karen m/ Roger Koors Robert Jennifer Craig Kristen 4. Robert m/ Michelle Diekhoff 5. Ronald m/ Angeline Tucher Tyler Kyle	Mary Ellen m/ Carl VeerKamp child: 1. Carl m/ not marr. 2. Shirley m/ Jay Becker Ben zachery 3. Karen m/ Roger Koors Robert Jennifer Craig Kristen 4. Robert m/ Michelle Diekhoff 5. Ronald m/ Angeline Tucher Tyler Kyle	Ed, Joseph m/ #1 Janet Greive m/ #2 Brenda McIntyre child: 1. Traci m/ Martin Hittle Trenda Nathaniel 2. Ed, Joe m/ Melissa Moorman Andrew 3. Jason m/ Nikki Mayer 4. Brian m/ Debbie Richison Kyle Julie 5. Chris m/ Janet Templeton Brook Skylar

Ancestors of:
 John H. (Harry) Dwenger
 and
 Mary Ceceilia Hessler

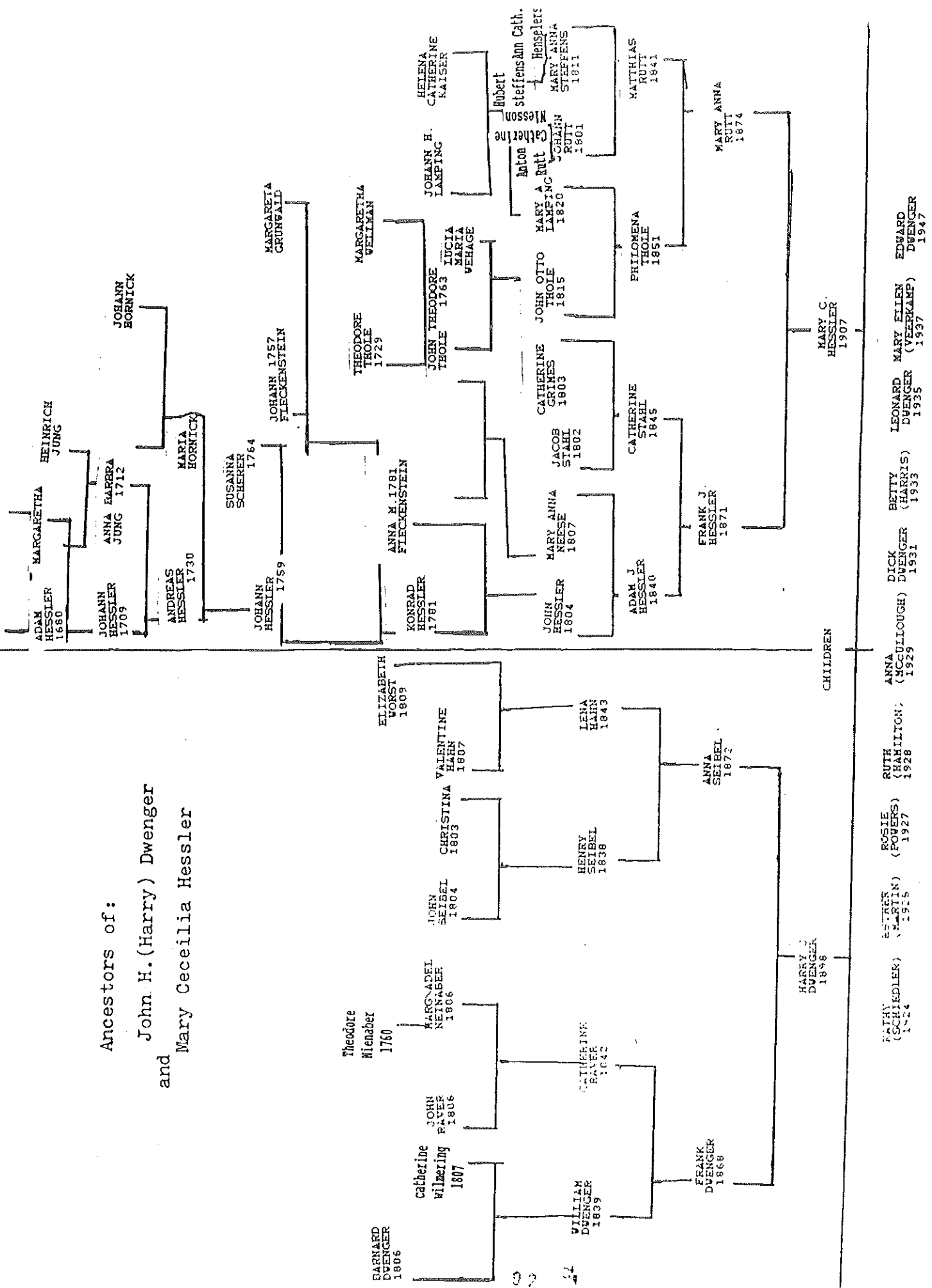

CHILDREN

- BATHY (SCHIEDLER) 1824
- ESTHER (MARRIN) 1855
- ROSIE (POWERS) 1927
- RUTH (HAMILTON) 1928
- ANNA (SCULLOUGH) 1929
- DICK DWENGER 1931
- BETTY (HARRIS) 1933
- LEONARD DWENGER (VEERKAMP) 1935
- MARY ELLEN DWENGER 1937
- EDWARD DWENGER 1947

MEMORIES OF MY DAD, HENRY J. DWENGER

*** Daddy hated lies. Anyone who ever lied to him (what he called a "Bold-faced Lie") he never again trusted. He always said "Anyone who lies will steal". Once I told the teacher a lie at school and was punished. That night when my folks found out I was punished again (a rule in our family). With five kids in 1 family in a one-room schoolhouse there were no secrets. I found out later that my sister Rosie walked around the house looking for something or anything I would want to steal. She thought that I had to steal, since I lied! **** Daddy played the harmonica well and we all enjoyed it. When Daddy was working on something and humming to himself, we didn't try to bother him since we knew he was thinking something out or planning something special. **** Daddy's saying: "Good morning. Nice Morning this morning. If tomorrow morning is a morning like this morning it'll be a nice morning tomorrow morning". **** Daddy liked us kids to scratch his head and sometimes would fall asleep while we were scratching. Once when Daddy was sleeping we put rag curlers in his hair and then we went out to play. Someone came to see him and he woke up and went out to talk to him with rags tied to his hair. We were scared he would be mad but after awhile he laughed about it. Mom laughed too but we were told never to do it again! **** Daddy played on the St. Dennis Men's ball team and was a good player. Since he drove the school bus, the kids all knew him. Some Sundays he played ball with the neighborhood boys and girls who met in our field. I don't recall any other Dads coming. Everyone called him Harry, but we were proud to call him Dad. He was always fair and liked the kids. He didn't like arguing or poor sportsmanship, but was careful of everyone's feelings. The fun was more important than the winning, but he did like to win though! **** When Daddy plowed, he used a one-row plow pulled by a team of mules or horses. It was hard work, stopping at the end of each row to pull the plow back and set it for another row. We would take turns going to the field with cold water and maybe a snack. He didn't seem to mind walking all day but what he did mind was plowing up a nest of snakes. He wasn't afraid of much but he was afraid of snakes. He said that a mother snake would follow a person for "a mile". Once we girls went berrypicking and I wore Dick's new straw hat. We saw a big black snake which I killed, picked up, and put in the hat. We went on home and I ran out to where Daddy was working on the straw stack. Reaching over the fence, I yelled "Look what I've got!". Daddy came over, saw the snake, grabbed the hat, and beat hat & snake to a pulp. He said that the snake had its tongue out. After that we knew he didn't like snakes. Dick was mad about his hat and remembered for a long time that his new hat was ruined because of me and the snake. I did kill other snakes (mostly black snakes) that we found in the henhouse or other places but I never showed them to Daddy again. **** Daddy was a hard worker. He worked on the State Road Crew and helped with building of State Road 3 from Greensburg to North Vernon. When politics changed sides he got on the Decatur County Road crew until he retired. **** When we went to Cincinnati to work, Daddy told us: "Remember, no matter what happens in your life you will always be welcome to come home. No matter how bad it is you can always tell us and we'll do whatever we can to help you."

ESTHER DWENGER MARTIN

MEMORIES OF MY MOM, MARY CECELIA HESSLER DWENGER

I remember the lady I called "Mom". Mary Dwenger was a short, sweet, hard-working lady with sparkling blue-green eyes. She had high ideals, raising her 10 kids to grow up loving God and never to hate anyone. Mom was strict about following rules and obeying parents. She loved Daddy and us ... we never doubted that even when she was mad at something we did.

Mom sang alot, sometimes when she worked but always when rocking babies (or whoever else needed rocked). The rest of us who were not being rocked at the time had to be quiet, so we listened and learned many little songs from her. I remember that Daddy had different endings for a few songs!

Mom was a good neighbor who helped alot of people who needed help in their homes with their family after a new baby came. The rule in the 30's and 40's was that a mother who had a baby at home had to stay in bed for 10 days and could only have broth and light meals. Mom said "yes, you stayed in bed, AND took care of other little ones, AND did mending, AND brushed hair, AND did everything you could AND still stay off your feet". Only in the late 40's did we have electric and a phone (after all the kids were born and some married!), but not an indoor bathroom or running water until much later. We did get a pitcher pump after a cistern was dug but it was soft water that wasn't for drinking. Mom gardened and canned fruits and vegetables enough to last our family for the winter. She raised chickens and set hens. Mom also picked berries for canning, in pies and cobblers.

Mom was excellent as a clothesmaker. She used a treadle sewing machine and made all our dresses, slips, bloomers (panties) and even hats. She used material from feedsacks (flowered and figured) during the depression. Mom bought unbleached muslin and made sheets and pillowcases. She mended tears, darned stockings (long cotton), let down hems and sometimes adding a ruggle to the edge to make clothing last longer. In the mid-thirty's she let us pick our dress material from a mailorder catalog and we could pick any that were 9 or 10 cents/yard. She sewed by lamplight after we kids were in bed. She also made wool-filled comforteers and kept our dolls in new clothes each Christmas. Back in the 30's/40's girls did not wear shorts or slacks and you never went anywhere with holes in your clothes!

We were poor but we never felt poor. Almost everybody at school had the same things that we did. Mom packed our lunches. We had cornbread (Daddy took corn and had it ground at the mill), hard-boiled eggs, and cookies alot for lunch. We drank water from the pump in the schoolyard.

Each of us kids had a cake on our birthday and always felt we were loved and wanted. We were hugged alot, but also learned right from wrong. Mom said we had to do good things so we would be good-trusted grown-ups. Mother was slow to anger but she did lose her temper once in awhile. When she did, then she was mad for the rest of the day and remembered things that you did other days (that you hoped she forgot!) and that you should have been punished for but weren't. I would rather gotten spanked than be scolded by mom. I always deserved it, I know, either for what I did then or what I had gotten away with earlier. My mother was always very fair.

Mom was well loved by everyone who knew her. Our friends were welcome in our home and Mom made them feel special. Her grandchildren and later, great-grandchildren knew that they occupied a special place in her heart. Mom held our family as a unit through good times and bad, but backed Daddy up: what Daddy said was normally what was done. Mary Cecelia Hessler Dwenger was lovely inside and out and we'll always feel lucky she was our mom.

ESTHER DWENGER MARTIN

Mary (Hessler) Dwenger = mom

MEMORIES OF WASHDAY

The night before washday we had to carry water from the outside pump to fill the washboiler. We gathered all the dirty clothes and checked each one for stains. Mother put lard on grease stains that Rosie got on blouses when she worked at Cummins Engine in Columbus. Early the next morning the stove was started and the boiler was moved from the back of the stovetop to the front. A hot fire was kept going until the water was almost boiling. Mother sliced homemade lye soap into the water while it was heating. Meanwhile the big round washtubs were brought indoors and set on stands. Water was pumped and carried to fill them for rinsing. We had a gasoline engine wash machine with a wringer worked by a handle to wring out the clothes. (Before we got the machine all the clothes had to be soaked, washed out using washboards, and wrung out by hand.) After the clothes were sorted they were washed and wrung into the first rinse tub. The clothes were then rinsed in a second tub that had bluing added. The clothes were sorted again and most had be starched. The starch had to be cooked until thick and then added as desired to the 3rd tub of water. The clothes were dipped into the third tub, wrung out again and then hung on clotheslines to dry. We girls usually sang songs while we hung up clothes. In the winter we made clothes lines in the living room using heavy twine string. The outdoor clothes lines were wire and had to be washed every washday before hanging any clothes. After the clothes were dry they were sorted and folded. The starched clothes were dampened, rolled up, and made ready for ironing. Tubs and washer were emptied, cleaned out, and put away. Sometimes on washday Mother put potatoes in the hot oven and we ate them with cheese. HOME MADE COTTAGE CHEESE.

ESTHER DWENGER MARTIN

MEMORIES OF MY GRANDPARENTS

GRANDPA FRANK J. HESSLER: I remember that Grandpa always sat in a big chair. He had a kidney disease (Brights) and for the last 7 years of his life he lived, slept, and ate in his chair. (He couldn't sleep laying down.) Grandpa had an "open" leg that was wrapped in bandages and sometimes bled. When we walked by, he would sometimes reach out and hook his cane around one of our necks and say "come talk to me". He had a long beard that was really bushy but we weren't afraid of him. He died on Christmas Day.

GRANDMA MARY A. HESSLER: Grandma Hessler was a rather larger lady than our mother and wore her hair in a knot on top of her head. She always seemed glad to see us. We were told not to ask for anything but usually one of us casually mentioned something about cookies. Grandma would say "of course, you DURST have a cookie", giving us large sugar cookies with tiny scalloped edges and grape juice to drink. I never could make cookies taste as good. She made all of us feel special and loved. In later years Grandma lived with my Mom and Dad until our house burned, and then she lived with Aunt Bobby (Mr. and Mrs. Clem Koors) until she entered a nursing home.

GRANDPA FRANK RUTT AND GRANDMA MARY RUTT: Grandpa Rutt was thin and had white hair with a long pointed beard. I remember him wearing suspenders. Grandma Rutt was short and stocky, and seemed to be always smiling. She wore her hair fixed in a bun.

ESTHER DWENGER MARTIN

THE KITCHEN WOODBURNING STOVE

The large iron kitchen stove was, I think, the most important piece of furniture in our home. It had several functions besides cooking meals. One of the first noises we heard of a morning was Mom shaking down the ashes & building up the fire. The stove was roughly 3x5 ft of black iron and had 6 holes covered on top with removable iron plates. Above was a compartment called a warming oven that ran the length of the stove and was about 12x15". Small skillets and other things were kept there. The left end of the stove had sliding draft doors to control how hard and fast the wood was burning. One the right end of the stove was a water tank reservoir. This was kept full and hot from the heat of the stove. The night before washday a large copper boiler was put on top of the stove the and filled with water for washing. The stove sat on 4 short legs about 8 in above the floor. The front of the stove had a narrow door which opened to the ash drawer. This drawer was emptied almost daily of ashes. The large oven was always hot and was used alot. Almost all of the family's bread was homebaked, along with cookies, cakes, meats, pies, and other good things. When baking the oven heat was controlled by the draft doors on the front and the damper on the stove pipe going to the chimney. On cold days the oven door was left open to let more heat in the house. Sometimes wet items were dried on the door. The stove lids were used along with flat rocks for feet warmers, (wrapped in newspapers and placed in cold beds, warmed cold feet!). The stove lids were also washed clean and used to make toast when someone was sick. A piece of homemade bread was put onto the lid and browned on both sides. I have never tasted toast since then that was as good or had that flavor.

A tool that seemed part of the stove was the iron. The clothes we wore were mostly cotton and starched so each had to be ironed. The irons we used were called flat irons and had a snap on handle. They were heated on the stove top and exchanged as they became colder. We had 3 irons so one was always hot. All the canning was cold pack done in a boiler or canner on the stove. We used little store bought canned food. The iron stove took the place of many appliances we now take for granted. ESTHER (DWENGER) MARTIN



Wedding of Harry J. and Mary (Hessler) DWENGER Aug.29,1923 Millhousen
 L to R: Ceal Hessler, John Dwenger, Harry J.Dwenger, Matilda Hessler,
 Mary(Hessler)Dwenger, Francis(Bud) Hessler, Martha(Dwenger) Stier

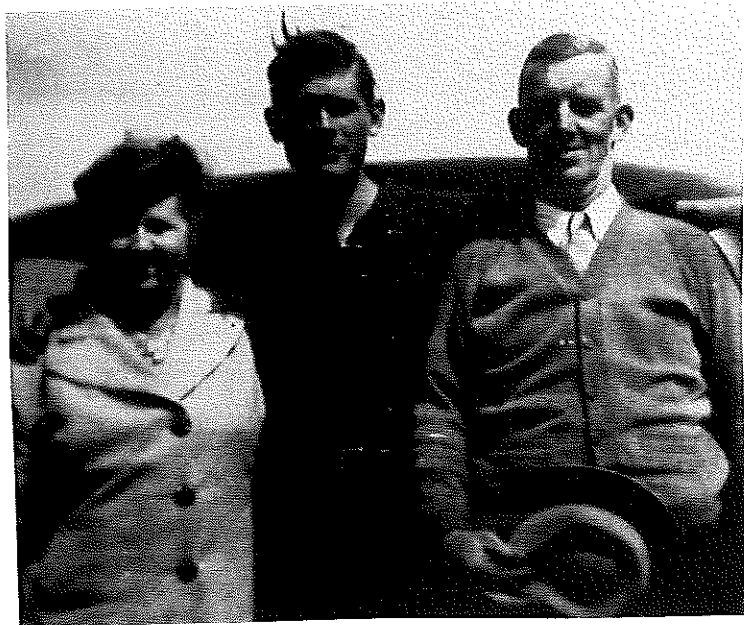

Mary Charles Harry J.
 Dwenger Hamilton Dwenger



Mary(Hessler)Dwenger age 18 - 1919



Mary(Hessler)Dwenger b/Nov.17,1901 Harry Dwenger b/Feb.19,1898



standing: Dick, Anna, Ruth, Esther, Kathy, Rosie, Leonard
 sitting: Betty, Harry J., Mary(Hessler), Mary Ellen, Eddie Joe
 family of Harry and Mary Dwenger

1946



standing: Kathy(Scheidler), Mary Ellen(Veerkamp), Dick, Esther(Martin), Leonard, Betty(Harris)
 sitting: Anna(HCcullough), Edward Joseph, Ruth(Hamilton), Mary(Hessler-Dwenger), Rosie(Powers)

1984

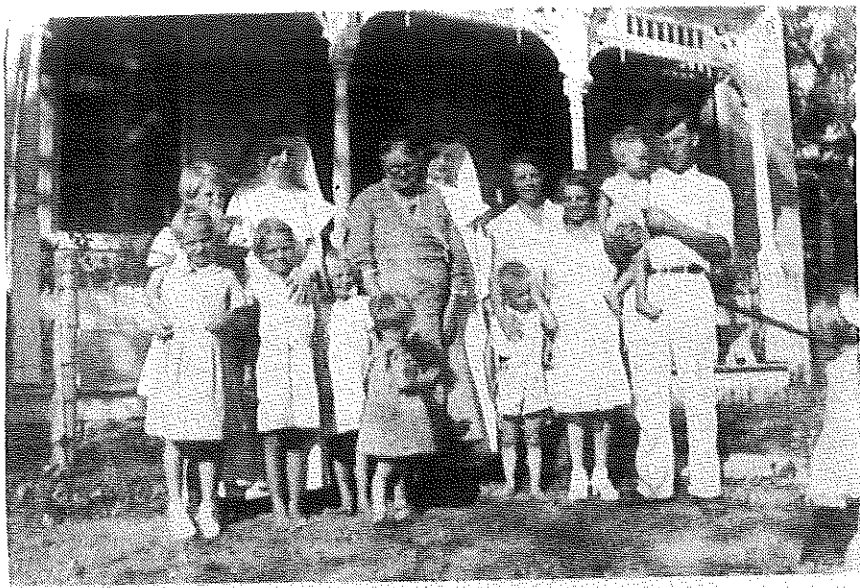

front row: Rosie, Ruth, Betty (turned), Dick,
back row: Esther, Rose Hessler, Annie, Grandma Hessler, sister Louise,
Mary (Hessler) Dwenger, Kathy, Harry J. holding Leonard.
family of Harry J. and Mary (Hessler) Dwenger

1936



Home of Harry and Mary Dwenger.
l to r: Anna, Mary, Rosie, Eddie Joe



4th grade at Lehman school 1938
Rosemary Schwering, Melvin McCullough, Ralph
Schwering, Ruth Dwenger, Calvin Halcomb
Clara Stuhrenburg.

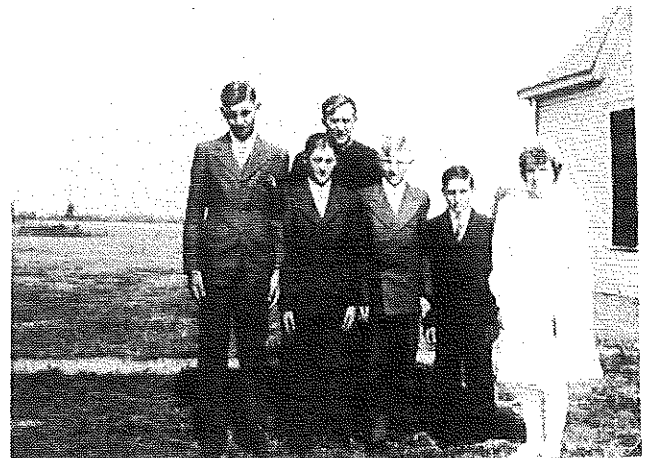

Father Laugel in Back
Nick Schwering, Francis D., Bud Schwering,
Matt Wood, Annie Dwenger

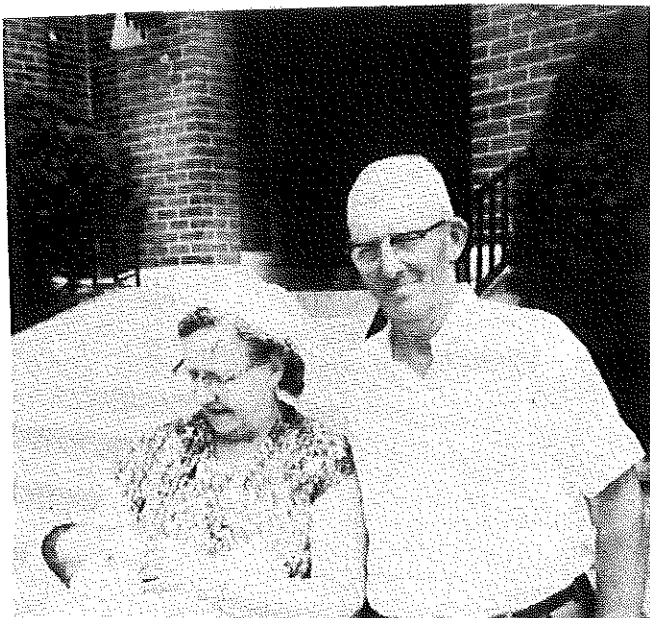

Teke Dwenger, with her grand-
parents: Harry and Mary Dwenger



Rose Hessler, Kathy Dwenger, Mary (Hessler) Dwenger, Helen, Annie
Mary Ellen Dwenger, Mary (Rutt) Hessler, Betty Dwenger

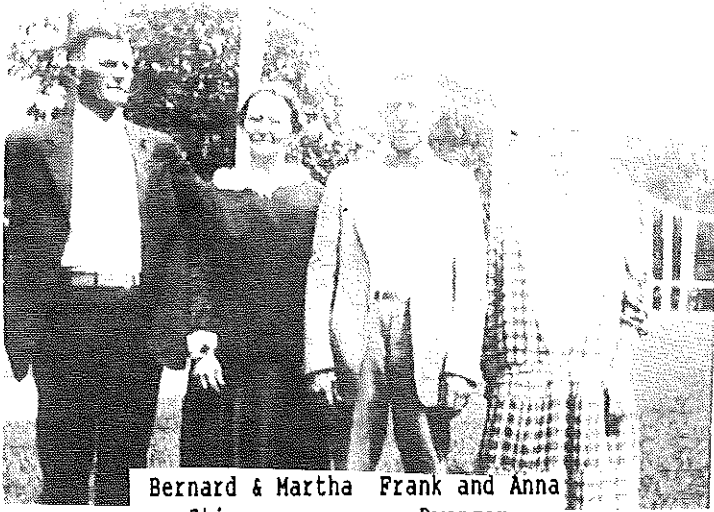

Bernard & Martha Frank and Anna
Stier Dwenger
August 18, 1926

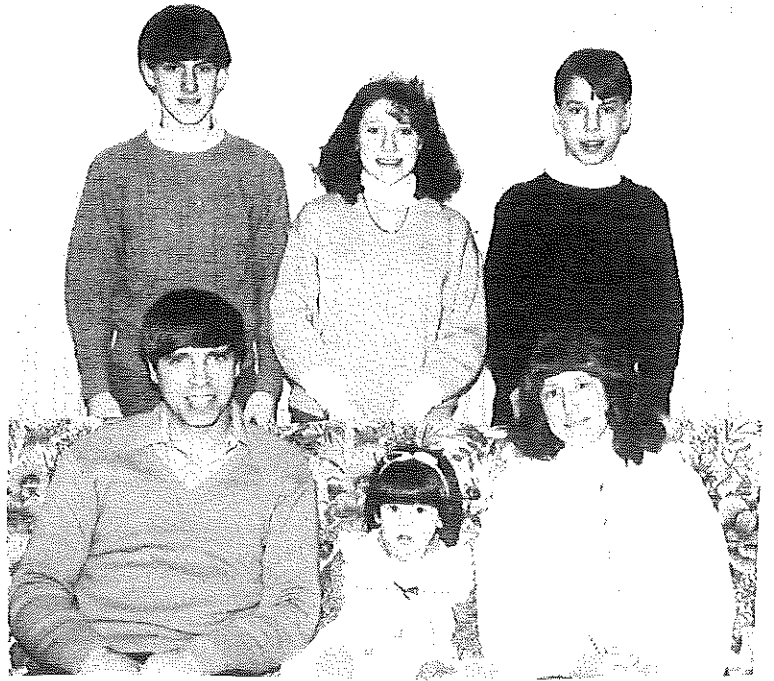

Jerry and Roxanne Scheidler
child: Matt, Kathie, Jon, Christy
1992



L to R: Mary Ellen, Doodle, Rose, Ruth,
Veercamp Scheidler Powers Hamilton
Mary Dwenger, and Esther Martin

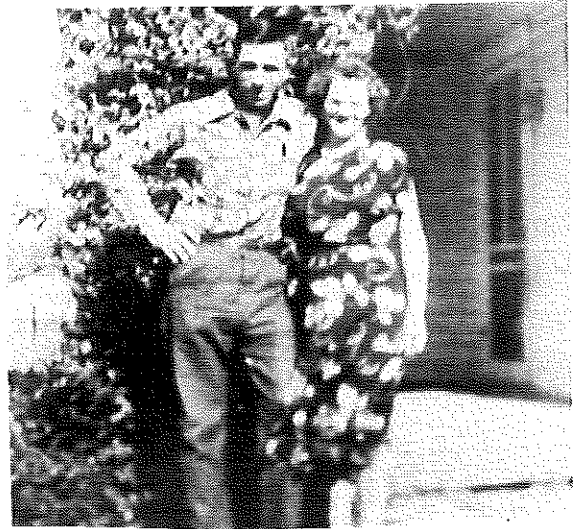

Paul and Kathy Scheidler



Anna Dwenger

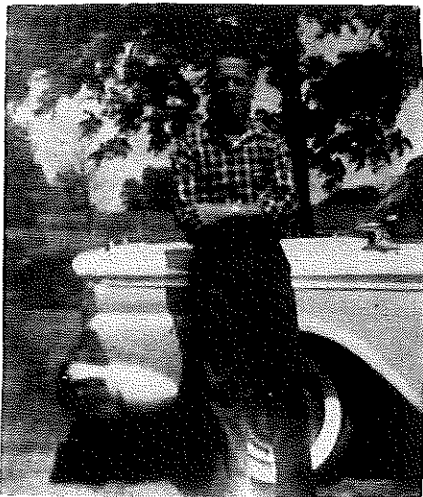

Leonard Dwenger 1960's



Esther, Ruth, Kathy
Dwenger



Kathy, Rosie, Esther
Dwenger



Carl and Mary Ellen
Veerkamp Dwenger
Sept. 23, 1958



Charles and Ruth
Hamilton Dwenger
Jan. 3, 1947



Rosie (Dwenger) Powers
b/Feb. 21, 1927



Leonard and Janet (Gus)
Dwenger Burgmeier
Oct. 24, 1964

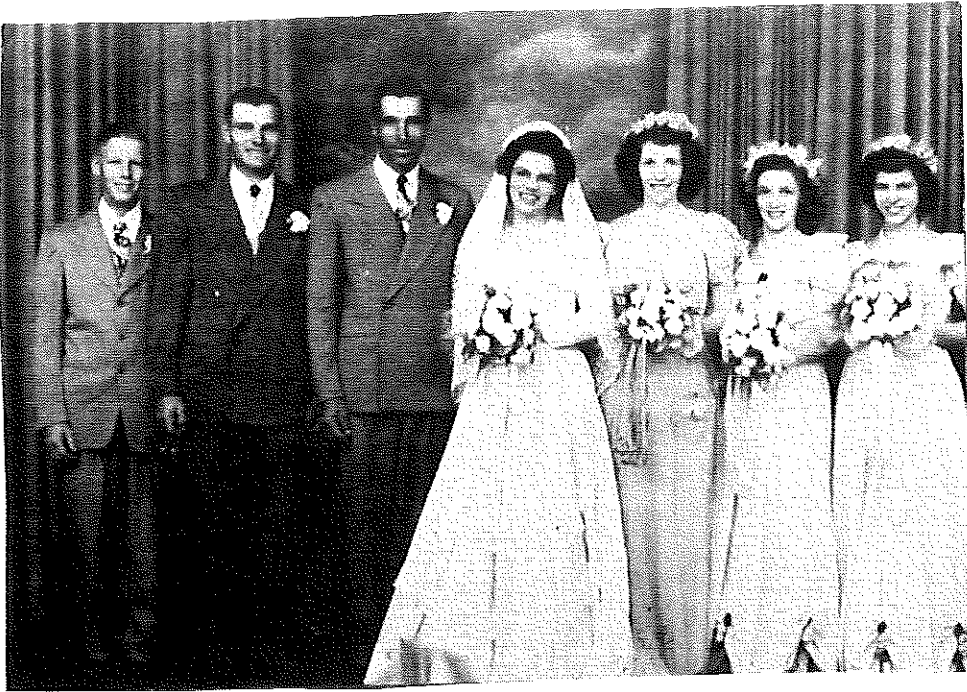

May 17, 1949 Kathy and Paul Scheidler
 L to R: Dick Dwenger, Tony Scheidler, Paul Scheidler,
 Kathy (Dwenger) Scheidler, Esther Dwenger, Rose Dwenger,
 Martha Scheidler

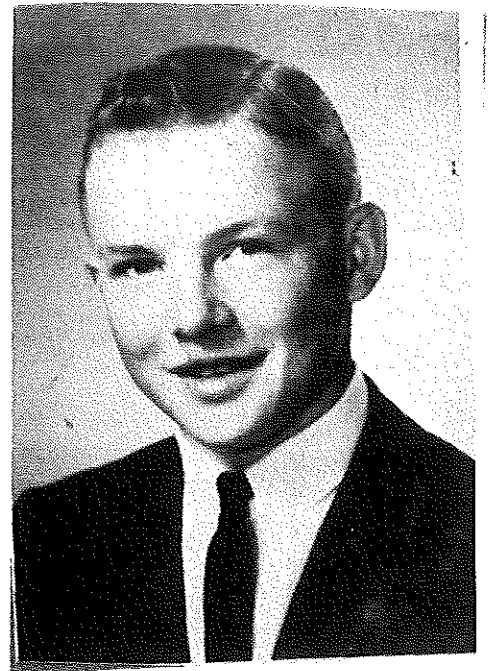

Edward Joseph Dwenger



Sis, Dick, Diane
 Dwenger Roncone

1992



Eddie Joe Dwenger
 (son of Harry and Mary)



Ruth Hamilton, Esther Martin
 Rosie Powers

ROSTERS OF STUDENTS AND STAFF OF LEHMAN SCHOOL DURING THE YEARS OF 1935-1942
AS COMPILED BY ESTHER DWENGER MARTIN

1935-36 Teacher: MARIE MONTER Janitor: _____

- 1ST Grade: BOBBY COCHRAN, HELEN ROBBINS
- 2ND Grade: RUTH DWENGER, CALVIN HOLCOMB, URBAN BLANKMAN, CALRA STURENBERG, MARY RUTH BENHAM, BETTY HORNLIN, OSCAR HUGHES
- 3RD Grade: ROSELIA DWENGER, MARY PAULINE SCHWERING
- 4TH Grade: JUANITA CHRISTIAN, BOB BENHAM
- 5TH Grade: ESTHER DWENGER, FRANCES CHRISTIAN
- 6TH Grade: EARL MANLIEF, JOHN HOLCOMB
- 7TH Grade: KATHLEEN DWENGER
- 8TH Grade: JAMES SCHWERING, MARCELLA SCHWERING

1936-37 Teacher: BOB McCLANAHAN Janitor: JOHNNY HALCOMB

- 1ST Grade: BRAD SCHWERING, NICK SCHWERING, NORMA JEAN HULL, ANNA MAE DWENGER
- 2ND Grade: HELEN ROBBINS, CHARLOTTE VICKREY
- 3RD Grade: RUTH DWENGER, CALVIN HOLCOMB, BETTY HORNLIN, CLARA STUHRENBERG, ROSEMARY SCHWERING, RALPH SCHWERING, DONALD PADGETT, OSCAR HUGHES
- 4TH Grade: ROSELIA DWENGER, MARY P. SCHWERING, PEGGY VICKREY
- 5TH Grade: REBA PADGETT, HENRY LEE ROSS
- 6TH Grade: ESTHER DWENGER
- 7TH Grade: JOHN HOLCOMB, EARL MANLIEF, JOHN H. VICKREY
- 8TH Grade: KATHLEEN DWENGER, NIOMA PADGETT

1937-38 Teacher: MARIE MONTER Janitor: JOHN H. VICKREY

- 1ST Grade: ADELAIDE STUHRENBERG, ISABELL MEREDITH, MARYLOU LEHMAN, MARJORIE NELL HUGHES, DICK DWENGER, RICHARD SCHWERING, DONALD SCHWERING
- 2ND Grade: ANNA MAE DWENGER, BRAD SCHWERING, BERT (NICK) SCHWERING, NORMA JEAN HULL, CLARA MABEL BYARD
- 3RD Grade: HELEN ROBBINS, NORMA RUTH THOMPSON, BILLY THOMPSON
- 4TH Grade: RUTH DWENGER, CALVIN HOLCOMB, ROSEMARY SCHWERING, RALPH SCHWERING, CLARA STUHRENBERG, MELVIN McCULLOUGH, ISCAR HUGHES
- 5TH Grade: ROSELIA DWENGER, MARY PAULINE SCHWERING, MARGARET VICKREY
- 6TH Grade: -----
- 7TH Grade: ESTHER DWENGER
- 8TH Grade: EARL MANLIEF, JOHN HOLCOMB, JOHN VICKREY, LEOTA McCULLOUGH

1938-39 Teacher: FRANK HAHN Janitor: ESTHER DWENGER

- 1ST Grade: GEORGE LEHMAN, MARY CATHERINE SCHWERING
- 2ND Grade: DICK DWENGER, MARJORIE NELL HUGHES, DONALD & RICHARD SCHWERING, ADELAIDE STUHRENBERG, ISABELL MEREDITH, MARYLOU LEHMAN
- 3RD Grade: ANNA MAE DWENGER, NORMA JEAN HULL, HENRY & NICK SCHWERING
- 4TH Grade: HELEN ROBBINS, BETTY HORNLIN, EDITH HARRISON, BILLY THOMPSON, NORMA RUTH THOMPSON
- 5TH Grade: RUTH DWENGER, CALVIN HOLCOMB, RALPH SCHWERING, DONALD PADGETT, ROSEMARY SCHWERING
- 6TH Grade: MARY P. SCHWERING, ROSELIA DWENGER
- 7TH Grade: REBA PADGETT
- 8TH Grade: ESTHER DWENGER, MAXINE HARRISON

1939-40 Teacher: RUTH KETCHUM Janitor: MARY SCHWERING

- 1ST Grade: BETTY DWENGER, EDWARD LEE LARSON (DOC), MARSHALL MEIXNER, LEBOY (HOWARD LELAND) HARRISON, SARAH GRACE LEHMAN
- 2ND Grade: GEORGE LEHMAN, MARY CATHERINE SCHWERING
- 3RD Grade: ISABELL MEREDITH, MARY LOU LEHMAN, DICK DWENGER, DON SCHWERING, MARJORIE NELL HUGHES, RICHARD SCHWERING, DONALD DAVID LARSON
- 4TH Grade: ANNA MAE DWENGER, NICK SCHWERING, BUDDY SCHWERING, NORMA J. HULL
- 5TH Grade: EDITH HARRISON, HELEN ROBBINS
- 6TH Grade: CALVIN HOLCOMB, RUTH DWENGER, DON PADGETT, RALPH & ROSEMARY SCHWERING
- 7TH Grade: MARY PAULINE SCHWERING, ROSELIA DWENGER
- 8TH Grade: -----

1940-41 Teacher: RUTH KETCHUM Janitor: MARY SCHWERING

- 1ST Grade: DWIGHT PADGETT, NORBERT SCHWERING
- 2ND Grade: BETTY DWENGER, MARSHALL MEIXNER, LEBOY HARRISON, SARAH GRACE LEHMAN
- 3RD Grade: GEORGE LEHMAN, MARY CATHERINE SCHWERING
- 4TH Grade: DICK DWENGER, DON SCHWERING, RICHARD SCHWERING, MARJIE HUGHES, MARYLOU LEHMAN, ISABELL MEREDITH
- 5TH Grade: ANNA MAE DWENGER, NICK SCHWERING, BUDDY SCHWERING, NORMA JEAN HULL
- 6TH Grade: EDITH HARRISON, HELEN ROBBINS
- 7TH Grade: RUTH DWENGER, CALVIN HOLCOMB, DON PADGETT, RALPH & ROSEMARY SCHWERING
- 8TH Grade: MARY PAULINE SCHWERING, ROSELIA DWENGER, GENEVA WIGGINS

1941-42 Teacher: MARIE MONTER Janitor: CALVIN HOLCOMB

- 1ST Grade: LEONARD DWENGER, FERN MANLIEF, NORMAN HARDEBECK
- 2ND Grade: DWIGHT PADGETT, NORBERT SCHWERING, LELAND HARRISON
- 3RD Grade: BETTY DWENGER, MARSHALL MEIXNER, SARAH GRACE LEHMAN
- 4TH Grade: GEORGE LEHMAN
- 5TH Grade: BILLY HARDEBECK, LOLA MAE ROGERS, MARYLOU LEHMAN, DICK DWENGER, ISABELL MEREDITH, MARJORIE NELL HUGHES, DON SCHWERING
- 6TH Grade: ANNA MAE DWENGER, NICK SCHWERING, BUD SCHWERING, NORMA JEAN HULL
- 7TH Grade: EDITH HARRISON
- 8TH Grade: CALVIN HOLCOMB, RUTH DWENGER, DON PADGETT, TONY HARDEBECK

* PAUL AND KATHLEEN(DWENGER) SCHEIDLER

Kathleen Mary Dwenger was born on June 5, 1924, in Decatur Co. Indiana. She was the eldest child of Harry J. and Mary(Hessler)Dwenger. She was one of ten children: Kathy, Esther, Rosie, Ruth, Anne, Dick, Betty, Leonard, Mary Ellen, Edward.

She was a member of the St. Dennis Catholic Church. After finishing her schooling, she worked for a time in cinn. Ohio.

She was married to Paul Clement Scheidler on May 17, 1924. Paul was born on September 5, 1919. He was the son of Paul and Clara() Scheidler from Millhousen.

Kathy and Pauly moved to the North side of Greensburg, to a farm which they later purchased. They are members of the St. Marys Catholic church in Greensburg.

They are the parents of six children: Rose Marie, Jerry, Tim, Mary Ann, and Paul, all of whom are now married.

Kathleen and Paul remain active in farming and are enjoying their twelve grandchildren.

TIMOTHY AND JANE(WESSEL) SCHEIDLER

Timothy Charles Scheidler was born on September 21, 1956, in Greensburg, in Decatur County. He is the son of Paul and Kathleen(Dwenger) Scheidler, and is the fourth of their six children.

Tim was married to Jane Roselyn(Wessel) on May 3, 1980. Jane Roselyn Wessel was born on October 31, 1958, in Batesville, IN. in Ripley Co. She is the daughter of Lawrence and Roselyn (Kuntz)Wessel. Jane has four sisters: Lucy Mikula, Donna Wietlisbach, Lorraine Hampson, and Mary Hornbach. She has two brothers, David and Kevin Wessel.

Tim and Jane are the proud parents of three boys: Andrew Lawrence, born June 10, 1983. Brian William born August 16, 1985, and Christopher Paul, born on January 29, 1991.

Tim and Jane enjoy their sons and farm life at 75 West County Road 1000 South, Westport, Indiana.

WILLIAM AND MARY ANN(SCHEIDLER) TURNER

Mary Ann Scheidler was the fifth child of Paul and Kathleen(Dwenger) Scheidler. She was born on October 16, 1958, in Greensburg.

She was married to William Marion Turner on November 28, 1987. William Turner was born on April 24, 1958. He was the son of William and Ann Turner, of Greenwood.

Her husband Bill, is the second oldest of six children, having two brothers, Larry and Tim. He has three sisters, Nancy, Amy, and Theresa.

Mary Ann and Bill have built a home on five acres North of Boggstown, in Shelby County in the summer of 1989. Bill has been employed for sixteen years as a city driver with Advance Transportation, Indianapolis. Mary Ann was formerly employed as a paralegal until the birth of their son, William Marion, on March 9, 1993. Mary Ann and Bill enjoy their country life at 5678 North 825 West, Boggstown, Indiana.

PAUL AND SHARI(HERMESCH) SCHEIDLER

Paul Anthony Scheidler was born on February 17, 1960. He is the sixth child of Paul and Kathleen(Dwenger) Scheidler. He attended the St. Mary's Catholic church in Greensburg.

Paul was married to Shari Lynn Hermesch on September 20, 1986. Shari is the daughter of Donald C. and Jeanie(Becker) Hermich, of Greensburg. Prior to their marriage Paul and Shari built a home in the summer of 1986 on 421 North. Paul is a farmer and a brickmason. Shari is employed with GTE.

Paul and Shari are the proud parents of one son, Bradley Paul, born November 27, 1992.

History of Jerry and Roxanne Scheidler

Jerome Paul Scheidler and Roxanne Becraft were married April 28, 1973 at St. Mary's Catholic Church in Greensburg, with Rev. Harold Ripperger officiating.

Jerry is the second of the six children born to Paul C. and Kathleen (Dwenger) Scheidler. He was born February 11, 1952 in Greensburg, Indiana. He was raised on his parent's farm north of Greensburg on Hwy. 421.

Roxanne is the first of the two daughters of Willard and Jane Kathryn (Sachse) Becraft. She was born May 9, 1953 in Greensburg, Indiana. She grew up in the small town of Sandusky, 5 miles north of Greensburg on St. Rd. 3.

Jerry and Roxanne both graduated from North Decatur High School, he in 1970 and she in 1971.

Jerry has been employed with Delta Faucet Company in Greensburg for the past 20 years. He has also engaged in farming, and has recently opened his own shop, Scheidler Farm Repair and Machine Shop, which is located 4 miles north of Greensburg on Hwy. 421.

Jerry is very interested in aviation and is a member of the Decatur Co. Aviation Club. He has restored a 1952 Cessna 170-B airplane, a classic, and enjoys flying when time permits. He has been a licensed pilot for several years and hopes to find the time to take additional training in the future.

Jerry and Roxanne's first child, a son, was born June 21, 1974 in Greensburg. Matthew Eric is presently a senior at North Decatur High School and has recently been accepted into Butler University in Indianapolis. He plans on studying Radio-TV and music. Matt is currently employed part-time with WIRE Radio in Greensburg.

Their second child, a girl, was born November 28, 1975 in Greensburg, and was named Kathie for her Grandmothers. Kathie is currently a sophomore at the Oldenburg Academy in Oldenburg, Indiana. Jonathan Michael, the third child of Jerry and Roxanne, was born July 30, 1978 in Greensburg. He is an 8th grade student at North Decatur High School.

The Scheidler's were pleased to welcome into their family their fourth child, a daughter, born September 25, 1990, in Greensburg. They named her Christa Anne.

Jerry, Roxanne, Matt, Kathie, Jon and Christy Scheidler currently reside 4 miles north of Greensburg on Hwy. 421.

Rose Marie (Scheidler) Peters was born on March 22, 1950 at Greensburg, Indiana, in Decatur County. She is the daughter of Paul Clement Scheidler, born on September 5, 1919 and Mary Kathleen (Dwenger) Scheidler, born on June 5, 1924. She is one of 6 children. The names of her siblings are: Jerome Paul Scheidler, born February 11, 1952
Mary Janet (Scheidler) Taylor, born February 18, 1954
Timothy Charles Scheidler, born September 21, 1956
Mary Ann (Scheidler) Turner, born October 16, 1958
Paul Anthony Scheidler, born February 17, 1960

Rose Marie attended Adams Elementary School and graduated from it after 8th grade in 1964. She then attended the Academy of the Immaculate Conception in Oldenburg, Indiana for her high school years and graduated from there in 1968. After graduation, she went into the convent for the next 2 1/2 years, where she also began her college education. After marriage and children, in the year of 1983, she finished her college and earned the Bachelor of Science Degree in Computer Science out of the Math Department from Middle Tennessee State University in Murfreesboro, Tennessee, graduating with honors.

Rose Marie met William Lee Peters in the summer of 1972, and they were married the next year on June 23, 1973. He was born on June 7, 1950 in Ohio, the son of William H. Peters, born on April 19, 1923 and Bernice Marie (Schroentrup) Peters, born August 1, 1924. He graduated from Purdue University in 1972 with a Bachelor's Degree in Aeronautical Engineering. In 1983, he received his Master's Degree in the same field from the University of Tennessee Space Institute. His siblings are:
Cynthia (Peters) Grote, born September 9, 1952
Kenneth Neil Peters, born August 25, 1955
Betsy Lynne Peters, born July 22, 1962

Rose Marie and William have two children:
Laura Ann Peters, born May 23, 1981
Rachel Lynn Peters, born December 10, 1984

Rose Marie and William hold the bookkeeper/treasurer office in their church and enjoy serving the Lord at all times and in all places. Praise Him! They are currently residing at 215 McKaig Road, Murfreesboro, Tennessee 37130.

I, Mary Janet Scheidler, was born on February 18, 1954, at the Decatur County Memorial Hospital. I am the daughter of Paul L. and Kathleen Dwenger Scheidler. I am one of six children. I have 2 sisters and 3 brothers. They are Rose Marie Peters (3-22-50), Jerome Paul (2-11-52), Timothy Charles (9-21-56), Mary Ann Turner (10-16-58) and Paul Anthony (2-17-60)

I graduated from the Academy of the Immaculate Conception, Oldenburg, IN, in 1972. I met my first husband, and the Father of my only child at a Rural Youth dance held in Oldenburg. I was a Senior and had received permission to walk across the street to a local dance. His name was James Edward Kipper. We were married on May 17, 1975. We had one child, a daughter, Jennifer Jo born on January 13, 1978. From the moment they placed her in my arms she has been the light of my life. Her father and I realized it was not in her best interest to continue to live together and were divorced on January 6, 1985.

I remarried on July 14, 1990 to Randy Dean Taylor of Westport, IN. We, Randy, Jenny and I, moved to Charlotte, NC two weeks later as He was employed there. We live in a small community about 15 miles north of Charlotte, near a large lake. We spend our weekends on our ski boat and enjoy the lake and lovely weather North Carolina has to offer.

I am employed at TDSI-BIDS as an office manager. We are serviced by the CSXT railroad. Our responsibility is to transload food grade plastics and products from rail car to truck for local delivery. It is a fast paced and rewarding job. I travel about once a month and I am getting to see a lot of this country.

Jennifer will be a sophomore at East Lincoln High. She plays volleyball and softball and is really enjoying high school.

Randy is employed by Heritage Environmental Service as a truck driver. He is still based out of Indianapolis, and gets home (Westport) quite often. His parents, John and Doris, still live in Westport.

ESTHER ANNA DWENGER b. 30 September 1925
WILLIAM FRANKLIN MARTIN b. 17 June 1925 d. 12 February 1985

Esther Anna Dwenger was born NE of Greensburg, IN near Kingston, IN in Decatur Co., the 2nd child of Harry John and Mary Cecelia Hessler Dwenger. Her father was a farmhand and her mother a housewife. Both were good at their jobs, honest and hard-working. Esther had 6 sisters and 3 brothers (see Hessler-Dwenger History).

Esther attended one-room schoolhouses "Woods" grades through 4 then moved from Joe Tuckers on R2 Greensburg to R1 Westport. Here her parents bought a farm 5 miles East of Westport. She attended "Lehman" school (see additional article) grades 5-8. At age 15, she began working in family homes with children. In 1941, she went to Cincinnati to continue this type of work. Many girls from Millhousen, Batesville, and surrounding counties did this - Esther had 2 aunts: Aunt Chris (Cord) and Aunt Helen (Sr. Margaret Mary) who also worked there. She worked mostly in Avondale for Jewish families. The pay averaged \$8 per week. She attended St. Thomas Aquinas Church in Cincinnati. The Priests and Nuns were Dominican. Esther went also to St. Andrews Parish and belonged to the Legion of Mary.

In 1947 she met William F. Martin who had been discharged in 1946 from the Army after WWII. Bill was the son of Wm E. and Josephine Hardebeck Martin. He had 2 twin brothers: Richard and Clarence Martin. Bill was 6 ft 1 and had curly red hair. He went to an "on the job" school training at "Clutch, Motor, and Brake" in Cincinnati. The program was co-sponsored by the Government for Vets. He was a mechanic/machinist for tractors and all farm equipment, working at Chas. Shirks, Dick Martin's garage, and Thurston's Implement, all of Greensburg. For a short period he worked with Norman Tower at Ceramic Ovens until Norman moved to Southern Indiana.

Bill was a Catholic and attended St. Mary's Church, Greensburg. He attended St. Mary's as a child and graduated from the 8th grade there. He attended high school at Sandusky where he was a member of the Blackhawk Basketball team until he was drafted into the Army. Bill was in the Mechanized Cavalry. He arrived in Europe during the "Battle of the Bulge" in Austria, serving there under General Patton. After the war ended, he stayed in Europe serving as a M.P. until his time was up. Bill then returned to his home at R.1 Greensburg.

Bill and Esther were married May 8, 1948 at St. Dennis Church by Father Joseph Laugel. They lived in Cincinnati until his school was over and then the couple moved back to Decatur Co. Bill and Esther lived on R8 Greensburg the rest of their married life. Bill liked to hunt and fish, and was a member of the Decatur County Conservation Club for some time. Esther enjoys crafts and most people. Esther is known to many people in the Decatur Co. area for her work as a 4-H leader for 27 years. Many also remember the excellent care they were given while Esther was a Nurse Aide on 3rd floor at Decatur Co. Hospital in Greensburg, from 1974 to 1986.

Bill and Esther had five children: Michael Wm. (b. 2-23-49), William Joseph (b.3-30-50), Jacques Charles (b.6-21-52 d.12-29-59), Debra Josephine (b. 7-20-59), and Steven Leonard (b. 1-14-64).

MICHAEL WILLIAM MARTIN *b. 23 February 1949*
BETTY ROSE (HERMESCH) MARTIN *b. 20 July 1949*

Michael Wm. Martin was born Feb. 23, 1949 at Decatur Co. Memorial Hosp. Greensburg, Ind., the 1st child born to Bill and Esther (Dwenger) Martin. Michael had 3 brothers (Bill, Jacques, and Steve) and one sister (Debbie). Michael attended St. Mary's Church and school and was a Mass server. He graduated from 8th grade at St. Mary's and then attended Greensburg High School, where he was on the track team. Mike was active in CYO and played on the basketball team. Mike was also a very active 4-H member and enjoyed many award trips. He graduated from Greensburg High School in 1967. Mike's hobbies are guns, fishing, and book collecting.

Michael joined the Air Force in Feb. 1968 and stayed in for 20 yrs. Mike married Betty Rose Hermesch on August 17, 1968. Betty was born July 20, 1949 at Greensburg, in Decatur Co. She is the daughter of Charles C. and Philomeana (Suttmoeller) Hermesch and was the 6th of eleven children. Betty enjoys gardening, flowers, cooking and baking for family and friends.

Mike and Betty have four children: Daniel Harlan Martin *b. May 5, 1969*, Scott Michael Martin *b. June 28, 1970*, Michelle Elaine Martin *b. Dec. 1, 1971* and Bernice Carol Martin *b. Dec. 20, 1972*.

The Martin family have lived in Washington D.C., Arkansas, Georgia, England, and Germany. The family lived two years in Greensburg: one year while Michael had a year's tour in Korea (1970) and another year (1972) as Michael served a year's tour in Vietnam as the U.S. was pulling out.

Michael divorced Betty in 1984. She & the 4 children came home to make roots in Greensburg, Ind. The children all went to North Decatur High School Betty is employed at Delta Faucet in Greensburg and Mike is employed at Valeo in Greensburg. They have one grandchild, Paul Michael Adams.

WILLIAM JOSEPH MARTIN *b. 30 March 1950*
DEBORAH LEE (COOMES) MARTIN *b. 4 February 1954*

William Joseph Martin was born March 30, 1950 at Decatur Co. Memorial Hospital, Greensburg Ind. He was the 2nd child of Wm. Franklin and Esther Anna (Dwenger) Martin (See History). William attended St. Mary's Church and School and graduated from the 8th grade there. He was a Mass server and was active in CYO, playing basketball. He was also an active 4-H member, winning many awards and trips. William attended Greensburg High School, played Freshman basketball, and graduated in 1968. He enlisted as a member of the Air Force Reserves in 1969 and served until 1975. Bill is employed at Briggs Equipment, Greensburg as manager of the Bobcat Division. He enjoys guns, hunting, fishing, gardening, and four-wheelers.

William married Deborah Lee Coomes on June 21, 1971. Deborah is the daughter of Malcome L. Coomes and Mary Cornelia (Asher) Coomes. She was born Feb. 4, 1954 at Bardstown, Ky. in Nelson County. Deborah has three sisters [Sandy Webb, Donna Toney, and Karen Runyan, all of Ind.] and one brother [William E. Coomes of Ky.]. Deborah enjoys reading, woodworking, ceramics, knitting, and crocheting. She is employed at Valeo of Greensburg.

William and Deborah have 4 children: William Lee Martin *b. Nov. 16, 1971* Heather Alane Martin *b. May 24, 1975*, Benjamin Ryan Martin *b. Aug. 29, 1981* and Shalon Renee Martin *b. April 13, 1985*. All reside in Decatur Co. Ind.

William Lee Martin (Willie) is a 1990 graduate of Greensburg High School. He attended Vincennes University and enjoys fishing and hunting.

Heather Alane Martin is a 1993 graduate of Greensburg High School and is currently attending Ball State University. She enjoys music and talking.

Benjamin Ryan Martin attends Jerman School in Greensburg. He enjoys electronics, putting together and taking things apart, and Nintendo games.

Shalon Renee Martin attends Washington Elementary in Greensburg. She enjoys coloring, bike riding, and puzzles.

Jacques Charles Martin was born June 21, 1952 at Decatur Co. Memorial Hospital, the 3rd son of William F. and Esther A. (Dwenger) Martin. Shortly before his 7th birthday, in June 1959, he was admitted to Riley Children's Hospital in Indianapolis with a diagnosis of acute leukemia. Jacques stayed in the hospital for 17 days, and then was a patient back and forth. After enjoying a nice Christmas, Jacques died on December 29, 1959.

Jacques enjoyed making models and made a bird model the night before he died. He was a quiet child, but enjoyed games with other children, especially his brothers Mike and Billy and his uncle Eddie Joe Dwenger.

Jacques completed the 1st grade at St. Mary's School. He made his First Communion early at Riley Hospital because his Blood Pressure was so low. He is buried in St. Mary's Cemetary next to his Grandpa and Grandma Martin.

DEBRA JOSEPHINE (MARTIN) PEETZ *b. 20 July 1959*

CLIFFORD LEE PEETZ *b. 4 September 1956*

Debra Peetz was born at Decatur Co. Memorial Hosp. in Greensburg, Ind. She was the 4th child (and only daughter) born to Bill and Esther Martin. Debra was the first child of this generation born with the Martin red hair. She attended St. Mary's school for 6 years and then attended Greensburg Jr. and Sr. High Schools, graduating in 1977. Debra was active in Decatur Co. 4-H and was a member of St. Mary's CYO. Two weeks before graduation from High School, Debra was introduced by her cousins (Patty McCullough Carson and David McCullough) to a friend of theirs named Clifford Lee Peetz. Cliff and Debbie went out on their first date alone on May 20, 1977 and were married exactly one year later on May 20, 1978.

Cliff is the son of Russell (John) Peetz and Pearl Alberta (Welsh) Peetz of Napoleon. He was born on September 4, 1956 and was the youngest of 5 children: John, Carolyn Sue, Linda Lou, Danny, and himself. Cliff attended Napoleon Elementary school and Jac-Cen-Del High School, where he graduated in 1975. While a Jr. and Sr. in High school, Cliff attended the Southeastern Indiana Vocational School in Versailles, and graduated from there with a certificate in electricity. Cliff's parents owned the Peetz Supermarket in Napoleon; he spent many hours working at the family store. Cliff works as a machine operator at Delta Faucet in Greensburg, where he has been employed since Sept. 3, 1975.

Cliff and Debbie four children: Michael Dan Peetz *b. Oct. 11, 1978*, Anthony Steven Peetz *b. Jan. 26, 1981*, Elisha Nicole Peetz *b. Dec. 29, 1981* and Margaret Josephine Peetz (Maggie) *b. Jan. 24, 1984*. The couple were blessed with two wonderful sons when Debbie found she was unable to have any more birth children. After many prayers, Cliff and Debbie became the happy and proud parents of two very special daughters, adopted and welcomed into the Martin, Dwenger, and Peetz families on June 1, 1990.

Debra is currently attending The Christ Hospital School of Nursing in Cincinnati and is well on her way to earning a bachelor degree at IUPUI. Cliff's hobbies are deer/squirrel hunting, collecting and watching John Wayne movies, computer games, and being a Boy Scout Assistant Scoutmaster. Together the couple enjoys flea markets, Volksmarches, & cookouts.

Mike is an IU/Bobby Knight fan, enjoying sports of all types. He is a freshman at Jac-Cen-Del High School, where he is a member of the basketball team, cross country, track, and student council. He is also a Life Rank Boy Scout and a member of the Order of the Arrow in Scouts.

Tony is a Purdue fan, and is a 7th grader at Jac-Cen-Del. He enjoys computer games and programs, and has helped with the summer computer classes at JCD since their beginning. He enjoys basketball & riding bikes.

Elisha is a 6th grader at JCD Elem. who enjoys sports, reading, and shopping. She especially enjoys weekly gymnastic lessons and hopes someday to become a cheerleader or drill team member at Jac-Cen-Del.

Maggie is a 4th grader at JCD Elem. who enjoys Barbie dolls, games, and television. She also enjoys gymnastic lessons and also baton lessons.

STEVEN LEONARD MARTIN *b. 14 January 1964*

Steven Leonard Martin was born January 14, 1964 at Decatur Co. Memorial Hosp., Greensburg, IN. He is the youngest of the 5 children of William Franklin and Esther Anna (Dwenger) Martin. (See History). Steve attended St. Mary's Catholic School in Greensburg thru the 6th grade, then attended Greensburg Jr. and Sr. High Schools, graduating in May, 1982.

As a teenager, Steve was an active member of the Boy Scouts, in which he was also a member of the Order of the Arrow. A member of Troop 500 Boy Scouts (sponsored by Greensburg K of C), Steve attended Philmont Boy Scout Ranch, located in Cimarron, New Mexico. He was also active in the St. Mary's CYO, a member of the K of C Squires, and enjoyed Decatur Co. Young Adults organization. Always having been interested in sports, Steve has been an active member in several local sports leagues, has participated in the Can-Am games, and has accumulated several team trophies and medals. He plays golf, and has enjoyed several vacation trips with different friends to many parts of the United States and Caribbean.

Steve bought a home at Lake Santee, Northeast of Greensburg, and is busy remodeling it. He worked for Stewart Seeds, Inc. since his sophomore year in high school (1980) and changed to Briggs Equipment in 1992. Steve works with Vanderbur & Sons and is not married.



Esther and Bill Martin
taken Aug. 1971



CPL William F. Martin
1944-1946 W.W.II
E 121 squadrin-106cav.



Esther and Bill Martin
May 28, 1948

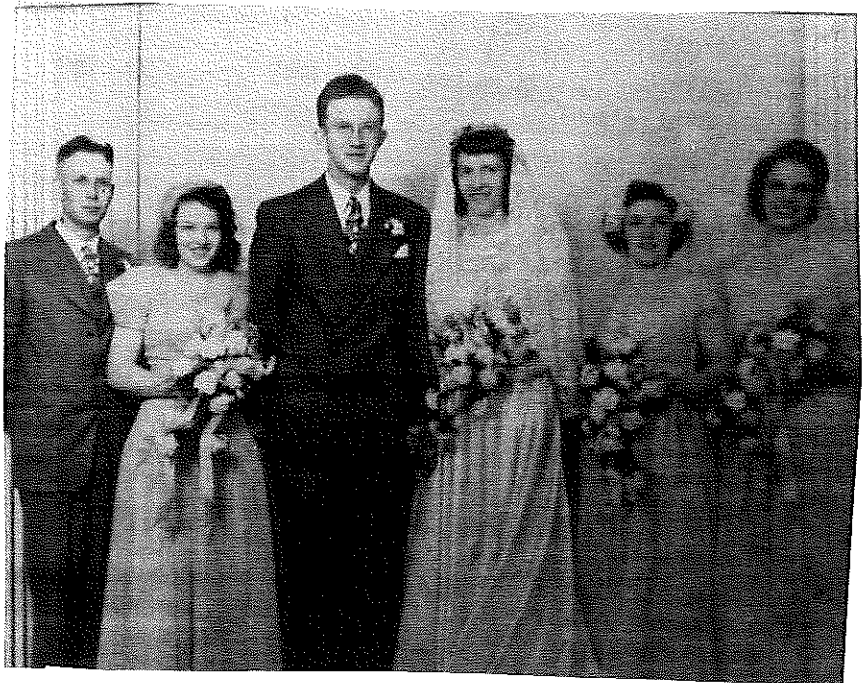

Wedding of Bill Martin and Esther Dwenger
May 8, 1948 Decatur Co. In. St. Dennis
L to R: Tony Hardebeck, Anna Dwenger, Bill
Martin, Esther (Dwenger) Martin, Rosie Dwenger,
Kathleen Dwenger



Betty Rose (Hermesch) Martin &
Michael Wm. Martin with their
1st Grandchild
Paul Michael Adams



Debra Josephine (Martin) Peetz &
Clifford Lee Peetz and Family
1st Christmas Together, 1990

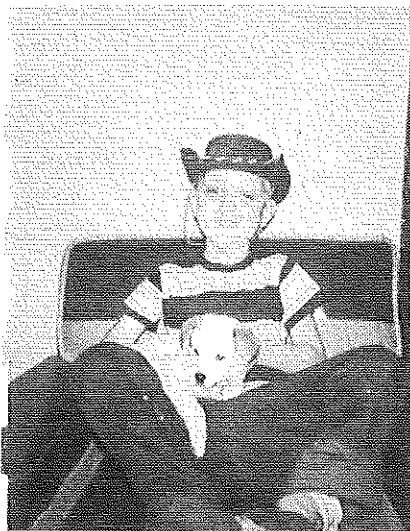

Jacques Charles
Martin
November, 1959



William Joseph Martin &
Deborah Lee (Coomes) Martin



Steven L. Martin

Children of Mike & Betty Martin:

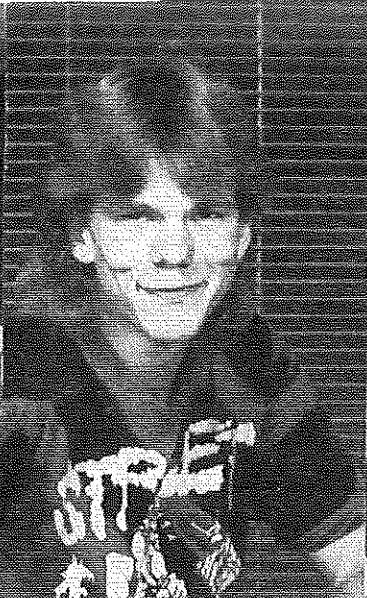

DANNY HARLAN
MARTIN

SCOTT MICHAEL,
MARTIN

MICHELLE ELAINE
MARTIN

BERNICE CAROL
MARTIN

Children of Bill & Debbie Martin:

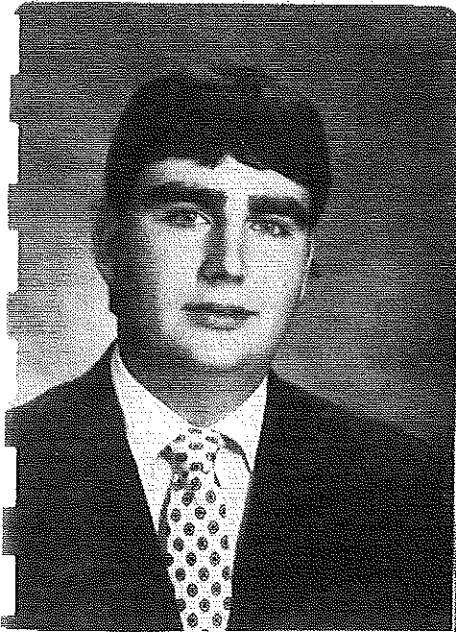

WILLIAM LEE
MARTIN

HEATHER ALANE
MARTIN

BENJAMIN RYAN
MARTIN

SHALON RENEE
MARTIN

Children of Cliff & Debbie Peetz:

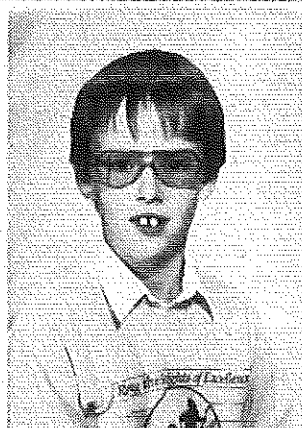
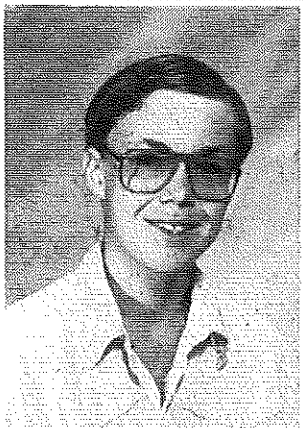

MICHAEL DAN
PEETZ

ANTHONY STEVEN
PEETZ

ELISHA NICOLE
PEETZ

MARGARET JOSEPHINE
PEETZ

Rosie (Dwenger) and Herald Powers

Roselia Cecilia Dwenger was born on Feb. 21, 1927 in Decatur County Indiana. She was the daughter of Harry J. and Mary (Hessler) Dwenger. Rosie was one of ten children: Kathy, Esther, *Rosie, Ruthie, Anne, Dick, Leonard, Mary Ellen, Eddie. Rosie met Harold Eugene Powers at the skating rink in Greensburg. They were married on Aug. 25, 1951, at Decatur County Indiana. They were members of the St. Marys Catholic church.

Harold was the son of Harry and Mabel (Redd) Powers, of Greensburg, in Decatur Co. He grew up in the town of Greensburg. He was also from a large family, mostly of boys, one sister, Carman Francis.

Harold and Rosie Powers lived in the town of Greensburg, where Harold was employed by the street Dept. of Greensburg for 14 years. Harold joined the Catholic church in 1952. They owned a home on S. Franklin St. in Greensburg, but the house is no longer standing.

Herald Powers passed away on Dec. 25, 1968 in Decatur Co. Rosie worked for many years at Randall Co. in Greensburg. Rosie and Herald were the parents of 11 children:

Mary Rose Powers was born on May 9, 1968. She was married to John Brogan on Oct. 14, 1972. John was born on Dec. 26, 1944. She was married the second time May 23, 1987. Mary Rose and John Brogan were the parents of four children, 1. Daniel Eugene b/March 28, 1971, 2. David Scott b/May 23, 1972. 3. Shirley Ann b/June 5, 1974, 4. Jennifer Denise b/July 2, 1975

Mabel Katherine (Kay) Powers was born on Aug. 20, 1953. She was married on June 3, 1971, to William (Bill) Yorn. They were the parents of four children, 1. William Yorn Jr. b/May 22, 1970, 2. Nicholas Eugene Yorn b/Jan. 26, 1972, he married Michelle Burchett on Feb. 14, 1989, they had a child: Nina Nichole b/May 21, 1989. They were later divorced. 3. Laura Kay Yorn b/Aug. 25, 1974. She had a child, Kayla Richelle b/Feb. 22, 1992. 4. Thomas Edward Yorn was born Aug. 25, 1975.

Susan Marie Powers was born on Nov. 12, 1954. She was married on June 27, 1970 to Casper Wilmer. Casper was born on March 2, 1950. They reside in Decatur Co. They were the parents of three children: 1. Karen Marie Wilmer b/Sept. 26, 1970, She has two children, a daughter Elizabeth Marie b/April 25, 1990, and a son Christopher Michael Fleener b/Oct. 7, 1991. 2. Casper Wilmer III, b/Sept. 23, 1971, 3. Joyce Lynn Wilmer b/Dec. 3, 1974.

Harold Anthony (Tony) Powers, was born on Jan. 13, 1956. He married Narita Ruble on May 9, 1975. They had two children: 1. Steve Ruble Coblentz b/Dec. 21, 1974, [Steve had a child, Dustin Michael Coblentz in ©? 2, 1992.] 2. Angela Renee b/May 5, 1976. Tony and Narita were divorced. Tony married Connie Wagner (Suitor), May 2, ©?, Feb 14, ©?. She had Tonya Sue b/Nov. 21, 1978, her name was changed to Powers.

Donald Charles Powers was born on May 30, 1958 at Greensburg Indiana. He was married to Joanne Dyer in Oct. 1978. They had two children; 1. Donald Charles Jr. b/Nov. 1, 1979. and 2. Kelly Eugene b/July 15, 1982. • Ray Joseph Powers was born on June 8, 1959. He was married to Ritha Roeder on Dec. 8, 1979. They had a son Aaron Michael Powers b/April 5, 1980. Ray and Ritha were divorced. Ray had a daughter, Lindsay Dawn, born on Dec. 7, 1991, to Ray and Virginia Adkins.

Rita Joan Powers was born on June 8, 1959 at Greensburg Indiana, in Decatur Co. She is the mother of four children: 1. David Ray b/Aug. 7, 1977, 2. Harold Arthur b/Jan. 7, 1979. 3. Katrina Dawn b/June 28, 1980, 4. Pamela Lynn b/Sept. 22, 1983. Rita presently resides in Decatur Co. Indiana.

Harry Arthur (Art) Powers was born on Aug. 21, 1960. He was married on Jan. 19, 1980 to Christine Salce, who was born on Oct. 17, 1960. Art has five children: 1. Jamie Lynn Ruble b/Jan. 4, 1978 (adopted) © 2. Leo Brad b/Nov. 3, 1979, 3. Tonya Faye b/Aug. 19, 1980, 4. Stacy Michelle b/Feb. 25, 1984, 5. Shannon Lynn b/Nov. 12, 1986.

Angela Marie Powers was born on July 25, 1962. She was married on Aug. 4, 1984 to David Lee Miller b/July 31, 1959. They are the parents of four children: 1. Amanda Rose Powers b/Sept. 9, 1980, 2. Chastity Marie Powers b/Sept. 25, 1981, 3. David Lee Miller Jr. b/Dec. 25, 1984. 4. Brandi Lynn Miller b/June 9, 1986.

Dorothy (Dot) Lynn Powers was born on June 13, 1964 at Greensburg In. in Decatur County. She was married on May 11, ©? to Ricky Perkins b/June 3, 1964. She has a son: Robert Ray Powers b/March 14, 1980.

Andrew Michael Powers was born on Jan. 12, 1967 at Greensburg In. in Decatur Co. He was married on April 7, 1990 to Dawn Louise Miller who was born on Jan. 3, 1968.

Jacob William Powers was born on May 21, 1968 at Greensburg Indiana, in Decatur County. He was married in Feb. of 1990 to Pam Collins. They had a son Jacob William Powers Jr. b/Sept. 4, 1990. Jacob and Pam are divorced.

CHARLES AND RUTH(DWENGER) HAMILTON

Ruth Elenora Dwenger was born May 27, 1928 in Decatur County. She is the daughter of Harry and Mary (Hessler) Dwenger.

Harry Dwenger was born February 19, 1898 in Franklin County and passed away January 6, 1966. Mary (Hessler) Dwenger was born November 17, 1900 in Decatur County. She resides in Odd Fellows Home in Greensburg, Indiana. Ruth was one of ten children. Her sisters and brothers are as follows:

Kathleen (Dwenger) Schiedler
Esther (Dwenger) Martin
Roselia (Dwenger) Powers
Anna Mae (Dwenger) McCullough
Richard Dwenger
Betty (Dwenger) Harris
Leonard Dwenger
Mary Ellen (Dwenger) Veerkamp
Edward Joseph Dwenger

I attended Lehman School in Decatur County, which was a one room school house with all eight grades in one room. I graduated from the eighth grade in 1942. I met Charles Herman Hamilton at St. Dennis Church around 1940. Charles was born May 13, 1926 in Decatur County, Greensburg, Indiana. He was reared in Cincinnati, Ohio. He was the son of Elbert F. Hamilton and Mary (Herman) Hamilton. Elbert was born May 11, 1900 and passed away March 20, 1978. He was the son of Clem Hamilton and Barbara (Pfiefer) Hamilton of Decatur County. Mary was born February 13, 1901 in Decatur County and passed away September 19, 1983. She was the daughter of Henry and Catherine (Lohman) Herman.

Charles was one of four children his sisters and brother are as follows;

Mildred (Hamilton) Woods
Donald Hamilton
Lois (Hamilton) Zang

Ruth and Charles are the parents of twelve children;

	(Born)	(Married)
Marilyn Martha (Hamilton) Peetz	5-6-48	7-27-68
Catherine Ann (Hamilton) Stier	7-23-50	4-17-71
Charles William Hamilton	10-17-51	8-31-91
Chuck married to Cindy Reasnor		12-22-72
James Donald Hamilton	2-10-54	7-15-78
Linda Kathleen (Hamilton) Ortman	7-21-55	7-9-77
Barbara Rose (Hamilton) Mattox	8-10-57	9-18-76
Helen Marie (Hamilton) Schutte	12-1-58	8-23-80
Philip Richard Hamilton	3-27-60	1-25-92
Carol Marie (Hamilton) Reed	1-27-63	8-1-87
Joyce Elizabeth (Hamilton) Ricke	5-23-64	3-9-91
Dale Joseph Hamilton	7-11-65	
Joseph Leo Hamilton	5-16-67	10-21-89

Charles and Ruth were married June 3, 1947 at St. Denis Church in Jennings County. Charles worked for Ashley Machine Co. in Greensburg, IN. for forty one years. Ruth is a home maker and Mother and is presently employed part time at Minears in Greensburg. Charles is retired and does a little farming.

We reside at: 8301 South County Rd. 200 E.
Greensburg, Indiana 47240

We attend Immaculate Conception Catholic Church in Millhousen where we have lived for forty years.

The Hamilton grandchildren are as follows:

		(Born)
John and Marilyn Peetz	Amanda	1-4-77
	Julie Ann	7-19-80
Marvin and Ann Stier	Angela	5-20-72
	Mark	8-8-76
	Patrick	9-5-77
	Kevin	2-8-82
	Paul	3-31-84
Chuck and Cindy Hamilton	Jeff	1-29-75
	Jenny	4-6-78
Chuck and Diana Hamilton	Jason	6-24-86
	Jordan	3-12-91
James and Susan Hamilton	Renae	12-1-81
	Natalie	11-18-84
	Samuel	8-2-88
Gary and Linda Ortman	Eric	8-27-79
	Melissa	6-11-81
	Deron	7-9-83
	Clint	9-19-77
Gregg and Barbara Mattox	Andy	4-9-80
	Staci	9-10-84
	Jake	11-16-92
	Nicholas	2-16-81
	Amy	7-2-83
Philip and Karen Hamilton	Emily McAdams	8-14-83
	Jeremiah McAdams	4-11-85
	Nacole	5-26-92
Todd and Carol Reed	Lauren	12-24-91
	Jamie	5-25-93
Bob and Joyce Ricke	Erica	1-5-83
	Elizabeth	11-11-86
	Logan	2-19-92
Joe and SuAnn Hamilton	Colton	1-21-91
	Ethan	8-27-92



ROW 1 L. to R. (sit.): Marilyn Pectz, Charles and Ruth Hamilton, Ann Stier, Carol Reed
ROW 2 L. to R.: Dale Hamilton, Helen Schutte, Linda Ortman, James Hamilton, Joyce Ricke, Joe Hamilton, Barb Mattox, Philip Hamilton, Chuck Hamilton.

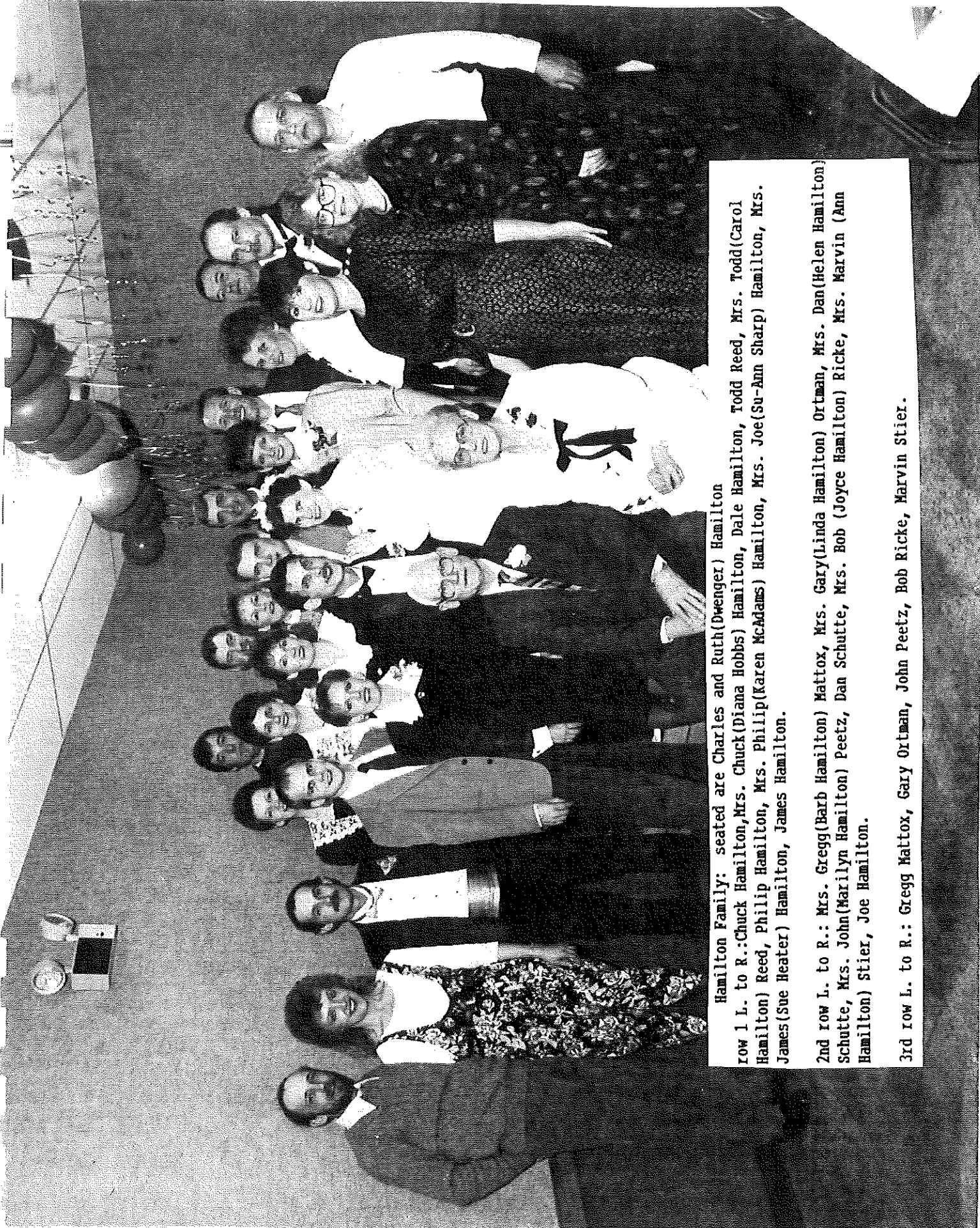

Hamilton Family: seated are Charles and Ruth (Dwenger) Hamilton
 Row 1 L. to R.: Chuck Hamilton, Mrs. Chuck (Diana Hobbs) Hamilton, Dale Hamilton, Todd Reed, Mrs. Todd (Carol Hamilton) Reed, Philip Hamilton, Mrs. Philip (Karen McAdams) Hamilton, Mrs. Joe (Su-Ann Sharp) Hamilton, Mrs. James (Sue Heater) Hamilton, James Hamilton.
 2nd row L. to R.: Mrs. Gregg (Barb Hamilton) Mattox, Mrs. Gary (Linda Hamilton) Ortman, Mrs. Dan (Helen Hamilton) Schutte, Mrs. John (Marilyn Hamilton) Peetz, Dan Schutte, Mrs. Bob (Joyce Hamilton) Ricke, Mrs. Marvin (Ann Hamilton) Stier, Joe Hamilton.
 3rd row L. to R.: Gregg Mattox, Gary Ortman, John Peetz, Bob Ricke, Marvin Stier.

JOHN AND MARILYN (HAMILTON) PEETZ

Marilyn Martha Hamilton was born at Decatur County Memorial Hospital in Greensburg Indiana on May 6, 1948. I am the oldest of twelve children born to Charles Herman Hamilton and Ruth Elenora (Dwenger) Hamilton. My sister and brothers are as follows:

	(Born)
Catherine Ann (Hamilton) Stier	7/23/50
Charles William Hamilton	10/17/51
James Donald Hamilton	2/10/54
Linda Kathleen (Hamilton) Ortman	7/21/55
Barbara Rose (Hamilton) Matttox	8/10/57
Helen Marie (Hamilton) Reed	12/1/58
Philip Richard Hamilton	3/27/60
Carol Marie (Hamilton) Reed	1/27/63
Joyce Elizabeth (Hamilton) Ricke	5/23/64
Dale Joseph Hamilton	7/11/65
Joseph Leo Hamilton	5/16/67

I attended Immaculate Conception Grade School in Millhousen, Indiana for eight years. There were three grades taught in one room, and there were only ten kids in my grade. I was in 4-H and later became a Junior Leader. I did babysitting for \$.50 an hour and cleaned the church with my sister Ann for a little money.

I attended High school at Jac-Cen-Del in Osgood, Indiana for four years. This is where I met my husband John Douglas Peetz. We both graduated in May of 1966. After High School I worked as head cashier for the telephone company in Greensburg, In. for two years. John went to electronics school at Southeastern Indiana Vocational School in Versailles, Indiana for two years.

We were married July 27, 1968 and moved to Cincinnati, Ohio for three years. John was an electronics technician for Nutone and I worked for Kenner Toys and Picks Reed Furniture, in the Office. We then moved back to Indiana and bought our first farm on which we now reside. We are located on state road 421 between Osgood and Napoleon.

John was born January 28, 1948 at Margaret Mary Community Hospital in Batesville, In. He was the only child born to Clyde Carol Peetz and Margaret Mary (Klusman) Peetz. Margaret was born December 20, 1919, she is also an only child. Clyde was born January 20, 1912 and passed away December 16, 1991. He was one of ten children. His sisters and brothers are: 1. Esther Marie (Peetz) Robins; 2. Alta Mae (Peetz) Brunner; 3. Irvin Edward Peetz; 4. Bernice Ruybe (Peetz) Young; 5. Hazel Irma (Peetz) Deters; 6. Crystal Oma (Peetz) Eisert; 7. Dorothy May (Peetz) Molen; 8. Merle Louis Peetz; 9. Leora Virginia (Peetz) Walters.

John attended six years at Napoleon Elementary and then went to J-C-D in the seventh grade. We had a son Douglas Allen Peetz born Nov. 11, 1968 and passed away the same day. We also have two daughters, Amanda (Mandy) Lynn born Jan. 4, 1977 and Julie Ann born July 19, 1980. They were both born at Decatur County Memorial Hospital in Greensburg, In. They both attend Jac-Cen-Del School in Osgood, Ind.

We have been farming full time since 1971. John drove a school bus for Jac-Cen-Del Schools for eight years after we moved back to Indiana. I then went to Southeastern Indiana Vocational School and took Cosmetology. I have been employed at Little Charm Beauty Salon since 1972. We both work at our farming business. We farm about 1100 Acres of corn and soybeans and farrow to finish about 6,000 hogs a year. We enjoy camping and being together.

ANN (HAMILTON) STIER

Catherine Ann Stier was born on July 23, 1950 at Greensburg, In. in Decatur Co. She is the daughter of Charles H. and Ruth (Dwenger) Hamilton. Charles was born on May 13, 1926 and Ruth was born on May 28, 1928. Ann is one of twelve children. Marilyn (Hamilton) Peetz is the first, born May 6, 1948. Ann follows next in line, then Charles W. Hamilton, born on Oct. 17, 1951, followed by James D. Hamilton, born Feb. 10, 1954. Linda (Hamilton) Ortman born July 21, 1955, Barbara (Hamilton) Mattox born Aug. 10, 1957, Helen (Hamilton) Schutte born Dec. 1, 1958, Philip Hamilton born March 27, 1960, Carol (Hamilton) Reed born Jan. 27, 1963, Joyce (Hamilton) Ricke born May 23, 1964, Dale Hamilton born July 11, 1965 and Joseph Hamilton born May 16, 1967.

Ann attended Millhousen Catholic School grades 1 thru 8 then went to Sandcreek High School and graduated in 1968. Hobbies include bowling and golf. Ann met Marvin Stier who is the brother of my girl friend all thru school. He was in Viet Nam during my high school days so I really didn't get to know him, until the summer of 1968. We were married April 17, 1971 at St. Marys in Greensburg. Marvin was born March 22, 1946 at Greensburg. His parents are Ed. and Marie Stier. Ed was born Oct. 22, 1907 and passed away Dec. 26, 1982. Marie was born June 27, 1917. Marvin is one of 8 children and is the third oldest. His brother and sisters are Gary, Kenny, who passed away Sept. 28, 1988, Carl, Eileen Richardson, Janet Bledsoe, Steve, and Kathy Kohrman. Marvin enjoys fishing, golfing, and raising cattle in the spring thru the fall.

Marvin and Ann are the parents of five children; Angela Lyn who was born May 20, 1972; Mark James who was born August 8, 1976; Patrick Charles who was born on Sept. 5, 1977; Kevin Edward who was born on Feb. 8, 1982; Paul Joseph who was born on March 31, 1984; All the children were born in Greensburg, In.

Angie is attending Marion College in Indianapolis, and will graduate in May 1994 with a Bachelor degree in Elementary Ed. and a minor in computers. Marvin works at Cummins Engine in Columbus, In. and Ann works at James River in Greensburg. Marvin and Ann are currently residing at 2378 E. Co. Rd. 700s. Greensburg, In. which is actually a mile and a half north of Millhousen.

JOSEPH AND SUE-ANN (SHARP) HAMILTON

Joseph Leo Hamilton was born on May 16, 1967 at the Decatur County Hospital, Greensburg, IN. He was the son of Charles and Ruth Hamilton (Dwenger). He was one of twelve children. He attended South Decatur Schools, which he graduated from in 1986. He is now completing Carpenter's Apprenticeship programs and is employed with Burns & Gutwiller.

Joe married Su-Ann Hamilton (Sharp) on October 21, 1989. She was born in Clinton County in Frankfort, Indiana on June 24, 1967. She is the daughter of Tom and Mary Jane Sharp (Wyrick), also born in Clinton County. Su-Ann was one of two children. She is employed with Paul R. Nahmias, D.D.S. as a dental assistant and is now attending the Expanded Function Assistant Course at the I.U. School of Dentistry.

Joe and Su-Ann Hamilton are the parents of two children. They are Colton Leo Hamilton, born Jan. 21, 1991 and Ethan Thomas Hamilton, born Aug. 27, 1992.

Joe and Su-Ann Hamilton are currently residing at 6758 S. County Rd. 225 E., Greensburg, Indiana 47204.

JAMES D. AND SUSAN(HEATER) HAMILTON

James Donald Hamilton was born on Feb.10,1954 at Greensburg, in Decatur County, Indiana. He is the son of Charles and Ruth (Dwenger) Hamilton. He is one of twelve children. His family were members of the Immaculate Conception Catholic Church in the town of Millhousen, Indiana where they lived.

James attended the Millhousen Catholic School, grades 1-8 1968. He attended the South Decatur High School in grades 9-12; and graduated in 1972.

He was married to Susan Kay Heater on July 15,1978 in Decatur Co. Indiana. Susan Kay was born on Jan.28,1955 in Grant County, Indiana. She is the daughter of Eldon Gene Heater and Alice Ruth (Comer) Heater. She was one of three children; Susan Kay Heater, Gary Eldon Heater, Sara Ruth (Heater), David, Susan attended Madison Grant United School Corporation at fairmont, Indiana grade 1-12. She graduated in 1973. She attended Purdue University-BA- from 1973 to 1977; and Indiana University -MA- 1984.

James and Susan live on Millhousen Road in Decatur County in Indiana. They are the parents of three children, all born at the Bartholamew County Hospital, at Columbus Indiana. 1.Renae Jessica Hamilton, born on Dec.1,1981 2.Natalie Dawn Hamilton, born Nov.18, 1984 3. Samuel James, born Aug.2,1988. James and Susan Hamilton presently reside at 3333 S.60 East Greensburg, In.47240.

Linda Kathleen (Hamilton) and Gary Ortman

Linda Kathleen Hamilton was born on July 21, 1955 at Decatur County Memorial Hospital in Greensburg, Indiana. She was the daughter of Charles and Ruth Hamilton. She was one of Twelve children. They were; Marilyn, Ann ,Charles, James, Linda, Barbara, Helen, Philip, Carol, Joyce, Dale and Joe.

Linda attended Millhousen Catholic School for eight years then graduated from South Decatur High School in 1973. She attended Purdue University for four years graduating in 1977, receiving a Bachelor of Science degree in secondary education in mathematics. She later earned a Masters degree in education from IUPUI in Columbus, Indiana.

Linda married Gary Frank Ortman in Millhousen on July 9, 1977. Gary was born Jan.22,1949 in Decatur County Memorial Hospital in Greensburg, In. He was the son of Sylvia Fry, born March 8,1913, and Frank Ortman, born June 10,1907. Gary was one of seven children. They were Carol Hermesch,Dale Ortman, Mary Jane Buening,Patricia VanDorn, Gary Ortman, Susan McPherson, and Debbie Vanderbur.

Linda currently teaches sixth, seventh,and eighth grade math at St.Louis School in Batesville, Indiana. Gary is a loan officer at Fifth Third Bank in Batesville, Indiana.

Linda and Gary Ortman are the parents of three children. They are;Eric James Ortman, born Aug.27,1979; Melissa Lynn Ortman born June 11, 1981; and Deron Charles Ortman, born July 9,1983. The Gary Ortman family currently resides at 70 South Oak Court in Greensburg, Indiana.

Daniel and Helen(Hamilton)Schutte

Helen Marie Elizabeth(Hamilton)Schutte was born on 12-1-58 at Decatur County Memorial Hospital in Greensburg In. She was the Daughter of Charles and Ruth Hamilton. She was one of 12 children, Marilyn, Ann, Charles, James, Linda, Barbara, Philip, Carol, Joyce, Dale, Joseph. Helen attended 1-6 years of school at Immaculate Conception School in Millhousen. Attended grades 7-12 at South Decatur High School. Helen graduated from South Decatur in May 1977. Helen met Daniel Jon Schutte at a party. Daniel was born on 9-7-58 at Decatur County Memorial Hospital in Greensburg In. Daniel was the son of Raymond and Irene Schutte. Daniel was on of 7 children, Raymond Lee, David, Donald, James, Marijean, Karen.

Helen and Daniel are the parents of 2 children, They are Nicholas Jon born 2-16-81 and Amy Lynn born 7-2-83. Helen and Daniel are currently residing at 4629 S. Co. Rd. 20W. Greensburg Indiana.

Gregg L. and Barbara R.(Hamilton)Mattox

Barbara R. Hamilton born on Aug. 10, 1957 at Decatur County Memorial Hospital Greensburg In. She is one of twelve children. They are; Marilyn Peetz; Ann Stier; Chuck; James; Linda Ortman; Helen Shutte; Philip; Carol Reed; Joyce Ricke; Dale & Joe. Barbara attended Immaculate Conception through the eight grade and went on to South Decatur High School and graduated in 1975.

She married Gregg L. Mattox on Sept. 18, 1976. Gregg is one of three children. Connie Raines, and Kerry Mattox. He was born in Bartholomew County Hospital, Columbus In. Together they have four children. They are Clint Michael born; September 19, 1977 Andy James born; April 9, 1980; Staci Lee born September 10, 1984; Jacob Charles born November 16, 1992. Barbara is the daughter of Ruth and Charles Hamilton. Gregg is the son of Ruth and Ray Mattox. They now reside at 7638 West County Road 850 south Greensburg In.

Philip & Karen(McReynolds)Hamilton

Philip Richard Hamilton was born March 27, 1960 at Decatur County Memorial Hospital in Greensburg, Ind. He is the son of Charles H. and Ruth E. (Dwenger) Hamilton. Philip has four brothers Charles James, Dale, and Joseph. He has seven sisters; Marilyn Peetz; Ann Stier; Linda Ortman; Barb Mattox; Helen Schute; Carol Reed; Joyce Ricke.

Philip was a 1978 graduate of South Decatur High School. He enjoys farming, bowling, golfing, and spending time with his family. On Mar. 23, 1991 Philip was reacquainted with a girl from his teen years, Karen E. McReynolds. On Jan. 25, 1992 the two of them were married. Karen was born Dec. 4, 1961 at Decatur County Memorial Hospital. She is the daughter of Kenneth O. and Geraldine A. (Owens) McReynolds. Karen is the only girl of five kids. Her brothers are Michael, Steven, Darrell (Tom), and James. She enjoys reading, writing, art, and being with Philip and the children. Philip and Karen have a daughter Nacole Elaine, born on May 26, 1992. Karen has two children from a previous marriage, Emily Rene and Jeramiah David McAdams, Emily will be 10 in Aug. and Jeramiah will be 9 Apr. of '94. August of '93 Philip and Karen had a daughter, Kristy Lynn Hamilton, who was born on Aug. 4, 1993. Philip and Karen are presently residing near Westport, In.

Carol Marie Hamilton, was born on January 27, 1963 at Decatur County Memorial Hospital, Greensburg, Indiana. She is the daughter of Charles and Ruth Hamilton of Millhousen. She is the 9th of 12 children. Marilyn Hamilton Peetz, Ann Hamilton Stier, Chuck Hamilton, James Hamilton, Linda Hamilton Ortman, Barbara Hamilton Mattox, Helen Hamilton Schutte, Philip Hamilton, Joyce Hamilton Ricke, Dale Hamilton and Joseph Hamilton. Carol attended South Decatur High School and graduated in 1981. She earned her pilots license May of 1990 . She enjoys flying, golfing and spending time with her family.

Carol married her husband Todd Taylor Reed August 1, 1987. He was born August 15, 1962 at Decatur County Memorial Hospital. Todd is the son of Richard C. and Louise Reed also from Greensburg. He is one of 3 children. Bradley Richard Reed and Brian F. Reed. Todd attended Greensburg High School and graduated in 1980 and from Purdue University in 1984. He returned to Greensburg, Indiana and joined the family company Kova Fertilizer an agribusiness, with corporate office in Greensburg, Indiana. Todd earned his pilots license in 1984 while attending Purdue, and is corporate pilot for family business. He enjoys flying, photography, music and golf.

Carol and Todd currently have two children. Lauren Carol Reed, born December 24, 1991, and Jamie Marie Reed, born May 25, 1993.

Joyce Elizabeth Hamilton was born on May 23, 1964 at the Decatur County Memorial Hospital in Greensburg, Indiana. Daughter of Charles and Ruth Hamilton. Joyce is one of 12 children. Marilyn, Ann, Chuck, James, Linda, Barb, Helen, Philip, Carol, Dale and Joe.

I attended South Decatur elementary and high school and graduated on May 23, 1982.

My husband is Bob Ricke born August 17, 1957 at the Margaret Mary Hospital in Batesville, In. Bob is the son of Clifford and Anna Mae Ricke. Clifford Franklin Ricke was born November 23, 1929 and Anna Mae (Hauert) Ricke was born February 13, 1932. Both parents are still living. Bob is one of six children. Mary Ann (Ricke) Davidson, Deborah Marie (Ricke) Ericson, Mark Clifford Ricke, John David Ricke, Renee Elizabeth (Ricke) Hellmich.

Bob and Joyce were married March 9, 1991. We have one son Logan Robert Ricke, born February 19, 1992. We are expecting our second child at the end of July 1993.* Bob has two daughters from a previous marriage, Erica Ricke born January 5, 1983 and Elizabeth Ricke born November 11, 1985. The girls are residing with us at our home in Clarksburg, In.

* Julia Elizabeth Ricke was born on July 20, 1993

Mr. and Mrs. Robert Ricke
7189 E. Co. Rd. 640 N.
Greensburg, In. 47240

Martha Elizabeth (Betty) and Frank (Ed) Harris Family

Martha Elizabeth (Betty) Dwenger was born June 27th, 1933 at Tarkyo, Decatur County, Indiana. Tarkyo no longer exists, but it was down the road going left from Cobb's Fork - headed from Millhousen to Greensburg. She is the daughter of Harry and Mary Dwenger. She is one of ten children listed elsewhere in this book. Betty attended Lehman School, a 1 room schoolhouse, for 8 years then Napoleon High School for 2 years. At age 16, she quit school and got a job keeping house. Later in a grocery store, the chicken factory in Greensburg, and RCA in Indianapolis. She got a GED diploma in 1969. Hobbies include crocheting, reading and grandchildren. Betty met **Frank (Ed) Harris** (Born 12-4-1930) while in grade school. He also went to a 1 room school, Deganhart. As Betty recalls, "Our school played his in baseball and they beat us bad. He was so much bigger than all of the Lehman school kids, but I thought surely we'd win as my father was the referee, however, he called it fairly and we lost the game."

"Met him again in high school and dated a couple of times. Then started dating him again after I was 18. We were married on December 27th, 1951." He was 21 when they wed, she was 18. He spent 2 years in the U.S. Marine Corps from January 1952 until his honorable discharge in January 1954. Spent most of his time in California and Japan. He is the son of Jacob and Thelma Harlan Harris. He has 2 sisters and 1 brother living, 2 brothers and 1 sister dead. Surviving sisters include Norma Jean Martin of Greensburg, Indiana and Anna Belle Harrison of Prattsville, Arkansas. Surviving brother is Bill Harris of Seagaville, Texas.

Betty and Ed have 7 children: (Oldest to youngest) : Juanita Marie - Frank (Eddie) Edmund Jr. - Richard John - Lawrence Joseph - Kenneth Eugene - Cynthia Louise Waltermire - Gregory Wayne.

Betty and Ed are both retired from Muscatatuck State Developmental Center in Butlerville Indiana, and are currently residing at Nebraska, Indiana.

Juanita Marie Harris: Born: December 29th 1952 at Camp Pendelton, California. She is the Daughter of Ed and Betty Harris. She started school at Zenas grade school, and later transferred to St. Mary's Grade School in North Vernon. She spent 6 months of her 7th grade in Adams school in Decatur County Indiana then back to St. Mary's in North Vernon. She attended North Vernon High School for 1 year then the Jennings County High School the remaining 3 years until graduating. She also attended Versailles Vocational School while in high school. She became employed at Muscatatuck State Developmental Center for 7 years. Juanita resigned from MSDC and began her training for R.N. at Park View Nursing School in Fort Wayne, graduating in May, 1981. She has since been employed at Community Hospital East in Indianapolis as an RN on night shift. Juanita lives in Indianapolis near the hospital. Her hobbies include Ball-room dancing, swimming, water arobics, tennis, and she has graduated from clown school in 1993.

Frank Edmund (Eddie) Harris Jr.: Born: November 29th, 1953 at Camp Atterbury Indiana. He is the second child, a son of Ed and Betty Harris. He attended St. Mary's School in North Vernon, Indiana for 8 years with the exception of 1/2 year at Adam's School in Decatur County, Indiana. Frank attended Jennings County High School and graduated in 1972. He also went to Versailles Vocational School while at JCHS. He holds an Associated degree in robotics, a certificate in Wastewater treatment and is a qualified electrician. He met Elaine Walker in high school and married her on June 27th, 1973. Of this union were 2 sons, Shawn Edmund and Chad Everett. Frank and Elaine were divorced in November 1981. Frank now resides in Versailles Indiana. Frank as a small child was referred to as "Eddie". Frank is currently employed as an electrician at Muscatatuck State Deveolpmental Center in Butlerville, Indiana.

Shawn Edmund Harris: Son of Frank Edmund Harris Jr. and Elaine Walker Harris. Born May 12, 1973 at Columbus Indiana. He attended St. Mary's Grade School and Jennings County High School, Graduating May, 1991. He is presently employed at the Wal-mart Distribution Center in Seymour, Indiana. **Chad Everett Harris:** Son of Frank Edmund Harris Jr. and Elaine (Walker) Harris. Born March 12, 1974 at Columbus Indiana. He attended St. Mary's Grade School and Jennings County High School. He is working this summer and getting ready for his 2nd year at Ball State University in Muncie, Indiana.

Richard John Harris: Third child of Ed and Betty Harris, a son born at Greensburg Indiana on May 1st, 1955. At that time the Harris's were living at R # 1 Rushville. Richard attended St. Mary's Grade School in North Vernon, Indiana, then Jennings County High School. In Febuary 1973, Richard quit school to join the Marine Corps. Although he had not graduated from high school, he did acquire his GED while in the military. During his 12 years in the Corps, Richard was stationed in many duty ports throughout the world. He met Melanie Ritchie (Born 12-25-1953) while in high school and they were married on MArch 25th, 1973. This union netted them three girls; Katina Michelle, Liana Jade deceased and Kari Marie. Richard is employed as a civil servant at the Cherry Point Naval Rework Facility in North Carolina, where he spent much of his marine career

Katina Michelle Harris was the first daughter of Richard John Harris and Malanie (Ritchie) Harris. Born at Memphis Tennessee on July 10, 1973. She has graduated from high school and presently has a job. **Liana Jade Harris** was the second daughter of Richard John Harris and Malanie (Ritchie) Harris. Born at Cherry Point, North Carolina, August 10, 1974 and Died August 17, 1974. She was laid to rest at the St. Mary's Cemetary at North Vernon, Indiana. **Kari Marina Harris** is the third daughter of Richard John Harris and Malanie (Ritchie) Harris. Born at Kaneohe Bay, Hawaii on December 24, 1978.

She is presently attending High School in New Bern, North Carolina where she lives with her family.

Lawrence Joseph Harris: The fourth child of Ed and Betty Harris. Born on August 19, 1956 at Greensburg Indiana. His parents moved with their children to Jennings County when Larry was 3 years old. He attended St. Mary's Grade School in North Vernon, and Jennings County High School in North Vernon Indiana. He also attended Versailles Vocational School while in high school. Larry joined the Marine Corps immediately after graduating from high school in 1974. Larry remained in the Marine Corps for 16 years. While in the service he met Jerri Lynn Coker at Yuma Arizona and married in 1979. Of this union was two girls; Jamie Roseann and Theresa Marie. Jamie and Theresa live in Yuma Arizona with their mother and stepfather. Larry and Lynn were divorced in June, 1989. Larry then met Lisa Bannister and they were married on May 22nd, 1993. From this union came 1 son, William Joseph Payne, Born in Columbus Indiana on July 18th, 1992. Larry and Lisa reside at R # 3 North Vernon Indiana. Larry is currently employed with Diamet in Columbus Indiana and is a member of the National Guard.

Jamie Roseann Harris was the first daughter born to Lawrence Joseph Harris and Jerri Lynn (Coker) Harris on November 20th, 1981 in Minneapolis, Minnesota. *Theresa Marie Harris* was the second daughter born to Lawrence Joseph Harris and Jerri Lynn (Coker) Harris on December 28th, 1982 in South Carolina.

Kenneth Eugene Harris: Their fifth child, born January 8, 1958 in Greensburg Indiana of Ed and Betty Harris. The family moved from Route #1 Rushville when Ken was 19 Months old. Kenneth attended St. Mary's Grade School in North Vernon for 5 years, Butlerville Elementary School for 1 year, North vernon Junion High school 2 years, and Jennings County High School. Kenneth joined the Marine Corps Reserve and left for 6 months training then returned to complete his five and one-half years in the reserve as well as his senior year. He met Barbera Jean Blevins in high school and married her on April 28, 1979. Two boys were born to this couple. Michael Robert and Dan Bernard. Both boys attended St. Mary's Elementary School in North Vernon. Michael will attend Jennings County Middle School while Dan will advance to the 5th grade. Barbera works as a housekeeper at Muscatatuck State Developmental Center in Butlerville Indiana. Kenneth is a truck driver for Stoop's. Ken and Barb live about 5 miles out of Butlerville in 'God's Country'. His mother says, "It's beautiful in the summer but hard to reach in the winter months."

Michael Robert Harris was born of Kenneth Eugene Harris and Barbera Jean (Blevins) Harris on November 8th 1980 at Seymour Indiana. *Daniel Bernard Harris* was born of Kenneth Eugene Harris and Barbera Jean (Blevins) Harris on August 20th 1982 at Seymour Indiana

Cynthia Louise (Harris) Waltermire: The sixth child and second daughter born to Ed and Betty Harris on May 2nd 1959, at Greensburg Indiana. Family moved to Jennings County when she was three months old. Cindy went to St. Mary's Grade School in North Vernon 5 years, then to Butlerville Elementary School for 1 year. She then attended North Vernon Junior High School for 2 years before moving on to the Jennings County High School for three years where she graduated. (At that time students were allowed to graduate as Juniors if they had enough credits. She met Benny Dean Kuntz at Junior High School and they were married on June 18th 1977 after she graduated from high school. Two girls born to them were Amanda Lynn and DeAnna Rose. Cindy and Ben were divorced in November 1984. Cindy married Ivan Poe Waltermire on August 19, 1989. From their union came a boy, Thomas Edmund. Cindy and Ivan also reside in 'God's Country' near the home of her brother Kenneth.

Amanda Lynn Kuntz was born to Benny Dean Kuntz and Cynthia Louise (Harris) Kuntz on March 27th 1981 at Columbus Indiana. She is looking forward to her 7th grade at St. MARY's Grade School in North Vernon Indiana when school begins in the fall. Amanda lives with her father and step-mother near Nebraska Indiana. *DeAnna Rose Kuntz* was born the second daughter of Benny Dean Kuntz and Cynthia Louise (Harris) Kuntz on November 13th 1982 at Columbus Indiana. She will be attending the 5th grade at St. Mary's Grade School in North Vernon Indiana. She lives with her mother and step-father near Nebraska Indiana. *Thomas Edmund Waltermire* was born to Ivan Poe Waltermire and Cindy Waltermire on December 15, 1987 at Columbus Indiana.

Gregory Wayne Harris: The seventh child from Ed and Betty born on the 22nd of July, 1960 at Greensburg Indiana. Greg attended St. Mary's Grade School in North Vernon for 4 years, Butlerville Elementary School for 2 years, North Vernon Junior High School for 2 years and 4 years at Jennings County High School. He also attended Versailles Vocational School while in high school. He joined the Marine Corps for four years immediately after high school. While in the Marine corps, Greg enjoyed the sights of England, West Germany, France, Spain, Portugaul, Italy, Greece, Norway, Tunisia and Kenya from the three Meditterean Cruises he embarked upon. Greg gained employment at Muscatatuck State Developmental Center in 1983 where he met Peggy Jo Stark whom he married on June 8th 1985. Greg and Peggy have 2 children; Chasity Louise and Matthew Wayne. Peggy is attending part time nursing training to become an LPN. Her calss will graduate in August 1993. Greg holds an Associates Degree in Computer Programming, Both work full time at Muscatatuck State Developmental Center in Butlerville Indiana. Greg and Peggy live south of North Vernon.

Chasity Louise Harris, the first child born to Peggy Jo and Greg Harris on November 23rd 1980 at Columbus Indiana. Chasity will be attending Jennings County Middle School as a 7th grader in the fall. *Matthew Wayne Harris* is the second child born to Peggy and Greg Harris on April 4th 1985 at Columbus Indiana. Matthew will be attending North Vernon Elementary School in the first grade this fall.



Frank Ed. Harris and wife
Elizabeth(Betty)Dwenger
December 27,1951

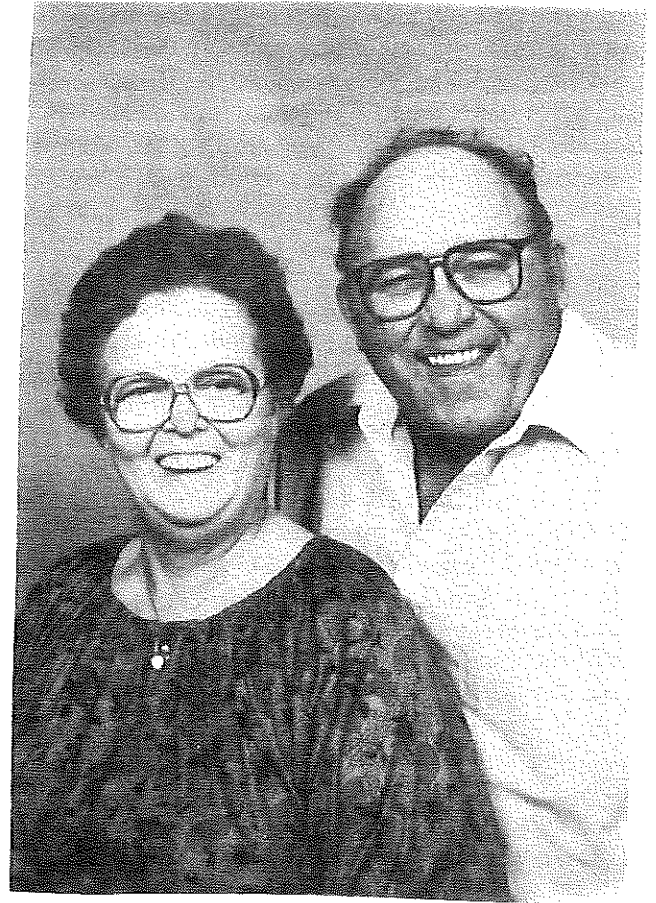

Ed and Betty(Dwenger)Harris



Harris family 1992
sitting:Cindy, Ed, Nita
stand:Ken,Rick,Betty,Gregg, Frank,Larry

JOHN DAVID AND ANNA(DWENGER) MCCULLOUGH

Anna Mary(Mae) Dwenger was born on Dec. 14, 1929, at the home of her parents, in Decatur Co. Indiana. She was the daughter of Harry J. Dwenger, born on Feb. 19, 1898 in Franklin Co. In, and Mary Cecilia (Hessler) Dwenger, born Nov. 17, 1901, at Millhousen Indiana in Decatur Co. She was one of ten children: Kathy(Schiedler), Esther(Martin), Rosie(Powers), Ruthie(Hamilton), Anna(self), Richard(Dick), Betty(Harris), Leonard, Mary Ellen(Veerkamp), Edward Joseph.

When Anna was a very young child her parents lived in a rented house, in Salt Creek twp. When she was about age five they moved into a home they had purchased in Decatur Co., near the St. Dennis Catholic church. This land was between Millhousen and Westport in Decatur County, but very near to the Jennings Co. line. They attended Catholic services at the St. Dennis Church.

When Anna was little she had a favorite doll. One day she had been outside playing with her doll, and had left it near the creek bed. It had begun to rain heavily, and she cried because her doll, (which she thought of as a real baby) would get washed downstream when the water rose. Her mother went out in the pouring rain and retrieved her precious doll bringing it safely back .

Back in those days there was no Kindergarten classes , and the nearest school was a one-room school house called Lehman school. Anna attended this school as she started first grade. They would walk a mile to and from school. When they got up in the morning the children all had chores to do before going to school. Anna would often have to get up, get dressed, go to milk the cows in the barn, and feed the chickens before walking the mile to school. She enjoyed school and did well there. She loved to read, and did so any chance she got. The school had one teacher for grades one through eight. If a child got their work done early they were allowed to sit quietly and read. Anna would take advantage of this. She graduated at the top of her eighth grade class. There were no inside toilets, but the school did have boys' and girls' outhouses behind the school building.

Because they lived out in the country there was no electricity in their home. On winter evenings the children did their homework around the kitchen table by the light of a coal oil lantern. Electricity finally made it into the country in 1945. Then there was one plug-in each room.

All of the children had chores daily to do around the house. Some of these chores were: dishes, cleaning, carrying in wood, and milking the cows every morning and evening. One chore which Anna seemed to get stuck with all the time was making the homemade bread, which had to be made every few days. She hated making the bread, but became very good at it. Although Anna was raised during depression times, they did not feel it quite so bad as some because they lived on a farm and grew a great deal of their own food. They canned and stored food from the garden every year. They also raised hogs and sheep for selling.

They had a fairly small house for their large family. The upstairs was divided into two rooms, one large room for the girls, and one small room for the boys. A wood stove was used sometimes in the winter to warm it a bit. The chores were usually done outside by the boys and inside by the girls, except milking the cows and feeding the chickens.

When Anna was a young girl her father taught each of the children to dance, and would take them to the many free dances of the time. He would dance the first dance with them to get them out onto the floor, then the boys would see that they danced and would ask them to dance.

Anna's parents, Mary and Harry Dwenger also would sponsor baseball games on Saturdays. All the boys from the neighborhood would come to play. Her mother made homemade donuts, and homemade root beer (made from sassafras

tree roots). Everyone had a good time.

When Anna was fifteen she had her tonsils taken out. She had been repeatedly sick with bad sore throat, and after the money was saved to pay for it, they were taken out at Greensburg. The Sunday after she had returned home she and her brother, who also had his tonsils out, were left at home while the family left for church. Anna had coughed and broken some stitches, she was not worried, it seemed no worse than a nose bleed, but it didn't stop. When her parents returned she wasn't feeling well and the bleeding had continued. She went to her mother, explaining what had happened. Her father went to get the car to take her into Greensburg, while her mother tried to clean her up a bit. She remembered seeing her mother crying, she wasn't really sure why. She didn't feel real sick. They took her to the Greensburg hospital, her father asked her if she needed help getting in, but she said no, she could walk alright. She took a few steps and then passed out. She had broken her stitches and had hemorrhaged. Her mother told her later that she had been really scared that they might lose her because the bleeding was so bad. But everything turned out fine.

Anna graduated the eighth grade from the Lehman school. That was as far as it went, and if a person wanted to go on to high school it cost extra. Her parents couldn't afford it, so Anna got a job in Cincinnati as a maid for rich people. It included room and board, and she came home to visit on weekends. She and her sisters traveled back and forth to Cincinnati, Ohio, on the train. When she was twenty she and some friends traveled to Texas. They had jobs as waitresses. Often their one meal was the free meal they received at their work. She returned to Indiana a few pounds slimmer for that trip.

There was a skating rink on Main Street in Greensburg, it is still being used today. It was at this skating rink that she was introduced to a brother of her sister's boyfriend, John David McCullough. He had seen her, and asked his brother to introduce them. They met and began at first to ride into work together, as they both were working at Indianapolis, and had a long drive. They became engaged shortly after, and were married at the St. Dennis Catholic church on August 16, 1952.

John David McCullough was born on March 17, 1929, at Westport, Indiana. He was the son of James (Simon) b/Nov. 12, 1890 at Westport, In. and Mabel (Tanner) McCullough b/Sept. 16, 1897 at Milner, North Dakota. He was one of 12 children: James, Don, Ralph, Vernon, Harold, Mary Ellen(Perkins), John D.(self), Arthur, Sydna Ann(Mozingo), Marian Francis(Fox), Ernest, and Joe. John graduated the 12th grade from the Westport High School in 1948. He was a member of the Westport Baptist Church. (For more information on McCullough's see the "Our McCullough History", Book in the Greensburg Library, Greensburg, Indiana.) John David loved farming and hoped one day to own a farm of his own.

John and Anna McCullough first set up housekeeping in Indianapolis, as this was where their jobs were. Anna had a job in an RCA factory making radio tubes. Both Anna and John wanted children (Anna said she had wanted 12). Anna became pregnant soon after their marriage, they had a baby girl, stillborn, July 16, 1953. Anna felt devastated, and was afraid she wouldn't be able to have any more children. Anna and John opened a small grocery store next to their home, which worked well. Anna helped in the store, John continued to work in the factory. Anna became pregnant once more, and at this time she decided to quit work and stay home. Donna Marie McCullough was born at Indianapolis In. on Sept. 12, 1954.

Another daughter followed, Patricia Ann McCullough, born on Nov. 3, 1955 at St. Francis Hospital. She was followed only eleven months later by Margaret Mary McCullough, born on Oct. 9, 1956. When Margaret was two

months old they bought a farm in Green Co. In. for \$4,000. They sold their home and store in town and moved to their farm in the country near Bloomfield, Indiana. There was a little town called Stanford nearby. For a while John continued to work in Indianapolis and drive back and forth. On April 2, 1958 another daughter, Beverly Ellen, was born at the Freeman Green County Hospital in Linton, In.

John and Anna were raising milk cows and selling the milk on their farm. John found employment at the Westinghouse factory in Bloomington, which was much closer, only 15 miles away. Their first son, David John McCullough, was born on May 17, 1959 at Linton In. He was very small, and he had an allergy to the barn dust. John and Anna decided to sell the milk cows, all but two for their own milk. They kept Bessie and Lady?. John decided to raise beef cows at that time. Their daughter, Sharon Rose, was born on May 16, 1960. Their daughters Donna and Patricia (Patty) attended the new Bloomfield school which housed both the high school and the grade school. On Nov. 13, 1961, daughter Carolyn Jane McCullough was born. John had gradually been buying more small sections of land and eventually built the farm up to 250 acres. They planned to eventually build a new home on it.

The farm was a rocky one, and well farmed, but John cleared much of it, and built up the soil with fertilizer, and it was coming along nicely. There were a number of apple trees on the farm, along with persimmon, pears, walnuts, and an unusual berry tree. There was a huge blackberry patch not far from the house. The kids would pick themselves a bowl of berries, put sugar and milk on them, and eat them for a snack.

A second son, Simon Harry McCullough was born on Jan. 19, 1963, also at Linton, In. Harry was followed shortly by another daughter, Ruth Alice McCullough, born on Anna's birthday, Dec. 14, 1964.

On Jan. 6, 1966, Anna and John received a phone call saying that Anna's father, Harry J. Dwenger had died of a heart attack in his sleep. Anna at first thought it was a mistake, for John's father had been ill for quite a while from heart trouble, and was expected to go any time. This loss was followed on May 12, 1966 by the death of John's father, Simon McCullough, after a long illness with his heart.

During a long strike at the factory where he worked John was forced to butcher his curly-headed bull. A neighbor, John Weaver came over and helped him. John felt bad afterwards because the bull came right to him when he called. He never butchered anything else himself after that. Sharon raised a real fuss and said she wouldn't eat any of the curly-headed bull. Another son, William Ray McCullough was born on Sept. 27, 1966.

The girls were getting old enough to help with the hay bailing, but John had to make the balls small.. John had put in an inside bathroom into the house, and had built his herd up to nearly 50 head of cattle. He had bought a new hay bailer too. The farm was coming along nicely. However, plans to build a new house at that time fell through. Their youngest son, Glen Arthur McCullough was born on March 3, 1968 at Linton.

In spring of 1968 John was diagnosed as having throat Cancer. (He chewed tobacco) This was successfully treated. In July they decided to take a vacation to Mississippi to visit John's brother Vernon and his family. They packed all of the children and John's mother into the VW Van and went. They had only one mishap on the way down. They had stopped at a rest stop, and Anna told David to take Harry to the bathroom. After a time they headed off again, and Anna immediately did her routine head count. She came up two short. She counted again, then did a roll call, David and Harry were missing. John David did a U-turn on the interstate, crossing the median and heading back. Meanwhile, David and Harry had emerged just in time to see the Van drive off. David, being the elder child, tried to be brave for Harry, "Don't worry," he said, "we'll walk to Mississippi,

and catch up with them." So as the van arrived quickly back at the rest stop, they were met by two small, frightened boys just starting to walk along the interstate. Once rescued, the brave older brother burst into tears of relief.

In September of 1968 John was once again diagnosed as having cancer, this time in his liver. It progressed rapidly; the cancer treatments didn't help. The men from Westinghouse where he worked pitched in each week with collections which helped pay the bills. On Feb. 19, 1969 after arriving home from the hospital from visiting John, Anna had a strong feeling that she needed to go back. As she had never learned to drive a car, she called the neighbor, who drove her to the hospital at Bloomington. When she arrived she found John was glad to see her, he said " Everything will be Ok now that you're here!" He was in great pain and she asked the nurse to give him something for it. He died shortly after that, on Feb. 19, 1969. He was buried at the Westport Cemetery, near his father. He said he thought it was a pretty spot, with a big shade tree there.

At this time Anna determined that she would have to learn to drive. She pretty much just got in and started driving. She had a few minor collisions along the way. She also went back to school and got her GED. She got a job working for Head Start (a pre-school program), and she also worked in a restaurant as a dishwasher. She would often bring leftovers from the restaurant home as treats for the kids. She tried for two years to keep up the farm, but after driving the tractor into a sink hole and busting the front end off; she decided that she just couldn't do it and she decided to sell the farm.

She bought a large house in the town of Millhousen, in Decatur County, Indiana. She was able to sell the farm for \$100.00 dollars an acre, (\$25,000.) on contract. The children attended the South Decatur school system (South Decatur High School, and Sandcreek Elementary). Anna and the children attended the Millhousen Catholic church there. She obtained a job as an aid working at The Muscatatuck State Hospital. She worked there until the time of her retirement in 1990. John's mother Mabel (Tanner McCullough) died suddenly of a heart attack on May 4, 1983 at Greensburg, In. Anna's mother, Mary Dwenger, is presently residing in the Oddfellows Nursing home in Greensburg, In.

In 1991 Anna decided to trade houses with her daughter, Beverly Powers, who was living in a small home in Greensburg with five children, while Anna was in the big house alone. Since her retirement Greensburg would be more convenient. She is presently living at this home on Mobley Drive in Greensburg, and the trade is expected to be permanent, as it is pleasing to all involved.

Anna and John were the Parents of 11 children: 1. Donna (Able) Swinford, Greensburg, 2. Patty Carson, Osgood, 3. Margaret Derflinger, Burney, 4. Beverly (Powers) Maggard, Millhousen, 5. David, Greensburg, 6. Sharon, Greensburg, 7. Carolyn Richards, Napoleon, 8. Simon Harry, Greensburg, 9. Ruth Griffith, Indianapolis, 10. William, Indianapolis, 11. Glen, Mooresville. She presently has 42 grandchildren/steps, and 2 greatgrandchildren/steps. She works part time staying with older ladies in their homes.

John David McGeullough b/March 17, 1929 Westport, Indiana D/1969
 marr./Aug. 16, 1952 Decatur Ci. In.
 Anna M. Dwenger b/Dec. 14, 1929 Decatur Co. In.

1.	2.	3.	4.	5.	6.	7.	8.	9.	10.	11.
b/1954	b/1955	b/1956	b/1958	b/1959	b/1960	b/1961	b/1963	b/1964	b/1966	b/1968
Donna M.	Patty A.	Margaret	Beverly	David	Sharon	Carolyn	Simon Harry	Ruth	William	Glen
m/#1 Gary	m/Mark	m/Ronnie	m/1 Tony	m/Penny	m/	m/Steve	m/#1 Pam	m/George	m/Debra	Arthur
Abel	Carson	Derflinger	Powers	Biddle	Child:	Richards	Cordray	Griffith	Smith	(not)
m#2 Terry	Child:	Child:	m#2 Bill	Child:	1. Stephanie	Child:	m/#2 Mary	Child:	Child:	(married)
Swinford	1. Jodi	1. Chris	Maggard	1. John	1. Stephanie	Ferry-Frazer	Ferry-Frazer	1. Mandy	1. Sean	
child:	b/1977	b/1975	Child:	b/1982	b/1989	Child:	Child:	b/1984	William	
1. Jesse	2. Chrissy	2. Michelle	1. Wayne	2. Kevin	1. Jacob	1. Coleen	1. Coleen	2. Ben	2. Ben	
Abel	b/1982	b/1977	b/1974	b/1983	b/1984	b/1982	b/1982	b/1986	b/1986	
b/1982	3. Elizabeth	3. Brandi	d/1975		2. Sarah	2. Cindy	2. Cindy	3. Carl	3. Carl	
2. Matt	b/1984	b/1981	2. Jeremy		b/1986	b/1984	b/1984	b/1987	b/1987	
Abel	4. Craig	one	b/1976		3. Vicky	d/1984	d/1984	4. Alex	4. Alex	
b/1985	b/1990				b/1990			b/1989	b/1989	
3. Aaron	5. Rebecca	grandchild				3. Mark	3. Mark	2. stepchild	2. stepchild	
Abel	b/1991	1. Brittney	3. Jeff			b/1985	b/1985	1. Michelle	1. Michelle	
b/1987	Derflinger	Derflinger	b/1977			4. Joe	4. Joe	b/1979	b/1979	
4. Adam	b/1991	4. Jenny	b/1981			b/1987	b/1987	2. Bo	2. Bo	
Swinford		5. Julie	b/1983			3. stepchild	3. stepchild	b/1980	b/1980	
b/1992		6. Justin	Powers			1. Christine	1. Christine			
5. Swinford		Powers	b/1985			b/	b/			
b/feb. 1993		2. stepchild	1. Cheri			2. Michelle	2. Michelle			
4. stepchild		1. Cheri	b/			b/	b/			
1. Danny Abel		2. Pam	b/			3. Amy	3. Amy			
b/1973		b/				b/	b/			
2. Becky Abel										
b/1975										
Courtney										
Swinford										
b/198										
Chris										
Swinford										
b/198										



Wedding of John David McCullough and Anna (Dwenger) Aug. 16, 1952 Decatur Co. In.
L to R: Mary Ellen, Esther, John David, Anna Mae, Bill, Harold
(Dwenger) (Dwenger) McCullough (Dwenger) Martin Powers



Family of John David and Anna (Dwenger) McCullough - June 1993
 sitting: Donna Swinford, Anna McCullough, Carolyn Richards
 row 2: Patty Carson, Sharon McC., Margaret Derflinger, Ruth Griffith
 row 3: Glen McC., David McC., Beverly Maggard
 back-top: Simon (Harry) McC., William McC.

pictures taken 25 years apart

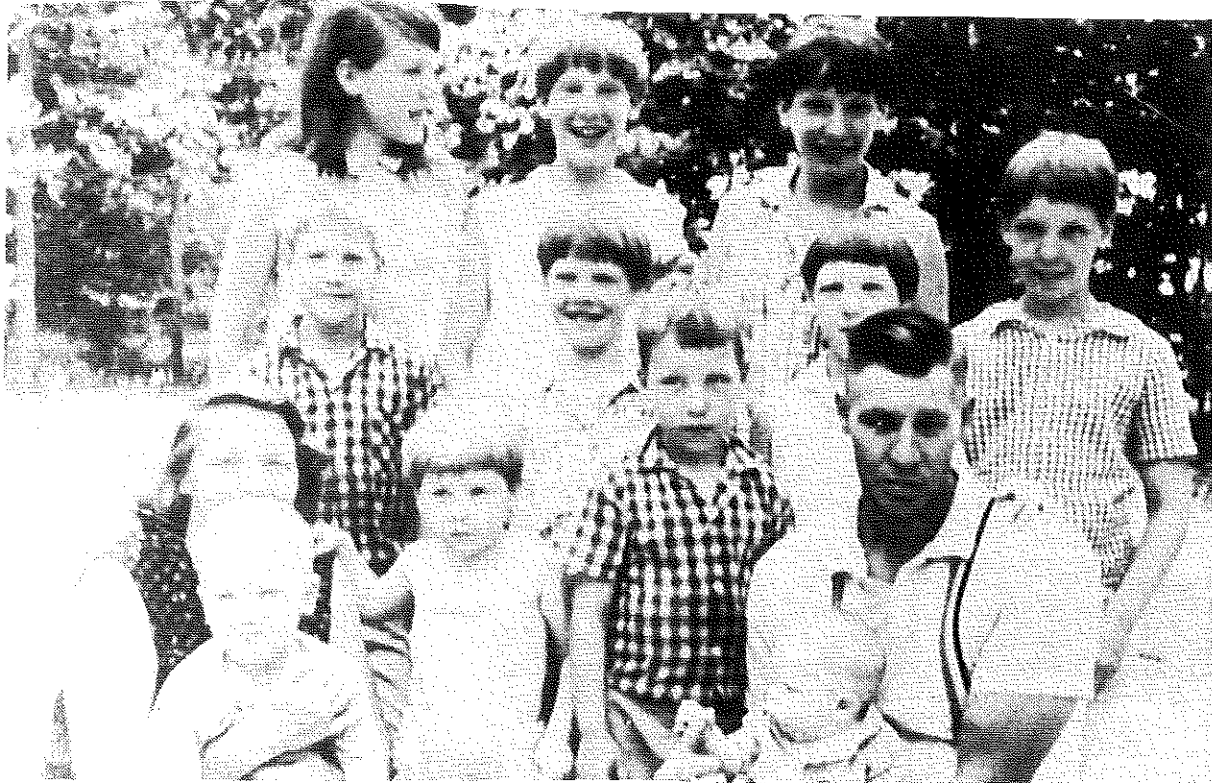

Row 1: (Bottom) Anna & William, Ruth, Simon Harry, John David & Glen
 Row 2: David John, Sharon Rose, Carolyn Jane, Beverly Ellen
 Row 3: Donna Marie, Patricia (Patty) Ann, Margaret Mary

Taken: Mississippi 1968 July 137



Anna (Dwenger) McCullough
born Dec. 14, 1929 Indiana

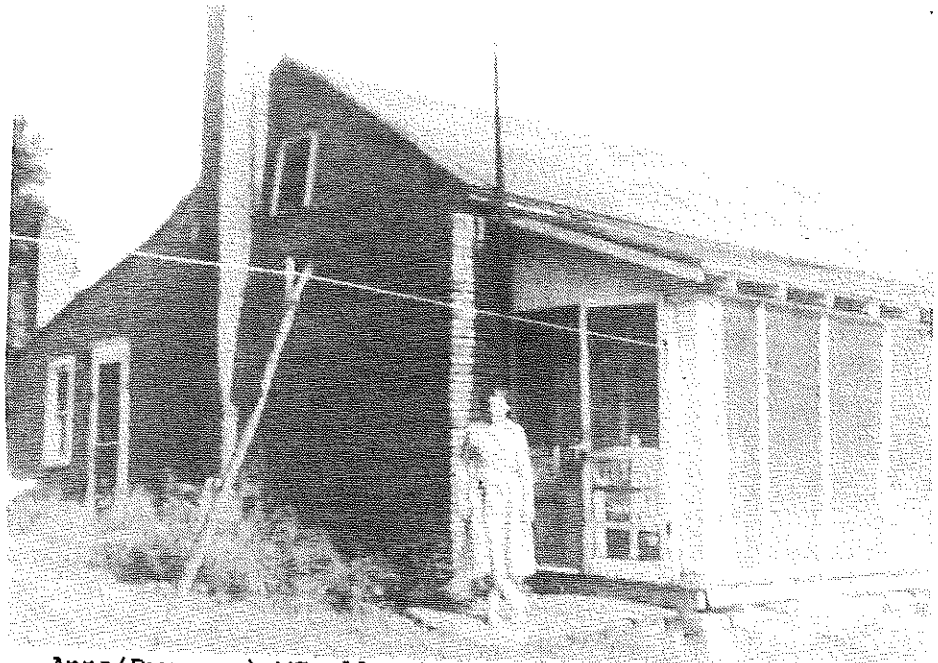

Anna (Dwenger) McCullough in front of the house
on their farm at Bloomfield, In. in Green Co.
around 1957

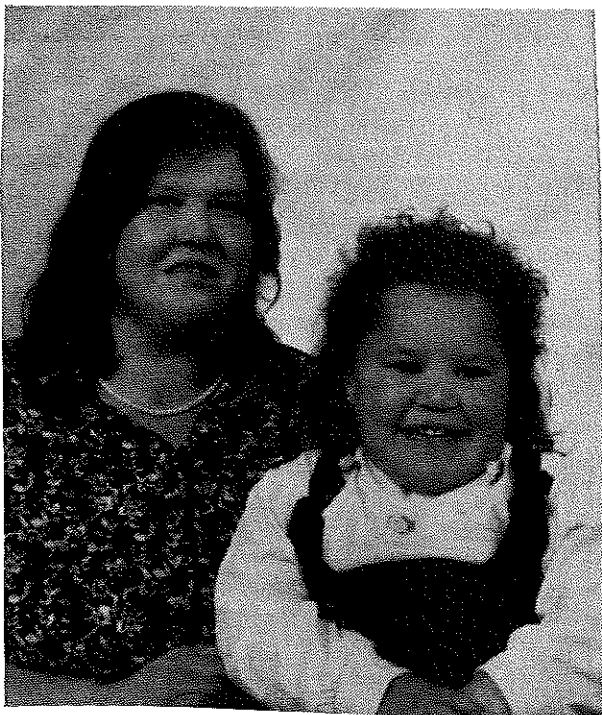

Sharon McCullough
b/May 16, 1960 &
dau. Stephanie
McCullough taken 1993

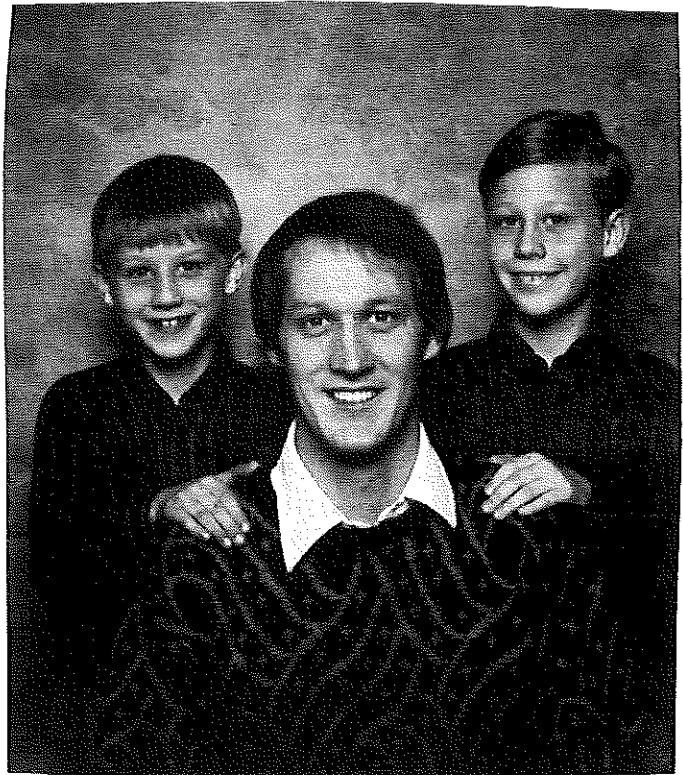

L to R: Kevin, David, John David
taken 1992 McCullough

DONNA MCCULLOUGH ABELL SWINFORD

I, Donna Marie McCullough was born September 12, 1954 in Indianapolis, Indiana the first child of Anna Mae Dwenger and John David McCullough. Other children in the family include Patty Ann, Margaret Mary, Beverly Ellen, David John, Sharon Rose, Carolyn Jane, Simon Harry, Ruth Alice, William Ray and Glen Arthur. The family resided in Indianapolis until Donna was two then the family moved to a farm in Green County in Southern Indiana which is the place that I remember as home. My father died of cancer in 1969 but the family remained on the farm until 1971. At that time the family moved to Millhousen, Indiana.

I began my Senior year at South Decatur High School and graduated in 1972. I began college at Ball State University that fall and graduated in the Spring of 1976 with a double major in Speech and Theatre and a minor in Library Science. I went on to finish my Masters in Library Science at Indiana University in 1981. Although I love doing plays and continue to be active in Tree County Players in Greensburg, Indiana I have always worked professionally in libraries and enjoy that very much. Currently I am employed as a school librarian at Sunman Elementary School in Sunman, Indiana and have been there for four years. Previously I have worked at South Decatur Elementary School, Greensburg Public Library, Kokomo Public Library and the SIALSA Services Center which handles interlibrary loans for area libraries.

I was married the first time to Gary Wayne Abell on June 24, 1978. He had been previously married and had 2 children by his first marriage. Danny Wayne was born October 5, 1973. Rebecca Carol (Becky) was born July 10, 1975. We had three sons together. Jesse Wayne was born January 4, 1982. Matthew David was born June 16, 1985. Both boys were born in Columbus, Indiana where we lived the first eight years of our marriage. In January 1986 we moved to Kokomo, Indiana after Gary was laid off at Cummins Engine Company. He found employment at Delco Electronics in Kokomo and continues to work there to date. A third son was born to us in Kokomo, Aaron Joseph was born June 27, 1987. Gary and I were divorced on June 15, 1988. I moved to Decatur county with the boys at that time.

On June 1, 1991 I married Terry Wayne Swinford in Greensburg, Indiana. Terry was born Dec. 3, 1948 to Nancy Rapp and Marvin Swinford. Nancy and Marvin were divorced and Nancy remarried William Daniels. Nancy and Bill live in Terre Haute, Indiana. Terry has a brother Robert Swinford, 1 year younger. Terry and Robert moved with their mother to Terre Haute and a sister was born there, Teresa Daniels. Bill Daniels is the only father Terry ever knew. Robert (Bob) currently lives in Terre Haute next door to Nancy and Bill. Teresa resides in Fortville, IN. Although Terry was previously from the Indianapolis area he moved here with us at the same address. Terry is employed at Babcock and Wilcox in Indianapolis and had been there 13 years. He is an inspector there. Terry has two children from his previous marriage. Christopher Wayne was born June 30, 1979. Courtney Lynn was born October 9, 1981. On May 28, 1992 a son was born to us, Adam Michael Swinford. He is my fourth son, Terry's third child and makes a total of 6 when we have them all together. We are expecting another child in early February 1994.

Danny Abell was married January 30, 1993 to Stephanie Stout of Seymour, Indiana. Danny and Stephanie are the parents of Nicholas Wayne Abell born March 31, 1992. Danny is currently serving in the Army and is stationed in Ft. Hood, Texas. Stephanie and Nick are with him there. Danny and Becky Abell were part of my family for 10 years and will always be family to me.

The Swinford's (and Abell's) reside at 528 Bennett Street in Greensburg, Indiana.

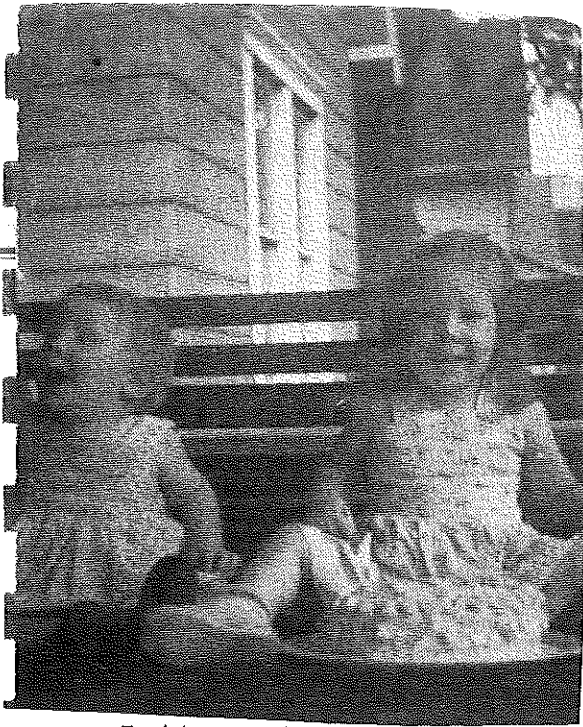

Patty and Donna
age 1 age 2
McCullough



Wedding of Terry and Donna (McCullough-Able) Swinford
June 1, 1991 Greensburg, Indiana - Decatur County
Donna and Terry
Jesse Able, Courtney Swinford, Aaron and Matt Able, Chris Swinford

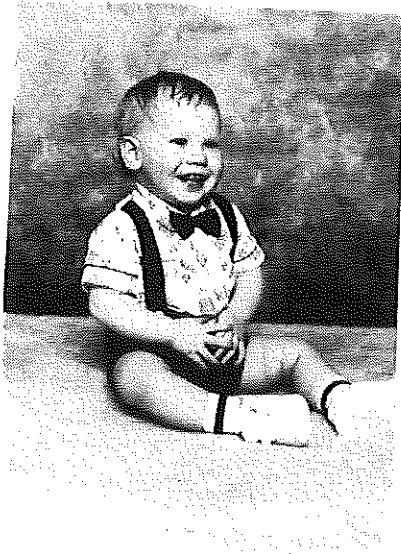

Adam Swinford
age 1 year 1993



Jan. 30, 1993 Danny and Stephany Able's Wedding (all Ables)
Becky Able, Jessie, Danny and Stephany & Nicholas, Aaron, Matt

MARK E. AND PATRICIA A. (MCcULLOUGH) CARSON

Patricia ann McCullough was born on Nov. 3, 1955 at Indianapolis In. She was the daughter of John David b/1929 and Anna Mae(Dwenger)b/1929 McCullough. John was the son of James Simon McCullough b/Westport, and Mabel(Tanner) b/Milner, N. Dakota, of Westport, In. Simon and Mabel were both school teachers, and owned a small farm outside of Westport. Anna was the daughter of Harry J. and Mary(Hessler) Dwenger. Anna was one of ten children. Anna and John David were married in 1952 Ind.

When Patty was one year old her parents bought a farm in Greene Co. Indiana. It would eventually become a 250 acre farm. Patty attended the Eastern School (Now a part of the Bloomfield school system.) Patty's father was a farmer, but he also worked at a factory, Westinghouse, in Bloomington, on second shift. Patty was second oldest of eleven children: Donna(Swinford), Patty(Carson), Margaret(Derflinger), Bev(Maggard), David, Sharon, Carolyn(Richards), Harry, Ruth(Griffith), William, Glen.

The girls would help with bailing hay and stuff. Occasionally when we would be bailing hay in the hot summer heat daddy would stop in the field and we would all take a quick swim in our clothes in the nearby white River which ran along the hayfield. Then we would go back out and finish bailing hay. Daddy would make the bails as small as they would go on the bailer so that we would be able to lift them.

Sometimes on Sundays in the summer we would have a picnic for the meal. The whole family would walk out to one of the fields. The Jinx field had a nice tree and it was where we usually had picnics.(We children called it the jinx field because somebody always seemed to get hurt there.) Daddy would have all the children gather up sticks and he would build a fire. Mom would set the food out on a blanket under a tree. Then daddy would cut us roasting sticks for hot dogs from green sapling branches. To this day I love the taste of hot dogs roasted on an open fire.

We had a pond on the farm which we used to swim in when it was hot. Daddy made us a jumping board, none of us knew how to dive but we liked to see how big a splash we could make when we jumped in.

We had a basic routine that we followed each school day. Mom would get us up, and we would get dressed. She would have breakfast for us downstairs. I hated eggs, oatmeal, and corn flakes which we had a lot. When we got home from school we took off our good clothes and put on everyday clothes and would wear each outfit at least two days. Mom had us help wash clothes and hang them on the line. She had an old wringer washing machine, which we filled up with the water hose.

We attended the Bloomfield Catholic church. There weren't many Catholic's around and we would often be teased at school, "Don't sit next to her, she's Catholic!" We attended church every week and never missed unless it was unavoidable. Once a month, on a Sunday, we would drive to Decatur County to see the grandparents, on these Sundays we would leave early and go to church in Bloomington, or at the log church in Brown County. Daddy, who was Baptist, would wait in the car. When we went to the grandparents we would visit her parents one month and his parents the next month.

When we were little mom was always home. She would always let you climb in bed with her if you had a bad dream,(In Mom and dad's bed the dreams would go away) when daddy got home from work, then you had to go back to your own bed. We kids all shared one big room upstairs.

We went on a vacation in 1968 to Mississippi to visit Daddy's brother Vernon. Daddy sold a cow to pay for the trip. We took Grandma McCullough down with us. It was an exciting adventure, very different from everyday. It was fun. I remember stopping at a place where they had hamburgers five for a dollar, and Daddy got all us kids one burger. Daddy got two. I told him it wasn't fair that he got two and we got one, he said "I'm bigger than you, I need more food", I said, "I'm a growing kid, I need more food." He laughed, but I didn't get an extra hamburger.

After we returned from the trip, Daddy took Donna to the doctor for a sore knee where she had scraped it on a barnicle and it had gotten infected. The doctor checked Daddy also for nausea. They discovered that he had cancer. Daddy died six months later on Feb. 19, 1969 from cancer.

We lived for two more years on the farm, but Mom just couldn't do it by herself. She bought a house in Millhousen, in Decatur County, to be near she and John's families.

When I first saw the house I thought it was a mansion. It was a huge nine room house. I only had to share a whole room with just my sister Margaret. Moving was also an exciting adventure.

I graduated from South Decatur High School in 1974. In August I moved into a small apartment in Greensburg which my sister Margaret and I shared. I got a job filling vending machines in factories in Greensburg. My sister Margaret worked at Burger Chef.

In August I met Mark Eugene Carson. He was a student at the Cinn. Bible college studying to be a minister. We began dating in Aug. and were engaged in Oct. 1974. We were married on May 24, 1975 at the New Point Christian church, where Mark was a member, (Mark's great great grandfather Parkinson Barkley had helped establish the church in 1800's) in Decatur Co. Indiana.

Mark Eugene Carson was born on Oct. 14, 1954 at Batesville, Indiana. He is the son of Clarence Eugene and Helen Faye (Haley) Carson of New Point, Indiana. Mark is the oldest of three children. He has twin sisters, Diane Elaine (Celaya) Tuson, Ariz., and Debra Etta (Yeggy) Cinn., Ohio.

Clarence Carson was the son of William and Velma (Barkley) Carson, of New Point. Clarence's father William was the son of Hugh and Annie (Brinker) Carson. Annie died when Will was only a baby and Will was raised by Hugh's parents, George and Elizabeth (Smothers) Carson.

Helen (Haley) Carson was the daughter of Morton and Carrie (Lawrence) Haley, of Greensburg, In. Helen was one of eleven children. Morton was the son of James and Cordealia (Haley) Haley. The Haley were originally from Kentucky. Carrie was the daughter of Edward and Flora (Skeen) Lawrence.

Mark grew up his whole life in the town of New Point. He was in the boy scouts, and he mowed lawns for people to earn spending money. He graduated in 1972 from North Decatur High School. He attended one year at the Great Lakes Bible College, then transferred to the Cinn. Bible College, in Cinn. Ohio, which was much closer to home.

Mark became employed at Hill-Rom (makes hospital beds), a part of Hillenbrands, in Batesville. After Mark and I were married we set up housekeeping in an apartment in Lincoln Street in Greensburg. We moved six times that first year. We finally rented a house on Wilson St. in Greensburg, where we lived for two years. Mark decided to remain at Hillenbrands.

I got a job working at Oddfellows nursing home in Greensburg. I worked there until the birth of our daughter, Jodi Michelle Carson on Oct. 28, 1977 at Greensburg, In. In fall of 1977 we had been looking at homes. We purchased an old home which needed much work, in the town of Napoleon, in Ripley Co., In. We completely remodeled it, over a period of several years.

I was employed for a short time at the Osgood shoe factory before being hired at Hill-Rom in Batesville. Mark and I worked at the same factory. We rode into work together and took our lunch breaks together. I worked there for three years. Our second daughter, Christina Mae Carson was born on Feb. 2, 1982 at Decatur Co. Hospital. I quit working six months after that to stay home with the children. Shortly after Christina was born we added two rooms and a deck onto the house.

We found a piece of land we wanted to buy (on Finks Rd., in Center Twp. in Ripley Co.) and closed the purchase shortly before our third daughter, Elizabeth Faye was born on Dec. 11, 1984, at Decatur Co. In.

We sold our home in Napoleon to my sister Carolyn Richards and her husband Steve, in fall 1986. We began building on our land immediately. We had the basement poured, and with the help of family and friends, we put up the shell of the house in a very short time. In Jan. of 1987 we moved into the basement while we completed the insides of the house ourselves. We lived in the basement for two years, and in the spring of 1989 we moved into the house, on seven acres of land.

In 1989 I compiled together research on the McCullough family into a McCullough History book. This was completed in Winter 1989, two months before our son was born. Our son Craig Eugene Carson was born on Jan. 23, 1990 at the Decatur Co. Hospital. Our fourth daughter, Rebecca Lynn Carson, followed closely behind Craig, she was born on July 9, 1991.

Our home is now complete. It takes three riding mowers going at the same time to mow the nearly six acres that we mow. We have planted a lot of regular trees and fruit trees. Mark recently celebrated his 18th year at Hill-Rom.



Helen F. Carson, Mark E. Carson, Patty (McCullough)
 back: Clarence Carson, Anna McCullough
 Mark and Patty's Wedd. May 24, 1975



Mark and Patty Carson Family
 L to R: standing; Jodi, Chris, Elizabeth
 sit: Mark, Patty, Rebecca, Craig
 June 1993



Mark Carson Patty Carson
 age 38 age 37
 June 1993

MARGARET MARY (MCCULLOUGH) DERFLINGER

Margaret Mary McCullough was born on Oct. 9, 1956 in Marion Co. at Indianapolis, Indiana. She was the daughter of John David and Anna Mae (Dwenger) McCullough. When Margaret was only a few weeks old, the family moved from Indianapolis, to a farm in Greene Co. In. R.R.#4 Bloomfield.

Anna and John were attempting to establish a dairy farm, and one day when Anna was needed to assist John at the barn, they left Donna to watch over the other children, Margaret and Patty. Margaret still being an infant rolled from the center of the bed where she was sleeping and began to cry. Anna had given Donna strict instructions not to leave the babies, but Donna who was only about three tried to pick up the baby, but could not lift her back onto the bed. She ran down the hill to the barn to get her mother. When her mother saw her she spanked her for leaving the babies, but when Donna explained that the baby had fallen off the bed and she couldn't pick her up. She ran to the house quickly. Margaret by this time lay playing happily on the floor. After this occasion, Anna never spanked again, before hearing what the child had to say.

She attended Eastern High School, grades 1-9. In 1969 her father passed away, from cancer. In 1972, her mother sold the farm and purchased a large home in the town of Millhousen, in Decatur Co. near their families. Margaret graduated from South Decatur High School in May of 1974.

Margaret was married on Nov. 16, 1974 to Clarence Ronald Derflinger, at Millhousen, IN. Ronnie was born on Nov. 6, 1955 in Germany, (His father was in the Military) He was the son of Clarence and Nannie (Tolliver) Derflinger. Ronnie was in the Air Force and stationed in Abilene, Texas for four years.

Their son Christopher Ronald was born on April 13, 1975 at Greensburg In., just one day before Ronnie left for Basic training. Margaret was pregnant with their second child while in Texas. Margaret had not been feeling well that day and she got up in the evening having some pains, and went to the restroom, where she realized that she was in labor. She woke Ronnie and after dropping Chris off at a friend's, headed quickly for the base hospital. The baby began to come while they were on the way to the base. They arrived at the hospital and the baby was born only four minutes from the time they reached the hospital doors. Their daughter, Michelle Marie Derflinger was born on Aug. 27, 1977 at Abilene Texas, Dyess Air Force Base Hospital.

Ronnie got out of the Army after four years in 1979, and they returned to the City of Greensburg, in Decatur Co., where Ronnie became employed at James River Corp.

Their daughter, Brandi Nicole Derflinger was born on Feb. 14, 1981 at Decatur Co. Hospital in Greensburg. Margaret and Ronnie purchased a home in Greensburg and moved in just before the birth of their daughter Brandi.

Margaret and Ronnie were divorced at Greensburg, In. in Decatur County on Aug. 5, 1988. Margaret moved for a time to Millhousen In. with her mother. She became employed at Sintering Tech. Inc. where she is employed today. She purchased a home in the town of Burney, in Decatur Co.

Ronnie is remarried. He has a son, Tanner Ronald Derflinger, born on Aug. 22, 1989. Tanner is the son of Sarah Bishop.

Margaret's son Christopher is the father of a daughter, Brittany Richelle Derflinger, born on Aug. 21, 1991 at Greensburg.

BEVERLY ELLEN MCCULLOUGH MAGGARD

I am the 4th daughter of John David & Anna Mary McCullough. My family as a child was Donna, Patty, Margaret (Peggy), ME, David, Sharon, Carolyn, Harry, Ruth, Willie, Glen.

My name is Beverly, Bev for short. I am 35 years old. As a high school student that knew everything, I became pregnant and dropped out to get married at the ripe old age of 16. I married my first true love, Anthony Wayne Powers. We were married on Dec. 7, 1974 in the Millhousen school house. We were married 10+ years and had 6 children together. We divorced on 5-17-85.

Our children were:

<u>Where</u>	<u>Name</u>		
Greensburg	Wayne Anthony	born 12-25-74	died 2-3-75
Greensburg	Jeremy Allen	born 3-17-76	
Greensburg	Jeffery Lee	born 6-24-77	
Greensburg	Jennifer Lynn	born 7-05-81	
Greensburg	Julie Ann	born 3-04-83	
Batseville	Justin Scott	born 5-13-85	

I returned to school and received my GED diploma in 1977. I started college classes in 1990 at IUPUI in Columbus. I am studying to be a CIMT (Computer Intrigated Manufacturing Technologist). Thats fancy for Mechanical Engineering. I married the most wonderful man in the world on August 1, 1992. His name is William D. Maggard.

I met Bill at a "Old Timers Party" from work. He was hired to play in the band. I was single, and happy that way. The last thing I needed was a man in my life to slow me down. Bill seemed interested but didn't call. At first I had myself convinced that I didn't care. Later I called him, he wasn't home so I left a message. He didn't call back. I gave up. Three weeks later he got the 1st message that I called. He called me. After our first date at 2 P.M. at Cattlemans in Greensburg. We were destined to be together. And we are.

Bill has 2 girls from his first marriage. Cheri Lynn age 18 and Pamela Faye age 10. Cheri is attending Purdue University, and Pam goes to North Decatur Elementry. This is interesting because my children attend South Decatur Elementry & High School.

Jeremy and Jeff are both juniors. Jeremy works at Hardee's in the evenings after school. Jeff works at Toco Bell. Both boys have drivers licences and are growing up on me.

We live in the house I lived in after the age of 12 when we moved to Millhousen. Mom and I traded houses 3 years ago (1990). Our address is:

Bill & Bev Maggard
P.O.Box 15
Millhousen, Ind. 47261

David John McCullough Family

David John McCullough was born May 17, 1959 in Freeman Green County Hospital, Linton, Indiana. His parents are John David and Anna Mary McCullough. At that time they lived on a farm in Green County, Indiana.

In 1971, two years after his father's death in 1969, his mother sold the farm and the family moved to Millhousen, Indiana where he lived until after graduating from South Decatur High School, Westport, Indiana, in 1978. Since high school he has been employed at Federal Mogul, a bearing factory in Greensburg, Indiana.

On May 16, 1981 David married Penny Jean Biddle (born on August 1, 1960, in Batesville, Indiana, to James Leo and Bonnie Biddle). Penny and David were divorced on July 11, 1985. Penny and David are the parents of two children, John David McCullough and Kevin James McCullough; both children live with David.

John David was born on February 21, 1982 in Greensburg, Indiana, and attends school at St. Mary's Catholic School in Greensburg.

Kevin James was born on February 21, 1982 in Greensburg, Indiana, and also attends St. Mary's Catholic School in Greensburg. Kevin was born with a heart without chamber walls, and has since had corrective open-heart surgery. He is now doing fine.

David and his sons are faithful members of St. Mary's Catholic Church in Greensburg, Indiana where they live. David devotes much of his spare time helping family and friends with household and automotive repairs.

SHARON ROSE MCCULLOUGH

Sharon Rose McCullough was born on May 16, 1960 at Linton, in Green Co., Indiana. She is the daughter of John David McCullough, born at Westport, In. on March 17, 1929, and Anna (Dwenger) McCullough born in Decatur Co., Indiana on Dec. 14, 1929.

She is one of 11 children.: Donna Swinford, Patty Carson, Margaret Derflinger, Beverly Maggard, David McCullough, Sharon McCullough, Carolyn Richards, Harry McCullough, Ruth Griffith, William McCullough, Glen McCullough,

Sharon attended South Decatur High School and graduated in 1980. Her Hobbies include sewing and cooking, and also she enjoys working with crafts.

Sharon became employed at Indiana Beechcraft in Indianapolis. Sharon met James Edmodson at Beechcraft in Indianapolis, in Jan. 1988. He was working at Allagahanie commuters, next to Beechcraft. He used to come to the Beechcraft break room at the same time Sharon would take her break, just so he could talk to her. They started dating in March of 88 and Sharon thought it was going to be a serious relationship.

In August of 1988 Sharon found she was going to have a child. At this time he found that the company he was working for, Allaganie Computers, was going out of business. Because of health problems related to her pregnancy, Sharon moved to Burney and James was going to Nebraska. When he found a job, he was going to call Sharon so they could get together again, but he never did call her, and he has never seen their daughter.

Stephanie Ann McCullough was born on April 16, 1989 at Wishard Hospital in Indianapolis.

Sharon has worked at several part time jobs, and at present is working as a practical nurse staying through the night with Zue Mitchell, a retired teacher.

Sharon and Stephanie are currently residing at their home in Burney, Indiana in Decatur County. She is a member of the Greensburg Catholic Church.

STEVE RICHARDS AND CAROLYN MCCULLOUGH

Howard Steven Richards was born in Vermilion County, Danville, Illinois on January 30, 1960. He resided at his parents' home in Hume, Illinois. Upon graduation from High School in May 1978, he entered the US Army. He received Basic Combat Training and Advanced Individual Training at Ft. Dix, New Jersey and was awarded the Military Occupational Specialty (MOS) of Motor Transport Operator. Upon graduation from AIT, he was assigned to permanent duty to Headquarters, Headquarters Company, 5th Battalion, 32nd Armor, at Ft. Stewart, GA.

During a Military Leave, he married Gay Lynn Nichols at her parents' home in Brocton, Illinois on August 4, 1979. They were divorced March 27, 1981. They had no children.

In June 1981, he was reassigned to Headquarters, Headquarters Battery, 1st Cavalry Division Artillery, at Ft. Hood, Texas. There he was promoted to the rank of Sergeant (E-5) and received the Good Conduct Medal within the same month. He was discharged from active duty on October 8, 1982.

Carolyn Jane McCullough was born at Linton, Indiana, in Greene County, on November 13, 1961. She resided at the family farm near Cincinnati, Indiana. After her fathers' death in February 1969, the farm became too much of a burden for a widow with eleven children. After the sale of the farm, the family moved and made their home in Millhousen, Indiana in May 1971. Carolyn graduated high school in May 1979, then worked as a Nurse Aid at the Decatur County Memorial Hospital in Greensburg, IN. She enlisted in the US Army in October 1980. She received training in South Carolina and Georgia and was awarded the Military Occupational Specialty of Radio Teletype Operator. She was then assigned to permanent duty to Headquarters, Headquarters Battery, 1st Cavalry Division Artillery at Ft. Hood, TX.

Steve and Carolyn met there in June 1981 and soon became very close friends and began dating later in November. In February 1982, Carolyn returned to Greensburg to perform Hometown Recruiting Duty. While there, she arranged for the coming wedding.

Steve and Carolyn were married in the First Christian Church in Greensburg, IN. on June 18, 1982. Many of the original plans were changed due to the death of Steve's father on June 17. According to Army Regulation, Carolyn could not stay on leave if she were not legally related. So, to stay, the wedding was moved up a day and the couple were married as planned. During the next year and a half, they ended their tour of duty at Ft. Hood and spent a year in Japan, where Carolyn was promoted to Sergeant (E-5), and received an Honorable Discharge due to pregnancy.

They returned to the US and now reside in their home in Napoleon, IN. Carolyn is employed at GenCorp Automotive in Shelbyville, IN. Steve is employed by Indian Lakes Resort and is currently attending Indiana University, majoring in Elementary Education. They have three children at this time. Jacob Howard Richards was born in Ireland Army Hospital at Ft. Knox, KY on July 2, 1984. Sarah Alyse Richards was born at Margaret Mary Community Hospital in Batesville, IN on May 19, 1986. Victoria Ruth Richards was born on June 14, 1990, also at Margaret Mary Community Hospital.

Carolyn and Steve Richards are expecting a baby due on May 26, 1994.



Harry and Mary McCullough
 Christine Michelle
 Frazier Frazier
 Coleen McCullough
 Amy Frazier, Mark McC.
 1993 Joe McC.



Cheri, Beverly, Bill, Jeff, Jeremy
 Maggard Maggard Powers Powers
 taken 1992
 Jenny, Pam, Justin, Julie
 Powers Maggard Powers Powers

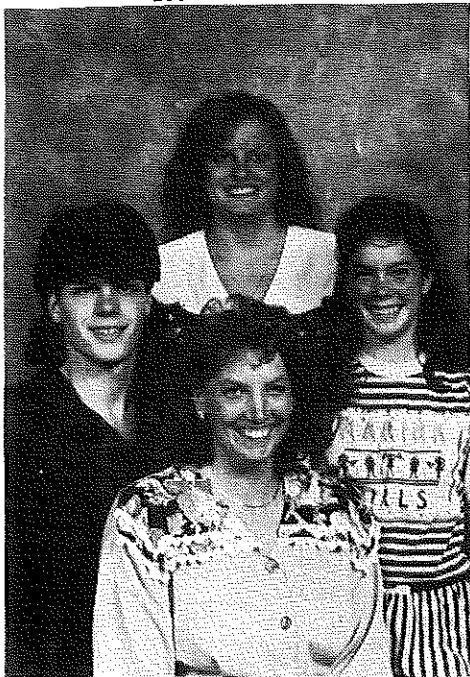

Michelle
 Christopher Brandi
 Margaret
 Derflinger
 taken 1993

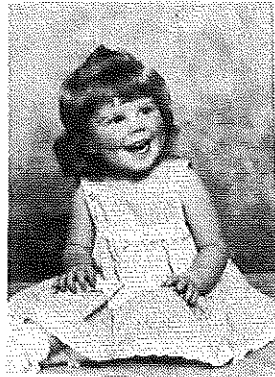

Brittany
 Derflinger
 b/Aug. 21, 1991

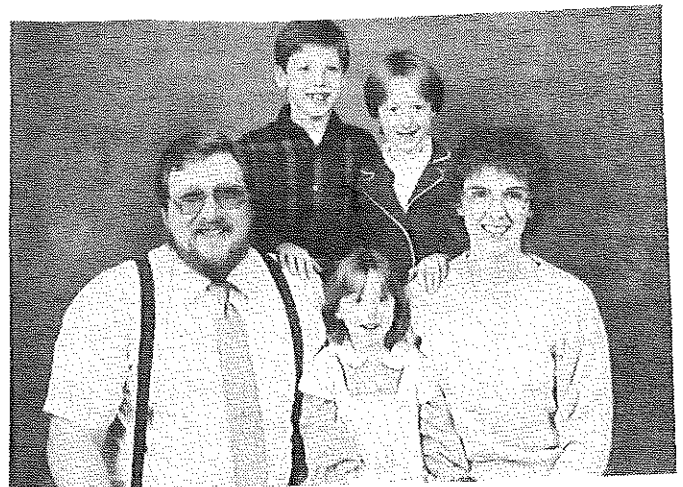

Jacob and Sarah
 Steve, Victoria, Carolyn
 1993 Richards

HARRY AND MARY(FRAZER) MCCULLOUGH

Simon Harry McCullough was born on Jan. 19, 1963 at Linton Indiana. He has seven sisters and four brothers. Harry's family lived on a farm in Greene Co. In. After his father died in 1969 from Cancer, his mother moved the family back to Millhousen, in Decatur Co. to be near their family's.

Harry graduated from South Decatur High School at Westport, In. in 1981. He was married in June 1981 and later divorced in Sept. 1987. He entered the US Army in September 1981, and served five years; seven months, of which, were in Germany. He was honorably discharged in 1986, as Sergeant.

He has four children from his first marriage, Colleen McCullough, born Jan. 9, 1982, Cynthia Beth, born Feb. 3, 1984 and died April 14, 1984 (SIDDS). Mark McCullough born May 14, 1985 and Joe McCullough born July 31, 1987.

Harry was married to Mary Rose Ferry-Frazer, on Sept. 8, 1990. Mary was born on Nov. 21, 1956 at Beech Grove In. in Marion Co. She was the daughter of Frank Albert Frazer and Rosanna Catherine (Burke) Frazer. She is one of six children. Mary graduated from Indiana University School of Medicine in 1984 and currently practices in Greensburg, In. as a family physician. Mary has three children from a previous marriage, Christine Frazer born March 15, 1981, Michelle Frazer born Oct. 16, 1983, Amy Frazer born Sept. 17, 1985.

Harry and Mary McCullough currently live at 2568 E. Base Road, Greensburg, In. with all six children. Harry is finishing his Bachelor of Science degree in electrical engineering technology at Purdue University in Indianapolis, and expect to finish in December of 1994. He also has his pilots license and enjoys flying an airplane.

Harry and Mary are members of the St. Mary's Catholic Church in Greensburg. They are also members of the Tree Co. Players of Greensburg.

Ruth and George Griffith are currently living in Chicago, Ill. where George is employed.

My name is Ruth Alice (McCullough) Griffith. I was born December 14, 1964 to *John D. and Anna McCullough* in Linton, Green County, Indiana. I am their ninth of eleven children. I was born on my mother's 35th birthday. My father wanted to name me Wilma, but because I was born on my mother's birthday she got to name me. My family lived on a farm in Little Cincinnati, Indiana until my father died of cancer in 1969. Two years later (1971) my mother sold the farm and moved to Decatur County, Indiana, near where most of her family were located. At that time I was 6 years old.

I attended Sandcreek elementary school for grades 1 through 5. This was an old tin building constructed in one long hallway. Formerly the local high-school, it had long been converted to a grade school, and was well past its prime. I remember the teachers telling us to bring our coats into the rooms, and off of the hallway coat racks every time it rained because the roof leaked, and we could not wear them home wet. In 1976 the school district set to work to build a new grade school. The first through fifth grades held class in the gymnasium (exempted from reconstruction), and the sixth graders (ME) were relocated to the Junior High/High School combination, South Decatur High School. The new South Decatur Elementary School was completed the following year. I graduated high-school early, in January, 1983, as a member of the National Honor Society. Two weeks later I left for Ft. Dix, New Jersey, and U S Army basic training. After completing basic, I went to Ft. Bliss, Texas, where I learned how to be an IHAWK missile crewmember, setting up, loading, unloading, and arming/disarming IHAWK missiles. After completing my training I was sent to Schweinfurt, West Germany (in the Bavarian region).

I arrived in the FRG(Federal Republic of Germany) in June, 1983. I was immediately assigned to the personnel office because of my typing abilities, and was enrolled in a German language course. Two weeks later I met my future husband, George Lee Griffith, also a soldier in the U S Army. George arrived into Germany, and was sent to my unit. On his first night on post we had our first date. By October we were engaged. We took one week leave, flew home to Indiana, and were married on March 19, 1984. We had to return to Germany at the end of the week. We had a delayed honeymoon on the 4th of July weekend, 1984 in Riva on Lago del Garda, Italy, and Venice, Italy.

George, my husband, was born (and raised) in Anderson, Indiana, February 28, 1962, to Earl and Alice Griffith. He is the youngest of 5 children (Earl, Jr; James; Alice Jean; Carolyn Jane; George). He attended Anderson High School; his parents now reside in Fitzgerald, Georgia. George was married previously, at age 17, to Christy Jo Bicknell, and had two children, *Michelle Lee (April 27, 1979)*, and *George, Jr (June 14, 1980)*. They were divorced in May, 1983.

I lived in Germany for 15 months,(6/83-8/84) mostly in a German house off post. As many of my ancestors are from Germany I would like to take this opportunity to tell some stories about my life there. Though East and West Germany have now re-merged into a single Germany, I sometimes still refer to West Germany, or FRG, as that was the proper terminology when I was there.

Schweinfurt was located in Bavaria, Germany, the southeastern region of West Germany (southcentral region of the new Germany). My house was located in Gochsheim. It was a two story, two bedroom house, with a living room, dining room, and kitchen. The bathroom was split. The toilet was located upstairs, with the bedrooms, and the bathtub was located downstairs. Both were apparently built into former closet space. The water heater was electric, but only held about 15 gallons, and had to be turned on about 30 minutes before you planned to use hot water for a bath or dishes. The kitchen appliances looked like children's toys. The Germans kept only a minimum of food in the house, grocery shopping daily in the open market downtown. They irradiated their meat and milk, so that it could be stored unopened on the pantry shelf, without refrigeration. The house was heated by a small oil burning space heater, which left a heavy black smoke on the windows so thick that the windows had to be washed twice a week, just to be able to see out at all.

My landlord was a German named Willy Spitzner, who lived two houses down from me. He was a gentle old man who spoke not a word of English. George and I communicated with broken German, using a German to English Dictionary, and many hand gestures. This was quite a learning experience, as were many of the quaint German laws, like 1) If you kill a chicken you must pay the owner not only the value of the chicken, but also the value of all eggs that chicken may have laid in its natural lifetime, or 2) You cannot wash your car on Sunday, or 3) A policeman will not stop you for speeding or running a red light. A picture is taken on site and tickets are mailed to you for traffic violations, no protest is allowed. I received a lace tablecloth from Willy and his frau as a wedding gift which will be treasured.

During the summer the Germans have a two-week-long holiday called Fashing. This is similar to Halloween here. Everyone dresses in costumes and loud, boisterous never-ending parties are held for the entire two-week period. During my time in Germany I visited many castles. German castles are either fortresses (built for military purposes), or palaces (built as a royal residence). The town of Wurzburg has both a fortress and a palace which I visited. I also toured the castle Neuschweinstejn, a fairy-tale like palace in the Bavarian Alps, after which Walt Disney modeled his replica. I also visited the German towns of Frankfurt, Fulda, Nuernberg, Munich, and Birteschgarden during my time there.

I returned from Germany in August, 1984, and gave birth to *Amanda Ruth, October 26, 1984*, in Batesville, Indiana. George returned from Germany in November, 1984. We moved to Indianapolis in May, 1985, where George worked as a diesel mechanic, and attended IUPUI, studying electrical engineering, and physics (6/86 - 5/93). I also attended IUPUI, studying accounting(6/87-8/91). Together we had three more children, *Benjamin Earl (September 14, 1986)*, *Carl James (October 6, 1987)*, and *Daniel Alexander (October 26, 1989)*, all born in Indianapolis, Indiana. George's brother, Earl Junior joined our family in December, 1987. George Jr (Bo) came to live with us in June, 1988. At this time we (Ruth, George, Earl, George Jr, Amanda, Ben, Carl, and Alex) reside at 3647 Hillside Avenue, Indianapolis, Indiana 46218. Michelle Griffith lives in Marion, Indiana with her mother, Christy Campbell. After George graduates in May we will relocate to where we can find work.

WILLIAM and DEBORAH (Smith) MCCULLOUGH

William (Willie) Ray McCullough was born on September 27, 1966 at Linton, IN in Greene County. He is the son of John David and Anna (Dwenger) McCullough. He is one of eleven children: 1) Donna, 2) Patty, 3) Margaret, 4) Beverly, 5) David, 6) Sharon, 7) Carolyn, 8) Simon Harry, 9) Ruthie, 10) Willie, and 11) Glen. Willie graduated from South Decatur High School in May of 1984. In January 1985, Willie moved to Indianapolis, IN where he found employment at Domino's Pizza.

On April 22, 1989 at the Immaculate Conception Church in Millhousen, IN in Decatur County, he was married to his high school sweetheart, Deborah Dawn Smith. She was born on February 11, 1967 at Noblesville, IN in Hamilton County. She is the daughter of Frank Russell Smith, born August 15, 1939, son of Irvin Leroy Smith (born April 9, 1915) and Mary Louise (Brown) Smith (born August 4, 1912). Debbie's mother, Judith Louise (Isaacs) Smith Cutler was born on January 10, 1941 the daughter of Claud Taylor Isaacs (July 30, 1898 - January 1973) and Thelma Catherine (Starkey) Isaacs (August 25, 1901 - September 1982). Debbie's parents, Frank and Judy, met at a Baptist Youth Rally and were married on August 30, 1959. They had four children: 1) Rebecca Lynn (Smith) Claxton, born October 13, 1962; 2) Deborah Dawn (Smith) McCullough; 3) Matthew Russell Smith, born August 14, 1971; and 4) Daniel Isaac Smith, born July 14, 1972. Debbie's parents are now divorced and have both remarried.

Debbie graduated from Greensburg High School in May of 1985 and from Ball State University in December of 1988 with a Bachelor's Degree in Psychology. Willie and Debbie met at the Greensburg roller skating rink in 1982 and they dated for six years before their marriage in 1989. Willie continued working at Domino's Pizza until 1991 and occupied every position there from delivery driver to manager. He currently works at UPS and is studying Heating and Air Conditioning Technology at Ivy Tech in Indianapolis. Debbie is currently working at 70001 of Indianapolis which is a social service program for high school dropouts. She began graduate work at Indiana University-Purdue University at Indianapolis in Industrial/Organizational Psychology but has postponed her studies since the birth of their son, Sean William McCullough who was born June 14, 1993. They currently reside at 5006 Bethel Road, Indianapolis, IN 46254.

RICHARD(DICK) AND JOAN(SIS) DWENGER

Richard Francis Dwenger was born Oct. 1, 1931 in Decatur County, the first born son of Harry and Mary (hessler) Dwenger. He was one of ten children. He attended Lehman school and enjoyed hunting, fishing and trapping growing up. He served in the United States Army from 1952 until 1954, married Kathryn Joan Lawrence in 1955 shortly after her high school graduation from Greensburg High School. She is the daughter of Harry B. and Ethel (Keihn) Lawrence. She is one of five children: Charles Edward of Houston, Texas, Ronald D. of Greensburg and Mary Jean (Mrs. Danny) Hobby of Westport. Her brother, Harry Jr. and her father are both deceased. She attended Indiana University in Columbus and worked several years at Quince Consulting. She also had written articles for two newspapers and four racing magazines, has sold Aeon products for over twenty-five years and achieved Aeon Presidents Club.

In 1956 Dick took a job as a welder and fabricator at Ashly machine, became interested in Three-quarter midget race cars, built one, drove it until 1964 then drove for various owners. He has won several championships and honors in different racing Associations Championship again that year. He served in many capacities in the club. He raced in many states and Canada despite a severely damaged right arm, sustained in a racing accident in 1968. His most memorable win was a 100 world lap championship race on the paved track at the Indianapolis Speed Rome in 1974.

Dick and Joan had four children, Beverly Diane Roncone, born 1 1956 and lives with her husband Dom and their three daughters and her son from a previous marriage, in Hampton Bays Island, New York. Charles Eugene Dwenger born in 1959 and lives with his wife Shirley a few miles West of Greensburg. Their son Lawrence Joseph Dwenger was born in 1963 and lives with his wife Dawn. James Richard Dwenger was born on June 16, 1957 and died of Leukemia in Riley Hospital in Indianapolis on Oct. 5, 1958.

On their 25th wedding anniversary in 1980, their three Children hosted a surprise pig roast party for over one hundred relatives and friends then gave them tickets for a week long cruise to the Bahamas.

Dick built racing engines for midget race cars and worked at Ashly Machine until he was medically retired in 1991, suffering from heart, lung, and kidney problems which requires him to be on a kidney dialysis machine three days a week. Together, Dick and Joan still sell race car parts from the shop at their home, the same home that they moved into when they were married.

Beverly Diane was born to Richard Francies and Kathryn Joan (Lawrence) Dwenger in 1956 at Decatur Co. Hospital in Greensburg, In. She attended St. Marys School and graduated from Greensburg High in 1974. She had been involved in many school activities, on the gymnastics team, pom pom girl for two years, varsity cheerleader for two years, a member of and piano accompanist for the high school choirs, just to name a few. In 1975 she married Brian Lee Thackery, son of John and Marilyn Thackery of New Point, In. In 1976 they had a son, Brent Lee, who was born in Margaret Mary Hospital in Batesville In. Diane and Brian ended their marriage in 1981.

Diane and Brent moved too Florida, she got a job and married her boss, Dominick Roncone in 1982. They moved to East Islip, New York where Dom had grown up with his Italian Family, Salvatore and Ninfa Roncome, brother Joseph and Sister Connie. Diane and Dom had three daughters, Kathryn Anne born in 1992, Stephanie Ninfa, born in 1985 and Brittany Dominique born in 1991. All of them and Brent, who is an artist and works after school in an air brush studio live in Hampton Bays, Long Island New York. Diane enjoys scuba diving

and sail boating, Dom enjoys fishing and golfing. Together they enjoy camping and fishing.

Diane attends State University of New York at Stony Brook where she holds a teaching degree in English, she is a pre-law student, is on the deans list and is a member of the honor society. she works as a columnist at a local magazine Co. Dom, who holds a Bachelor of Arts Degree in economics at State University of New York at Albany, is Customer Service Representative at a car dealership.

James Richard was born to Richard Francis and Kathryn Joan (Lawrence) Dwenger June 16, 1957 at Decatur Co. Hospital in Greensburg, In. He had leukemia and died in Riley Hospital in Indianapolis, In. October 5, 1958. He is buried in St. Mary Cemetery in Greensburg, Indiana.

Charles Eugene was born to Richard Francis and Kathryn Joan (Lawrence) Dwenger in 1959 at Decatur Co. Hospital in Greensburg, In. He attended St. Mary School and graduated from Greensburg High School in 1977. Shortly after graduation he moved to Batesville but kept his job at Delta Faucet in Greensburg where he had worked since 1976.

In 1978 he married Kelli Ann Collins, an only child of Emerson and Ann (Wise) Collins but the marriage only lasted two years. There were no children. Charles and Shirley (Hash) Beard were married in 1987, she had three sons by a previous marriage, Jeff who is serving in the United States Army in New York, Steve and Chrism who live at home. Shirley is a computer operator at K.B. Specialty Foods in Greensburg. For several years Charles was a professional disc jockey but gave that up to be co-owner of a Three Quarter Midget race car, a Champion asphalt track car, with his brother, Larry. He also does fiber glass body work and engine work on the other midget cars Larry owns. He is a machinist at Zimmermann Brothers Speed Shop in Greensburg and lives in a country home a few miles West of Greensburg.

Lawrence Joseph was born in 1963 to Richard Francis and Kathryn Joan (Lawrence) Dwenger at Decatur Co. Hospital in Greensburg, In. He attended St. Marys school and graduated from Greensburg High School in 1981. He was born with a blood clotting deficiency disease known as Hemophilia. Although he has suffered through several life threatening situations he has led a very fulfilling life because of his courage, faith and positive attitude. He married his high school sweetheart, Dawn Combs in 1987. Dawn has two brothers, Ronnie who drive on of Larrys midget race cars, and Chris who lives with his mother, Sharon.

Larry is manager of Zimmermann Brothers Speed Shop in Greensburg. Besides being co-owner of the champion asphalt track Three Quarter Midget race car with his brother, Charles, he also owns three other midget race cars, has been champion car owner and mechanic of the year five years plus many other honors. He has served the local club as Vice President, President, Chairman of the Board of Directors, technical committee and other capacities. His wife, Dawn, is official track photographer for the United Midget Racing Association and they travel to several states and Canada year around. They live in Greensburg and have no children.

Leonard J. & Janet M. (Burgmeier) Dwenger

Leonard J. Dwenger was born on Jan. 15, 1935 in Decatur County, the son of Harry and Mary (Hessler) Dwenger. He attended Napoleon High School. He was one of ten children.

He met Janet M. Burgmeier daughter of Nora M. and Edwin J. Burgmeier (born March 16, 1945) in 1963 right after getting out of the Army. She is one of five children Darlene (Huff); Daniel; Arlene (Cook); Donald; Janet (Dwenger). Edwin born on Sept. 21, 1907; passed away Feb. 17, 1983. Nora born May 13, 1913; passed away May 19, 1978. Edwin and Nora were married on Dec. 27, 1937.

Leonard and Janet were married on Oct. 24, 1964. They had two children; Terrica born on 8-10-64 and Todd 12-25-67. Terrica married Wm. A. Moorman on Oct. 3, 1987. They had one child Jacob A. Moorman born Aug. 8, 1993 at Greensburg.

We own a package liquor store in New Point, In. since 1977; I'm owner and operator. Leonard works as sewage foreman for the City of Greensburg.

William A. & Terrica (Dwenger) Moorman

Terrica Lynn Dwenger born August 10, 1965 in Greensburg, In. Attend St. Mary's Catholic School grade 1-6; Greensburg Junior High grade 7-8; Greensburg High School grade 9-12. I like tennis, I make crafts and do several local craft shows.

I remember Grandma as being very patient and always understanding when we were little and even as teenagers. I think she has to be the sweetest, kindest person I have ever known. I met Bill in October of 1985 at a wedding reception I worked at Rust Wholesale Co. in Greensburg for 6 years. I started as a typist and worked up to an administrative supervisor. I quit in August 1991 when our son was born. We married in Oct. 3, 1987 at St. Mary's Catholic Church. I married William A. Moorman, born Sept. 2, 1966 at Cincinnati, Ohio. He has owned his own construction business since 1987 called Meyer and Moorman Const. He likes to fish, hunt and golf and anything outside. We reside at 1065 Sawmill Rd. Batesville, In. We have one child Jacob A. Moorman born August 1993 in Greensburg Indiana. We will be married 6 years this in 1993

Bill parents; Virgil F. Moorman born Oct. 19, 1932 at St. Mary's In. Patricia A. Braun born Sept. 7, 1932 in Cincinnati, Ohio. They were married in Cincinnati, Ohio. They had five children James; Pam (Eckstein) Rick; Bill; Melissa.

Todd M. Dwenger

Todd M. Dwenger was born Dec. 25, 1967 at Greensburg. Has one sister Terrica Moorman. Graduated from Greensburg High School in 1985, graduated from Vincennes University in 1988 with a Associates Degree in Marketing and Management. His hobbies include golf. Been working at James Rivers the past 2 years.

I, MARY ELLEN (DWENGER) VEERKAMP WAS BORN IN A FARM HOME FOUR MILES EAST OF WESTPORT, INDIANA, TO MY PARENTS, HARRY JOHN AND MARY CECILIA (HESSLER) DWENGER. THE DATE WAS JUNE 29, 1937. MY DADDY WAS BORN FEBRUARY 19, 1898, NEAR KINGSTON IN DECATUR COUNTY, FUGIT TOWNSHIP. MY MOM WAS BORN IN MARION TOWNSHIP, DECATUR COUNTY, NEAR THE SMALL TOWN OF MILLHOUSEN, ON NOVEMBER 17, 1901. THEY WERE MARRIED AUGUST 29, 1923. DADDY DIED AT HIS HOME NEAR MILLHOUSEN, ON JANUARY 6, 1966.

MY BROTHERS AND SISTERS AND THEIR BIRTHDAYS:

MARY KATHLEEN (DWENGER) SCHEIDLER	JUNE 5, 1924
ESTHER ANN (DWENGER) MARTIN	SEPTEMBER 30, 1925
ROSELIA CECILIA (DWENGER) POWERS	FEBRUARY 21, 1927
RUTH ELENORA (DWENGER) HAMILTON	MAY 27, 1928
ANNA MARIE (DWENGER) MCCULLOUGH	DECEMBER 14, 1929
RICHARD FRANCIS DWENGER	OCTOBER 1, 1931
MARTHA ELIZABETH (DWENGER) HARRIS	JUNE 27, 1933
LEONARD JOSEPH DWENGER	JANUARY 15, 1935
MYSELF	JUNE 29, 1937
EDWARD JOSEPH DWENGER	SEPTEMBER 2, 1947

THE FIRST SCHOOL I ATTENDED WAS A ONE ROOM SCHOOL, LEHMAN SCHOOL, ABOUT A MILE FROM HOME. ON GOOD DAYS WE WALKED TO SCHOOL, WHEN IT WAS REAL BAD WEATHER DADDY TOOK US TO SCHOOL. WE HAD TO GET UP REAL EARLY FOR THAT DADDY WAS THE SCHOOL "HACK" DRIVER. HE ALSO STARTED THE "ROUND BELLY" STOVE FOR US SO WE COULD BE WARM. HE MADE 3 TRIPS WITH HIS CAR TO PICK UP KIDS THAT LIVED FARTHER FROM SCHOOL THAN ONE MILE. WHEN I REACHED FIFTH GRADE, THE "BIG YELLOW SCHOOL BUS" CAME TO THE COUNTY. THEN DADDY FOUND ANOTHER JOB, IN ADDITION TO FARMING.

THAT WAS WHEN I MET CARL, BUT AT THAT POINT I WASN'T INTERESTED IN BOYS! WE BOTH WERE IN THE FIFTH GRADE. WHEN WE STARTED IN HIGH SCHOOL, CARL WENT TO NAPOLEON HIGH AND I WAS SENT TO SANDCREEK HIGH - FROM WHICH I GRADUATED FROM IN 1955.

CARL WILLIAM VEERKAMP, SON OF JOHN AND HILDA (HARDEBECK) VEERKAMP, WAS BORN AT HOME WEST OF MILLHOUSEN ON FEBRUARY 14, 1937. HE ATTENDED MILLHOUSEN SCHOOL THE FIRST FOUR YEARS, THEN MILLHOUSEN CATHOLIC GRADE SCHOOL, AND THEN ON TO NAPOLEON HIGH SCHOOL.

AFTER SCHOOL WE BOTH WENT TO DANCES AT MILLHOUSEN KNIGHTS OF ST. JOHN HALL. WHEN CARL ASKED ME TO DANCE, OF COURSE I SAID "YES". WE BECAME ENGAGED ON CHRISTMAS EVE, 1957, AND MARRIED SEPTEMBER 23, 1958 IN ST. DENIS CATHOLIC CHURCH IN JENNINGS COUNTY, INDIANA.

OUR FIRST HOME WAS AN APARTMENT IN MILLHOUSEN. THEN SEVERAL MOVES LATER, WE HAD A NEW HOME THAT WE HAD BUILT LOCATED 5 MILES SOUTH OF GREENSBURG. BY THAT TIME WE HAD OUR FIVE CHILDREN WHO WERE ALL ATTENDING GREENSBURG SCHOOLS.

OUR CHILDREN ARE:

CARL JOHN VEERKAMP - BORN JUNE 21, 1959
SHIRLEY ANN VEERKAMP - BORN SEPTEMBER 2, 1960
KAREN MARIE VEERKAMP - BORN MARCH 4, 1962
TWINS ROBERT ANTHONY VEERKAMP - BORN FEBRUARY 19, 1964
RONALD JOSEPH VEERKAMP - BORN FEBRUARY 19, 1964

CARL JOHN LIVES IN GREENSBURG, INDIANA. HE OWNS AND OPERATED VEERKAMP TRENCHING FROM HIS HOME IN GREENSBURG, HOUSING HIS EQUIPMENT ON HIS FATHERS FARM. HE NEVER MARRIED.

SHIRLEY ANN AND DENNIS JAY BECKER WERE MARRIED OCTOBER 24, 1987, AND LIVE IN BATESVILLE, INDIANA. "JAY" WAS BORN MARCH 24, 1955. THEY HAVE 2 BOYS, BENJAMIN JAY, BORN SEPTEMBER 1, 1988, AND ZACHARY PAUL, BORN AUGUST 29, 1991.

KAREN MARIE AND ROGER EDWARD KOORS (BORN JUNE 3, 1961) CHOSE JUNE 2, 1984 FOR THEIR WEDDING DAY. THEY HAVE FOUR CHILDREN, CRAIG EDWARD, BORN JUNE 13, 1986; ROBERT WILLIAM, OCTOBER 10, 1988; JENNIFER MARIE, DECEMBER 29, 1989, AND KRISTEN BRIANNA BORN ON SEPTEMBER 8, 1992.

OUR BIG "SURPRISE" HAPPENED ON FEBRUARY 19, 1964, (DADDY DWENGER'S BIRTHDAY) WHEN WE BECAME PARENTS OF HEALTHY TWIN BOYS: ROBERT ANTHONY AND RONALD JOSEPH.

ROBERT ANTHONY AND MICHELLE ANN DIEKHOFF WERE MARRIED ON THE 2ND DAY OF JUNE, 1990. SHEL WAS BORN DECEMBER 5, 1967. THEY LIVE NEAR INDIANAPOLIS, IN A SMALL TOWN, PLEASANT VIEW.

RONALD JOSEPH AND ANGELINE MARIE TUCHER WERE MARRIED OCTOBER 4, 1986. THEY HAVE 2 SONS, TYLER JOSEPH, BORN FEBRUARY 12, 1990, AND KYLE JAMES ARRIVED NOVEMBER 18, 1992.



Center group--L.to R. back row--Ron, Bob, Carl Sr., & Carl J. Veerkamp - Front- Karen Koors, Mary Ellen Veerkamp & Shirley Becker--Grandchildren clockwise from top right, Tyler & Kyle Veerkamp; Kristen, Jennifer, Bobby & Craig Koors; Zachary & Ben Becker.

Personal History of Edward J. Dwenger

Edward Joseph Dwenger was born on September 2, 1947, in Denver, Colorado, to his parents, Harry J. and Mary C. Dwenger. He joined 7 sisters and two brothers, and soon became known as Eddie Joe to the family. He was raised on a 97 acre farm in Southern Decatur County near St. Dennis Church in nearby Jennings County, on County Road 200 West between County roads 1000S and 1100S.

When Eddie was 13 years old, the house burnt and they moved to Al Redelman's place near Millhousen for eight years, graduating in 1961. He then attended Sandcreek High School near Westport for four years, graduating in 1965. His father passed away in January, 1966. His mother is currently a resident of the Odd Fellows Home in Greensburg.

Eddie served his country in the U.S. Army Reserves from May, 1966 to March, 1971, receiving an Honorable Discharge.

In November of 1966 he married Janet M. Greiwe and they had two sons, Brian Edward born 9-9-67 and Christopher Michael born on 3-9-70. Eddie and Janet were divorced in 1970. Janet remarried John French and had the boys' names changed to French. Brian and Debbie Ritchison were married in November of 1987 and have two children, Kyle Andrew and Julie Ann. Chris and Janet Templeton were married and have two children, Brook Nicole and Skylar Michael.

Eddie married Brenda L. McIntyre, the daughter of Oral and Lelia McIntyre on Jan 2, 1971. They share a daughter, Tracy Michelle born 8-23-68. They also have two sons, Edward Joseph II born 3-26-71 and Jason Richard born 4-22-72. Tracy married Martin P. Hittle and they have a daughter Trenda Jo and a son Nathaniel Page. Tracy and Martin were divorced in 1993. Edward Joseph II was always known as Joe. He married Melissa Moorman in August of 1993. They have a son, Andrew Michael. Jason married Niki Meyer in 1992.

All five of Eddie's children were baptized in St. Mary's Catholic Church in Greensburg, Indiana. Eddie and Brenda are very active at St. Mary's, currently as of this writing, serving as Ministers of Hospitality and Eucharistic Ministers as well as delivering the Eucharist to the sick and shut ins.

Eddie has always been involved in the community around him serving as a Republican Precinct Committeeman in Greensburg as well as serving on several Election Boards over the years. He served as a coach of Youth baseball for eight years and was the President of the Greensburg Youth Baseball program in 1981. He served as a basketball coach for the 5th and 6th grades at St. Mary's in 1981 and 1982. He served as a member of St. Mary's Parish Council from 1990 to 1993, with duties on St. Mary's Board of Education in 1991. He is a member of the Knights of Columbus council 1042 in Greensburg serving various offices including the Grand Knight from 1991 to 1993. He is a Past Cub Scout Master of Pack #500 as well as serving as Webelos Leader. He restarted the Columbian Squire Circle #2547 in 1989 winning many State Awards. He currently is serving as a member of the Decatur Co. Parks & Recreation Board and the Nominating Committee for the Decatur Co. REMC. He is also a member of the Indiana State Championship Knights of Columbus bowling team of 1993. He has always been active in organized sports participating in Volleyball, Basketball, Slow Pitch Softball and Bowling in the Greensburg and Westport areas.

Eddie has been employed since 1971 in the business of Plastic Packaging, working for Crown Zellerbach and later James River Corp which bought Crown in 1986. He is currently working as a Shift Supervisor in the Printing Department.

He and Brenda have travelled throughout most of the United States. Camping was a large part of their lives during their child raising years. Eddie was a big fan of his brother Dick's racing career, traveling with the race team in the early 1970's until his job finally prevented it. This love of racing has later expanded to annual trips to the Indianapolis 500 and the NASCAR race in August at Watkins Glen, New York.

Eddie's love of Football centers around the only team he could really cheer for, the Chicago Bears. This comes from his friendship with Randy Jackson whom he met in the military and was a lineman for the Bears in the late 1960's. Sports statistics seem to come easy to remember and he often receives calls from friends about some trivia.

Music has always been a big part of the Dwenger household, with radio or tapes being heard often. Recently, this has been expanded with trips to Nashville's Opryland, Music Row and Memphis with many more expected.

RAVER

John Henry Raver b/1806 Germany d/1879 In.
m/around 1832

Margaret Adelaide Nienaber b/1803 d/1864 In.

CHILDREN OF JOHN AND MARGARET:

1. b/1833	2. b/1834	3. b/1837	4. b/1839	5. b/1842	6. b/18--	7. b/1844	
Henry m/ not married died at age 21 1853	Maria m/1854 Theodore Dedrich Mayer <u>Child:</u> 1. <u>John August</u> m/ Helena Luttle one child: Harry 2. <u>Katie</u> m/ Charles Ronnebaum child: Henry Bernard Hilda 3. <u>Mary</u> m/ William Hermesh child: William F. Henry John Rose (Kohlman) Veronica (Kappes) August 4. <u>Elizabeth</u> m/ Henry Fehrman child: Elizabeth (Osterling) Matilda Eleanor (Haskamp) Gwenavere Mary (Flodder) 5. <u>Anna</u> m/ John Volk child: William J. Agnes Elenora (Doyle) Leo Frank 6. <u>Francis</u> m/ Henry Luttle child: Henrietta (Wright) Clara (Schwegman) 7. <u>Carolina</u> m/ Clem Fisher <u>child:</u> Frank Cornelious Stanley John Odella Linda Amos Courtney 8. <u>Minnie</u> died early	Gosina m/ died on Jan. 19, 1853 age 16 Oldenburg In.	John m/1858 Kate Beckschulte <u>Child:</u> 1. <u>John</u> b/1860 m/ 2. <u>Maggie</u> m/ Crammer 3. <u>Benjamin</u> m/ died young 4. <u>William</u> never married 5. <u>Frank</u> never married 6. <u>Henry</u> never married 7. <u>Katie</u> 8. <u>Jula</u>	Catherine m/1860 William Dwenger <u>child:</u> 1. <u>John</u> m/ Elizabeth Weibold child: John Elizabeth 2. <u>William</u> m/ Magdelina Weimer child: John Caroline Harold 3. <u>Frank</u> m/ Anna Selbel child: Raymond Hilmer Harry Stella Martha (Stier) Eilon (Reis) 4. <u>Bernard</u> m/ Elizabeth Haskamp <u>child:</u> Joseph Edwin Maurice Roman Joanna Loretta Alma Mary Betty 5. <u>Carrie</u> m/ Henry Seibel child: Eleanor (Peters) Arthur Mable (Allen) Rosemary (Kirschner) 6. <u>Henry John</u> m/ Anna Huth child: Leo Victor Hilda Olivia Norbert Emma Eddie Alvina (Nobbe) Alfred Clarence Waldo Clara (Niese) Stella (Tekulve) Paul 7. <u>Francis</u> died age 7 8. <u>Vincent</u> died young	Elizabeth died at a young age	Frank F. m/1865 Anna Lamping <u>child:</u> 1. <u>Henry</u> m/ Margaret Luttel child: 1. William 2. Joe 3. Clara 2. <u>Mary</u> died of croup 3. <u>Anna</u> died of croup 4. <u>Frank J.</u> m/ Mary Bunnemeyer 1. Clemes 2. Walter 3. Raymond 4. son (died infancy) 5. <u>Benjamin</u> m/ Bernadine Kuntz 6. <u>Amelia</u> died at age 12 years 7. <u>Francis</u> m/ Henry Schwegman child: 1. Cecilia (Wolter) 2. Joe 3. Dorothy 4. Francis (Berkemeier) 8. <u>Anna</u> m/ Joe Huser m/ #2 Henry Suhre 1. John (Father Roger) 2. Edgar Suhre 3. Edith Suhre (Weigel) 9. <u>George J.</u> m/ Elizabeth (Lilly) Wanstath 1. <u>George Jr.</u> 2. <u>Eloise</u> (Berkemeier)	7. b/1844

4. b/1862	2. b/1863	3. b/1865	4. b/1868	5. b/1872	6. b/1874	7. b/1875	8. b/1876
John Dwenger m/ Elizabeth Weibold <u>child:</u> 1. John m/ Anna Hessler 2. Elizabeth	Bernard m/ Elizabeth Haskamp <u>child:</u> 1. Joseph 2. Edwin 3. Maurice 4. Roman 5. Joanna 6. Loretta 7. Alma 8. Mary 9. Betty	William B. m/ Magdelina Weimer <u>child:</u> 1. John m/ Margaret Cahill 2. Caroline 3. Harold m/ Leona Hahn	Frank J. m/ Anna Seibel <u>child:</u> 1. Raymond 2. Hilmer 3. Harry 4. Stella 5. Martha 6. Ellen	Henry m/ Anna Huth <u>child:</u> 1. Leo 2. Eddie 3. Alvina 9. Alfred 4. Olivia 10. Clarence 5. Norbert 11. Waldo 6. Emma 12. Clara 13. Stella 14. Paul	Carrie m/ Henry Seibel <u>child:</u> 1. Eleanor m/ Ed Peters 2. Mabel m/ Sam Allen 3. Rosemary m/ Kirschner	Francis died in 1883 Hamburg	Vincent died in 1879

JOHN RAVER AND ADELAINA(NIENABER)RAVER

John Henry Raver was born on April 15, 1805 in Hanover Germany. He originally came from Germany around 1828, by way of Baltimore, Maryland. He remained there for a few years before moving to Ohio.

John Raver was married to Margaretha(Adelaine) Nienaber, born on April 8, 1801 in Hanover Germany.

Margaret Adelaide was the daughter of Theodore Coonrad Nienaber (b/1766 Hanover Germany-d/1854 Indiana), who was also a Ray Twp. settler, and a native of Germany. She was one of four children: Gerhard b/ 1795, John F. b/1799, John Albert b/1800, Margaret Adelaide b/1801.

John and Adelaine had two children while living in Maryland, Henry Raver born in 1833, and Maria Raver born in 1835.

They left Maryland around 1836 and traveled to Cinn. Ohio. Where two more children were born, Elizabeth and Gena, both appear to have been born in 1837 in Ohio. Shortly thereafter they moved West to Franklin County in Indiana.

John and Margaret Adelaine were Catholic, and members of the Oldenburg Catholic church. He came to Franklin County Indiana as a young man. He purchased two farms, 80 acres each, in Ray township (Range? twp.?), He was one of the earliest settlers in the area.

John Raver cleared his land and he established a successful farm where he and his family lived, known as "the old Raver Homestead" East of Salt Creek in Franklin Co., now owned by Hillenbrands Corp.

According to record books at Franklin Co., John Raver sold a portion of land to his son-in-law Theodore Dedrich Meyer, (80 acres) on March 31,1869.

John Raver died on Jan. 6, 1879 at Franklin Co. Indiana, He did leave a will, on which for his signature, he made his mark, in place of signing his name.

Margaret Adelaine Raver, died on Feb. 27, 1864, in Indiana. both are buried in Franklin County.

John and Margaret Raver were the parents of seven children:

1. Henry Raver, (Born 1833 M.D.- died Jan.9,1897) at age 21, from a large limb falling from a tree on him.
2. Elizabeth Raver, born in 1837- and who, died young(no dates).
3. Mary Raver, born in 1835 M.D. and married on Jan. 19, 1854 to Theodore Dedrich Meyer. She died on March 3,1897.
4. John Francis Raver, born in 1840 in Indiana. He was married on May 29, 1858 in Franklin Co. In. to Catherine Barksholt. They were the parents of five sons and three daughters.
5. Catherine Raver, born on April 13, 1842, she was married on Nov. 8, 1860 to William Dwenger. They were the parents of seven children. They owned a store in Hamburg.
6. Francis Raver was born on May 20, 1844 in Franklin Co. He was married on Nov. 1, 1805 at Oldenburg to Anna Lamping. They were the parents of eight children.
7. George J. Raver was born ?, he was married on Oct. 20, 1909, to Lillian(Elizabeth) Wanswrath. They were the parents of two children: Eloise and George.
8. Gesina Raver was born in 1837 in Ohio.(I have no other info.) d/Jan.19,1853 Oldenburg, IN.

211 Estate of John Roeser Probate of Will,

517

By it remembered that on the 29 day of September, 1877 the last Will and Testament of John Roeser late of Franklin County, Indiana deceased was admitted to Probate and Record in the words and figures following to wit

In so name of the Bancroft Judge of Alb.

I John Roeser of Franklin County and State of Indiana do make and publish the following my last will and testament,

- 1 It is my Will that all my just debts and funeral expenses be paid first,
- 2 I give and bequeath to my beloved son Francis Roeser all my Real Estate consisting of One hundred acres, and also the Stock and the other property on the farm to be his and his heirs forever he however being to my son John Roeser, and to my daughter Catharina now the Wife of William Swenger, each of them three hundred Dollars, to be paid to them two years after my death. A Warranty Deed of my Real Estate having been made and signed by me bearing the same date of this, shall be delivered to him six weeks after my decease.
- 3 I give and bequeath to my son John Roeser and to my daughter Catharina now the Wife of William Swenger all my outstanding money and my money on hand, to be divided equally, excepting that my daughter shall receive fifty Dollars extra before division.
- 4 I give and bequeath to my daughter Maria now the wife of Theodore Meyer five Dollars to be paid her out of my money because she having received already Eight Hundred from me.
- 5 I hereby nominate and appoint my son Francis Roeser Executor of this my last Will and testament.
- 6 I hereby revoke all former wills by me made

in witness whereof I have hereunto set my hand and Seal this 15th day of August A.D. 1874.
John Roeser (Seal)
Signed and sealed and acknowledged by said John Roeser

①
This Indenture Witnesseth That

John Henry Raver

Convey and Warrant unto

Abner Meyer

and his heirs and assigns for the sum of (\$800) Eight hundred Dollars the receipt of which is hereby acknowledged, the Paul Estate in Cass County, Indiana, described as follows, to-wit:

All the West half of the North West quarter of Section twelve (12) of Township No. ten (10) of Range Eleven (11) East of the second principal Meridian line in the District of lands subject to sale at Cincinnati, Ohio containing 80 acres according to the official survey and in the name granted by Henry Harpall by the U.S. by patent dated the first day of August 1838 and recorded in Vol. 15 page 174 in the General Land Office



↑
Vol. 15 p. 12

12 - 10 - 11E

with the appurtenances, to hold the same unto his heirs and

Frank F. Raver m. Anna Lamping
5-20-1844 3-31-1846
2-1-1916 3-20-1923
11-14- 1865

1887-1954 George J m. Elizabeth M. Wanstrath 1885-1946
8-29-1885 10-20-1909
2nd m 5-22-20 Anna m. Joe Huser - Henry Suhre b 10-29-1875
Frances m. Henry Schwegman m. 10-28-1903
Amelia 12 yrs. d.
Philomenia m. Anthony Zeigler
1875-1961 Benjamin m. Bernadine Kuntz 1877-1957
Frank J. m. 1898 Mary Bunnemeyer
Anna d. croup
Mary d. croup
1866-1951 Henry m. Margaret Luttel 1869-1902
m. 10-23-1889 Henry died 4-15-51, 84 yrs.,
1:30 a.m., Friday, @ son William's
Anna (Romer) Hilleford 5-23-1923
Mary Koetter Humpert

11-8-1860
Catherine Raver m. Wm. Dwenger
Store in Hamburg
Catherine d. 3-6-1891; b. 1841
48 yrs. 10 mo. 21 da.
Wm. b. Cin., Ohio 1-3-1839
12-21-1909
70 yrs.
P.O. 11-28-1882 to 4-5-1888 Wm. B.

Frank m. Anna Seibel
b. 1879 Mary Carolina m. 1899 Henry Seibel
1876-1879 Vincent
1874-1883 Mary Frances
1873 Anna Maria
1872- John Henry B. m. 1899 Anna Marie Huth
Antonius d. 1870
William m. 1887 Magdalena Weimer
P. O. 12-30-1890
Bernard m. 1885 Eliz. Haskamp
John m. Elizebeth Weiben

5-29-1858
John Raver m. Kate Beckschulte
moved to Ohio
John b. 1839

Lula
Katie
Henry
Frank
Willie
Ben
Maggie
John

1-19-1854
Mary Raver m. Theodore Meyer
Mary b. 1834 in Maryland

Minnie d. young
9-29-1871 5-26-1873
1-23-1931 Carolina m. Clemens Fischer 4-17-1956
1870 (21 yrs.) 2-27-1889 3-03-1865
1931 Frances m. Henry Luttel 9-26-1944
5-23-1867 8-1-1867
1-25-1927 Anna m. John E. Volk 1-18-1893 1948
1856-1922 Elizabeth m. Henry Fehrman 1852-1926
1855-1943 Mary m. Wm. Hermesch Roszburg m. 10-29-1874
Kate m. Charles Ronnebaum Shelbyville
John August Meyer m. Hellena Luttel 11-21-1888
d. 3-3-1911 (47 yrs.)d. 7-16-1910 (49 yrs.)

Elizabeth Raver
b. 1836 in Maryland
Henry Raver d. 21 yrs.
1832-1853 in Maryland

N: 8-1
ADELINE NIENABER
DIED: 2-27-1864

MARRIED
5
JOHN RAVEN
DIED: 8-31-1879



Frank and Anna(Lamping) Raver

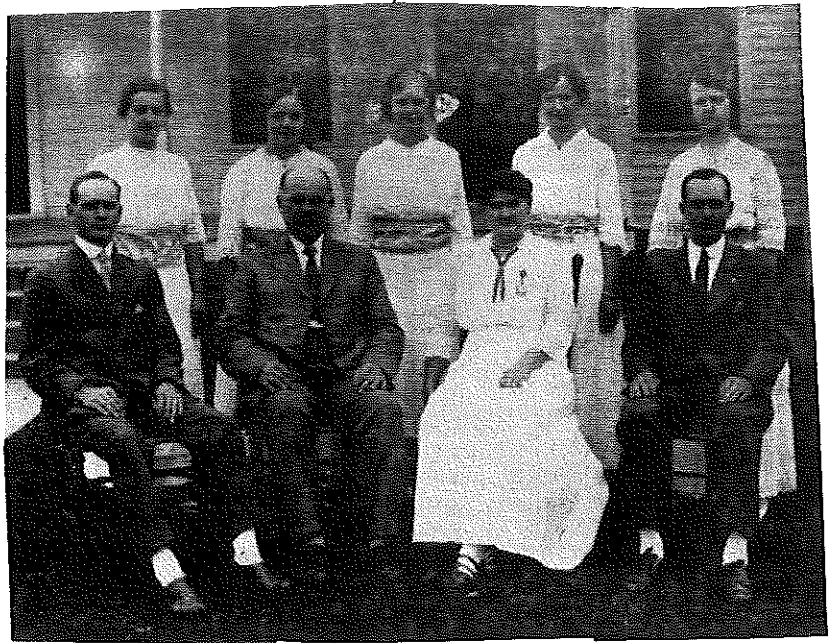

Family of Henry Raver

L to R:sitting-Bill, Henry, Anna (Romer), Joe
standing: Veronica, Loretta, Cora, Mayme, Clara

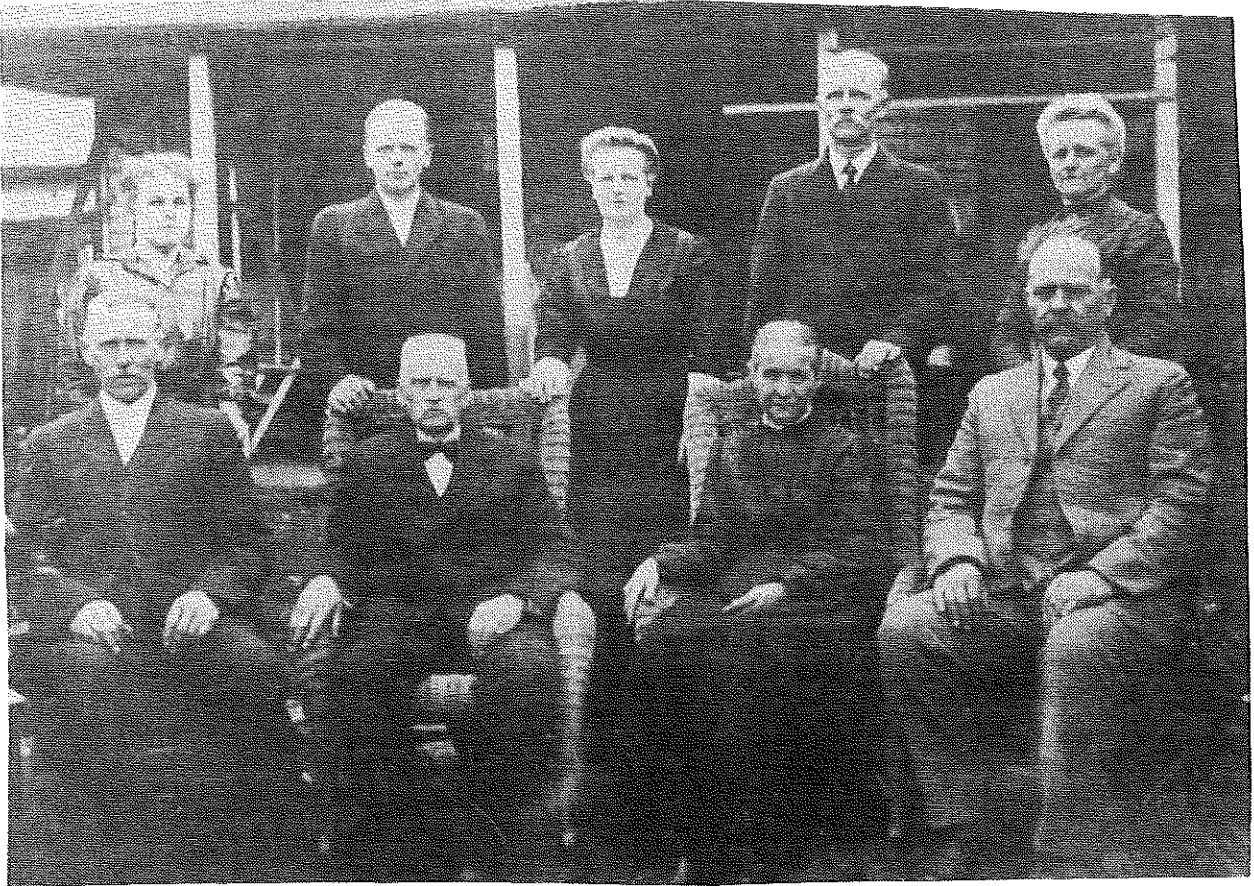

Golden anniversary of Francis and Anna(Lamping) Raver Oct.4,1914 with their children
standing: Anna(Huser)Suhre, George Raver, Frances(Raver)Schwegman, Ben Raver, Minnie Ziegler
sitting: Frank J. Raver, Francis F. Raver, Anna(Lamping) Raver, Henry Raver

MINNIE MEYER died young

1855-1943 Mary Meyer m. 10-29-1874 Wm. Hemesch	1856-1922 Lizzie Meyer m. 10-11-1876 Henry Fehman 1852-1926	THEODORE MEYER (DEIDRICH MEIER) August Meyer m. Charles Ronnebaum Shelbyville 11-21-1888	MARRIED MARY RAVER 01-19-1854 1870-1931 Frances Meyer m. 02-27-1889 Henry Luttel 03-03-1865 09-26-1944	09-29-1871 01-23-1931 Caroline Meyer m. 9-26-1894 Clemens F. Fischer 05-25-1873 04-17-1956	03-26-1895 05-03-1973 Frank m. Marie Obermeyer 09-06-1900 06-30-1974	08-14-1896 11-17-1972 Stanley E.	10-30-1898 07-08-1985 John	11-26-1900 04-12-1920 Odella	04-11-1902 10-17-1984 Linda	06-26-1905 06-30-1964 Cornelius m. Viola = Joseph	b.07-07-1908 d.11-1983 b.08-30-1910 d.06-01-1961
					Henrietta b. 12-6-1898 bapt. 12-7-1898 buried in South Park m. Clarence Wright						
					William J. b. 09-17-1894 d. 04-20-1977 m. 09-15-1919 Anna Maria Wessling 01-19-1894 10-15-1975		Agnes Magdalena 01-22-1897 06-25-1921	Eleanora Mary Bernadine (Nora) b. 04-30-1901 d. 09-30-1932 m. James Wm. Doyle 05-02-1906 10-30-1970 m. on 03-14-1931	Leo Frank b. 10-29-1905 d. 05-19-1958 m. 02-18-1925 Matilda Gigrich b. 11-29-1902 d. 02-07-1985		
					?? Henry 1880-1954 m. Cecilia 1883-1960		?? Bernard J. 08-24-1908 12-26-1975		?? Hilda C. 01-12-1902 10-02-1977		
					Henry Theodore (Harry) was about 47 yrs. when son, Glenn Meyers, b. m. a Methodist, Shelbyville Harry d. when son, Glenn Meyers, was 16 yrs. Harry's wife d. when son, Glenn Meyers, was 14 yrs.						
					Elizabeth b. 1880 d. 1960 m. Anthony Oesterling b. 1877 d. 1913	Matilda b. 1884 d. 1944 Sister	Henry m. Joseph C. Haskamp 1888-1933 m. 1890-1934 m. 1919 dgtr. Florine 1921-46 ?? Sylvester	Eleanora 1888-1933 m. Joseph C. Haskamp 1890-1934 m. 1919 dgtr. Florine 1921-46 ?? Sylvester	Genevive Mary m. Harry Flodder not m. b. 1890 d. 1972		
					1883-1964 Wm. F. m. Myrtle Maynard	Henry John	Rose m. Coleman	Veronica m. 5-20-1902 Charles F. Kappes	August not married 1886-1942		Harry Frank Kate m. Brockman

Mary Meyer and William Hermesch had a son, John Hermesch, who married Margarita Ritter. Three of their children were baptized at St. John Church, Enochsburg. Hilda was born 1-27-1907. Edwin was born 9-13-1908, and his baptismal sponsors were John and Anna Volk. Edwin married Leona Salatin on 4-11-1931 at St. Louis Church in Cincinnati, Ohio. Linda was born 6-12-1910.

Anna Meyer married John E. Volk. Their third child, Eleanora Volk, married William Doyle. Their only child, Doris Ann, married William D. Reed of St. Paul on 4-19-1952. They had Dale, Curtis, Cheryl, Brian, and Tina. Their fourth child, Leo F. Volk, married Matilda Gigrich. Their only child, Helen Nora, married Albert H. Stuhrenberg on 8-20-1952. They had Teresa, Anthony, Rose Ann, and Thomas E. Albert died on 8-14-1964.

Frank Fischer married Marie Obermeyer, and they had one son and two daughters. The eldest, Clara, married Kenneth Bedel of Oldenburg. There were several descendants.

The seven children of Henry H. and Margaret (Luttel) Raver were Joseph Raver, who married Addie Schulte. Their daughter, Margaret, married Quirin Gauck. They had four sons and one daughter. Their son, Louis Raver, married Marian Geis in August, 1951, and they live in Anderson. There were children born of this marriage.

Clara Raver married John Schulte. Their son, Clarence, never married, but their daughter, Martha, married Alfred Blankman of Millhousen on 10-2-1946. They moved on a farm east of Rushville, Indiana, and are the parents of three girls and one boy.

William Raver married Rose Ricke. Their daughter, Esther, married Albert Wallpe. Their only son, Hubert, married Esther Volk on September 27, 1952. They live on the ancestral farm. Dorothy married Steve Scheidler. Roselyn married Maurice Hoeing. They are all blessed with children.

Veronica Raver married Frank Hellmich. Their only child, Helen Marie, married Harold Klosterkemper on June 21, 1951. They have a son and daughter. William Raver and Veronica Raver were twins.

Mayme Raver died.

Loretta Raver married William Holtkamp. They were the parents of Walter, who died as a young child. Leonard married Ella Mae Cramer. Robert married Pauline McDermott. Raymond married. Maurice John died in a garage incident when he was about sixteen years old. There were several descendants.

Cora Raver married Harry Meyer, whose son, Alrod, married Mary and has a family. Cora and Harry's daughter, Rita, married A. Anthony Etter, and they have children.

Frank J. Raver, who was born 3-17-1873 and died in 1947, married Mary Bunnemeyer, who was born in 1872 and died in 1941, in 1898. They and their four children lived on a farm where Theodore Meyer had lived. Their four children include Clemens Raver, who married Anna Berkemeier of St. Maurice; Walter, who married Eleanor Harmeyer; Raymond, who married Loretta Harmeyer; and an infant son. Clemens and Anna Raver were the parents of five. Their children were a daughter, Irene, who married Ray Schutte on 8-21-1946. Their children are Raymond, David, Donald, James, Marijean, Daniel, and Karen. A son, Paul Raver, married Shirley Schultz on 10-25-1947. Their children are Barbara, Paul, Rita, Mark, and Beth. Rita Raver married Thomas

Grieshop on 10-23-1948. To this couple were born Timothy, Jeffery, Lisa, and Sandy. Dolores Raver married Fran Walke on 6-30-1951, and their children are Cheryl, Janet, Steve, Joan, and Carol. Marjorie Raver married Lowell Yorn on 7-30-1955, and their children are named Kathy, Kerry, Kirk, and Kendall.

Benjamin Raver married Bernadine Kuntz. Their children were Emma, who married Henry Krome; Clarence; Anthon; Angela, who married Walter Cramer; Bernadine, who married Roman Federle; Edwin, who married Lillian Long; and Anne, who married Anthony Federle.

Philomena (Minnie) Raver married Anthony Zeigler. Their children were Leonard, who married Mary Koehne; Clara, who married Bernard Harmeyer; Ralph, who married Bernice Schwegan; Ruth, who married Cliff Kunkel; and Leona, who married Al Wagner of Hamburg.

Amelia Raver died at the age of twelve.

Frances Raver married Henry Schwegman on 10-28-1903. To this union were born Dorothy and Joseph, who never married. Frances Schwegman married Joseph Berkemeier on 8-20-1941 and have living sons. Cecilia Schwegman married Joseph Wolters, and she died in childbirth and was buried at St. John's, Enochsburg.

Anna Raver married Joe Huser, and he died about one year later. Their son, John, became Father Roger OFM. Then Anna married Henry Suhre. Born to this union were Edgar and Edith. Edith married Robert Weigel.

George J. Raver married Elizabeth (Lillie) Wanstrath on 10-20-1909. Their two sons were George, who married Lorene Struewing, and Norman, who married Norma Struewing. Their daughter, Eloise, married Bernard Berkemeier of St. Maurice. They were parents of one daughter, Eileen. Eileen Berkemeier married Charles Fisse, who are the parents of six.

FRANK J. RAVER FAMILY

Among the progressive young farmers of Franklin County, who have achieved a considerable measure of success in their chosen vocation, is Frank J. Raver, of Ray Township. Mr. Raver has impressed his personality upon the citizens of the township where he lives and is today ranked as one of the leading factors in the community of that township.

Frank J. Raver was born March 17, 1873 in Ray township, four miles west of Oldenburg, In. the son of Frank F. and Anna (Lamping) Raver, the farmer a native of Ray township, born May 20, 1844, and the latter born March 31, 1846.

The paternal grandparents of Frank J. Raver were John and Adeline (Nienaber) Raver, the farmer of whom was a native of Germany. He came to America as a young man and settled in Ray township, where he bought two farms of 80 acres each. The Raver family was one of the earliest families in this part of Franklin Co. John Raver and his wife were the parents of five children: Henry, who died at the age of 21; John; Frank; Mary, who married Theodore Meyer; and Catherine, who married Wm. Dwenger. Frank F. father of the subject of this sketch, is the only living child born to this marriage. The family were Catholics and members of the church of Oldenburg.

Frank F. Raver was educated in the public schools of Ray township and as a young man began farming in his father's farm. For many years he operated a threshing machine in connection with farming. He moved to Oldenburg about 1893, previously owning a farm of 200 acres. After moving to Oldenburg he sold farming implements for about 15 years, but is now living a retired life. He and his wife were the parents of the following children. Henry, a farmer of Decatur County, who married Margaret Little, Anna and Mary, both of whom died young; Frank, Benjamin, who married Bernadine Keentz; Phelomena, who married Anthony Ziegler and lives on the old home farm in Ray township; Amelia, who died young; Frances, who married Henry Schwegman of Decatur Co., Anna, who married Joseph Huser, deceased, and George, who married Elizabeth Wanstrath and lives in Ray township. The Family are all members of the Holy Family Church at Oldenburg.

Frank J. Raver, the subject of this sketch, was educated in the Enochsburg School. As a young man he started in with his brother in the threshing business. They also did job sawing and followed his business for 5 or 6 years. Then Frank J. Raver went to Oldenburg and bought out a blacksmith business, operating this for 2 years and then returning to his father's farm.

In 1898 Mr. Frank Raver was married to Mary Bunnemeyer, the daughter of Clemens and Agnes (Wielinberg) Bunnemeyer, who was born at Oldenburg, this county. Her father came from Dinklage, in Oldenburg, Germany, locating about 1850, in Cincinnati, where for 12 years he followed his trade as a sailor. At the end of that time he moved to Oldenburg, this county, where he resided for 40 years before his death. To the marriage of Frank J. and Mary (Bunnemeyer) Raver were born four children, Clemens, Waslter, Raymond and one son who died in infancy.

In 1898, the same year in which Mr. Raver was married, he moved to the farm 3 miles west of Oldenburg, which was owned by his father. In 1904 he bought the farm and now owns 159 acres. His is engaged in general farming and stock raising, as well as threshing.

Mr. Raver is a stockholder and director in the Farmers and Merchants Bank at Oldenburg. He is identify with the Democratic Party and is now a member of the advisory board, of Ray township. The family are members of the Holy Family Church at Oldenburg. Mr. Raver takes an active interest in questions affecting the interest of the public and is highly respected in the community.

FRANK J. RICKE, B 10-16-93, M 10-18-31, Mary C. Martin - D 12-14-49

No Children

ROSE AUGUSTA RICKE, B 12-23-1895, M 11-25-1920, William Frank Raver, B 6-30-1894

D 9-8-86 DESCENDANTS D. 7-31-78

Esther Catherine Raver, B 8-15-1921, M 6-22-1946, Albert Aloys Wallpe
D. 7-13-88
B 12-23-1915

- Stephen Joseph Wallpe, B 11-27-1952 *Ruth Land '75*
- Rose Ann Wallpe, B 2-24-1954 *Mary Wayne Field '75*
- Gregory Paul Wallpe, B 6-19-1955 *+ Dec 2, 1973*
- Philip Louis Wallpe, B 10-25-1956 *Jane Mauer '79*
- John Edward Wallpe, B 2-25-1958 *Anna Stoltenmiller Oct '88*
- Eugene Lee Wallpe, B 4-17-1959 *Nancy Kinker*
- James Albert Wallpe, B 7-4-1960 *Mary Silbert June 20, 1987*

Hubert Louis Raver, B 8-26-1923, M 9-27-1952, Esther Mary Volk, B 5-3-1924

- Michael William Raver, B 11-12-1953 *Donna Beck July 28, 1979*
- Sara Jude Raver, B 8-14-1955 *Dale Hermesch June 12, 1976*
- Catherine Rose Raver, B 9-5-1956 *Norbert Kenneth Bedel June 17, 1978*
- Monica Ann Raver, B 4-8-1959 *Joseph Neuman Sept 10, 1988*
- Mary Cecilia Raver, B 8-5-1962 *Thomas Bedel Sept 29, 1984*

Dorothy Marie Raver, B 4-3-1928, M 6-25-1955, Stephen Herman Scheidler
B 10-28-1932

- Andrew Dale Scheidler, B 11-4-1957 *- 6-11-78*
- Mary Ann Scheidler, B 5-9-1961 *- Died 5-9-1961*
- Edward Jay Scheidler, B 8-15-1962 *- Dennis Eggloff 10-12-84*
- Anita Rose Scheidler, B 8-9-1963 *Michael Johnson 4-1-89*

Roselyn Cornelia Raver, B 8-5-1931, M 9-14-1957, Maurice David Hoeing
B 3-31-1928

- Ronald Joseph Hoeing, B 6-19-1958
- Barbara Ann Hoeing, B 1-16-1960 *Richard Sullard*
- Dale Robert Hoeing, B 8-9-1962 *- Died 8-10-1962*
- Wayne Thomas Hoeing, B 8-6-1964 *Ann Patterson 1984*
- Nancy Marie Hoeing, B 1-6-1966

DESCENDANTS

William Gerhard Ricke

B 1856 Ironton, Ohio
 M 1-13-82 St. Ann, Hamburg, Indiana
 D 12-26-13 Greensburg, Indiana - age 57 yrs.
 Buried St. Mary's Cemetery,
 Greensburg, Indiana

Catherine Welling

B 1863 Franklin County, Indiana
 M 1-13-82
 D 11-23-55 - age 92 yrs.
 Buried St. Mary's Cemetery,
 Greensburg, Indiana

Clara Juletta B 10-8-83 D 1-28-98 - age 14 yrs. 3 mo. 20 days
 Buried - Catholic Cemetery, Dunnington, Indiana
 Single - No Descendants

Anna Catherine B 8-26-85 D 5-12-29 - age 43 yrs. 8 mo. 16 days
 Buried - St. Mary's Cemetery, Greensburg, Indiana
 Single - No Descendants

Bernard John B 6-9-87 Franklin County, Indiana
 Henry Vincent B 3-12-89 Franklin County, Indiana
 Charles Frank B 8-28-92 Benton County, Indiana
 Frank Joseph B 10-16-93 Benton County, Indiana
 Rose Augusta B 12-23-95 Benton County, Indiana
 Leo Joseph B 9-23-97 Benton County, Indiana
 Louis Vincent B 2-19-1900 Benton County, Indiana
 Raymond Carl B 9- 5-1902 Benton County, Indiana
 Dorothy Mary B 11-24-1904 Decatur County, Indiana

HENRY AND MARGARET(LUTTELL) RAVER

Henry Raver was born in 1866 at Hamburg, Indiana in Franklin County. He was the son of Frank F. Raver b/1844 and Anna(Lamping) Raver b/1846. He was one of ten children.

Henry Raver was married on Sept.23,1889 to Margaret Lutttell. Margaret was born in 1869. Margaret passed away in 1902. Henry and Margaret were the parents of seven children.

After Margaret's death, Henry remarried to Anna Romer Hillgeford. Anna passed away and Henry was married for a third time to Mary Koettter Humpert. There were no children from the second and third marriages.

Henry owned a store at Oldenburg, Indiana. They also attended the Oldenburg Catholic church there.

Henry Raver passed away on April 15,1951 at Oldenburg Indiana.

Henry and Margaret(Luttell) Raver were the parents of seven children:

1.Joseph Frank Raver was born in 1890 and died in 1970. He was married in 1916 to Addie Schulte. Joseph and Addie had two children: 1. Louis who married Marion Geis and had six children: Diane m/Ken Huff, Sandra, Bernent, Susan, Steven, Janet. 2. Margaret who married Quirn Gaulk and had four children: A. Gerald m/ Rosemary Schoettmer (Brian, Bonita, Bart) B. Don m/Ruth Muckerheid (Andy, Joe, Jeff, Brenda, Donna, Christine) C. Tim m/Mary Scheidler (Steven, Paul, Dianna) D. Ernie m/Mary Lou Helmich.

2.Clara Raver was born in Franklin Co. In. She was married to Joe Schulte. They had two children: 1. Clarence Schulte (not married). 2. Martha Schulte married Fred Blankman: child: (John, Carol m/Steve Gordon, Susan m/Robert Meer, Linda m/Marv Leising.

3.William Raver was born in Hamburg. He was married to Rose August Rickie. (see history) They had four children: 1. Esther m/Albert Walpe (7 child) 2. Hubert m/Esther Volk (5 child) 3. Dorothy m/Stephen Scheidler (4 child) 4. Rose m/Maurice Hoeing (5 child)

4.Veronica Raver (twin to William) she was born at Franklin County In. She was married to Frank Helmich. They had a daughter Helen Helmich who married Herald Klosterkamper. child: (Mary m/Omberg, Mark)

5.Loretta Raver was born at Hamburg Indiana. She was married to William Holtkamp. 1. Leonard Holtkamp m/Ella Mae Cramer-five children. (Bill m/Venge Mazingo, Charles, David m/ Joyce Mayes, Dennis m/Joyce Redman, Walter -Drowned at age 2 or 3 he fell into a bucket of water after a rain. 2. Robert Holtkamp m/Pauline MCDermit. children: (Barbra, Michael, Paul, Patricia) 3. Maurice Holtkamp. 4. Ray Holtkamp m/Joyce Reisinger (Holly Holtkamp).

6.Cora Raver was born in Franklin Co. In. She was married to Harry Meyer. They had three children: 1. Norbert 2. Alfred m/Helen children: (Susan, Ann, Robert, Mary, James) 3. Rita m/Anthony Etter two children: (Edward and Anita Etter)

7.Mayme Raver was born in Franklin County Indiana. She was married to Julius Wolfor. They had two children: (1. Hubert m/Trudy (Gail & Linda 2. Louis -not married)

Catherine Raver and William Dwenger

Anna Catherine(Kate) Raver was born on April 13,1842 on the Raver family farm in Franklin County, Indiana.

She was the daughter of John Henry and Margaret Adelaide (Nienaber) Raver. Kate was one of seven children:Henry b/1833, Maria b/1834, Gesina b/1837 died young, John b/1839, Catherine b/1842, Elizabeth b/died young, Frank F.

Kate's parents, John and Margaret Adelaide(Nienaber) Raver were both born in Germany. The German Language was still spoken in their household.

The Raver family were members of the Catholic church and attended the St. John's Catholic church at Enochsburg.

Catherine Raver was married on Nov. 8,1860 at Hamburg Indiana, to William Bernard Dwenger.

William Bernard Dwenger was born on Jan. 3,1839 at Cinn. Ohio. He grew up near the small town of Hamburg, Indiana in Franklin County. He was the son of Bernard and Catherine (Wilmering) Dwenger. William was one of four children: William., Catherine (Welling), Bernard, Henry.

William and Catherine Dwenger lived in the town of Hamburg. They owned and operated a small general dry goods store on the main street in Hamburg.

They were members of the St. Mary's Catholic church in Hamburg, and their children attended Catholic school there.

William Dwenger was also a postmaster in the town of Hamburg from the year of 1882 to 1889.

Catherine became ill and passed away on April 13,1891 at Hamburg, Indiana, from TB. after an illness of several months.

William Dwenger passed away on December 21,1909 at Hamburg Indiana in Franklin County, from the bronchial Pullmanary grip.

William and Catherine (Raver) Dwenger were the parents of eight children:

1. John Dwenger was born in 1862 at Hamburg Indiana. He was married to Elizabeth Weibold. They adopted two children: John Dwenger who married Anna Hessler and Elizabeth.
2. Bernard Dwenger was born in 1863. He was married to Elizabeth Haskamp. They had nine children: Joe, Edwin, Maurice, Roman, JoAnna, Loretta, Alma, Mary, Betty,
3. William Dwenger was born in 1865 at Hamburg Indiana. He was married to Magdelina Weimer on May 11,1887. three children: John, Caroline, Harold.
4. Frank J. Dwenger was born in 1868. He was married to Anna Seibel. They had six children: Ray, Hilmer, Harry, Martha, Stella, Ellen,
5. Henry Dwenger was born in 1872. He was married to Anna Huth. They were the parents of 14 children: Leo, Victor, Hilda, Olivia, Norbert, Emma, Eddie, Alvina, Alfred, Clarence, Waldo, Clara, Stella, Paul
6. Carrie Dwenger was born in 1879. She was married to Henry Seibel. They had three children: Eleanor, Mable, Arthur, Rosemary.
7. Mary Francis was born in 1874 and died in 1983.
8. Vincent Dwenger was born in 1876 and died in 1879 at age 3.

1. b/1795 Germany Gerhard (Garret) m/ ? Elizabeth J. Nienaber children: 1. John b/1850 In. m/	2. b/1799 Germany John Frederick m/ ? child: Bought land in Franklin Co. 1837 naturalized in Franklin County	3. b/1800 Germany John Albert m/ Gesina Maria Kuntz child: 1. Anna b/1841 d/1847 2. John Francis b/1844 died at d/1844 age 5 months 3. Elizabeth b/1846 m/1863 d/1922 Bernard Dwenger child: 1. Frank m/ #1 Mary Huth #2 Mandy Holms 2. Charles 3. Catherine m/H. Meyer 4. Philomena m/B. Haskamp 5. Amilia m/Peter Huth 6. Joseph m/ (see Dwenger history) 4. Francis (Frank) b/1848 d/1915 m/1866 Mary Wanswrath 1. John m/ Dora Knueven child: sister Dorothy Theresa, Aloysious, Edwin, Norbert, Clara, Marcella, Helen 2. Elizabeth Anna b/1869 d/1874 St. Maurice, In. 3. Josephine m/(Frank) Barnhart m/1899 4. Henry m/Tillie Benson m/1810 nine children (Wilbur, Mary) 5. Francis Anthony Bernard m/1903 to Henrietta Ernestes m/#2 Mary Kneven (Molly) child: Leonard, Frances, Dorothy, Anthony, Mary, Christine, Rosemary, Bernard, John 6. Catherine b/1874 m/Henry Hellmich child: Dora, Pauline, Albert, Freda, Maurice, Leona, Bernard, Leo, Katherine 7. Frank b/1882 not married 8. Joe b/1884 m/Clara Ernestes child: Paul, Joseph, Ralph. 9. Mary b/1884 not married 10. Anthony b/June 1879 m/#1 Henrietta Ernestes m/#2 Mary F. Kneven Leonard, Francis, Dorothy, Anthony, Christina, Mary, Rosemary, Bernard, John	4. b/1803 Germany Margaretta Adolalde m/ John Raver child: 1. Henry b/1833 died at age 21 2. Maria b/1834 m/Theodore Meyer child: 1. John August m/Helena Luttel child: (Harry (Grandchild) Glenn Mayer 2. Katie m/ Charles Ronnebaum (Henry, Bernard, Hilda) 3. Mary m/Wm. Hermish (Wm. F., Henry, John, Rose (Kohlman), Veronica (Kappes), August) 4. Elizabeth m/ Henry Fehrman (Elizabeth (Ostering), Matilda, Eleanor Haskamp), Guenavive, Mary (Flodder) 5. Anna m/John Volk (Wm. J., Agnes, Elenora Doyle); Leo Frank) 6. Francis m/ Henry Luttel (Henrietta (Wright), Clara (Schwegman) 7. Carolina m/ Clem Fisher (Frank, Cornelius, Stan, John, Odella, Linda, Amos, Courtney) 8. Minnie /died young 3. Gesina b/1837 Ohio died Jan. 19, 1853 4. John b/1840 m/1858 Kate Becjschulte 1. John b/1860 2. Maggie (Cammor) 3. Ben /died young 4. Frank (not married) 5. Henry (Not married) 6. Katie 7. Lula * 5. Catherine b/1842 m/ Wm. Dwenger John, Wm., Frank, Bernard Carrie, Henry, Mary Fran (see Dwenger for more) 6. Frank F. b/1844 m/Anna Lamping 1. Henry m/Marg. Luttel (Wm. Anna, Mary) 2. Mary /died young 3. Anna /died young 4. Frank J. m/Mary Bunnemeyer (Clem, Walter, Ray, son) 5. Benjamin m/ Bernadine Kuntz 6. Amelia /died at 12 yr 7. Francis m/Henry Schwegman (Cecilia, Joe, Dorothy, Francis) 8. Anna m/Joe Huser (John, Edgar, Edith) 9. George J. m/(Lilly) Elizabeth Wanswrath (George, Eloise) 7. Elizabeth m/ DIED YOUNG

for more information:
children of Wm. and Catherine (Raver) Dwenger

THEODORE COONRAD NIENABER

Theodore Coonrad Nienaber was born around 1760 in Hanover, Bavaria, in Germany.

He was educated, and could read and write. He was also a farmer.

Theodore emigrated with his family to the United States of America, in 1831. They left from the Kingdom of Hanover in December of 1831, and landed in Baltimore, Maryland, in the U.S. in January of 1832.

They left Maryland and traveled to the State of Ohio, settling in the town of Cincinnati, in Hamilton Co. in 1836.

Theodore and his family moved on to the State of Indiana, in February first of 1839. They settled in Franklin County, in Ray township.

Theodore Coonrad was the father of four children that we know of. All of whom came with him to the U.S.

When he was much older in the year of 1850 he was 84 years old and, was living with his son Albert Nienaber in Franklin County Indiana. He was still a farmer.

Theodore Coonrad Nienaber passed away on December 3, 1854 at Tipton, Indiana, at the age of 88. He is buried in the Hamburg Cemetary in Franklin County Indiana.

Theodore's children were:

1. Gerhard (Garret) Nienaber was born in 1795 in Hanover, Germany. He married Elizabeth J. They had five children: Mary b/1839, Susanna b/1845, Lena b/1847, John b/1850.
2. John Frederick Nienaber b/1800 Hanover Germany. He purchased land in Franklin County Indiana on Nov. 15, 1836 in Ray township in Franklin County. Range 11, Section 15, Township 11, S.E. ct. He was naturalized in Franklin County in 1839.
3. John Albert Nienaber was born on Oct. 16, 1800 in Hanover Germany. He was married to Gesina Marie Kuntz. (b/1809-d/1867) She was the daughter of Francis Kuntz. 1. Anna b/March 6, 1841 and died Oct. 100, 1847. 2. John Francis b/July 28, 1844-Dec. 27, 1844 3. Elizabeth b/Feb. 27, 1846 d/Feb. 8, 1922. She married Bernard Dwenger on Oct. 26, 1863. 4. Francis Xavier (Frank) b/April 6, 1848 d/June 4, 1915. He married Mary Wanstrath on April 24, 1866.
4. Margaret Adelaine Nienaber was born on Oct. 8, 1844 in Hanover Germany. She died on Feb. 27, 1864. She was married to John Raver in Maryland. She was the mother of seven children: 1. Henry b/1833 died at age 21. 2. Mary Raver b/1835 Maryland she married Theodore Diedrich Meyer in 1854. They had eight children August, Kate, Mary, Lizzie, Francis, Anna, Carrie, Minnie. 3. Elizabeth Raver b/1837 Ohio, and died at a young age. 4. John b/1840 and married Catherine Beckschulte. They had eight children: John, Maggie, Ben, Willie, Frank, Henry, Kate, Lula. 5. Catherine b/1842 she married William Dwenger. They had seven children: John, William, Frank J., Bernard, Mary Caroline, John, Francis. 6. Francis b/1844 and he married Anna Lamping. They had ten children: Henry, Mary, Ann, Frank, Ben, Philomene, Amelia, Francis, Ann, George. 7. George J. was born 18-. HE married Elizabeth Lillian Wanstrath. two children: Eloise and George.

(for more information, see RAVER history)

Naturalization for John Albert Nienaber,
son of Theodore Nienaber- brother to Catherine(Nienaber) Raver

State of Indiana }
Franklin County } Sec

Personally appeared before me
Robert John Clerk of the Franklin Circuit Court in
and for said County, on the 30th day of July 1880
John A. Nienaber an alien and made the
following report and declaration to wit: That
he was born in Hannover in the year of our Lord
1801 that he is about 39 years of age that he left said
Kingdom in the year 1832 and landed at Baltimore
in the State of Maryland in the United States
of America in 1832 and from thence he came
to Cincinnati State of Ohio in 1836 and from
thence he came to Franklin County in the State
of Indiana in October 1837 where he has since
resided and that Franklin County is
the place of his intended settlement and that
he on oath declares that it is bonafide his
intention to become a citizen of the United
States of America and to renounce forever
all allegiance and fidelity to every foreign
Prince, potentate, State or Sovereign, heathen
and particularly to the King of Prussia.
Sworn to & subscribed before me
at my office in Brookville }
this 30th day of July 1880 } John Albert Nienaber
Robert John Clerk

FRANK AND MARY (WANSTRATH) NIENABER

Francis (Frank) Xavvier Nienaber was born on April 6, 1815, in Franklin Co. Indiana. He was the son of John Albert and Gesina Maria (Kuntz) Nienaber of Franklin Co. Indiana. Frank was one of four children; Anna (died young); John Francis; Elizabeth (who married Bernard Dwenger); Frank. He attended school when he was young and he could read and write. Frank Nienaber was born Apr. 6, 1815 and died June 4, 1915 and married on April 24, 1866, to Mary Wanstrath who was born on March 13, 1846 and died on July 14, 1907. Frank was a farmer and he and his wife Mary, lived in Fugit Twp. in Decatur Co. Indiana, in 1910. Frank and Mary had 9 children:

1. John Nienaber born March 1, 1868 and died Nov. 26, 1935; was married on Oct. 6, 1897, to Dora (Knueven) born July 28, 1873 and died Dec. 13, 1931. They had seven children; Sister Dorthy Theresa (Gertrude); Aloysius; Edwin; Norbert; Clara; Moralla; Helen.

2. Elizabeth Anna Nienaber b/ Feb. 26, 1869 & died Nov. 27, 1874.

3. Josephine (Nienaber) born April 22, 1872 and died Nov. 15, 1952, and married on April 19, 1899, to Frank Barnhorst born on Jan. 1873.

4. Catherine (Nienaber) born on July 28, 1874 and died May 10, 1967, married Henry Hellmich on Nov. 11, 1896, they had nine children;

5. Henry Nienaber born on Feb. 6, 1877, married Tillie (Benson) on Aug. 17, 1910. Their children are: Wilbur, Mary Elizabeth.

6. Francis Anthony Bernard Nienaber born on July 30, 1879 and died on Jan. 26, 1955, married on Oct. 21, 1903, to Henrietta (Ernstes) born on Aug. 16, 1879 and died March 17, 1905. His 2nd wife Mary (Molly) F. Knueven born on June 25, 1882 and died on Dec. 30, 1947, and married on May 1, 1907. They had nine children;

1. Leonard born Jan. 16, 1908 died in 1961. His wife Luella Wenning born March 16, 1919, were married on Oct. 26, 1940, they have 4 children; Paul Richard b/ July 30, 1941; Marjorie b/ July 26, 1946; Irene Catherine b/ Dec. 16, 1950; Mary Ann b/ Jan. 2, 1953.

2. Frances born on Nov. 20, 1909 and died Feb. 1, 1975 (never married). 3. Dorothy born Jan. 6, 1912 married Walter Cartee.

4. Anthony Jr. was born on Feb. 12, 1914, and died on Oct. 30, 1983, was married on July 11, 1936 to Dolores Nolan born on June 12, 1912 and died on Oct. 2, 1989. They had a son Tom born on March 12, 1938.

5. Mary born on April 16, 1916 and died on Oct. 10, 1918. 6. Christine born on April 22, 1918 and married E. J. Dockter on Feb. 20, 1942, they had four children; James; Thomas; Susan; Cathy. 7. Rosemary born on July 23, 1920 and died on April 4, 1967, (never married).

8. Bernard born Nov. 26, 1923 and married Marhta Clark. 9. John Wm. was born on Feb. 17, 1927 and died on April 29, 1953.

7. Frank was born on Jan. 12, 1882 and died in 1965 (never married).

8. Joe was born on June 20, 1884 and died on Nov. 12, 1939 and in 1904 married Clara (Erpstes), they had three children; Paul; Joseph; Ralph.

9. Mary born on June 20, 1884 and died before 1935? Joe and Mary were twins.

HENRY AND CATHERINE(NIENABER) HELLMICH

Catherine Nienaber was born on July 28,1874 in Franklin County Indiana. She was the daughter of Frank and Mary(Wanswrath) Nienaber. She was one of nine children: John, Elizabeth, Josephine, Catherine*, Henry, Francis, Frank, Joe, Mary. Frank and Mary Nienaber were members of the Catholic Church.

Catherine Nienaber was married on Nov.11,1896 at Franklin County, Indiana to Henry Hellmich. Henry Hellmich was born on Feb. 1,1875.

Catherine and Henry Hellmich were the parents of 9 children:
Dora(Moeller),Pauline(Moorman),Albert,Freda(Navara),Maurice,
Leona(Strasburger),Bernard,Leo,Katherine(Wickens).

Henry Hellmich passed away on Aug.22,1953. Catherine(Nienaber) Hellmich passed away on May 10,1967

1.Dora Hellmich was born on Sept.20,1897 and died on Dec.16,1981. She was married to Joseph Moellar on June 23,1920. Joe was born on July 21,1896 and died on Nov.21,1969. Dora and Joe had seven children: 1.Norbert b/Oct.2,1921 m/Julia Goodwin. 2.Henrietta b/ April 2,1923 m/Rae Carroll 3.Marita b/Aug.1,1924 m/Robert Cherry 4.Walter b/April 14,1926 m/Mildres Welage 5.Maurice b/Oct.14,1927 m/Susanne Loyd 6.John William b/May 16,1930 m/Marilyn Niehoff 7. Robert b/Oct.16,1931 m/

2.Pauline Hellmich was born on July 27,1899. She was married on Nov.9,1921 to George Moorman. George was born on April 19,1898 and died on May 27,1963. they had five children: 1.Mary Catherine b/Aug.25,1922 m/Richard Schroeder 2.Justine b/May 11,1925 m/ Evelyn Grace Davis 3.Eugene b/Jan.7,1928 d/March 15,1933 4. Georgene b/Sept.3,1930 d/Aug.10,1981 m/Albert Stein 5.Don b/Nov. 4,1934 m/Ruth Riehl

3.Albert Hellmich was born on Aug.27,1901 and died on Feb.20,1983. He was married to Lou Meyer on Nov.24,1927. Lou was born on Mar.8,1900 and died Dec.13,1992. They had six children: 1.John Edward b/Dec.15,1928 m/Freda Goins 2.Mary Lou b/Oct.26, 1930 m/#1 Don Richards m/#2 Tom Buckley 3.James b/Aug.5,1932 m/#1 Jeanne Bates m/#2 Jo Davis 4.William b/Nov.23,1933 m/Edith Jones 5.Ann b/April 1,1937 m/Robert Hall 6.Carl b/June 29,1939 m/Katha Robbins

4.Freda Hellmich was born on Aug.22,1903 and died on Nov.26, 1990. She was married on Sept.25,1927 to Nick Navarra. Nick was born on May 25,1904 and died on April 5,1945. They had three children: 1.Nick b/Aug.18,1928 m/Helen Harpring 2.Robert b/June 1,1932 m/Joan Tekulve 3.Connie b/May 1,1934 m/Norbert Meyer

5.Maurice Hellmich was born on Sept.15,1905. He was married on April 15,1926 to Naomi Roell. Naomi was born July 1,1905. They had two children: 1.Tom b/Oct.27,1928 m/Joan Oswald 2.Soundra Sue b/Oct.12,1933 m/John P. Hill.

6.Leona Hellmich was born on Feb.18,1908 and died on Nov.11, 1982. She was married on April 3,1929 to Joseph Strasburger. Joe was born on Dec.7,1902 and died Nov.21,1983. They had three children: 1.Joleen b/April 24,1930 m/Roy Conner 2.Nancy b/Sept.1, 1932 m/Jack Leif 3.Patricia b/Mar.16,1936.

7.Bernard Hellmich was born on July 16,1910 and died Mar.5,1911

8.Leo Hellmich was born on Aug.30,1912 and died Ovct.14,1980. He was married on June 6,1935 to Gladys Miller. Gladys was b/June 22,1916. They were the parents of three children: 1.Richard b/ Feb.4,1937 m/Phyllis Beagle 2.Robert b/Mar.3,1938 d/Aug.30,1951 3.David b/Aug.24,1940 d/June 21,1947 4.Janet b/Oct.2,1950 m/James T. Wise.

9.Katherine hellmich was born on June 28,1905 and died on Aug.22,1946. She was married on Dec.27,1934 to Hubert Wickens. Hubert was born on Dec.7,1908 d/April 23,1979. They had four children: 1.Don b/May 5,1936 m/Sharon Murphy 2.Janice b/May 24,1938 m/John F. Land 3.Roberta b/Aug.12,1941 m/Robert McGinnis 4.Adell b/Nov.2,1945 m/John Corya.

SEIBEL

M/?

1. b/1804 Germany d/1881 2. b/1813 Germany d/1903 3.
 John Seibel Godfried Seibel
 m/before 1837 m/#1 Helena
 Christina m/#2 Margaret Geis
 child: child:
 1. Henry b/1837 1. Michael
 2. Daniel b/1840 m/Josephine Irene Floyd
 3. John b/1845 (2 girls & 1 boy)
 4. Michael b/1848 lived Brookville
 2. Anna Margaret b/Aug. 27, 1846
 3. John b/Feb. 3, 1844
 4. Catherine b/Feb. 19, 1842
 5. Josephine b/May 8, 1846
 m/Joseph Harman
 6. Mary b/
 m/Dismas Schath
 7. Froneka b/
 m/Conrad F. Reis
 8. Rosella b/
 m/Peter Woest



1. b/1837 Bavaria, Ger. 2. b/1840 Germany 3. b/1845 Germany 4. b/1848 Germany
 Henry Seibel Daniel Seibel John Seibel Michael Seibel
 m/1860 m/1863 m/1863 ? m/1866
 Magdalena Hahn Gertrude Nuneyer Sarah Davis Mary Anna Hahn
 child: child: child: child:
 1. Henry m/Carrie Dwenger 1. Michael b/1866 1. Henry b/1868
 2. Anna m/Frank Dwenger m/Louise Walterman 2. Catherine b/1869
 3. George m/Mary Beagle m/#2 Cora Gard 3. John b/1871
 4. Felda /not married (Emmanuel) 4. Valentine b/1873
 5. Frank m/#2 times 2. Catherine Christina 5. Margaret b/1875
 Clara Mendenhall m/John Dietz b/1869 6. Mary Magdelina b/1877
 #2/----- Newman (no child.) 7. Anna Maria b/1879
 6. Joseph /not married 3. Veronica Margaret m/May 7, 1902 son:
 7. John m/Mary Schroader m/Frank Dephew b/1871 John Weimer (Peter Weimer)
 8. Kate m/Henry Schroader (no children) 8. Michael c. b/1885
 9. Bernadetta /not married 4. Catherine (died young) m/June 13, 1886
 10. Magdalena /died at age 4 5. Catherine b/1875 Catherine Wallerman
 11. Margaret Mary 6. William b/1876
 m/Veronica Weber
 (Harry Wm., Mary F.,
 Ann Marg., Flora Eliz.,
 Clarence Daniel)
 7. Magdalena b/1878
 d/1880 died young
 8. Francis b/1879 d/1880
 9. Mary Margaret b/1881
 10. John b/1862
 11. Henry b/1867
 12. Anna b/1870



children of Henry:

1.	2.	3.	4.	5.	6.	7.	8.	9.	10.	11.
John b/1861 m/Mary Schroader child: 1. Edward	Katherine b/1869 m/ Henry Schroader child: 1. Hilda m/ Mershman	Margaret b/1865 m/ not married	Joseph b/1870 never married	Anna M. b/1872 m/1892 Frank Dwenger child: 1. Raymond m/Flora Rolfes 9 child 2. Hilmer m/Nora Walke 3 child 3. Harry J. m/ Mary Hessler 10 child 4. Stella died at age 12 1/2 5. Martha m/ Bernard Stier 3 child 6. Ellen M. m/ Joe Ries 5 child	Henry b/1874 m/Carrie Dwenger child: 1. Arthur died young 2. Elenora m/Edwin Peters ch. Howard Henry Helen 3. Harry J. m/ Sam Allen ch. Clarence Rodney Thelma 4. Rosemary m/Kirshner Sandra Linda Carolyn	Magdelina b/1876 d/1880 died at age 4	Valentine b/1878 (Felda) Bud never married	George b/1880 b/1918 Mary (Hampton) Beagle child: 1. Paul m/Betty Green 2. Howard m/ Ruth Bostic 3. Ralph m/Maxine Wingham 4. Harold m/Dorothy Reed	Francis b/1883	Bernadetta Rose Marie

(See
Anna
&
Frank
Dwenger
graph)

JOHN AND CHRISTINA SEIBEL

Johannes (John) Seibel was born around 1803 in Bavaria Germany. He was raised in Bavaria Germany, an area of much territorial stress between the local states over the ownership of lands. There were also periodical attempts by neighboring countries to overthrow the local governments.

He had at least one brother that we know of, Godfried Seibel, who also came to America and settled in Franklin County, near the town of Hamburg.

Godfried Seibel married Margaret Geis. They were the parents of five children: Mike, Anna Marg., John, Catherine, Josephine.

John was a farmer. He was married to his wife Christina sometime before 1838 in Germany. They were members of the Catholic church. They lived in the province of Hannover in Bavaria.

Christina Seibel was born around 1804 in Bavaria Germany. (I do not have her maiden name at this time.)

John and Christina Seibel were the parents of four children that we know of. They were all born in Germany.- Henry, Daniel, John, Michael.

John and Christina emigrated to the United States around 1848 (or 1831?). They settled first at St. Mary's (in Dearborn Co. In.) They later moved to the town of Hamburg in Franklin Co. Indiana where they were living in 1860.

John in 1860 was shown as a cooper by trade. A cooper is one whose occupation is making and repairing barrels, and he followed this occupation all of his life.

He owned land in Franklin County, named as lots no. # 19, 31, 32, 34 & 35 in the town of Hamburg, in Franklin Co., in Ray twp. In the 1870 census in Franklin Co. he was living near or with his son Daniel Seibel Salt Creek Twp. in Hamburg. (The county line between Ray and Salt Creek twp. runs through the middle of the town of Hamburg.)

John Seibel died in Franklin Co. on Sept. 16, 1881, at Hamburg, and is buried there. He left a will naming his eldest son, Henry Seibel as executor of the estate. He left everything to his widow, Christina Seibel.

Christina Seibel moved to Huntersville, she died sometime after 1886. probably buried in Franklin County.

John and Christina were the Parents of four children that we know of: Henry b/1838, Daniel b/ 1840, John b/1845, Michael b/1848.

1. Henry Seibel was born around 1838 at Hannover Bavaria, in Germany. He was Married on July 17, 1860 at Franklin Co. Indiana, to Magdalena [Lene] Hahn, who was born on Feb. 26, 1843 at St. Leon In. Henry Seibel owned and operated a store in Hamburg. He was shot and killed on Jan. 20, 1888, and is buried at Hamburg (Oldenburg?) His wife Magdalena (Hahn) Seibel, remarried on Aug. 9, 1892 to Peter Bittner in Franklin Co. They lived at Kingston. Magdalena died on May 6, 1918, and is buried at Hamburg In.

Henry and Lena were the parents of eleven children: 1. Henry b/1874 m/Carrle Dwenger. 4 child. 2. Anna b/1872 m/Frank John Dwenger - 6 child:. 3. George Matthias b/1880 m/Mary(Hampton) Beagle - 6 child. 4. Felda(Bud)Valentine b/1878 m/not married 5. Francis b/1883 m/#1 Clara Mendenhall m/#2 --Newman child ?. 6. Joseph b/1870 m/not married. 7. John Harry b/1860? m/Miriam Schroader -4 child 8. Katherine b/1863 m/Henry Schroader - 1 child 9. Bernadetta(Rose Marie) b/? m/? 10. Magdalena b/1876 d/1880 11. Margaret b/1865 m/?

2. Daniel Seibel was born in 1840 in Rhinebyer, Bavaria Germany. He was married on Feb. 8, 1863 to Gertrude Nuneyer. They were the parents of nine children: 1. Michael b/1866 m/Louise Walterman - 2 child. 2. Catherine b/1869 m/John Dietz child:?. 3. Veronica Margaret b/1871 m/? 4. Catherine b/1873. 5. Catherine b/1875. 6. William b/1876 m/Veronica Weber - 4 child:. 7. Magdalena b/1878 died 1880. 8. Francis b/1879 d/1880 9. Mary Margaret b/1881

3. John Seibel was born in 1845 in Bavaria Germany. I have no other information on him.

4. Michael seibel was born in 1848 in, Germany. He was married on Oct. 16, 1866, to Mary Hahn. They were the parents of three children. 1. Mary Magdalena b/1877 m? 2. Anna Maria b/1879 m/1902 to John Weimer child:?. 3. Michael C. b/1885 m/? child:?

John Seibel

Be it remembered, that the last will and testament of John Seibel, deceased, was admitted to probate and record on this the 20th day of September AD 1881 in the words and figures following to wit : "In the name of God ,amen.

I John Seibel of the town of Hamburg in the county of Franklin State of Indiana at the age of 78 years and being of sound mind and memory do make and publish and declare this my last will and testament in the following manner, that is to say: First I wish to have set aside \$100 .00 ----- One Hundred Dollars for funeral expenses and Masses said at St. Anne's Church, Hamburg Franklin Co. Ind.

Second I give and bequeath to my wife all my personal property and real estate consisting in the Lot numbers - 19, 31, 32, 34, and 35 situated in the town of hamburg Franklin Co. and Be it so if the said \$100.00 stted above can not be found to be cash on hand, Lots Num. 34 and 35 may be sold and from the money realized, said \$100.00 may be paid.

Lastly, I appoint my son H. Seibel executor of this my last will and testament. Hereby revoking all former wills by me made.

On ----- whereof I have hereunto set my hand and seal this day 10th of Sept. in the year of our Lord, One thousand eight hundred and eighty one.

Seal Johanes Seibel

The above mistouneuh consisting of two sheets was, of this date thereof signed, sealed, published and declared by the said John Seibel; as and for his last will and testament, consisting of in the presence of us, who at his request and in his presence, and in the presence of each other, have subscribed our names as wittnesses thereof, Henry Schroder, Joseph Haskamp, Geo. Eberhard, OSF.

THE STATE of INDIANA, Franklin, County, SS:

Be it remembered, that on the 20th day of September at 1881, Henry Schroder one of the subscribing wittnesses to the mither and forgoing last will and testament of John Seibel, Late, of said County deceased, personally appeared before me W. H. Bracken, clerk of the circuit court of Franklin County, in the State of Indiana and being duly sworn by the clerk of said county upon his oath declared and testified as follows , that is to say, That on the tenth day of September AD 1881, he saw the said John Seibel sign his name to said instrument in writing as and for his last will and festiment, and that this deponent at the same time heard the said.

MICHAEL SEIBIL

The agricultural advancement in Franklin county has been due largely to the untiring struggle and success of the German citizens of this county, some of whom came with their parents to build homes in the great land of freedom, other of whom have been born here after the arrival of their parents. The German citizens, whether native or foreign born, have proved to be splendid men and women who are interested in the welfare of the community where they live and always loyal to the country of their birth or adoption.

Michael Seibel was born in Hamburg, Franklin county, Indiana April 5, 1866, the son of Daniel and Gertrude (Nuneyar) Seibil, both natives of Germany, the former born April 19, 1840, and the latter born December 5, 1839. Daniel Seibil Died November 10, 1909 his wife having preceded him to the grave just two years, her death having occurred November 11, 1907.

The paternal grandparents of Michael Seibil were John and Christina Seibil, both natives of Germany, who came to America when Daniel Seibil was eight years old. They located first at St. Marys, this county, and later moved to Hamburg, where he died and is buried. His wife died later at Huntersville and is buried there. He was a cooper by trade and followed this occupation all his life.

Michael Seibil maternal grandparents were Frank and Gertrude Nuneyar, both natives of Germany, who came to America on the same boat with Michael Seibil paternal grandparents. They located at St. Mary's, in this county, and remained there the rest of their lives, being among the best known farming people of that thriving neighborhood.

Daniel Seibil was educated in the St. Mary's parish school and entered the Union army at the age of eighteen years, serving in the Twenty-seventh Regiment, Indiana Volunteer Infantry for four years. He fought in the battle of Gettysburg and participated in seven bayonet charges in that battle. After the war he returned to Franklin county and lived until sixty-seven years old. He took up farming at Hamburg and owned eighty-eight acres at the time of his death. Both he and his wife died in Hamburg.

Michael Seibil was educated in the Hamburg parish school and took up farming early in life. In 1893 he purchased the place where he now lives, which consists of eighty acres in Salt Creek township, where he is engaged in general farming.

Michael Seibil was married June 15, 1895, to Louisa Waltermann the daughter of John Henry Waltermann, of Salt Creek township.

Mr. Seibil and wife are members of the Church of Christ and are highly respected in the community where they live. By their labor, thrift and good management they have added much to the agricultural life in their section of Franklin county.

1
2
3
4
5
6
7
8
9
10
11
12
13
14
15
16
17
18
19
20
21
22
23
24
25
26
27
28
29
30
31
32
33
34
35
36
37
38
39
40
41
42
43
44
45
46
47
48
49
50
51
52
53
54
55
56
57
58
59
60
61
62
63
64
65
66
67
68
69
70
71
72
73
74
75
76
77
78
79
80
81
82
83
84
85
86
87
88
89
90
91
92
93
94
95
96
97
98
99
100

DANIEL AND GERTRUDE(NUNEYAR) SEIBEL

Daniel Seibel was born on April 5, 1840 in Bavaria Germany. He was the son of Johannes(John) and Christina Seibel, both natives of Germany.

Daniel's parents, John and Christina were residents of the town of Hamburg, in Franklin Co. In. They had four children that we know of: Henry born in 1837, Michael, born 1839. Daniel born in 1840, John born in 1845. They came to the U.S. in 1847 when Daniel was eight years old.

Daniel grew up around the town of Hamburg in Franklin Co. They were members of the Catholic Church. He was educated in the St. Mary's parish school.

Daniel entered the Union Army at the age of eighteen, serving in the twenty-seventh Regiment, Indiana Volunteer Infantry, for four years. He fought in the battle of Gettysburg, and participated in seven bayonet charges in that battle. After the war he returned to Franklin County and lived until sixty seven years old.

Daniel was married on Feb. 8, 1863 at Franklin, County Indiana to Gertrude Nuneyar. Gertrude was born on Dec. 5, 1839 in Germany, the daughter of Frank and Gertrude Nuneyar, both natives of Germany. The Nuneyar's came over to America on the same boat with the Seibels.

Daniel Seibel purchased eighty acres of land in Franklin Co., Salt Creek township. He took up the occupation of farming which he continued his whole life.

Gertrude Seibel passed away on Nov. 11, 1907 at Hamburg, In and Daniel Seibel passed away on Nov. 10, 1909 at Hamburg, Indiana.

Daniel and Gertrude were the parents of twelve child: 1. John b/1862, 2. Michael b/1866, 3. Henry b/1867, 4. Cath. Christina b/1869, 5. Anna b/1870, 6. Veronica Marg. b/1871, 7. Catherine b/1873 (died young), 8. Catherine b/1875, 8. William b/1876, 9. Magdalena b/1878, 10. Francis b/1879, 11. Mary Margaret b/1881.

1. JOHN SEIBEL was born in 1862 Franklin Co. Indiana.

2. MICHAEL SEIBEL was born on April 5, 1866 in Franlin Co. Indiana in Salt Creek township. He was educated in the St. Mary's Hamburg parish school, in Franklin County. He took up farming early in life. In 1893 he purchased the place where he and his wife lived, which consisted of eighty acres in Salt Creek township, where he engaged in general farming.

Michael Seibel was married on June 15, 1895, to Louisa Waltermann. Louisa was born in 1869 the daughter of John Henry Waltermann, of Salt Creek Township. Michael and Louisa were members of the Church of Christ and were highly respected in the community. Louisa died young on July 17, 1916.

Michael married a second time to Cora Gard on Dec. 25, 1916 at Franklin Co. Indiana. A son, Emmanuel Seibel, was born on Sept. 29, 1917. Another son, was stillborn on March 1, 1919. Michael's second wife Cora, passed away on June 29, 1919, when their son was only three monthes old.

Michael married a third time to Elizabeth Brickner, no children were born to this union.

Michael Seibel engaged in general farming and stock raising, in which he had met with a fair degree of success. He was a highly respected citizen of the community and had considerable influence in public affairs.

Michael Seibel passed away on June 10, 1955 in Franklin Co. Indiana. His wife Elizabeth is buried at Beuna Vista.

Michael's son Emmanuel Seibel presently resides in Rushville, In. No children.

3. HENRY SEIBEL was born in 1867, in Franklin Co. No other info.
4. CATHERINE CHRISTINA SEIBEL was born in 1869 in Franklin Co. In. She was married on Aug. 20, 1885 to John Dietz. They moved to Chicago, Ill. John was a pattern cutter at a factory. They had no children.
5. ANNA SEIBEL was born in 1870 in Franklin Co. no other info.
6. VERONICA MARGARET SEIBEL was born in 1871 in Franklin County In. She was married to Frank Dephew. She passed away in Detroit Michigan. She had and Frank had no children.
7. CATHERINE SEIBEL was born in 1773 in Ind. and she died young.
8. CATHERINE SEIBEL was born in 1875 in Franklin Co. Indiana. She was married at Indianapolis, In. to a Frank Reynolds. They had a son Harvey Reynolds at Pitts. Penn. He made Letter Heads for Coompanies. He was married to Veronica Weber. They were the parents of five children: 1. Harry Wm. Reynolds born in 1905. 2. Mary Francis born in 1906. 3. Ann Margaret Reynolds born in 1907. Ann married Bob Kohn. 4. Florentine Elizabeth Reynolds was born in 1911. She died from Cancer. 5. Clarence Daniel Reynolds was born ? He moved to Cinn. Ohio around 1926, and is buried in Cinn. Ohio
9. WILLIAM SEIBEL was born Jan. 1876 in Franklin Co. Indiana. He was a carpenter and a farmer.
10. MAGDELINA SEIBEL was born in 1878. She died young on Nov. 18, 1880 in Franklin Co. In.
11. FRANCIS SEIBEL was born in 1879, and died young at less than one year old on Nov. 26, 1880.
12. MARY MARGARET SEIBEL was born in June of 1881 at Franklin Co. In. She was married at age 21 to John Weimer on May 7, 1902.

HENRY AND MAGDELINA (HAHN) SEIBEL.

Henry Seibel was born around 1838 in Bavaria Germany. He was the son of John and Christina Seibel. He emigrated with his parents to America around 1848, when he was eleven years old.

He first settled with his Parents at St. Mary's , then they later moved to the town of Hamburg, in Franklin County Indiana. His father purchased lots in the town of Hamburg. He was one of four children, as far as we know: Henry, Daniel, John, and Michael.

Henry Seibel was married on July 17, 1860, at Franklin Co. Indiana, to Magdelina(Lena) Hahn. They were married in the St. Mary's Catholic church.

Magdelina Hahn was born on Feb. 26, 1843 at St. Leon Indiana, in Dearborn Co. She was the daughter of Valentine and Elizabeth (Worst) Hahn. She was one of seven children: Joseph, Barbra, Frederick, magdelina, mary Anna, margaretta, john. She moved with her family to Franklin Co. around 1859.

Henry and Magdelina(hahn) Seibel lived in the town of Hamburg, in Franklin Co. Ray twp. According to an old Hamburg Platt Map, Henry owned lots 20, and 21 on Main St. in Hamburg. His father John owned a number of lots all around him and he probably purchased his lots from his father.

Henry established a store in the town which he ran himself. He is listed in the old business directory as a dealer in dry goods and general merchandise, and all kinds of grain. He also ran a liquor store from his establishment. His store was not located on the two lots previously mentioned, but was on the North end of town on lot 37, set on the road from Kingston. It looks on the map that there may have been a wall seperating the liquor store from the dry goods store.

Although exactly when the store was established is uncertain, there were a number of fines levied at him for the violation of liquor laws, (Mostly for selling liquor on Sunday or without a license) beginning on Feb. 4, 1868 through Nov. 23, 1885.

Henry Seibel was also a postmaster in Hamburg from 1877 to 1882. He probably ran it from his store also.

Henry and Magdelina were members of the St. Anne's Catholic church of Hamburg. Henry was well known in the area. For many years he was regarded as a local Democratic leader in the Western part of the county, and had frequently been a candidate for county office.

He had long been in the saloon and merchandising business at Hamburg. His place of business was located on the road between Metamora and Oldenburg, and was a popular resort, especially during political campaigns. When under the influence of liquor he could be quarrelsome and often insulting. His peculiarities of disposition were patent to nearly everybody.

On the day of Jan. 19, 1888, on a Thursday afternoon around 6:00 in the evening, the saloon was open for business as usual. Joseph Welling and two of his friends, named Goldschmit, were in the saloon. Welling, age 20 and his friends had returned from hunting that day. They had stopped at Seibel's to play a few games of cards and drink some liquor. They had sat around and were all matching pennies for drinks. At closing time, upon settling up at the bar there, a dispute arose over the amount of Joseph Wellings indebtedness. Henry claimed that it was twenty-five cents and Welling said he owed but fifteen cents. Both had been drinking. After calling each other liars and other hard names, Welling borrowed a quarter from one of his companions and handed it to Henry, remarking as he did so. "If you can go to heaven with this, alright." Seibel returned the compliment by telling Welling he could "Go to hell". Seibel asked Welling to leave, it was also near closing time. The boys left,

and were followed out by Seibel who kept up the quarrel by calling Welling a "Son of a bitch", upon which the latter became more enraged, and threatened to shoot Henry if he repeated the words.

Joseph Welling, since he had been out hunting, had his shotgun with him, as he stood outside. Henry took the dare as he turned to close the shutters of the store, repeated the words. Welling pointed his gun at him and fired, hitting him full in the back and abdomen. Henry said, "I'm shot!" and stumbled back into the store. One of the Goldschmit boys said, "You ought not to have done that Joe." The friends when questioned later, claimed they did not see anything.

Henry Seibel was removed to his home and a doctor was called. He lingered painfully for ten hours, before passing away early the next morning, on Jan. 20, 1888, he was about 50 years old.

After the shooting young Welling went home and retired to his room without telling his parents, Vincent and Catherine (Dwenger) Welling, of what had occurred. He was arrested around 10:00 that night. He said the shooting was an accident.

Joseph Welling was found guilty of murder and served three years in prison.

Henry and Magdalena were the parents of eleven children. The youngest being about age four at the time of his death.

Magdalena had to go to court to gain administrative power of the estate from the state. Henry Seibel left no will. She was granted power as executrix of the estate. She sold the store.

Henry was probably not naturalized as I had found no papers about him, and the newspaper account of the shooting identified him as, "a German".

Magdalena kept all of her children after the death of her husband. It was common at that time for a widow with a lot of children to give them up to relatives for care, as women did not work or support themselves at this time.

On August 9, 1892, Magdalena (Hahn) Seibel, remarried to a Peter Bittner. They moved to the town of Kingston, where she lived at the time of her death. Her children liked their step father Peter Bittner.

When Magdeline became older and was unable to do all of the house work, a cleaning lady (Mary Beagle) was hired by her sons who were still at home, to help her out.

Magdalena Hahn Seibel Bittner, passed away on May 6, 1918, at home at Kingston, and is buried at the Hamburg Catholic Cem.

Henry and Magdalena Seibel were the parents of 11 children:

1. John H. Seibel b/1861 - m/1884 to Mary Schroeder
2. Katherine Seibel b/1863 - m/? to Henry Schroeder.
3. Margaret (Mary?) Seibel b/1865 - m/?
4. Joseph (Josephine?) Seibel b/1870 - m/never married
5. Anna M. Seibel b/1872 - m/1892 to Frank John Dwenger.
6. Henry Seibel b/1874 - m/1899 to Carrie Dwenger
7. Lena (Magdalena?) Seibel b/1876 - m/not married d/1880
8. Valentine (Felda-Bud) Seibel b/1878 - not married
9. George M. Seibel b/1880 - m/? Mary (Hampton) Beagle
10. Francis (Frank) b/1883 - m/#1 Clara Mendenhall, m/#2 Newman
11. Bernadetta (Rose Marie) b/? -

23rd Day April Term A.D. 1888. (Friday May 18

1358. Estate of Henry Seibel, deceased. } Order Vesting estate in widow.

Comes Magdalena Seibel, widow of Henry Seibel, deceased & Carter, her attorneys, and files her affidavit, and an inventory of property of said decedent, asking that said estate be, by the Court, vested in her without administration, of the same exclusive of incumbrances, being less than \$50. which petition, affidavit and inventory are as follows.

And the Court upon examination had, and being sufficient advised in the premises now grants the order prayed. And orders and directs that said estate be now named in said widow, and that administration of said estate be, and the same is hereby dispensed with.

And Court adjourns until 9 o'clock on tomorrow
Ferdinand S. Swift

23rd day of April Term A.D. 1888, Friday May 18
Settling of the Estate of Henry Seibel - by widow Magdalena Seibel

Estate of Henry Seibel, deceased. Order Vesting Estate in Widow

Comes Magdalena Seibel, widow of Henry Seibel, deceased & Carter, her attorneys; and files her affidavit, and an inventory of property of said decedant, asking that said estate be, by order of the court, vested in her without administration. The extent of the same, exclusive of incumbrances; being less than \$50. and of which petition affidavit and inventory are as follows that.

And the court upon examination, had and being sufficient advised in the premises, now grants the order prayed; and orders and directs that said estate be now named in said widow, and that administration of said estate be, and the same is hereby dispensed with.

And the court adjourned until 9:00 on tomorrow
Ferdinand S. Swift

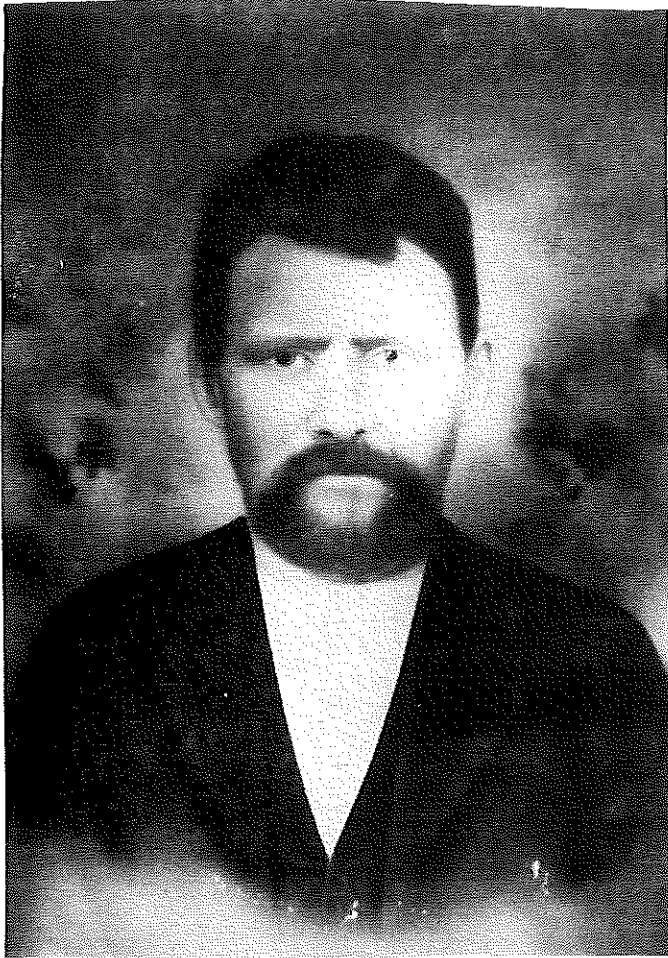

Henry Seibel b/1838 married July 17,1860 to
Magdelina Hahn (son of John and Christina Seibel)

Magdelina(Hahn)Seibel b/Feb.26,1843
dau. of Valentine and Eliz.(Worst)Hahn



Seibel Store at Hamburg - owned by Henry Seibel
taken around 1881 a wall seperated the liquor
store from the dry goods store on the other side



Henry and Magdelina(Hahn) Seibel Family before 1888
 (Not all children are pictured)
 sitting:Magdelina and Henry, Anna
 L to R:Marg.M.,Felda,Henry,Kate,(Lying dwn. George)



Left standing:
 Mary Anna(Hahn) Seibel
 and her children
 Lady in black hat?

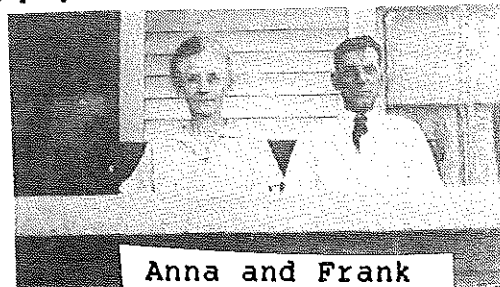

Anna and Frank
 (Seibel) Dwenger
 around 1927



Emmanuel Seibel and Maxine Seibel
 1993 (wife of Ralph Seibel)



L to R: John Beagle, Frank Beagle, Paul Seibel, George Seibel, Howard Seibel, Mary Seibel, Harold and Ralph Seibel



*Mrs. A. J. Cullin
Mrs. Chas Wasson Mrs. Mary Seibel*

Mrs. A.J. Cullin
Mrs. Chas Wasson, Mrs. Mary Seibel



George and Felda Seibel with their horses.



Felda (Bud) Seibel
Valentine b/Aug. 2, 1878



Kate (Seibel) Schroeder

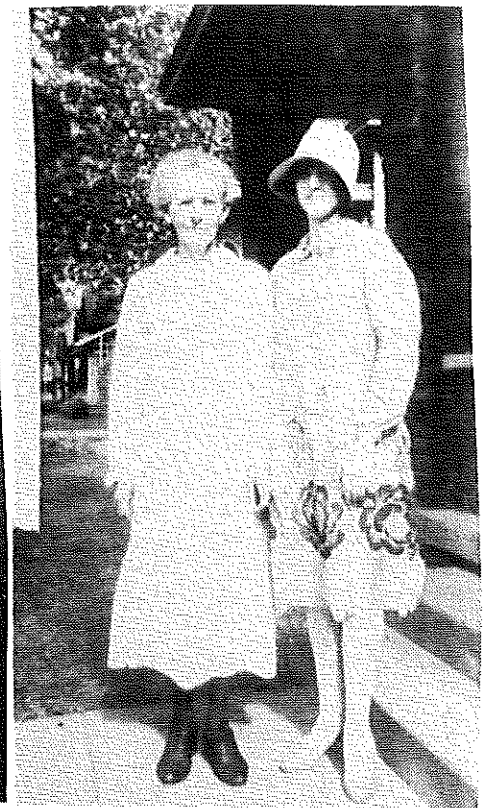

Anna (Seibel) Dwenger
Martha (Dwenger) Stier

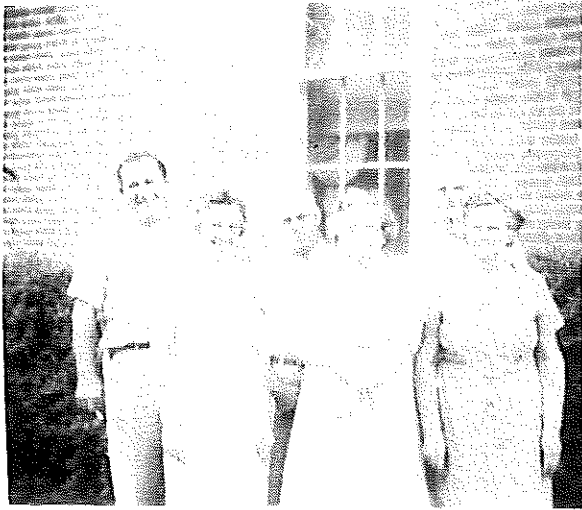

L to R: Clifford & Rose Kersken
Sam and Mabel Allen
Edward and Elenor Peters



Carrie Seibel, Henry Seibel, Mabel Seibel, Ed Peters,
Mike Bauman, Charles Boesche, Walter Boesche, Harold Dwenger



L to R.: Elinor, Mary, Hilda, Kate, Anna
1922 (Walke)(Hessler)(Seibel) (Seibel) (Seibel)
Dwenger Dwenger Meershman Schroder Dwenger
sitting: Ellen Dwenger, Dorothy Dwenger, Martha Dwenger



Seibel family members
sitting is Kate (Seibel) Schroeder



taken: 1908 Seibel family
stand: Helen, ?, Anna, ?
Seibel (Seibel)
on chairs: Lena (Hahn) Seibel holding Martha
Kate (Seibel) Schroeder holding Henry S.
sitting: Elinor, Stella, Arthur
Seibel Dwenger Seibel

CHILDREN OF HENRY AND MAGDELINA(HAHN) SEIBEL - *11 children in all*

1. John Henry seibel was born in 1861 in Indiana. He was married on September 2, 1884 to Miriam(Mary) Schroader. John and Mary Seibel had five children: Edward, Eva Magdeline b/1885, Mary b/1885, Henry b/1886, Joseph Clement b/1888.

2. Katherine Seibel was born in 1863 in Indiana. She was married to Henry Schroader. Katherine was nicknamed Kate. Kate and Henry moved to Cincinnati, Ohio. They owned and operated a jewelry store in Cinn.

Kate and Henry Schroader had two children: 1. Hilda Schroader who married a Mershman. 2. Elsie Schroader, who married aa Koch. Elsie Koch had two child.: a. Vera Koch who married and had a little boy and a girl. Vera died after her children had had scarlett fever and she was cleaning things with bleach and died from bleach poisoning. b. Al Koch, who was a Dentist in Cinn.

3. Bernadetta Seibel was born in the 1800's. She became a Nun and took the name of "Sister Rose Marie". She died on Nov. 3, 1918 at St. Maurice.

4. Anna Magelina seibel was born on June 13, 1872 at Sunman, Indiana. She was married on May 25, 1892 to Frank John Dwenger b/1868 d/19339 from Hamburg, Indiana in Franklin County.

Anna and Frank Dwenger were members of the Catholic Church. They were the parents of six children:

1. Raymond Dwenger born in 1895 and married on Sept. 12, 1917 at Millhousen Indiana to Flora Rolfes.

2. Hilmer John Dwenger was born in 1893. He married Elenora Walke on Oct. 27, 1914.

3. Harry Dwenger was born in 1898. He was married on Aug. 29, 1923 to Mary Cecilia Dwenger.

4. Stella Dwenger was born on Feb. 28, 1904. She died on Dec. 22, 1916 of Perilonitis General (Gangreen, Apendicitus). She was 12 and a half years old.

5. Martha Dwenger was born in 1905 and married Bernard Steir on Aug. 18, 1926.

6. Ellen Dwenger was born in 1908 and married Joe Ries.

FOR MORE INFORMATION SEE "FRANK AND ANNA DWENGER" HISTORY

HENRY AND CAROLINE (DWENGER) SEIBEL

(1874-1927)

(1878-1932)

Henry Seibel was born in 1874 at Hamburg, Franklin County, Indiana. One of eleven children, he was the son of Heinrich Seibel and Magdalina (Hahn) Seibel.

Caroline "Carrie" Dwenger was the daughter of William Dwenger and Anna Katharina (Raver) Dwenger. Carrie was born in Hamburg IN, the youngest of seven children.

Henry and Carrie were married November 15, 1899 in the Hamburg Catholic Church. They farmed land near Clarksburg IN, and on the Kitchen Family farm near Kingston IN. Later, they moved to St. Maurice IN, where Henry used his carpentry and woodworking skills. His skill was such that he made a very realistic three foot high cherry rolltop desk for his daughter, Rosemary.

Henry loved to hunt and was proud of his hunting dogs.

Their eldest daughter, Eleanore, always spoke highly of her parents, although she often recalled one disappointing Christmas. It seems she went snooping (who hasn't) before Christmas, and as her "reward" a very nice doll she had found didn't show up under the tree. This was remembered as a lesson in values held by her parents, typical of the community in which they lived.

They apparently lived a happy life except for the early death of of their teenage son, but were shocked by Henry's sudden death at age 52 in 1927. He died from a heart attack on the eve of a planned trip to Cincinnati to visit their daughter, Mabel, who had moved there. Carrie continued to live in their St. Maurice home until her death from cancer at age 53 in 1932.

Henry & Carrie's four children (shown in *ITALICS*) included:

ELEANORE MAGDALENE (SEIBEL) PETERS, born 8-12-1900, was married November 15, 1921 to Edward Henry Peters. They lived on farms in Decatur County, Indiana. Edward and Eleanore died in 1965 and 1990, respectively. Their descendants :

1. Helen Louise Peters R.N., born Nov. 14, 1922, married Nov. 25, 1948, to Paul A. Lime. They reside in Indianapolis IN. Their children: Ruth (Lime) Allardyce, Melbourne, Australia; Shirley Lime, Indianapolis IN; Richard Lime, Greenwood IN; & Jerry Lime, Indianapolis IN.

2. Carl Henry Peters, Greensburg IN, born Jan. 5, 1925, married Sept 11 1948, to Rosemary Lamastra R.N.. Their children : Nicholas Peters & Carl Peters, Jr., both of Greensburg IN.

(continued, next page)

HENRY AND CAROLINE (DWENGER) SEIBEL (cont.)

3. Howard Francis Peters, born May 17, 1928, married Nov. 24, 1955 to Helen Joyce Hill. Their children: Michael Wayne Peters, Erlanger KY; Susan (Peters) Eddington, Elmhurst IL; Carol (Peters) Dwenger, Indianapolis IN; and David Alan Peters, Fairfield OH.

ARTHUR SEIBEL, who died as a teenager, from apppendicitis.

MABEL ELIZABETH (SEIBEL) ALLEN, born June 7, 1904, was married June 25, 1927 to Samuel James Allen . They lived in Amelia, Ohio. Their descendants are:

1. Clarence Allen, born Aug 4, 1931, married Jan 13, 1956 to Edna Bradbury. They live in Cincinnati OH, as do their children: Kathleen (Allen) Wilson & Rebecca (Allen) Riley.

2. Thelma Irene (Allen) Eckart, born Mar. 26, 1934, married May 23, 1955 , to Ralph Lee Eckart. They live in Cincinnati OH, as do their children: Debbie Kay (Eckart) Conrad & Dennis Allen Eckart.

3. Rodney Earl Allen, Cincinnati OH, born Mar. 27, 1938, married Oct. 17, 1959 to Bonnie Ann Sager. Their children: Scot Dean Allen; Kenneth Dale Allen; Holly Lynn (Allen) Piersall Taylor; & Brian Douglas Allen.

ROSEMARY BERNADETTE (SEIBEL) KERSKER, born Oct. 3, 1918, married 12-24-1937 to Clifford Kersker. They lived in Cincinnati, and Charlotte, NC. Rosemary and Cliff died about 1980 and about 1987, respectively. Their descendants, of Charlotte NC area are:

1. Sondra (Kersker) Edgar Hudgen, born Mar. 5, 1941, married to James C. Edgar, and Larry E. Hudgen.

Children: James M. Edgar; Kimberly A. Edgar; & Timothy P. Edgar.

2. Carolyn Kay (Kersker) Walters, born Jul. 19, 1945, married Joe F. Walters.
Child: Carolyn Marie Walters.

3. Linda Lee (Kersker) Elrod, born Apr. 17, 1947, married Joseph E. Elrod.
Children : Meggan A. Elrod & Mark J. Elrod.

Henry and Carrie would have been proud of the children, grandchildren, and great-grandchildren if only they could have enjoyed longer lives. Hopefully, they know the values they espoused live on with their descendants!

GEORGE AND MARY(BEAGLE) SEIBEL

George Matthias Seibel was born on July 3, 1880 at Hamburg In, the son of Henry and Magdelina(Hahn) Seibel. He attended the Catholic school at Hamburg. George and his friends chewed tobacco while in school and would spit tobacco juice into their ink wells and then they would empty their ink wells out at recess.

George's father Henry was killed in 1888 when George was still a young boy. George and two brothers Feldy and Joseph, when ever married, lived with his mother in Kingston. His mother, Magdelina(Hahn) Seibel had remarried to a Peter Bittner. George and his brothers and sisters, liked their stepfather Peter.

George had the normal chores to do. He often would have to take the team of horses into the field for farming.

As his mother got older, she needed help with the housework. They hired the widow of Frank Beagle, Mary(Hampton) Beagle, to come in to help his mother with the work.

George and Mary fell in Love and were married in 1918 at Kingston, In., where his mother lived. George was 38 years old. They had a small wedding, and moved in with Magdelina, as she still needed help.

Mary(Hampton) Beagle was born on Jan. 1, 1895. She had two sons from her first marriage. 1. John Beagle who married Mary Thomas. John and Mary Beagle had three children: Phyllis who married Dick Helmich, Karen who married Roger Wagner, and Peggy. 2. Frank Beagle who married Ollie Clark in 1945. they had two children: Bill and Darlene Beagle.

After they were married Mary took care of Magdelina. George would take the team of horses to help build the road during the depression. He helped build the road from Sandusky to Clarksburg. Mary would take eggs to the Huckster wagon when it came to town. (The Huckster wagon came around with groceries) She would sell the eggs for 5 cents a dozen. When she did the cleaning she cleaned the rugs with a rugbeater, and she would let the kids help.

After his mother, Magdelina died in 1918, they moved to a farm East of Kingston, which they rented. They later moved to a farm in Rush Co., then to Spring Hill, West of Clarksburg. It was South of the Church. They rented, and lived there for 19 years.

In 1941, George bought 100 acres of land on a farm in Forrest Hill. After a while he purchased another 80 acres.

They attended the Greensburg Catholic Church. Once in 1945, they went to Greensburg for midnight Mass and the weather got so bad that they had to spend the night with their daughter in law Maxine. (Their son Ralph's wife) who lived in town while he was away in the service.

Maxine remembers Mary as a very quiet person. George Seibel died on September 9, 1962. Mary died on Dec. 8, 1973

George and Mary(Hampton) Beagle) Seible, were the parents of four children: Paul, Ralph, Herald, and Howard.

PAUL AND BETTY(GREEN)SEIBEL

Paul Seibel was born on July 14, 1919 the son of George and Mary (Hampton) Seibel. He grew up near Kingston in Decatur Co. He was married on Dec. 10, 1935 to Betty Green at the St. Mary's Catholic church in Greensburg. Betty grew up in Greensburg, the daughter of David John and Laura Bell(Hues)Green. Betty is employed as a bartender at the Will Mill on the Greensburg square.

Paul died on July 18, 1987 in Greensburg In. Paul and Betty were the parents of five children: Jane, Paul, Mary Alice, Becky, Angela.

1. Jane Laura was born on March 10, 1957 at Greensburg In. She was married to George Stewart. They had a daughter, Robin Renee. They were divorced and she remarried to Larry Land, they had no children. She was married a third time to a Muerer.

2. Paul was born on Aug. 20, 1961 at Greensburg In. He never married and lives in Greensburg with his mother.

3. Mary Alice was born on July 13, 1959 at Greensburg. She was married to John Davis. They had one son John Paul Davis who is 14 years old. They were divorced and she remarried to Thomas Moore. no children. Tom is presently in the service in Ill.

4. Becky was born on July 30, 1968 at Greensburg In. She was married to Don Parsons. They are the parents of three children, Bradly, Brandy, and Brenda Parsons.

5. Angela was born on Jan. 29, 1974 at Greensburg, In. She is the mother of one child, Ashly Rene Seibel, age two.

HOWARD EDWARD AND RUTH(BOSTIC) SEIBEL

Howard Edward Seibel was born on July 24, 1921 the son of George and Mary Seibel. He grew up on a farm near Kingston, in Decatur Co.

He was married to Ruth Devota Bostic, on May 13, 1934 at St. Mary's Catholic church in Greensburg. Ruth was born on April 29, 1927 at Adams In. She was the daughter of Russel and Mae (Burton) Bostic. She was one of five children: Ruth, Harry, Roland, Pauline, Eva.

Howard and Ruth lived at Adams in Decatur Co. In. Howard was a carpenter. He also worked for 28 years at Delta Faucet in Greensburg, and retired in 1986. Howard passed away on Aug. 7, 1992. Ruth is presently living in Adams.

Howard and Ruth Seibel were the parents of four children: Joseph, Sharon, Howard, and Marilyn.

1. Joseph George Seibel was born on Sept. 3, 1945. He was married Patty White. They were the parents of two children: Bryan and Randy Seibel. He and Patty were divorced and he is now married to Kim. They reside in Texas.

2. Sharon Kay Seibel was born on Feb. 10, 1947. She is employed at Delta Faucet in Greensburg. She lives at Adams.

3. Howard Edward Seibel Jr. was born on June 15, 1948. He was called (Sonny) by the family. He was married for a short time to Lisa, they were divorced. Howard was stationed in Korea in the service. While there he met and married his second wife Gison. They are the parents of two children: Mary and Paul Seibel. Howard retired from the service after 21 years, and is presently living in Tenn.

4. Marilyn Arlene Seibel was born on Sept. 22, 1952. She grew up in the town of Adams. She was married to Randy Dewherst. They have one son, Randy Dewherst Jr. Marilyn is presently employed at the James River Corp. in Greensburg.

RALPH AND MAXINE(WINGHAM) SEIBEL

Ralph Raymond Seibel was born on Sept. 5, 1923 near Kingston, in Decatur County. He was the son of George and Mary (Hampton-Beagle) Seibel. He grew up at Springhill, Indiana near Clarksburg. He attended the Clarksburg school, was there until the age of 18. He helped his father out on the farm. He milked cows, fed the chickens and cattle and did farming. They did the plowing and disking with a team of horses.

Ralph and his brother Howard were traveling around town one day in his 1945 Chevy, when they saw two attractive girls strolling along, so they stopped to meet them. One was his future bride, Maxine Wingham.

Ralph and Maxine were married on July 7, 1942. Ruth Maxine Wingham was born on Aug. 7, 1925 at Jefferson Co. In. the daughter of Marie and Giltner Wingham. They had to move when the Govt. bought up the land for the Jefferson Prov. grounds. They moved to Greensburg. Ruth Wingham was one of ten children: 1. Geneva Mae b/1927 2. Kenneth b/1931 3. Rosco b/1929 died age 2 4. Keith b/1933 5. Delbert b/1936 6. Janice b/1940 7. Stanley b/march 1944 8. Ruth b/1925 9. Nancy b/1951 10. Gerald, died young.

After Ralph and Maxine were married, they lived for a year or two with his parents at Springhill. Ralph farmed at first, then worked at Knobets & Sparks, a factory in Columbus that made bomb shells.

They moved to Forrest Hill at Greensburg, In. Their first child Judith Ann was born on Jan. 12, 1944, at Decatur Co. In. Ralph was drafted into the service in May 1945 while Maxine was pregnant with their second child. Ralph got a 10 day furlough to come home after the baby, Ralph Eugene was born. He was stationed at Camp Hood Texas, then sent to California, then to France and on to Belgium, Germany, but shortly after he arrived the war ended and all the men who had children were sent home.

Their third child Brenda Marie was born on Aug. 14, 1948, then James Richard was born Aug. 15, 1951 at Decatur Co. IN. They purchased their own home in Greensburg in 1952.

After the service Ralph was employed at the Hyatt Chevrolet garage in Greensburg.

Their son Ralph Eugene who was a Teacher at South Decatur school. he passed away on Nov.8, 1972

Maxine went to work at Bohn Aluminum form 1959-1962. She then worked for the Greensburg school system for 24 years and retired in 1989. She presently works part at Wal-Mart in Greensburg. Ralph presently is a car salesman at Al Reynolds and slao works at Valeo. He also has a lawn mower shop.

Ralph and Maxine are the parents of four children: Judy, Ralph(Bub), Brenda, and Jim.

1. Judy Ann Seibel was born on Jan. 12, 1944 at Greensburg, In. She attended the Greensburg school system. She was married to Steven Ricky. They were the parents of two sons, Brian and Tim. They were divorced and she remarried in 1983 to Horn Schlemmer. She presently lives at Westpeiser add. in Greensburg.

2. Ralph Eugene Seibel who was nicknames (BuB) was born on Sept. 27, 1945. He graduated from Greensburg High School and attended college at Western Ky. University. He graduated in 1963. He was married in Aug. of 1966 to Susan Blare at the Presbyterian church. Susan was the daughter of George and Barbra(Kelly) Blare. Ralph was employed as a teacher and a coach at South Decatur High School, in Decatur Co. Indiana. Ralph and Susan were the parents of two children: Scott, who is not married, and Sherry who married Chris Woolston. Sherry has a son Jeffery Woolston, born Jan. 29, 1988 and blare arthur Woolston was born on Sept. 10, 1993. Ralph passed away on Nov. 8, 1972 unexpectedly.

3. Brenda Marie Seibel was born on Aug. 14, 1948 at Greensburg. She was married to Bill Hornberger. She and Bill were divorced in 1982. They were the parents of three girls: 1. Christina, 2. Robin Elaina, 3. Aarin. Brenda presently lives in North Hill Michigan. She is employed as a night cleaner at a repair shop and at Hudson's Dept. store.

4. James Richard Seibel was born on Aug. 17, 1951 at Greensburg In. He graduated from the Greensburg school system. He presently works for Al Reynolds in Greensburg.

HAROLD AND DOROTHY(REED) SEIBEL

Harold Seibel was born on Feb. 2, 1928 at Spring Hill, In. He was the son of George and Mary Seibel. He attended school at Clarksburg, in decatur Co.

He served in the 82nd airborne division in the service. He served for 2 years from 1946-48.

He was married to Dorothy Reed on Nov. 8, 1947 at St. Mary's church in Greensburg. Dorothy Reed was born on Jan. 26, 1929, the daughter of George and Sylvia(Wilson) Reed, of Greensburg. She was one of five children.

Harold worked at Jackson office supplies and also for the Greensburg Daily newspaper for 25 years after which he retired. He and his wife presently reside in the town of Greensburg.

Harold and Dorothy are the parents of three children: Ronnie, Vicky, and Anita.

1. Ronnie Seibel was born on Aug. 1, 1952. He was married to Leslie Woodward. He is employed as executive vice president at Quad. Mid in Cypres, California. Ron and Leslie are the parents of two sons, Philip and Jeffery.

2. Vicky Seibel was born on July 26, 1954. She was married to David Clark in 1970. They are both school teachers. They presently live at Newcastle, In. They were the parents of two children: 1. Derek Clark who was born in 1975 and who died in 1989 at the age of 14 from Leukemia. 2. Mandy Clark.

3. Anita Seibel was born on July 26, 1954. She was married to Bob Workman. Bob is employed by a micro film-micro fish company. They presently reside in Greenfield, In. They have a son Ryan James Workman.

1
2
3
4
5
6
7
8
9
10
11
12
13
14
15
16
17
18
19
20
21
22
23
24
25
26
27
28
29
30
31
32
33
34
35
36
37
38
39
40
41
42
43
44
45
46
47
48
49
50
51
52
53
54
55
56
57
58
59
60
61
62
63
64
65
66
67
68
69
70
71
72
73
74
75
76
77
78
79
80
81
82
83
84
85
86
87
88
89
90
91
92
93
94
95
96
97
98
99
100

Hahn

m/around 1802
#2 Eva Francis (Renneberg?) b/1786 Limbourg
d/Jan. 4, 1862 Dearborn Co. In.

Children of Joseph and Eva:

1. b/1807	2. b/1808	3. b/1819	4. b/1820	5. b/1822	6. b/1829
Valentine m/ Elizabeth Worst b/1809 child: 1. Joseph 2. Barbra 3. Frederick 4. Magdalena 5. Mary Anna 6. Margareta 7. John	Sibilla m/ Peter Renner child: 1. Francis 2. Barbra 3. Sibilla 4. Lena 5. Mary Ann 6. Elizabeth 7. Catherine 8. Nicholas	Barbra m/ Adam Schmit child: 1. Peter Schmit	Anthony m/ Mary Anna Huff child: 1. Mary Anna m/Wm. L. Hugal 2. Christina m/Joe Hugal 3. Joseph m/Barb Meir 4. John m/Mary Brinkman 5. Valentine (Felty) m/#1 Susana Herman m/#2 Elizabeth Herman 6. Anthony m/Catherine Schwind 7. Francis m/John Eberhart 8. Lewis m/Mary Patterson 9. Magdalena m/#1 John Goddaka m/#2 Hageman	John m/ Elizabeth Weber child: 1. John Valentine 2. Magdeline 3. Adam	Mary Magdeline m/ Michael Werner child: Sibilla

Children of Valentine and Elizabeth (Worst) Hahn:

1. b/1835	2. b/1838	3. b/1840	4. b/1843	5. b/1847	6. b/1850	7. b/1853
Joseph Hahn m/1859 Eva Barbra Bishop child: 1. George 2. Lena 3. Henry 4. Margareta	Barbra Hahn m/1856 Matthias Herbert Child: 1. Barbra 2. William 3. Henry 4. Elsie 5. Gustie 6. Joseph 7. Marion	Frederick Hahn m/1864 Sarah Gard Child: 1.	Magdalena m/#1 Henry Seibel m/#2 Peter Bittner Child: 1. Henry 2. Anna 3. George 4. Valentine 5. Frank 6. Joseph 7. John 8. Kate 9. Bernadetta (Rose Marie) 10. Lena 11. Margaret	Mary Ann Hahn m/1866 Michael Seibel Child: 1. Mary Magdeline 2. Anna M. (Weimer) 3. Michael 4. Margaret 5. Valentine 6. John 7. Catherine 8. Henry	Margareta m/ not married	John Hahn m/ d/in Keiso Twp. Dearborn Co.

children of Magdalena Hahn and Henry Seibel:

1.	2.	3.	4.	5.	6.	7.	8.	9.	10.	11.
John b/1861 m/Mary Schroader child: 1. Edward 2. Eva 3. Henry 4. Joe 5. Mary	Kate b/1863 m/ Henry Schroader child: 1. Hilda (Mershman) 2. Elsie (Koch) (Vera, Al)	Margaret b/1865 m/? lived at home	Joe b/1870 m/never married	Anna b/1872 m/Frank Dwenger child: 1. Ray 2. Hilmer 3. Harry 4. Stella 5. Martha 6. Ellen	Henry b/1874 m/Carrie Dwenger child: 1. Arthur 2. Elenor m/Ed Peters (Howard, Carl, Helen) 3. Mable E. m/James Allen (Clarence, Rodney, Thelma) 4. Rosemary m/ Kirshner (Sandra, Linda, Carolyn)	Lena b/1876 not married	Valentine (Felda) b/1878 not married	George b/1880 m/Mary (Hampton) Beagle child: 1. John Beagle (step) 2. Frank Beagle (step) 3. Paul m/Betty Green (Jane, Paul, Alice, Becky, Angela) 4. Ralph m/Maximo Wingham (Judy, Halph, Brenda, Jim) 5. Harold m/Dorothy Reed (Vicky, Ronnie, Anita) 6. Howard m/Ruth Boatic (Joe, Sharon, Howard, Marilyn)	Frank b/1883 m/#1 Clara m/#2 Newman child:	Bernadetta b/18 (Rose Marie) a Nun Wendenhall died Nov. 3, 1918

Children of Frank and Anna (Seibel) Dwenger:

1. b/1893	2. b/1895	3. b/1898	4. b/1904	5. b/1905	6. b/1908
Hilmer John m/ Elenora Walke child: 1. Hilmer 2. Dorothy 3. Carol	Raymond Wm. m/Flora Rolfes child: 1. Robert 2. Ralph 3. Edna 4. Helen 5. Donald 6. Russell 7. Mary Jane 8. Patricia	Harry J. m/ Mary Hessler Child: 1. Kathy 2. Esther 3. Rosie 4. Ruth 5. Annie 6. Dick 7. Betty 8. Leonard 9. Mary Ellen 10. Edward Joseph	Stella died on Dec. 22, 1916 age 12	Martha m/ Bernard Stier child: 1. Harold 2. Margie 3. Phyllis	Ellen m/Joseph Ries child: 1. Jo Ann 2. Jimmie 3. Marion 4. Evelyn

VALENTINE AND ELIZABETH(WORST) HAHN

Valentine Hahn was born around 1807 in Bavaria, Germany. He was often called Felty) as a nickname. This has showed up, even in some old church records.

He was the son of Joseph Hahn and and Eva Francis Hahn (b/1786-d/Jan.4,1862 at age 76 in Dearborn Co. IN.). He was one of six children, that we know of: Valentine,Sibilla,Anthony, Barbra, John,Magdlena.

His parents emigrated to the United States of America around the year 1834. They settled first in Pennsylvania, but stayed only a short time before moving on to Ohio, and then to Dearborn, County in Ind. Joseph Hahn purchased land in Dearborn Co. in kelso Twp. sec.3,2,and 10 in township 7 range 2.

Some of the children married in Ohio, others married after they arrived in In. Valentine was married to Elizabeth Worst, probably in Ohio. The Hahn's settled in Kelso twp. and attended the St.Joseph Catholic church at St.Leon In

Elizabeth Worst was born around 1809 in Bavaria, Germany. I do not know anything of her family at this time.

The records at the St. Leon Catholic church, showed that Anthony and Mary Anna(Huff) Hahn and Valentine and Elizabeth (Worst)Hahn were the Godparents for each others children, in the 1840's. Valentine and Elizabeth(Worst) Hahn were the Godparents to Anthony's son Valentine Hahn b/1847.

In 1850 they were in St. Leon, in Dearborn County(Kelso Twp.), and attended the Catholic church there. In the late 1850's Valentine and his younger brother Anthony moved on to Franklin County. In 1860 they were in Franklin County in Ray twp. Valentine was listed in the Census as a blacksmith and a farmer. Anthony moved on to Decatur County from there.

Valentine and Elizabeth purchased land in Franklin County. The South 1/2 of West 1/2 of N.E. qtr. of fractional sec. 14, twp. 11, range 11, Valentine and Elizabeth were said to have movved around frequently.

In Feb. 1868 in Franklin Co. In. Valentine and Elizabeth Hahn sold the above mentioned land to Herman Kotter for \$615. it was 40acres. I have no record of them after that date. A history written by a child of their daughter Barbra who married Matthias Herbert, mentioned them and said they lived at various places. It also and said that his death occured at Hamburg. no date given. When Elizabeth died on where they are buried is as yet unknown.

Valentine and Elizabeth Hahn were the parents of eight children:

1. Joseph Hahn b/Oct. 1835 Ohio m/1859 Eva Barbra Bishop, they had four child:George,Lena,Henry,Margaretta

2. Barbra Hahn b/1838 Ohio m/1856 Mattias Herbert, they had eight children: Edgar,Barbra,Will,Harry,Elsie,Gustie,Joe,Marion

3. Frederick Hahn b/1840 Ohio m/1864 Sarah Gard
child: I do not have childrens names.

4. Magdelina Hahn b/Feb. 26, 1843 m/1860 Henry Seibel. They lived in Hamburg, and had eleven child: Henry,Anna,George, Felda, Frank, Joe, John, Kate, Bernadetta, Lena, Margaret

5. Maria Anna Hahn b/1847 m/1866 Michael Seibel, they were the parents of three children. child:Mary Magdeline,Anna Marie, and Michael Seibel.

6. Margaretta Hahn b/1856 m/not married

7. John Hahn b/1853 m/?

Valentine and Elizabeth(Worst) Hahn -- the sale of land by them.

this indenture- witnesseth that Valentine Hahn and Elizabeth Hahn, his wife of Franklin County in the State of Indiana Convey and Warrent to Herman Kotter, in Franklin County in the State of Indiana for the sum of Six hundred and fifteen \$615.00 Dollars, the receipt whereof is hereby acknowledged. The following real estate in Franklin County in the State of Indiana to Wit.

The South half of the West half of the North East Quarter of fractional Section Fourteen (14), Township Eleven (11) of Range Eleven Containing Forty acres more or less. In Witness Wherof the said Valentine Hahn and Elizabeth Hahn, his wife, have hereunto set their hand and Seal this 2nd day of February 1868.

Gov. stamp Cancelled
One Dollar

Valentine Hahn Seal
Elizabeth (X)Hahn Seal
(x-her mark)

x This Indenture Witnesseth That Valentine Hahn and Elizabeth Hahn, his wife, of Franklin County in the State of Indiana Convey and Warrant to Herman Kotter, in Franklin County in the State of Indiana for the sum of Six hundred and fifteen \$615.00 Dollars the receipt whereof is hereby acknowledged the following Real Estate in Franklin County in the State of Indiana to Wit.

The South half, of the West half, of the North East Quarter, of Fractional Section, Fourteen (14), Township Eleven (11) of Range Eleven (11) Containing Forty acres more or less In Witness Wherof the said Valentine Hahn, and Elizabeth Hahn, his wife, have hereunto set their hands and seals this 2nd day of February 1868.

Gov Stamp Cancelled
One Dollar

Valentine Hahn Seal
Elizabeth (X) Hahn Seal

ANTHONY AND MARY ANNA(HUFF) HAHN

Anthony Hahn was born in Germany in 1818. He was brought by his parents to America. They arrived on a ship from Germany in 1834, when Anthony was just 16 years old. Anthony was the son of Joseph Hahn, and Eva Frances Hahn, both from Germany. He was one of six children that we know of: 1. Valentine b/1807 2. Sibella b/1808 3. Anthony b/1818 4. Barbra b/1819 5. John b/1822 6. Mary Magdeline b/1829

His parents, Joseph and Eva Francis Hahn, settled first in Penn., then subsequently moving to Ohio, then too Dearborn Co.

Anthony Hahn was married to Mary Anna Huff. Mary Anna was also born in 1819 Germany, and came to the United States at the age of ten with her parents.

Anthony was found owning land in 1839 in Dearborn, Co. where he sold much of it between 1839 and 1851.

In 1850 Anthony and Mary Anna Hahn were living in Center Twp. in Dearborn Co., near his brothers Valentine and John. They were members of the St. Leon Catholic Church. Their son Valentine was born on Feb. 27, 1847 at St. Leon. His Godparents were Valentine and Elizabeth (Worst) Hahn.

By 1860 the Hahn's had moved on to Franklin Co. We found them in June of 1860, living in Ray Twp. in Franklin Co. Anthony was a farmer.

In 1861 Anthony and Mary Anna moved to Decatur Co. Indiana, in Marion Twp. They purchased a farm near Millhousen, in Indiana. They were members of the Catholic church, and were highly respected in the community.

Mary Anna (Huff) Hahn passed away in 1898 in Decatur County. Anthony Hahn passed away in 1903, in Decatur, Co. In.

Anthony and Mary Anna Hahn were the parents of nine children: Anna Maria, Christina, Joseph, John, Valentine, Anthony, Francis, Louis, Magdeline.

1. Anna Maria Hahn was born June 1, 1837 at St. Leon In. She was married to Lewis William Hugal on Oct. 18, 1855 at Oldenburg, IN. Lewis was born on Oct. 13, 1832. They moved to Muncie In. They had two children: Mary Christina b/1856 and Magdeline b/1858.

2. Christina Hahn was born in 1839 at St. Leon In. She was married in 1865 to Joseph Hugal. They had ten children. (I have only one child's name.) 1. Mary Hugal was born March 3, 1859 and died Dec. 29, 1955. She married James O'Donnell on Nov. 12, 1877 one child: Mrs. William (Rose) Olinger d/1925 12 children.

3. Joseph Hahn was born in 1843 at St. Leon In. He was married twice. M/#1 in Jan. 29, 1857 to Barbra Meier b/1838 Bavaria. M/#2 was to Mrs. William Mueller on May 15, 1895. He lived in Franklin Co. He had five children: 1. George b/1861 IN. 2. Magdeline b/1863 In. 3. Henry b/1866 (twins) 4. Margaretta b/1866 In. 5. Anna b/1870.

4. John Hahn was born in 1843 at St. Leon In. He married on July 9, 1868 in Augusta Ky. to Mary Brinkman b/1851 Ky. A child: Frank b/1869

5. Valentine Hahn was born on Feb. 27, 1847 at St. Leon In., Dearborn Co. He was the son of Anthony and Mary Anna (Huff) Hahn. He was married twice (sisters). He married first to Susanna Herman on Sept. 20, 1870, She was born on - the daughter of Joseph and Susannah (Young) Herman, natives of Germany who settled in Sandcreek Twp. in Decatur Co. Susannah died on June 27, 1887. nine children from that marriage: 1. Caroline Hahn born July 20, 1871 and who married Herman Rolles. They had four children: Ray, Ruth, Thelma and Mildred Rolles. 2. Ida Hahn born March 8, 1873 and married Frank Notter of Indianapolis, and had a child, Henrietta who married Rudolph Price (2 child Francis, Laverne). 3. Charles Hahn born on Nov. 20, 1875, of Marion Twp. he married Josephine Ortman and has three children: Edna m/George Hardebeck, Catherine m/John Koors Jr.,

and Loretta m/Joe Forster 4. Henry Hahn was born April 11, 1877, also from Marion Twp. He married Minnie Langs, and had three children: Marie and Frank m/Mary Scheidler, Herbert (killed in WW2) 5. Dora was born on Aug. 17, 1879 she was married to William Link of Millhousen. They had four children: Walter, Ethel m/Logan, Martha m/Glen Hungate, Howard married and lived Texas. 6. Sarah Hahn was born in Sept. of 1881 she passed away young. 7. Mary Hahn was born on March 26, 1883 and married William Bruns of Ripley Co. They had three children: Esther, Alma and Bernatta Bruns. 8. Andrew Hahn was born on March 21, 1885 of Marion twp. he married Rose Hardebeck and had four children: Hilbert, Maurice, Naomi, Susanna. 9. Albert Daniel Hahn was born June 5, 1887. Lived in Wash. twp he married Anna Evangeline Tucker born Feb. 14, 1909 and had six children: A. Leone Hahn b/Feb. 1909 m/Herold Dwenger (5 child: Jean, Ruth, Martha, Joe, Linda) B. Leo David Hahn b/1911 m/Verna Eichacker, C. Valentine Hahn b/1913 m/Constance Campbell (2 child Alfred, Roland), D. Mary Gertrude b/1915 m/ Clyde Pate D. Alfred (Fritz) b/1924 m/Elanca Mijeska, E. Rollin b/1929 not marr.

After the death of Valentine Hahn's first wife Susanna, he remarried to her sister Elizabeth Herman on Aug. 7, 1889. Elizabeth was born on Sept. 25, 1860 Cinn. Ohio. They had five children: 1. Wilfred Hahn was born on Oct. 12, 1890 and married Anna Gates, they had a son Wilfred Jr. 2. Lawrence Hahn was born on April 29, 1894 he was married to Josephine Harpring who was born on June 22, 1901. They were the parents of four children: A. Norbert Hahn born April 7, 1927 who married Margie Stier and had 7 child (Theodore, Daniel, Nicole, Gordon, Mark, Andrew, Patrick) B. Ernest Hahn who married Carol Muckerheid and had two child (John and Kevin) c. Ralph who married Beverly Cross and had 3 child (Mike, Carla m/Rob Bileau, Robin) D. Mildred who married Alvin Koors and had eight children (Tom, Doris, Herbert, Jerry, Richard, Debbie m/ Steve Wilson, Jeff, Becky) 3. Leonard Hahn was born on Jan. 26, 1876 not Marr. 4. Carlotta Hahn born Nov. 6, 1898 not marr. 4. Ernest Hahn born Jan. 3, 1902 and died young.

6. Anthony Hahn was born on Jan. 3, 1850 at St. Leon In. HE was married to Catherine E. Schwind on June 9, 1892.

7. Francis Hahn was born in 1853 She was married in 1872 to John Eberhart. They lived in Kokomo.

8. Louis Hahn was born in 1857 in In. He was married on Jan 4, 1881 to Mary Lavina Patterson. They lived at Morris, Franklin Co.

9. Magdelina Hahn was born in Feb. 1858 In. Married twice. m#1 to John Godaka Decatur Co. He passed away. M#2 E. Hahaman, Muncie



Anthony Hahn b/April 28,1819



Mary Anna(Huff)Hahn b/1819



family of Valentine Hahn and Elizabeth(Herman)Hahn Decatur Co. In. 1891
(8 children from 1st wife Susannah(Herman)Hahn)
L to R:Dora,Andrew,Ida,Carolyn,Albert,Elizabeth,Wilfred,Mary,Valentine,Charles,Henry

#1

HESSLER

Adam Hessler b/1680 Krombach, Germany d/1725 married/
Margaretha --- b/16--Germany d/July 8, 1729 Krombach

1. b/before 1710 Germany d/1742
Johann Hessler
m/1722 born
Anna Barbra Jung before 1712

child:
1. Andreas Hessler

1. b/1730 d/1759

Andreas Hessler
m/1752
Maria Hornick

child:
1. Johann Phillip
2. Johann
3. Heinrich
4. son

1. b/1759
Johann Hessler
m/1780
Susanna Schorer

child:
1. Konrad Hessler

2. Heinrich b/1753
had descendants
1. Holmet d/1972
2. Elvira Kilgenstein
3. Wernor d/1982 was
the mayor of Scholl-
kripen in 1974 (m/Erna)

3. b/1757 * see
Johann Phillip

m/
child:
1. Franz b/1812 d/1894
m/Magdelina Rosenberger
2. George Adam m/Margaret Glaab

4. son
a descendant of
this son
"Leo Hessler"
lived in
Houenstein in 1974

1. b/1781 Germany
d/1842 Indiana

Konrad Hessler
m/1801 Germany
Anna Fleckenstein

child:
1. Johann Hessler
2. John Adam
3. Margaret
4. Mary Anna

1. b/1804
Johann Hessler
m/
Magdelina Buttner

child:
1. Rosina
2. John
3. Catherine
4. Anna Mary
5. Gerhard
6. Gerhard
died in Oct of cholera
together

2. b/1807
John Adam Hessler
m/
Anna Maria Neese

child:
1. Eva
2. John
3. Adam
4. John
5. Margaret (Stahl)
6. Anna Mary (Stahl)
7. Gerhart

3. b/1809
Margaret Hessler
m/
John Adam Schnieder

child:
1. Margaret m/Georg Schneider
(9 child)
2. Adam m/Louisa (Anna Mary)
3. Caroline m/Bernard Brandwiede
4. Catherine m/Heodore Pfeiffer
(6 child)

4. b/1817
Mary Anna Hessler
m/
Francis Link

child:
1. Margaret
2. Adam
3. John m/Theresa Fry (dit)
4. Francis m/Sarah Deason
5. Herman m/Sophia Graus
6. Mary
7. Magdeline

1. b/1833
Eva Hessler
died
at
age 17

2. b/1835
John Hessler
(big John)
m/#1/Catherine
Wissel d/1877
n#2/Louise
child:
13 child
1st wife
2 child
2nd wife
Illinois

3. b/1840
Adam John
m/1865
Catherine
Stahl
child:
1. Mary m/Joe
Menkedick
(Theresa, Louis, Cath) m/
(Henry, Will, Joe, Anna)
2. John
(died young)
3. Frank m/Mary
Rutt
(Philomen, Francis, Mary,
Matilda, Ceal, Rose, Clara, Joe,
Gertrude, Chris, Hildegard,
Lawrence, Aloysious, Helen, Marg.)
4. George m/#1 Anna Herbert
#2/Viola Wheeldon
(Fred, Thelma, Rose, Elsie, Lester,
Alvin, Henry)
5. Adam John m/Ida
Wagner
(Anna, John)
6. Gerhart m/Catherine
Vanderpohl
(Theresa, William, Freda, Ray,
Albert, Carl, Lidia)
7. Henry
(died Young)
8. Andrew m/Catherine
Enderline
(Arealea, Marcella, Angeline,
Mary Etta, Cressie)

4. b/1841
John
m/Mary Stahl
child:
1. Clarence
m/
2. Albert

5. b/1844
Margaret
m/1866
Adam Stahl
child:
1. George m/
Mary Shrader
(no children)
2. Frederick
m/Minnie E. Lahn
(Will, Charles, Girl)
3. Lewis m/Anna
Vanderbosch
(Margaret, Rudolph,
Paul, Rosalie)
4. Anna M. L. m/
Henry Kinney
George, Charles)
5. Charles J. m/
Elsie E. Jessup
(Francis, Agnes, Clare)

6. b/1846
Anna Mary
m/1866
George Stahl
child:
1. John m/Mary
Richey
(Clarence, Will,
Carl, Herman)
2. Catherine
(not Married)
3. Lewis m/Anna
died at age
three)

3. Anna Mary m/
James Kirby
(6 children)
4. Anna Catherine
(died at age 1)
5. John Adam
(died at age 3 1/2)
6. Margaret Rose m/
Arthur Coyle
(Agnes, George, Ray,
Anna Mary, Rose, James,
Joe, John, Leo)
7. Henry T. m/Maude
Gerhart
(Martin, Rosemary,
Richard, Houston, Henry,
Ivan, Cecilia, Alfred)
8. Mary Theresa m/
Edward Mueller
(no children)
9. Joseph A. m/
Gertrude Lowlett
(Joe, Paul, Ed, George, Theresa, Elmo)
10. Leo Francis m/
Zora Reagan
(Elenor, Leo Jr., Raymond)

7. b/184
Gerhard
m/?

1.b/1866	2.b/1868	3.b/1871	4.b/1873	5.b/1875	6.b/1876	7.b/1878	8. b/1879
Mary m/Joseph Menkedick Child: <u>L. Theresa</u> m/Lolus Moorman Lawrence (not m/) Stella(Scheidlr) Alma(Schwering) Lucille(Braun) Martha(Batta) Mary(Yeager) Ralph Carl Ileen(Schebler) Walter 2. <u>Louis</u> m/ Elizabeth Parr Mary Jane(Died) Tholma(Crawley) 3. <u>Catherine</u> m/ Lawrence Duerstock Margaret(Bedal) Norbert Kenneth Helen(Tebbe) Rita(Young) Urb Vincent Cyril Marvin 4. <u>Henry</u> m/ Catherine Wenning Carl Alfred Edna(Zobel) Harold Clifford Mary Ellen 5. <u>William</u> m/ Helen Draping Dale Irene(Wenning) 6. <u>Joseph</u> m/ Gertrude Weimer Tom Gertrude(Tevis) 7. <u>Anna</u> m/ died young at 18mos.	John died in 1870 at age 2.	Frank m/Mary Rutt child: 1. <u>Philonena</u> m/Herman VoorKamp (Cathy,Rita, Herman,Norbert, Stanley,Martha, Cyril,Ralph, Patricia,Barb, Margaret,Tony, 2. <u>Francis</u> m/ Theresa Hardebeck (Margie,Bertha) 3. <u>Mary</u> m/Harry Dwenger (Kathey,Esther, Rose,Ruth,Ann, Dick,Betty, Leonard,Mary Ellen,Edward) 4. <u>Matilda</u> m/Clem Stuhrenburg (Mary Agnes, Bernard,Dorthy, Vincent,Maurice Jerry Ellen,Lucille, Alvin,Marie, Beth,Mary) 5. <u>Cecilia</u> m/ Bernard Harpring (Joan,Edgar, Irma,Lois, Luella,Elvora, Bernard,Vernon) 6. <u>Rose</u> -a nun sister Joseph Marie 7. <u>Clara</u> m/ Geo. Naderman (George,Justin, Rose Marie,Jane, Edna,Albert,John, Esther) 8. <u>Joseph</u> m/ Bernice Wenning (Ken,Judith,David, Mary Ann,Robert) 9. <u>Gertrude</u> (Bobbie) m/Clem Koors (James,Sylvester, Paul,Carl;Donald, Lewis) 10. <u>Christine</u> m/ Alvin Cord (Francis,Deloris, Carolyn) 11. <u>Hildegard</u> died at age 3 12. <u>Lawrence</u> died at age 2 13. <u>Aloysious</u> died at 4½ mon. 14. <u>Helen</u> (Tonnie) a nun - sister margaret Mary 15. <u>Margaret Agnes</u> died at age 3 weeks	George m//iViola Wheeldon m#2 Anna Herbert #3 child: 1. <u>Fred</u> m/Ries Catherine Wagner 2. <u>Thelma</u> m/ Jim Darby Dale Deloras(Hottinger) Jim Donna(3. <u>Rose</u> m/ Clarence Hardebeck Tony Bill Marietta(died) Norman Mary Ann(Runyan) Margaret(Kipper) Betty(died) 4. <u>Elsie</u> m/ Ralph Sealing Jim Vincent,Maurice Jerry 5. <u>Henry</u> (died at age one) 6. <u>Lester</u> died at age twenty-four 7. <u>Alvin</u> died at age two	Adam John m/Ida Wagner child: 1. <u>Anna</u> m/ John Dwenger (no child.) 2. <u>Andrew</u> m/	Gerhart m/Catherine Vanderpohl child: 1. <u>Theresa</u> m/ Charles Burkhardt Rosemary(Walpe) Luella(Feldman) Carl Jos. Thomas William Charles 2. <u>William</u> m/ Rosemary Kalb William Marilyn(Schneider) Rosemary(Kramen) 3. <u>Freda</u> m/#1 Rochford Simmons m/#2 Harry Pennish Edith Sammons 4. <u>Raymond</u> m/ Cecilia Grider Raymond James Shirley(Grochalski) 5. <u>Albert</u> m/ Mayme Harbaugh (no children) 6. <u>Carl</u> m/ Hilda Kuhn Charles John Gerhard Catherine (Rettenbacher) 7. <u>Lidia</u> m/ (died young)	Henry m/ died age 1	Andrew m/Catherine Enderline child: 1. <u>Arealea</u> m/#1 Charles Wood m/#2 Brian Rork m/#3 Roy Zeigler (no children) 2. <u>Marcella</u> m/ George Vanzant Robert 3. <u>Angeline</u> m/ Roman Ebbing Kenneth Edward 4. <u>Mary Etta</u> m/ Earl Layton James Earl Norman Helen(Graue) 5. <u>Cressie</u> m/ never married fought in W.W.II

for more information
see Frank and Mary
Hessler graph

OUR HESSLER ANCESTORS AND THEIR GERMAN HOMETOWN

By Charles A. Hessler

During the 19th century about five million people left their homes in Germany to build new lives in the United States. Our Hessler ancestors were part of a wave of immigrants who left Germany in search of a new life. Some immigrants came for political reasons, others for economic ones. Our ancestors were probably motivated primarily by economic reasons. They had been poor farmers or peasants in Germany for many generations. They were likely serfs during the 17th and 18th centuries. It is not clear when they became free of their obligations to some feudal knight or lord, but at least from 1806, when serfdom was abolished in the German lands conquered by Napoleon Bonaparte, the Hesslers were more or less free to live where they chose.

In 1838, Conrad Hessler (my great-great-great grandfather) decided to leave his home in Germany and travelled to the port city of Bremen, together with his wife and several of his children and grandchildren. In Bremen, they boarded the ship Mathilde bound for Baltimore. At that time, Conrad was 56 years old, though the ship's passenger list shows his age as 60. After a few months in the Cincinnati area, Conrad and his children settled just south of what was to become the town of Millhousen, Indiana. Conrad lived in the Millhousen area until his death in 1842.

In Germany, the concept of Heimat or homeland is very important. I think it must have taken a lot of courage for our ancestors to leave their German Heimat for an unknown future in America. All of us can be very grateful that they took the chance and found the United States a good place to raise their families.

When I first became interested in family history, I had no idea that Conrad Hessler had settled in this country. In fact, it was only from the family record book started by Mary (Rutt) Hessler and continued by her daughter Mary Dwenger (my father's first cousin) that I learned about my great-great grandfather John Hessler, who died in 1873. That book also confirmed that the Anna Maria Hessler (who died in 1880 and whose tombstone with an inscription in German is in the Millhousen cemetery) was John Hessler's wife and my great-great grandmother. I assumed that John and his wife Anna Maria were my only immigrant Hessler ancestors.

When I learned of the existence of John and Anna Maria Hessler, I knew almost nothing about them, let alone about their parents or their hometown in Germany. No one in the family had any recollection of an older generation of Hessler immigrants, consisting of John Hessler's parents. In fact, before 1970, I really knew very little about any of my Hessler ancestors, except my father, Carl Hessler, and his parents, Gerhard and Catherine (Vanderpohl) Hessler. Then, while cleaning out my mother's attic in Greensburg in 1970, I discovered a large portrait of a rather sober-looking couple. I did not know who they were, so I asked my mother. She really was not sure about their names, but she knew they were Hesslers, probably my great grandparents. After checking with several other people in the family, I confirmed that they were my father's Hessler grandparents. Their names were Adam John Hessler and his wife Catherine (Stahl) Hessler.

I learned that Adam John Hessler was born in Millhousen, Indiana, on February 17, 1840, about a year after his parents John and Anna Maria (Nees) Hessler had settled in the Millhousen area. I had heard for years that two Hesslers were among the original thirteen pioneers who had settled Millhousen, so I thought maybe they came from a town named Millhousen. After I had done quite a bit of research on the early settlers of the Millhousen area and had traced our Hessler ancestors to their German hometown, it was clear that Millhousen was not named for the hometown of the Hesslers.

Finding that old portrait was what really hooked me on the Hessler family history. Before that, when I had asked my father where his Hessler ancestors came from, he said it was somewhere in Bavaria, but he did not know the name of their hometown. Now I was determined to find out exactly where in Germany the Hesslers had lived.

Crossing the Atlantic aboard the Ship Mathilde

While spending a year at home with my mother in Greensburg in 1971-72, I had time to search through church records, census lists and courthouse records. My mother paid a researcher in Washington to find more information about the Hesslers. That researcher found some ship passenger lists showing Hessler immigrants, but he overlooked the correct listing, which showed a party of 14 immigrants headed by Conrad Hessler, aboard the ship Mathilde from Bremen to Baltimore in 1838.

Those 14 immigrants included my great-great-great grandparents, Conrad Hessler and his wife Anna Maria Fleckenstein. Traveling with Conrad were his son John Hessler and John's wife Anna Maria Nees (my great-great grandparents), Conrad's daughter Margaret and her husband Adam Schneider, Conrad's daughter Mary, and several grandchildren. The passenger list for the Mathilde shows the hometown of the Hesslers as "Schöllkripon." At least five other families came from villages within two miles of the Hesslers' home, so the Hesslers probably knew them and perhaps had planned the trip together with some of those families. There were 37 family groups (114 passengers) aboard the Mathilde. Children were born to two families (Roth and Steigerwald) during the voyage, so actually 116 immigrants arrived at Baltimore on the Mathilde.

A newspaper published on March 27, 1838, in Alzenau (a town about seven miles west of the Hesslers' home), listed the names of Conrad Hessler and his children as emigrants headed for North America. This newspaper provided further details, confirming that Conrad Hessler, a shoemaker, was from Schöllkrippen, that his daughter Margaret and her husband Adam Schneider were from Schöllkrippen-Waag, and his son Johann Hessler and his wife Anna Maria Nees were from Krombach.

The Mathilde left Bremen on July 21, 1838, and arrived at Baltimore on September 21, 1838, after a voyage of 62 days. If Conrad and his family left their homes at the end of March 1838, as the Alzenau newspaper suggests, it took them nearly four months to reach the port city of Bremen, about 200 miles north of their home villages, and arrange passage to America. That was about twice as long as the ocean voyage itself.

Locating the German Hometown of the Hesslers

But that's getting ahead of the story. I only found that passenger list showing Conrad Hessler after I already knew the Hessler family had come from a small village in northwestern Bavaria called "Schöllkrippen," and I only learned about the Alzenau newspaper listing Conrad and his family even later. It was the naturalization records of Conrad Hessler and his son Adam at the Decatur County courthouse that provided me with the critical clues about our ancestors' home near Schöllkrippen.

Conrad Hessler's application for naturalization (recorded in Greensburg on April 20, 1839) shows his home as the state of Aschaffenburg in Germany. When Conrad's son Adam Hessler, who arrived in the U. S. in August 1841, filed for naturalization as a U. S. citizen on August 23, 1843, his hometown was shown as "Shilgrape." By looking at a detailed map of Germany showing the vicinity of Aschaffenburg (about 25 miles east of Frankfurt), I found a small town called "Schöllkrippen." It seemed obvious to me that this must be the right place.

I wrote to the parish priest in Schöllkrippen twice and never received an answer. I was very disappointed, though I still felt I was on the right track. Next, I wrote to several German archives trying to obtain more information. Finally, in 1973, I received a nice note from an archivist in Nürnberg. He said his library had nothing that would help me, but he gave me the address of an old schoolmate named August Hessler, who had grown up in the same part of Bavaria where Schöllkrippen is located.

I wrote to August Hessler in Munich. After several weeks, I received a friendly letter from August Hessler, who was in his 80s at that time. August said that I was writing to the wrong church. He said that most of the Hesslers that he knew had been members of the Krombach parish, about two miles west of Schöllkrippen, and that several Hesslers were buried in the Catholic cemetery in Krombach.

Taking August's advice, I wrote to the parish priest in Krombach asking if his church records had any information about my great-great grandfather John Hessler. In a few weeks I received a detailed reply giving me information about John Hessler and his parents and grandparents. The birth date for John Hessler, February 4, 1804, corresponded almost exactly with the information contained in the family record book that my father's cousin Mary Dwenger had shown me several years earlier. Actually Mary Dwenger's record book shows John Hessler's birth date as February 2, 1804. While it is possible that John Hessler was born and baptized on the same day, as the Krombach records seem to indicate, it is also possible that John was really born on February 2nd and baptized two days later. Anyway, I knew that I had found the hometown of the Hesslers.

I wrote several more times to Father Josef Bretz, the pastor at Krombach. In August 1974, I visited Krombach with my wife Jane as part of our honeymoon trip to Europe. At that time, I was able to spend several hours reading the Krombach church records, and I found a few more Hessler entries to supplement the information provided by Father Bretz. In a separate section, I have included a family tree of our German Hessler ancestors, based on those Krombach church records.

The regular Krombach church records date only from 1715. There is one older church book with a few records dating back to 1669, but there are no Hessler births or marriages in that book. That book is less than an inch thick and measures about four inches wide and perhaps eleven inches long. The book, though in poor condition, has a beautiful old cover decorated with a manuscript text.

Krombach

Krombach is a very old town. It celebrated its 1000th anniversary in 1991. Hesslers lived in the Krombach area at least from the 1680s because there are two entries in the earliest Krombach church book listing Hesslers as godparents. In 1684, Eva Hessler, daughter of Jacob Hessler, was a baptismal sponsor for Eva Näsin. In 1687, Anna Maria Hessler, the wife of Johann Stephan Hessler, also served as a baptismal sponsor.

It seems likely that Hesslers lived in the Krombach area for several hundred years before that. Perhaps they were among the families who lived there in 991 when Krombach was founded. Maybe they were among the families who are said to have emigrated from the area near the Dutch border in the 9th century and settled the area around Krombach. It is interesting that the parish church in Krombach is named for St. Lambert, who was a Dutch bishop in the town of Maastricht in the 7th century. The feast day of St. Lambert is September 18th. The church in Krombach also has another patron, St. Sebastian, who was an early Christian martyr.

The church at Krombach was founded by Benedictine monks from the monastery at Seligenstadt, which is about ten miles west of Krombach. The monastery at Seligenstadt, a town on the Main River, was founded in 828 by Einhart, the biographer of Charlemagne. Legend has it that Charlemagne gave Seligenstadt its name, which means "Blessed City." Geiselbach, a town about two miles north of Krombach, was a Hof (farm) owned by the Benedictine Abbey at Seligenstadt. Originally, the Hof at Geiselbach also included the land around Krombach.

On the next page is a map from an 1836 magazine showing Germany as it existed at that time. I have drawn a small circle on that map to show the area east of Frankfurt where our Hessler ancestors lived. I have also marked on that 1836 map the general location of Lemberg, the town where the Stahls lived before emigrating to the United States. Lemberg is about 2-1/2 miles southeast of Pirmasens, Germany, near the French border.

On the following page are two hand-drawn maps showing most of the places that I mention in this section on the Hesslers' German homeland. The Kahlgrund area where the Hesslers lived is now part of "Unterfranken" or "Lower Franconia" in Bavaria. Krombach and the surrounding Kahlgrund area were part of Landkreis (county) Alzenau until a reorganization of administrative districts occurred in 1972. Since then, the Kahlgrund area has been part of Landkreis (county) Aschaffenburg.

1836

M A P

of the Customs

Union of

GERMANY

B A L T I C S E A

German Homeland of the Hesslers
Kahlgrund (just east of Frankfurt)

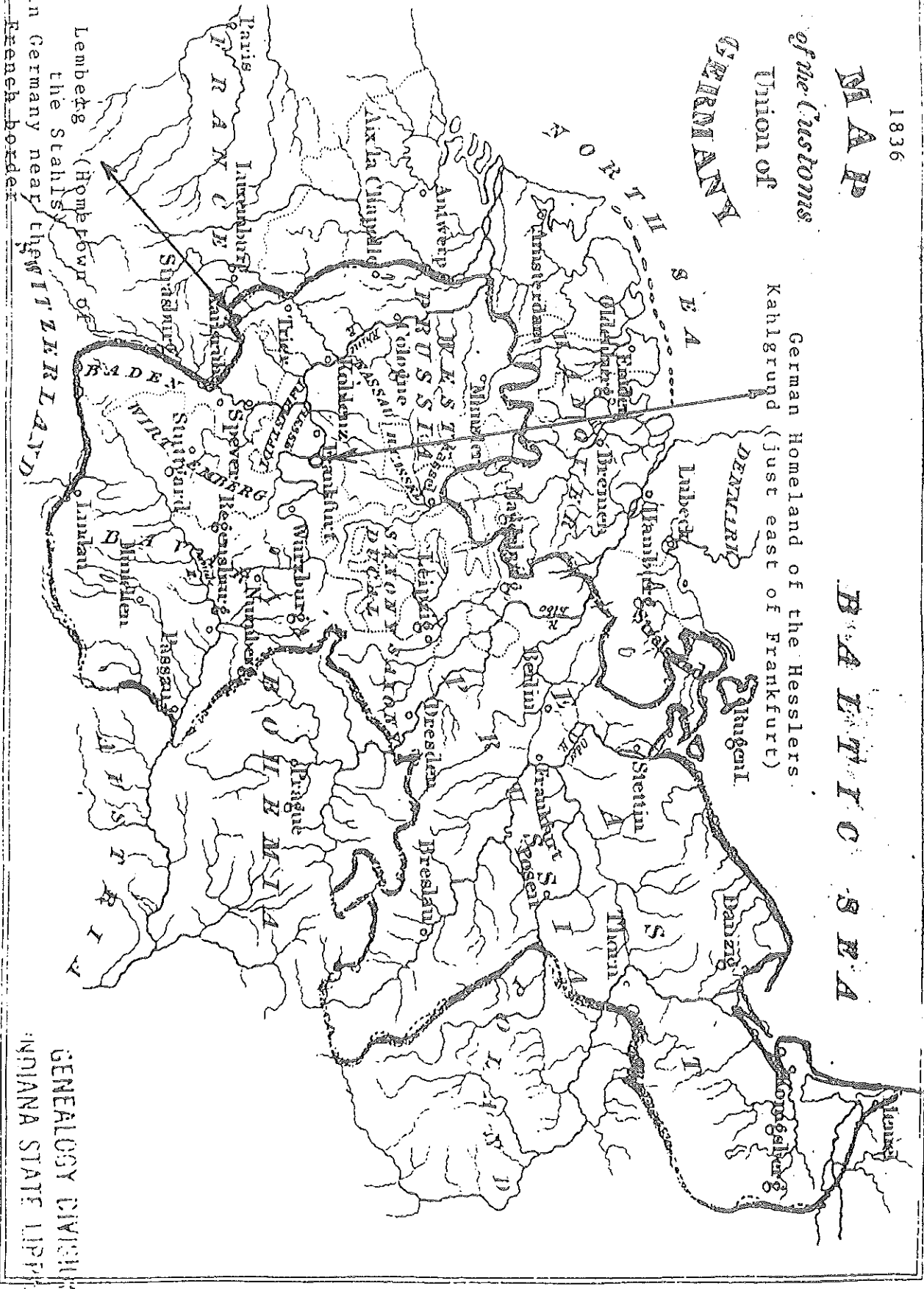

From the *Historical Magazine* Vol. XXXIX to two pages 57

GENEALOGY DIVISION
INDIANA STATE LIBRARY

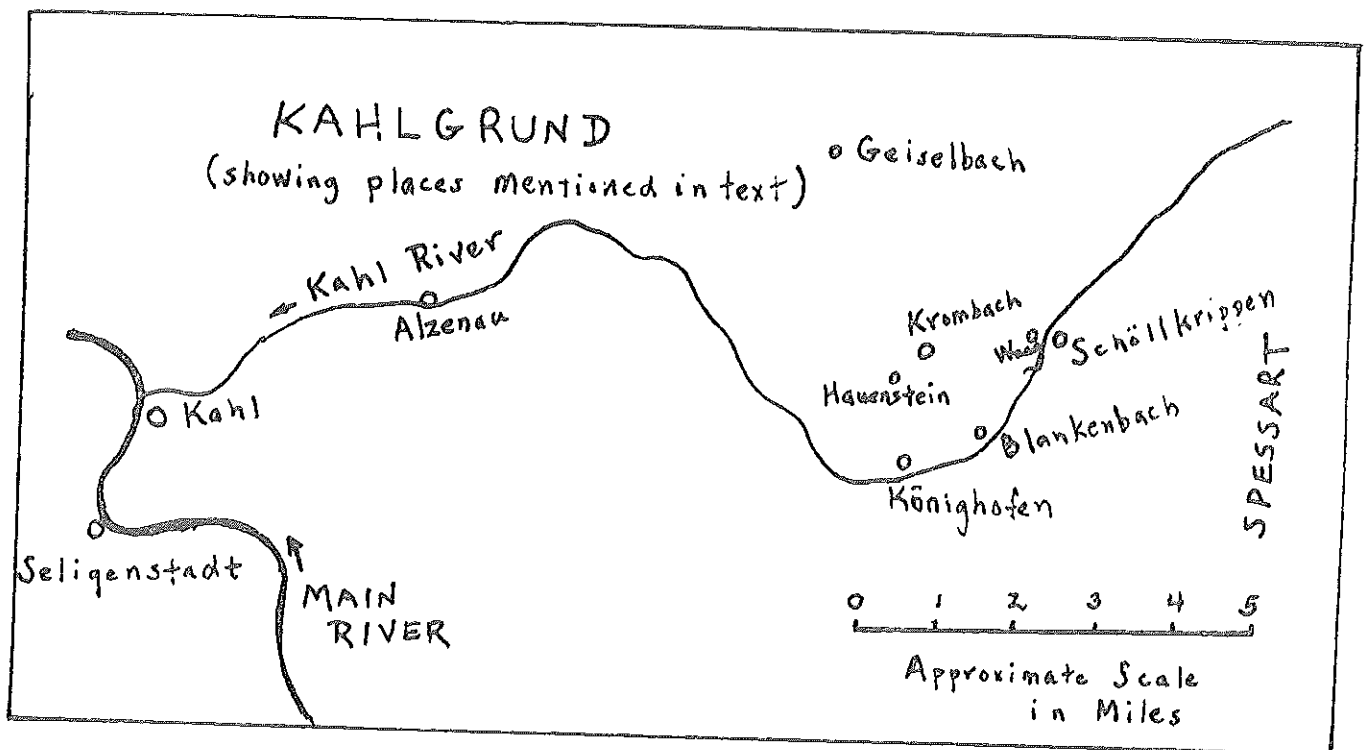
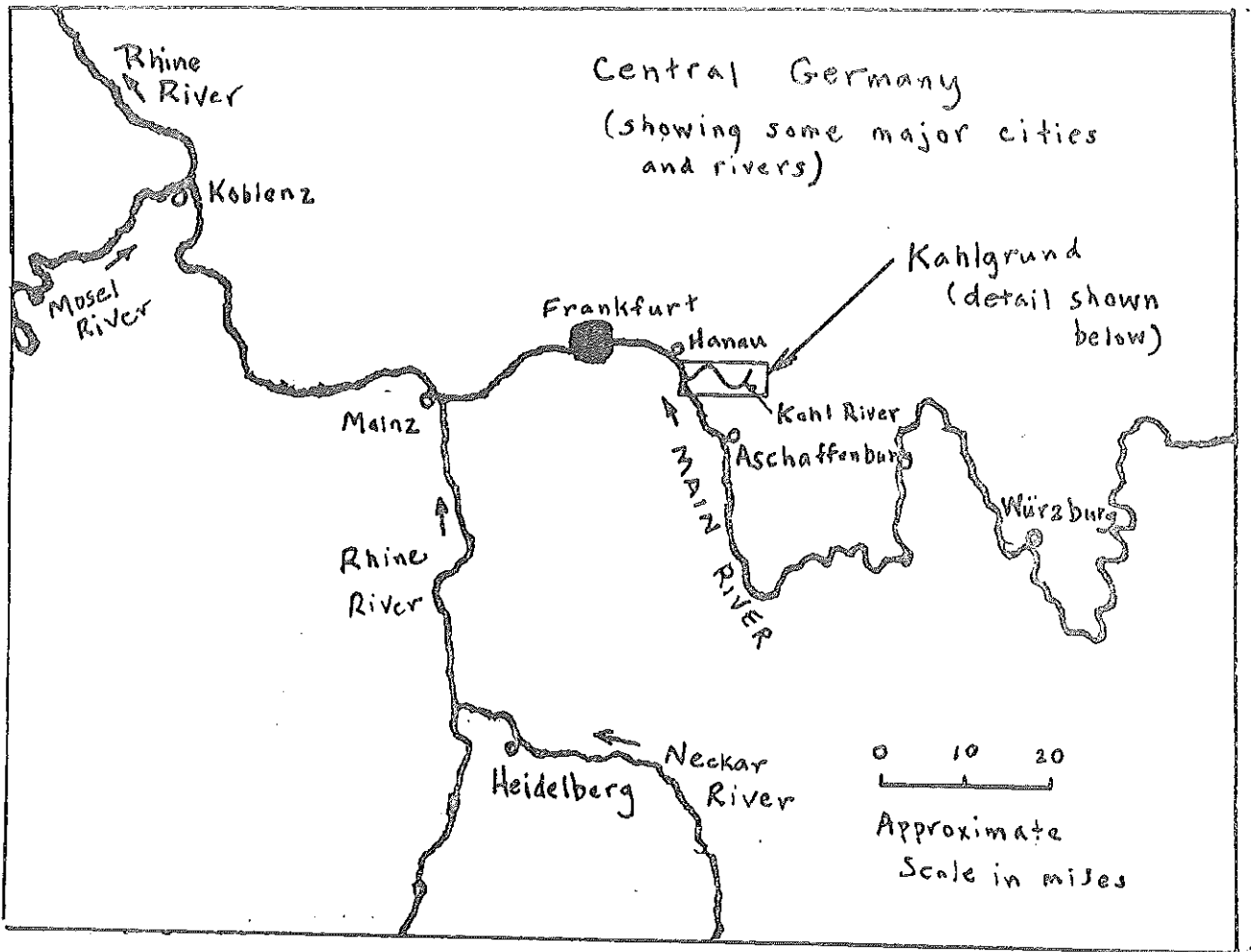

The Catholic parish of Krombach dates from 1269, when it was established by the Archbishop of Mainz and placed under the patronage of the Benedictine Abbey at Seligenstadt. Geiselbach and Krombach were separated politically in 1496, and Krombach was known thereafter as Landgericht Krombach (or Crombach or Cronbach). The political divisions in the Krombach area were very complex in feudal times. For example, Königshofen, a village about one mile south of Krombach, on the Kahl River, was a Hof of the Frankish king, as its name suggests.

The political divisions in the Krombach area reflect the general complexity of political boundaries in Germany. After the breakup of Charlemagne's empire into three separate kingdoms in the late 9th century, the general tendency until perhaps the 18th century was a gradual fragmentation of Germany into smaller and smaller states. Most of central Germany remained a patchwork of small feudal states with scattered landholdings, even after the emergence of several large German kingdoms (such as Prussia in the northeast and Bavaria and Württemberg in the south). It was only in the mid-19th century that a unified Germany began to emerge, due to the efforts of the Prussian chancellor Otto von Bismarck. Finally, in 1871, all of Germany (except for the lands controlled by the Austrian Hapsburgs) was united into a German empire, with the Prussian king as Kaiser Wilhelm I.

The town of Krombach stretches out for a mile or more along the valley in which a small stream, called Krombach, flows. In German, "Bach" means stream or brook. This stream flows south into the Kahl River near the village of Blankenbach, which is about a mile east of Königshofen. The entire area around the town of Krombach is often referred to as the "Kahlgrund" or Kahl valley. The town of Krombach is divided into three parts: Oberkrombach (Upper Krombach) at the northern end, Mittalkrombach (Middle Krombach) in the middle (including the steep hill on which the Catholic Church was built), and Unterkrombach (Lower Krombach) at the southern end.

The main street of Krombach runs north and south. It is called "Hauptstrasse" (Main Street). Most of the houses in Krombach are on either side of that street, but there are also several short side streets leading off from either side of Hauptstrasse. Many of the houses are modern, but there are still quite a few half-timbered ("Fachwerk") houses, with some of these dating back to at least the 18th century. In 1972, the population of Krombach was about 1,500.

For at least a hundred years, and perhaps for over 500 years, our Hessler ancestors lived in Lower Krombach. The land that they farmed probably lay to the west of Lower Krombach, in the direction of Hauenstein, where a ruined fortress is located. All that is left of the old fortress (Alte Burg) are piles of rocks from some of its walls. I was told that there is a tradition that the Hessler name traces its origin to this Alte Burg, but I was unable to find out any more about the Hesslers' connection to the old Hauenstein fortress.

Near the Alte Burg, there is a picturesque farm called Hof Hauenstein, which was owned by Leo Hessler, a distant cousin, when my wife Jane and I visited the area in 1974. The house and barn on Leo's farm date from 1841 and were built together with an enclosed courtyard. Hof Hauenstein looked to me a bit like a fort or castle, especially at its entrance. Near Hof Hauenstein is a small roadside shrine with a cross. Such a shrine, called a "Bildstock" (picture on a post) or "Steinkreuz," (stone cross) is common in the Kahlgrund countryside.

Waag and Schöllkrippen

Before our ancestors came to America, they had moved from Krombach to the neighboring village of Waag about two miles east of Krombach. Our immigrant ancestors had probably lived in Waag, which is now part of the town of Schöllkrippen, since 1801, when Conrad Hessler married Anna Maria Fleckenstein. The Fleckenstein family was from Waag, and the newly-wed couple may have lived in Waag with her parents. Anyway, all Conrad's children seem to have been born in Waag.

The 1832 death record of Conrad Hessler's mother Susanna shows her address as Waag Nr. 28. It seems likely that she was living with her son Conrad when she died. The address Waag Nr. 28 is based on an outdated method of numbering houses in Waag, and that house number now apparently corresponds to Krombacher Strasse Nr. 6. I was told that a family named Fleckenstein lived there in

1974 when we visited the area, but I did not get a chance to talk to them or see the inside of the house. However, I did take several photos of what I think is the house at that address. Even if that is not the house where our ancestors lived, it is probably fairly typical of the houses in Waag in the 1830s. The farmyard adjoining the house at this address is especially interesting, and it may still look much as it did in the 1830s when the Hesslers lived in Waag.

In 1830, there were about 25 houses in Waag, with a total population of 165 people. Another settlement called Hofgut adjoined Waag on the same side of the Kahl River; in 1830, Hofgut had a population of 220. The nearby village of Gasse had about 100 people in 1830. Just across the Kahl River from Waag was the town of Schöllkrippen. The Kahl River is not very wide near Schöllkrippen and looks more like a good-sized creek. The area drained by the Kahl River is called the "Kahlgrund" or "Kahl Valley." In 1830, Schöllkrippen had just over 1,000 people, including the settlements of Waag, Gasse and Hofgut on the west side of the Kahl River.

Schöllkrippen is currently at the end of a small railroad line that runs west to the city of Kahl, where it connects with a main railroad line from Hanau to the city of Aschaffenburg. From those cities, it is possible to travel by rail throughout Germany. In 1974, Jane and I took the train from Frankfurt through Hanau and then to Kahl on the Main River. At Kahl, we transferred to a small commuter train that went to the town of Schöllkrippen. This railroad, which was completed in 1898, was very important to the economy of the area. The town of Schöllkrippen currently has a population of about 3,000 and is a center for tourism in the picturesque forested area known as the "Spessart," just east of Schöllkrippen.

When Jane and I visited this area in 1974, Werner Hessler, a distant cousin, was the assistant mayor of the town of Schöllkrippen. Werner's great-great-great-great grandfather Heinrich Hessler was born on February 1, 1753. Heinrich Hessler was the oldest brother of Johann Hessler, our ancestor, who was born in 1759. I think this means that Werner and my father were fifth cousins. Werner and his wife Erna had a small meat market on the first floor of their house. He also had a fuel oil business. Werner and Erna had two daughters, Isolde and Eva. Werner died about 1982.

Werner and his family were very kind to us. They shared many stories about the Kahlgrund and took us on several tours of local sights, including Hauenstein. Werner showed us his office in the old "Schloss" (castle) in Schöllkrippen, where city offices are now located. We enjoyed a barbecue at Werner's house on August 15th, the feast of the Assumption, which is a public holiday in Bavaria.

Werner also took us to see the church in Krombach, as well as the church in Schöllkrippen, and he showed us the cemetery where some of his ancestors are buried. Space in the cemetery is so limited that it is customary in Krombach (and apparently in much of Germany) to re-use space in the cemetery every generation or so. Except for a few very old markers, which are probably preserved for their historical interest, virtually all the tombstones in the Krombach and Schöllkrippen cemeteries date from the 20th century. Thus, there are no tombstones in Germany for our ancestors.

The Kahlgrund and the History of the Area Around Krombach and Schöllkrippen

The countryside around Krombach and Schöllkrippen generally consists of an undulating plateau, over 1600 feet high in some parts. Winding valleys with narrow grassy floors lie about 500-650 feet below the plateau and break it up into broad ridges. From my visit in 1974, I can say that it is very beautiful country. Forest covers over half the area and dominates the scenery. Magnificent oak and beech forests cover the area in the immediate vicinity of Krombach.

Interestingly, a topographic map of this area shows one stand of hazel trees, just west of Krombach, near a little street in Lower Krombach called Hesslergasse (or Hessler Lane). Since the Hessler name is said to mean "someone who lives near a hazel ('Hasel') bush," it seems quite possible that Hesslers lived in this area, just west of Lower Krombach, from at least about the 13th century, which is when the use of surnames became prevalent in Germany.



Schollkrippen - WAAG address: Waag NR. 28
prob. The house where the Hessler's lived in Germany in the 1800's
residence at the time of Susanna(Scherer)Hessler's death in July 1833.

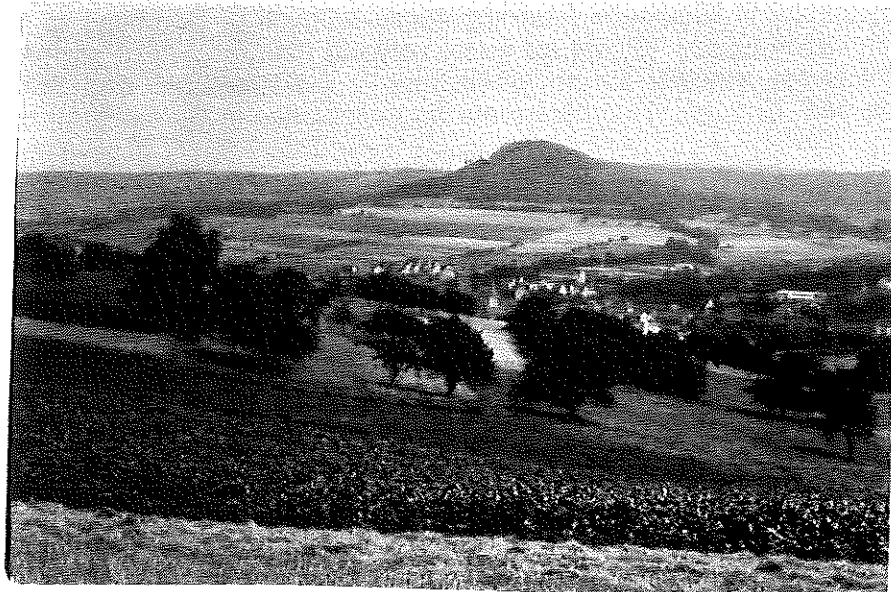

Countryside between KROMBACH and SCHOLLKRIPPEN

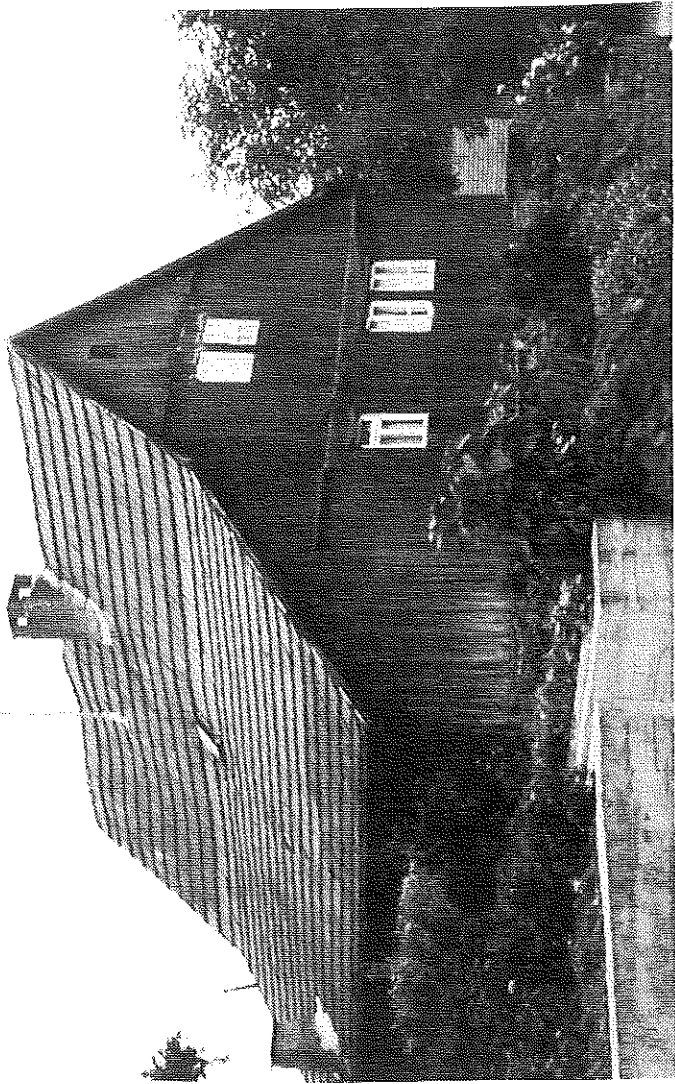

House (as seen from Krombacher Strasse) where Hesslers may have lived in Schöllkrippen-Waag in 1830s (1974)

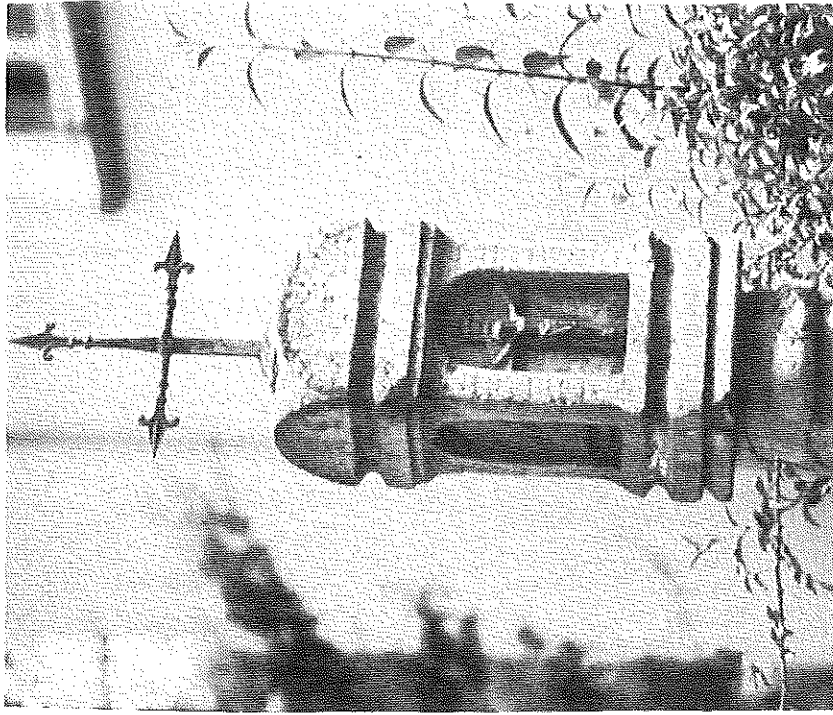

Top of a Bildstock (roadside shrine) in Schöllkrippen-Waag, at T-road where Krombacher Strasse meets Waagstrasse (1974)



Small bridge over the stream called "Krombach" in the town of Krombach (1974)

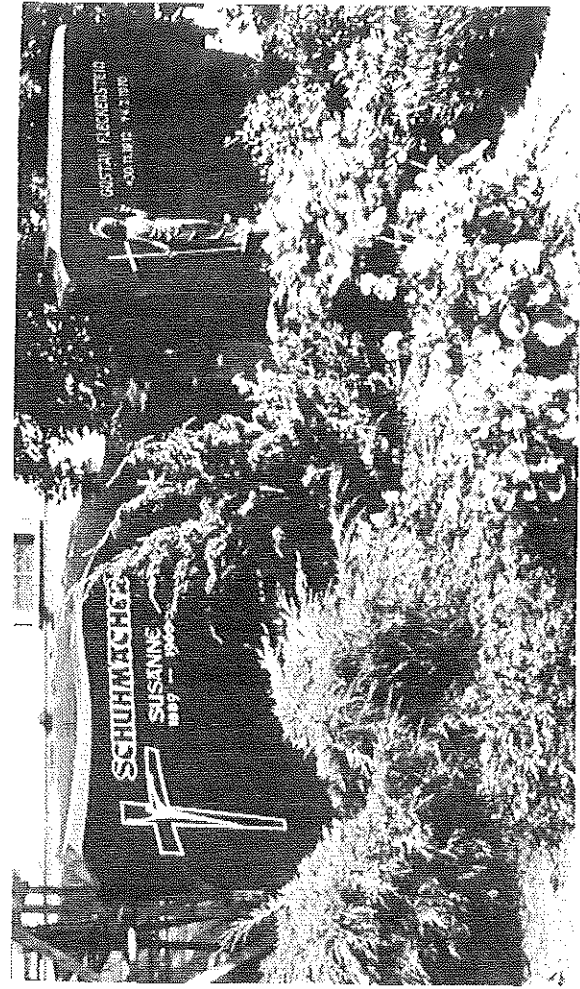

Catholic Church Cemetery in Krombach (1974)

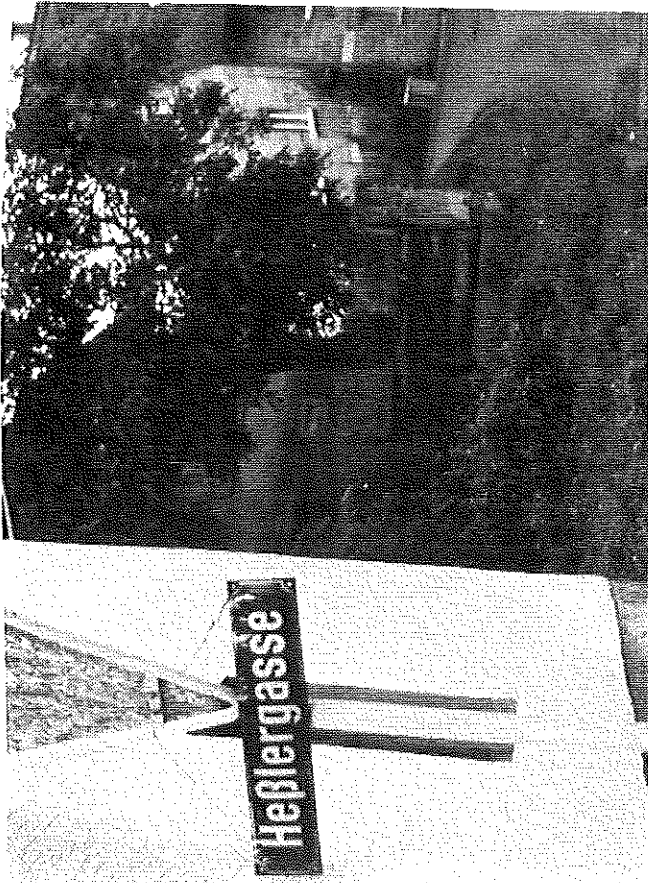

Street sign for Heßlergasse in Lower Krombach (sign belongs on side of house, which was being painted, so it was hung on a stop sign) (1974)

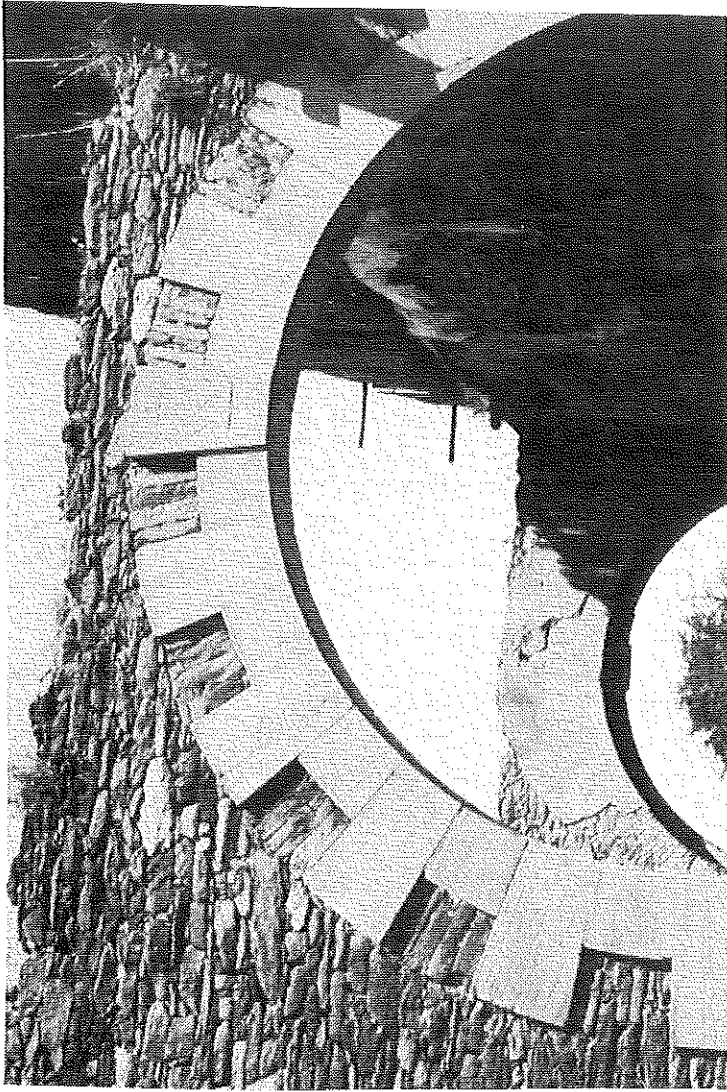

Entrance to Hof Hauenstein near Krombach (an enclosed set of farm buildings) (1974)

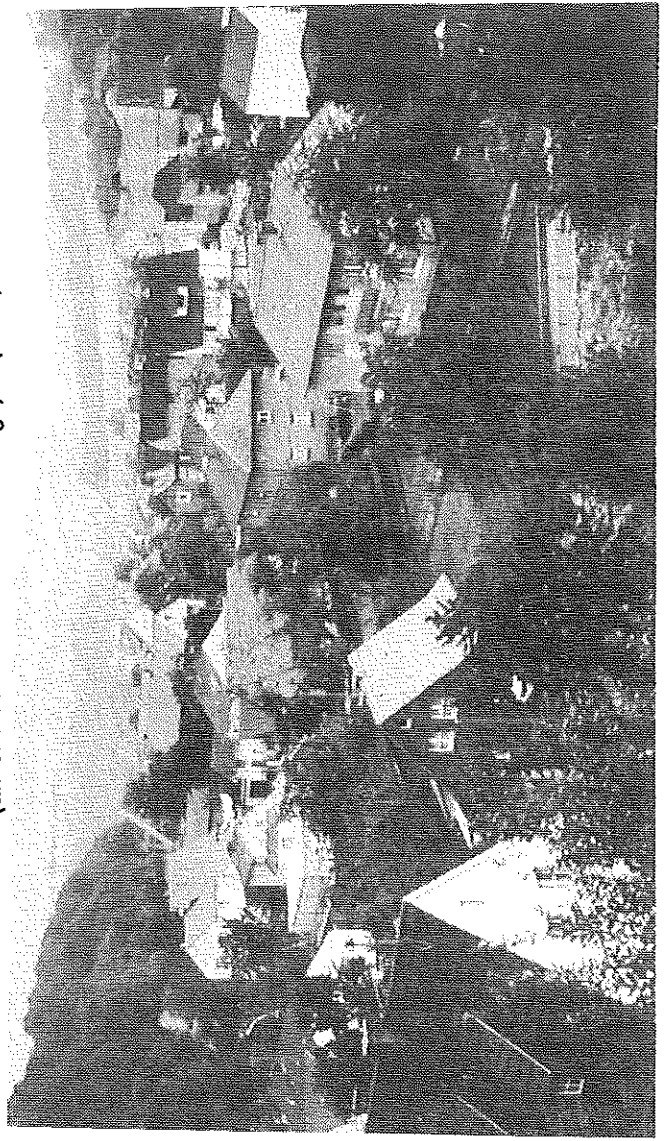

Lower Krombach as seen from hilltop where St. Lambert's Church is located (1974)

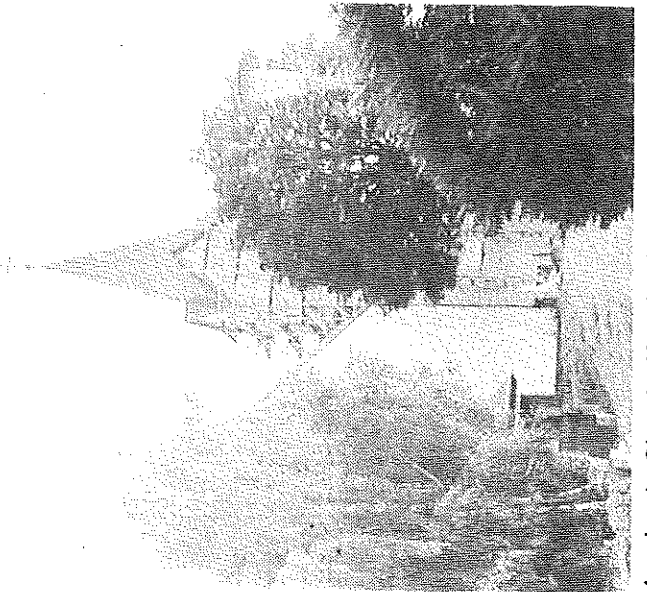

St. Lambert's Church, Krombach (Note: Scaffolding around church tower due to renovation) (1974)

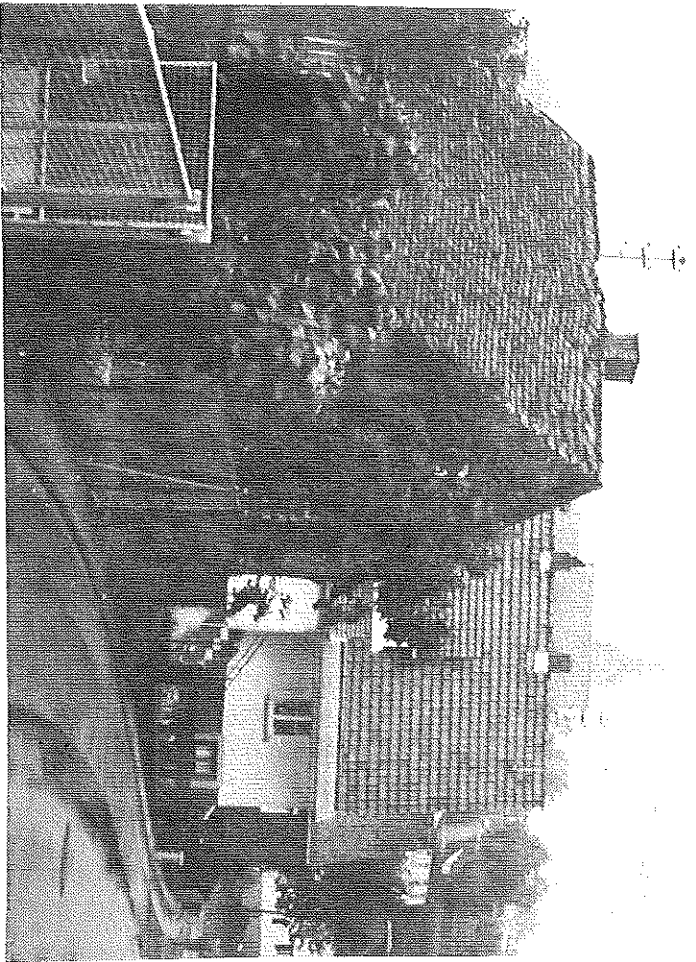

The houses along the west side of Hauptstrasse in Lower Krombach, looking toward the church (1974)

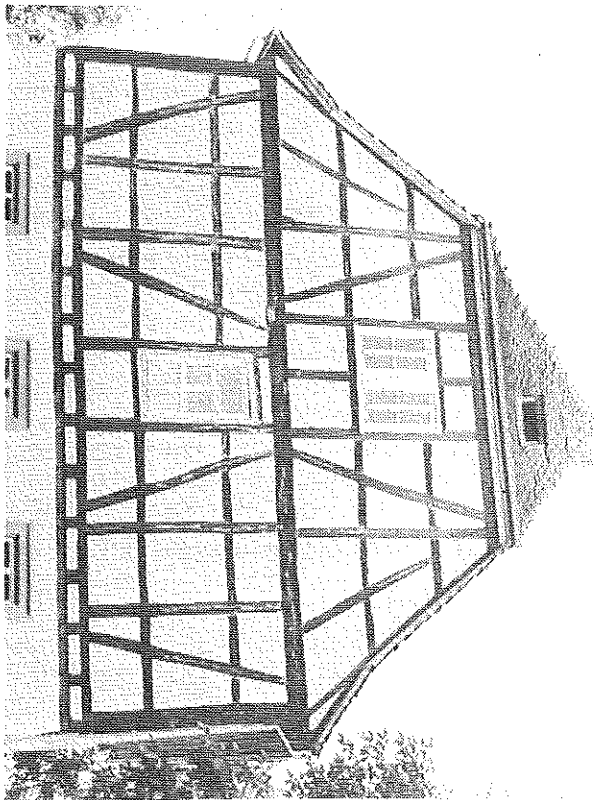

Fachwerk (half-timbered) details on upper stories of Krombach Catholic rectory, where record books are kept

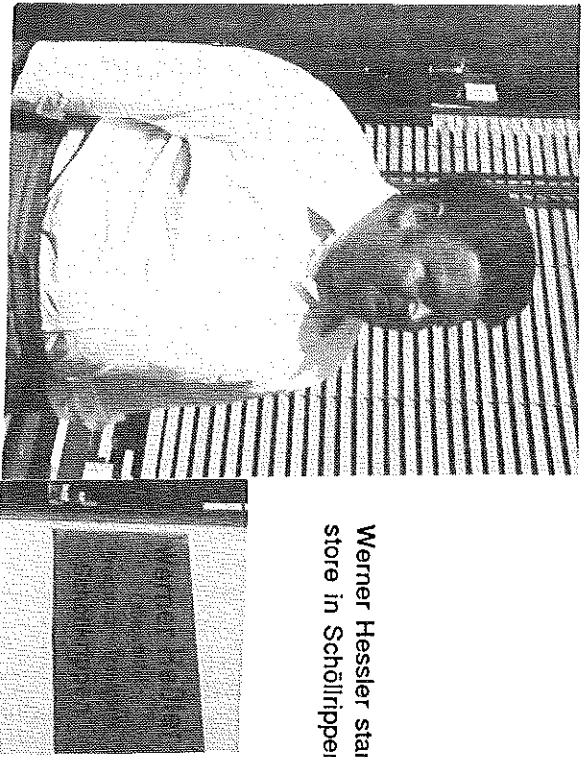

Werner Hessler standing beside his store in Schöllrippen (1974)

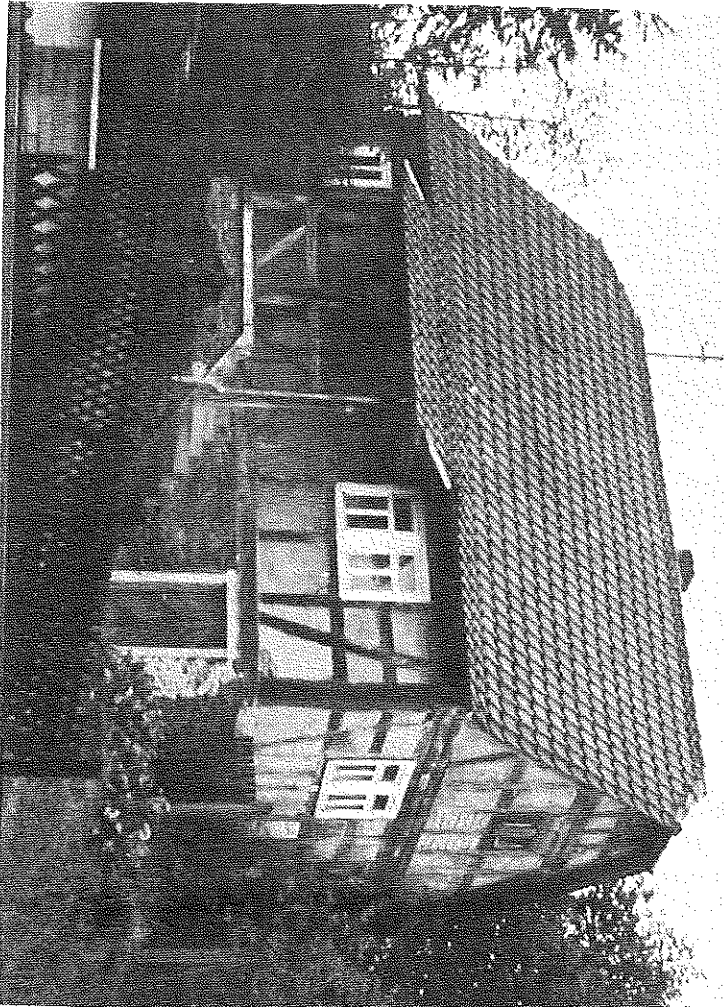

Typical old Fachwerk house in Krombach (1974)

Today, the area east of Schöllkrippen is included in the Naturpark Bayerischer Spessart (or the Bavarian Spessart Nature Park). In Middle High German, the name "Spessart" literally means "woodpeckers' forest." Our Hessler family should be regarded as High Germans ("Hochdeutsch"), which means they spoke the dialect of the Germans who lived in the southern part of the country, which is higher in altitude than the flat plains of north Germany. Most of the immigrants from Germany to America during the 1830s and early 1840s were High Germans. Later, especially in the 1850s and 1860s, the majority of German immigrants were Low Germans ("Plattdeutsch") from northern provinces, like Hannover.

Most of the Spessart is formed of new red sandstone in level strata, as much as 1300 feet thick. This area has been inhabited since prehistoric times. About 200 A.D., there were Roman outposts spread out along the Main River west and south of the Kahlgrund area, and a major Roman settlement at Moguntiacum (Mainz) about 45 miles west of the Spessart. The area around Krombach and Schöllkrippen probably was settled at least as early as the 9th century. However, it was only in the 13th and 14th centuries that settlement spread up the forest valleys to the east of Schöllkrippen. In the 15th-17th centuries, glass furnaces utilized the timber in the forested areas, and many villages originated in the clearings made when the forest was cut to supply the glass furnaces.

The area around Krombach is almost 100% Roman Catholic. The Protestant Reformation of the 1500s had virtually no effect in the immediate area around Krombach. However, Krombach and the surrounding countryside did suffer greatly during the religious war known as the Thirty Years' War, which ravaged Germany from 1618-48. In 1634, the people fled the town of Krombach in order to escape from the German emperor's troops. Most of the town was burned by marauding soldiers, though the church escaped destruction because it was built of stone. The parish priest accompanied his parishioners to the woods and is said to have been killed by wolves. Plague also swept through this area during the war years. The present rectory was built in 1664, after the people returned to Krombach. The current church, which was built in 1744, is a replacement for the church that survived the Thirty Years' War.

As already mentioned, the area around Krombach and other towns drained by the Kahl River is called the "Kahlgrund" in German, which means the Kahl ground or valley. Waag is on the west side of the Kahl River and during the early 19th century, residents of Waag still were part of the Krombach parish. At least until the first bridge over the Kahl was built at Schöllkrippen about 1800, it may often have been easier to walk two miles to church in Krombach than to get across the Kahl River.

The connection between Krombach and Waag can also be traced to the fact that Krombach and Waag generally were controlled by a different feudal noble than the town of Schöllkrippen. In the early 16th century, lords from Geiselbach controlled the Krombach area, while Schöllkrippen and other lands to the east and south were owned by the Hohenstauffen royal family. Later in the 16th century the Rieneck family gained control of the area around Krombach. Ownership of this area passed to the Archbishop of Mainz in 1559, when there was no Rieneck heir. The Groschlag family obtained ownership of the Krombach area about 1609. They sold it to the Schönborn family in 1666.

The villages of Waag and Gasse also belonged to the Graf von Schönborn, the same feudal prince who controlled Krombach. Schöllkrippen and the village of Hofgut, which adjoins Waag and Gasse on the west side of the Kahl River, were part of the church lands directly controlled by the Archbishop of Mainz. Even though several Schönborns became Archbishops of Mainz, the towns of Krombach, Waag and Gasse remained family lands owned by the Schönborn family, rather than church property. The mill in the town of Krombach paid ground rent to the Krombach parish church, while the rest of the town owed feudal dues to the Graf von Schönborn.

During the Napoleonic occupation in the first decade of the 19th century, the Kahlgrund area was governed for the French by Theodor von Dalberg, Archbishop of Mainz, as part of the principality of Aschaffenburg. After 1814, when the French were defeated, the principality of Aschaffenburg was made part of the Kingdom of Bavaria, and this result was confirmed by the peace treaty negotiated in Vienna in 1815. At that time, even though the Krombach area had become part of Bavaria, administrative control of the area was returned to the Schönborn family. In 1817, the Catholic parishes in the Kahlgrund were transferred from the Archdiocese of Mainz to the Archdiocese of Würzburg.

Finally, in 1848, direct administrative control of the area passed from the Schönborn family to the Bavarian government.

Agriculture in the Spessart is not especially productive. Potatoes are the chief crop, though buckwheat, corn and sugar beets also are grown. When I was in Germany, Werner Hessler and his wife Erna told me that periodically the area has experienced mass crop failures. According to Erna, there was such a crop failure in 1837. This may have been one of the main reasons that Conrad Hessler set out with his family in March 1838 for the port of Bremen.

The later history of Krombach and its vicinity did not involve our ancestors, since they had already emigrated to the United States. In 1870-71, the Prussian government under the leadership of Chancellor Bismarck achieved a united Germany under Kaiser Wilhelm I. The final step in that process involved fighting the Franco-Prussian War, in which the Germans defeated the French and annexed the provinces of Alsace and Lorraine that had been part of France since the 1790s. In 1974, when I visited the home of Werner Hessler's sister, Elvira Kilgenstein, I saw a portrait of someone in her or her husband's family in a military uniform at the time of the Franco-Prussian war.

In World War I, when Germany and its allies fought against France, Britain, Russia, and eventually the United States, some of the descendants of the Hessler immigrants fought in the American army, while some of their distant cousins were fighting in the German army. As a result of World War I, the Hesslers and other Americans of German ancestry became more detached from their German cultural heritage. Many schools (including the one at Millhausen, I think) stopped conducting any classes in German. Continuing to speak German at home probably was regarded as unpatriotic. Of course, many of the older generation--such as Grandma Hessler (Catherine Stahl)--continued to speak some German. But in time they died, and the younger generation tended to forget what little German they knew.

In 1941, the United States and Germany were again at war, and again descendants of the Hessler immigrants defended their country against the old country of their ancestors. Among the Hesslers who fought in World War II was my father, Carl August Hessler, who served in the U. S. Army in North Africa, Italy and France. In Germany, Leo Hessler, who owned Hof Hauenstein in 1974, served on the Russian Front and was held as a prisoner of war in Russia until about 1950. Werner Hessler's older brother Helmut, who died in 1972, also served in the German army. Werner told me about his gratefully accepting chocolate from American soldiers in the early days of the Allied occupation in 1945.

By 1974, the area around Krombach and Schöllkrippen had fully recovered from the war years. The local economy seemed healthy, and many German tourists enjoyed spending their holidays in the Kahlgrund countryside.

Other Hessler Families

Before moving on to the story of our Hessler ancestors in their new home near Millhausen, Indiana, I want to include some information about other Hessler immigrants and their families. Hessler is a fairly common name in the Kahlgrund, and in searching through indexes to the passenger lists, I found quite a number of Hesslers who also came to this country. Many of them seem to have been from the Kahlgrund and may be related to us. In fact, I am always on the lookout for information about people named Hessler. Anyone interested in Hessler family history can contact me at 7329 Cape Cod Circle, Indianapolis, Indiana 46250.

Once when I was in the airport in Washington, D. C., I called a couple of Hesslers listed in the telephone book and found one who was interested in genealogy. He had found out a bit about his ancestors and sent me a photo of his immigrant ancestor's tombstone showing a German hometown. By that time, I had visited the Kahlgrund and had several maps of the area. I found a town called "Laufach" (which is more or less the same as the hometown on the tombstone) located about seven miles south of Krombach. I wrote my new Hessler contact with that information, and I think he now knows where his ancestor, Lorenz Hessler, was born. My guess is that we are distantly related to Lorenz.

There were also many Hesslers in other parts of Germany. When I was stationed in Giessen, Germany, with the U. S. Army in 1969-70 (alas, before I knew anything much about my ancestors), Josef Krainhöfner, the German clerk with whom I worked, said there were six Hessler families in the small town of Hungen where he lived. Many Hesslers from elsewhere in Germany also emigrated to the United States. Several Hesslers (or Heslers) were among the so-called Pennsylvania Dutch, who settled mainly in Pennsylvania in the 1700s and who were from Germany, not Holland. They were called "Dutch" because the word "German" is "Deutsch" in German, which sounded like "Dutch" to English-speaking settlers. The Pennsylvania Dutch tended to be Protestant, rather than Catholic. The descendants of most of those earlier Hessler immigrants spell their names with only one "s." In the census indexes, I found several such Hesler families in west central Indiana, especially in Fountain Co.

Obviously, many of the other Hessler families are not related to our family. According to one of those mail-order places that try to sell you a "detailed" history of your family and really only give you some general information, including names listed in telephone books, there were slightly over 1,100 Hessler families in the United States in 1982. I have bits of information on several dozen different Hesslers, but including that type of information does not seem worthwhile to me, when I cannot trace our relationship with those Hesslers. However, I do want to include some information I have gathered about two other Hessler families that do have a relationship with our family.

Conrad Hessler Who Settled in Mt. Healthy, Ohio

Among the 14 immigrants in Conrad Hessler's party on the ship Mathilde was a younger man, also named Conrad Hessler. He was a cousin of my great-great-grandfather Conrad Hessler. The younger Conrad Hessler settled near the town of Mt. Healthy, Ohio, now part of Cincinnati. Conrad Hessler was born in January 1813, according to his tombstone in the Assumption Catholic Cemetery in Mt. Healthy. The Krombach church records show Conrad Hessler, the son of Georg Adam Hessler and Margareta Glaab, was born on January 13, 1813. Conrad's wife was named Anna Mary Hembrock. They had seven children: (1) George, (2) William, (3) Mary, (4) Peter, (5) Adam, (6) John, and (7) Elizabeth. They have a large number of descendants in Ohio, Michigan, Wisconsin, and elsewhere.

I have learned from descendants of Conrad Hessler in Mt. Healthy that this Conrad and several of his descendants were shoemakers. Apparently, that was a family trade since Conrad Hessler and his son John Hessler, who settled in Millhousesen, also were shoemakers. According to family tradition, my great-great grandfather, John Hessler, returned to the Cincinnati area for an extended period at least once or twice, perhaps when times got difficult in the Millhousesen area. According to federal census records, two of his children were born in Ohio, probably near Cincinnati, in 1842 and 1844. Perhaps John Hessler and his family stayed with this Conrad Hessler in Mt. Healthy, while they were in Ohio. John may have gone there to earn some needed cash for his family by working as a shoemaker.

According to a family story, Conrad Hessler, who lived in Mt. Healthy, had as many as five brothers who came to the United States. Some of them may have returned to Germany according to that story. Perhaps Joseph and Henry Hessler, who are shown on the 1850 Ohio census as living in a house with Barney Wanstroth in Cincinnati's 9th Ward, two houses from the Catholic rectory where Father Ferneding lived, were brothers of Conrad Hessler, who lived in Mt. Healthy. In the 1850s, there was a Christian Hessler who lived in the Oldenburg area; he served in Union Army during the Civil War and died of wounds sustained at the Battle of Chickamauga in 1863. Maybe some of these Hesslers are related to our family.

Franz Hessler--Another Immigrant Who Settled in the Millhousesen Area

One of the Mt. Healthy Conrad Hessler's brothers, Franz Hessler, who arrived at Baltimore on July 25, 1840, on the ship Alexander, did settle in the Millhousesen area. His future wife, Magdalena Rosenberger, came to America on the same ship, and they were probably married in Cincinnati.

Franz Hessler was born on March 12, 1812, in Krombach. He was the oldest child of Georg Adam Hessler and Margareta Glaab. According to Father Bretz's research in the Krombach church records, Franz's grandfather was named Philip Hessler. When I was in Krombach, I found the record of Johann Philip Hessler, who was baptized on October 20, 1757, and whose parents were Andreas and Anna Maria Hessler. Johann Philip was an older brother of our ancestor Johann Hessler, born in 1759. That means Franz Hessler and my great-great grandfather John Hessler were second cousins.

Franz Hessler settled near Millhousen, and it is Franz Hessler's descendants who are the other Hesslers in the Greensburg area. Franz owned a 40-acre farm in Jackson Township, Ripley County, in section 32, near Goose Creek. His son Adam Hessler was sometimes called "Goose Adam" to distinguish him from the other Adam Hesslers in the Millhousen area. It must have been difficult in late 19th century Millhousen to keep straight all of the Hesslers named Adam or John.

Franz and his wife Magdalena Hessler had eight children: (1) Adam, (2) Conrad, (3) Frank, (4) Margaret, (5) Catherine, (6) Elizabeth, (7) Anna Mary, and (8) Eva. Franz Hessler died on March 27, 1894. His wife Magdalena Rosenberger had died earlier, on October 4, 1880. They are buried in St. Mary's Cemetery in Greensburg.

Adam Hessler, Franz's oldest child, was baptized at Millhousen by Father Schniederjans on November 1, 1841. Adam had three wives and at least nine children. He married the first one, Elizabeth Macke, on October 9, 1877. She died of consumption in March 1880. Adam then married Mary Hoffe (Huff) on June 16, 1881, with the wedding performed by Father Pepersack at Millhousen. They had three children: (1) Jacob, (2) Henry, and (3) Ida, but the marriage ended in divorce about 1884, perhaps even before Ida was born. Mary died about 1890, leaving a small estate for her children to be managed by their father. Because Adam had been divorced, his third marriage to Elizabeth Stuart on October 30, 1884, was not in the Catholic Church, and their children were not raised as Catholics, though some were baptized. Adam's third marriage also ended in divorce, and the six children of Adam and Elizabeth were split up. Adam and Elizabeth's six children were: (1) Franklin, (2) Ethel May, (3) Melinda, (4) Adam Frederick, (5) Celia (Ceolia), and (6) James Allen. Their father, Adam Hessler, died on July 10, 1923.

Conrad Hessler, Franz's second son, was born in early October 1842, and was baptized in Millhousen, Indiana, on November 25, 1842, with Conrad Osthelmer and Margaretha Steigerwald (both of whom likely came from the Kahlgrund like the Hesslers) serving as his godparents. Conrad Hessler never married. In 1903, he deeded to the Catholic bishop of Indianapolis two adjoining lots next to the church property in Greensburg. Conrad lived at St. Francis Hospital in Cincinnati, which probably operated like a retirement or nursing home, from about 1909 until his death about 1921.

Franz's third son, Frank Hessler, was born on January 19, 1844, near Millhousen. Frank served in Co. A, 68th Indiana Infantry, during the Civil War. He married Mary Steppau in the Catholic Church at Newport, Kentucky, on September 24, 1867. Frank and his family moved to Coffey County, Kansas, about 1870. Franz and his wife had six children: (1) William, (2) Catherine, (3) John, (4) Joseph, (5) Maude, and (6) Rosie. Franz died near Burlington, Kansas, on May 1, 1923.

In addition to three sons, Franz and Magdalena Hessler had five daughters: (1) Margaret, born about 1846; (2) Catherine, born about 1847; (3) Elizabeth, born about 1849; (4) Anna Mary, born in 1851; and (5) Eva, born about 1852. I only have further information on the youngest two. Eva married Joseph Dannacher on June 24, 1875, in Greensburg. Joe Dannacher had two children by a prior marriage, named Catherine and Joseph. He and Eva had a daughter Carrie born in June 1877. Eva Hessler died on November 28, 1877. Joe Dannacher then married Eva's older sister Anna Mary. Joe and Anna Mary Dannacher had four children: (1) Lena, (2) Oliver, (3) Edward, and (4) George.

I attended high school in Greensburg with Linda Hessler (now Mrs. Charles Greiwe). At the time, I always assumed that my family was not related to Linda's or any of the other Hesslers listed in the Greensburg telephone directory, except for my father's first cousin, Francis Hessler, who then lived in Millhousen. However, it is now clear that the other Hesslers in the vicinity of Greensburg are the descendants of Franz Hessler and are our distant cousins. Linda's grandfather was Jacob Hessler, the oldest child of Franz's oldest son Adam. That means that Linda and I are sixth cousins.

GENEALOGY OF THE GERMAN HESSLERS

By Charles A. Hessler

The Krombach Catholic church records contain much information about our Hessler ancestors. Continuous church records only date from 1715 in Krombach. In addition, the first church register contains a few sporadic entries dating back as far as 1669. Unfortunately, this earliest book contains no marriage, birth or death records for any Hessler. However, the church records that begin in 1715 contain hundreds of such Hessler entries. Sorting out the various Hessler families is rather difficult. It seems that there were at least three different Hessler families living in the Krombach area about 1715. The heads of these families were named Adam, Nicholas, and Johann Adam.

It seems almost certain that Adam was our direct ancestor, but the church records contain no information about who Adam's parents were or how he was related to Nicholas and Johann Adam Hessler. Here is our family tree beginning with Adam Hessler:

- I. ADAM HESSLER (1680?-1725?). His widow Margretha died in Krombach in 1729.
- II. JOHANN HESSLER (1700?-1742), son of Adam Hessler, died in Lower Krombach. He married Anna Barbara Jung, the daughter of Heinrich Jung, in 1722.
- III. ANDREAS HESSLER (1730?-1759), son of Johann Hessler, died in Lower Krombach. He married Maria Hornick, the daughter of Johann Hornick of Hauenstein, in 1752. Children: (1) Heinrich, (2) Johann Philip, and (3) Johann (and perhaps others).
- IV. JOHANN HESSLER (1759-1825), son of Andreas and Maria Hessler, born in Lower Krombach; died in Waag. He married Susanna Scherer, the daughter of Johann Michael Scherer of Lower Krombach, in 1780.
- V. KONRAD HESSLER (1781-1842), son of Johann and Susanna Hessler, born in Lower Krombach; died in Jennings County, near Millhousen, Indiana. He married Anna Maria Fleckenstein, the daughter of Johann Fleckenstein, in 1801. They raised their children in Waag before emigrating to the United States. Children: (1) Johann, (2) Adam Johann, (3) Anna Margareta, (4) Margareta (died at birth in 1814), and (5) Maria Anna.
- VI. JOHANN HESSLER (1804-1873), born in Waag; died in Millhousen. He married Anna Maria Nees, the daughter of Kaspar Nees of Lower Krombach, in 1832. Their two oldest children (Eva and Johann) were born in Waag. They had five more children in the U. S. (Adam John, John, Margaret, Anna Mary, and Gerhard).
- VII. ADAM JOHN HESSLER (1840-1903), born and died in Millhousen, Indiana. He married Catherine Stahl, the daughter of Jacob Stahl who lived in the vicinity of Napoleon, Indiana. They had eight children: (1) Mary, (2) John, (3) Francis, (4) George, (5) Adam, (6) Gerhard, (7) Henry, and (8) Andrew.

Extract from Krombach Parish Records

The record books at St. Lambert's Church in Krombach contain a wealth of information about the Hessler family. Here is an extract of what I found to be the most interesting entries, together with some notes that I have added:

- | | |
|------------------|--|
| February 3, 1722 | Johann Hessler, son of Adam Hessler of Krombach, married Anna Barbara Jung, daughter of Heinrich Jung of Lower Krombach. |
| July 8, 1729 | Burial of Margretha Hessler, widow of Adam Hessler. |

- January 27, 1742 Burial of Johann Hessler, an inhabitant of Lower Krombach. He received the last rites of the Church.
- February 8, 1752 Andreas Hessler, son of Johann Hessler of Lower Krombach, married Maria Hornick, daughter of Johann Hornick of Hauenstein. Witnesses: Johann Mayer from Krombach and Georg Adam Wiesel from Dornsteinbach.
- February 1, 1753 Baptism of Heinrich Hessler, son of Andreas and Maria Hessler. (This was an ancestor of Werner Hessler; his descendants still live in Germany.)
- October 20, 1757 Baptism of Johann Phillip Hessler, son of Andreas and Maria Hessler. (This was an ancestor of Franz Hessler, who settled in the Millhousen area.)
- October 20, 1759 Baptism of Johann Hessler, son of Andreas and Maria Hessler. Sponsor: Johann Mayer. (This was an ancestor of Johann Hessler, born in 1804, who settled in the Millhousen area.)
- November 10, 1759 Burial of Andreas Hessler from Lower Krombach. (Note: If, as seems likely, this is the father of Johann Hessler, who was born on October 20th, Andreas left a son less than a month old when he died.)
- February 9, 1764 Baptism of Susanna Scherer, daughter of Johann Michael Scherer. Sponsor: Susanna Mayer.
- January 31, 1780 Johann Hessler from Krombach and Susanna Scherer were married. (These are the paternal grandparents of my great-great grandfather Johann Hessler who was born in 1804.)
- October 1, 1781 Baptism of Konrad Hessler, son of Johann Hessler of Krombach and his wife Susanna.
- September 22, 1801 Konrad Hessler, son of Johann Hessler, married Anna Maria Fleckenstein, daughter of Johann Fleckenstein from Waag.
- February 4, 1804 Birth and baptism (on the same day) of Johann Hessler, son of Konrad Hessler and Anna Maria Fleckenstein from Waag. Sponsors: Peter Huth and Anna Maria Noellin from Waag.
- April 25, 1825 Johann Hessler, farmer from Waag, died in the morning at 4 o'clock, aged 65 years. He was called "Huppen-Hannes." (His nickname, which I think means Hopping Hans or Hopping John, may indicate that he limped.)
- July 24, 1832 Johann Hessler, son of Konrad, married Anna Maria Nees, daughter of Kaspar Nees and his wife Anna Maria.
- June 27, 1833 Baptism of Eva Hessler, daughter of Johann and Anna Maria Hessler. The baptism was performed by Father Ziegler, a Benedictine from the monastery at Seligenstadt. (I was told that Father Ziegler was the last Benedictine from Seligenstadt to serve the Krombach parish.)
- July 1, 1833 Susanna Hessler, farmer's wife, Waag Nr. 28, widow, died at 3 o'clock in the morning, aged 70 years. (This was the great grandmother of Eva Hessler who was baptized four days earlier.)
- August 31, 1835 Baptism of Johann Hessler, son of Johann and Anna Maria Hessler. (This is "Big John.")

EARLY DAYS OF THE HESSLER FAMILY IN MILLHOUSEN

By Charles A. Hessler

Conrad Hessler and his family probably set out for Cincinnati within a few days of their arrival in Baltimore, on September 21, 1838. They probably spent most of the winter of 1838-39 in Cincinnati. On March 12, 1839, Conrad and his son John Hessler bought 89 acres of land in section 29, just south of what was to become the town of Millhousen, Indiana. They presumably had brought at least several hundred dollars in cash with them from Cincinnati, since they paid \$300 for this land, and I have found no record of any mortgage.

In addition to providing some information I have gathered about the Hesslers in Millhousen during the 19th century, this section will tell you a little about some of our other relatives in the Millhousen area. As my father used to try to explain to me, we have relatives named Schneider, Link, Redelman, Brandewiede, Pfeifer, Menkedick, Vanderpohl, and Stahl. You have to go back to 19th century records to trace those relatives and their connections with the Hessler family.

Local tradition refers to thirteen pioneer families who settled the town of Millhousen. One story refers to them as traveling together from Cincinnati and having to hack their way through the underbrush from the town of Napoleon to the vicinity of Millhousen. Even the road from Cincinnati to Napoleon was probably little more than a well-worn dirt path in some places. This trip probably occurred during the winter of 1838-39, with Maximilian Schneider leading this group of families.

Father Joseph Ferneding, who is regarded as the founder of several early German Catholic parishes in southeastern Indiana, may have helped to organize the group which made this trip with Schneider, who traditionally is regarded as the founder of Millhousen. Blasius Gigos, who owned land in section 19 as early as July 1836 and who was later a merchant in Napoleon, also probably played a role in the early history of Millhousen. Franz Anton Hartmann, who was probably the brother-in-law of Blasius Gigos, also arrived in the area in July 1836, and Hartmann is included in the list of thirteen Millhousen pioneers. Perhaps it was in recognition of the role of Blasius Gigos and Franz Anton Hartmann in settling the Millhousen area that Maximilian Schneider chose the name Millhousen for the new town he founded. The large city of Mulhouse (Mühlhausen, in German) in Alsace, which was part of France in the 1830s, was very near Blasius Gigos's home village of Altkirch.

In any event, both John Hessler and his brother Adam are included among the traditional listing of the thirteen Millhousen pioneers. However, Adam Hessler only arrived in the U. S. in 1841, to join his father and his other relatives who had arrived in 1838, so it is clear that not all these thirteen families arrived in Millhousen at the same time. The omission of Conrad Hessler and some members of the older generation from the list of pioneer families probably is due to the fact that the older generation had died by the time that people started compiling a list of early settlers.

Any attempt to date the history of the Millhousen Catholic parish from 1834, which is the traditional date for its founding, seems rather uncertain. Most likely the first Mass at Millhousen was celebrated in 1838 or 1839. As already mentioned, there were a few German Catholic families (like Gigos and Hartmann) who settled in the Millhousen area before settlers like the Hesslers arrived in early 1839. Thus, an earlier date for the first Mass at Millhousen is possible. The earliest German Catholic in this area whom I have found is Franz Vietor, who bought land in section 30 in May 1835.

The earliest entries in the Millhousen church records only date from March 1840. Conrad's grandson, Adam John Hessler, was one of the first three baptisms in the Millhousen church records, which all occurred on March 17, 1840. His godparents were Anna Maria Hessler (probably his grandmother) and John Adam Bedel. Nothing more is known about John Adam Bedel, but he may have been from the Kahlgrund.

The map of the Millhousen area on the next page can be used to see where our relatives lived in Marion Township, Decatur Co.; Jackson Township, Ripley Co.; and Columbia Township, Jennings Co.

Conrad Hessler--Immigrant Patriarch

When the 1840 Federal census was taken, Conrad and his wife Anna Maria Fleckenstein were living in Decatur County in the household of their son John (or Johann) Hessler, who was born in the village of Waag in the Kahlgrund in 1804. The federal census in 1840 only listed the name of the head of the household with the approximate age and sex of others living in the same house. Another piece of information about Conrad Hessler found in the public records is his stock mark, which was recorded in Decatur County on November 6, 1839. Conrad's stock mark was "a smooth crop off the right ear and a half crop off of the left." Stock marks were necessary because there were few fences and livestock roamed freely most of the time.

About 1841, Conrad and his wife probably moved to live with their daughter and her husband Adam Schneider, who lived in Columbia Township, in Jennings County, near Millhousen. Part of the reason for the move may have been a warrant that was issued by the Decatur County Sheriff for the arrest of Conrad Hessler. The charge was retailing, which meant that Conrad was accused of selling liquor without a license. It is also possible that the move to Jennings County occurred after the death of Conrad's wife. There is no record of the death of his wife Anna Maria, but since she is not mentioned in Conrad's will, it seems likely that she predeceased him, perhaps dying in 1841 or early 1842.

Conrad's will is recorded in the Clerk's office in Jennings County in volume 1, pages 9-10. It was admitted to probate in December 1842, which establishes the approximate date of his death. There is no record of his death in the Millhousen parish burial records. At that time, there was no resident priest, so burial probably occurred without the presence of a priest. Here is a transcript of Conrad Hessler's will, with some punctuation added for ease of reading:

I, Conrad Hesler of Jennings County, State of Indiana, do make and publish this my last will and testament hereby revoking and making void all former wills by me at any time heretofore made. First, I direct that my body be decently interred and that my funeral be conducted in a manner corresponding with my estate and situation in life and as to such worldly estate as it has pleased God to entrust me with I dispose of the same in the following manner to wit: I direct first that all just debts and funeral expenses be paid as soon after my decease as possible out of the first monies that shall come to the hands of my Executor from any portion of my estate. I also give and bequeath to my daughter Margaret who has intermarried with Adam Snider my half of the wagon owned by me and said Snider, also my half of our common stove, one sorrel mare, eight hogs, and one half of my beds and bedding and four cider barrels and one mattock and one weeding hoe. I also give and bequeath to my granddaughter Margaret Hessler, a step daughter of Francis Link, fifty dollars in cash and one half of my beds and bedding provided she shall live to years of maturity and the remainder of my estate is to be equally divided between Adam Snider, my son-in-law; Francis Link, my son-in-law; and Adam Hesler and John Hesler, my two sons; said residue to be divided by two respectable neighbors, and I hereby make and ordain my worthy and esteemed friend Adam Snider Executor of this my last will and testament.

The list of Conrad's personal property, including a sorrel mare, a wagon, a stove, a mattock (which is a pickax-like grubbing tool), and a weeding hoe, is fascinating. Interestingly, the will leaves a residual share for each of his sons-in-law, instead of leaving a share directly to his daughters, Margaret Schneider and Mary Link.

Unfortunately, the original of Conrad's will has not survived. All that I found in the courthouse records at Vernon, Indiana, was the transcription of the will copied in the Will Record by the County Clerk. As was the case with most early county records involving the Hesslers, the family name is shown with only one "s." This may have been due to the language barrier that separated our ancestors from their English-speaking neighbors. It may also reflect an effort by county employees to transcribe German script that uses a single letter "ß" where a double "s" is used in English. Our ancestors probably learned to read and write a little in the elementary school at Krombach. Here are copies of the German script signatures of "Konrad Heßler" in 1839 and his son "Johann Heßler" in 1849:

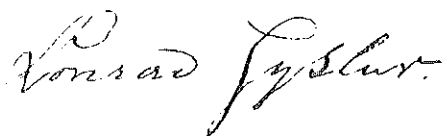

Now, I want to tell something about each of Conrad's four adult children who settled near Millhousen, plus a little about a few other 19th century Hesslers. Before that, I will mention that Conrad and his wife Anna Maria had a fifth child, Margareta, who was born in Waag on January 22, 1814, and died in infancy, probably at birth.

Family of John Hessler (1804-1873)

Conrad Hessler's oldest child, my great-great grandfather John Hessler, married Anna Maria Nees, the daughter of Kaspar and Anna Maria Nees on July 24, 1832, at St. Lambert's Church in Krombach. John and his wife Anna Maria had seven children: (1) Eva, (2) John, (3) Adam John, (4) John, (5) Margaret, (6) Anna Mary, and (7) Gerhard. John Hessler died on June 21, 1873. Anna Maria (Nees) Hessler died on November 22, 1880. Her tombstone is in the Millhousen cemetery.

According to the family history book that Mary Dwenger showed me, John Hessler's wife was named Anna Maria Neese, which is very close to the spelling of her name in the Krombach church records that show her name as "Nees." However, the church records at Millhousen contain three other spellings for her name. The baptismal record of Adam John Hessler in March 1840 shows his mother's name as "Anna Maria Nehring." The church census of 1860 shows her name as "Anna Maria Noessen," while the 1865 marriage record of her son Adam John shows her last name as "Näsin." All this is a bit confusing, until you know that the German word ending "-in" refers to a female, so "Nees" could easily become "Noessen," "Näsin," or even "Nehring" to refer to a woman named Nees. The spelling differences between German and English names often cause some confusion. For example, in American records, Conrad's name is spelled with a "C"; in German records it is usually "Konrad."

John and Anna Maria Hessler's oldest child, Eva, was born on June 27, 1833, in Waag. She died at the age of 16 and was buried in St. Boniface cemetery at Millhousen on July 16, 1849, just a week before her aunt and uncle died of cholera. Eva is not listed on the 1850 mortality schedule compiled in connection with the federal census, even though her aunt and uncle are listed. We can only guess about the cause of her death, but it seems quite possible that Eva also died of cholera.

John and Anna Maria Hessler's next child, John Hessler, was born on August 31, 1835, in Waag. He was later known as "Big John" to distinguish him from his younger brother born in 1842, who was also named John. Big John's first wife Catherine Wissel died in childbirth with her thirteenth child on July 13, 1877; according to her tombstone in the Millhousen cemetery she was 35 years old, so she was born about 1842. Big John remarried about 1880 and had two more children by his second wife Louise Dickman Kemper. He and his family are listed on the 1880 census in Hamilton Co., Ohio. Big John died on November 24, 1890, in Pesotum, Illinois, about 15 miles south of Champaign-Urbana.

Big John's children were: (1) John Joseph (Joe), born November 7, 1860; married Clara Miller; two children (Louise and John Joseph); died in St. Louis on June 20, 1905, (2) Mary, born in January 1862, died in infancy on January 16, 1862; (3) Mary Anna, born late 1862; married George Jesel; died young, without children; (4) John Francis (Frank), born June 1864; wife Bridget; four children (Charles, John, William, and Walter); died in Sylvania, Ohio, on May 13, 1937; (5) Anthony (Tony), born April 2, 1866; married his step-sister Lilly Kemper; three children (Sylvester, Curtis, and Robert); died in San Diego on February 25, 1939; (6) Mary Caroline, born December 21, 1868; married Harry Boelock; three children (including Harry and Viola); died December 22, 1898; (7) John William, born October 20, 1869; married Dorothy Bengé; three children (Earl, Grace, Pearl); died in Spokane, Washington, on March 29, 1941; (8) Harry (no further information); (9) name and date unknown; (10) name and date unknown; (11) Louis, born February 5, 1874; married Alice Love Green; no children; died in Longmont, Colorado, on May 1, 1973; (12) Bernard Gregory (Barney), born December 16, 1875; married Elizabeth Clementz; three children (Mae Mary Catherine, Rosa Maria, and Alice Ethel); died in Urbana, Illinois, on December 2, 1937; (13) Ruth Katherine, born July 13, 1877; first married to George Lawrence Waid, who died in Reardon, Washington, on May 27, 1931; seven children (Thelma, Mildred, Everett, Wilbur, Pauline, Gladys, and Ethel); divorced; then married William Philip Snyder on June 29,

1912; three more children (Anna Eleanor, Wilmer Arthur, and Catherine Elizabeth); Ruth died in Warsaw, Indiana, on February 13, 1968; (14) Fanny Agnes, born July 22, 1881; married William Buettner; died in St. Louis on January 21, 1946; (15) Mae (no further information).

Big John has many descendants located throughout the United States. One of his granddaughters, Mildred Waid Lamb (whose mother was Ruth Katherine Hessler and who now lives in Scottsdale, Arizona), has assembled details on his family history. Another granddaughter, Alice Hessler (the daughter of Barney Hessler) is now Sister Gretchen, a Dominican nun, who taught German at Rosary College near Chicago for many years and is now retired. I shared the results of my German research with Sister Gretchen, and she visited Krombach about 1978.

According to a family story, Big John set off to the Cincinnati area to find a wife. After a few weeks, he returned and asked his brother Adam to drive a wagon to bring back some things from his new wife's family. Adam brought back furniture, carpets, feather beds and bedding, and a cow. Supposedly, Adam said, "I got this much; if he doesn't get the girl, it's his own fault." Anyway, Big John got the girl; he married Catherine Wissel on January 31, 1860.

Adam John Hessler (the third child of John Hessler and Anna Maria Nees), who was born at Millhousen on February 17, 1840, married Catherine Stahl (the daughter of Jacob and Catherine (Greiner) Stahl) on November 21, 1865. Catherine was born in Lemberg, Germany on February 5, 1846, according to records found in Germany; her tombstone shows a birth date of February 6, 1845. Adam and Catherine Hessler had eight children: (1) Mary (Menkedick), (2) John, (3) Francis, (4) George, (5) Adam, (6) Gerhard, (7) Henry, and (8) Andrew. Two died in infancy: their second child, John, was born on October 8, 1868, and died of typhoid fever on March 21, 1870; and their seventh child, Henry, was born on September 17, 1878, and died of croup on January 14, 1879. Their other six children lived to maturity, married, and raised their families in the Millhousen area. Adam John Hessler died on March 7, 1903.

I am sure that the descendants of my great grandfather Adam John Hessler will be covered in considerable detail in other parts of this book. I will write the section on my grandfather Gerhard Hessler and his wife Catherine Vanderpohl. However, I also want to add a few words here about two of Adam John Hessler's children in case this information is not included elsewhere in this book. George (or "Uncle Bob," as my father called him), Adam and Catherine Hessler's fourth child, was born on March 20, 1873. Uncle Bob was very big man; he is said to have weighed over 300 pounds and worn a size 21 shirt collar and size 14 shoes. According to a family story, George Hessler once carried a stone weighing 400 pounds nearly a block around one side of the courthouse square in Greensburg. George was married three times. George and his first wife Anna had one child, Fred (or Fritz), who lived with his Grandma Hessler (Catherine Stahl) after his mother died in 1899. George and Viola Wheeldon, his second wife, had four children: (1) Rosie, (2) Lester, (3) Elsie, and (4) Thelma. George and his third wife, Florence Cooper Reis, had no children.

Adam J. Hessler, the fifth child of Adam John and Catherine Hessler, was born on February 27, 1875, near Millhousen. Adam is mentioned in the History of Decatur County (1914) as a leading breeder of Chester White hogs. Adam married Ida Wagner on October 5, 1897. Adam and Ida Hessler had one daughter, Anna, who was born in September 1905. Adam J. Hessler died on November 17, 1947. As a child, I remember visiting his widow, whom we called Aunt Ida, and being fascinated with the stuffed owl which she had in her sitting room. Aunt Ida lived with her daughter Anna and her son-in-law John Dwenger on a farm in section 19, which had been owned by Hesslers since at least the 1880s. Among their farm animals were usually some guinea fowl, which I do not remember seeing anywhere else in the area. Anna and John Dwenger had no children.

John and Anna Maria Hessler's fourth child, John, was born on January 20, 1842, in Ohio, probably near Cincinnati. According to one family story, he was named John because his older brother John was sick at the time and was not expected to live. I have also heard that it was traditional for German families to use John as their sons' first or middle name, and similarly to use either Mary or Anna as one of the names for their daughters. Anyway, their fourth child was often called "Little John" to distinguish him from his older brother; however, Little John was, in fact, a much larger man than his older brother "Big John." Little John served in Co. E., 43rd Indiana Infantry in the Civil War.

Little John married Anna Mary Stahl on November 20, 1866. Little John was active in local Democratic politics, holding several minor offices in Marion Township, including Justice of the Peace. He is listed in the Atlas of Decatur County (1882). About 1882, Little John moved with most of his family to Howard County, Indiana, selling his farmland of about 110 acres to George Forster for \$2,800. In 1887, Little John's brother Adam John Hessler bought this land back from Forster for \$3,150. Little John died on June 12, 1908, near Kokomo, Indiana. Anna Mary Stahl Hessler was born on September 3, 1847, in Lemberg, Germany, and died near Kokomo on December 22, 1905.

Little John and his wife Anna Mary Hessler had six children: (1) Adam, (2) Mary, (3) John, (4) Joseph, (5) Rosa, and (6) Carrie. The oldest child, Adam, remained in the Millhousen area and married Frances Hodapp on February 7, 1893; she died on April 18, 1894, and is buried in the Hessler family plot at the Millhousen cemetery. Adam then married Elizabeth Ortman and soon moved to the Muncie area. Adam and Elizabeth had five children: (1) Albert, (2) Clarence, (3) Carl, (4) Ralph Adam, and (5) Catherine Alma. I met Albert Hessler in Muncie in the 1970s.

John and Anna Maria Hessler's fifth child, Margaret, was born on April 13, 1844, probably near Cincinnati. She married Adam Stahl, and they moved to the Kokomo area (Taylor Township, Howard County, Indiana) about 1870. They had at least five children (George, Fred, Lew, Mary, and Jacob). Margaret Hessler Stahl died on July 7, 1909. Her husband, Adam Stahl, who was born in Lemberg, Germany, about 1839, died near Kokomo on November 30, 1918.

John and Anna Maria Hessler's sixth child, Anna Mary, was born near Millhousen. According to her death certificate, Anna Mary was born on August 11, 1846; however, the church records show she was baptized on August 22, 1847, so it is more likely that she was actually born in August 1847. Anna Mary married George Stahl on June 14, 1866, and in 1872 they moved to Howard County with three small children. They had ten children: (1) John, (2) Catherine, (3) Anna Mary, (4) Anna Catherine, (5) Adam John, (6) Margaret, (7) Henry, (8) Mary Theresa, (9) Joseph Anthony, and (10) Leo Francis. Anna Mary Hessler Stahl died near Kokomo on May 24, 1920. George Stahl was born about 1838 in Lemberg, Germany, and died near Kokomo on March 8, 1904.

John and Anna Maria's Hessler's seventh child, Gerhard, was born on January 24, 1850. He was baptized on February 3, 1850; his baptismal sponsors were Gerhard Ruhl and Anna Maria Ruhl. No record of Gerhard's death has been found, but he probably died before his first birthday. He did live long enough to be listed on the 1850 federal census, where his age is given as three months.

A final word about the Stahls. I have always been intrigued that four Hessler brothers and sisters married four Stahl brothers and sisters. The Hessler and Stahl families used to get together regularly. What was probably the last (and perhaps only) formal Hessler-Stahl reunion was held in Millhousen on September 2, 1923, and was attended by 130 people according to the newspaper report of the event. A group photo taken at the reunion shows about 100 people, with the Hesslers mostly on the left and the Stahls mostly on the right. It is interesting to note that this reunion was held about two months after Grandma Hessler (Catherine Stahl) died on June 23, 1923. Perhaps it was planned before her death, or perhaps it came about as a result of conversations among family members who attended her funeral.

Family of Adam Johann Hessler (1807-1849)

Conrad Hessler's second child, Adam Johann Hessler, was born in Waag on September 3, 1807. It seems likely that Conrad (or his son John) wrote to Conrad's son Adam Johann (usually just called Adam) back in Germany and described their new home in Indiana. However, as far as I know, no letters written by our immigrant ancestors have survived. In any event, in 1841, Adam Hessler, along with his wife Magdalena Büttner and their daughter Rosina, left their home in the Schöllkrippen area and sailed aboard the ship Albert to join the rest of the Hesslers in America. They arrived at Baltimore on August 12, 1841. Three other Hesslers from Schöllkrippen (probably relatives of Conrad Hessler and his family) were aboard the same ship: Ad. Hessler, age 26, a baker; A. M. Hessler, age 16, a joiner; and A. M. Hessler (may be "N. M.," the handwriting is hard to read), age 44, a weaver. Nothing further is known about these other Hesslers.

Adam and Magdalena Hessler had six children: (1) Rosina, (2) John, (3) Catherine, (4) Anna Mary, (5) Gerhard (who died in infancy), and (6) Gerhard. All their children were born near Millhousen, except Rosina who was born in Germany and John who was probably born near Cincinnati.

Adam and Magdalena Hessler died tragically of cholera in July 1849, leaving five orphans. A cholera epidemic swept through the Midwest in the summer of 1849. According to the mortality schedule prepared in connection with the 1850 census, which listed deaths from June 1, 1849 to May 31, 1850, the following number of people died of cholera in these Indiana counties, mostly during summer 1849: Decatur Co., 19; Jennings Co., 15; Ripley Co., 66; and Franklin Co., about 75.

Adam and Magdalena Hessler were buried at St. Boniface Cemetery in Millhousen on July 23, 1849. The 1850 federal census mortality schedule incorrectly shows their deaths as occurring in August 1849. Family tradition says that they died in their sleep with their youngest child Gerhard, who was barely a month old, sleeping in the bed between them. Gerhard was fine and lived until 1928, having spent most of his adult life in Anderson, Indiana.

Adam Hessler's tombstone can still be seen in the Millhousen cemetery, though it incorrectly shows his birth date as 1809 (instead of 1807). As far as I can tell, that tombstone shows the earliest death date (1849) of any current tombstone in that cemetery. The inventory of Adam's estate in the Decatur County Courthouse provides an interesting glimpse into the everyday life of our immigrant ancestors. Here is that record valuing his personal property:

1 copper kettle	\$.75	1 keg, 1 trough & fat, & sundries	3.00
1 lot cooking utensils	2.00	1 barrel & salt, 1 tub & soap	2.25
1 lot cupboard ware	1.50	1 dung hook	.25
2 chopping axes	1.50	1 sugar kettle	.75
1 Britannia soap dish & lamp	.75	1 grindstone	.30
7 bee stands	25.00	1 clock \$2, 1 lot tinware 25¢	2.25
7 empty bee gums	.50	3 jugs, 2 buckets, and 1 keg	1.00
1 stove and pipe	3.00	1 lot plow and wagon harness	10.50
8 earthen crocks & 1 lot of onions	2.70	8 baskets, 1 flour barrel, and 1 bread tray	1.15
1 pair steelyards	.75	1 wagon, wagon bed & neck yoke	35.00
2 bedsteads	3.00	1 field of corn (about 13 acres)	39.00
1 lot linen, 2 bed ticks	3.20	1 lot threshed oats, 1 bag of beans	4.50
1 crop of potatoes in ground	7.50	1 piece of corn (about 1-1/2 acres)	6.00
5 bags, 1 lot linen 2 bed ticks	3.20	2 wagon covers, 1 umbrella	.85
1 lot of oats in shed	3.00	1 lot of wheat in sheaf in barn	5.00
1 lot of hay in barn	12.00	1 hat, 1 rope, 2 chests, & 1 looking glass	4.25
1 basket, 3 padlocks, & 1 clothes brush	.50	3 beds and bedding	6.00
1 plow	6.00	1 lot of tools, 1 barrel of vinegar	3.60
1 plow	1.50	3 bags of wheat	5.40
1 reel, 1 wheel, 5 chairs	1.50	1 rocking cradle & dressing	.50
1 double tree, 1 single tree, and 1 shovel	1.25	1 lot of old iron, 2 reap hooks, 1 old axe	1.25
4 bundles of poplar shingles	3.00	1 wheat fan	8.00
26 hogs	32.50	1 shoe bench & tools, and sieve	.50
1 table and oil cloth	1.00	1 bay horse, 3 years old	50.00
1 saddle	.75	1 bay horse, 2 years old	35.00
1 barrel and shelled corn	.60	1 pair wagon shaves and basket	1.00
1 yearling steer	3.00	1 red & white cow with one horn	8.00
1 yearling heifer	3.00	1 churn, 1 washtub, 1 base & pitcher	1.20
1 heifer calf, white face	2.00	1 barrel vinegar, 2 empty barrels	2.00
1 red bull, white face	6.00	1 spotted cow and calf	8.00
1 red heifer, white back	6.00	1 red cow, white back and belly	6.00
1 steer calf, white face	2.00	1 red heifer, white face	6.00
1 bay mare colt	18.00	1 bay mare and mule colt	50.00
		1 bay mare colt	18.00

The total value of Adam Hessler's tangible personal property was just under \$500. In addition, he owned notes receivable from various individuals worth almost \$650, and he had cash on hand in banknotes of \$46. Among the administrator's receipts are \$2.50 paid to John Boltz for making coffins for the deceased and his wife, \$2.48 paid to B. Gigos for goods furnished for the funeral, \$2.00 to John Newman for hunting and returning stray horses to the deceased's farm, \$3.45 to John Hessler for caring for livestock and property of deceased, \$2.00 to Daniel Patterson for crying the sale of Adam Hessler's estate, \$5 to A. Davison as attorney's fees for the estate, and \$5 to Father Munschina for Masses for the deceased and his wife. Adam Hessler's farm in the northwest corner of section 29 (just south of Millhousen) was sold to Anton Hahn by the administrator of Adam's estate.

Rosina, the oldest child of Adam and Magdalena, was born in the Schöllkrippen area in 1836, and she married Balthasar (Bals) Redelman at Millhousen on March 10, 1856. Bals was born about 1832 and was the youngest son of Matthias Redelman (born 1798) and Catherine Romberg (born 1801). Bals arrived at New Orleans on December 1847. According to Michael Daumer, from Crown Point, Indiana, who has researched the Redelman family, Bals's grandfather, Johann Freidrich Redelmann, from Borgholzhausen, Prussia, was married to Maria Elizabeth Geiners on October 17, 1785. Rosina died in December 1894. Bals died in 1915. Both are buried at Millhousen.

Bals and Rosina Redelman raised twelve children in the Millhousen area: (1) Mary, born 1857, married Ferdinand Keller; (2) John, born December 1858, married Tersa (Sophrina) Levell in 1880, eight children (including Ferdle, Frank, Laurence, Johnie, Bertha, and Bernard); (3) Philomena (Minnie), born 1860, married George Luken, no children; (4) Rosina, born 1862, married Harry Tomlin, one child; (5) Magdalena, born 1869, married John Hugel (or Stengal), two children (Balthasar and Mary); (6) Elizabeth, born about 1870, never married, died 1947; (7) Henry, born 1873, married Ida Picker, one child; (8) Anna, born 1875, married John Goldschmidt, one child; (9) Josephine, born December 1878, married Berhard Goldschmidt on February 16, 1898, seven children (including Albert, Rosa, and Estella (Holdreith)); (10) Ollie (Ulrich), born July 1880, married Elizabeth Mitchell, two children (Beryl (Hoatson) and Mildred (Fostvedt)), (11) Sarah, born July 1881, married Mr. Saddler, no children; (12) Sadle (Cecilia), born June 1886, married Benno Scheidler on May 12, 1909, no children.

Gerhard Hessler, the infant who escaped cholera, was born on June 19, 1849. Gerhard was cared for by Henry and Anna Coorman for a few years, and then his sister Rosina and her husband Bals Redelman adopted Gerhard. As an adult, Gerhard followed the shoemaker trade and owned his own shop in Anderson, Indiana. Perhaps he learned this trade from his uncle John Hessler, or perhaps he learned it from his Hessler cousins in the Cincinnati area. Little is known about Gerhard's first wife, except that they had two children (George and Anna). His second wife, Catherine Wiggerman, was born in Maysville, Ky., in 1857, and died in Anderson, Indiana, in 1932. Gerhard had seven children: (1) George, (2) Anna, (3) William, (4) Florence, (5) Clara, (6) Frank, (7) Urban. Gerhard Hessler lived in Cincinnati for several years (most of his children were born there), before he moved to Anderson. One of his sons, Urban, served in World War I; Urban never really recovered from being gassed in the war and died in 1929, about age 34. Gerhard Hessler died in Anderson, Indiana, in 1928.

Not much is known about the rest of Adam Johann and Magdalena (Büttner) Hessler's children. John was born about 1842 and died about 1855. Catherine was born on January 15, 1844, and died about 1859. Anna Mary was born on April 16, 1846; after her parents died, she was cared for by her godparents, John Henry and Catherine Moeller. Anna Mary married John Herman Hardebeck on April 22, 1862, at Millhousen. Her husband was probably the son of Barney Hardebeck. Anna Mary and her husband had at least one child (H. Boniface, born March 14, 1864) before they left the Millhousen area. I have been unable to trace her family any further. Another son named Gerhard was born on July 30, 1848, and was buried at Millhousen on August 14, 1848.

Family of Margaret Hessler Schneider (1809-1845)

Conrad Hessler's daughter Margaret, whose baptismal name was Anna Margareta, was born in Waag on November 30, 1809. Margaret Hessler married Adam Schneider at Krombach on May 7, 1833. According to the Krombach church records, Adam Schneider was born in Schöllkrippen on April 4, 1798, and was the son of Andreas Schneider and Eva Maria Steigerwald.

Adam Schneider and his wife Margaret Hessler had four children: (1) Margaret, (2) Adam, (3) Caroline, and (4) Catherine. The first two children were born in or near Schöllkrippen, and the youngest two in Jennings County, near Millhousen, where the family settled. Margaret Schneider was buried at St. Boniface Cemetery in Millhousen on September 4, 1845. Her husband Adam survived her for many years and died about 1870.

Adam and Margaret Schneider's oldest child, Margaret Schneider, was born in Germany (probably in Schöllkrippen) on May 1, 1835. She married Gregor Schneider in Millhousen on May 7, 1858. Their marriage record contains extra information to establish that he and Margaret were not related. Gregor's birthplace was shown as Herbstein, in Hesse, near the city of Fulda. His parents were Jacob and Josepha Schneider; according to their son's marriage record, Josepha's maiden name was also Schneider. By writing to the parish priest in Herbstein, I confirmed that Gregor Schneider was born in Herbstein on April 4, 1831, and that Maximilian Schneider, as well as Christian and Gerhard Ruhl (who are all listed among the thirteen Millhousen pioneers) were also born in Herbstein. Gregor Schneider arrived in the United States in December 1854.

Gregor and Margaret Schneider had eight children: (1) Catherine, married Mr. Conradt, (2) Benjamin, (3) Adam, (4) Mary, (5) Theodore, (6) Caroline, (7) Elizabeth, and (8) Joseph. Gregor Schneider died in 1895. Margaret Schneider died on December 21, 1906, at the age of 97. Both are buried in the Millhousen cemetery.

In the 1970s, when I was doing much of my genealogy research, I learned that a great grandchild of Gregor and Margaret Schneider, Mary Ann Schneider, and her mother Marie (widow of George Schneider, who was a son of Theodore Schneider) were living in a house in Millhousen which was built next to the original 40 foot long log church at Millhousen. The old log church was probably moved to that site in the mid-1860s, and was the home of John Voges and his family in the 1880s. After the Schneiders' new house was completed about 1930, the old church building was demolished.

Adam and Margaret Schneider's son, Adam Schneider, was born in Germany about 1836. His wife was named Louisa, and they had one daughter Anna Mary. In a Jennings Co. atlas published about 1880, a farm in section 1 was titled in Louisa's name, so her husband Adam had probably died earlier.

Adam and Margaret Schneider's daughter, Caroline Schneider, was born on April 25, 1841, near Millhousen. Her godfather was George Steigerwald. (This may be the same M.G.T. Steigerwald, who was among the passengers aboard the ship Mathilde who made the trip from Germany in 1838 with the Hesslers and the Schneiders.) Caroline married Bernard Brandewiede. They had seven children: (1) Benjamin (Bernard), who had three children (William, born September 2, 1896, died in 1975; Tannor Andrew; and Susan (Mrs. Percy Hall)); (2) Carrie (Mrs. William Albright), lived in Hamilton, Ohio; (3) Mary (married Mr. Woodruff); (4) Anna (married Mr. Wachendorf), lived in Cincinnati; (5) Louise (married Mr. Spander), lived in Indianapolis, then Chicago; (6) Frank, never married, died of typhoid fever at age 26; and (7) Joseph, died about age 7 or 8.

Adam and Margaret Schneider's daughter, Catherine Schneider, was born on September 23, 1843, near Millhousen. Catherine married Theodore Pfeifer, who was born in Hösbach (a German village about ten miles south of Krombach) on September 18, 1838. Theodore Pfeifer emigrated in 1853, and he married Catherine Schneider on April 18, 1860. Catherine and Theodore Pfeifer had nine children: (1) William, born August 31, 1864, (2) Caroline, born March 27, 1866, (3) John, born July 1868, (4) Lana, born about 1871, (5) Barbara, born 1876, married Clement Hamilton on April 15, 1896, (6) Joseph, born about 1879, (7) Charles, born about 1881, (8) August, born about 1883, and (9) Tillie, born about 1885.

Family of Mary Hessler Link (1817-1883)

Conrad Hessler's daughter Mary Hessler was born in Waag on August 22, 1817. Her baptismal name was Maria Anna. Mary Hessler married Francis Link at Millhousen on March 15, 1840. Their marriage was performed by Father Joseph Ferneding. Francis Link was born in 1804, and according to his naturalization record, he arrived in New York City on September 16, 1837. Link is a common family name in the Kahlgrund, so it is quite likely that Francis (or Franz) Link came from Krombach or a neighboring village. Mary Hessler Link died about 1883. Francis Link died on May 4, 1877. Their tombstones are in the Millhousen cemetery.

Mary Hessler and Francis Link had seven children: (1) Margaret Hessler (adopted by Francis Link); (2) Adam, baptized on April 25, 1841, never married, probably lived with his brother Frank; (3) John; (4) Francis; (5) Herman; (6) Mary Anna, born September 10, 1850; and (7) Magdalena, born September 18, 1853. I have further information about only three of these children, John, Francis, and Herman.

John Link, was born the last week of October 1842 (according to his baptismal record at Millhousen), and was baptized on November 25, 1842, at Millhousen. His godparents were John Kretz and A. M. Halverben. John Kretz was probably from the Kahlgrund. John Link married Theresa Fry at Millhousen on September 11, 1866. John and Theresa Link had three children: (1) John, (2) Mayme, born June 27, 1871, and (3) William, born February 10, 1874. John Link and his second wife Lena Folzenlogel had five children: (1) Catherine, (2) Bertha, (3) Rosa, born October 1883, (4) George, born May 1886, and (5) Margaret, born April 1889.

I have a little additional information about two of John Link's children. John and Theresa (Fry) Link's daughter, Mary M. (Mayme) Link, married James Francis (Frank) Hamilton on November 22, 1893. Mayme and Frank's daughter, Leona Hamilton, was born on May 6, 1896. Leona's great grandfather was Dr. Conwell, who lived in Westport, Indiana. John and Theresa (Fry) Link's son, William Link, married Dora Hahn. Her parents were Valentine Hahn (a Civil War veteran) and Susanna Herman. William and Dora Link had at least four children: (1) Walter, born on July 12, 1901, and died on May 25, 1985, in Greensburg, (2) Martha (Mrs. Glen Hungate) of Greensburg, (3) Ethel (Mrs. Clyde Logan) of Greensburg, who had one son William Logan, and (4) Howard Link, born June 27, 1912, and died October 13, 1984, in Texas City, Texas.

Francis (Frank) Link was born near Millhousen about 1844 and died about 1911. Frank Link married Sarah Dobson on January 28, 1875. His will lists six children: (1) Roman, born 1877, (2) Herman, born 1879, (3) Henry, born 1883, (4) Elizabeth (Tator), born 1884, (5) Charles, born 1886, and (5) Franz (birthdate unknown). Another son, Eddy Link, died on September 4, 1889, at age 10.

Herman Henry Link was born on February 15, 1847 and died on March 7, 1889. Herman Link operated a saloon in Greensburg. Herman's wife, Sophia Kraus, was born in 1849 in Batesville and died in Greensburg in 1899. Herman and Sophia had five children: (1) Mary, (2) Antoinette (Mrs. Jacob Meyer), (3) Della (Mrs. Frank Loudon), (4) Harry, and (5) Charles. Herman Link's daughter, Antoinette, was born on August 27, 1880. She married Jacob Meyer, who owned a saloon in Napoleon. Jacob's parents were Andrew and Saloma Philips Meyer, French immigrants. Jacob died in 1927. Antoinette (Nettie) died in 1959. Herman Link's daughter, Della, was born on November 25, 1883. On September 12, 1906, Della married Frank Loudon in Greensburg. Frank Loudon was born in Shelbyville on February 13, 1884, and was the son of John and Maggie (Gaynor) Loudon. Frank worked as a transferman for the railroad in Greensburg. Della and Frank Loudon had two children: (1) Margaret Loudon, who married Tommy Thompson, and (2) Richard (Dick) Loudon. Herman's youngest son, Charles Link, was born on September 23, 1888, in Greensburg. He married Mary Tumilty, the daughter of Thomas and Margaret (Wright) Tumilty, on June 18, 1914. Charles owned Link's Cigar Store (tavern) in Greensburg. Charles and Mary Link had three children: (1) Mary Margaret Link (Mrs. Donald Gilliland), (2) Thomas Link, and (3) Urban Link.

Conrad Hesters Will

I Conrad Hester of Jennings County, State of Indiana do
make and publish this my last Will and Testament hereby
revoking and making void all former wills by me at any time
heretofore made. First I desire that my body be decently
interred and that my funeral be conducted in a manner
corresponding with my Estate and situation in life and
as to such worldly Estate as it has pleased God to bestow
on me with I dispose of the same in the following manner
to wit I direct first that all my just debts and funeral
Expenses be paid as soon after my decease as possible
out of the first monies that shall come to the hands of my
Executors from any portion of my estate. I also give
and bequeath to my daughter Margaret who has intermar-
ried with Adam Snider my half of the Negro owned by
me and said Snider also my half of one common two
one horse mare Eight high and one half of my beds
& bedding and four sides Barrells and one Mattress
and one wedding hood. I also give and bequeath
to my Grand daughter Margaret Hester a step
daughter of Francis Sink Fifty dollars in cash and
one half of my beds & bedding provided she shall live
to years of maturity and the remainder of my Estate
is to be equally divided between Adam Snider my
son in law and Francis Sink my son in law and
Adam Hester and John Hester my two sons said
residue to be divided by two respectable neighbors
and I hereby make and ordain my worthy and
esteemed friend Adam Snider Executor of this
my last will and Testament.

In witness whereof I Conrad Hester the Testator
have hereunto set my hand and seal this 26th
day of November A. D. 1842

This Indenture made this twelfth day of March in the year of our Lord one thousand eight hundred and thirty nine between Peter Mires and Margaret his wife of the county of Decatur and state of Indiana of the one part and Conrad and John Hesler of the county of Decatur and state of Indiana of the other part witheneth that the said party of the first part for and in consideration of the sum of three hundred dollars lawful money of the United States to them in hand paid by the said party of the second part the receipt where of is hereby acknowledges by the said party of the first part hath granted bargained and sold and by these presult both granted bargain and sell unto the said party of the second part their heirs and assigns forever all that trust or parcel of land situatted lying and being in the county and state afore said and described as follows eighty nine acres off from the east end of the fractional mouth west quarter north of the Indian boundry line of fractional section number twenty nine in township No.9 north of range No.10 east it being in the district of low subject to sale at jeffersonville Indiana to have and to hold the above described premise thereby sold and conveyed unto the said Conrad and John Hessler their heirs and assigns forever together with all and singular the appurtained thereunto belonging or in any wise appert aiming to their own proper use and the said Peter Myers and Margaret his wife for their heirs escutas and administrators the aforesaid lot or tract of land and appusturaumes to the said Conrad and John Hessler their heirs and a administrators against the claim or claims of all and every person whatever will warraut and forever defend in testionmony where of the said Peter Myers and Margaret his wife have here unto set their hands and affixed their seals the day and year first and above written

Sign Sealded and delivered in the present of E.A. Jocelyn Pete Myers Blasuis Gegos Margaret Mvers

[Handwritten transcription of the deed text, including details of the land parcel and the parties involved.]

[Handwritten signatures and names of the parties, including E.A. Jocelyn, Pete Myers, Blasuis Gegos, and Margaret Mvers.]

ADAM JOHN AND CATHERINE (STAHL) HESSLER

Adam John Hessler was born on Feb.17,1840 at Millhousen in Decatur Co. Ind. He was the son of John and Mary Anna (Nees) Hessler. Adam was one of seven children;1.Eva;2.John;3.Adam;4.John;5.Margaret;(Stahl);6.Anna Mary (Stahl);7.Gerhart.

John and Mary Anna (Nees) Hessler traveled the United States from Krombach Germany with John's father Conrad Hessler. They purchased land in March of 1839 in Decatur Co. Indiana.

Adam John Hessler was born during the days, of the first settlers in Millhousen. The first church at Millhousen, "Chapel of St. Boniface" was a log structure 20X24 feet, built in 1840. The first marriage performed there was that of Mary Hessler and Francis Link. The records show that Adam John Hessler and Henry Victor were the first to be baptized there. The chapel was without pews and without heat. Parishioners brought their own stools and during the winter months stomped the rought floor with their wooden shoes to keep their feet warm.

Adam John was married on Nov.21,1865 at the Millhousen Catholic Church, to Catherine Stahl. Catherine Stahl was born on Feb. 6,1845 Lemberg Germany. She was the daughter of Jacob and Catherine (Greiner) Stahl who had settled in Ripley Co. Indiana.

Adam was a farmer, he also established a lumbering business, cutting and hauling the huge old trees to Cincinnati to sell. He and Catherine lived for a time in a small log cabin near the site of their future home. Adam built a large two story brick home (south of Millhousen) in 1869 for his family. The bricks were made from clay, near the site of the home. All of Adam and Catherine Hessler's children were born in this house. It is still standing today, and is owned by Lawrence Smith.

Adam Hessler passed away on March 7, 1903 at Millhousen Indiana. Catherine (Stahl) Hessler ,when she grew older moved in with her daughter, Mary Menkedick. She lived with her daughter Mary until the time of her death June 29,1923 at Millhousen, Ind. Adam and Catherine Hessler are both buried at the Millhousen Catholic Cemetery. Adam and Catherine were the parents of 8 children;Mary b/1866 married Joseph Menkedick they had 7 children;John b/1870 died 1870 at the age 2;Frank b/1873 married Mary Rutt they had 15 children;George b/1873 married 1.Viola Wheeldon 2.Anna Herbert Viola and George had 7 children; Adam John b/1875 married Ida Wagner they had 2 children; Gerhart b/1876 married Catherine Vanderpohl they had 7 children; Henry b/1878 died at the age of 1 years old.; Andrew b/1879 married Catherine Enderline they had 5 children.

(See graph)



Adam Hessler Catherine (Stahl) Hessler
 (b/1840) (b/1845)



Catherine (Griner) Stahl
 (born Nov. 8, 1803 Germany)
 wife of Jacob Stahl



gravestone of Mary Anna
 (Neese) Hessler - wife of
 Adam J. Hessler
 b/1807 d/1880



Gravestone of
 John Adan Hessler
 b/1809 d/1849

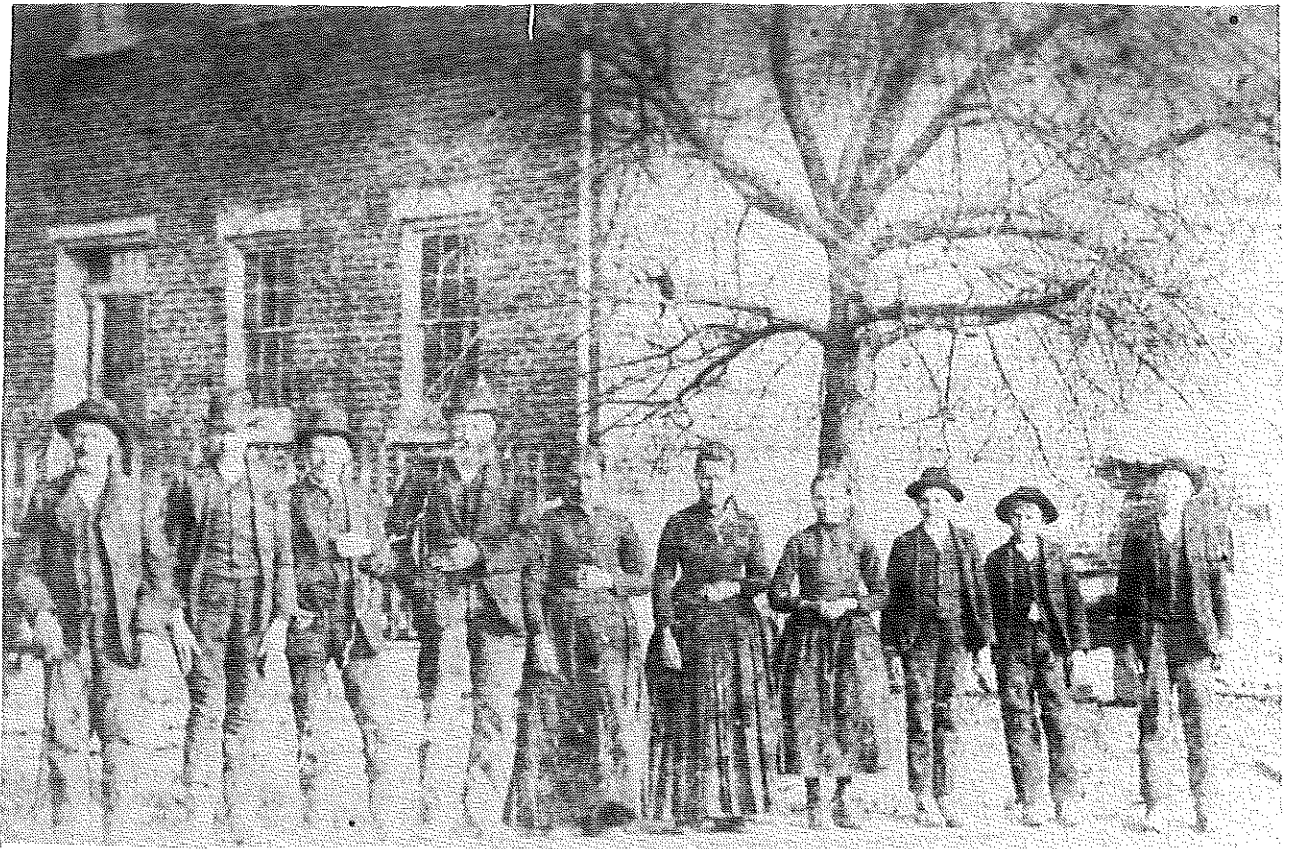

Family of Adam and Catherine(Stahl) Hessler
 L to R:Hired Man,George, Frank, Adam, Catherine, Mary, Hired girl,
 Gerhard, Andy, Ed taken about 1888

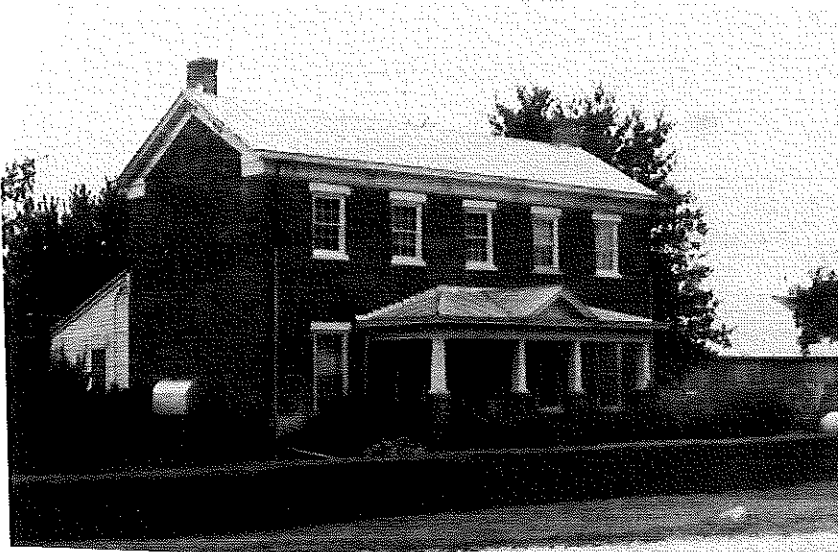

Hessler home at Millhousen,
 built by Adam and Catherine(Stahl)Hessler



Adam and Catherine(Stahl) Hessler
 son of John and Mary Ann(Neese) Hessler



Hessler and Stahl family reunion at Millhusen in 1923

WEDNESDAY, SEPT. 5, 1923, 717

HESSLER AND STAHL FAMILIES' REUNION

A family reunion of the Hesslers and Stahls was held Sunday at Millhusen. Many of the members of these families from Illinois and Iowa, Muncie, Anderson, Kokomo, Indianapolis and Decatur and adjoining counties gathered at Millhusen, near where their ancestors settled more than a century ago.

A mass was said at 9:30 o'clock Sunday morning at St. Mary's Catholic church at Millhusen, for the deceased members of these families, and after the services all gathered at the Knights of St. John hall, where the crowd, numbering 180 relatives, participated in a pitch-in dinner. Music, card playing, feasting and picnicking kept the merry crowd together until late in the evening.

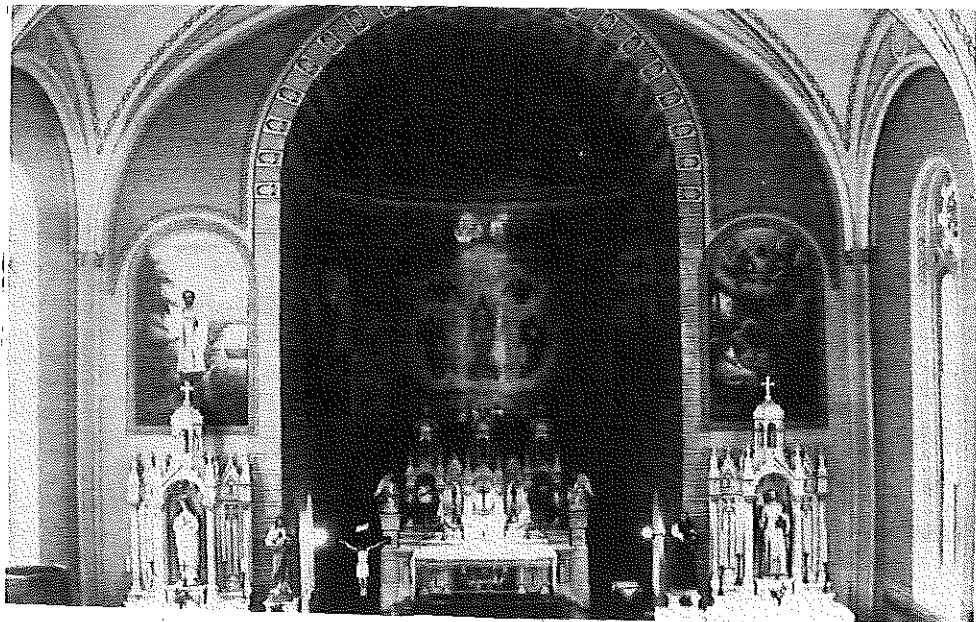

239 interior of the Millhusen Catholic church

MILHOUSSEN

1880's

J. F. J. e

J. Waljaeck
26.57A.

Christian Schneider

SCHNEIDER'S
OutLot 5
465A.

OutLot 6
465A.

H. Schutte
460A.

J. Pander
455A.

J. Pander
444A.

J. Pander
444A.

Total 40A.
Cathol

Cathol

OutLots
K. L. Hugel
450A.

OutLots
J. G. Harbeck
3,568A.

OutLot 10
Mrs. M. Schneider
3,568A.

OutLot 11
H. Pander
3,368A.

OutLot 12
H. Pander
3,884A.

B. Koots
4A.

G. S. T. A. N. D. A. C. H
17A.

24A.

Catholic Church Property

Mrs. Martha Miller

Mrs. A. M. Korke

Mrs. Egbert

H. Vonderheide

Mrs. Wleiman

J. Keller

Brick yard
300000 Per Year

Mrs. E. Potkenlogel

Catholic Church Property

JOSEPH AND ANN MARY(HESSLER) MENKEDICK

Anna Mary Hessler (called Mary) daughter of Adam and Catherine (Stahl) Hessler was born on a farm near Millhousen, Indiana on August 26, 1866. On April 19, 1893.

She was married to Joseph Menkedick from Cincinnati Ohio, son of Gerard Henry and Catherine Wickmann Menkedick, in the Immaculate Conception Church of Millhousen, which they attended.

Joseph Menkedick was born in Cincinnati Ohio, on July 11, 1859, the son of Gerhart Henry and Catharine Menkedick. Gerhart Henry Menkedick was born in Germany in 1818, and came to America in 1857, He settled first in Cinn. Ohio. While there he was married to a widow, Catherine Moeller, who had two boys. He stayed a short time in Ohio before coming to Indiana and settling in Decatur County, where he bought a farm in 1865. He lived in a log cabin. His wife gave birth to twins, a girl and a boy, His wife and baby daughter both died in complications of childbirth. The baby boy was our Joseph Menkedick. Gerhart Henry Menkedick in his old age moved to Millhousen, where his last days were spent, his death occurring in 1890. His third wife, was Mrs. Theresa Herbert, of Ripley County, Indiana, to which union there was no issue.

At the age of fourteen years Joseph Menkedick started in to earn his living, receiving at first but five dollars a month, which wage gradually was increased until he was receiving twenty dollars a month, and eventually he earned enough to pay one thousand dollars down on a farm costing him three thousand two hundred dollars, the balance to be paid in eight years. He now has a well-improved farm, on which he has spent about nine thousand dollars in improvements. Mr. Menkedick's farm covers one hundred and twenty acres of vvery productive, level land, located a quarter of a mile from the pike road, on which he has a substantial brick dwelling. he raised from fifteen to eighteen head of cattle and from twenty-five to forty hogs annually.

Joseph and Mary Menkedick purchased a 120 acre farm north west of Millhousen area and made their living entirely from farming. This was their home throughout their lives. They raised seven children Theresia b/1894 (Moorman), Louis b/1895, Catherine b/1897 (Duerstock), Henry b/1898, William b/1900, Anna who was born on April 17, 1903 (who died at age 17 months from dysentery they thought as a result of eating green grapes from an arbor in the yard in 1904) and Joseph b/1905. The Children attended school at Dakenhart (a little one room school) only a year then they attended the Catholic School at Millhousen.

When Mary's mother, Catherine (Stahl) Hessler, was no longer able to care for herself Joseph and Mary took her into their home; she died June 20, 1923.

Once when little Anne had picked up a butcher knife, Mary upon seeing her reached for the knife and Anne pulling it back away cut deeply into her mothers Mary's hand. She always had the Scar on her hand from this. Henry was very quiet, and would stand in the background very quiet.

Mary died on the Holy Day of the Assumption in 1928. When Grandma Menkedick died Joseph didn't want to move, but anybody could move in with him, so he sold the farm to their daughter. Theresia and her husband Louis Moorman purchased the family farm. Joseph lived with his daughter only a short time, he died of a cerebral hemorrhage on December 27, 1928. The farm bought by Joseph and Mary in 1893 is still owed and operated by a grandson Carl Moorman.

Mr. and Mrs. Menkedick were members of St. Mary's Catholic Church at Greensburg and their children were reared in that faith. Mr. Menkedick was a Republican and was warmly interested in the county's political affairs, being an earnest supporter of all measures designed to advance the public welfare.

Menkedick - Wenning.

Henry Adam Menkedick 11/10/98 - 2/11/72 Catherine Elizabeth Wenning 5/16/01 - 2/02/89
Married Sept. 12, 1923

- Carl Joseph Aug. 17, 1924 - Dec. 21, 1932
- 1. Alfred John Aug. 17, 1927 - Nov. 25, 1963
- 2. Edna Mae July 3, 1932
- 3. Harold William Aug. 8, 1934
- Clifford Joseph Oct. 13, 1937 - Aug. 15, 1959
- Mary Ellen May 30, 1944

- 1. Alfred John Menkedick - Betty McKelvey Married Aug. 3, 1955
- David William Oct. 14, 1956
- Karen Ann Aug. 24, 1959
- Kathleen Marie Oct. 3, 1962 - Feb. 12, 1963

David Menkedick - Kathy Nobbe May Married 1991

- 2. Edna Mae Menkedick - Frank Zobel Married Aug. 8, 1959
- Sue Ellen Aug. 11, 1960
- James Francis Dec. 6, 1961
- Roscoe Frank July 6, 1963 - July 6, 1963
- Hark Jon June 3, 1964
- Carol Lynn Oct. 3, 1967

Sue Ellen Zobel - Brian Stoneking Married 1985
 Anna Catherine March 6, 1988
 Jonathan Chester May 10, 1991

Hark Zobel - Annette Wilbur Married 1985
 Tasha Nicole Dec. 18, 1991

Carol Zobel - Jeff Teague Married 1993

- 3. Harold Menkedick - Bernice Lamping Married Nov. 27, 1958
- Michael Harold Dec. 15, 1959
- Kevin Carl Sept. 23, 1961
- Douglas John July 14, 1963
- Philip Edward Feb. 12, 1965
- Donna Kay Nov. 18, 1966
- Christopher Alan Dec. 10, 1978

MENKEDICK - HESSLER

- Theresia Menkedick - Louis W. Moorman
2/3/94 - 6/21/64 11/19 '87- 2/2/44
- Louis Menkedick - Elizabeth Parr
9/25/95 - 3/27/56 12/1/97 - 3/17/46
Mary Schwerling
1/ /09 - 6/8/74
Humphrey
- Catherine Menkedick - Lawrence Duerstock
2/15/97 - 1/28/51 4/11/89 - 3/22/61
- Henry Menkedick - Catherine Wenning
11/10/98 - 2/11/72 5/16/01 - 2/2/89
- William Menkedick - Helen Draping
10/16/00 - 1/30/60 6/28/05 - 2/17/93
- Anna Menkedick
4/17/03 - 9/9/04
- Joseph Menkedick - Gertrude Weimer
11/9/05 - 12/10/63 8/5/14 - 2/20/40
Rose Schoettmer
4/17/10 - 8/18/64

Michael Menkedick - Rita Ricke Married 1983
 Keith Michael Jan. 16, 1985
 Lindsay Joann Jan. 16, 1985
 Craig William April 29, 1986

Kevin Menkedick - Kathy Reed Married 1980
 Kayla Sue Dec. 30, 1986
 Kyle Joseph March 19, 1989

Douglas Menkedick - Anne Kinsner Married 1989
 Derek John May 8, 1990
 Autumn Marie Nov. 8, 1991

Philip Menkedick - Lian Hanitel Married 1991
 Macey Lee Nov. 28, 1991

Donna Menkedick - Jon Wren Married 1985
 Megan Nicole Dec. 20, 1985
 Caitlyn Renee June 9, 1992



Theresa Menkedick
 Catherine Menkedick
 m/1915 Joseph Moorman
 Louis Moorman
 sitting



Joseph Menkedick and Mary (Hessler) Menkedick
 b/1859 Cinn., Ohio b/1866 Millhausen, In.



Catherine, Henry, Louis, William, Theresa
 Joseph



Stella, Martha, Alma, Lucille, Lawrence,
 Carl, Louis, Walter, Theresa, Eileen, Mary, Philip

Mary Theresia Menkedick

LOUIS WILLIAM MOORMAN

Louis Moorman was born November 19, 1887 in Millhousen. He married Theresia Menkedick daughter of Joseph Menkedick and Mary Hessler Menkedick on Nov. 23 1915. They bought a farm and lived there until 1928. Grandma MENKEDICK died and Grandpa would not move. Anyone who wanted to could move in with him, since he was not able to stay by himself. The rest had other homes so they bought the farm and moved in with Grandpa in sept. Joseph Menkedick died in Dec. Louis died Feb. 2, 1944 and Theresia farmed the farm with the help of her children until she sold it to Lawrence and Carl Moorman. She lived with them until Carl married in Oct. of 1960. She moved in with her daughter Alma until she died in June 1964.

They were the parents of ten children, Lawrence born Nov. 16, 1916 He never married. He still lives on the home place.

Stella Mary born August 1, 1918. She married Norbert Scheidler.

Alma Elizaeth born Dec. 24, 1919. She Married Edward Schwering.

Lucille Dorothy born Dec. 3, 1921. She married Thomas Braun.

Martha Catherine born Nov. 17, 1923. She married Richard Batta.

Mary Christina born July 27, 1928. She married Henry Yeager.

Ralph Charles born Oct. 31, 1930. He married Mary Effing.

Carl Joseph born Sept. 26, 1933. He married Eileen Nobbe.

Eileen Theresia born July 19, 1935. She married Cyril Schebler.

Walter Lawrence born June 8, 1937. He was born with a mental handicap.

Feb. 24, 1928 will be remembered in the life of Louis. Someone saw the church roof on fire. The alarm was sounded and the crowd gathered the old fire engine was brought in, but the water would not reach the roof of the church. The shingles were burning sixty feet above the ground. Louis climbed the tower with a bucket of water and crawled through a small opening onto the roof. He poured the water onto the fire and saved the Millhousen church from burning.

Lawrence Joseph no family

Stella Mary married Norbert Scheidler May 9, 1950. Norbert was born Oct. 16, 1912. They are the parents of five children.

Teresa Clare born Feb. 26, 1952

Marita Jonette born March 30, 1953

Laura Eileen born March 7, 1955

Susann Mary born March 15, 1957

Denise Lucille born March 15, 1963

Teresa married Lawrence Paul Merkel Sept. 27, 1980. Lawrence was born Sept. 7, 1951. They had three children. Christopher Lawrence born June 8, 1982. Heidi Marie born Nov. 15, 1983. Janice Nicole born sept. 28, 1986.

Marita married John Michael Cohen July 7, 1984. He was born May 13, 1943 They had three children. Kelly Ann born Aug. 27, 1985. Kimberly Scheidler born June 30, 1987. Danielle Denise born Dec. 7, 1989.

Laura Eileen married Connor Dan Ross April 19, 1980. He was born Nov. 15, 1955. They had three children. Julie Kristen born July 1, 1981. Jesse Connor born June 12, 1984. Jason Michael born Feb. 21, 1987.

Susann married Kevin Lee Reich Nov. 24, 1979. He was born July 18, 1958. They had three children. Lindsey Michelle born Jan. 17, 1985. Adrienne Marie born March 29, 1987. Eric Stephen Sep. 24, 1990.

Denise not married.

Lucille married Thomas Joseph Braun Nov. 23, 1948. He was born July 21, 1922. They had two children. Patricia Mae born Sept. 21, 1950. Virginia Sue born Nov. 29, 1952.

Patricia married Dennis D. Wuensch Aug. 21, 1971. He was born June 29, 1944. They had two children Tyson Thomas born Sept. 1, 1974. Rurik Joseph born Sept. 7, 1980.

Virginia married Richard Marchel Aug. 18, 1984. They had one child Joseph Ryan born Nov. 19, 1985. He was born on his great grandfather's 98 birthday.

Lucille's step Grandmother and Tom's Grandmother were sisters so that made them step cousins.

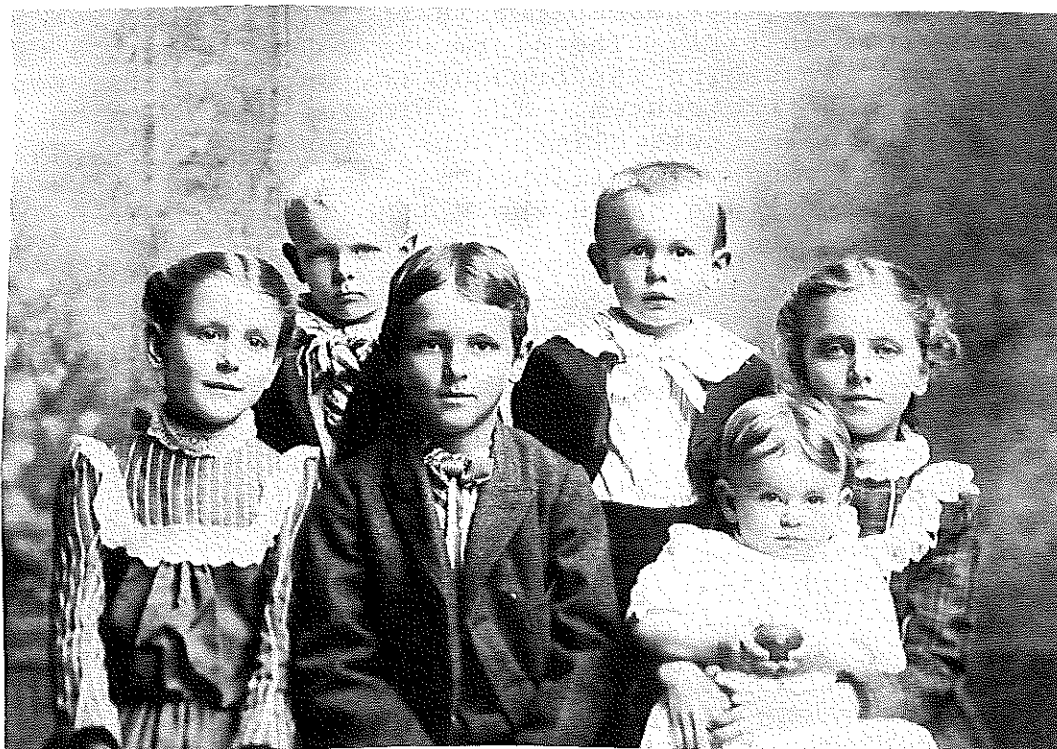

Children of Joseph and Mary (Hessler) Menkedick
Back row: William (Bill), Henry
front row: L to R: Catherine (Menkedick), Louie,
Annie (died Young), Theresa (Moorman) 1904

Edward Bernard and Alma Elizabeth (Moorman) Schwering

Alma Elizabeth Moorman was born on De.24,1919. She married Edward Bernard Schwering of Oct.10,1945. Ed was born on Jan.13, 1917 and died on June 3,1955. He served in World War II for three and one half years. Alma and Ed have five children.

1.Raymond Bernard Schwering born Sept.6,1946; 2.Louis Clement Schwering born Nov.1,1947; 3.Georgiana Mary (Jan) Schwering born Feb.28,1949; 4.Marjorie Helen Schwering born May 25,1951; 5.Ruth Ann Schwering born Aug.26,1953.

Raymond married Donna Johannigman on July 28,1973. Donna was born on June 21,1953. They have two sons Andrew James born Aug.19, 1974 and Patrick William born on June 14,1976.

Louis married Barbara Roby on July 16,1967. Barbara was born on July 12,1948. They have two children ;Edward Louis born May 17, 1968 and Tamarah Marie born March 31,1971. Louis And Barbara was divorced in 1972.

Louis married Judy Kaye (Wilson) Barcus on July 26,1975. Judy was born April 23,1945. Louis and Judy have one daughter, Staci Rae, born May 6,1977. Judy had two children before she married Louis. Lisa Lynne was born Dec.10,1965 and Nichole Lee (Nikki) was born July 11,1973. Louis adopted Nikki in 1980. Lisa has a daughter, Amanda Kaye Barcus, born on Nov.29,1981. Lisa married Walter Sanabria on April 12,1984 and they have a son Timothy Walter, born on September 12,1985. Lisa and Walter were divorced in July of 1990. Nikki died on Easter Sunday, April 11,1993 after a mysterious illness that happened in Sep. 1982. This illness left Nikki paralyzed from the neck down and dependent upon a ventilator to breath.

Georgiana Mary married Roy Thomas Ervin on June 22,1974. Roy was born on Jan.16,1939. Roy and Jan have one son ,Christopher James, born Feb.13,1975. Roy has two sons and an adopted daughter from a previous marriage. Peggy Sue was born March 1,1958; Roy Thomas Jr. was born July 24,1963 and Jeffrey Wood was born Aug. 21,1965. Peggy was married to Mark Rice and they have a daughter named Christy and a son named Craig. Peggy was divorced and later married Don Hynes. Roy Jr. married Lisa Denney and they have one son, Dylan, born Nov.22,1991. Roy Jr. also has a daughter, Amanda Kaye Barcus, born November 29,1981.

Marjorie married Ronald Reitman on June 27, 1970. Ron was born Oct.7,1950. They have four children, Tricia Kaye, born Aug.13,1971, Rhonda Michelle, born Aug.11,1972. Dominic Robert born March 10, 1977 and Paul Zachary born Dec.8,1982.

Ruth Ann married Donald Lucas on Aug. 13,1976. Don was born on March 12,1954. Ruth has a daughter Tracy Lynne born Sept.21, 1972. Ruth and Don have two daughters, Janice Ann born Aug.13, 1978 and Dawn Michelle born Sep. 15,1980.

MARTHA MOORMAN

Martha Catherine Moorman born Nov. 17, 1923 married Richard Batta May 11, 1949. He was born May 8, 1924. They had seven children.

MARY Jane born Aug. 3, 1950. She married Richard F. Fussner Jan. 20, 1973. He was born March 11, 1944. They had eight children.

Catherine Marie Fussner born Jan. 16, 1974

Jennifer Ann Fussner born Jan. 15, 1975.

John Adam Fussner born July 17, 1976.

Joseph Richard Fussner born Nov. 16, 1977.

Carl David Fussner born Oct. 2, 1979.

James Daniel Fussner born May 29, 1982.

Theodore Roger Fussner born June 12, 1986.

Kenneth Nicholas Fussner born Feb. 18, 1988.

Karen Dorothy born July 5, 1952. She married David Anderson Aug. 5, 1972. He was born Jan. 9, 1950. They had three children.

Amy Michelle Born June 17, 1973.

Jill Marie born Jan. 31, 1976.

Matthew Carl born June 7, 1977.

George Richard born May 14, 1954. He married Sue Lampert Sept. 9, 1978. She was born Aug. 27, 1959. They had four children.

Christina Louise born May 21, 1979.

Andrew George born Oct. 19, 1981.

Michael Nicholas born Nov. 23, 1984.

Emily born Sept. 26, 1990.

David Howard born Jan. 6, 1956. He married Joyce Werner Sept. 26, 1981. She was born June 1, 1961. They had two children.

Brian David born June 9, 1984.

Kimberly Erin born Dec. 1, 1986.

Daniel Paul born Feb. 17, 1959. He married Janelle Kain June 19, 1982. She was born March 23, 1960. They had three children.

Nicole Ann born April 18, 1983.

Sarah Emily born Sept 21, 1985.

Alicia Catherine born Feb. 1, 1987.

Roger Joseph born Feb. 13, 1962. He married Diane Erhart Aug 20, 1988. She was born June 1, 1963. They had three children.

Amanda born Oct. 10, 1989.

Victoria born Feb. 23, 1991.

Brandon born July 19, 1992.

Nicholas Carl born Nov. 10, 1967.

MARY CHRISTINA MOORMAN

Mary born July 27, 1928. She married Henry Yager Sept. 6, 1950.
He was born April 17, 1926. They had seven children.

Betty Mary born Nov. 2, 1951. She married Philip Anthoy May 26, 1974.
He was born May 8, 1952. They had two children.

Barbara Marie born Aug. 6, 1979.

Stephen Michael born Dec. 16, 1980.

James Henry born Oct. 16, 1952. He married Kathy Alverson Aug. 1, 1975.
She was born Oct. 26, 1957. They had three children.

Katie Sue born Feb. 3, 1976.

Daniel James born Nov. 2, 1978.

Elizabeth Ann born April 13, 1982.

Donald Fredrick born Nov. 6, 1953. He married Debbie Chandler Jan. 31,
1986. Divorced. *Married Kim Adkins born 9-25-58*

Married 9-15-1990

Paul Louis born Feb. 29, 1956.

Jerome Edward born Aug. 9, 1957. He married Beverly Heller

She was born

They had one child.

Douglas *born 9-4-91*

Janet Matilda born Sept. 24, 1958. She married August Litmer Oct. 8, 1976
He was born Nov. 26, 1957. They had four children.

Nathan Lee born April 17, 1977.

Neil August born Dec. 29, 1980

Brandon James born May 8, 1982.

Blake born July 29, 1989.

Ann born Oct. 9, 1960. She married Michael (Charlie) Koors July 26,
1980. He was born April 5, 1960. They have four children.

Bruce Michael Feb. 12, 1984.

Scott Dale born Nov. 21, 1985.

Craig born May 20, 1987.

Mindy Lynn born June 10, 1990.

RALPH CHARLES MOORMAN

Ralph born Oct. 31, 1930. He married Mary B. Effing Sept. 14, 1955.
She was born April 2, 1934. They had six children.

Teresa born Sept. 10, 1956.

Bernard Louis born Sept 5. 1957. He married Laura E. Manion July 9, 1982
She was born April 21, 1959. They had two children.

Elizabeth Beth born June 29, 1983.

Tamara Rene born Dec. 5, 1984.

George born March 20, 1959.

Richard born July 7, 1961. He married Ruth Hempfling Feb. 9, 1980.
She was born Nov. 29, 1962. They had four children.

Mary Elizabeth born July 20, 1980. She lived just two days.

Died July 22, 1980.

Rovena Ruth born Oct.12, 1982.

Jennifer born March 23, 1984.

Cassandra Nicole born April 22, 1986.

Rick and Ruth were divorced ~~on Nov-23, 1991~~ Rick then married Linda
Eisert Snow. She was born Feb. 6, 1951. She had three children.

Amber born Oct. 29, 1974.

Leslie born March 11 1977.

Shawna born Dec. 7, 1981.

John born Dec. 1, 1962.

Mark Andrew born March 21, 1967. Mark was seriously injured in a
bicycle and car accident in May of 1974.

CARL JOSEPH MOORMAN, SEPTEMBER 26, 1933

CARL WAS BORN IN GREENSBURG, INDIANA, THE SON OF LOUIS WILLIAM AND THERESIA MENKEDICK. ON OCTOBER 26, 1960, CARL MARRIED EILEEN STELLA NOBBE IN ST. MAURICE, INDIANA. SHE IS THE DAUGHTER OF WILLIAM FRED NOBBE AND ALVINA CARYLAN DWENGER AND WAS BORN DECEMBER 2, 1939. CARL AND EILEEN HAVE ALWAYS LIVED IN MILLHOUSEN AND FARM APPROXIMATELY 220 ACRES. THEY HAVE SIX CHILDREN, JOSEPH CARL, LINDA SUE, CAROL ANN, THOMAS WILLIAM, GENE ALLAN, AND DONNA MARIE, AND ONE SON, ALLAN LOUIS, WHO DIED AT SEVEN WEEKS.

JOSEPH CARL MOORMAN, JULY 25, 1961

JOSEPH WAS BORN IN GREENSBURG, INDIANA, THE SON OF EILEEN STELLA (NOBBE) AND CARL JOSEPH MOORMAN. HE GRADUATED FROM SOUTH DECATUR HIGH SCHOOL IN 1979. IN 1980, JOE ATTENDED INDIANA STATE UNIVERSITY, TERRE HAUTE MAJORING IN ACCOUNTING. FROM 1981 - 1983, HE ATTENDED PURDUE UNIVERSITY, WEST LAFAYETTE AND GRADUATED IN 1983 MAJORING IN AGRICULTURAL FINANCE. JOE CURRENTLY IS A LOAN OFFICER AT NAPOLEON STATE BANK. ON AUGUST 13, 1983, JOE MARRIED VALORIE KAY STUCKER IN MILLHOUSEN, INDIANA AND THEY HAVE TWO SONS. RYAN JOSEPH WAS BORN SEPTEMBER 4, 1986 AND JEREMY ADAM WAS BORN JUNE 28, 1990 BOTH IN COLUMBUS, INDIANA. THEY RESIDE AT 3130 E. COUNTY ROAD 300 S., GREENSBURG, INDIANA.

LINDA SUE (MOORMAN) ECKEL, JULY 3, 1962

LINDA WAS BORN IN GREENSBURG, INDIANA THE DAUGHTER OF EILEEN STELLA (NOBBE) AND CARL JOSEPH MOORMAN. SHE GRADUATED FROM SOUTH DECATUR HIGH SCHOOL IN 1980. LINDA CURRENTLY IS A SHIFT SUPERVISOR AT A&W RESTAURANT. ON OCTOBER 2, 1982, SHE MARRIED RONALD LEWIS ECKEL IN MILLHOUSEN, INDIANA AND THEY HAVE TWO CHILDREN. BRANDI LYNN WAS BORN AUGUST 7, 1985 IN GREENSBURG, INDIANA AND RANDY ALAN WAS BORN NOVEMBER 4, 1987 IN COLUMBUS, INDIANA. THEY RESIDE AT 602 S. IRELAND, GREENSBURG, INDIANA.

CAROL ANN MOORMAN, MARCH 25, 1964

CAROL WAS BORN IN GREENSBURG, INDIANA THE DAUGHTER OF EILEEN STELLA (NOBBE) AND CARL JOSEPH MOORMAN. SHE GRADUATED FROM SOUTH DECATUR HIGH SCHOOL IN 1982 AND MARION COLLEGE, INDIANAPOLIS IN 1986 MAJORING IN MATH EDUCATION. CAROL CURRENTLY IS A MATH TEACHER AT SOUTH DECATUR HIGH SCHOOL AND IS PLANNING A NOVEMBER, 1993 WEDDING TO SAM KOESTER.

THOMAS WILLIAM MOORMAN, AUGUST 1, 1965

TOM WAS BORN IN GREENSBURG, INDIANA, THE SON OF EILEEN STELLA (NOBBE) AND CARL JOSEPH MOORMAN. HE GRADUATED FROM SOUTH DECATUR HIGH SCHOOL IN 1983 AND LINCOLN TECHNICAL INSTITUTE IN 1984 MAJORING IN AUTO AND DIESEL MECHANICS. TOM CURRENTLY IS AN AUTO MECHANIC AT DON MEYER FORD. ON SEPTEMBER 23, 1989, TOM MARRIED BETH VOLK IN NAPOLEON, INDIANA. THEY RESIDE AT 4130 E. STATE ROAD 46, GREENSBURG, INDIANA.

ALLAN LOUIS MOORMAN, AUGUST 3, 1967 - SEPTEMBER 20, 1967

ALLAN WAS BORN IN GREENSBURG, INDIANA, THE SON OF EILEEN STELLA (NOBBE) AND CARL JOSEPH MOORMAN.

GENE ALLAN MOORMAN, JUNE 25, 1970

GENE WAS BORN IN GREENSBURG, INDIANA, THE SON OF EILEEN STELLA (NOBBE) AND CARL JOSEPH MOORMAN. HE GRADUATED FROM SOUTH DECATUR HIGH SCHOOL IN 1988. GENE CURRENTLY IS EMPLOYED AS A WELDER WITH HILLENBRAND INDUSTRIES AND ALSO HELPS HIS FATHER WORK ON THE FARM.

DONNA MARIE MOORMAN, DECEMBER 13, 1971

DONNA WAS BORN IN GREENSBURG, INDIANA, THE DAUGHTER OF EILEEN STELLA (NOBBE) AND CARL JOSEPH MOORMAN. SHE GRADUATED FROM SOUTH DECATUR HIGH SCHOOL IN 1990. DONNA CURRENTLY IS A JUNIOR AT MARIAN COLLEGE, INDIANAPOLIS MAJORING IN EARLY CHILDHOOD DEVELOPMENT.

LOUIS MENKEDICK

Louis was born Sept 25, 1895, in Millhousen Indiana. He married Elizabeth Parr, she was born Dec. 1, 1897, and died Feb. 17, 1946. Louis died March 27, 1956, in Kentucky; that is where he is buried. They had two children; Mary Jane born March 18, 1922 and died a few days later on March 23, 1922. Thelma born Nov. 12, 1923. Louis second wife was Mary (Schwerling) Humphrey born Jan. 1909 and died June 8, 1976. Thelma married John Crawley July 9, 1946, he was born Dec. 8, 1925. They had two children John (Jack) Lewis born Nov. 20, 1951. He married Carol Fry July 20, 1973. They had two children Gennie Eileen born Nov. 10, 1980. Michelle born Sept. 25, 1988.

Kathleen Elizabeth born Jan. 17, 1955. She married William Liable they had one son. Ion born Nov. 28, 1975, she divorced. Kathleen married Ron Farren one son Keth Wayne born Feb. 4, 1989.

EILEEN THERESIA MOORMAN

Eileen born July 19, 1935. She married Cyril Paul Schebler June 4, 1958, he was born Jan. 8, 1933. They had five children.

Robert Paul born May 13, 1959, he married Donna C. Larmann July 9, 1983, she was born Nov. 20, 1963. They had two children; David Paul born Aug. 29, 1984; Keith Alen born March 30, 1987.

Michael Charles born Feb. 27, 1961. He died in an auto accident less than two miles from home on April 25, 1982.

Gary Louis born March 8, 1962. He married Anne Mack Sept. 17, 1988, she was born April 6, 1964. They have one child; Jacob Michael James born Oct. 11, 1992.

Cheryl Ann born Jan. 18, 1963. She was born less than two days after her Grandma Schebler died. She married Donald John Baechle on March 5, 1983. He was born Dec. 22, 1960. They have three children; Joshua Michael born May 14, 1983; Erica Lynn born April 4, 1986; Justin Matthew born Nov. 29, 1989.

Timothy Joseph born April 5, 1965.

LAWRENCE AND CATHERINE(MENKEDICK) DUERSTOCK

Catherine Menkedick was born on feb. 15,1897 on the family farm near Millhousen in Decatur Co. Indiana. She was the daughter of Joseph Menkedick and Mary(Hessler) Menkedick. She was one of seven children: Theresa(Moorman), Louis, Catherine(Duerstock), Henry, William, Joseph, Anna.

Her family attended the Immaculate conception church at Millhousen. She attended the Catholic school at Millhousen also.

Catherine was married to Lawrence Duerstock on Nov.19,1919, at Millhousen, In. at the Immaculate conception church, Millhousen. Lawrence was born on April 11,1889.

Catherine and Lawrence Duerstock were the parents of eight children: Margaret(Bedel), Norbert, Kenneth, Helen(Tebbe), Rita (Young), Urb, Vincent, Cyril.

Catherine(Menkedick)Duerstock passed away on Jan. 28,1951. Lawrence Duerstock passed away on Feb. 2,1961.

CHILDREN OF CATHERINE AND LAWRENCE DUERSTOCK:

1.MARGARET DUERSTOCK WAS BORN ON AUG. 24,1920 AT Decatur Co. In. SHE WAS MARRIED TO Edmund DEDAL ON Aug. 21,1946 AT Millhousen. EDMUND WAS BORN ON MAY 10,1917. THEY WERE THE PARENTS OF FOUR CHILDREN. 1. Mary Martha Bedal was born on May 13,1948. He was married on July 26,1969 to Ronald Laker b/Nov. 18,1947. they were the parents of three children(Craig Laker b/July 18,1970, Alicia Laker b/July22, 1972, Kristyn Laker b/Sept.25,1981.) 2. Steve Bedal was born on Feb. 12,1952. He was married on June 7,1980 to Sharon Steingruber b/May 1,1954. They had two children (Mathew Bedal b/March 133,1981, Renee Bedal Oct. 20,1983) 3. David Bedal was born on April 21,1954. He was married on July 7,1977 to Linda Decker b/Sept.7,1955. They had three children(Michael Bedel b/March 18,1981, Gregory Bedal b/March 29,1983, Bradly Bedel b/July 14,1993.) 4. Arthur Bedel was born on March 21,1956. He was married on May 29,1982 to Treva Mullins b/June 5,1958.

2.NORBERT DUERSTOCK WAS BORN ON April 18,1923 HE WAS MARRIED TO RUTH KORTZENDERF, ON AUG. 6,1958. RUTH WAS BORN ON JAN. 13,1933. THEY WERE THE PARENTS OF TWO CHILDREN. 1. Wayne Duerstock was born on Aug.27, 1959. He was married on Aug.6,1983 to Misti Rollins b/March 8, 1964. They had three children.(Eric and Lindsay Duerstock b/ Jan. 2,1987 and Dustin Duerstock b/Feb.26,1988. 2.Mark Duerstock was born on Oct. 1,1960. He was married to Lisa McCreary b/Sept.19,1966, on Oct. 18,1986. they have a child Kurk Duerstock b/Feb.26,1988. 3.Kieth Duerstock was born on June 18,1969. He is to be married on Oct.2,1993 to Angela Brown.

3.KENNETH DUERSTOCK WAS BORN ON NOV. 21,1924. HE WAS MARRIED TO CAROLINE KLEINE ON AUG. 25,1951. CAROLINE WAS BORN ON JUNE 16, 1927. THEY WERE THE PARENTS OF FOUR CHILDREN. 1. Carol Duerstock was born on Nov.20,1954. She was married on Aug.5,1978 to Paul Cielsielski b/Aug.31,1958. They had three children(Heather Cielsielski Jan.1,1979, Danielle Cielsielski b/June3,1981, Gregory Cielsielski b/Nov.27,1982.) 2.Alice Duerstock was born on Dec.12,1955. She was married on Sept.8,1979 to Tom Schwegman b/April 7,1953. They were the parents of two children(Carolina Schwegman b/Dec.23,1980, Benjamin Schwegman b/May 19,1983.) 3.Theresa Duerstock was born on Dec.23,1958. She was married on Aug.12,1978 to Joe Dickman b/ Dec.5,1958. They were the parents of two children(Crystal Dickman b/Jan.21,1983, Theodore Dickman b/Sept.18,1985. 4.Rose Duerstock was born on March 26,1962. She was married on Oct.3,1981 to Bill Hountz b/July 26,1959. They were the parents of three children(Amanda Hountz b/Oct.10,1984, Michael Hountz b/July 27,1986, Kyle Hountz b/ Nov.15,1989.

3.HELEN DUERSTOCK WAS BORN ON NOV. 6,1926. SHE WAS MARRIED TO GERALD TEBBE ON SEPT 18,1952. GERALD WAS BORN ON FEB. 3,1939. THEY WERE THE PARENTS OF FOUR CHILDREN. 1. Betty Tebbe was born on Jan. 3,1958. She was married on April 8, 1989 to Christodoulou Costos b/Jan.26,1947. They had a child Kyle Jennings Costos b/July 4,1981. 2.Diane Tebbe was born on Sept. 6,1956. She was

married on March 22,1986 to Ernest(Bud) Eubanks b/Sept.16,1940. 3.Karen Tebbe was born on Nov.6,1956. She was married on Sept.24,1983 to Mike Foytek b/July9,1957. two children (David Foytek b/Dec.15,1986, George Foytek b/Feb.1,1990.) 4.Jane Tebbe was born on Dec.2,1961. She was married on Sept. 21,1985 to Mike Schmelya b/Aug.28,1958. (a child George Schemelya b/Aug.26, 1990.)

4.RITA DUERSTOCK WAS BORN ON JUNE 26,1928. SHE WAS MARRIED TO ALFRED YOUNG ON JUNE 15, 1949. ALFRED WAS BORN ON FEB. 3,1925. THEY WERE THE PARENTS OF FOUR CHILDREN. 1.Larry Young was born on Nov.2,1950. He was married on Sept.9,1978 to Pam Crank b/Dec.9,1956. they have two children(Leslie Young b/May 16,1979, Michael Young b/May 15,1981.) 2.Janice Young was born on Jan/9,1953. She was married on Sep.6, 1980 to Kenneth Fry . They had one child, Amy Fry b/Feb.27,1986. 3. Dale Young was born on May 31,1956. He was married on Sep.18, 1976 to Debbie Shafer b/Jan.22,1956.They had three children Missy Young b/Aug.23,1975;Lisa Young b/Jan.27,1977;Theresa Young b/Sept.13,1985. 4. Nancy Young was born on May 16,1960. She was married on Sept.11,1982 to Bob Obermeyer b/Nov.9,1959, they had two children; Brain Obermeyer b/Nov.7,1986-d/Nov.25,1988; Joshua Obermeyer b/Sept.20,1990.

5.URBAN DUERSTOCK WAS BORN JAN. 10,1931. HE WAS MARRIED JOANN RETHLAKE ON AUG 24,1955. THEY WERE THE PARENTS OF THREE CHILDREN. 1.Donald Duerstock was born Sept.17,1956. He was married on July 8,1978 to Jean Powers b/Dec.7,1957. They had two children Kristina Duerstock b/ July 1,1981;Jeffrey Duerstock b/Jan.4,1983. 2.Debra Duerstock was born on Sept.3,1957, she was married on June 3,1978 to James Schoettmer b/may 5, 1955. They had three children, Eric Schoettmer b/March 13,1981;Brian Schoettmer b/Feb.10,1984; Breanne.Schoettmer b/Aug.25,1987. 3.Linda Duerstock was born on Dec.15,1960. She was married on May 26,1979 to Donald Lecher b/ Sept.20,1960. They had Two children; Stephanie Lecher b/Oct.5, 1979; Melanie Lecher b/Aug.2,1983.

6.VINCENT DUERSTOCK WAS BORN ON JAN. 4,1933. HE WAS MARRIED TO ANN FORTHEFER ON JUNE 29,1957. ANN WAS BORN ON JULY 25,1954. THEY WERE THE PARENTS OF FOUR CHILDREN. 1.James Duerstock was born March 14,1958.He was married on June 12,1982 to Stephanie Wells b/March 27,1958. They had two children; Christine Duerstock b/March 30,1986; Laura Duerstock b/Nov.25,1983. 2. Donna Duerstock was born April 22,1959. She was married on April 7,1979, to Grant Holder b/may 10 1956. They had three children; Kimberly Holder b/Nov. 5,1980; William Holder b/ May 5, 1984; Martina Holder b/Dec.2,1986. 3.Richard Duerstock was born Aug.19,1961. He was married on Nov.24,1984 to Shona Kay Bausback b/may 27,1963. (Ruby Agular b/June 19,1991.) 4. Wanda Duerstock was born on April 19,1963. She was married on July 6,1985 to John Stake b/Nov.29,1956. They had two children; Jason Rubenstein b/ April 24,1982; Patrick Stake b/March 15,1988.

7.CYRIL DUERSTOCK WAS BORN ON MARCH 4,1937. HE WAS MARRIED TO RITA THOLE ON JUNE 2, 1962. RITA WAS BORN ON DEC. 21,1942. THEY WERE THE PARENTS OF TWO CHILDREN. 1.Kevin Duerstock was born on Aug.14,1963. He was married on June 27,1987 to Cathy Schoettmer b/Dec.23,1963. They had one child; Kristen Duerstock b/June 12,1990. 2.Michael Duerstock was born on Dec.13,1964. He was married on April 16,1988 to Joan Obermeyer b/Nov.17,1966. They had two children; Natasha Duerstock b/May 19,1989; Travis Duerstock b/July17,1990.

8. MARVIN DUERSTOCK WAS BORN ON JUNE 2, 1940. HE WAS MARRIED ON NOV. 7,1964, TO SARAH CARMACK. SARAH WAS BORN ON FEB. 13, 1940. THEY WERE THE PARENTS OF ONE CHILD. 1.Gregory Duerstock b/Jan. 14,1967.He was married on Sept.5,1992 to Mary Beth Witt b/ Jan. 24, 1969.

DALE AND MARILEE(RAY) MENKEDICK

Dale Menkedick was born on April 20, 1932, at home at his parents farm in Decatur County. He was the son of William and Helen(Drapping) Menkedick. He was one of two children. His sister Irene married Clarence Wenning.

Dale grew up on his parents farm in Decatur Co. In. near slabtown. He attended country school, then later he attended and graduated from Greensburg school.

He was in the army during the Korean War at Fort Knox, Ky., May 1953 to May 1955.

Dale Menkedick was married to Marilee Ray on July 4, 1953 at the St. Mary's Catholic church rectory in Greensburg, In. in Decatur County.

Marilee(Ray) Menkedick was born on March 27, 1935 at the Greensburg Hospital, in Decatur Co. Indiana, the daughter of Maurice and Pearl(Thrasher) Ray. She grew up at Kingston, In. in Decatur County. She was one of four children: Bob, Marilee, Donna, David, and Danny. She attended school at Clarksburg and graduated in 1953.

Dale and Marilee Menkedick lived on the family farm in Decatur county near slabtown. Dale was a farmer, but in the 1960's he purchased 3 semi trucks which he also drove himself. He traveled a great deal. It was on one of these trips that he was involved in a terrible accident and was killed, on Sept. 7, 1976. He is buried at Rossburg Cemetary in Decatur County, near New Point.

Dale and Merilee Menkedick were the parents of four children: Nancy, Larry, Paul, John. Dale had another son by a different, relationship, Jimmy Dale Menkedick.

Merilee was a member of the New Point Christian Church at New Point, In. in Decatur Co. She remained on the farm for a number of years before passing it on to her son, who took over the running of the family farm. Merilee presently resides at Harrison, Ohio.

children of Dale and Marilee Menkedick:

1. Nancy Menkedick was born on Dec. 30, 1954. She attended New Point grade school and North Decatur High school. She was married to Daniel Martin in June 1973. They were divorced, she remarried too Harlem McKenzie in Sept. 1988. She lives in Decatur County Indiana, She is a member of The First Church of Christ, of Greensburg.

She has two children: Stephanie Martin born Nov. 11, 1974 and Patricia Martin born March 17, 1977. Stephanie graduated from North Decatur High School in 1993 and is engaged to be married to Andrew Cronin. Patricia will graduate from North Decatur in 1995.

2. Larry Dale Menkedick was born on Jan. 24, 1957. He attended the New Point grade school and graduated from North Decatur High school in 1975. He was married to Cindy Marie Huffmeyer on July 29, 1977. Cindy was born on June 17, 1958. They are the parents of two children: Gregory born Sept. 6, 1979 and Mathew born Sept. 24, 1981.

Larry purchased the family farm in Decatur County from his mother, Marilee in May 1983 and currently resides there, where he also farms the approximately 76 acres. Larry and Cindy are members of the Napoleon St. John Lutherin Church.

3. Paul Menkedick was born on July 26, 1955. He attended the New Point Grade school and the North Decatur High school, graduating in 1976. He was married to Patricia (Russel) Adams. Paul adopted Patty's daughter, Leasa Menkedick. Paul currently lives at Lake Santee. He is employed at Hill-Rom in Batesville.

4. John Menkedick was born on Dec. 3, 1962. He attended the New Point Grade school and North Decatur High School. He graduated in 1980. He currently lives at New Point, Indiana in Decatur Co. and attends the New Point Christian Church. He is employed at Geocom in Greensburg. He has one son, Tyler John, born on July 10, 1992.

JOSEPH MENKEDICK

Joseph was born Nov. 9, 1905. He married Gertrude Weimer. She was born Aug. 5, 1914. They had one child. Gertrude died in child birth Feb. 20, 1940. Joseph then married Rose Schoettmer. She was born April 17, 1910. Joseph died Dec. 10, 1963. Rose died Aug. 18, 1964. They had one child.

Thomas Menkedick born Feb. 12, 1940. He married Nancy Louise Cathy Aug. 18, 1960. She was born Oct. 16, 1942. They had four children. James Joseph, Timothy Alan and twins Ronnie and Jonnie born July 2, 1967 They died at birth.

James was born June 16, 1961. He married Kim Wonnona Foster Boling Dec. 11, 1984. She was born July 19, 1967. She had one child Norman Ray Boling born May 20, 1983. James adopted Norman April of 1984. They had three children. James Cory JULY 26, 1985.

Rachel Dawn born Sept. 17, 1987.

Tyler Jay born Jan. 25, 1991.

Timothy was born Jan. 26, 1964. He married Robin Renee Jenkins She was born June 6, 1966. She had one child. Kegan Alan. He was born May 21, 1985. Timothy adopted him in May of 1990. Timothy and Robin were divorced. He then married Leigh Ann Homan Huber Jan. 12, 1990. She was born Oct. 5, 1967. She had one child. Jonathan Ryan Earl Homan born Jan. 15, 1983. Timothy adopted him May 5, 1990.

Gertrude Mary Menkedick born JULY 31, 1943. She married Francis Arthur Tevis Jan. 15, 1966. He was born June 19, 1941. They had three children.

Catherine Ann born Sept. 27, 1971.

Jennifer Lynn born May 25, 1976.

Joseph Francis born May 17, 1977

FRANK AND MARY (RUTT) HESSLER

- | | | | | | | | | | | | | |
|--|---|--|--|--|---|---|---|--|--|--|--|--|
| <p>1. <u>Philomena</u>
b/1894
m/ Herman
Veerkamp
Children:
1. Cathy
m/ Joe
Schultz
a. Jerome
b. Judith
c. Joyce
d. Janet
e. Jeanie
2. Rita
m/ Al Thilges
a. Robert
b. Betty
c. Richard
e. Jean
f. Sandra
J. Herman (Ed)
4. Horbert
m/ Rita Dohz
a. Linda Marie
b. Donald Joe
5. Stanley
(Francis)
6. Mary Martha
m/ Robert Laughter
a. Phyllis
b. Catherine
c. Sharon
7. Cyril
m/ Darlene Jent
a. Susan Kee
b. Karen
c. Nancy
8. Ralph Joe
m/ Laura Kabage
a. Katherine
b. Michael
c. Charles
a. Jodel
b. Anthony
c. Jennelle
d. Derrick
12. Barb
m/ Paul Slowski
a. Theresa
b. Jeffery
c. Michael
d. Dennis
e. David
f. James
g. Sheryl
9. Mary
m/ Tony Slowski
a. Thomas
b. Eugene
c. Peggy
d. Terry
e. Ronnie
f. Sussei</p> | <p>2. <u>Francis</u>
m/ Theresa
Hardebeck
Children:
1. Margie
(Margaret)
single
2. Bertha
Marie m/
James
3. Dilks
a. Jo Ann
b. Cathy
c. Billy
James</p> <p>(cont;)
10. Margaret
m/ Robert Hiching
a. Gary
b. Robert
c. Helen
d. Dale
11. Tony
m/ Ethel Koeings
a. Jodel
b. Anthony
c. Jennelle
d. Derrick</p> | <p>3. <u>Mary</u>
m/ Harry
Dwenger
Children:
1. Kathy
2. Esther
3. Rosie
4. Ruth
5. Annie
6. Dick
7. Betty
8. Leonard
9. Mary
Ellen
10. Ed</p> <p>(see Mary &
Harry graph)</p> | <p>4. <u>Matilda</u>
m/ Clem
Stuhrenburg
Children:
1. Mary Agnes
m/ Albert
Husske
a. Denise
a. Kathleen
c. Mary Jean
d. Luann
2. Bernard
m/ Pat Kusske
b. Karen
c. Michael
d. Keith
e. Donald
f. Alicia
g. Tracy
3. Dorothy
m/ Richard
Husske
a. Richard
b. Christopher
4. Vincent
m/ Mary Ellen
Wilson
a. Denis
b. Kevin
c. Bernard
e. Deanne
f. Steven
5. Maurice
m/ Virginia
Gasser
a. Susan
b. Andrew
c. James
d. Carol
e. Lynda
6. Mary Ellen
m/ Henry
Rathouz
a. Sharon
b. Barbra
7. Lucille
m/ Tom Peterson
8. Alvin
Silbough
m/ Judith
a. Debra
b. Nancy
c. Robert
d. John
9. Marie
10. Beth
m/ Lowell
Lowler
a. Theresa
b. Rebecca
11. Mary</p> | <p>5. <u>Cecilia</u>
m/ Bernard
Harpring
Children:
1. Mary
Joan m/
Leonard
Schoettmer
a. Stephen
b. Stanley
c. Joyce
d. Leonard
e. Charles
f. Mary Ann
g. Patrick
7. Ed Francis
m/ Thelma
Lecher
a. David
b. Jean
c. Samuel
d. John
e. Susan
3. Irma
b/ 1931
4. Lois
m/ Alis
Laudick
a. Mary Beth
b. Kimberly
c. Greg
5. Luella
a. Brenda
b. Wicklas
d. Bernard
6. Eluepa
m/ Harvey
Wessel
a. Domen
b. Nathan
c. Matthew
d. Monica
e. Alyis
f. Sheila
7. Bernard
m/ Sharon
Peters
a. Jay
b. Tracy
c. Gina
12. Tonya
8. Vernon
m/ Diane
Williams
a. Owen
b. Todd
c. Mark
e. Perry</p> | <p>6. <u>Rose</u>
Sister
Joseph
Marie</p> | <p>7. <u>Clara</u>
m/ George
Hadermend
Children:
1. George Jr.
m/ Pat Lauer
a. Paul
b. Karl
c. David
2. Justin
3. Rose Marie
m/ 4 divorced
Edward Baur
a. Annie
b. John
4. Jane
m/ Larry
(Steve) Reed
5. Edna Ann
m/ James
Cardinal
a. Theresa
b. Scott
6. Albert
m/ Cheryl Holt
a. Michelle
b. Kim
c. Matthew
d. George
e. Adam
7. John
m/ Bonita White
divorced;
8. Esther
m/ Marty Ruehl
a. Jessica
b. Janel
c. Martin</p> | <p>8. <u>Joseph</u>
m/ Bernice
Wenning
Children:
1. Ken
m/ Carol May
a. Barry
b. Julie
2. Judith
b/ 1939
d/ 1961
3. David
m/ Sharon
Wilson
a. David
b. Sean
4. Mary Ann
m/ Neil
Hindman
a. Karyn
b. Tricia
c. Jennifer
d. Suzanne
5. Robert
m/ Bernice
Maxwell
a. Ronald
b. Stephen</p> | <p>9. <u>Gertrude</u>
(Bobbie)
m/ Glen Koors
Children
1. James
b/ 6/1/21/1945
m/ Marieda
Boeing
a. David
b. Rick
c. Daryl
2. Sylvester
b/ Sept. 1933
d/ Oct. 1934
3. Paul
b/ 4/1934
4. Carl
m/ Julie
Scheidler
a. Jannice
b. Brian
5. Don
m/ Geraldine
Saver
a. Patricia
b. Theresa
c. Julianne
d. Joseph
e. Christopher
f. Kathleen
6. Louis
m/ Rita
Harpring
a. Rose d/ 1980
b. Kevin
c. Cletus
d. Karen d/ 1977
e. Brenda</p> | <p>10. <u>Christina</u>
m/ Alvin Cord
Children
1. Francis
b/ 6/1/21/1945
2. Deloris
m/ Doug Flint
2nd m/ Kevin Gay
3rd m/ Mike Rogg
a. Nathan Flint
b. Rob Flint
3. Carolyn
1st m/ Charles Baker
2nd m/ Wm. Scheidler
a. Charles Baker</p> | <p>11. <u>Hildegarda</u>
b/ 1913 d/ 1916
pneumonia</p> | <p>12. <u>Lawrence</u>
b/ 1914 d/ 1916
pneumonia</p> | <p>13. <u>Aloyyoidus</u>
b/ 1914 d/ 1915
4 1/2 months</p> <p>^ TWINS ^</p> <p>14. <u>Helen (Tonnie)</u>
Sister Margaret
Mary</p> <p>15. <u>Margaret Agnes</u>
b/ 1918 d/ 1918
died at the age of
3 weeks</p> |
|--|---|--|--|--|---|---|---|--|--|--|--|--|

Frank John and Mary(Rutt) Hessler

Franz Johanna Hessler was born on March 25, 1871 in Decatur Co. Indiana, near the small town of Millhousen.

He was the son of Adam John Hessler, born on Feb. 17, 1840 in Indiana. Adam was the son of John and Anna Maria(Neese) Hessler.

Frank's mother was Catherine (Stahl) Hessler, born on Feb. 6, 1845 in Germany. Catherine was the daughter of G. Jacob and Catherine (Grimes) Stahl. The Hesslers were devout Catholics.

Frank was one of eight children. He had one sister, Mary Hessler(Menkedick), and six brothers, John Hessler[died young], George(Bob) Hessler, Adam(Ed)John Hessler, Gerhart Hessler, Henry[died young], Andrew Hessler. They were of German decent and still spoke the German language predominantly. Mary Hessler their daughter said that she spoke only German until she began going to school, where she learned English. Mary said that after coming home from school one day she was speaking English, and her father, hearing her, said "We are German, and at home you are to speak German, at school you do what they tell you to do, but at home you do as I say. (This could be possibly that he may not have understood much English at this time himself.)

The Hessler family were farmers. They owned land in Decatur Co. on the East end fr. NW Qtrs. 29-9-10 also the SW of SE QTR. 20-9-10, NE. QTR 29-9-10

When Frank was a young boy he only went to school when there was bad weather and they were unable to work on the farm.

His daughter Mary told of one time [told to her by her father] when he had been on his horse, riding it in the winter to guide the horse while pulling logs out of the woods. His legs had gotten so cold they had nearly frozen and he had to be lifted from the horse and carried into the house to thaw out. Frank's father was a logger, who bought up virgin forest; and cut and sold lumber. After logging it he would sell the land also. Frank had said that he would often have to run up and down the hills to keep warm when he was working with the logs.

Frank's mother Catherine (Stahl) Hessler was originally from the nearby town of Napoleon Indiana, in Ripley County. This is probably the source through which Frank met his future bride.

Mary Anna Rutt, was born on July 15, 1874 in Cinn. Ohio. (Hamilton Co.) She was the daughter of Matthias Rutt, born Dec. 1, 1841 in Germany, and Philomena (Thole)Rutt, born on Dec. 4, 1851 in Cinn. Ohio. Mary's Parents lived with her Uncle Joe Thole, and had moved from Cinn. Ohio, to Napoleon, Indiana with them when Mary was about 13 years old. This would be around 1887.

Frank John Hessler, and Mary Anna Rutt, were married on Sept. 21, 1897, at The Saint Maurice Catholic Church at Napoleon, Indiana.

They moved into a small log cabin on the Hessler farm which had originally been built by Frank's grandfather John Hessler, and possibly by his great grandfather Conrad Hessler also, as the original deed to the land appears to show co-ownership in the purchase in 1839.

Frank and Mary Hessler were to be the parents of 15 children. They were members of the Millhousen Catholic church. Their first child, Philomena, [probably named after Mary's mother] was born on Jan. 5, 1899. Their second child was a son, Francis, was born on May 11, 1900. Their third child, Mary Cecilia, was born on Nov. 17, 1901. in the log cabin of their ancestors.

The log cabin was of fair size for the day. It had four rooms downstairs, and two rooms upstairs. On the first floor were the kitchen, which was the mainly used room of the house. The dining room which was mostly used when there were guests. The other two rooms were bedrooms. One was Frank and Mary's, and the other was occupied by Mary's mother and father, Matthias and Philomena. Upstairs the two rooms were separated by the stairs, with the girls' room on one side and the boys' room on

the other. On very cold nights the girls had a coal stove in their room for heat.

Log cabins were made from logs with mud chinking to block up the holes in between. After a while the mud would dry out and break up leaving holes in places. Sometimes on snowey nights when the wind blew very hard, they would wake up with snow on them.

It was around 1902, Mary's mother and father, Matthias and Philomena, (thole) Rutt, came to live with them at Millhousen. They helped with the children and the many chores on the farm.

In 1903 Frank's father, Adam Hessler passed away.

A transfer of land dated for Feb.14, 1903, directs the transfer of a parcel of land from Catherine Hessler to Frank Hessler as an heir to Adam Hessler. [bk.53] pt. N.E. 1/4 29-9-10 - 4.34 acres and pt. N.E. 1/4 29-9-10 - 9.9 acres, and 29-9-10 - 109 acres.

On Sept. 11, 1903, their fourth child, Matilda Hessler was born. Their fifth child was Cecilia Hessler, born on July 17, 1905, and their sixth child was Rose, born on Feb. 6. 1907, then Clara, born on April 24, 1908 their seventh. A little over a year later their eighth child, Joseph was born, on May 7, 1909. Their ninth child, a daughter, was born on Nov. 12, 1910, named Gertrude[nicknamed Bobbie]. Another daughter, Christine, was born on Dec. 12, 1911.

A daughter, Hildegard Hessler was born on March 31, 1913. Frank and Mary were blessed with twin sons, Lawrence and Aloysious, on Nov. 29, 1914. Aloysious, a sickly child from birth, had never been really well.

On April 16, 1915, when Aloysious was four and a half months old he became ill. Frank had gone into Greensburg to buy fertilizer, when Aloysious took a turn for the worse. Mary felt she needed to take him into Millhousen to see the doctor. Francis hitched up the horses. As the baby was fussy, Mary nursed him on the way in to town. When they arrived they were informed that the doctor was not in and they would have to wait. The doctors wife looked at the baby and he was dead, he had died in his mothers arms.[10:00 a.m.]

On October 3, 1916 their fourteenth child, Helen [nicknamed Tonnie], was born.

In that same month of October tragedy was to strike their family. Little Lawrence became sick with the pullmonary pneumonia. He was very ill. Mary had been up all night with him, as he had difficulty in breathing. The doctor had been in and out several times checking on him. Mary who between the new baby, and the sick child had not gotten any sleep. That morning, her daughter Mary Cecilia, who was fifteen years old at the time, volunteered to take care of Lawrency so she could get a little sleep.

Around 5:30 in the evening, the doctor arrived to check on him. Mary Cecilia held the small child in her arms as the doctor checked him. His breathing was slow and laborious. Mary's dress had a long row of buttons up it, which buttoned up to the neck of her dress. Little Lawrency reached up with his tiny fingers and played with the buttons as she held him.

Their Grandfather, Matthias Rutt, who lived with them remarked quietly as the doctor finished. "He's just about gone isn't he." The doctor shook his head in confirmation, "yes!".

Mary looked down at the sweet little face, the tiny hand, his little body which she held as he so laborously breathed. Anger rose up inside, how could they say such as thing, NO!, Lawrency couldn't die. That was a cruel thing to say, she was angry at them for saying it.

That day on Oct.20, 1916 at 5:30 p.m. little lawrency died in his sister Mary's arms. The little fingers which only a few minutes earlier had played with the buttons on her dress were now still and silent.

Little hildegarde, who was three and a half years old, lay sleeping at the time. Their father Frank became very upset, and asked that the doctor check Hildegarde

before he left because she was coughing a little also. The doctor checked her and passed it off casually.

"Oh, Frank he said, she's all right, your just upset about the baby."

When Hildegarde woke up from her nap the other children rushed to tell her. "Lawrency is dead, come see." The little child looked upon her little brother with all the understanding of death of a three year old, and stated, "Yup!, Lawrency's dead".

Little Hildegarde Hessler passed away early the next morning at 6:30 a.m., on Oct.21, 1916. The two tiny caskets were buried together in a single grave, at the Millhousen, Catholic church Cemetery.

Frank and Mary's fifteenth child, Margaret Agnes, was born on Jan.8,1918 at 1:30 a.m. She was never really healthy from birth, and she died on Jan.31, 1918 at 1:00 p.m. less than a month old.

Mary had been ill after the birth of Margaret Agnes, and after the baby's death she became ill and was confined to her bed for a year.

The Hessler children all had chores before school. They would feed the chickens and other animals in the morning, then they would walk to school. They attended Catholic school and had Mass first thing in the mornings. If the weather was really bad or rainy, their father(Frank) would hitch up the horses and drive them in.

After school they had their chores, Grandma (philomena), did most of the cooking and baking. The children helped mother with the cleaning and the laundry.

They all took baths on Saturday night. They carried water in and heated it on the wood stove. They had more than one stove. One cook stove, and two heating stoves.

The farmers all used horses for farming and their father, Frank, never owned an automobile. There were not many auto's around until 1917 or 1918 around Millhousen.

Their Grandmother(Philomena) worked very hard helping to care for the children, the house and the sewing, until around 1919 when she got arthritis in her knees and after that she sewed and patched and quilted.

The children picked lots of blackberries, they were canned and made into juices and jellies. They also canned meats. The children all helped in the garden. The boys tended the hogs, and the girls helped milk cows.

In the year of 1926, Frank and Mary moved into Millhousen, into a little three room house(Gone now), the Ruhl place. Franks brother Francis, when he married, moved into the little Hessler family log cabin. (also gone now, it burned in a fire) He took over running the family farm.

About nine monthes after they moved there the house was sold and then they moved to the Henningher place. Frank and Mary moved again, for the last time, into a large white house in Millhousen. This was until recently owned and occupied by Marie Monter, now owned by a Johanningman.

In June of 1923, Franks mother, Catherine(Stahl) Hessler died. Helen Hessler, was about six years old at the time. She remembered very little about the funeral, except that her mother and father were crying, and her fathers hands were shaking.

She had never seen her father like that and it scared her. She cried so much and so hard that they had to take her home instead of going to Aunt Mary Menkedick's for the day.

Mary's father Matthias Rutt, passed away on Sept. 7, 1927, at Millhousen, after an illness of only a few days and was buried in the Catholic Cemetary there.

Most of the grandchildren remember the house in Millhousen. A Granddaughter, Anna(Dwenger) McCullough, remembers at the house in Millhousen; the first room on the left is where grandma Philomena sat.

Anna, when visiting her Grandma Hessler, at about age five, would slide down the banister, and aunt Chris(Christine), would give them a small spanking. Great Grandma Philomena Rutt, would say, "Don't spank that child", and Anna would go in to her and

Great Grandma would put her arm around her.

Frank Hessler became ill and was unable to work. Around 1923, one day Frank Hessler was working, shoveling sand from the creek bed into the wagon. He appeared to have a stroke, and he just continued to keep shoveling sand onto the wagon until it was running off the other side. When he didn't come home for lunch his wife, Mary sent their son Francis to see what was wrong. He found his father still shoveling sand onto the overfull wagon. They had to shovel some of the sand off because the wagon was too heavy for the horses to pull.

He had problems with his legs, He had aquired a disease called elephantiasis, which "a horse recieved a bite from a mosquito which had recieved this from another mosquito, then this moaquito bites a person, he can give the person elephantiasis. He had an old horse on the farm who had this, (no cure). He also had a disease called Brights disease which gave him much trouble with his legs.

He was chairbound for years, and the grandchildren remember that he would sit in his chair holding his cane which he always carried. When they would run by playing he would reach out the cane and hook them around the neck and pull them to him. He being chair bound wanted to talk and visit with them, but they, being young, wanted to play. They would avoid the reach of his cane in future passes by his chair.

On Dec. 25, 1930, Frank John Hessler passed away. He was buried at the Millhousen Catholic Cemetery.

Great Grandmother Philomena, sang songs, mostly in German. In 1933, her mind failed, and she died on Dec. 1, 1935, and was buried beside Matthias in the Millhousen Cemm.

Mary(Rutt) Hessler broke up housekeeping around 1942, after the marriage of her daughter Christine on Aug 6, 1941, and her daughter Helen went into the convent on Aug. 30, 1941. She lived with her children, each for short periods of time until her mind began to fail her.

Her great granddaughter, Patty(MCcullough) Carson, remembers visiting with her when she was staying with Patty's grandmother, Mary Dwenger.

She always seemed to have a rosary in her hands. She was always so pleased to see the children, and she would smile and hug them very tightly, almost too tightly. For a while she would walk with a walker from her bed to the kitchen, but later she was always in bed when we came to visit.

Mary Hessler was a very religious and intelligent person and the childrens main support in religious learning.

Mary (Rutt) Hessler died on Aug. 3, 1962 at Decatur Co. Indiana. She was buried at the Millhousen Catholic Cemm.

Frank and Mary(Rutt) Hessler were the Parents of child:

1. Philomena b\1894- m\1\19\1921 to Herman Veercamp 12-child.
2. Francis b\1900 m\1\7\1926 to Theresa Hardebeck - 2 child.
3. Mary Cecilia b\1901 m\8\29\1923 to Harry Dwenger 10-child.
4. Matilda b\1903 m\2\5\1927 to Clem Stuhrenberg 11- child.
5. Cecilia b\1905 m\8\28\1926 to Bernard Harpring 8- child.
6. Rose b\1907 m\not married-- a nun-- sister Joseph Marie
7. Clara b\1908 m\2\15\1939 to George Naderman 8 - child.
8. Joseph b\1909 m\8\11\1937 to Bernice Wenning 5- child.
9. Gertrude(Bobbie) b\1910 m\2\26\1930 to Clem Koors 6- boys
10. Christine b\1911 m\8\6\1941 to Alvin Cord 2- child(adopted)
11. Hildegard b\1913 m\not married - died at age 3
12. Lawrence b\1914[twin] m\not married - died at age 2
13. Aloysious b\1914[twin] m\not married - died at age 4 1/2m.
14. Helen b\1916 m\not married --a nun--sister Margaret Mary
15. Margaret Agnes b\1918 m\not married - died at age 23



L to R: Frank Hessler, Rose, Carrie Thole,
Chris, Marie Monter, Helen, Cecilia Johanningman
L to R: Back row - Joe, Bobbie (Gertrude),
Al Thole, Clara, Harry Dwenger



Wedding Picture: Sep. 21, 1897
Frank & Mary (Rutt) Hessler

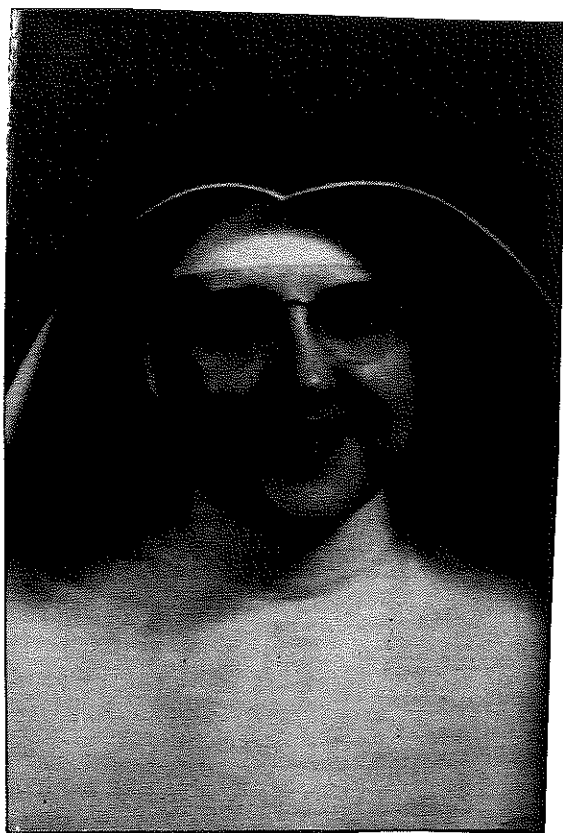

Helen (Tonnie) Hessler
Sister Margaret Mary
b/1916



Children of Frank & Mary Hessler
L to R: Clara; Philomena; Matilda
Cecilia; Joseph; Francis; Rose; Mary.
(taken in 1910)



Mary(Rutt)Hessler
wife of Frank Hessler
dau. of Matt & Philomena

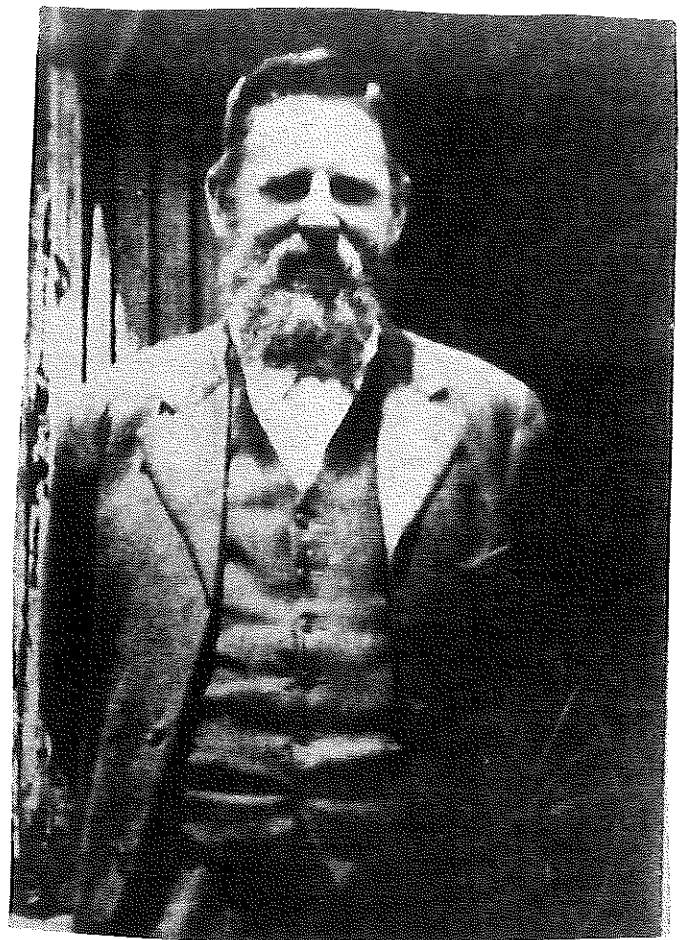

Frank J.Hessler
b/March 25,1871
son of Adam and Cath.



sitting:Mary(Rutt) Hessler
L to R:Mary Dwenger,Bill Martin,
Mike Martin, Ester Martin



Family of Frank and Mary(Rutt) Hessler
L to R: standing- Clara,Rose,Chris,Francis,
Mary,Philomena,Joe,Ceal,Bobby,Matilda.
sitting:Helen,Frank,Mary around 1922

HOME OF FRANK J. AND MARY (RUTT) HESSLER

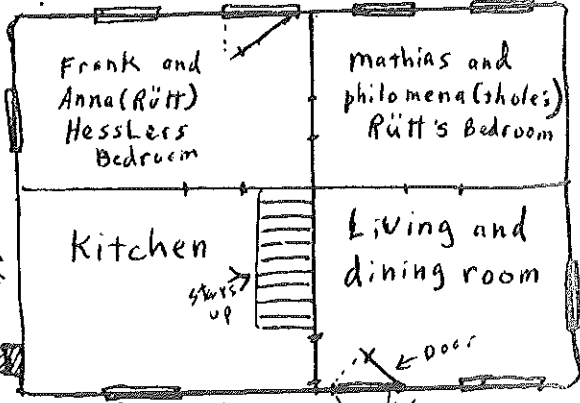
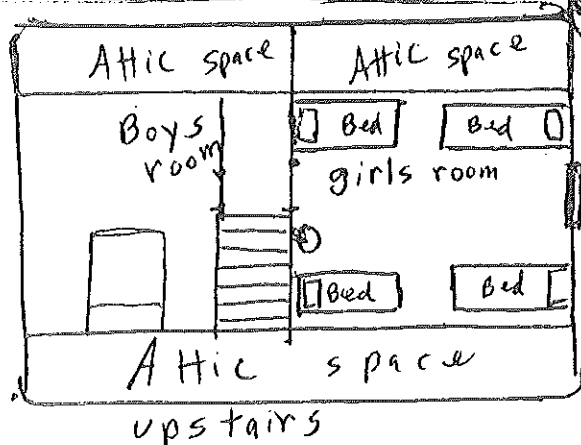
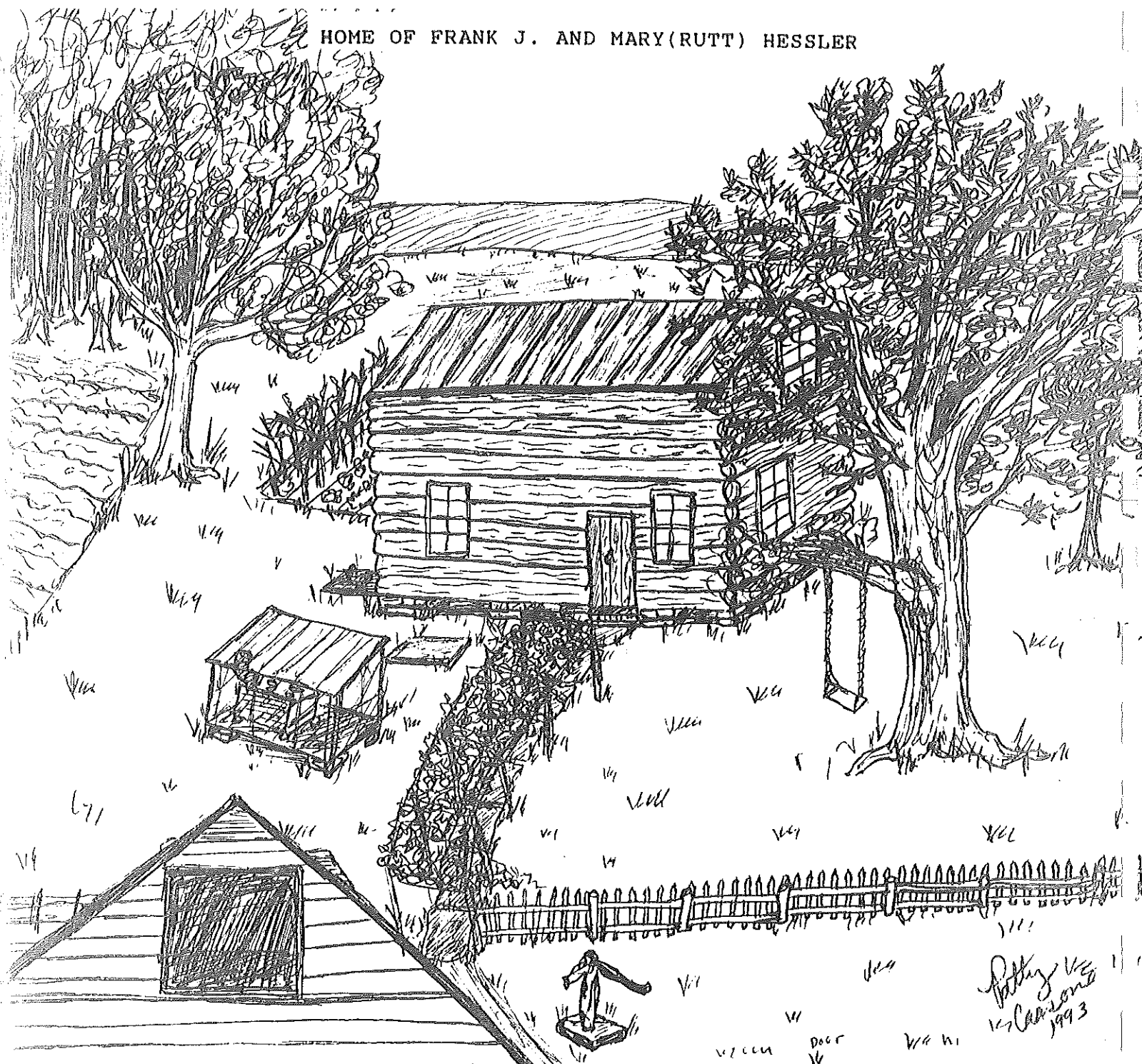

Down stairs - 1st Floor

always ate in the kitchen unless there was company

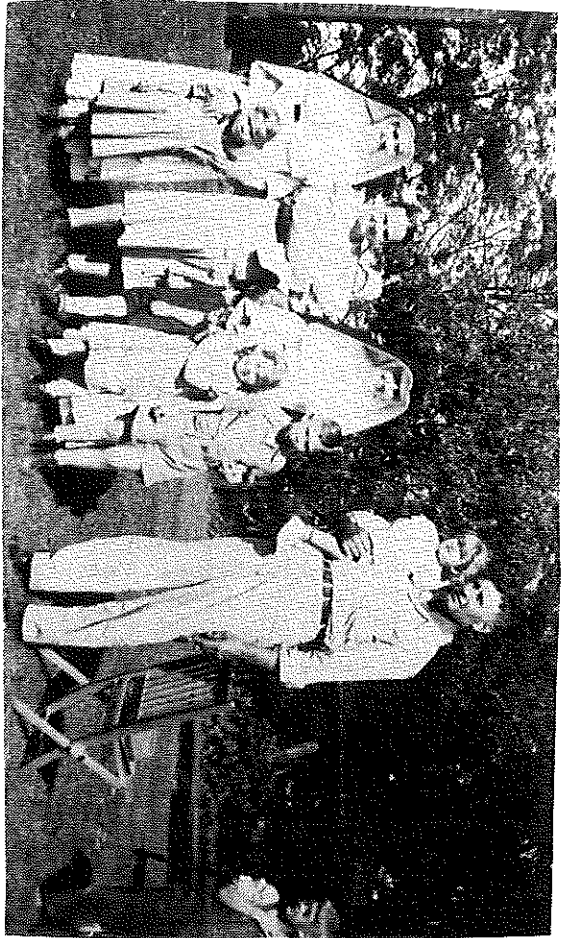

George and Clara(Hessler) Naderman Family
 L to R: Back: Helen(nun), Clara, Albert, Rose, Edna & Albert
 front: Janie, -----, Justin, Rose Marie, Junior,

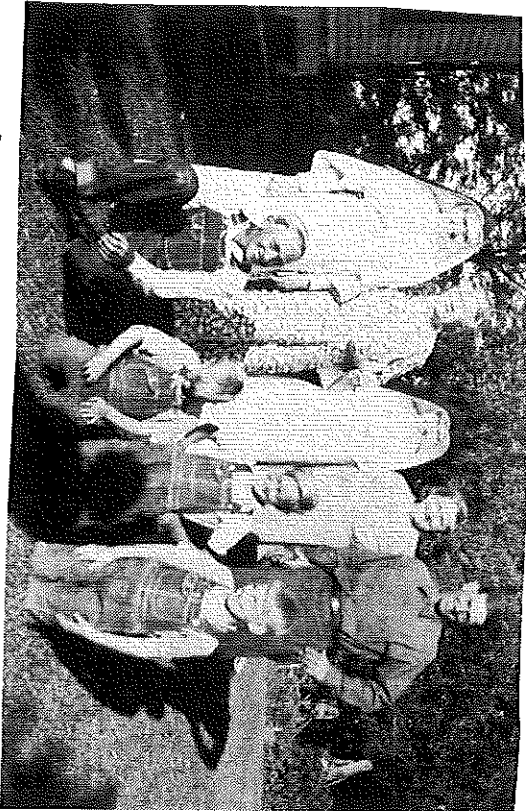

Clem and Gertrude(Bobbie Hessler) Koors family
 standing: Helen Hessler, Mary(Rutt), Rose Hessler,
 Gertrude Koors, Clem Koors
 sitting: James, Louis, Carl, Donald

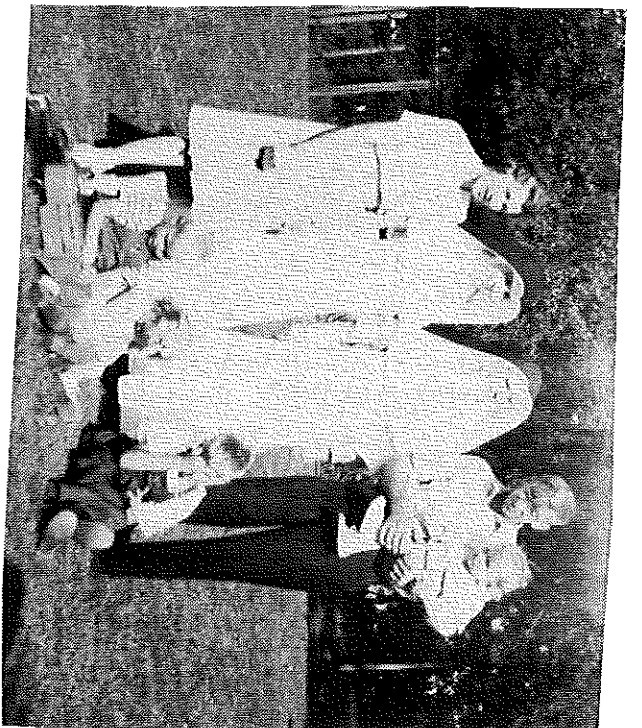

Joe and Bernice Hessler family
 standing: Bernice, Rose, Helen, Joe, Mary Ann
 sitting: David, Judy, Kenny

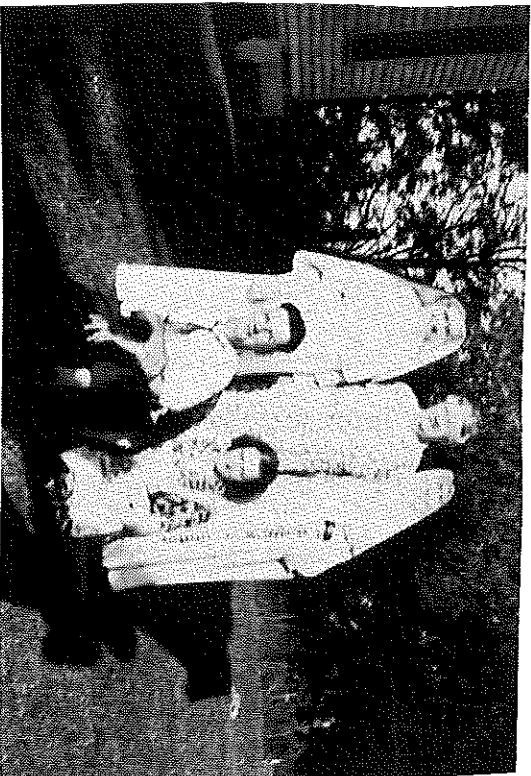

Alvin and Christine(Hessler) Cord family
 standing: Rose Hessler, Mary(Rutt)Hessler, Helen Hessler
 sitting: Alvin and Christine(Hessler) Cord

HERMAN AND PHILOMENA(HESSLER) VEERKAMP

Mary Catherine(Philomena) Hessler was born on Jan. 5,1899 at home on the family farm at Millhousen, Indiana. She was the daughter of Frank J. and Mary(Rutt) Hessler.

Philomena was one of 14 children:Philomena b/1894,Francis b/1900,Mary b/1901, Matilda b/1903, Cecilia b/1905, Rose b/1907, Clara b/1908, Joseph b/1909, Gertrude(Bobbie) b/1910, Christine b/1911, Hildegarde b/1913, Lawrence b/1914(twin), Aloysious b/1914, Helen b/1916, Margaret Agnes b/1918.

Philomena grew up on the Hessler family farm just outside the town of Millhousen. The family was Catholic and they attended the Immaculate Conception Catholic church in Millhousen, Indiana.

Philomena attended the Millhousen Catholic school in the town of Millhousen. The family were of German decent and still spoke German at home.

Philomena Hessler was married to Herman VeerKamp, on January 19,1921 at High Mass at the Immaculate Conception Catholic church in Millhousen, in Decatur County.

Herman George VeerKamp was born on May 14,1891 near Millhousen Indiana. He was the son of George Veerkamp and Catherine (Stuhrenberg) Veerkamp.

Herman and Philomena VeerKamp moved to Blooming Prairie, Minnesota.

Herman G. VeerKamp passed away on April 7,1987 Blooming Prarie, Minn. Philomena(Hessler) VeerKamp passed away on Feb.13,1983 at Blooming Praire, Minn.

Herman and Philomena(Hessler) VeerKamp were the parents of twelve children:

- 1.Katherine Marie Veerkamp, born Nov.25,1921. She married Joseph Schultz on Nov.25,1946.
- 2.Rita Matilda VeerKamp, born June 3,1923. She married Aloysious Thilges on Feb.13,1945.
- 3.Herman Edward Veerkamp, born Oct.13,1924. Died on April 9,1945 in W.W.II in Okinawa, killed by mortar fire of an enemy attack.
- 4.Norbert Bernard Veerkamp, born Oct.31,1926. He married Rita Dohr on June 24,1961.
- 5.Stanley Francis Veerkamp, born April 1,1928. He died from Cancer on Nov.1,1986.
- 6.Mary Martha Veekamp, born Aug.24,1929. She married Robert E. Vaughters on May 7,1953.
- 7.Cyril George VeerKamp, born March 18,1931. He married Darlene Violet Jante on July 13,1957.
- 8.Ralph Joseph Veerkamp, born Dec.1,1932. He married Laura Mae Kabage on Nov.27,1954.
- 9.Patricia Mary Veerkamp, born Sept.4,1934. She married Anthony Francis Slowinski on Sept.7,1953.
- 10.Margaret Ann Veerkamp, born Jan.10,1936. She married a Hitchings.
- 11.Alphonse Anthony Veerkamp, born June 13,1937 Ottoseu, Iowa.
- 12.Barbra Rose Veerkamp, born April 7,1941. She married a Slowinski.

JOSEPH & KATHERINE (VEERKAMP) SCHULTZ

Katherine Marie Veerkamp was born Nov.25,1921 in Webster County, Duncombe, IA. She was the daughter of Herman G.Veerkamp and Philomena Hessler Veerkamp. Herman George Veerkamp was born May 14,1891 near Millhousen, In. He passed away April 7,1987 at Blooming Prairie, MN. Philomena was born Jan.5,1899 near Millhousen, IN. She passed away Feb.13,1983 at Blooming Prairie. MN. Katherine was the eldest of 12 children as follows:

Katherine Marie (Veerkamp) Schultz	born	Nov.25,1921
Rita Matilda (Veerkamp) Thilges	born	June 3,1923
Herman Edward Veerkamp	born	Oct.13,1924
Norbert Bernard Veerkamp	born	Oct.31,1926
Stanislaus,Stanley Francis Veerkamp	born	Apr.1,1928
Mary Martha (Veerkamp) Vaughters	born	Aug.24,1929
Cyril George Veerkamp	born	Mar.18,1931
Raphael (Ralph) Joseph Veerkamp	born	Dec.1,1932
Patricia Mary (Veerkamp) Slowinski	born	Sep.4,1934
Margaret Ann (Veerkamp) Hitchings	born	Jan.10,1936
Alphonse Anthony Veerkamp	born	June 13,1937
Barbara Rose (Veerkamp) Slowinski	born	Apr.7,1941

Katherine married Joseph Sebastian Schultz Nov.25,1946 in Corpus Christi Church at Fort Dodge, IA. Joseph, son of Sebastian A. Schultz and Emma Kruse Schultz was born July 13,1920 at Starkweather, ND. Joseph and Katherine had 5 children:

1.Jerome (Jerry) Charles Schultz born March 30,1948;;married Jane Ann Algoe, June 16,1973. Jane Ann was born May 4,1947. Their child : a.Jennifer Ann Schultz born April 24,1974;

2.Judith Katherine Schultz born Dec.20,1940,died Dec.24,1949

3.Joyce Marie Schultz born Nov.22,1950,married Thomas I. Maulsby III on July 17,1971. Thomas was born May 10,1949. There children are: a.Thomas I. Maulsby IV, born Nov.10,1972; b. J.Michael Maulsby, born Dec.24, 1975.

4.Janet Katherine Schultz born March 12,1955, married Gary Scott on June 26,1982. Gary was born April 26,1954.

5.Jeanine Ann Schultz, born March 12,1955,married Daniel J. McCart on April 5,1975.Daniel was born Sep.17,1954. There children are: a. Melia Marie McCart born Feb.21,1979; b.Malinda May McCart born May 4, 1981.

FAMILY OF RITA MATILDA VEERKAMP

RITA MATILDA VEERKAMP, daughter of Herman G. & Philomena Hessler Veerkamp, was born June 3, 1923, near Duncombe, Iowa, in Webster County. She was the second oldest of twelve children. Married Aloysius J. Thilges on February 13, 1945, at St. Joseph, Iowa. Aloysius was born April 21, 1912. They have lived on a farm two miles West of Algona, Iowa, since February 1945, where they continue to live. Aloysius and Rita are the parents of five children.

1. ROBERT ALOYSIUS THILGES, born March 22, 1946, at Algona, Iowa. Married Debra Lynn Olson July 29, 1972, at Bode, Iowa. Debra Olson was born August 12, 1954. Robert & Debra live on an acreage West of Algona, Iowa. Robert & Debra are the parents of three sons:
 - a. Jeremy Douglas Thilges, born July 28, 1974
 - b. Jeffrey Robert Thilges, born September 29, 1976
 - c. Justin Michael Thilges, born April 13, 1982
2. BETTY JANE THILGES, born July 10, 1949, at Emmetsburg, Iowa. Married Floyd John Baas September 4, 1970, at Whittemore, Iowa. Floyd Baas was born July 6, 1945. Floyd & Betty live on a farm Northeast of West Bend, Iowa. Floyd & Betty are the parents of two children:
 - a. Mark John Baas, born March 14, 1974
 - b. Kelly Jane Baas, born May 19, 1979
3. RICHARD JAMES THILGES, born January 21, 1952, at Algona, Iowa. Married Sandra Rose Godfredson on February 16, 1974 at Algona, Iowa. Divorced in January, 1976. Married Karen Jean Lauck April 16, 1983, at Whittemore, Iowa. Karen Lauck was born March 12, 1960. Richard & Karen live in Whittemore, Iowa. Richard & Karen are the parents of three daughters:
 - a. Melissa Sue Thilges, born December 8, 1983
 - b. Kathy Ann Thilges, born October 12, 1985
 - c. Amber Marie Thilges, born May 17, 1988
4. JEAN MARIE THILGES, born July 25, 1955, at Algona, Iowa. Married Warren Householder September 11, 1976, at Algona, Iowa. Warren Householder was born April 29, 1947. Warren & Jean live in Whittemore, Iowa. Warren & Jean are the parents of two sons:
 - a. Heath Warren Householder, born July 14, 1978
 - b. Brock John Householder, born May 16, 1982
5. SANDRA ROSE THILGES, born April 17, 1957, at Algona, Iowa. Married to Daniel Lee Myers June 21, 1980, at Algona, Iowa. Daniel Myers was born November 28, 1956. Dan & Sandy live in Algona, Iowa. Dan & Sandy are the parents of two daughters:
 - a. Brooke Danielle Myers, born August 15, 1986
 - b. Melanie Dawn Myers, born April 6, 1990

Herman Edward Veerkamp, born Oct. 13, 1924 near Duncombe, IA son of Herman G. Veerkamp and Philomena(Hessler) Veerkamp. Moved with his parents to Ottosen, IA in 1925. Inducted into the United States Army on February 14, 1944. Killed in action in Okinawa on April 9, 1945, serving with Co. K. 382nd Infantry. Received Bronze Star posthumously.

Norbert Bernard Veerkamp born October 31, 1926 near Ottosen, IA son of Herman G. Veerkamp and Philomena Hessler Veerkamp. He married Rita Dohr on June 24, 1961. Rita is the daughter of Joseph and Alma(Flesch) Dohr. After serving in the U.S. Navy and receiving his doctorate in electrical engineering, Norbert was a dean in the Milwaukee School of Engineering when he died of cancer on January 17, 1970. They legally adopted two children:

Linda Marie Veerkamp, born Feb. 15, 1964

Received May 22, 1964.

Donald Joseph Veerkamp, born June 3, 1965

Received July 29, 1965

Stanislaus (Stanley) Francis Veerkamp, born April 1, 1928 near Ottosen, IA son of Herman G. Veerkamp and Philomena Hessler Veerkamp. After serving in the U.S. Navy, he returned to Minnesota and was working in Minneapolis when he passed away of cancer November 1, 1986.

Cyril George Veerkamp

Cyril George Veerkamp was born on March 18, 1931 at Ottosen, Kossuth County, Iowa. He was the son of Philomena Hessler and Herman George Veerkamp. Philomena was born on January 5, 1899, at Millhousen, Indiana, Died February 13, 1983 at Blooming Prairie, Minnesota. Herman was born May 14, 1891 at Millhousen, Indiana, Died April 4, 1987 at Blooming Prairie, Minnesota. They were married at Millhousen, Indiana on January 21, 1921. Cyril was one of twelve children.

Katherine Marie Veerkamp (Schultz)	Born 11-25-1921	
Rita Matilda Veerkamp (Thilges)	Born 6-3-1923	
Herman Edward Veerkamp	Born 10-13-1924	Died 4-9-1945
Herbert Bernard Veerkamp	Born 10-31-1926	Died 1-17-1970
Stanislaus (Stanley) Francis Veerkamp	Born 4-1-1928	Died 11-1-1986
Mary Martha Veerkamp (Vaughters)	Born 8-24-1929	
Cyril George Veerkamp	Born 3-18-1931	
Raphael (Ralph) Joseph Veerkamp	Born 12-1-1932	
Patricia Mary Veerkamp (Slowinski)	Born 9-4-1934	
Margaret Ann Veerkamp (Hitchings)	Born 1-10-1936	
Alphonse Anthony Veerkamp	Born 6-13-1937	
Barbara Rose Veerkamp (Slowinski)	Born 4-2-1941	

Cyril George Veerkamp met Darlene Violet Jante at Owatonna, Minnesota. Darlene was born on 10-30-35 in Steele County, Minnesota; the daughter of Henry and Louise Jante; she is one of seven children. Cyril and Darlene were married 7-13-57.

Cyril and Darlene Veerkamp are the parents of three children.

Susan Kay Veerkamp (Stehr)	Born 5-30-1958	
Karen Marie Veerkamp	Born 10-15-1959	Died 10-15-1959
Nancy Ann Veerkamp	Born 7-6-1962	

Cyril and Darlene Veerkamp live at 5931 34th St. N.W., Rochester, MN 55901. Cyril has retired from IRM after 35 years.

Raphael (Ralph) Joseph Veerkamp was born on 12-1-1932 at Kossuth County, Iowa. He is the son of Herman George Veerkamp and Philomena Mary Hessler. He is one of 12 children - Herman, Katherine, Rita, Norbert, Stanley, Mary Martha, Cyril, Ralph, Patricia, Margaret, Alphonse, and Barbara.

Ralph was in the Navy for 4 years where he worked in maintenance. When he was discharged he and Laura moved to the Altura, MN area.

Ralph met Laura Mae Kabage in Owatonna on Dec. 1, 1953. It was at a dance. He was in service and they started writing letters to each other. They were married on Nov. 27, 1954.

Laura's birthdate is June 18, 1932. She was born on a farm near Dodge Center, MN in Dodge County. She is the daughter of Joseph Jacob Kabage and Emma Spinler Kabage. She is one of 10 children.

Ralph and Laura are the parents of 7 children.

Katherine Joann (12-8-56) married Stephen Littlefield. Their children are:

James Patrick - 4/20/79
Joseph Ralph - 10/1/81
John Devon - 2/11/86
Julie Michelle - 6/13/91

Michael Joseph (9-1-57 to 9/8/57)

Charles Jerome (7-13-58) married and divorced Jeanne Schultz. Their daughter is Leah Jeanne (2-3-79).

Dennis James (7-4-58) married Debra Storsveen. Their children are:

Jill Nicole - 8/15/82
Amy Michelle - 8/16/86

David Joseph (6-9-61) married Corinne Kramer. Their children are:

Jessica Jo - 9/30/88
Jennifer Ann - 9/30/88
Breanna Mae - 8/28/90

James Jeffrey (11-18-62) is engaged to Michelle Strelow. His daughters are:

Michelle Margaret - 10/15/83
Kristina Rose - 2/11/91
Kylie Michelle - 1/20/93

Sheryl Jean (4-12-64) married James Jones. Their children are:

Christina Marie - 7/13/81
Candance Jean - 5/2/85

Ralph and Laura live in Altura, MN. Ralph has worked in maintenance all his life. He is now ready to retire and wants to spend time on his woodworking - especially games and toys. Laura likes to read, do needlework, and spend time with her grandchildren.

ANTHONY FRANCIS AND PATRICIA MARY (VEERKAMP) SLOWINSKI

Patricia Mary Veerkamp Slowinski was born on Sep. 4, 1934 at Ottosen, Kossuth County, Iowa. She is the daughter of Herman Veerkamp and Philomena (Hessler) Veerkamp.

Herman Veerkamp was born on May 14, 1891 in Greensburg, In. and died on April 3, 1987 in Blooming Prairie, Minnesota. Philomena was born on Jan. 5, 1899 in Milhousen, In. and died on Feb. 13, 1983 in Blooming Prairie, Minnesota. They were married on Jan. 19, 1921 in Milhousen, Indiana.

Patricia is one of twelve children. Her sisters and brothers are: Katherine Marie (Veerkamp) Schultz; Rita Matilda (Veerkamp) Thilges; Herman Edward Veerkamp (deceased); Norbert Bernard Veerkamp (deceased); Stanley Francis Veerkamp (deceased); Mary Martha (Veerkamp) Vaught, Cyril George Veerkamp; Ralph Joseph Veerkamp; Margaret Ann (Veerkamp) Hitchings, Alphonse Anthony Veerkamp and Barbara Rose (Veerkamp) Slowinski.

Patricia attended Ottosen Public School, Algona Catholic School and Blooming Prairie Public School. She graduated from Blooming Prairie School in 1952. Patricia met Anthony Francis Slowinski at Waltham, Minnesota in August of 1952 at the free movie show. Their very first date was Sep. 7, 1952, one year prior to their wedding date. Patricia and Anthony were married on Sep. 7, 1953 in Blooming Prairie, Minnesota. Anthony Francis Slowinski was born on Nov. 28, 1927 in Armstrong, Emmet County, Iowa. He is the son of John and Stella Slowinski. He is one of nine children, his sister and brothers are; Rose Comer, Wallace Slowinski; Joseph Slowinski; Henry Slowinski (deceased); Frank Slowinski; Victor Slowinski; Paul Slowinski and Charles Slowinski.

Patricia purchased her own business in 1985. The name of her business is the Yarn Shop. She has been very active in the needle work profession. She has taught needle work through the community services in both Austin, Minnesota and Lyle, Minnesota for approximately 20 years. She has been involved in judging needle work for the Mower County Fair (4-H) and also for other counties in her area including for the State Fair. In 1980, she and her husband moved back to Austin, Minnesota after living on a farm in Lyle, Minnesota for 19 years.

Patricia and Anthony had seven children plus they also had 3 foreign exchange students live with them. Their children are; Thomas Anthony Slowinski, Eugene Francis Slowinski; Peggy Anne (Slowinski) Tamke; Terry Raymond Slowinski; Ronny James Slowinski; Russell Edward Slowinski and Kristine Marie (Slowinski) Jensen.

Thomas was born on Feb. 12, 1954 in Austin, Minnesota. He graduated from Lyle High School in 1972. He married Shirley Ann Kemp on Aug. 24, 1973. They have two children, Sean David Slowinski and Shannon Marie Slowinski.

Eugene was born on Dec. 15, 1955 in Austin, Minnesota. He graduated from Lyle High School in 1974. He married Lori Rae Lechnir on Oct. 6, 1979. They have three children, Kristen Kay Slowinski; Nicholas Eugene Slowinski and Brandon Peter Slowinski.

Peggy Anne (Slowinski) Tamke was born on Nov. 19, 1958 in Austin, Minnesota. She graduated from Lyle High School in 1977. She married Mark Anthony Tamke on Oct. 1, 1977.

Terry Raymond Slowinski was born on April 9, 1960 in Austin, Minnesota. He graduated from Lyle High School in 1978. He married Anne Marie Krueger on Dec. 9, 1989. They have three children; Daniel Robert Leidall; Aaron Michael Leidall and Kara Anne Slowinski.

Ronny James Slowinski was born on Jan. 15, 1962 in Austin, Minnesota. He graduated from Lyle High School in 1980. He married Diane Rae Holdgrafer on July 13, 1985. They have one child, Jessica Rae Slowinski.

Russell Edward Slowinski was born on Oct. 26, 1966 in Austin, Minnesota. He graduated from Lyle High School in 1985. He married Teres Rae Dunn on July 8, 1989. They have three children; Daniel Duane Slowinski; Anthony Loren Slowinski (deceased) and Benjamin Russell Slowinski.

Kristine Marie Slowinski Jensen was born on Nov. 7, 1967 in Austin, Minnesota. She graduated from Lyle High School in 1986. She married Scott Leslie Jensen on Sep. 24, 1988.

Elizabeth Furuseth is Patricia and Anthony's foreign exchange daughter. She is originally from Sem, Norway. She lived with the Slowinski family in Lyle, Minnesota for the summer of 1976.

Javier Gutierrez is Patricia and Anthony's foreign exchange son. He is originally from Tampico, Mexico. He lived in Lyle, Min. with the Slowinski family for the school year of 1988-89.

Roberto Hung is Patricia and Anthony's other foreign exchange son. He is originally from Caracas, Venezuela. He lived in Lyle, Minnesota and Austin, Minnesota with the Slowinski family for the school year 1989-90.

Patricia's hobbies include needle craft, reading and she enjoys traveling. Anthony enjoys reading, fishing and handy work around the house (remodeling). He also enjoys travel with Patricia.

Patricia and Anthony presently reside at 303 24th St. N.W. in Austin, Mower County, Minnesota. They look forward to many years of traveling together and watching their children and grandchildren grow. They enjoy spending time with their family. This also includes traveling and making arrangements to see their foreign exchange children.

FRANCIS & THERESA (HARDEBECK) HESSLER
by Bertha (Hessler) Dilks

My name was Bertha Marie Hessler I was born on Jan.8 1928 at Millhousen In. Ripley County State of Indiana. My parents were Francis M. Hessler born May 11, 1900 and Theresia M. Hardebeck born Aug.7,1900. My father died April 23,1986; my mother died June 29,1975. My father was born in Ripley Co. Millhousen and attended School there, my mother was born near Napoleon Indiana in Ripley Co. and attended school in Napoleon, my father was one of 15 children 1 brother and 9 sisters and 4 deceased. My mother was 1 of 8 children 1 sister and 6 brothers. My father was a farmer and owned a gas station,lumberjack,carpenter and a butcher and at his death he ended up a carpenter and part time farmer. My mother was a homemaker and mother to my sister and I. My father liked to hunt and fish in his younger years and mother mostly sewed all our clothes and kept house and also helped grandma Hessler quilt and help take care of some elderly people as was needed she helped take care of great grandma Rutt when she became ill.As we only lived a block away at that time. When my father got out of school two of his sisters had married and moved to Iowa, so he went to Iowa to work and stayed there until his father became ill and they called him home.To help take care of the farm since he was the oldest boy and his brother was to young and great grandpa Rutt was too elderly. He helped run the farm and they all lived there until he and my mother got married. Grandpa and Grandma Rutt and G & G Hessler then moved to Millhousen I don't know how many children they had at home at this time as they were all getting married or going to work as soon as they were able too.

I don't know how long we lived on the farm or why we moved, but I can see how no three families could make a living off of one farm. Also the ones working out as there was no Social Security or Welfare at that time. Maybe Aunt Helen could answer some of these questions. They all moved to a house on the property where Carl Kroeger now lives and I can remember my Grandfather sitting in a rocking chair looking out of the window. The rocking chair was on a rag rug grandma had hand made. He died in Dec.25,1930 and I was three years old on Jan.8,1931 so its hard to realize children can remember that far back. I can remember they moved to where Marie Monter lived later on and that is where Grandma Root died. I remember her as a little frail lady with long gray hair. After we left the farm we moved to Greensburg for a short time and my dad worked as a hired hand to some farmers until he broke his ribs and we then moved back to Millhousen, I must have been one or two years old; west side of millhousen then moved to the house where Dora Waters now lived, so we only lived a block from Grandma and Aunt Helen was still home then so we spent a lot of time at their house. Grandma had a real old fashion washing machine in the summer kitchen and a stove she heated the water in and sometimes when she washed she'd bring Grandma Rutt out and she would sit in a chair and run the washing machine with a handle that moved forward and backwards.

She had three grape harbors and out of these grapes she made grape juice and jelly. She had a big garden and she was always canning everything she could. Marjorie and I helped her mow the yard and weed the garden and whatever she had to do and she would give us cookies and grape juice as she had very little money. Grandma loved to have her hair combed and I use to comb it and she would let me do it for hours while she hand sewed and her hair had such natural curl in it she would then wind it up and pin it on top of her head with long hair pins. She also didn't have any mattresses on the beds and had thing called feather beds they were made of ticking and had a hole in the center and as I can remember they were filled with feathers and corn leaves and husks and when you made the bed you had to stick your arm in these holes and reach around and fluff them up and then make the bed. All the dressers and chest of drawers had marble tops on them and she had large bowls and pitchers to wash yourself with.

When Aunt Helen was still at home she was too young to go to work, I loved to tease her and help her write letters to her older sister in Cincinnati.

Mom also tells how when the older girls had boy friends they would come to see them on Sunday and get to teasing and horse playing and the boys would hold the girls under the well pump and pump water on their heads this was when they lived on the Kroeger place, before I could remember.

When I was 12 years old in 1940, we then moved back on the old Hessler farm the old house was torn down but Aunt Clara had married Uncle George Naderman and he had built a new house there, it had a couple chicken houses and a barn. However it wasn't on the site where the old house had stood, it was a quarter of a mile or so closer to the main road. There was no inside plumbing and no electric att that time. We also didn't have any water, we had to haul it from where the old house stood. The old barn and some of the fences around the barn were still there, also some fruit trees. So my dad witched a well with a peach limb and dug down 12 or 15 feet, I can't remember and we hit a water vein and he put a pump on it and we had enough water to cook with and didn't have to haul all our water. Also I think it should be mention that the war broke out in 1941 and the government put in two pipelines, they ran from Texas to the East Coast and they carried petroleum in them for the war I think one was 20 inch. and the other was a 16 inch. and they cross the Hessler farm also. They put them in the garden were the new house stood. (I hear it the house, is burned down since). These pipes now carry natural gas or so they tell me. We moved off the Hessler Farm when my dad bought a house in town, where Marjorie lives now, I think in 1945 or 46.

I Bertha Hessler grew up in Millhousen In. Decatur Co. and attended the Millhousen school and graduated from the eighth grade in May 1942. I attended the Immaculate Conception Catholic School and also attended Church there having been baptized, received my first and solemn Communion there and was confirmed there also. When I got out of school and in the summers while I was in school my sister Marjorie and I helped care for our grandma Hardebeck who was in failing health and also helped Aunt

Clara Naderman Care for her three oldest children in Sept. of 1943 ,I was 15, I came to Greensburg to work doing housekeeping,first for a car salesman than an attorney of the City of Greensburg while working for them on Feb.14,1944 I met Billy Jim Dilkes who was in the service in World War II. He was born in Greensburg and went to the schools there until he was 16 and had to drop out as his parent divorced and he was the oldest of four,so he had to work on the railroad until the army called him to duty ,his parents were Ollie Dilkes of Greensburg and Oral Opal Clinginpul. His father passed away in 1963 in Indianapolis In. His mother passed away in Dec.12,1986, she was born on April 1,1904. She had two brothers both deceased. These people were all born and died in or near Greensburg In. Jim came home from the service in March 1946 and he and I were married Jan.11,1947. He had 3 brothers and 1 sister 2 brothers who are deceased.

Jim and I had three children. Jo Ann born on June 18,1947, Cathy on Jan.8,1961, Billy Jim Jo on Aug.11,1967. They all went to St.Mary's School and graduated from the Greensburg High School; Joan in 1965;Cathy in 1979; and Bill in 1985. They all made their Baptism,First and Solemn Communion at Confirmation at St. Mary's.

My husband worked in factories until about 1952 and then became a carpenter and housing builder in fact he built the house we now live in at 904 W. 9th St. in Hillcrest in 1960. He had a stroke in Dec. 1989 and was very ill and the stroke affected his right side and his speech and motivation. At this time he has recuperated and is a lot better able to do small jobs and mow the grass.

After Jim and I married I stayed home for 1 1/2 years. Then I went to work at Racim Short factory and Garrett Garment in July 1948 to when the factory closed in 1976. In 1977 I became employed at the Decatur Co. Hosp. and I'm still there, however I only work part time now.

My oldest daughter Jo Ann married Carl Joseph Winkler on April 9,1966 and to this union was born a son on May 11,1970.They later divorced and she is now married to John Marlorn as of Feb. 14, 1987. Jo Ann now lives in Sandusky. She also worked at the Ranch from 1963 to 1966.They are both employed at James Rivers. Their son was named Joseph Dwight Winkler he is now 23 years old and works at Tops Hardware Store.

Cathy Sue Dilkes graduated from High School in 1979 and worked at the Ranch Market,she then went to BCA factory and after being laid off twice she looked for other employment and went to work for Dr.David McCarthy a chiropractor who sold out to Dr. Segraves and she works for him now. She is not married at this time but plans to marry in the near future, she lives on the Millhousen Rd.605.

Billy Jim Dilkes Jr. graduated in 1985, attended Indiana State University until he enlisted in the Army in 1988 and stayed in the Army from May 1988 to Dec.1992; 4 1/2 years. He is now attending Indiana State under the G.I. Bill of Rights.

MARJORIE HESSLER

Marjorie Francis Hessler was born on Sept. 2, 1926, at Millhousen in Ripley Co., just across from the county line from Decatur County. She was the daughter of Francis Matthias and Theresa Mary (Hardebeck) Hessler. She has one younger sister, Bertha Marie (Hessler) Dilks.

Marjorie attended the Immaculate Conception grade School, in Millhousen, in Decatur Co. and graduated from there on Sunday, May 18, 1941. She never attended any other schooling.

Her hobbies consist of housekeeping, yard and garden work, including working with flowers. She lives on the East side of the town of Millhousen, In. since July 18, 1945.

Francis Matthias Hessler was born on May 11, 1900. He was the son of Frank J. and Mary (Rutt) Hessler. He was the second oldest child. He had one older sister, and 13 younger brothers and sisters.

Theresa Mary (Hardebeck) Hessler was born on August 7, 1900, the daughter of Edward G. Hardebeck and Francis Mary (Herbert) Hardebeck. She was the third oldest child of the family having two older brothers, and a younger sister and four younger brothers all deceased.

Francis and Theresa were married on January 7, 1926, at the St. Maurice Catholic church at Napoleon, in Ripley Co. Indiana.

Francis passed away on Wednesday April 23, 1986, and was buried in the Immaculate Conception Cemetary in Millhousen, In.

Theresa passed away on Sunday, June 29, 1975, and was buried in the Immaculate Conception Cemm. in Millhousen, Indinana.

HARRY (JOHN HENRY) AND MARY (HESSLER) DWENGER

Mary Cecilia Hessler was born on Nov. 17, 1901 in the Hessler Cabin just outside of the town of Millhousen. She was the daughter of Frank John and Mary (Rutt) Hessler of Millhousen. She was born one of 14 children.

Her family were members of the Immaculate Conception Catholic church in Millhousen. She attended the Catholic school in Millhousen.

John Henry Dwenger was born on Feb. 19, 1898 at Hamburg Indiana, in Franklin Co. While Christened, John Henry, he went his whole life by the name of Harry J. Dwenger, and many only know him by that name.

He was born the son of Frank J. (John) Dwenger, who was born on Aug. 20, 1868 at Hamburg In. and Anna Seibel, who was born on June 13, 1872, also born at Hamburg In. They were devout Catholic's and they attended the St. Maurice Catholic church at St. Maurice, in Decatur Co. Harry was one of six children.

Harry and his brothers had a large group of friends. One form of entertainment was going to the free dances, which were held on the weekends. Harry's sister Martha was also in this group of friends. One of Martha's girlfriends, was a girl named Mary Hessler. She drew Harry's attention above the other girls that he knew. He began asking her out for dates. He told her on one occasion, "You know I'M going to marry you one day!

This seemed to Mary, quite brash, and she responded, "Oh, you are, are you."

Harry J. Dwenger and Mary Cecilia Hessler were married at the St. Mary's? Catholic church at Millhousen, on Aug. 29, 1923.

They first set up housekeeping in a house on his father's farm. Harry helped his father out with his farming. They lived in a small house just across the road from Harry's parents.

Their first child, Mary Kathleen, was born on June 5, 1924. It was a very hot summer, and a very hot June, so Mary would set little Kathy, in her bassinet, on the

Harry and Mary Dwenger were the parents of ten children:

1. Mary Katherine b/1924 married, Paul Schiedler-- six child: Rose Marie, Jerome Paul, Janet, Tim (Billy), Mary Ann, Paul.
2. Esther Ann b/1925 married William Martin-- five child: Michael, Billie Joe, Jackie, Debra, Steven.
3. Rosella Cecilia b/1927 married, Harold Powers-- twelve Child: Mary Rose, Kay, Susan, Harold, Donald, Rita, Raymond, Artie, Angela, Dorothy, Andrew, Jacob.
4. Ruth Elenora b/1928 married, Charles Hamilton-- twelve child: Marilyn, Ann, Charles, James, Linda, Barbra, Helen, Philip, Carol, Joyce, Dale, Joseph.
5. Anna Marie b/1929 married, John David McCullough-- eleven ch: Donna, Patty, Margaret, Beverly, Davvid John, Sharon, Carolyn, Harry, Ruth, William, Glen.
6. Richard Francis (Dick) b/1931 married, Joan (Sis) Lawrence-- four child: Diane, James, Charles, Lawrence.
7. Martha Elizabeth (Betty) b/1933 married, Frank Ed Harris-- seven child: Nita, Eddie, Ricky, Larry, Kenny, Cindy, Gregory.
8. Leonard Joseph b/1935 married, Janet (Gussy) Burgmeier-- two child: Terrica, Todd.
9. Mary Ellen b/1937 married, Carl Veercamp-- five child: Carl, Shirley, Karen, Robert, Ronald.
10. Edward Joseph b/1947 married, Brenda McIntyre-- five child: Brian, Tracy, Christopher, Joseph, Jason.

(FOR MORE INFORMATION SEE DWENGER HISTORY)

CLEM AND MATILDA (HESSLER) STUHRENBERG

Mary Matilda Hessler was born September 11, 1903 at Millhousen, Indiana in Decatur County. She was the daughter of Frank and Mary (Rutt) Hessler of Millhousen. Her paternal grandparents, Adam and Catherine (Stahl) Hessler were well known and respected in the area. Her maternal grandparents were Matthias and Philomena (Thole) Rutt, who lived with her parents. Many a childhood day was filled with stories of her Grandpa Rutt's home in Germany.

Matilda's family were faithful members of the Immaculate Conception Catholic Church in Millhousen. She attended the Catholic schools in Millhousen. Prior to her marriage, Matilda was employed as domestic help in a home in Greensburg, Indiana and later at a home in Cincinnati, Ohio. Matilda was married February 5, 1927 in the Catholic church at Millhousen to Clem Bernard Stuhrenberg.

Clem Bernard Stuhrenberg was born March 20, 1903 at Millhousen, Indiana in Decatur County. His parents were Herman and Mary Ann (Kohrman) Stuhrenberg. Herman was born December 6, 1848 and Mary Ann on May 18, 1862.

After their marriage they moved to a farm south of Duncombe, Iowa and were members of St. Joseph's Catholic Church. In 1945 they moved to a farm west of Duncombe where they farmed until moving to a farm west of Clare, Iowa in 1961. In 1970 they retired from farming but continued to live on the farm until 1983 when they moved to the Clare retirement homes. While living at Clare they were members of St. Matthew's Catholic Church.

Clem passed away on September 24, 1985 at his home in Clare, Iowa from a heart condition.

Matilda passed away on May 29, 1986 in a hospital in Fort Dodge, Iowa after suffering a stroke.

They are buried in St. Joseph's Catholic cemetery in Duncombe, Iowa.

Descendants of Clem Bernard Stuhrenberg

Clem Bernard Stuhrenberg
 b Mar 20, 1903 in Milhousen, Indiana
 d Sep 24, 1985 in Clare, Iowa
 Number of children: 11
 Age at death: 82

Patilda Hessler
 b Sep 11, 1903 in Milhousen, Indiana
 d May 29, 1986 in Clare, Iowa
 m Feb 5, 1927 in Milhousen, Indiana
 Age at death: 82

Children

Mary-Agnes Stuhrenberg
 b Dec 4, 1927 in Duncombe, Iowa
 Number of children: 4

Albert Husske, Jr.
 b Jun 12, 1927 in Humbolt, Iowa
 m Sep 6, 1949 in Duncombe, Iowa

Denise Husske
 Kathleen Husske
 Mary Joan Husske
 Luffon Husske

Bernard Joseph Stuhrenberg
 b Feb 11, 1928 in Duncombe, Iowa
 Number of children: 8

Patricia Husske
 b Feb 6, 1936 in Clare, Iowa
 m Nov 15, 1955 in Fort Dodge, Iowa

Marvin Stuhrenberg
 Karen Stuhrenberg
 Dean Michael Stuhrenberg
 Keith Stuhrenberg
 Donald Stuhrenberg
 Alecia Stuhrenberg
 Tracy Ann Stuhrenberg
 Timothy Stuhrenberg

Dorothy Catherine Stuhrenberg
 b Nov 3, 1930 in Duncombe, Iowa
 d Nov 27, 1974 in Fort Dodge, Iowa
 Number of children: 2
 Age at death: 44

Richard Husske
 m Jun 18, 1952 in Duncombe, Iowa

Richard Husske, Jr
 Christopher Husske

Vincent Harry Stuhrenberg
 b Jul 21, 1932 in Duncombe, Iowa
 Number of children: 5

Mary-Ellen Wilson
 b Nov 1, 1936 in Fort Dodge, Iowa
 m Nov 8, 1958 in Fort Dodge, Iowa

Dennis Stuhrenberg
 Kevin Stuhrenberg
 Alan Bernard Stuhrenberg
 Diana Stuhrenberg
 Steven Stuhrenberg

Maurice Bernard Stuhrenberg
 b Jul 6, 1934 in Duncombe, Iowa
 Number of children: 5

Virginia Ruth Grasser
 b Mar 25, 1936 in Chicago, Illinois
 m Jun 25, 1960 in Chicago, Illinois

Susan Marie Stuhrenberg
 Andrew Lloyd Stuhrenberg
 James Anthony Stuhrenberg
 Carol Marie Stuhrenberg
 Lynda Marie Stuhrenberg

Mary-Helen Stuhrenberg
 b Jan 24, 1936 in Duncombe, Iowa
 Number of children: 2

Henry Rathouz
 b Mar 14, 1923 in Moorland, Iowa
 m Aug 23, 1969 in Fort Dodge, Iowa

Sharon Elizabeth Rathouz
 Barbara Ann Rathouz

Lucille Mary Stuhrenberg
 b Oct 20, 1937 in Duncombe, Iowa
 Number of children: 2

Thomas Petersen
 b Apr 26, 1936 in Fort Dodge, Iowa
 m Dec 27, 1969 in Fort Dodge, Iowa

Mary Beth Petersen
 Jennifer Ann Petersen

Alvin Francis Stuhrenberg
 b Sep 18, 1939 in Duncombe, Iowa
 Number of children: 4

Judith Silbough
 m Nov 27, 1955

Debra Stuhrenberg
 Nancy Stuhrenberg
 Joan Stuhrenberg
 Robert Stuhrenberg

Theresa Marie Stuhrenberg
 b Jun 17, 1941 in Duncombe, Iowa

Elizabeth Ann Stuhrenberg
 b Mar 23, 1943 in Duncombe, Iowa
 Number of children: 2

Lowell Lawler
 b Sep 26, 1940 in Clare, Iowa
 m Dec 27, 1967 in Fort Dodge, Iowa

Theresa Rose Lawler
 Rebecca Ann Lawler

Mary Louisa Stuhrenberg
 b Jan 4, 1945 in Duncombe, Iowa
 d Jan 5, 1945 in Duncombe, Iowa
 Age at death: 0

MARY AGNES STUHRENBERG was born December 4, 1927 at Duncombe, Iowa. My parents were Matilda Hessler, born at Millhousen, Indiana on September 11, 1903 and Clem Stuhrenberg, born at Millhousen, Indiana on March 20, 1903.

I am the oldest of eleven children. My brothers and sisters are: Bernard, born February 11, 1929 and married to Patricia Husske. Dorothy, born November 3, 1930 and married to Richard Husske. Dorothy passed away September 27, 1974. Vincent, born July 21, 1932 and married to Mary Ellen Wilson. Maurice, born July 6, 1934 and married to Virginia Grasser. Helen, born January 24, 1936 and married to Henry Rathouz. Lucille, born October 20, 1937 and married to Thomas Petersen. Alvin, born September 18, 1939 and married to Judith Silbough. Theresa Marie, born June 17, 1941. Elizabeth (Beth), born March 23, 1943 and married to Lowell Lawler. Mary Louisa, born January 4, 1945 and died January 5, 1945.

I attended Duncombe Public School and graduated from Duncombe High School in 1946. After graduation I was employed as a clerk in the motor freight department for the Brady Transfer & Storage Company in Fort Dodge, Iowa.

On September 6, 1949 I was married to Albert Husske, Jr. at St. Joseph's Catholic Church in Duncombe, Iowa. Albert is the oldest of six children of Albert Husske, Sr. and Mary Pauline (Tuvell) Husske. We lived in Fort Dodge, Iowa until March of 1950 when we moved to a farm near Moorland, Iowa and I left my job with the Brady Company. In 1956 we moved to a farm near Clare, Iowa and in 1958 moved to a farm in the Otho, Iowa area. Albert retired from farming in 1970 and worked until his retirement in 1989 for a security service.

In 1968 I returned to the work force and was employed at Fantle Bros. department store in Fort Dodge, Iowa until 1986 when the store was sold and closed. Since that time I have worked at Svana's Fashion Imports, a ladies ready to wear shop in Fort Dodge, Iowa.

Albert and I have four children. Denise Marie, born November 16, 1950. Denise lives in Fort Dodge, Iowa and is employed as a secretary to the Secretary Comptroller of the Fort Dodge School District. Kathleen Ann was born April 9, 1953. She lives in Apple Valley, Minnesota and works as a department sales manager for Sears Roebuck & Co. and is currently working in the Sears store in the Mall of America in Bloomington, Minnesota. Mary Joan (Mary Jo Hasty) was born October 2, 1957. Mary Jo lives in Des Moines, Iowa and is an assistant manager with "Kids 'R Us" a childrens clothing store. LuAnn Christine was born June 24, 1959. She lives in Fort Dodge, Iowa and is employed as a secretary in the feed division of Cenex/Land O'Lakes.

Our grandchildren are Curtis Hasty, born July 25, 1981 and Nickolas Hasty, born June 18, 1984.

Lucille Mary Stuhrenberg was born on October 20, 1937, at her parent's home near Duncombe, Iowa. She is the daughter of Clem Stuhrenberg (born 3/20/1903 at Milhousen, Indiana; died 9/24/1985 at Clare, Iowa) and Matilda Hessler Stuhrenberg (born 9/11/1903; died 5/29/1903 at Fort Dodge, Iowa). She was one of eleven children.

Mary Agnes Stuhrenberg Husske (Albert, Jr.) - born 12/4/1927

Bernard Joseph Stuhrenberg (Patricia Husske) - born 2/11/1929

Dorothy Catherine Stuhrenberg Husske (Richard) -born 11/3/1930 -died
9/27/1974

Vincent Henry Stuhrenberg (Mary Ellen Wilson) - born 7/21/32

Maurice Bernard Stuhrenberg (Virginia Grasser) - born 7/6/34

Mary Helen Stuhrenberg Rathouz (Henry) - born 1/24/36

Alvin Francis Stuhrenberg (Judith Silbough) - born 9/18/39

Theresa Marie Stuhrenberg - born 6/17/41

Elizabeth Ann Stuhrenberg Lawler (Lowell) - born 3/23/1943

Mary Louisa Stuhrenberg - born 1/4/1945 - died 1/ /1945

Lucille attended elementary school at Washington Township #10 and graduated from Duncombe High School in 1956. She graduated from St. Joseph's School of Nursing in Fort Dodge in 1959, and was employed there as an operating room nurse until 1963. She spent the next four years with the Papal Volunteer program working in Amazonas, Brazil and Pernambuco, Brazil.

Through a mutual acquaintance she met Thomas J. Petersen and they were married on 12/27/69 at Sacred Heart Church in Fort Dodge, Iowa. Tom was born 4/26/36 in Fort Dodge, the son of Nels J. and Eileen McIntyre Petersen. He has two sisters, Patricia Petersen Loveland (Ronald) and Colleen Petersen.

Lucille and Tom continue to reside in Fort Dodge and are the parents of two adopted daughters, Mary Elizabeth Petersen (6/1/72) and Jennifer Anne Petersen (4/6/74). Lucille is presently working as school secretary at Sacred Heart School in Fort Dodge, and Tom is retired from Geo. A. Hormel and working part-time at Fort Dodge Distributing.



Clem and Matilda
Stuhrenburg on
Their Wedding day
Feb. 5, 1927



Joseph and Bernice Hessler
taken 1985



Wedding of Joseph and Bernice Hessler



Mary (Rutt) Hessler
and dau. Christine (Cord)

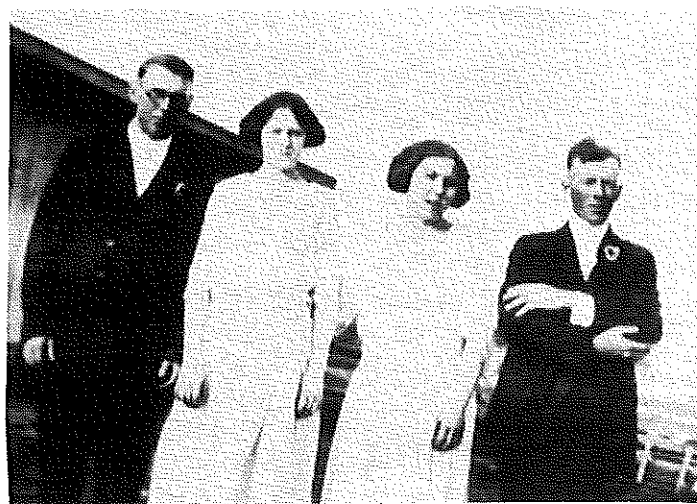

John , Rose & Ceal, Harry J.
Dwenger Hessler Dwenger

BERNARD AND CECILIA (HESSLER) HARPRING

Mary Anna Cecilia Hessler was born at on a Monday July 17, 1905 at Millhousen Indiana in Decatur County. She was the daughter of Frank John Hessler (b/1871 in Indiana) and Mary Anna (Rutt) Hessler (b/1874 in Ohio). The Hesslers were devout Catholics, and attended the Immaculate Conception Catholic Church at Millhousen Indiana. Their children attended the Millhousen Catholic School. Their children first learn to speak English when they started attended the School.

Cecilia was called Ceal by her family and friends. Cecilia was one of fifteen children; Phlonena; Francis; Mary; Matilda; Cecilia; Rose; Clara; Joseph; Gertrude; Christina; Hildegarde; Lawrence; Aloysius; Helen; Margaret

Agnes. When Ceal was old enough she went to Greensburg In. to work as a maid for a time. Cecilia Hessler was married on Aug. 28, 1926 at the Catholic Church in Millhousen Indiana, to Bernard Harpring.

Bernard Joseph Harpring was born on July 14, 1895, in Millhousen, Decatur county, Indiana. He was the son of Anthony and Mary (Hoeing) Harpring. Bernard and Cecilia lived first on Anthony's farm, then rented a farm in Greensburg until 1950, then moved to Batesville. He bought a farm, around 100 acres in Franklin County Indiana, and lived there until 1964, when Bernard died, Aug. 7, 1962. Bernard always farm until the late 50's, when he was force to retired, because of illness. He died in 1962. They attended Church at Batesville St. Louis and is buried there.

In 1964 Cecilia sold the farm and bought a home in Morris in Riply Co. Indiana, (two miles south of Batesville) and lived there until 1975. Then moved to September Place in Greensburg In. where she was living, when she passed away, on Feb. 19, 1981 of a heart attack. Bernard and Cecilia are buried at the St. Louis Church Cemetery in Batesville In. Bernard and Ceal Harpring were the parents of eight children: Mary Joan; Edgar; Irma; Lois; Luella; Elvera; Bernard; Veron.

1. Mary Joan Harpring b/Sept. 4, 1927 at Millhousen In. She was married on Feb. 26, 1947, at St. Mary's Catholic Church in Greensburg In., to Leonard Schoettmer. They currently own a farm at Greensburg Indiana in both Adams and Clinton Twp. of 342 acres. They are the parents of eight children;

a. Steven Schoettmer who works on the family farm. Steven married Anita Nobbe, and they have two children; Scott and Jennifer who attends North Decatur High School. The family attends the St. Louis Church in Batesville.

b. Stanley Schoettmer married Carol Mann, and they live at Greensburg, Indiana. They have one daughter Sarah Schoettmer.

c. Joyce (Schoettmer) who married Duane Comer, lives at Greensburg Indiana. They have three children; Robert; Michael, and Christopher Comer.

d. Leonard Schoettmer Jr. was married to Jere Jasin, they live at Greensburg Indiana. Leonard and Jere have a daughter Stacy Lindsay Schoettmer.

e. Joseph Schoettmer was married to Carolyn Long, they live at Greensburg Indiana, and are the parents of four children; Carrie; Joseph Jr. Catey; Caryn.

f. Charles Schoettmer was married to Margaret Chaney, they live at Greensburg Ind. and are the parents of three children; Lee; Travis; Amber.

g. Mary Ann Schoettmer married Rob Smith, they live at Greensburg and have two children; Kelcie, Ericka.

h. Patrick Schoettmer was married to Mary Conk, they live in New Jersey. Patrick is a member of the Air Force Reserves, he works on C-41 Loadmaster airplanes. He is also a guard at the juvenile prison. Patrick has two stepsons; Gary and Dennis Conk.

2. Edgar Francis (Bud) Harpring was born on Feb. 14, 1929 the second child of Bernard and Cecilia Harpring. He was married to Thelma Catherine Lecher on May 13, 1950. Thelma was born on Oct. 28, 1928. Edgar and Thelma currently reside at Columbus Indiana. Edgar and Thelma Harpring are the parents of five children: David; Jean; Samuel; John, and Susan.

1. David Irvin Harpring born: Nov. 12, 1951. He married Vicky Sue Zuick on Oct. 8, 1977. Vicky was born on June 8, 1955. They had three children: Jennifer Lynn b/Jan. 8, 1979, Sarah Marie b/Dec. 1, 1980, Andrea Rachel b/Aug. 8, 1986.

2. Jeanette Marie Harpring born: Nov. 4, 1952. She was married on July 28, 1990 to Gary Lynn Barker. Gary was born on May 4, 1953. They have a child Catherine Susan Barker born on Jan. 26, 1993.

3. Samuel Clemens Harpring, born: Dec.17,1956. He was married to Rebecca Elise Beaman on June 30,1979. Rebecca was born on Nov. 28,1958. They had a child: Crystal Elise Harpring b/April16,1983. Samuel was divorced and remarried to Taresa Rice on Dec.12,1992. Taresa was born on Sept.17,1949.

4. John Edward Harpring was born: May 9,1961. He was married to Lee Ann Eckerle on April 23,1983. They were divorced and John remarried to Belinda Gayle Croddy on Feb.16,1991. Belinda was born on Feb.25,1961. He is the father of three children: Jeremy Vray b/Oct.14,1981, Ashly Dawn b/Jan.2,1984, Jamey Lynn b/July 1,1987.

5. Susan Catherine Harpring was born: June 9,1966. She married Brian Allen Walters on Jan.27,1984. Brian was born on April 11,1962.

3. Erna Harpring was born in 1931 and died in 1932, buried in Millhousen Indiana.

4. Lois Marie Harpring was born on May 19,1933. She was married on July 8,1953 at Batesville Indiana to Alvin Laudick. Lois and Alvin have three children;

a. Mary Beth who married Dexture Haney, had a child; Josh. They were divorced and Mary Beth married Brent Gibson. She currently resides at Morris Indiana.

b. Kimberly married Eric Moenter, they have three children; Sean; Philip; Jenny Moenter.

c. Greg married Marilyn Miller, and they have no children.

5. Luella Josephene Harpring was born on May 1,1936 at Decatur Co. Indiana, she was married on May 1,1954 to Edward Lecher at the ST.Louis Catholic Church in Batesville Ind. Ed and Luella own a home in Greensburg where they currently reside. They attend the St.Mary's Catholic Church .Ed is a retired mechanic and welder. Luella works at "Weddings by Walter" in Greensburg as a seamstress. Ed and Luella Lecher are the parents of 4 children:

a. Brenda Lecher who married Charles Emsweller, they are the parents of two children; Chad and Ashly .

b. Nicholas Lecher died on Feb.2,1961 at 1 & 1/2 days old.

c. Julie Lecher was married to Thomas Keillor, they have one child, Daniell Keillor.

d. Bernard Lecher was stillborn on April 13,1965.

6. Elvera Helen Harpring was born on Aug.13,1938. She was married on Sept.13,1958 to Harvey Joseph Wissel at Batesville Indiana. They own a home at Morris In. this is the old homeplace of William and Ekulve, a grandfather on the Wissel side. Harvey Wissel passed away on May 13,1993. Evera and Havver Wissel were the parents of six children;

a. Damien Wissel who married Barbra Howse and have two children; Brett and Sarah.

b. Natan Wissel (not married)

c. Matthew Wissel (not married)

d. Monica Wissel who married Chris Hooten and have a child Bryan Hooten.

e. Alyssa Wissel (not married)

f. Sheila Wissel (not married)

7. Bernard Harpring born Sept.5,1943, near St.Peters in Franklin Co. Indiana. He was married to Sharon Peters on Nov.22,1962 (divorced) Then he married Sue Mobly on July 9,1971 in Franklin Co. Sue was born May 26,1949. Bernard had 7 children;

a. Jay Harpring b/March 2,1964, studing to be a priest;

b. Tracy Harpring b/March 2,1966 married Paul Hodges and have

on child; Jeramy 5 years old.
have two children; Terra and

c. Gina Irene Harpring b/May 25,1969 married Kyle Hanna and

Austin.

Children of Bernard and Sue:

d. Tonya Sue Harpring July 13,1972

e. Rosetta Jo Harpring Oct. 1,1973

f. Anna Jean Harpring Dec.15,1975

g. Jodi Lee Harpring Feb. 11,1992

8. Vernon Harpring born on May 17,1945, and married Diana Williams on March 26,1966 (divorced) and then married Maureen. He presently resides in Ripley County Indiana. Vernon is the father of four children;

a. Gwen Ann Harpring b/July 1,1966 (single)

b. Todd Lloyd Harpring b/Sept.5,1969

c. Mark Anthony Harpring b/Oct.1,1970 (single)

d. Perry Robert Harpring b/April 11,1973 (single)

MARY ROSE HESSLER(SISTER JOSEPH MARIE)

Mary Rose Hessler was born on February 6, 1907 at Millhousen Indiana. She was the daughter of Frank J. and Mary Anna(Rutt) Hessler. She grew up on a farm at the edge of the small town of Millhousen.

The Hessler family were members of the Immacualte Conception Catholic Church in Millhousen, and Rose attended the Catholic school there. She was one of 15 children.

Rose entered the St. Cecilia Convent at Nashville Tenn. on August 25, 1931. She recieved her Habitt on March 6, 1932 and recieved the name of Sister Joseph Marie. Sister Joseph Marie was a quiet, unassuming person who took delight in providing her sisters in teaching apostolate with clean clothes and good meals to sustain their health.

She was burdened with the responsibilities of the local bursar at St. Cecilia Convent for many years and seemed to stretch the money to provide more than you could possibly imagine. She could be seen at the market each week carefully pricing commodities and quality of produce before purchasing the most and the bestt for the least price. Sister Joseph Marie also kept a watchful eye on the mainten-ance of the heating and electrical equipment as well as the general condition of the convent to provide cleaning equipment and materials.

She was rarely sick. When she began having trouble retaining her food, she tried to continue her duties and hoped it was something passing that would go away. After the condition persisted for a couple of weeks, she was forced to see a doctor.

Surgery was performed on Sept. 11, and Advanced Cancer was revealed. Sister was unable to return to St. Cecilia until Oct. 1, and faithfully attended all her religious duties in the kitchen which had so often kept her from community prayers but she was always most exacting about saying those prayers privately.

As her condition grew worse, Sister Margaret Mary(Helen-Tonnie), her sister was transferred from Hampton, Virginia to St. Pious school in Nashville to be with her.

Sister Joseph Marie never complained of her suffering and insisted on attendeing Mass in a wheelchair until the day she died. as the end drew near the sisters were summoned to sing the Salve and say the prayers for the dying. Sister Margaret Mary and another of her sisters had been at her bedside for several hours reciting the rosary aloud so that sister could hear. As the community joined then in the recitation of the rosary, Sister Joseph Marie died as she had lived, very quietly without disturbing anyone.

MAY SHE REST IN PEACE

MARY HELEN HESSLER(SISTER MARGARET MARY)

Mary Helen Hessler(Tonnie) was born on Tuesday Oct. 3, 1916 at home near Millhousen Indiana She was born the daughter of Frank John and Mary(Rutt) Hessler. She was one of 15 children. Her family attended the Catholic church in Millhousen. She was baptised on Sunday Oct. 8, 1916 her sponcers were, John Bernard Thole and Caroline Thole. She recieved the nicknane of "Tonnie" by a niece who could not say her name clearly as a child and she is still called by that today.

Helen entered St. Cecilia's Convent at Nashville, Tenn. on Aug. 30, 1941. She recieved the holy habit of St. Dominic on Sunday, March 1, 1942 at 4:00 P.M. and recieved the name of Sister Margaret Mary.

Sister Margaret Mary made her first profession on March 7, 1943. renewed pro-fession on March 7, 1946 and her final profession on Aug. 15, 1940.

Sister Mary was a school teacher. She is presently retired and resides at the St. Cecilia Convent, 801 Dominican Drive, Nashville, Tenn. 37228-1909.

She was a tremendous help in collecting information for this book.

GEORGE & CLARA (HESSLER) NADERMAN

Clara Mary Hessler was born April 24, 1908 at Millhousen Indiana, in Decatur County (Marion township). She was born the daughter of Frank John and Mary Anna (Rutt) Hessler. She grew up in Millhousen and attended the Catholic School there, she was one of 15 children.

The Hessler family attended the Immaculate Conception Catholic Church at Millhousen. After graduating from school Clara worked in Cincinnati, Ohio for 13 years as a maid for two Jewish families, before returning to Decatur Co.

She was married on Feb. 14, 1939 at the Catholic Church in Millhousen to George John Naderman, they knew each other for nearly their whole lives.

George John Naderman was born on Nov. 29, 1895 on a farm west of Millhousen. George received a portion of the original farm from his dad, Albert and Rosa (Klosterkemper) Naderman. He grew up on a 120 acre farm, he was one of six children. George was a machinist in the Army, in W.W. I; was trained, but Armistice was signed before he had to go. He was a long time member of the American Legion in Greensburg.

George's father Albert, was the son of Heinrich Naderman who came to the U.S. from Germany in 1856. He married Adelaide (Funke) in Germany and she was pregnant on the boat over. They settled at Millhousen, and had six children; 1. Mary m/ Henry Stuhrenburg, 2. Elizabeth m/ Joe Blankman, 3. Albert m/ Rosa Klosterkemper, 4. Henry m/ 5. Anne/ died of flu in Jan. 1919. 6. Rose m/ Ben Harpring.

George Naderman passed away at Decatur County Indiana on Jan. 25, 1925 and is buried at Millhousen. Clara Mary (Hessler) Naderman passed away on Dec. 8, 1992 and is buried at Millhousen.

George and Clara were the parents of eight children:

1. George Naderman Jr. was born on Jan. 2, 1940. He was married to Pat Lawer. They live in Cary North Carolina; George and Pat had 3 children: Paul; Kari; David.

2. Justin Francis Naderman was born on Feb. 5, 1941 in Decatur County Indiana. He is not married and lives in Rigby, Idaho.

3. Rose Marie (Naderman) Baur was born on March 10, 1942 near the town of Millhousen. She was married to Ed Bauer on Oct. 8, 1977 (Miami Co. at St. Charles Catholic Church in Peru, Indiana. Anthony Edward Baur born Aug. 1, 1941 (Marion Co. In.). She has two children: a daughter, Anna Marie Bauer born Easter Sunday Airo; 6, 1980 at Elemendorf A.F.B Hospital, Anchorage, Alaska. and a son John Edward Bauer, born Memorial Day Sunday, May 31, 1981 at U.S.A.F. Academy Hospital, Colorado Springs, Colorado.

Rose Marie was a schoolteacher for ten years before marriage. She is now doing clerical work. Mr. Baur made a career in the U.S. Air Force. After nearly 30 years in the Air Force, he retired and accepted work at the Nevada Test Site north of Las Vegas. They moved to Nevada in Nov. 1991.

4. Jane Clara Naderman was born on April 1, 1943. She was married to Steve Reed. They presently live in Muncie Indiana. No children

5. Edna Ann Naderman was born on Jan. 9, 1945 in Decatur County, Indiana. She was married to James Cardinal and they have two children: 1. Theresa Cardinal who married Cameron Brown. and 2. Scott Cardinal who is not married.

6. Albert Naderman was born Feb. 4, 1946 on the family farm near Millhousen Indiana, where he currently resides. He was married to Cheryl Holt. They have 5 children: Michelle; Kimberly; Matthew; George; Adam.

7. John A. Naderman was born on May 7, 1948 in Decatur County, Indiana. He is not married, and lives at Muncie.

8. Esther Deloras Naderman was born on Sept. 22, 1950 at Decatur County Indiana. She was married to Marty Ruhl. They live in Sherwood Oregon, a suburb of Portland. They are the parents of three children; 1. Jessica Ruhl (not married), 2. Janel Ruhl n/m 3. Griffin Michael born March 28, 1993.

JOSEPH and Bernice(Wenning)HESSLER

Joseph Hessler was born May 7,1909 near Millhousen Ind. He was the son of Frank J. Hessler who was born March 25,1871 and Mary Ann (Rutt)Hessler, born July 5,1874. They were married Sept 21,1897. His father died Dec.25,1930 his mother died Aug.3,1962, both are burried at Millhousen.

Joseph Hessler was born and raised on the Hessler family farm just outside of the town of Millhousen, in Decatur County, Ind. He was one of 15 children; Philomena,Francis,Mary,Matilda,Ceal, Rose,Clara,Joseph,Bobbie,Chris,Hildegarde,Lawrence,Helen,Margaret Agnes. He and his parents were members of the Millhousen Catholic Church. He attended school at Millhousen In.His family often spoke German at home, but the children always spoke English when at school.

Joseph Hessler was married to Bernice Wenning at the Immaculate Conception, Catholic church in Millhousen, Indiana, on Aug.11,1937.

Bernice Wenning was born the daughter of John and Josephine Wenning. Bernice was born on Aug.18,1911 in Ripley Co. Ind. She is one of five children;1.Helen Hoeing;2. Everett and 3. Edmund Wenning and 4. Hilda Garrison are her sisters and brothers. 5.

John Wenning was born Oct.28,1883 and died Nov.1,1966. Josephine Wenning(Bernice's mother) was born March,19,1884 died Feb.27,1978. Both are burried at Millhousen.

Children of Joseph and Bernice(Wenning) Hessler are:
1. Kenneth John Hessler b/May 12,1938; 2. Judith Ann Hessler b/June 1,1939; 3.David Lawrence Hessler b/Jan.20,1942; 4. Mary Ann Hessler b/Sept 24,1943; 5. Robert Joseph Hessler b/June 23,1945. 6. Judith Ann Hessler died Jan.1,1961 she is buried at Millhousen.

We have lived at 209 West Connersville St. in Milton, Ind. Wayne County for 51 years, until his retirement,Joseph was a factory worker.

KENNETH JOHN HESSLER

Kenneth John Hessler was born on May 12, 1938 at New Castle In. He is the son of Joseph B. Hessler and Bernice M. (Wenning) Hessler. He is one of five children; Kenneth, Judith (deceased); David L.; Mary Ann (Hessler) Hindman; and Robert T. Kenneth is married to Carolyn Sue (May) Hessler. She is the daughter of Herschel and Rosa May of Milton, In. She was born in Milton on July 28, 1940. They were married at St. Elizabeth Catholic Church in Cambridge City, In. on april 11, 1959. Kenneth and Sue are the parents of two children. Barry Lee Hessler was born at New Castle In. August 1, 1961. He is single and currently works and lives in Houston Texas. Julia Ann (Hessler) Burke was born at Gallon Ohio on January 11, 1965. She is married to Mark Burke. They are the parents of one daughter, Alyssa Suzanne Burke born at Toledo Ohio November 19, 1989. They currently reside in Toledo Ohio.

Ken and Sue live in Mansfield Ohio. He is on the corporate staff of Abex Inc. Sue is a Registered Nurse and is a supervisor in the Operating Room at Mansfield General Hospital.

MARY ANN HESSLER

Mary Ann Hessler born Sept. 24, 1943 in New Castle, Ind, the parents of Joseph b/May 7, 1909 and Bernice (Wenning) Hessler b/Aug. 18, 1911. She had three brothers and one sister; Kenneth J. b/May, 12, 1938; David L. b/Jan. 20, 1942; Robert J. b/June 23, 1945 and Judith b/June 1, 1939. Mary Ann Hessler graduated from Milton High School in 1961; Ball State University in 1965; International Travel Academy in 1993. Married Neil C. Hindman b/July 14, 1940 in Cambridge City, In. on Dec. 26, 1964. She had four children; Karyyn Renee Hindman b/5/9/65; Tricia Ann Hindman b/4/15/69; Jennifer Leigh Hindman b/10/3/72; Suzanne Lynn Hindman b/9/24/73. Karyn Hindman married Mark Erik Hume b/8/30/65 on Sept. 7, 1991. The family interests are travel, gourmet dining, reading, and volunteer work.

MARY GERTRUDE (BOBBIE) HESSLER

Mary Hessler was born on Nov. 12, 1910 at Millhousen in Decatur Co. She was the daughter of Frank John and Mary (Rutt) Hessler of Millhousen. Her family were devout Catholic's and attended the Immaculate Conception, Church at Millhousen, In. Gertrude was one of 15 children; Philomena, Francis, Mary, Matilda, Cecilia, Rose Christina, Clara, Joseph, Gertrude, Hildegard, Lawrence, Aloysious, Helen, Margaret.

Gertrude attended the Catholic School at Millhousen, after graduating she worked in Cincinnati, Ohio cleaning homes for rich people. Gertrude and Clem were married on Feb. 26, 1930 at Millhousen, In. in the Catholic Church. After their marriage they lived near Millhousen in Decatur Co. Indiana; south on a farm.

Clement Bernard Koors was born on Feb. 16, 1905 in Decatur Co. Indiana, and died April 21, 1993, in Greensburg Indiana. He was the son of Clement Joseph Koors and Mary Christina (Bruns) Koors. Joseph Koors was born on Oct. 15, 1857 in Decatur Co. and died on July 12, 1938 in Decatur Co. Indiana. He married Mary Christina Bruns on Nov. 15, 1881 at Millhousen, In. Mary Bruns was born on Oct. 29, 1862 in Ripley Co. In. and died on Feb. 23, 1944 in Decatur Co. Indiana.

Clem was a farmer and purchased 80 acres of land owned by Joseph Koors in 1945. They were members of the Immaculate Conception Church in Millhousen in Marion Twp. Clem was a member of The Knights of St. John and Knights of Columbus in Greensburg over 50 years. Gertrude was a member of The Ladies Auxiliary in Millhousen, Indiana.

In 1970 Clem retired from farming to a home in Millhousen. Clem did some janitor work at the Catholic Church in Millhousen. In 1992 they sold the farm to, Dave Koors, their grandson. In January of 1993 they moved from Millhousen, to Heritage House Nursing Home in Greensburg In. where Gertrude is still residing.

Gertrude and Clem were the parents of six sons; James Joseph Koors b/Feb. 6, 1932; Sylvester Koors b/Sept. 5, 1933 d/Oct. 20, 1934; Paul Joseph b/d/ March 31, 1935; Carl William Koors b/April 26, 1936; Donald John Koors b/March 23, 1938; Louis Herman Koors b/March 18, 1940.

Donald John and Geraldine Julia Sauer Koors Family

Donald John Koors, March 23, 1938, Millhousen, IN, Decatur County
Fifth child of Clement and Gertrude Hessler Koors
Married October 6, 1962 to Geraldine Julia Sauer, July 28, 1938,
Second child of Frank and Marguerite Berens Sauer, born in
Anderson, IN, Madison County

CHILDREN:

1. Patricia Anne Koors, September 1, 1965, Indianapolis, IN,
Marion County
2. Teresa Lynn Koors, December 14, 1966, Indianapolis, IN,
Marion County
Married June 24, 1989 to Ricky Lee Rambo, September 20,
1965, Gary, IN, Lake County, Fourth child of Robert and
Cheryle Hoyt Rambo
3. Julianne Marie Koors, April 5, 1968, Indianapolis, IN, Marion
County
Married April 17, 1993 to Daniel Joseph Godin, JR., December
17, 1965, Detroit, MI, Oakland County, Second child of Daniel
Godin, SR. and Mary Lee Godin
4. Joseph William Koors, May 10, 1970, Indianapolis, IN, Marion
County
5. Christopher Michael Koors, January 25, 1975, Indianapolis, IN,
Marion County
6. Kathleen Michelle Koors, January 22, 1977, Indianapolis, IN,
Marion County
7. Angela Christine Koors, April 8, 1979, Indianapolis, IN,
Marion County

Louis Herman Koors was born on March 18, 1940 at Milhousen, Indiana in Decatur County. Louis was the son of Clem and Gertrude (Hessler) Koors. Clem and Gertrude were born and raised in Milhousen and lived there most of their lives before they entered the Heritage House Nursing Home in Greensburg, Indiana in January of 1993, where Gertrude is still a patient. Clem was born on February 16, 1905 and died April 21, 1993. Gertrude was born on November 12, 1910. They are the parents of six sons, four living and two deceased.

Louis met Rita (Harpring) at a dance in Milhousen in 1960. Rita was born in Hamburg, Indiana in Franklin County on August 6, 1942. She was one of seven children born to William and Catherine (Effing) Harpring. On October 13, 1962 they were married in Batesville, Indiana at the St. Louis Catholic Church. Louis and Rita are the parents of seven children, four girls and three boys. Rose Marie was born July 22, 1963 at Walter Reed Army Medical Center in Washington D.C. while Louis was in the Army stationed at Walter Reed Army Medical Center. She was killed on November 12, 1990 in a car accident at the age of 27 in Greensburg, Indiana. Kevin Joseph- February 17, 1965, Cletus Allen- May 21, 1967, Karen Susan- October 24, 1969, Brenda Lee- October 25, 1972, Shirley Renee- June 27, 1978, and Ryan Paul- July 15, 1983 all were born in Greensburg, Indiana. Brenda Lee died on July 23, 1977 at the age of four years old. Kevin was married to Sheila Wilson on May 18, 1991 in Greensburg, Indiana. They have one son, Kyle Donald born on November 27, 1992. They live at 207 West First Street in Greensburg, Indiana.

Louis and Rita are living at 1031 East Skyline Drive in Greensburg, Indiana. Shirley and Ryan are also living at this address and attending Greensburg Schools.

Louis Koors

JAMES JOSEPH KOORS

James Joseph Koors born on Feb. 6, 1932 in Millhousen In. the son of Clement Bernard Koors and Gertrude Mary (Hessler) Koors. Married on April 26, 1958 at St. Marys Catholic Church in Greensburg, to Marieda Catherine (Hoeing) daughter of (Joseph Bernard Hoeing and Agnes Marie Butz born in April 24, 1937, Decatur Co. Indiana.

They had three children: David Alan Koors born Feb 6, 1959 Greensburg In., married July 3, 1982 at Immaculate Conception Catholic Church in Millhousen In. to Sherry Louise (Morrow) daughter of (Elmer David Morrow and Diana Lynn (Martian) she was born on June 15, 1964 at Greensburg In. They had two children Michael David Koors born July 27, 1989 in Greensburg IN. and Bradley James Koors born March 8, 1993 in Greensburg In.

Rickey Joseph Koors was born Aug. 22, 1961 in Greensburg In. was married May 6, 1989 at Immaculate Conception Catholic Church in Millhousen, In. To Virginia Darlene (Bruner) born Oct. 6, 1964 in Greensburg In. daughter of (Donald Bruner and Clara (Campbell)). Daryl James Koors born Dec. 14, 1965 in Greensburg Indiana.

Carl William Koors

b. April 26, 1936 - Decatur County, Indiana

d.

Son of Clement Bernard Koors

b. February 16, 1905 - Decatur County, Indiana

d. April 21, 1993 - Greensburg, Indiana

Son of Clement Joseph Koors

b. October 15, 1857 - Decatur County, Indiana

d. July 12, 1938 - Decatur County, Indiana

Married Mary Christina Bruns - November 15, 1881, Millhousen, Indiana

b. October 29, 1862 - Ripley County, Indiana

d. February 23, 1944 - Decatur County, Indiana

Married Mary Gertrude Hessler - February 26, 1930 - Millhousen, Indiana

b. November 12, 1910 - Ripley County, Indiana

d.

Daughter of Frank J. Hessler

b. March 25, 1871 - Ripley County, Indiana

d. December 25, 1930 - Ripley County, Indiana

Married Mary Ann Rutt

b. July 5, 1874 - Cincinnati, Ohio

d. August 3, 1962 - Greensburg, Indiana

Married Julia Ann Scheidler - December 27, 1960 - Greensburg, Indiana

b. November 6, 1939 - Shelbyville, Indiana

d.

Daughter of Richard Louis Scheidler and Olivia Ann Herman

Children:

Jannice Lynn

b. February 22, 1962 - Greensburg, Indiana

d.

Married Jay J. Tremblay - April 27, 1985 - Harrison, Ohio

b. March 7, 1958 - Massachusetts

d.

Son of Joseph Tremblay and Mary Ann Sullivan

Brian David

b. August 2, 1963

d.

Carl attended elementary school (1942-1950) in Millhousen, and high school (1950-1954) in Napoleon. He received his B.S.M.E. (Mechanical Engineering) from Purdue University in January, 1959. During his studies he completed the Co-op program with Kearney & Trecker Corporation in Milwaukee, Wisconsin. Following graduation he began a career with The Cincinnati Shaper Company (later renamed Cincinnati Incorporated). He is currently Manager of Computer Aided Design at Cincinnati Incorporated. In June, 1969, Carl received his Master of Business Administration degree from Xavier University.

ALVIN AND CHRISTINE (HESSLER) CORD

Christine (Chris) Hessler was born on Dec.12,1911 at Millhousen,Indiana, in Decatur Co. She was the daughter of Frank Hessler, born in 1871, in Indiana and Mary Anna (Rutt) Hessler born in 1874 in Ohio. Christine attended the Immaculate Conception School in the town of Millhousen. Her parents were devout Catholics and they attended the Immaculate Conception Catholic Church in Millhousen. Christine maternal grandparents, Matthias, and Philomena (Thoe) Rutt lived with them as she was growing up. Christine Hessler was married on Aug.6,1941, at the Immaculate Conception Catholic Church in Millhousen.

Alvin Cord was born on Aug.15,1912 at Millhousen, the son of Frank and Anna Cord. They had a son Francis who was born and died on the same day, Jan.21,1945. After a little time they adopted two daughters; Deloras was born on May 11,1947,was married to Doug Flint on April 6,1966. They were divorced. She remarried on Jan.19,1989 to Michael Hogg, and she has two sons Nathen Flint and Robb Flint. She currently lives at St. Paul, Indiana, and is employed at Delta Faucet. Carolyn was born on July 26,1949, she married Charles Baker and was divorced. She remarried to William Scheidler. She has one son Charles Baker.

Christine passed away on Feb.19,1987 from cancer. Her husband Alvin Cord passed away on June 1,1963. She was employed at Stewarts clothing store, in Greensburg Indiana. They are buried at Millhousen, Indiana.

GEORGE JOHN(BOB) HESSLER

George John Hessler was born on March 22,1873 at Millhousen, Indiana, Marion township of Decatur County.

He was the son of Adam John and Catherine(Stahl) Hessler. He was one of eight children: Mary(Menkedick), John(died young),Frank m/Mary Rutt, George(self), Adam John m/Catherine Vanderpohl, Henry(died Young), Andrew m/Catherine Underline.

The Hessler's had emigrated from Germany. The German language was still spoken in the household.

George(Bob) Hessler's family were devout Catholics and they attended the Millhousen Catholic Church. He attended the Catholic school there also.

His father Adam Hessler owned a farm just outside of the town of Millhousen. George helped his father out with the farming and with his logging business.

George was married two times. He was married the first time to Viola Margaret Wheeldon. Viola was born in April 1891. (Viola Had a son Fred born in 1879.)

George and Viola lived near Millhousen, George was a farmer and a handyman. They were members of the Immaculate Conception Catholic Church at Millhousen.

They were the parents of six children:1. Lester Hessler b/1909 he died in 1933,2. Thelma Marie Hessler(who married Jim Darby and lives in Cinn. Ohio) b/Jan.10,1912, 3. Alvin Hessler b/1913 and died at age two in 1915, 4. Elsie Mary Hessler(who married Ralph Sealing) b/May 28,1915 she died on Nov.5,1966 in an automobile accident, 5.Henry Hessler b/ Feb.17,1917 he died on Feb.17,1918 at the age of one year old. 6. Rose Viola Hessler was born on Sept. 26,1907 at Millhousen, Indiana.(She married Clarence John Hardebeck).

Viola(Wheeldon) Hessler passed away on Sept.17,1918. She was buried at the Catholic church in Millhousen. George's oldest daughter Rose helped out around the house and took over many of the chores if the household, also tending to her younger brothers and sisters.

George Hessler remarried to Anna M. Herbert. Anna was born in 1884 Indinana. She passed away in 1933 Millhousen, In.

George(Bob) Hessler continued too farm until his retirement. He passed away in September of 1940 at Millhousen Indiana in Decatur County.

ROSE VIOLA HESSLER

Rose Viola Hessler, was born on September 26, 1907 at Millhousen, Indiana. She was the daughter of George John Hessler and Viola Margaret Wheeldon. George was born on March 22, 1873. He died on September 1940. He was the son of Adam John Hessler (1840-1903), and Catherine Stahl (1845-1923). Viola Margaret Wheeldon was born on April , 1871. She died on September 17, 1918.

Rose was one of seven children. She was born on September 26, 1907. She died on June 28, 1978 at Greensburg, Indiana. Her brothers and sisters were;

Lester Hessler he was born in 1909. He died in 1933.

Thelma Marie Hessler (Darby), was born on January 10, 1912. She is the only one that is still living. (1993)

Alvin Hessler was born in 1913. He died in 1915.

Elsie Mary Hessler (Seiling) was born on May 28, 1915. She died on November 5, 1966 in an automobile accident in Michigan.

Henry Hessler was born in February 17, 1917. He died on February 17, 1918.

Fred Hessler was a half brother to Rose. He was born on 1879

Rose married Clarence John Hardebeck on November 6, 1926.

Clarence was one of ten children. Clarence was born on May 23, 1900. He died on February 22, 1975.

Clarence brothers and sisters were George, Ben, Elmer, Mae (Hardebeck) Butz, Anna (Hardebeck) Veerkamp, Hilda (Hardebeck) Veerkamp, Josephine (Hardebeck) Martin, Nora (Hardebeck) Henningner, and Clara (Hardebeck) Vogel.

Rose and Clarence had seven children Elmer Anthony (Tony), William George (Bill), Marietta, Norman Joseph, Mary Ann (Runyan), Margaret Inez (Kipper), and Betty Ann. Betty was born on April 24, 1943. She was killed in an automobile accident on September 12, 1963. Marietta was born on December 28, 1932. She died on January 12, 1933.

Elmer Anthony (Tony) was born on August 10, 1927. He married Marie Alfreda (Schantz) on February 15, 1950. Marie was born on September 21, 1927.

Elmer and Marie are the parents of seven children: Helen Marie (Owens), John Anthony, Patricia Ann (Manlief), Dorothy Mae, Robert William, James Joseph, Karen Sue.

Elmer and Marie live at 9707 South County Rd. 60 SW. Westport Indiana.

Helen was born on February 7, 1951. She was first married to Robert McGill of North Vernon, Indiana. They had two children Shawn Patrick born on February 27, 1973. Shannon Marie born on November 8, 1974. Helen is now married to John Matt Owens (born on January 19, 1947). They were married on October 15, 1976. They have one child Matt Anthony Owens, born on November 30, 1977. They live at R. 6 Box 329B North Vernon, Indiana.

John was born on July 28, 1952. He is married to Mitzi Joan Ildewine, (born on July 10, 1957) they were married on March 21, 1975. They have two children Shelly Renee born on September 4, 1975. Jason Anthony born on December 6, 1977. They live on the Hardebeck's (Rose and Clarence) home place. Their address is 2547 W. County Rd. 1000S, Westport Indiana.

Patricia was born on November 20, 1953. She is married to Charles Robert Manlief (born July 5, 1951). They were married on May 25, 1973. They have two children Anthony Earl born on May 13, 1974. Craig Allen born on November 17, 1975. They live at 283 East County RD. 1000S. Westport, Indiana.

Dorothy Mae Hardebeck was born on April 4, 1956. She lives at 119 North Lincoln, Greensburg, Indiana.

Robert William Hardebeck was born on April 11, 1958. He lives at home.

James Joseph was born on May 15, 1961. He lives at home. He helps Elmer farm.

Karen Sue Hardebeck was born on March 24, 1966. She lives at home.

2.

William George (Bill) Hardebeck was born on February 17, 1931. He was Rose and Clarence Second child. He lives at 2944 W. County Rd. 1000S Westport, Indiana.

3.

Norman Joseph Hardebeck was born on March 12, 1935. He is married to Eva Janett (Brown). They were married on February 2, 1957. Eva Janett was born on November 10, 1939. They have two children; William Joseph born on June 23, 1959. Michael Lee born on May 21, 1965. They live at 2399 West County Rd. 1000S. Westport, Indiana.

William Joseph was married to Cheryl Jean Fortner (born November 8, 1968) they were married on February 4, 1984. They have two children; Daniel Joseph born September 10, 1985. Andrew James born on August 2, 1987.

Michael Lee is married to Jenny Kay Thompson (born April 24, 1971) they were married on February 1, 1992. ~~They are expecting~~ They have ~~a child in May (1993)~~. They live at 10095S County Rd. 60 SW. Westport Indiana.
Lynn - Born May 28, 1993

4.

Mary Ann (Runyan) Hardebeck was born on August 14, 1937. She married William Orlando Runyan (born March 4, 1934) on February 21, 1957. They have seven children: William Edward born on April 23, 1959, Robert Anthony born on April 14, 1960, Ronald Joseph born on July 17, 1961, Kenneth John born on March 3, 1963, Teresa Ann born on November 26, 1964, Billy Anthony born on July 8, 1979, Thomas Joseph born on July 26, 1989. (Billy and Thomas are Adopted).

William Edward is married to Karen (Coomes-born March 22, 1959). They were married on July 19, 1983. They have one child Steven Michael born on December 12, 1985. They live at 3086 N. County Rd. 425 W. Greensburg, Indiana.

Ronald Joseph is married to Marica Denise (Beckett- born August 28, 1961). They were married on October 9, 1982. They have two children Matthew Douglas born on October 27, 1986. Elizabeth Rose born on September 14, 1989. They live at 1340 East County Rd. 600S Greensburg, Indiana.

Robert, Kenneth, Teresa, Billy and Thomas Joseph live at 1467 West County Rd. 750S Greensburg, Indiana.

5.

Margaret Inez (Kipper) was born on October 30, 1940. She married Donald Charles Kipper (born February 16, 1941) on September 7, 1959. They are the parents of three children; Donald Charles Jr. born on November 3, 1961, Rose Ann born on November 3, 1962, David Wayne was born February 5, 1956.

Donald Charles Kipper Jr. married Brinda Bush on August 12 1983, they have one child Shawn William born on May 28, 1984. They were divorced in 1990.

Rose Ann(Kipper) son was born on May 25, 1980 his name is William Joseph. Rose Ann married David Lee Euler on March 19, 1981. They divorced in August of 1982. They had one son Ricky Lee Euler born on June 30, 1981. Rose then married David Wayne Walters on March 15, 1985. They have two children Joshua David born on May 1, 1985, and Justin Lee born on July 17, 1986.

David Wayne Kipper lives at home with his parents he is a policeman for the Jennings County police department. He also served in the military for several years after graduation for high school.

JOHN HESSLER

John Hessler was born on Oct. 8, 1868 at Millhousen, In. He was the son of Adam and Catheerine(Stahl) Hessler. John died in Aug. of 1870, at the age of one year and ten months old. He is buried at the Catholic Cemmetary in Millhousen, In.

ADAM J. AND IDA(WAGNER) HESSLER

Adam J. Hessler was born on Feb. 27, 1875 at Millhousen, In. He was the son of Adam and Catherine(Stahl) Hessler of Millhousen. Adam grew up in Millhousen, his father Adam was a farmer and also ran a lumber business.

Adam J. Hessler was married on Oct. 5, 1897 to Ida Wagner. They were married at St. Maurice Catholic Church at Napoleon, Indiana in Ripley Co. Ida was born on Dec. 23, 1875 at Napoleon In.

Adam was called by the nickname of "Ed" by many who knew him. Adam(Ed) was a farmer from the Millhousen area. He and his wife were members of the Immaculate Conception church at Millhousen.

Adam and Ida Hessler had two children, 1. a son Andrew, who probably died young, and I have no birth or death dates on him. 2. A daughter, Anna C. Hessler was born in 1901 at Millhousen, Indiana. She was married to John Dwenger who was born in 1894 and died in 1974. Anna died in 1972. They had no children.

Adam J.(ED) Hessler passed away on Nov. 17, 1947. His wife Ida Hessler passed away on Feb. 11, 1968. They are buried at the Catholic Cemmetary at Millhousen.

HENRY HESSLER

Henry Hessler was born on Sept. 17, 1878 at Millhousen, In. in Decatur Co. He was the son of Adam and Catherine(Stahl) Hessler. Henry passed away when he was only one year old, on Jan. 14, 1879. He is buried at the Millhousen Catholic Church Cemmetary.

GERHARD HESSLER AND HIS FAMILY

By Charles A. Hessler

My grandfather Gerhard John Hessler was the sixth child of Adam John Hessler and his wife Catherine Stahl. Gerhard was born on December 30, 1876, and was baptized at Millhousen. Gerhard Hessler was born in a log cabin, just across the Ripley County line from Millhousen. His parents lived in that cabin for several years after they were married.

Gerhard attended the Catholic school at Millhousen, as did his brothers and sister. However, their attendance was sometimes sporadic, and Gerhard was never a very good reader. Gerhard and his brother Adam liked to sneak back in the schoolroom during the noon recess and steal Sister's willow switch and hide it in a hole in the schoolhouse's foundation. They attended school in the brick school located near the old sister's house; that was the second school at Millhousen. The earliest school was north of the road, near the site of the present school building, which has been closed since 1971.

Gerhard may have helped his brother Frank dig the old well at the brick house, where they moved in the 1880s. According to the story told me in the 1970s by Paul Blankman, who lived in that house, Frank and his brothers dug down 45 feet, lining the walls of the well with stone. Toward evening, Frank decided they had gone deep enough, so they quit. The next morning the well was full of water, and it was still being used in the 1970s.

Gerhard worked as a farmer and teamster and was also an occasional bartender and contractor. On August 17, 1898, Gerhard married Catherine ("Katie") Vanderpohl, who was born on January 17, 1879. They had seven children: (1) Theresa, (2) William, (3) Freda, (4) Albert, (5) Raymond, (6) Carl, and (7) Lydia. The children often called their mother "Katie" and called their Grandmother Vanderpohl "Mother," presumably because they heard their mother refer to Theresa Vanderpohl as "Mother," and all the adults called their mother "Katie."

Gerhard and Katie's oldest child, Theresa, was born in 1899, probably on the Vaske farm north of Millhousen, where Gerhard and Katie lived when they were first married. The barn on that farm burned down about a year after Gerhard and Katie were married, and that was probably one reason why they moved to Kokomo, where several of their Stahl and Hessler relatives lived. Also, Gerhard had a close friend, Bill Ruberg, who lived in Kokomo. While in Kokomo, Gerhard worked hauling ice. Apparently, Gerhard and Katie missed Millhousen, because they moved back shortly after their son William Gerhard was born in Kokomo in 1901.

The rest of Gerhard and Katie's children were born in the frame house on the road south from Millhousen, just before you get to the old brick house where Adam Hessler and Catherine Stahl lived from the 1880s until after Adam died in 1903. This land was owned by Gerhard Ruhl when the 1867 Decatur Co. map was published. The frame house on that land was built according to plans made by Gerhard, as Katie did not want any part of the planning. As a result, the entrance to the cellar was rather awkwardly located in the kitchen at the base of the stairway. Freda once fell into the open cellar entrance. Gerhard always intended to relocate the cellar door, but he never got around to it. I have a photo of Gerhard and his sons Carl and Albert putting a roof on the garage/shed behind their house. That house, which was sold by my father, Carl Hessler, to Norbert Scheidler in the late 1940s, was destroyed as a result of a propane gas explosion in September 1989. Norbert Scheidler was in the house at the time and escaped without serious injury.

Gerhard hauled logs, lumber, and gravel for roads. In a good week, he could make \$20 hauling logs. Gerhard called snaking logs "snagging." Gerhard's wagon would move very slowly going uphill with a heavy load. He would move forward on a steep hill only a few feet at a time, putting in blocks under the wheels to let his two horses rest in between times. At least once, Gerhard and others in the family, including his brother Adam and his son Albert, helped build a bridge near Millhousen, as shown in another photo. They probably worked together on other construction projects.

Gerhard called his farm "the 35 hills," because it consisted of about 35 acres of hilly land. Only about 15 acres were tillable. Blackberries thrived on some of the back hills. When blackberries were in season, the whole family helped pick them. In a morning they could pick 10-15 gallons. In the afternoon, Gerhard, often accompanied by his son Bill, would take the berries in the buggy to Greensburg, where he sold them for 40¢ a gallon. Often he bought a pork liver for 10¢ from a butcher in Greensburg with part of the berry money; the butcher usually threw in some soup bones. In blackberry season, Gerhard would quit hauling logs, because he could make more money selling fresh blackberries up and down the streets of Greensburg.

Raymond and Carl and their cousin Joe Hessler trapped small animals for their fur. The boys also hunted squirrels and rabbits in the woods and fields around Millhousen and probably roamed the area around Squaw Run and Muscatatuck River. They probably also had some favorite fishing spots.

Gerhard and his family raised a little wheat and corn and some livestock on their farm. The children shared the chores of feeding and watering the animals, splitting and carrying in wood, bringing in water from the well, and washing dishes. They sometimes used "funny money" made on scraps of paper to pay someone else to do their chores. They also used their funny money in card games. If someone lost all their funny money in a card game, they would have to do someone else's chores to earn back enough funny money to play cards again. Their card games included euchre, rummy, sixty-six, and three pairs. The latter game was played by dealing out five cards to each player, then drawing and discarding until someone got three pairs. They also played checkers.

At Christmas, Gerhard and Katie would keep the parlor doors locked while they decorated the Christmas tree with popcorn, candles, ornaments, and little gifts. Katie would tell the children that, when Santa came, there would be a light under the parlor door and they would have to behave or Santa would leave. When the light went off in the parlor, the children would open the door and go in.

The family raised lots of vegetables, and they lived on their potato crop all year, having potatoes with practically every meal. My father liked boiled potatoes, mashed potatoes, fried potatoes, and potato soup. Breakfast usually included bread and butter, cornmeal cakes, and in the spring when the chickens were laying, there would also be eggs. In the winter after a hog was butchered, there was often a little pork. Coffee was served with every meal. Katie made the coffee by adding a tablespoon of freshly ground coffee to the leftover grounds in the large coffee pot, which was only emptied out completely and cleaned every couple weeks.

In the evening, the meal usually consisted of bread and butter, cottage cheese, fried potatoes, and fried eggs. Only occasionally was there any meat, such as pork in the winter or a chicken. Sundays were often spent socializing with relatives in the afternoon, after attending Mass in the morning. The family often visited back and forth with Uncle Frank Hessler's family and Aunt Mary Menkedick's family. On Sundays, Gerhard's children would often go over to the 20 acres where the Hessler log cabin had stood and play a game of baseball with Frank Hessler's family and the Scheidlers who were their neighbors. After baseball, they would often eat melons and then go swimming in "Runnie Hole," a swimming hole at the end of Frank Hessler's farm.

Gerhard and Katie's youngest child, Lydia, was born on March 27, 1913, and died of typhoid fever on October 10, 1916. Lydia's death was a severe loss to the family. Before she died, her mother often sang as she went about her chores around the house. After Lydia died, Katie stopped singing.

In 1921, Gerhard bought the family's first automobile, a Model T Ford, for \$430. He used money sent home by his son Bill, who had saved the money working for the Pennsylvania Railroad. All of the children, except Carl, left home at a fairly early age, and they sent part of their wages back home to help out. Until they were 21, Gerhard kept their excess wages, as was common practice.

Gerhard Hessler died on January 3, 1926. He had been ill for over a year, often confined to bed. His death certificate shows the cause of his death as organic heart disease. After his father's death, Carl continued to live on the farm with his mother until he was drafted by the Army in 1942. Katie Hessler died in Greensburg on December 3, 1944.

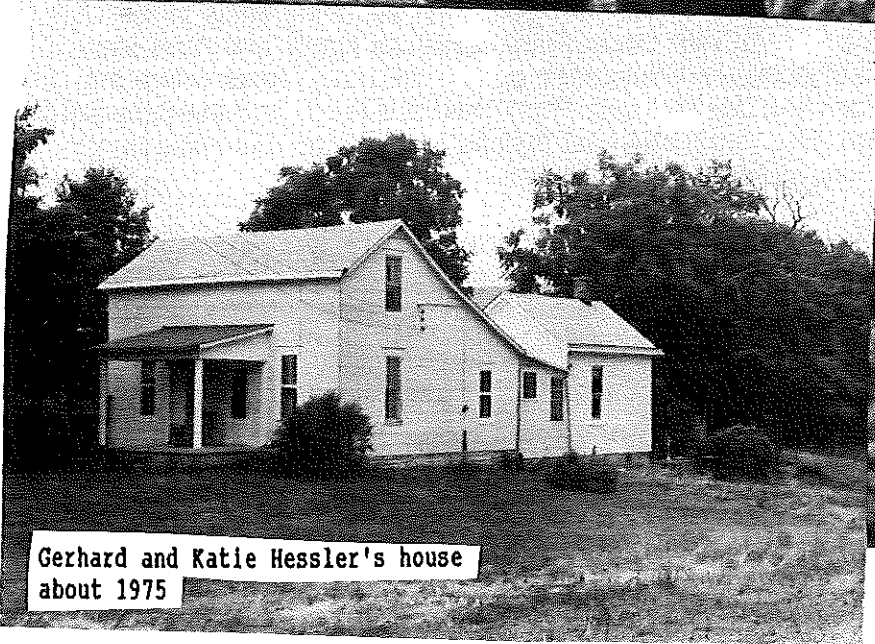

Gerhard and Katie Hessler's house
about 1975

Gerhard and Catherine Hessler

about 1921



Carl, Bill, Raymond, Katie, and Gerhard Hessler
1921 Model T auto

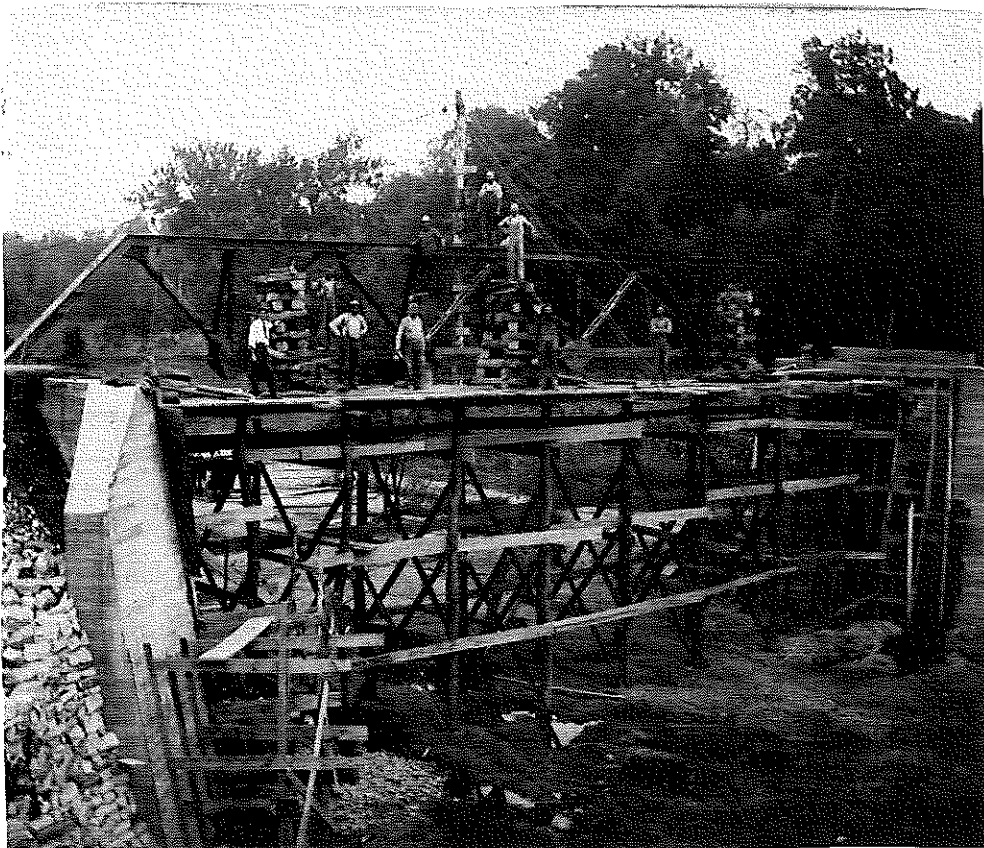

Bridge construction near Millhousen about 1919
3rd from L front:Gerhard Hessler, standing in trus
Adam Hessler, extreme right: Albert Hessler

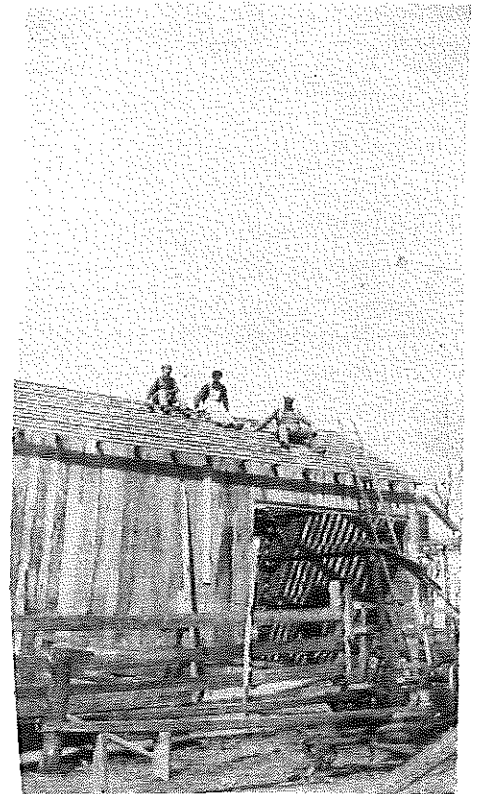

about 1924
Carl, Albert, & Gerhard
Hessler on Garage Shed

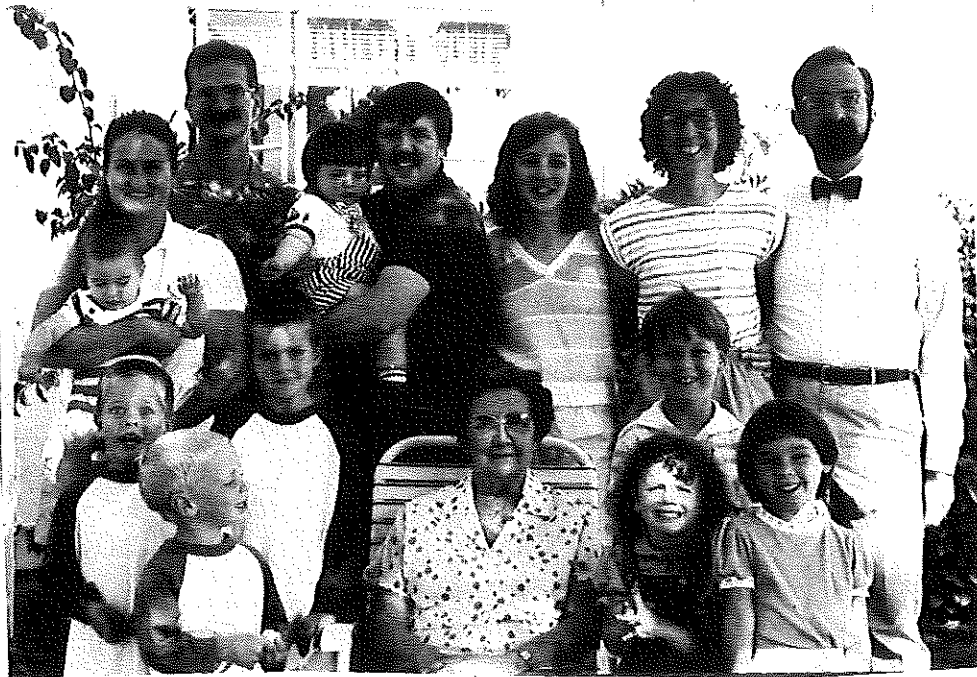

Names for 1987 family photo:

Front row: Mark Hessler, Johnny Hessler, Carl Hessler, Hilda Hessler, Sarah Rettenbacher, Adam Hessler, Kathryn Hessler.

Back row: Theresa Hessler holding Walter, John Hessler, Bob Rettenbacher holding Ryan, Katie Hessler Rettenbacher, Jane Titus Hessler, Charlie Hessler.

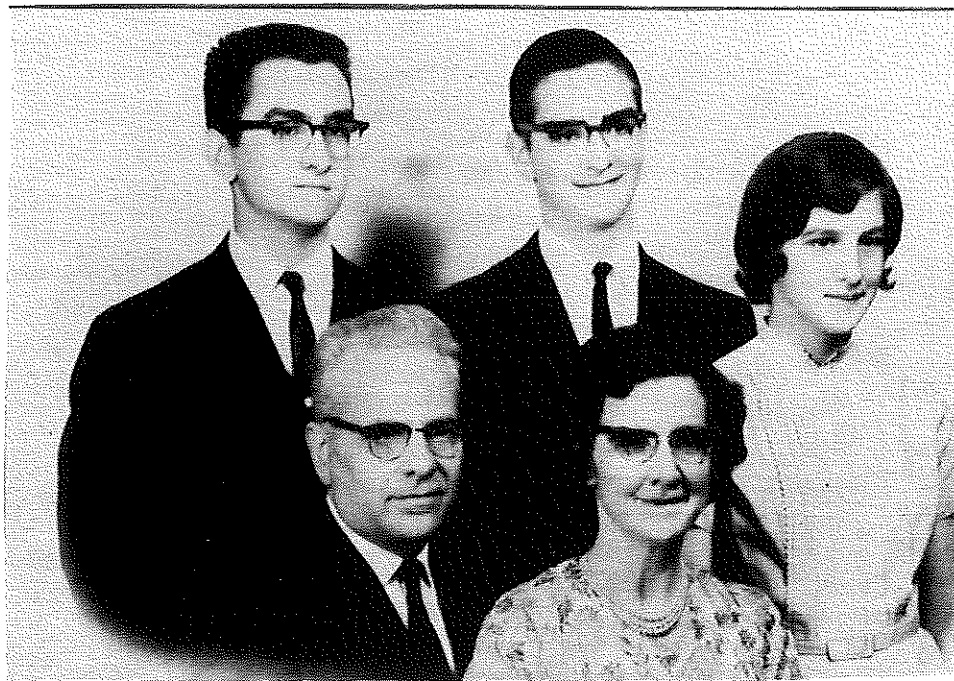

Carl and Hilda Hessler 1964
Charles, John and Katie

Raymond Hessler

Raymond Joseph Hessler (Gerhard and Katie Hessler's fifth child) was born on January 16, 1907. He graduated from the Millhousen elementary school and also attended the high school which operated briefly at Millhousen. Raymond left Millhousen about 1922 before he was 16. Raymond went to live with his brother Bill in Chicago. At night, Bill taught Raymond the basics of accounting, and in a few months Raymond got a job in Chicago as an assistant bookkeeper with the Great Atlantic and Pacific Tea Co. Raymond did not like the big city and being so far away from home. Within a year he moved to Indianapolis, where he worked as an assistant bookkeeper for the Rub-Tex Company, which made rubber battery boxes and floor mats for automobiles.

Raymond lived with his brother Albert for a year or two after he moved to Indianapolis. After a few months at Rub-Tex, Raymond decided he would prefer repairing watches to being a bookkeeper, and he found a jeweler named Fisch, who helped him at night to learn how to repair watches. In exchange, Raymond helped Fisch, who was Polish and had recently emigrated from Switzerland, improve his English. About 1924, Raymond quit his bookkeeping job and went to work full-time at Fisch's jewelry store located at 228 Massachusetts Avenue, in downtown Indianapolis, where the Indiana National Bank tower now stands. In 1940, Raymond purchased the store from Fisch and operated it until 1947, when he moved his family to California.

On August 21, 1928, Raymond married Myrteldia Cecilia Grider (usually called Cecilia), who was born on September 24, 1912, in Vincennes, Indiana. They met while Cecilia was working as a waitress at a restaurant across the street from the jewelry store where Raymond worked. Raymond moved to California with his family in 1947, primarily to get away from the cold Indiana winters. Raymond and Cecilia had three children: (1) Raymond Gerhard, (2) James, and (3) Shirley Ann.

When Raymond arrived in California, he did not have a job. He went to a jewelry supply house in downtown Los Angeles and asked if they knew anyone who needed a good watch repairer. They told him to try an address a few blocks away. When he arrived there, it turned out to be a trade school, not a jewelry store. He explained to the owner of the school what he had been told, and he was hired as the school's eighth instructor. Raymond taught in that school until 1952, when the number of veterans seeking to learn a trade had dried up and the school no longer needed him as a teacher. Raymond really enjoyed his job teaching watch repair, and he said those were the best five years of his life.

For the next 20 years, Raymond worked in a retail jewelry store in Sherman Oaks, California, until he retired in 1972. His wife Cecilia died on August 3, 1983. Raymond lives in his own home in Reseda, California. He continues to repair watches in his spare time at home. Raymond is still quite active and bowls once or twice a week. In May 1993, Raymond fell on the driveway while playing baseball with one of his great grandsons and broke his hip, but by late August 1993 he had discarded his cane and again was able to go bowling.

Children of Raymond and Cecilia Hessler

(1) Raymond Gerhard Hessler (Ray or Red) was born on November 27, 1929. He and his wife Diane have three children: (1) Melody Hessler, born June 8, 1957, (2) Raymond Richard Hessler (Ricky), born June 18, 1959, and (3) Mark James Hessler, born October 8, 1970.

(2) James Hessler was born on March 15, 1931. Jim worked in the computer business. He died of cancer in 1983. Jim and his wife Shirley Rose, who were married on December 8, 1952, had two children: (1) James Hessler, Jr. was born on July 15, 1956, and is married to Lisa; they have a son Brian, who was born in 1992, and (2) Cynthia (Cindy) Hessler, was born on July 6, 1963, and is married to Vic Griganivicius.

(3) Shirley Ann Hessler was born on April 10, 1934. She married Norbert Grochalski ("Ski") on September 10, 1955. They have five children:

1. Suzanne Grochalski (Susie) was born on May 16, 1958. She had two children by her first marriage. Now, she is married to Gary Rudolph. He has two children by his prior marriage, and Susie and Gary have one son Daniel. They have five children altogether: (1) Shannon Marie Mann, (2) Kristen Marie Mann, (3) Kelly Rudolph, (4) Kristin Rudolph, and (5) Daniel Joseph Rudolph.
2. Loretta Marie Grochalski was born on January 20, 1961. She is married to Alexander Kotichas.
Child: (1) Nicholas Alexander.
3. Joseph Richard Grochalski was born on March 3, 1963.
4. Angela (Angie) Grochalski was born on October 17, 1964.
5. Rosie Grochalski was born on December 24, 1973.

Carl August Hessler

Carl August Hessler (Gerhard and Katie Hessler's sixth child) was born on April 29, 1909. His godfather was August Vanderpohl, his great uncle, and his godmother was Maria Moenkedick. His baptismal name was "Carl Albert August," but I only learned that a few years ago when I saw it in the Millhousen church records. Carl was only 16 years old when his father died in January 1926. His brothers and sisters had all left Millhousen by that time, so Carl stayed at home to help his mother on the farm.

Carl worked at various part-time jobs in the Millhousen area for other farmers. In 1934, he was hired as a bookkeeper for the Public Telephone Corporation in Greensburg. He drove his Mercury to work in Greensburg five days a week, and others in the Millhousen often rode with him. Carl had learned accounting from his brother Bill, who recommended Carl for the job at the telephone company. Carl worked for the telephone company, except while serving in the Army, until he died on April 17, 1968. After Carl's death, the telephone company hired someone with an M. B. A. to replace him.

According to his cousin Helen Hessler (Sister Margaret Mary), Carl's nickname as a child was "Tundle." Helen also told me a story about Carl that his mother told Helen. Carl had come in from playing outdoors and asked for something to eat. His mother gave him a piece of bread with jelly on it. As Carl started out the door, both the cat and dog were there begging for some. Carl said, "Well, I ain't got much, but I'll wide [divide] with you." According to Helen, Carl was always patient and kind to everyone.

Carl met his future wife, Hilda Katherine Kuhn, while working at the telephone company. When Carl was drafted in 1942, Hilda substituted for Carl as bookkeeper at the telephone company. When Carl returned in late 1945, after serving with the U. S. Army in North Africa, Italy and France, he resumed his old job at the telephone company. Hilda and Carl were married on December 27, 1945. They had three children: (1) Charles Albert, (2) John Gerhard, and (3) Kathryn Alice.

Hilda Katherine Kuhn was born on February 7, 1914, and was the daughter of Charles Albert Kuhn and Claudia Alice Trimble. Hilda graduated first in her class at Greensburg High School in 1932. She worked as a secretary after high school, first for an attorney in Greensburg and then beginning in 1933 for the telephone company. Hilda worked for the telephone company until she was married. Hilda became a Catholic just before her marriage in 1945. Hilda and Carl lived at 530 East Central Avenue in Greensburg, in the house built by her parents in late 1913.

Hilda continued to live in Greensburg after Carl's death in 1968, and was active in church and volunteer groups. Since June 1992, Hilda has spent most of her time in a Catholic retirement home called Villa Siena in Mountain View, California, which is run by Dominican nuns.

Carl was very interested in farming and was active in managing the farm about a mile west of Greensburg that was given to Carl and Hilda by her mother, Claudia Kuhn. Originally, Hilda's grandfather Oscar Trimble bought that farm on the Vandavia Road. In 1962, Carl and Hilda purchased an adjoining farm. Carl also regularly read the Wall Street Journal and was very knowledgeable in business matters, even though he had not attended high school.

Carl and Hilda were active in St. Mary's Church in Greensburg, where Carl served as an usher for many years. Carl and Hilda both encouraged their children to be good students and were proud of the academic achievements of all three of their children.

Children of Carl and Hilda Hessler

(1) Charles Albert Hessler was born on September 22, 1946. He graduated from Indiana University in 1968 and has a master's degree in history from Stanford University and a law degree from Indiana University. Charlie served as a draftee with the U. S. Army in 1968-70; he was stationed in Giessen, Germany. On May 24, 1974, Charlie married Jane Wallace Titus. They met while they were attending law school in Bloomington. Jane is the daughter of Albert C. Titus and Jane Elizabeth McLaughlin. She was born on November 8, 1943, near Schenectady, New York, where her father was a chemist working for General Electric. Jane is a graduate of Duke University and received a master's degree in history from the University of North Carolina. She also has an M.S. in library science and worked at the Harvard library for about five years before law school. Charlie is interested in genealogy and gardening. Since 1980, Charlie has been an attorney with McCreedy and Keene, Inc., a pension consulting company in Indianapolis. Jane was hired in 1976 as an attorney for Eli Lilly & Co., and she currently works part-time for Lilly. Children: (1) Adam Titus Hessler, born December 25, 1979, and (2) Kathryn Ellen Hessler, born September 30, 1982.

(2) John Gerhard Hessler was born on May 2, 1949. John graduated from the University of Notre Dame in 1971 and was valedictorian of his college class. John has a Ph.D. in English from Stanford University, where he studied on a Danforth Fellowship. On January 3, 1976, he married Theresa Louise Dellamano, the daughter of Albert and Patricia Dellamano, at the Stanford Chapel. Theresa was born on May 19, 1952. John and Theresa met while she was a student at St. Mary's College, near Notre Dame. John worked for several years as a technical writer in the computer field and has taught English at the college level. Currently, John is a sales executive for Patson's Press, a printing company founded by his wife's parents, in Sunnyvale, California. Theresa is a registered nurse and currently works part-time at El Camino Hospital. Theresa is also a masters swimmer, and she and John are proud of their children's accomplishments as swimmers. Children: (1) Carl Joseph Hessler, born March 31, 1981, (2) Mark Gerhard Hessler, born July 27, 1982, (3) John Francis Hessler, born July 16, 1984, and (4) Walter Herman Hessler, born January 29, 1987.

(3) Kathryn Alice Hessler (usually called "Katie") was born on May 28, 1950. Katie graduated from the College of Mt. St. Joseph near Cincinnati and has an M.S. in library science from the University of Michigan. While in college, Katie spent a semester studying in Angers, France, and after graduation she worked in Troyes, France, as a governess for about six months. In late 1975, Katie moved to California to find a job in the San Francisco Bay area. On February 2, 1980, Katie married Robert Carl Rettenbacher in Half Moon Bay, California. Bob and Katie met through friends in Half Moon Bay, where Bob had lived for 10 years. Bob was born in Glendale, California, on August 2, 1946. His mother, Ellen Gazalla Rettenbacher, and his step-father, Richard Blackburn, moved from Half Moon Bay to Oregon in 1985. Bob is a graduate of the University of San Francisco and was a helicopter pilot in the U. S. Army during the Vietnam War. Bob works as a data technician for the San Mateo County Office of Education, and Katie is a computer systems analyst and currently works part-time. Their home north of Half Moon Bay is about a mile from the Pacific Ocean. Children: (1) Sarah Ellen Rettenbacher, born April 30, 1984 (adopted), and (2) Ryan Carl Rettenbacher, born June 19, 1986 (adopted).



Mary Mendkedick and her mother
Catherine (Stahl) Hessler (about 1922)



Wedding of Theresa Hessler & Charles Burkhart
January 28, 1925
(back row) Margaret Burkhart, Bill Hessler,
Albert Hessler, and Alma Burkhart

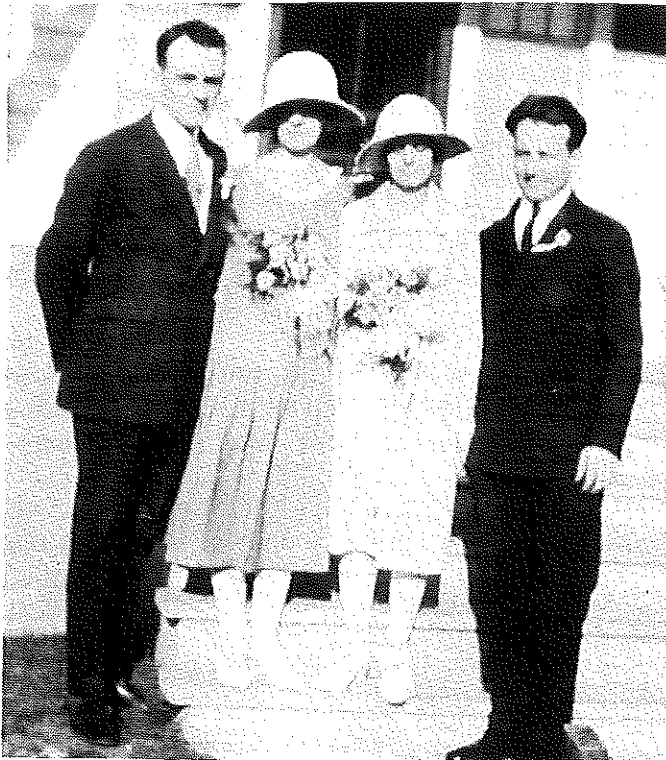

Wedding of William and Rosemary (Kalb) Hessler
June 13, 1925
Clarence & Florence Kalb, Rosemary, and William

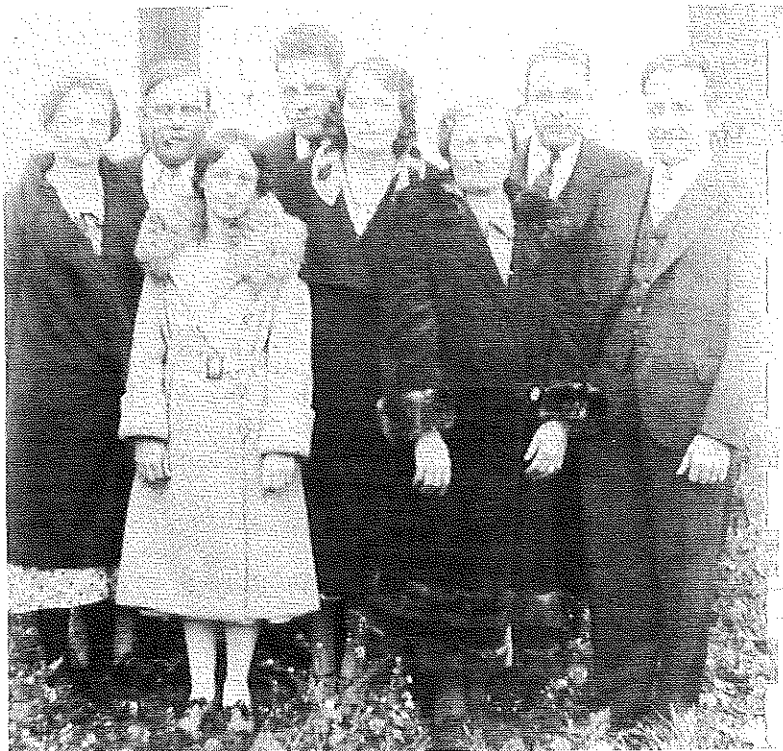

Theresa & Charley Burkhart, Rosemary (Toodles), Carl,
Freda, Katie (mother), Albert & Bill Hessler (about 1938)

Katie (Vanderpohl) Hessler with her chickens
(about 1925)

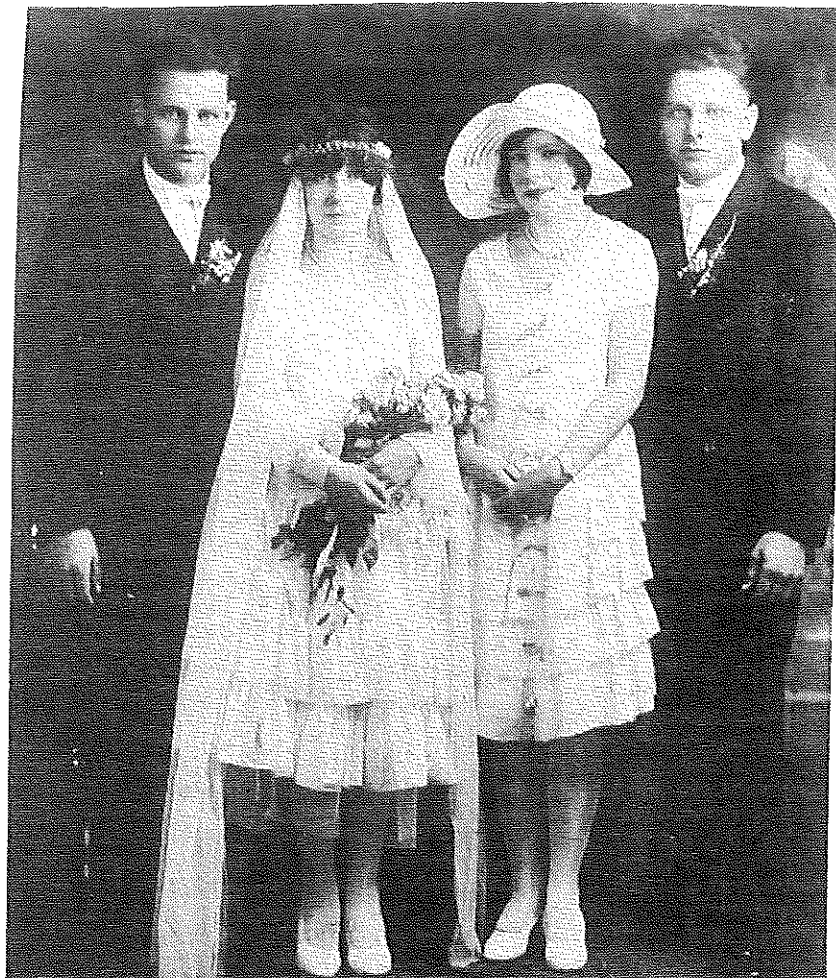

Wedding of Carl and Hilda (Kuhn) Hessler
December 27, 1945
Carl, Bill, Hilda, Rosemary (Toodles) Hessler

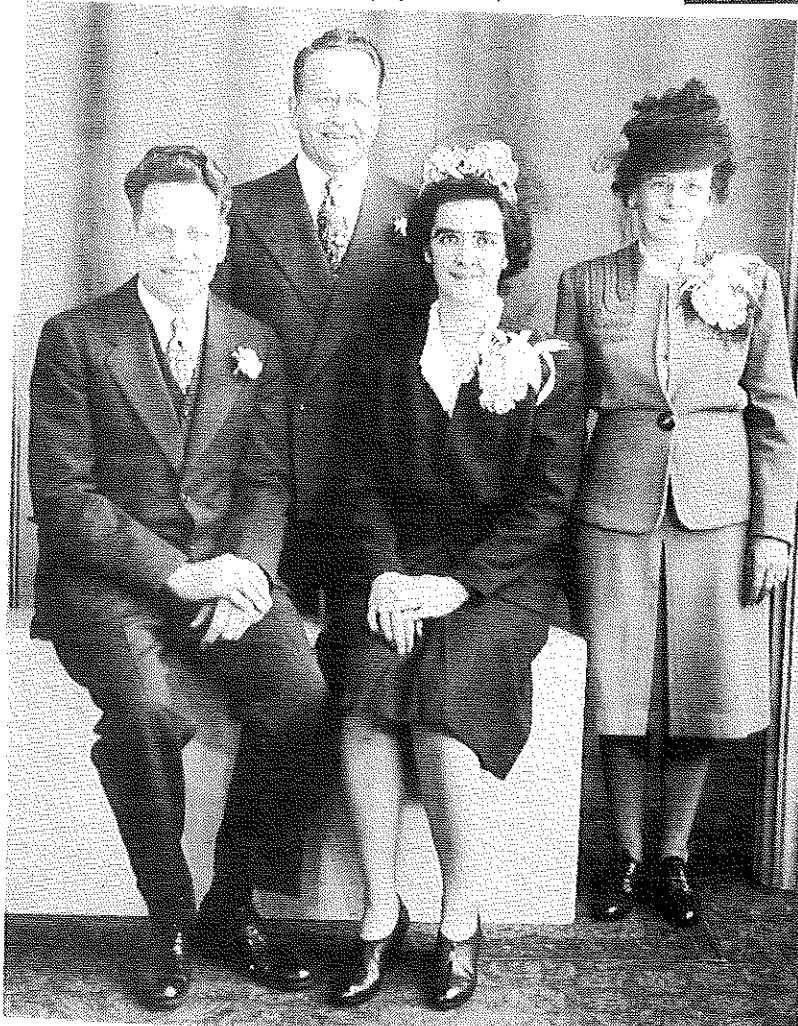

Wedding of Raymond Hessler & Myrteldia Cecila Grider
August 21, 1928
Raymond, Cecila, Cecilia's sister, Carl Hessler



Freda Hessler (about 1930)

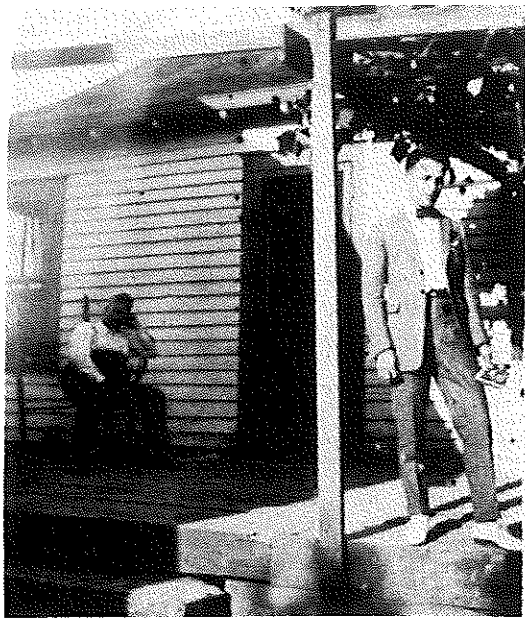

Gerhard Hessler (seated) and Bill Hessler
at home in Millhousen (about 1922)



Raymond and Carl Hessler about 1918,
with Grandma Theresa Vanderpohl



Hesslers & Burkharths (probably at Theresa's wedding, Jan. 1925)
Leona B. (Sister Ann Leo), Gerhard H., Carl H., Rosemary (Toodles) H.,
Katie H., Dave B., Johanna B., Raymond H., Paul B., Freda H., Nick B.



Carl Hessler and his mother Katie Hessler
at Louisville airport (about 1934)



Albert F. Hessler (about 1922)



Carl Hessler, Albert Hessler, Hilda Hessler,
Theresa (Hessler) Burkhardt (1957)

Theresa Hessler Burkhart

Theresa Antoinette Hessler, Gerhard and Katie's Hessler's oldest child, was born at Millhouse on September 3, 1899. Theresa helped her mother with the younger children, and then worked as a house maid for the Davidson and Zoller families in Greensburg and for the Lauck family in Indianapolis for a few years before she was married.

On January 28, 1925, Theresa married Charles Joseph Burkhart, the son of Joseph and Johanna (Minning) Burkhart. Joseph Burkhart was born on February 11, 1859, in Cincinnati, and died on December 7, 1922. Johanna Burkhart was born on August 23, 1871, and died on September 12, 1959. In her later years, Johanna Burkhart lived much of the time with Charley and Theresa Burkhart.

Charley and Theresa lived in a brick house on the Brookville Road, which was owned by the Burkhart family, and then bought a farm about five miles east of Greensburg, south of State Road 46. Theresa and Charles Burkhart were my godparents. I remember visiting them many times when I was a child, helping Aunt Theresa gather eggs and watching the cows being milked. Aunt Theresa usually asked us to stay for "a little lunch." I still remember her delicious coffee cake and bread.

Theresa and Charley Burkhart had six children: (1) Rosemary (Mrs. James Wallpe), (2) Luella (Mrs. Marvin Feldman), (3) Carl Joseph, (4) Thomas Louis, (5) William Edwin, and (6) Charles Edward. The last two were twins. Two other children died in infancy.

Charley Burkhart was a farmer. He used to play the violin at square dances and wedding parties. In later years, he was accompanied on the piano by his daughter Luella. Charley Burkhart died on February 11, 1958 (which would have been his father's 99th birthday if my information is correct). Theresa lived on the farm until she had a stroke about 1968. After her stroke, her children took turns caring for her in their homes for several years. Eventually, Theresa moved to a nursing home in Milan, Indiana, where she died on March 6, 1976.

Children of Charles and Theresa Burkhart:

(1) Rosemary Burkhart was born December 10, 1930, and married James Wallpe on September 6, 1952. Jim worked for many years as an electrician for Public Service and is now retired. They live near Batesville. They have five children:

1. Constance Joan Wallpe was born on July 15, 1953. Connie is married to Alvin Wuestefeld. Children: (1) Tim, (2) Eric, and (3) Lorrie.
2. Jerome William Wallpe was born on July 11, 1954. Jerry is married to Kathryn Rueff. Children: (1) Andrea, (2) Nathan, and (3) Christine.
3. Carolyn Sue Wallpe was born on January 10, 1957. Susie is married to Don Schwegman. Children: (1) Doug, and (2) Kevin.
4. Marita Jean Wallpe was born on December 22, 1960. Rita is married to Gary Meyer. Children: (1) Kayla, and (2) Grant.
5. Scott Anthony Wallpe was born on October 10, 1965.

(2) Luella Burkhart was born on June 7, 1935, and married Marvin Feldman on September 6, 1958. Marvin managed a Marsh supermarket for several years and currently runs a wholesale floral business. They live on the south side of Indianapolis, near Beech Grove. They have six children:

1. Barry Joseph Feldman was born on July 31, 1959. He is married to Kerry Culver. Children: (1) Blake, (2) Lydia, and (3) Ross. Lydia and Ross are twins.

2. Brian Anthony Feldman was born on October 16, 1960. He is married to Tara Baltzer. Children: (1) Brittany, and (2) Kelsey.
3. Nancy Ann Feldman was born on August 19, 1962. She is married to Dwayne Sowers. Child: (1) Jacob.
4. Bruce Alan Feldman was born on July 24, 1965.
5. Brent Patrick Feldman was born on March 12, 1967.
6. Brad Michael Feldman was born on April 10, 1978.

(3) Carl Joseph Burkhart was born August 8, 1937, and married Elizabeth Ley on May 9, 1959. Carl Joe has worked in the Greensburg area for many years and is currently an insurance agent and a realtor. They have five children:

1. Kathy Lynn Burkhart was born on March 30, 1960, She is married to Monty Shields. Children: (1) Joey, (2) Joshua, and (3) Jacob.
2. Michael Joseph Burkhart was born on April 1, 1961.
3. Deanna Sue Burkhart was born on October 23, 1964. She is married to John Fox. Children: (1) Bradley, and (2) Jason.
4. Patricia Jean Burkhart was born on November 5, 1965.
5. Regina Marie Burkhart was born on April 17, 1970. She is married to Bill Treash.

(4) Thomas Louis Burkhart was born August 15, 1939. He served in the U. S. Army in Germany. Tom married Mamie Gray on October 21, 1967. Tom has worked for Arvin for many years, and he met his wife while he was working in an Arvin plant in Kentucky. They currently live in Hixson, Tennessee, near Chattanooga. Children: (1) Sarah Evelyn Burkhart, born September 5, 1968; and (2) Martha Sue Burkhart, born February 24, 1970.

(5) William Edwin Burkhart was born on August 5, 1941, and married Ethel Shadday on May 22, 1971. Bill works for the BCA plant in Greensburg, and they live near Greensburg. Children: (1) Jared William Burkhart, born October 5, 1973; and (2) Ryan Matthew Burkhart, born May 3, 1978.

(6) Charles Edward (Ed) Burkhart was born on August 5, 1941, and married Joanne Buening on October 10, 1964, at Millhousen. Ed works for Sears in Indianapolis, and they live near Greensburg. Children: (1) Darren Charles Burkhart, born September 23, 1966; (2) Annette Lynn Burkhart, born February 13, 1969; married to Gary Hunger; and (3) Karen Diane Burkhart, born April 3, 1973.

William Gerhard Hessler

William Gerhard Hessler (Gerhard and Katie Hessler's second child) was born in Kokomo on March 18, 1901. After attending school at Millhousen, he went to work for John E. Robbins, a prominent farmer, who lived a couple miles south of Greensburg. Later, William (or Uncle Bill, as I have always called him) studied law and accounting at Cumberland University (now called Samford University) in Tennessee. Bill worked for the Pennsylvania Railroad in Indianapolis, where he met his future wife Rosemary Kalb. After working in Indianapolis for several years, Bill took a job in the Chicago area.

Rosemary Agnes Kalb was born in Indianapolis on October 8, 1899, and was the daughter of George P. and Catherine (Newman) Kalb. Bill and Rosemary were married on June 13, 1925, at Summit, Illinois. Rosemary's nickname, "Toodles," can be traced to a comic strip character in the early 1900s, known as "naughty Toodles." Apparently, some of her family thought Rosemary was just like naughty Toodles.

Bill returned to Millhousen with his family about 1933 during the Depression to study for his CPA exam. At that time, he helped his brother Carl, who was living at home with their mother, to study accounting. Then, when Bill Scheidler, the president of the telephone company in Greensburg, asked Bill if he knew someone who would make a good bookkeeper for the telephone company, Bill persuaded Scheidler to give his brother Carl a chance at the job. About 1935, while living in Millhousen, Bill and his brother Carl, with help from Bill's son Billy, wired the family home for electricity.

After successfully completing the CPA exam, Bill and his family settled in the Chicago area, where Bill worked for an accounting firm. Bill and Toodles had three children: (1) William Gerhard, (2) Marilyn, and (3) Rosemary. After World War II, Bill worked for the American Occupation Government in Japan. Before returning home, Bill and his wife toured China, just before its fall to the Communists in 1949. Bill and Toodles lived in the Chicago area during the 1950s, and my family visited them twice in their home in LaGrange. Bill worked for an international accounting firm in downtown Chicago, and I remember his giving me several envelopes with Swiss stamps that he had received from an accounting client.

About 1959, after his children were all married, Bill moved to Lafayette, Indiana, to manage a bowling alley that he owned with his brothers Albert and Carl. Toodles was an excellent cook, and I enjoyed my visits with them. After several years in Lafayette, Bill and Toodles moved to LaPorte, Indiana, where he worked as an accountant for a small manufacturing company. Later, he returned to Lafayette to oversee the bowling alley, and they purchased a house about five miles south of Lafayette.

After Bill retired, he and Toodles lived first in Mooresville and then in Franklin, Indiana. Bill and Toodles were active in St. Rose of Lima Catholic Church in Franklin, and they celebrated their 50th wedding anniversary there in 1975. Bill died in Franklin on September 26, 1980, and is buried in Holy Cross Cemetery in Indianapolis. After Bill's death, Toodles and her daughter Marilyn moved to Tucson, Arizona, where they currently live. In September 1993, Toodles was seriously ill.

Children of William and Rosemary Hessler:

(1) William Gerhard Hessler, Jr., was born on May 20, 1926, in Chicago, Illinois. He married Kazuko (Peace) Yonetsu on June 2, 1956. Peace was born on April 15, 1927, in Tokyo. "Peace" is the English literal translation of the Japanese name "Kazuko." Peace graduated from Kelo University in Japan with a law degree. Bill graduated from Purdue University with a degree in electrical engineering in 1946 and received an M.B.A. from Northwestern University in 1956. Bill worked for Goodyear as a senior computer systems analyst until his retirement. Peace worked for C. Itoh, a large Japanese conglomerate, in its American operations until her retirement. Bill and Peace live in Cuyahoga Falls, Ohio, near Akron. They have four children:

1. Martha (Marty) Hessler was born on August 15, 1957, in Chicago. Her first marriage to Jim Justham ended in divorce. They had one daughter, Truly, who has been adopted by Marty's second husband, Donald Davies. Marty, Don and Truly live in Akron, Ohio.
2. George Yonetsu Hessler was born on August 11, 1959, in Chicago. He is a graduate of Harvard College and has an M.B.A. from Harvard Business School. On November 4, 1989, George married Carol Anne Mateer. Carol is a graduate of Wellesley College and has a law degree from New York University. George works as an investment banker in New York City, currently for Prudential Securities. Carol works as a corporate attorney with a large Wall Street law firm (Rogers & Wells).
3. Kay (Kei) Hessler was born on June 25, 1964, in Akron, Ohio. She was married to Michael Maag, and they had one son Jonathan, who was born on October 22, 1987. Kei Maag is now divorced and lives in Cuyahoga Falls, Ohio, where she works for a printing company.
4. Emmy Yonetsu Hessler was born on April 6, 1966, in Akron. Emmy is a graduate of Wellesley College and expects to receive a law degree from the University of Chicago in June 1994. She clerked for a Wall Street law firm (Skadden, Arps) in their Boston office in the summer of 1993.

(2) Marilyn Hessler, (Bill and Toodles' second child) was born on April 24, 1927, in Chicago. She married Donald Schneider on April 23, 1949. They were divorced in 1965. Marilyn worked for several hospitals as a medical records specialist and is now retired. She now lives in Tucson, Arizona, and cares for her mother. Marilyn Schneider has three children:

1. Robert Schneider was born on October 31, 1950. Bob married Jan Kolodziej, and they live in Schererville, Indiana. Bob works for Amoco in downtown Chicago. Children: (1) Jennifer, born April 6, 1988, and (2) Lauren, born April 24, 1990.
2. Rosemary Schneider was born on May 5, 1953. She attended Immaculate Conception Academy in Oldenburg, Indiana. Rosie is single and lives in Lombard, Illinois.
3. James Schneider was born on July 12, 1954. Jim married Pat Heidenblut who had a son John, who was born on January 9, 1978, before Jim met Pat. Jim and Pat had a son, Jimmy, who was born on August 7, 1981. Jim and Pat are divorced, and Jim has custody of both John and Jimmy. Jim lives in Villa Park, Illinois.

(3) Rosemary Hessler (Bill and Toodles' third child) was born on December 28, 1936, in Blue Island, Illinois. She married Donald Kraman in LaGrange, Illinois, on July 6, 1957. They are divorced. Rosemary lived for several years in Florida and Texas, before moving to the Tucson area. Rosemary Kraman has four children:

1. Judith Marie Kraman was born on October 4, 1958. Judy married Jonathon Shea, and they live in Richardson, Texas.
2. David Marion Kraman was born on May 31, 1960. David graduated from the University of Arizona in 1990 and lives in his own apartment in Tucson, Arizona.
3. Michael Francis Kraman was born on May 12, 1961. Michael married Tammy Watson, and they have a son, Michael Wayne, who was born on April 4, 1992. They live in Plano, Texas.
4. Madeleine Marie Kraman was born on July 22, 1963. Madeleine married Eric Engstrom. They live in Tucson, Arizona.

Freda Hessler Penish

Freda Hessler (Gerhard and Katie Hessler's third child) was born January 25, 1903. Grandma Hessler took her to be baptized and wanted her to be named Seraphine, so she was baptized as "Catherine Seraphine Fredericka," but she was always called Freda.

Freda married Rochford Simmons on October 15, 1921. They had one child, Edith, who was born on August 22, 1922, and died on January 16, 1969. Freda and Rochford were divorced. On April 21, 1949, Freda and Harry Penish were married. Harry Penish, was born on April 4, 1906, in Indianapolis. Harry worked a salesman in Indianapolis. Harry and Freda moved to California in the early 1950s and lived for many years in Reseda, where Freda died on May 15, 1979. Harry returned to Indianapolis in late 1979 and lived in an apartment near 86th and Ditch Road until his death about 1987.

Albert Francis Hessler

Albert Francis Hessler (Gerhard and Katie Hessler's fourth child) was born October 25, 1904. After attending barber school in Indianapolis, Al worked as a barber in the Indianapolis area for many years. On February 16, 1940, he married Mayme Harbaugh at Brownstown, Indiana. Mayme was born on May 25, 1903; her parents were Charles and Cella Harbaugh, who lived in Freetown, Indiana. Mayme worked for State Farm Life Insurance Company in Indianapolis for 17 years, quitting in 1940. Al contracted polio shortly after his marriage, and Mayme cared for him in their home. Al responded well to the Sister Kenny treatment, and he was able to return to work after a year or two.

During World War II, Al worked at the Esterline factory in Speedway assembling radios. This job allowed him to sit down most of the time, which was important since his legs were still weak from his bout with polio. Later, his legs became strong enough for him to return to barbering. He owned his own shop at 30th and Lafayette Road in Indianapolis for many years. In 1953, Al and Mayme were in a serious auto wreck while travelling in Iowa. Al was hospitalized for about a month, and in later years he had difficulty walking due to his injuries in that wreck, as well as the lingering effects of polio. After living in Speedway for many years, Al and Mayme moved to Brownsburg about 1959.

Mayme was deaf when I knew her, and we children always enjoyed writing notes to her on the erasable slate that she always carried with her. She could also read lips, but she seemed to prefer her slate. Mayme loved children and she was always full of life. Mayme enjoyed gardening. Al and Mayme had a black poodle named Pierre for many years.

About 1969, Al retired, and he and Mayme traveled throughout the country, finally buying a home in Pinellas Park, near St. Petersburg, Florida, where they spent their retirement years. Mayme died on March 25, 1982 in Pinellas Park, Florida. I visited Al in Florida several times after Mayme's death. Al told me a number of stories about his childhood in Millhousen. The one that I most remember concerned his grandmother Theresa Vanderpohl who spent practically the whole day at their house. Every night she would walk to her own house down the lane that runs to the left of the brick house; I think this property was owned by Christian Ruhl when the 1867 Decatur Co. map was published. When Grandma Vanderpohl would arrive home, she would put a kerosene lamp in her window as a signal to let everyone know she got home safely.

Al died in his Pinellas Park home on April 8, 1992. In his last years, he often talked of returning to Millhousen for one more visit. His funeral Mass was celebrated by Monsignor Raymond Bosler at the Millhousen Catholic Church on April 13th, with all five of his Burkhart nieces and nephews from Indiana, his sister-in-law Hilda Hessler, his great nephew Bob Schneider, Pat Williams (the nurse who cared for him in his Florida home), and me (Charlie Hessler) and my family in attendance. Two great nephews, Eric Wuestefeld and Ryan Burkhart, were servers at Al's funeral Mass. Al and Mayme are buried in Washington Park North Cemetery in Indianapolis.

ANDREW ADAM & KATHERINE (ENDERLIN) HESSLER

Andrew (Andy) Adam Hessler b/Oct.23,1879 at Millhousen the son of Adam & Catherine Hessler. He attended Catholic school at Millhousen, In. and graduated from the 8th grade. He worked as a young man for his fathers farm and lumber business. In the winter when it was cold and they would have to take the horse drawn wagon, with loads of lumber to Cincinnati, they would get out and walk to keep themselves warm during the trip.

He was married on Aug.13,1901 at Millhousen In. to Katherine Theresa (Enderlin). Katherine (Kate) Enderlin was born July 22, 18 . She was the daughter of Ignatious & Elizabeth Enderlin. She was one of four children John;George;Rosalee;Gerome;Kate. Her family lived near Napoleon In. and attend St. Maurice Catholic Church in Napoleon.

Andrew and Kate lived on a farm he purchased, North East of Millhousen in Sandcreek township. He also owned some land in Jennings County as they were near the county line.

The children attended an one room School called Hamburg.

Andrew and his brother Gerhart Hessler, started a business building bridges in Decatur Co. but the business catch on.

On Andrew and Kate's 10th wedding anniversary, they had a big celebration at their farm. All of the nearby family members attended.

Andrew farmed and did a little lumbering. Kate made homemade bread, and canned vegetables from the garden. She would make homemade applesauce. They would build a fire out side, and would clean a large kettle with vinegar, then would hang it over the fire to cook the apples. They had a large paddle with a long wooden handle to stir without get to close to the fire.

Angeline remembers that her grandma(Catherine(Stahl)) Hessler's left hand would shake so much that Angeline was sure that grandma Hessler would drop her cup when she would hold it, but she never did. She would put her other hand on the badly shaking one to slow it down but it still shook.

Their son Cressie never married and helped his father out on the farm when he got older. Kate's parents Ignatious and Elizabeth Enderlin lived with Andy and Kate in thir later years.

Andrew always said that he would never own a car or a tractor, but eventually did own both. His first tractor was a John Deer. His first car was a Moodel T used around 1924.

Andrew and Kate Hessler were members of the St. Dennis Catholic church, which was near their farm.

Andrew Adam Hessler died on Jan.9,1948 in Decatur Co. Indiana Kate (Enderlin) Hessler died on June 21,1947 in Decatur Co. Indiana. The farm was sold after Andrew's death.

Andrew and Kate Hessler were the parents of 5 children;

1. Arealea Hessler was b/June 27,1902 . She was married 3 times;first husband was Dr.Charles Wood of Westport; after he past away she married Bower Rork, he died of a heart attack.She remarried to Roy Ziegler. Arealea lived in Westport, she had no children.

2. Marcella Hessler was b/May 9,1904. She married George Vanzant and lived in New Castle Indiana. She worked at the Hospital in New Castle IN. her husband was the Fire Chief of New Castle for 25 years. He also worked for the State Fire Marshall. They had one child Robert Vanzant, who married Anne Beitz. They own a bakery in Rushville In. they have two children; Rex, who married marsha and live in Richmond. Scott Vanzant married Tammy. Scott has a Phd. from Kent Univ. and live in Maryland.

3. Angeline Magdeline Hessler was b/March 28,1906. She graduated from I.U. and was a school teacher. She was married on June 12,1928 to Roman Ebbing b/Dec.9 1895. They had two children;1.Kenneth Ramone /March 15,1930 married Patty Brinkman they three children;Leslie Ann;Kent Ramone m/Kathy Holtzer(Kent,Kameron);Kelly Jean. They live in Indianapolis, Indiana. 2.Charles Edward April 19,1935 and married Kathleen Guppy. They live in Fayetteville, N.Y. They have four children: Daniel Raymond who married Marie White(child:Kate Louise).David Michael who married Melanie Kime. two child(Eric,Jennifer). Debra Ann who married Paul Sgroi(Jordan,Jeremy). Dennis Edward who is not married.

4.Marietta Hessler was b/Nov.9,1908. She married Earl Layton. They lived in Decatur County. They had four children: James, Norman who married Betty- and is a math teacher at South Decatur, Betty who married Gayle Gatewood and lives at Westport. child (Aaron) ,Helen who married Ronald Graue two child(Jeff,Gregg).

5.Cressie Hessler was born on Aug.17,1910 Millhousen, Indiana, in Decatur Co. Indiana. He fought in the U.S. armed service in World War II. and was stationed for a while in Germany. After he returned he helped his father out on the farm for a while, and then was employed at a factory in Columbus, In. He currently resides in Westport, In.

FAMILY OF ANDREW ADAM HESSLER

Marietta Marie Hessler married Earl Joseph Layton
(11/07/08 - 10/25/88) (1/6/01 - 2/4/65)

They had four children.

1. James Earl Layton
Born March 3, 1938
Ocala, Florida
2. Norman Joseph Layton
Born March 26, 1939
Greensburg, Indiana
3. Mary Elizabeth Layton
Born October 20, 1944
Greensburg, Indiana
4. Helen Catharine Layton
Born May 21, 1946
Greensburg, Indiana

James Earl Layton married Edna Vora Caffee on
April 23, 1966 in Austin, Indiana.
Edna was born March 3, 1935 in Edmonton, Kentucky.
Their mailing address is P.O. Box 22, Westport, Indiana. 47283
They have one son.

1. Jimmie Anthony Layton
Born May 23, 1967
Columbus, Indiana

Norman Joseph Layton married Betty Ruth Bussburg on
June 26, 1960 at the Union Baptist Church, County Road 400 South,
Greensburg, Indiana.
Betty was born in rural Greensburg on May 10, 1939.
They reside at 3680 Layton's Drive, Westport, Indiana 47283.
They have three sons.

1. Robert Earl Layton
Born March 31, 1967
Columbus, Indiana
2. Anthony Wade Layton
Born March 16, 1974
Greensburg, Indiana
3. Kevin Michael Layton
Born June 24, 1977
Greensburg, Indiana

Norman Joseph Layton graduated from Franklin College in 1965
with a Bachelor's degree in Elementary Education. Norman earned
his Masters degree from Indiana University in 1968.

Mary Elizabeth (Betty) Layton married Gayle Gatewood on November 15, 1963 in Westport, Indiana. Gayle Gatewood was born in Shelby County, Kentucky on November 1, 1934. They reside at 311 South Lincoln Street, Westport, Indiana 47283. They have two sons.

1. Bryan Scott Gatewood
Born August 16, 1964
Columbus, Indiana
2. Darian Thomas Gatewood
Born March 12, 1971
Columbus, Indiana

Bryan Scott Gatewood graduated from Rose Hulman Institute of Technology in 1986 with a Bachelor of Science degree in Electrical Engineering.

Darian Thomas Gatewood will graduate from Rose Hulman Institute of Technology in May of 1994 with a Bachelor of Science degree in Mechanical Engineering.

Helen Catharine Layton married Ronald Paul Graue on April 10, 1965 in Jamestown, Tennessee. Ronald was born on November 15, 1945 in Batesville, Indiana. They reside at 712 South Russell Drive, Greensburg, Indiana. They have two sons.

1. Gregory P. Graue
Born February 8, 1967
Columbus, Indiana
2. Geoffrey Cale Graue
Born September 19, 1971
Columbus, Indiana

Gregory P. Graue graduated from Indiana University in 1989 with a Bachelor of Science degree in Mathematics. Greg is presently studying for a Master in Arts degree in Mathematics from Indiana University.

Geoffrey Cale Graue is presently attending IUPUI in Indianapolis working on a Bachelor of Science degree in Health Administration.

Stahl

M/J. Jacob Stahl b/1802 Germany
 d/1870 Ripley Co. Indiana
 Catharina Griner b/1803 Bavaria Germany
 d/ Napoleon In.

THEIR CHILDREN:

1.1827	2.1829	3.1833	4.1833	5.1836	6.1837	7.1838	8.1839	9.1845	10.	11.	12.13
Catherine	Elizabeth	Johann	Henry J.	Jacob	Heinrich	George	Adam J.	Catherine	Anna Maria	Nario	
died young	died young	m/Catherin Shroder	Catherine Mandel	Margaret Fiffer	m/?	m/Anna Mary Hessler	m/Margaret Hessler	m/Adam J. Hessler	b/1834 died m/young	John Hessler	
		child: 1. Jacob m/Marietta Smith	child: 1. Frederik m/Rosa Hines	child: 1. Frederik m/Louise Mistler		child: 1. John m/Mary Richey	child: 1. George m/Mary Shrader	child: 1. Mary 2. John 3. Frank 4. George 5. Adam 6. Gerhart 7. Henry		1. Clarence d/1978	2. Albert d/1979
		2. Theresa died young 3. Adam died age 27 not marr. 4. George m/?	(Harry, Irvin, Alma & 2 boys) 2. Jacob m/? 3. Adam Ed. m/Louise Mistler (Arealia, Monica, Louise, Ollie)			(Clarence, Will, Elizabeth, Art, Carl, Herman) 2. Catherine died at age 3 3. Anna died at age 1 4. Anna Mary m/James Kirby (6 children) 5. John Adam m/died at age 3 6. Margaret m/Arthur Coyle (Agnes, George, Ray, Anna Mary, Rose, James, Mary, Dorothy, Leonard,)		(see Below) 3. Lewis H. m/Anna Vandembosch (Margaret, Rudolph, Paul, Rosalie) 4. Anna M. Luvina m/Henry Kinney (William, Christine, George, Charles) 5. Charles Jacob m/Elsie E. Jessup (Francis, Agnes, Clare)			

(children of Catherine & Adam Hessler)

1. b/1866	2. b/1868	3. b/1871	4. b/1873	5. b/1875	6. b/1876	7. b/1878	8. b/1879
Mary m/Joseph Menkedick child:	John Hessler as infant	Frank John m/Mary Rutt child:	George (BOB) m/#1 Viola Herbert child:	Adam m/#1 Francis m/#2 Ida Wagner child:	Gerhart Vanderpohl child:	Henry died as infant	Andrew m/Kate Underline child:
1. Theresa m/Louis Moorman (Lawrence, Stella, Alma, Lucille, Martha, Mary, Ralph, Carl, Eileen, Walter)		1. Philomona m/Herman Veercamp (12 child)	1. Fred m/Catherine Wagner half brother	1. Anna m/John Dwenger	1. Theresa m/Charles Burkhardt (Rosemary, Luella, Tom, William, Charles)		1. Arealia m/#1 Roy ziegler m/#2 Charles Wood (no children)
2. Louis m/Elizabeth Parr (Mary, Thelma,)		2. Francis m/Theresa Hardebeck (2 child.)	2. Thelma m/Jim Darby (Dale, Deloran, Jim, Donna)	2. Andrew	2. William m/Rosemary Kalb (William, Marilyn, Rosemary)		2. Marcella m/George Vannant (Robert)
3. Catherine m/Lawrence Duerstock (Margaret, Norbert, Ken, Helen, Rita, Urb, Cyril, Marvin) Vincent)		3. Mary m/Harry Dwenger (10 child)	3. Rose m/Clarence Hardebeck (Tony, Bill, Marletta, Norman, Mary, Margaret, Betty)		3. Prada m/#1 Hochford Blimmon (With Simmons) m/#2 Harry Ponniah		3. Angellina m/Ebbing (Roman, Charles)
4. Henry m/Catherine Wenning (Carl, Alfred, Edna, Harold, Cliff, Mary Ellen)		4. Matilda m/Clem Stuhrenburg (11 child.)	4. Elsie m/Ralph Sealing (Jim, Jerry)		4. Raymond m/Cecilia Grider (Raymond, James, Shirley)		4. Mary Etta m/Earl Layton (James, Norman, Mary, Helen)
5. William m/Helen Draping (Dale, Irene)		5. Cecilia m/Bernard Harping (8 child)	5. Lester (died age 24)		5. Albert m/Mayme Harbaugh (no children)		5. Gracie never married
6. Joseph m/#1 Gertrude Welmer m/#2 Rose Schoettmer (Tom, Gertrude)		6. Rose (a nun)	6. Alvin (died age 2)		6. Carl m/Hilda Kuhn (Charles, John, Catherine)		
7. Anna died at age 1 1/2		7. Clara m/Geo. Waderman (8 child)	7. Henry (died age 1)		7. Lidia Died Young		
		8. Joseph m/Bernice Wenning (5 child.)					
		9. Bobbie m/Clem Koors (6 child.)					
		10. Christine m/Alvin Cord (2 child.)					
		11. Hildegard					
		12. Lawrence					
		13. Aloysius					
		14. Helen (sister Margaret Mary)					
		15. Margaret Agnos					

Jacob and Catherine(Grimes) Stahl

Johann Jacob Stahl, was born on April 12, 1802 in Bavaria Germany. He apparently went by his middle name of Jacob. He was believed to be a stone mason in Germany.

He was married to Catherine Greiner sometime before 1837 in Bavaria Germany. Catherine Greiner was born on Nov. 8, 1803 in Bavaria Germany. Their children were all born there, in Lemberg, Pfalz, Bayern Germany(Bei Pirmassens) This is an area at the northern boarder of Alsase Loraine.

Family hearsay says that Jacob Stahl came to America because he wanted a new start for his sons, and he did not want them serving in the Kaiser's army.

He was 51 yeras old when he and his family boarded the ship, Georgia, on June 30,1852. They left from Le Harve Degrace, France and arrived at New York Harbor on the 17th day of July, 1852.

Family hearsay also says that when he came to America he first stopped at Wheeling West Virginia and then came to the Napoleon area, in Ripley County ,Indiana.

Jacob Stahl was naturlized in Ripley County Indiana, on Sept. 10,1852, shortly after arriving in the U.S.

He purchased 80 acres of land on section 3, township 9, range 11 in Ripley County. Here he establised a farm which he improved and built upon. This is where he lived until the time of his death in 1870.

Jacob and Catherine were members of the St. Maurice Catholic church at Napoleon Indiana.

Jacob Stahl made a will, dated May 11, 1870, only a month before he passed away. Jacob Stahl passed away on June 12, 1870. Catherine died on September 8, 1885. They are buried in the St. Maurice Catholic church Cemm. in Ripley County, IN

Jacob and Catherine had "thirteen children", seven of which grew to maturity. Their children were:

- 1.Catherine Stahl b/Jan.15, 1827 Lemberg Pfaltz, Germany. Died as a young child in Germany.
2. Elizabeth Stahl b/July 17, 1829 also died as a young child.
3. Johann Frederich Stahl b/Dec.26,1832 m/Catherine Shroader. They had four children:Jacob,Theresa,Adam,George.
4. Henry J. Stahl b/Jan. 23,1933 m/ Catherine Handle. They had five children:Frederick,Jacob,Adam Ed.,Mary,Elizabeth.
5. Heinrich Stahl b/1837 Germany no other information.
6. Johann Jacob Stahl b/1835 m/1870 Margaret fiffer.
7. George Stahl b/Feb.3, 1838 m/ Anna Mary Hessler. They had eleven children: John,Catherine,Anna Catherine,Anna Mary,John, Margaret,Henry,Mary,Joseph,Leo.
8. Adam John Stahl b/March 31, 1839 m/1866 Margaret Hessler. They had five children:George,Frederick,Lewis,Anna Mary,Charles Jacob.
9. Catherine Stahl b/Feb. 6, 1845 m/1865 Adam John Hessler. They had 8 children:Mary,John,Frank,George,Adam,Cerhart, Henry,Andrew.
10. Anna Maria Stahl b/1848 m/John Hessler. They had two children: Clarence and Albert.
11. Marie Stahl b/1852 died young. two other children were born to them but I have no information on them.



Greiner
CATHERINE (~~GREINER~~) STAHL
born: Nov. 8, 1803 Bavaria, Germany (Lemberg)
died: Sept. 8, 1885 Millhousen, Indiana

wife of J. Jacob Stahl
[Mother of Catherine (Stahl) Hessler]

CATHERINE GRIMES STAHL
(WIFE OF JACOB STAHL)

B/1803

THE WILL OF JACOB STAHL

I Jacob Stahl do make and publish this my last will and testament. 1st - I give and devise to my beloved wife Catherine Stahl in Lieu of her interest in my lands, the farm on which we now reside. Situated in the county of Ripley, in the State of Indiana; and described as follows to wit: being the East half of the North of Range Eleven(11) East, in the District of lands subject to sale at Jeffersonville Indiana containing eighty acres, more or less during her natural lifetime. Also and all the stock, household goods, furniture, provisions, and other goods and chattels, moneys, effects ect... which may at the time of my decease during her natural life as aforesaid. She however, selling so much thereof as may be necessary to pay my just debts.

It is further my will, that my wife can do with said property as she deems proper at her own pleasure without interference of my children or the laws of the State of Indiana; providing my wife shall erect a tombstone on my grave. 2nd - It is my will that at the decease of my said wife, my son Adam shall receive the sum of forty dollars with interest at the rate of six percent from the time of my decease.

3rd - It is my will that at the decease of my said wife my daughter Anna Marie Hessler, shall receive One hundred dollars with interest at the rate of six percent from the time of my decease.

4th - It is my will that at the decease of my said wife, all the property remaining excepting as herein provided shall go to my Children, to wit: Frederick, Jacob, Heinrich, George, Adam, Catherine, & Anna Mary equally.

5th - It is my will that at the time of my wife's decease that my said children, shall erect a tomb stone on each of our graves.

I do hereby break all former wills, by me made. In testimony hereof I have set my hand and seal the eleventh(11) day of May (AD) 1870.

Jacob Stahl

signed by said Jacob Stahl as his last will and testament, in our presence and signed by us in his presence.

Witnesses: Frederick Ehrhart and John Westrop

Witnesses: Hagar of. Place hereinto. Subscribes my name, and affords the Seal of said Court at Newburgh this 11th day of May 1870
John H. Smith Clerk
Circuit of Tennessee Newburgh May 11th 1870

The Will of Jacob Stahl

I Jacob Stahl do make and publish this my last will and testament. 1st - I give and devise to my beloved wife Catherine Stahl in Lieu of her interest in my lands, the farm on which we now reside. Situated in the county of Ripley, in the State of Indiana; and described as follows to wit: being the East half of the North of Range Eleven(11) East, in the District of lands subject to sale at Jeffersonville Indiana containing eighty acres, more or less during her natural lifetime. Also and all the stock, household goods, furniture, provisions, and other goods and chattels, moneys, effects ect... which may at the time of my decease during her natural life as aforesaid. She however, selling so much thereof as may be necessary to pay my just debts.

It is further my will, that my wife can do with said property as she deems proper at her own pleasure without interference of my children or the laws of the State of Indiana; providing my wife shall erect a tombstone on my grave. 2nd - It is my will that at the decease of my said wife, my son Adam shall receive the sum of forty dollars with interest at the rate of six percent from the time of my decease.

3rd - It is my will that at the decease of my said wife my daughter Anna Marie Hessler, shall receive One hundred dollars with interest at the rate of six percent from the time of my decease.

4th - It is my will that at the decease of my said wife, all the property remaining excepting as herein provided shall go to my Children, to wit: Frederick, Jacob, Heinrich, George, Adam, Catherine, & Anna Mary equally.

5th - It is my will that at the time of my wife's decease that my said children, shall erect a tomb stone on each of our graves.

I do hereby break all former wills, by me made. In testimony hereof I have set my hand and seal the eleventh(11) day of May (AD) 1870.

Jacob Stahl

signed by said Jacob Stahl as his last will and testament, in our presence and signed by us in his presence.

Witnesses: Frederick Ehrhart and John Westrop

Intent J. 23
Ripley Co. In.

By Edw. S. Edwards Esq.

DECLARATION OF INTENTION.

EDWARD S. EDWARDS OF KIPLEY CO. IN.

State of Indiana, Ripley County, Sit.

Personally appears before me, JOHN S. S. HUNTER, Clerk of the Circuit Court of said County, Jacob Stahl a native of Prussia

aged about 51 years, bearing allegiance to the King of Prussia

who emigrated from Prussia on or about the 3^d day of June A. D. 1848; and arrived at New York on or about the 24th day of July A. D. 1852; and who intends to reside within the jurisdiction and under the Government of the United States of America, to-wit: Ripley County, Indiana

And the said Jacob Stahl makes report of himself for NATURALIZATION, and declares on oath that it is bona fide his intention to become a citizen of the United States, and to renounce forever all allegiance and fidelity to any foreign Prince, Potentate, State or Foreign whatever, and particularly to the King of Prussia

whereof he is at this time a subject. Jacob Stahl
Subscribed and sworn to before me this 10 day of September A. D. 1852

John S. S. Hunter

In witness whereof, I have hereunto set my name, and the seal of said Court, in Versailles, the day and year last aforesaid.

John S. S. Hunter
Clerk of C. C.
Edw. S. Edwards Esq.

Henry and Catherine(Handel)Stahl

Henry(Henery) Stahl was born on Jan. 23,1833 in Bayrne Bavaria, in Germany. He was the son of Jacob and Catherine (Grimes) Stahl.

Henry's parents, Jacob and Catherine Stahl emegrated to America in 1852, bringing with them their children. They settled near the town of Napoleon, in Ripley County Indinana, as farmers. Henry was one of eight children: Frederich, Henry*, Jacob H., Adam J., George, Catherine, Anna Marie, Marie.

Henry Stahl followed the occupation of his father, and became a farmer, as were most German immagrants of that time.

Henry was married to Catherine Handel, born on May 4,1846 Bavaria Germany. They settled on a farm on Michigan Road, about two miles out of the town of Napoleon.

In the book of Napoleon, put out in 1970, Henery Stahl was listed as a member at the first organized meeting of the Mutual Farmers Fire Assistant Union, of Jackson Township. The meeting was held on Aug. 28, 1867, at Napoleon Indiana.

Henry and Catherine Stahl were members of the St. Maurice Catholic Church in Napoleon. [In the 1870 census they were listed as living in Deleware Township, in Ripley Co.]

Their children attended the nearby baylor one room school house. This school was located about one and a half miles East of Napoleon.

Henry and Catherine continued to farm until the death of Catherine on Jan. 15,1911. At this time Henry retired and moved in with his son Adam Edward Stahl who lived nearby. Most of Henry's children had long since moved too the town of Kokomo, in Indinan. Henry Stahl passed away at the home of his son Edward in Ripley Co. on Aug. 20,1917. He and Catherine are buried at the Catholic church cemm. of Napoleon.

Henry and Catherine Stahl were the parents of five children: Frederick, Jacob, Adam, Elizabeth(Crusemeyer), Mary(Stahl).

1. Frederick Stahl was born in Ripley Co. Indiana. He was Married to a Rose ---?. They moved to kokomo Indiana. They were the parents of three boys.(Names?)

2. Jacob Stahl was born in Ripley Co. Indiana. He was married to Anna. They moved to Kokomo Indiana. They had two children. A son named Edward Stahl, who was a Doctor, and a daughter (Name?).

3. Adam Edward stahl was born in Ripley Co. Indiana Oct. 1880. He was married to Louise Mistler on --? in Ripley Co. They were members of the St. Maurice Catholic church of Napoleon.

Adam was a farmer, they first lived in Jackson twp. their children attended the Baylor School located about one and a half miles East of Napoleon. He later owned and operated his own farm in Center twp. in Ripley Co. Indiana. He had a regular old fashioned farm. He plowed the fields with the horses hitched to the plow and he walking behind. He grew a variety of crops but mostly corn and wheat. He also raised some cattle.

Louise(Mistler) Stahl was the daughter of Martin and Mary Mistler, of Ripley Co. Indiana.

Louise worked hard at the usual household chores. She would

make her own homemade apple butter. They would peel the apples and she would make the apple butter in a big black kettle, hung over an open fire. It had to be cooked all day long and stirred constantly to keep it from sticking. Everyone would take turns stirring it.

Adam Edward Stahl was a member of the Knights of Columbus Napoleon from the St. Maurice Catholic Church in Napoleon.

Around 1955 Adam's son Ollie took over running the farm when Adam retired. Adam Edward Stahl, died in 1961. Louise Stahl took sick with Gallbladder trouble. She went into the hospital for surgery, and never recovered. She died at the hospital in 1969.

Adam Edward and Louise Stahl were the parents of four children: 1. Marcella Stahl b/1907, she was married to Stanley Kindel b/1902-d/1973. No children. 2. Monica Stahl b/1912 she was married to Lonnie Pickett b/1910-d/1990. no children. 3. Louise Stahl b/1915 she was married the first time to Ray Herman, a contractor, b/1904-d/1968, after his death, she was married a second time to Rollin Crum b/1912. They are currently residing at their home in Osgood In. No children. 4. Ollie Stahl b/1909- d/1989 He was married #1 to Monica Burdick b/1906-d/1991. They were the parents of two children: 1. George Stahl b/1943 and married Margret Lilley b/1947, George and Margret have one son, Garth Stahl b/1980. 2. Kathleen Stahl b/1946 and married Ronald Leising b/1945. (A grandson to Jacob Cook) They live in Indianapolis In. They are the parents of ten child: Lance b/1970, Tricia b/1971, Luke b/1974, Joshua b/1976, Tessa b/1978, Judd b/1981, Jessica b/1983, Tori b/1986, Jari Lynn b/1987, Taylor b/1990. Ollie Stahl was divorced from Monica Burdick in 1987. He was married a second time to a Velma Bultman b/1905- d/1984, after His wife Velma passed away, Ollie remarried to a Lillian Littell b/1912. Ollie Stahl passed away in 1989. He had resided his whole life in Ripley Co. In.

4. Mary Stahl was born in Ripley Co Indiana. She was married to a George Stahl, (who was somehow related as a cousin). They moved to Kokomo Indiana. They were the parents of six children: 1. Catherine Stahl b/? (never married), 2. Josephine Stahl b/? she married Clarence Baker. They had one son: Robert Baker who lives in Arizona, he had a son named Robert Baker. 3. Alvin Stahl b/? married ?. 4. Henry Stahl b/? married to a Mary. No children. 5. Charlotte b/? She became a nun , Sister Leona. 6. Margaret b/? she was married twice.. #1 to ? they had five children. #2 to ? she had a stepchild. They lived in Tampa Florida.

5. Elizabeth Stahl was born in Ripley Co. Indiana. She was married #1 the first time to Joseph Schantz. They had three children: 1. Clarence Schantz m/? , 2. Elmer Schantz m/? 3. Hilda Schantz m/ Jacob Cook and had six children. #2 second marriage for Elizabeth was to John Crusemeyer. They had six children: 1. Martha, 2. Raymond, 3. John, 4. Mary, 5. Dorothy, 6. Leonard- who died around age 8 or 9 years old of locked bowles.

ADAM EDWARD AND LOUISE STAHL

Adam Edward Stahl was born in Oct. of, 1880 in Ripley Co. In. He was the son of Henry J. Stahl, and Catherine (Handel) Stahl. He was one of five children: Frederick, Jacob, Adam Edward, Mary, Elizabeth.

Adam attended a one room school; it was the Baylor School about 1 1/2 miles east of Napoleon In. (attend to the eight grade?) The family attended the Napoleon Catholic Church.

He was married on Aug. 27, 1904 in Ripley County Indiana, to Louise Mistler. Louise was born in 1909. She was the daughter of Martin and Mary Mistler of Ripley Co. In.

Adam was a farmer and owned around 98 acres, in Center Twp. in Ripley Co. He raised cattle, corn, wheat and use horses to farm with. He was a member of the Napoleon Volunteer fire department. Louise would make homemade apple butter from apples in their orchard, peeling the apples and cooking it outside in a big black kettle over an open fire. It had to be cooked slowly and stirred all day long. Everybody would take turns stirring it.

Around 1955 Adam's son Ollie took over running the farm when Adam retired. Adam's wife, Louise (Mistler) Stahl, had gallbladder surgery in 1969 and never recovered.

Adam was a member of the Knights of Columbus (Napoleon) branch from St. Maurice Church.

Adam and Louise Stahl were the parents of four children: Mircella, Monica, Louise, and Ollie.

1. Marcella Stahl was born in 1907 in Ripley County Indiana. She married Stanley Kindell. They had no children.
2. Monica Stahl was born in 1912. She was married to Lonnie Pickett. They had no children.
3. Louise Stahl was born in Ripley County Indiana. She was first married to Ray Herрман. They were divorced and she remarried to Rollin Crum. She presently resides in the small town of Osgood.
4. Ollie Stahl was born in Ripley County Indiana. He was married to Monica Burdick. He was married a second time to Velma Bultman. They were the parents of two children: 1. George and 2. Kathey.

GEORGE AND MARY (HESSLER) STAHL

George Stahl was born Feb. 3, 1838 at Lamburgh, Bavaria, Germany, the son of J. Jacob and Catherine (Gieiner) Stahl. The 1900 U.S. census states that he came to America in 1852. He worked on his father's 80 acre farm at Napoleon, Ripley Co. In. until he was 21 years old. He then worked at whatever he could find to do for a while. At some time, Jacob sold his land to his sons George and Henry. Each son took 40 acres. He worked the land for seven years and then sold it. He then worked at various jobs again. In Oct. 1872 he and his family moved to Howard Co. In. to join his brother Adam who had preceded him there 3 years earlier. Together they bought 30 acres of land on which they built a tile factory in 1895. The tile factory was in the northeast part of the township (Taylor) near Wm. Helms. They later added another 10 acres. The tile factory was successfully operated for 14 years at which time the partnership was dissolved and the land equally divided. George was a hard working man and soon improved his farm and brought it to a high state of productiveness. All the 160 acres were well drained and tillable except for 20 acres which was in blue grass pasture. He underwent the usual hardships incident to life in an unimproved country; having, like the early pioneers, cleared the heavy timber, and developed a farm. He had a number of substantial buildings erected and amassed a comfortable competency for his family. He was strictly upright in all his dealings with his fellow man and was admired and much respected by all who knew him. He was a life long member of the Roman Catholic Church. George added this 20 acres to 40 acres he had in Taylor Township (part of the homestead). In 1901 he purchased another 80 acres making him 220 acres in all. In 1870 he purchased 250 acres of timber land in Lawrence County, Tenn. This was sold about 1892. George married Anna Mary Hessler on June 14, 1866. Anna was born Aug. 11, 1846 at Millhousen, Decatur Co. In. the daughter of John Hessler. John Hessler and his family came to America in 1838. They supposedly went to Cincinnati, Ohio for a short time before settling in Millhousen, In. George and Ann Mary Stahl had the following children.

1. John Stahl born March 24, 1867 at Millhousen, In. and died March 7, 1947. He married Mary Richey. Their children were Clarence, William, Elizabeth, Raymond, Lucille, Arthur Leonard, Carl and Herman. In Feb. 1986, Raymond was living in Tucson, Ariz. Bernard was living in Beech Grove, In. Elizabeth (Rotermund) was a widow in Chicago, Ill. and Carl and his wife Daisy lived south west of Kokomo, In. (they had a son deceased and a daughter married).

2. Catherine Stahl born Jan. 18, 1869 at Napoleon, In. and died Nov. 29, 1872.

3. Anna Catherine Stahl born Dec. 4, 1870 at Napoleon In. and died Sept. 21, 1871.

4. Anna Mary Stahl born Aug. 9, 1872 at Napoleon In. and died Feb. 21, 1969 at Kokomo, In. She married James Kerby and had six children.

5. John Adam Stahl born June 25, 1875 and died March 17, 1879. (buried in Kokomo, Indiana.

6. Margaret Rose Stahl born Nov. 8, 1877 and died Feb. 16, 1958. She married Arthur Coyle who was born Sept. 13, 1872 and died Feb. 16, 1939. They lived in Coffeyville, Kansas in 1947 and in Alabama in 1953. They had the following children; (1.) Agnes born March 14, 1902 and married A.L. Vanhaverbeke (they had 8 children); (2.) George born Aug. 20, 1903 and married Lucille Willa Klhe who was born Oct. 31, 1907. (in Feb. 1986 Lucille was still living in Sulphur, La.); (3.) Raymond Kasper born Sept. 11, 1906 and died the same day.; (4.) Anna Mary born April 11, 1909 at Kokomo, In. and married Arthur Hanlin. They divorced.; (5.) Rose Cecelia born about 1913 and died at the age of 7 on Nov. 13, 1920 at Tulsa, Oklahoma.; (6.) James Edward born Oct. 13, 1922 at Nowata, Oklahoma and died the same day.; (7.) Joseph Paul died Feb. 16, 1931 at Nowata, Oklahoma.; (8.) John A. who married Ann Lavelle. In Feb. 1986 they were living at 5304 Fairfield Blvd. Virginia Beach, Va. 23462.

They had 3 children; Barbara who married R.W. Carrole, Jack (deceased), Susan (married and lives at Silver Springs, Md.: (9.) Leo F. who married Lida Mabry and who lived at P.O. box 3655, Eureka, California, 95501 on Feb. 1986. They had one son, Bruce, who is a teacher in San Jose, California.

7. Henry Thomas Stahl born Dec. 21, 1879 and died July 13, 1958. He married Jan. 26, 1910 at St. Patrick's Church, Kokomo, In. Maude Gearheart (Gerhart) who was born March 6, 1887 in Northeastern Howard Co., In. and died Jan. 19, 1950. They had the following children; (1.) Martin Henry born April 13, 1911 and died from falling in a tub of water outside by the pump on Nov. 25, 1913. (2.) Rosemary born May 13, 1913 (3.) Richard Thomas born Oct. 15, 1917 (4.) Houston Leo born Nov. 22, 1918 (5.) Henry Junior born March 6, 1922 (6.) Ivan Matthew born Sept. 26, 1924 (7.) Cecilia Marie born May 25, 1926 (8.) Alfred George born Sept. 7, 1928. In Feb. 1986 all of the above children were living except for Martin. Henry and Maude are buried at Crownpoint Cemetery, Kokomo, Indiana.

8. Mary Theresa Stahl born March 25, 1882 and died Nov. 2, 1961. She married Ed Mueller (June 20, 1881-17 Oct. 1942). They had no children. They are buried at Crownpoint Cemetery, Kokomo, In.

9. Joseph Anthony Stahl born Aug. 8, 1884 and died Dec. 14, 1953. He married Gertrude Lowlett Feb. 2, 1910. They had the following children; Joseph L.; Paul Kenneth, Edward Earl, George Frederick, Theresa Katherine, and Elmo. Joseph and Gertrude are buried at Crownpoint Cemetery, Kokomo, In. (In Feb. 1986 Paul Kenneth and Elmo were known to be deceased.)

10. Leo Francis Stahl born July 6, 1887 and died Nov. 8, 1963. He married Zora (Zoe) Reagan of Center, In. on June 9, 1914. She was born May 17, 1888 and died Aug. 17, 1957. They lived and are buried in Indianapolis, In. They had the following children; Elinor Louise, Leo Francis Jr. (Chic) and Raymond Edward. (In Feb. 1986 Leo Francis was known to be deceased.)

George Stahl died March 8, 1904 of "indigestion". Anna Mary Stahl died May 24, 1920 of "chronic endocarditis" at her home 5 1/2 miles east of Kokomo, Indiana. At the time of her death she was in full management of 320 acres of land. She had lived in Howard Co. In. for 47 years. They are both buried at Crownpoint Cemetery, Kokomo, Indiana.

At the time of Anna Mary Hessler Stahl's death in 1920 her son Henry, and his wife Maude were still living with her which they had done since their marriage in 1910. On Nov. 27, 1920 Henry and Maude purchased 160 acres of land in the Northeast Quarter of Section Ten (10), Township Twenty-Three (23) North, Range Four (4) East, containing One Hundred Sixty (160) acres, for the sum of Forty-Four Thousand Dollars (\$44,000). Hard times fell on Henry and Maude and they lost the home place in approximately 1936. It was purchased by a Wm. Kring and his wife. After Wm. Kring's death it was purchased by his son Carol and his wife who rented it for several years to Ward Shenk, who farmed the 160 acres until 1965 when a tornado tore down most of the buildings. Eventually they were all torn down and converted to farmland. Later, Walter Young bought the land and farmed it. When he died it passed to his son, Melvin Young who was farming it in 1986. Henry and Maude Stahl, after losing the above farm, moved west of Kokomo, In. on to a small farm for about a year and then moved on to Fred Stahl's farm on State Road 31 north of Kokomo, In. They lived there until Feb. 9, 1949 when they moved to Kokomo In. and lived with their son Henry Junior on South Webster Street.

My Great Grandmother was Anna Mary Stahl who married James Kerby. She was born Aug. 9, 1872 at Napoleon, In. and died Feb. 21, 1969 at Kokomo, In. She married James Kerby Nov. 26, 1896 at St. Patrick's Catholic Church, Kokomo, Indiana. James was born Oct. 29, 1864 at Liberty Township (3 1/2 miles north of Greentown), Indiana the son of Michael Kerby and Catherine Fahey. According to Joseph Fredrick Kirby, there is a stained glass window in St. Patrick's Church in Kokomo, Indiana either given by or in memory of Anna Mary Hessler Stahl and George Stahl.



Anna Marie
(Hessler) Stahl



George Stahl b/Feb.3,1848
(brother to Catherine(Stahl) Hessler)



Home of
Anna &
George Stahl



Anna Mary(Stahl) Kirby
Aunt Mary Stahl 1919



sitting:L to R: Margaret Stahl(Coyle),Mary Stahl(Mueller),
Anna Mary Stahl(Kealy),
standing:Henry Finney,Lavena(Kinney),(twins)Lewis H. Stahl,
John Adam Stahl,Charles Stahl(son of Adam),Leo Stahl,Jos Stahl

ADAM STAHL AND MARGARET(HESSLER) STAHL

Adam John Stahl was born on March 31, 1839 in Bayern, Pfalz, Bavaria. He was the son of Jacob and Catherine(Grimes) Stahl. He came to America from Germany, around the age of 13 with his parents. They arrived in New York harbor in July 1852, and settled for a short time in Wheeling West Virginia. They purchased land in Ripley County Indiana in Aug. of 1852. They moved there shortly thereafter.

Adam Stahl was one of 13 children: Catherine, Elizabeth, Frederick, Henry, Heinrich, Jacob, George, Adam J., Catherine, Anna Maria, Marie, John, Child?.

Adam was married to Margaret Hessler on April 2, 1866 in the town of Millhausen, in Decatur County Indiana; in the Catholic Church.

Margaret Hessler was born on April 13, 1844 at Millhausen, In. the daughter of John and Anna Maria(Meese) Hessler. The Hessler's were also German. Margaret was one of seven children: Eva Cath., John, Adam, John, Margaret, Anna Mary, Gerhart.

Adam and Margaret Hessler moved to the town of Kokomo in Howard County, in the State of Indiana around the year of 1869. His brother, George Stahl, who had married Margaret's sister Anna Mary Hessler, followed three years later.

They purchased 30 acres of land and established a tile factory in 1895. Another 10 acres was added later. They successfully operated the factory for 14 years.

Adam Stahl was also a prominent farmer in Taylor Township for many years. The Stahls were all Catholic's and were members of the Catholic church in Kokomo.

Margaret Hessler died on July 7, 1909 in Howard County Indiana, at age 65 years, 2mo., 24days. Adam Hessler died on Nov. 30, 1918 in Howard County, In. at age 79yrs., 7mo., 29days.

Adam and Margaret Stahl were the parents of five children: 1. George 2. Frederick 3. Lewis 4. Anna Mary 5. Charles.

- *1. George A. Stahl was born on Dec. 16, 1868 the son of Adam and Margaret(Hessler) Stahl. He was married to Mary Shrader on Jan. 30, 1894 in Howard County, Indiana. Mary was born on Dec. 28, 1866. George passed away on Oct. 25, 1943 in Howard Co. In at the age of 74. Mary passed away on July 14, 1957. Both are buried in Sec. 26 of the Crown Point Cem. in Howard Co. In. (No Children)
- *2. Frederick E. Stahl was born on July 8, 1872 in Howard Co. In. He was married to Minnie Elizabeth Lahn, born about 1896 in Paris Ill. She was the daughter of Ernest and Carolyn Muller(Miller) Lahn. Fred attended school in Danville, Ill. and Indiana Normal College in Terre Haute, In. He taught school for several years in Liberty Twp. He was also a railroad clerk. Minnie died on Sept. 26, 1942. Frederick died on Oct. 12, 1945 at Paris, Ill. He was killed in an auto accident at the age of 73. Fred and Minnie were the parents of three children: Willard, Girl, Charles.
 - A. Willard E. Stahl was born March 27, 1905 at Paris, Ill. He was married to Lucille E. Dutton on Jan. 12, 1928 at Howard Co. In. Lucille was born on May 26, 1905 in Howard Co. In., the daughter of Alonzo M. and Chloe(Burgan) Dutton. Willard Stahl's wife, Lucille, died on May 7, 1948 in Howard Co. In. They had nine children. Willard remarried to a Lucille Kinney who was born on June 3, 1914. They were divorced on July 2, 1955. Willard was a prominent farmer in Howard County, Indiana. On March 19, 1957, he sold 157.7/6 acres of his homestead, on Albright road, to Pendiana Improvement Company, Inc. They sold the property to General Motors Inc. on Dec. 8, 1959. Delco Electronics is now located on this property. Willard then purchased 262 acres in Clinton County In. nine children:
 - 1. Frederick Ernest "Bud" Stahl, born Oct. 2, 1928 Howard Co., married Georgia Mae Butcher on Feb. 8, 1958. Georgia was born on June 15, 1923 Howard Co. In. the daughter of Elmer and Deulah(Robinson) Butcher. "Bud" served in the army from Dec. 7, 1954 to Dec. 7, 1956. with the medical detachment. He has been the owner of Stahl Welding and Crane Rental, since 1960. They had one child: Jeffery Stahl born July 1, 1958 Howard County In.
 - 2. Betty Louise Stahl, born June 20, 1930 in Howard Co. In. She married John McKay on July 8, 1950 Howard Co. In. He was born on Dec. 11, 1925 Columbus, In. Betty and John McKay were the parents of two children: Gary McKay born Sept. 3, 1952, and Steve McKay born Nov. 11, 1956 in Columbus, In.
 - 3. Jack Edward Stahl, born Nov. 25, 1931 Howard Co. He married Virginia L. Harding on July 21, 1951 Howard Co. Virginia was born July 23, 1932 Howard Co. In. She was the daughter of Logan and Anna(Boucher) Harding. She died

on MAY 19,1973 and is buried in Sunset Memory Gardens in Howard Co. In. Jack was married a second time to Ferol J. (Palmer)Ault, on June 21, 1974 in Delaware Co. In. Ferol J. Palmer was born on July 16, 1931 at Delaware Co. In. She is the daughter of Jesse S. and Velma A.(Roderick) Palmer. Jack had two children from his first marriage: Joe and David

Joey"Joe" Max Stahl, born Aug. 8,1952 Howard Co. In. He married Judy Alsop on April 17,1976. They divorced Nov. 3,1980 he remarried Judy on Oct. 26,1988. Judy was born on Jan. 2,1958. They had three children:1.Randy Wayne Stahl b/Dec. 20,1976 Howard Co. 2.Christophex Dwayne Stahl b/June 26,1979 Howard Co. 3.Rachel Catherine Stahl b/June 17,1989 Clinton Co. IN.

David Allen Stahl,born Sept.10,1958 Howard Co. In. He was married to Lara Pelly on March 30, 1980. They divorced in 1983. He was married to Ann Deguzman on Sept. 3,1983 in San. Jose, CA. Ann was born on April 24,1960 in Manila, Phillipenes. Ann redieved her citizenship to the U.S.A. on May 23, 1985, at San Jose, Ca. They have two children: Drew Allen Stahl was born on Sept. 20, 1985 San Jose, Ca. and Ryan Christopher Stahl, born July 23, 1988 in San Jose, CA.

4.Marjorie Ann Stahl, born March 15,1936 Howard, Co. In. She was married to Charles Wayne "Barney" Orem on Aug. 11, 1960 Howard Co. In. Barney was born on Dec. 15, 1912 at Howard Co.In. Marjorie and Barney Orem had two children: Abby Jo Orem b/March 16,1961. and Melanie Ann Orem b/Nov.21,1964 Howard Co. In. She married Tim Mannina on Dec. 31,1988. Tim was born on Feb. 22,1961.

5.Willard Ernest Stahl Jr. was born on April 29,1939 Howard Co. In. He married Carol Ann Wright on June 4,1960 in Dayton Ohio. Carol was born on Dec. 24,1940 Howard Co. IN. She is the daughter of Bernard and Nellie Irene(Harding) Wright. They had three children:1.Timothy Lynn Stahl, born Sept.17,1960 at Clinton Co. In. He married Donna Burns on June 14,1980, Howard Co. In. Donna was born on Oct. 5,1961. They have two children: Valerie Mae Stahl b/March 23,1981 Howard Co. and Natalie Nicole Stahl b/Nov.6,1983. Howard Co. 2.Christphex Dale Stahl was born Sept. 15,1961 He died March 9,1962 Clinton Co. In. buried Crown Pt. Cem. Howard Co. 3.Thomas Lee Stahl was born on July 12,1963 Clinton Co. In. He was married to Becky Reagan on Sept. 8,1986 Clinton Co. They have three children: Erick Stahl born Feb.28,1987 Clinton Co. Jason Curtis Stahl born March 31,1989 Fort Walton Beach, Florida. Teesha Shaleen Stahl born May 24,1992 Fort Walton Beach, Florida.

6.Carl Edward Stahl was born Oct. 23, 1942 at Howard Co. In. He was married to Joyce Cheek on Aug. 16,1963 Howard, Co. Joyce was born Dec.21,1944.(Divorced 1973) He married a second time to Janet"Jan" L. Jeffery on July 1,1978. Jan was born on March 3,1951. They have two children: Tammi Denise Stahl was born on April 16,1967 Howard Co. and Holly Marie Stahl born Oct.13,1969 Howard Co. In. Holly has one child, Bianca Jo Stahl born March 9,1990, Howard Co. In.

7.Robert"Wayne" Stahl was born on Aug. 11,1945 at Howard Co. In. He was married to Sandy Woods on Dec. 6,1966, they were divorced Jan. 1974. He married a second time to Cherry"Twig"Mcmenway on July 4,1976 in Allen Co. In. Twig was born on May 10, 1952. They had two children. (divorced) 1.Samantha Raymond"Sam" Stahl was born on April 6,1981 in Allen Co. In. 2.Adam Dutton Stahl born Oct. 4,1982 Allen Co. In.

8.Sheila Marie Stahl was born on May 1,1948 in Howard Co. In. She was married to Terrance Westbrook on Jan. 24, 1969 Cook Co. Ill. "Terry" was born on Aug.22, 1977 Cook Co. Ill. They are divorced. They had four children. Two sets of twins. 1.Vanessa Westbrook b/July 20,1970 CA. 2.Jason Westbrook b/July 20,1970 Ca. 3.Jeremy Westbrook b/Aug. 6,1977 Phoenix, Az. 4.Michael Westbrook b/Aug. 6,1977 Phoenix, Az.

(M#2)9.Kimberly Ann Stahl was born on Aug. 23,1957 Howard Co. In. She was married to Bruse Waddell on Oct.23,1982 Howard Co. In. Bruse was born on July 30,1956 at Cook Co. Ill.

B. Stahl,(Girl) STILLBORN- no name given Feb. 16,1912, Howard, Co. In.

C. Charles Frederick Stahl was born on Feb. 20,1914 Paris Ill. He was married #3 times. m#1.Josephine Rose m#2.Alice Fivecoat m#3.Dorothy Emma Schmunk on Sept. 18,1947. Dorothy was b/May 22,1920 the dau. of Frederick Otto and May Violet Schmunk. four children. m#1. 1.Charles Frederick Stahl born Nov.30,1935. Changed his name to Thomas Goodwin Lyon. He married Linda Lucking in 1960 had three child:Michele, Tracy, Scott Lyon. m#3 2.Sharon Sue Stahl b/Nov.11,1947 married Pasquale Rocchio in 1975 Kokomo. four children: Frank, Anna, Michael, Nicholas Rocchio.

3.Charlene May b/Aug.19,1951 m#3 times:1.Mark Clark 2.Charles Edward Coburn 3.William Nelson Schmidt. four children: Matthew Waynw Clark, Sarah Elizabeth Clark, Susannah Catherine Coburn, Abigail Emma Schmidt.

4. Jill Elizabeth Stahl b/Feb. 26,1955 m#2 times 1.Robert Joseph Kinney 2.Walter Leslie Ellis. four children: Jared Nathon Kinney, Rachael Marlah Kinney, Haley Eliz. Ellis,Megan Ellis.

* 3. Lewis H. Stahl was born on March 9,1877 at Howard Co. In. (Twin)He was married to Anna Vandebosch on Jan. 12,1910 at Howard Co. In. Anna was born on May 4,1879and died on Nov.22,1937, buried at Crown Point Cem. Howard Co. They had four children:Margaret, Rudolph, Paul, Rosalie.

1.Margaret Mary Stahl was born Oct.10,1910 Howard Co. In. d/June 30,1991 She married Lawrence J. Roswig on May 4,1938. Lawrence b/Oct.20,1907. Two children: 1.Lawrence Joe Roswig was born oct.19,1940. Howard Co. He married Shirley Kell and had three children:Christopher Lee Roswig, Lisa Roswig(Coan)(ADOPTED), Jeffery William Roswig.

2. Rudolph Mathew Stahl was born on Feb. 24, 1915 Howard Co. He died on Feb. 7, 1916 at Howard Co. In. age 11 mo. 17 days.

3. Paul Joseph Stahl was born on Oct. 18, 1911 at Howard Co. Died/May 19, 1962. He married Marjorie Smith on Oct. 11, 1940 Howard, Co. No children.

4. Rosalie Mary Stahl was born on Feb. 27, 1921 Howard Co. In. She died Oct. 17, 1977. She was married to William Harvey. They had three children: William Harvey III, Anna Harvey, Rema Harvey.

* 4. Anna Maria Luvina Stahl was born on March 9, 1877 at Howard Co. In. (twin). died on Nov. 13, 1949. She was married to Henry Kinney. Henry was born in 1869 and died on April 20, 1950 Howard Co. In. Henry and Anna Kinney had four children: Wm. F., Christine, Geo., Chls.

1. William F. Kinney was married to Mary Kepner on May 15, 1918. They had 5 children: 1. Richard Kinney married Mary Jean --? 2. Marjorie Kinney married Vestal Nicholas. They had seven children: Kathey, Mary Elaine, John, Jane (Nicholas) Kanable, Karen, Susan (Nicholas) Kuntz, Jimmy Nicholas. 3. Martha Jean Kinney b/Jan. 28, 1921 and married Clark Duane Roush on Aug. 18, 1945. three children: Wm. C., Stephan, Randall Roush. 4. Mary Ellen Kinney born Dec. 13, 1929. married James Ray Fenn on Oct. 27, 1951. four children: James Ray Fenn Jr., Richard Damon Fenn, Robert Wm. Fenn, Mary Ellen Fenn. 5. Robert Kinney married Mary Lou Weir, two children: Rachel Marix Kinney, David Kinney.

2. George Kinney who married and had one child.

3. Christine Kinney was born on June 26, 1900 and died Nov. 29, 1985. married Brandon Smoot. They had three children: Dora Brooke Smoot, Brayton Smoot Jr., Jane Smoot.

4. Charles Kinney who died in 1918 at age 22.

* 5. Charles Jacob Stahl was born on March 18, 1879 in Howard Co. In. d/Oct. 6, 1946. He married Elsie Ellen Jessup on Jan. 20, 1904 Howard Co. In. Elsie was born Dec. 18, 1883 and died June 27, 1971 Howard Co. They had two children: Francis and Agnes Clare.

1. Francis Frederick "Dutch" Stahl was born on Oct. 11, 1905 Howard Co. d/1986. He was married to Violet Adella Lamb on Jan. 28, 1928. Dau. of O.W. and Martha (Cox) Lamb. They had two children: Helen and Philip. 1. Helen Joan Stahl born Aug. 18, 1928 married Thomas Hickman on Nov. 19, 1946. two children: A. Mark Allen Hickman b/Oct. 6, 1950, who married Barbra Hoover (child: Tamara, Brent) B. Deborah Elaine Hickman b/July 15, 1954 who married Leon Dehaven (child: Patrick, Laura) 2. Philip Harold Stahl born Aug. 18, 1929 Howard Co. Married 3 times. #1 Jacqueline Freers 1956 #2 Betty Fisher #3 Loretta Howard two children: Toni and Michael. 1. Toni Leigh Anna Stahl born Jan. 20, 1958. She married William Jones on May 1, 1982. two child: Ryan, Amanda. 2. Michael Francis Stahl was born May 15, 1959. He married Lisa Richards on Aug. 13, 1983. two child: Taylor and Brittany. m#2 Betty Fisher.

2. Agnes Claire Stahl was born Feb. 4, 1912 Howard Co. In. She was married to Herman Gail Kern on Oct. 14, 1937. Herman was born Oct. 14, 1911 d/Oct. 8, 1973. Howard Co. Two child: Charles Herman Kern born July 31, 1953 Howard Co. Married Gina Mason (Bline) 1990. child: David Max Kern, two steps, Trine and Heidi Bline.

THOLE

Theodore THOLE b/1729 Germany D/1785 Germany
m/1763
Margaretha Wellman b/173 Germany

1. Johann Theodore Thole
b/1763
M/Lucia Maria Wehage
Child:
1. Herman Heinrich
2. Anna Margaretha
3. Maria Gertrude
4. Johann Theodore
5. Johann Heinrich
6. Maria Elizabeth
7. John Otto

1. b/1797 Herman Heinrich M/	2. b/1799 Anna Margareta m/	3. b/1802 Maria Gertrude m/	4. b/1805 John Theodore m/	5. b/1808 John Hein. m/	6. b/b/1811 Maria Elizabeth m/	7. b/1815 John Otto m/Mary Anna Lamping Child: 1. Philomena 2. Henry 3. Mary Anna 4. John Bernard 5. Carolina 6. Elizabeth
------------------------------------	-----------------------------------	-----------------------------------	----------------------------------	-------------------------------	--------------------------------------	--

4. b/1851 Philomena Thole m/1872 Mathias Rutt Child: 1. Boy (Charles?) 2. Mary Anna	2. b/1855 Henry Thole d/1871 died at age 16 of small pox	3. b/1856 Mary Anna Thole d/1871 died at age 17 of small pox	4. b/1861 John B. Thole (Joe) m/1892 Carrie Monter Child: 1. Mary Louise 2. Carrie 3. Mary Cecilia 4. Loretta 5. Joe Mathias 6. Louis Charles 7. Aloysious 8. John Bernard Jr.	5. b/18 Carolina D/ died as a baby from whooping cough	6. b/18 Elizabeth D/ died as a Baby
---	--	--	---	---	---

1. b/1872 d/1872 Boy Rutt died at birth.
2. b/1874 Mary Anna m/1897 Frank Messler Child:
1. Philomena b/1894 m/Herman Veerkamp, Cathy, Rita, Herman, Norbert, Stanley, Mary Martha, Cyril, Ralph, Mary P., Margaret, Tony, Barbra
2. Francis b/1900 m/Theresa Hardebeck child: Margie, Bertha
3. Mary b/1901 m/Hurry J. Dwenger child: Kathey, Esther, Rose, Ruth, Anne, Dick, Betty, Leonard, Mary Ellen, Edward Joseph.
4. Matilda b/1903 m/Clem Stuhrenburg child: Mary A., Bernard, Dorothy, Vincent, Maurice, Mary H., Lucille, Alvin, Marie, Beth, Mary
5. Cecilia b/1905 m/Bernard Harpring child: Mary Joan, Edgar, Irma, Lois, Luella, Elvera, Bernard, Vernon
6. Rose b/1907 Sister Joseph Marie (a Nun)
7. Clara b/1908 m/George Naderman child: George Jr., Justin, Rose Marie, Jane, Edna, Albert, John, Esther
8. Joseph b/1909 m/Bernice Wanning child: Ken, Judith, David, Mary Ann, Robert
9. Gertrude (Bobbie) b/1910 m/Clem Koors child: James, Sylvester, Paul, Carl, Don, Louis
10. Christine b/1911 m/Alvin Cord child: Deloris, Carolyn
11. Hildegarda b/1913 d/1916 age 3
12. Lawrence b/1914 d/1916 age 2
13. Aloysious b/1914 d/1915 age 4 1/2 mon.
14. Helen (Tonnie) b/1916 Sister Margaret Mary (a Nun)
15. Margaret Agnes b/1918 d/1918 age 3 weeks

1. 2. Mary Carie 1893 born m/1894 died 1894 Cinn.19 Ohio she was a school teacher
3. b/1897 Mary Cecilia m/1897 Matthias Johannsmann child: 1. Urban m/Margie Veerkamp child: Betty, Margaret, Donna, Marilyn, Kathy, Janet, Darlene, Urban, Charles, Dorothy, Laurie
4. b/1899 Loretta m/1892 Adolph V. Komescher child: 1. Adele m/George Porteck child: Jeff, Kevin, Greg, 2. Jerome m/Ruth Hollie child: Bonita, Ed, Judith, Diane, 3. Joan m/not child: Susan, Tom, Mary, Linda, Julie, Karen, Mark
5. b/1902 Mathias m/1902 Catherine White child: 1. Joseph m/Ann Fisher (2 sons) child: Sue, Cynthia, Linda, Elaine
6. b/1905 Louis m/1905 Hilda Schneider child: 1. Jerome m/Mary Fisher child: 2. Jane Will Jr., Ann, Stephanie, John, m/Ann Forst child: 2 stepchild, 4. Louis m/Jane Mollique child: Elizabeth, David, Louis, 5. Mary m/Thomas Gonnella child: Lisa, Laurie, Linda, Tom, Tim
7. b/1905 Aloysious m/1905 Esther Bruns child: 1. Eileen m/Cletus Wagner child: Marlene, Tom, Ken, Jan Robert, Jeff
8. b/1907 John B. m/1907 Alma Kohlman child: girl died at birth
9. b/1907 John B. m/1907 Wayne Reader child: Alan, Amy, David
10. b/1907 John B. m/1907 Robert Hounert child: 3. Marie m/Robert child: Kirt, Belinda
11. b/1907 John B. m/1907 Robert Hounert child: 4. Rita m/Cyril Duerstock child: Kevin, Mike, Doug, Jenny
12. b/1907 John B. m/1907 Robert Hounert child: 5. Martha m/Von Moorman child: Dennis, Brian, Melany, Shaifa
13. b/1907 John B. m/1907 Robert Hounert child: 6. Anita m/Doug Holly (Div) child: Talia, Tyler
14. b/1907 John B. m/1907 Robert Hounert child: 7. Paul m/Marjole Meyer child: Daniel, Catherine, Julie, David
15. b/1907 John B. m/1907 Robert Hounert child: 7. Thomas m/Javern Abbey child: Will, Michael, Adnan, Michaello, Regae, Tom

LAMPING

Johann Heinrich Lamping — born: Hausette, Germany
 m/Helena Catherine Kaiser Prussia

children;

1. Maria Anna
2. Gerhard
3. Johann

Children of John and Helena(Kaiser) Lamping

<p>1. Maria Anna Lamping Essen Germany m/John Otto thole <u>children;</u> a. Philomena b. Henry c. Elizabeth d. Carolina e. Mary Anna f. John Bernard</p>	<p>2. Gerhard Heinrich Lamping b/1822 Germany</p>	<p>3. Johann Bernard Lamping b/1825</p>
---	---	---

children of Anna(Lamping) and John Otto Thole:

<p>a. Philomean Thole m/1872 Matthias Rutt <u>children ;</u> 1. Charles b/12/1872 2. Mary Anna b/1/5/1874 m/1897 Frank Hessler</p>	<p>b. Henry Thole b/1855 d/1971 16 of age Small Pox</p>	<p>c. Mary Anna Thole b/1856 d/1871 15 of age Small Pox</p>	<p>d. Elizabeth Thole b/18__ died infant</p>
--	---	---	--

e. Carolina Thole
b/18__
died infant
Whooping Cough

f. John Bernard Thole
b/1861 Ohio
m/ Carrie Monter
children:
1. Mary (Johanningman)
2. Aloysious
3. Louis
4. John
5. Carrie

for more information see:
 John Otto and Mary Anna(Lamping)Thole History

JOHN OTTO AND MARY ANNA(LAMPING) THOLE

(Information from Helen Hessler, Mary Dwenger, Adel Porteck, Marie Monter, Daniel Thole, Moorman church lib.)

John Otto Thole was born on Sept. 23, 1815 at Hausette, Oldenburg, Germany (Prussia) and was christened on Oct. 17, 1816. He was the son of Johann Theodor Thole and Lucia Maria (Wehage) Thole. His parents were married in 1796 in Vestrup, Oldenburg, Germany. John Otto Thole was the youngest of seven children.

They were probably Dutch German as he had told his children that they were from Neidenlande (Holland?)

It is unsure of the reason for John Otto Thole's immigration to the United States, but some research done by Daniel Thole told this: It seems that during the early 1800's, Germany was in many ways much less advanced than the other countries of Western Europe. Commerce and manufacturing were limited, most of the people made their living by farming. The cities were small and were each ruled by individual Kings or princes. Each state had its own army and collected its own taxes. The people had little voice in the government. After 1830 the people grew increasingly unsatisfied. In 1844 the harvest was very poor, many people were out of work and and hungry. News of a revolt in France set off similar revolts in Germany. Times were hard during this period, and the people were looking for change and improvements. It was during this political climate and time that your great great great grandparents left Germany for America, seeking a better life and improved conditions.

John Otto Thole, alone, at the age of 32, boarded a ship to America in 1847. While on board ship he met a young woman of 27, Mary Anna Lamping. It is thought that John Otto Thole and Mary Anna Lamping were not acquainted until they met on board ship. I have found numerous records of marriages in Oldenburg Germany between Thole's and Lampings, and it is possible that, while not sweethearts, they may have had common acquaintances. The story goes that while on board ship, Mary Anna became very sick, and that John Otto, took care of her and nursed her back to health. The accommodations on board these boats were very poor and many died on the journey to America. Their ship arrived in America at New Orleans on Nov. 1, 1847.

Mary Anna Lamping was born on June 11, 1820 in Essen, Oldenburg, Germany. She was the daughter of Johann Heinrich Lamping and Helena Catherine (Kaiser) Lamping. She had two brothers that we know of, Gerhard Heinrich Lamping born July 30, 1822, and Johann Bernard Lamping born June 19, 1825. Neither came to America with her. It is rather odd to find a woman at that time to be traveling alone on such a journey. She may have had a chaperone.

After arriving in America, they both settled in Cincinnati, Ohio, in Hamilton Co. They began keeping company, and were married in Jan. of 1851 at St. Philomena's Catholic Church. They lived at 37 Baum Street, in Mt. Adams. They were members of the St. Philomena's church and their children were baptised there. (The church is now gone.)

JOHANN THEODORE AND LUCIA(WEHAGE) THOLE

Johann Theodore Thole was born on Dec.13,1763 at Haustette, Prussia (Oldenburg), in Germany. He was the son of Theodore Thole and Margaretha(Wellman) Thole.

Theodore Thole was born in 1729. He was married to margaretha Wellman on June 16, 1763 at Haustette, Germany, in the Oldenburg district. Theodore amd Margaretha attended the Evangelical Lutherin Church, at Haustette. I have only one son listed: Johann Theodore, our ancestor.

Johann Theodore Thole grew up in Haustette, Germany. He was married on Nov. 22,1796 to Lucia Maria Wehage.

Lucia Maria Wehage was born on March 15,1774 at Haustette, Oldenburg, Germany. She was the daughter of Johann Otto Wehage, born on April 16,1741. and Anna Katherine Wehage, born on March 27,1743 Haustette.

John Otto and Anna Catherine Wehage were married on Sept. 10, 1765 at Vestrup, Oldenburg, Germany.(Anna Katherine was the daughter of Johann Theodore Wehage and Anna Gertrude(Meyer) Wehage.) John Otto Wehage died sometime after 1777 Germany.

John Otto and Anna Catherine Wehage had five children: 1. Anna E. Katharina Wehage b/Aug.27,1766, 2. John Otto Wehage b/April 24,1768 Germany 3. Anna Margaretha b/March 5,1771 Haustette, Oldenburg. 4.Lucia Maria b/March 15,1774

Johann Theodore and Lucia Maria Thole were married in 1796 and they lived in the small village of Haustette in the district of Oldenburg. They were members of the Lutherin Church. They were also the parents of seven children:1. John Otto 2.Herman 3.Anna Margaret 4.Maria Gertrude 5.Johann Theodore 6.Johann Heinrich 7.Maria Elizabeth.

Johann Theodore Thole passed away on Dec. 26,1835 at Haustette Germany, his wife, Lucia Maria(Wehage) Thole, passed away on Feb. 4,1841 at Oldenburg, Prussia.

CHILDREN OF JOAHNN AND LUCIA THOLE:

- 1.Herman Heinrich Thole, born Dec. 4,1797, Haustette, Germany.
- 2.Anna MARGARETHA Thole, born 1799 Haustette Prussia.
- 3.Maria Gertrude Thole, born 1802 Haustette, Oldenburg, Prussia.
- 4.Johann Theodore Thole II, born 1805 Haustette.
- 5.Johann Heinrich Thole, born 1808 Haustette, Germany.
- 6.Maria Elizabeth Thole, born 1811, Haustette, Oldenburg.
- 7.Johann Otto Thole, born Sept. 15,1815 Haustette, Oldenburg.

Their youngest child, John Otto Thole emigrated to America in 1837. He came over on the same ship with his furture wife, Mary Anna Lamping. His brother Heinrich also came to the U.S. later.

In the old Germany records from which I searched, I found quite a number of Thole's who married Lamping's. Curiously there was a John Otto Thole who had a child by an Elizabeth Lamping, (no marriage recorded, child had the Lamping name.)

John Otto Thole married Mary Anna Lamping in Jan. of 1851 at St. Philomena's Catholic Church.

(see John Otto Thole history for more information)

Their daughter Philomena Thole was born on Dec. 4, 1851, in Cinn. Ohio. A son Henry was born in 1855, and a daughter Mary Anna was born in 1856.

Around 1855 or 1856 John Otto Thole bought a farm near Millhousen. Their daughter Philomena was around age 5 or 6. They moved to the farm and lived there for a few years. Things did not go as planned, crops were not good, and they also wanted their daughter who was coming of school age to attend a Catholic school and there was not one at Millhousen at that time. Around 1860, they decided to go back to Cinn., Ohio. Great great Grandpa Thole went to Cinn. to look for a job and a place to live, so they could move back.

While he was gone, one summer day, it was warm, and Mary Anna was working outside, when she saw a strange light off in the distance. She couldn't tell what it was. She told Philomena to "Climb a tall tree and see what it was." It turned out to be a forrest fire, moving in their direction. Mary Anna collected up what of their belongings she could and the children, and followed the nearby creek to safty. The fire burned some of their buildings. Soon after that John Otto Thole returned for them and took them back to Cinn., where they stayed until around 1887 when they moved to Napoleon.

John Otto had lost touch with his family after coming to America. One day his daughter Philomena came home from playing and said that another family was living near them with the same last name. John Otto said that they surely couldn't be related to them, but they went right over to the other house to see. They found that they were related, and that it was his brother. They kept close after that. In the 1875 Cinn. city directory, a Henry Thole was living at the same address as John Otto Thole.

John Otto and Mary Anna Thole had two daughters who died while still babies. Carolina Thole who died as a baby from whooping cough, and Elizabeth, who died as a baby, but I do not know from what. Their son John Bernard was born on April 5, 1861 Cinn. Ohio.

In December of 1871, the small Pox epid. hit their home. Two of their children, 17 year old Henry and 16 year old Mary Anna, both contracted the disease. They both passed away in Dec. of 1871 and are buried in Cinn.

In 1873 their daughter Philomena was married to Matthias Rutt, in Cinn. Ohio. They had a daughter Mary Anna Rutt born in Jan. of 1874. Their son John Bernard Thole was married in Oct. 1892 to Carrie Monter. They had six children.

Mary Anna (Lamping) Thole died on March 18, 1881, on her son, John Bernard's farm, in Napoleon In. She was buried in the Cath. Cemm. at Cinn. Ohio.

John Otto stayed in Cinn. until around 1887 when he moved to Napoleon, where his son owned a farm. John Otto Thole died on April 23, 1892 in Napoleon and is buried in St. Maurice Cemm. There is no marker for his grave.

John Otto and Mary A. Thole were the parents of six children, only two of whom grew to maturity. 1. Philomena born Dec. 4, 1851 2. Henry born in 1855 3. Mary Anna born in 1856 4. Carolina born ? 5. Elizabeth born? 6. John Bernard born April 5, 1861.

JOHN BERNARD AND CARRIE(MONTER) THOLE

John Bernard Thole was born on April 5, 1861 at Cincinnati, Ohio, in Hamilton County. He was the son of John Otto and Mary Anna (Lamping) Thole, both of whom had emigrated to the U.S. from Germany. He was one of six children, only two of which grew to maturity.: Philomena Thole (who married Mathias Rutt), John Bernard, Henry, Mary Anna, Carolina, Elizabeth.

His family lived in the town of Cincinnati Ohio, at Mount Adams, IN Hamilton County. They were devout Catholics. They attended the St. Philomena's Catholic church there. (This church is no longer standing.)

John Bernard Thole, was given the nickname of "Joe", by his colleagues at work (There were evidently quite a few John's there, so they called him Joe), and the name took, and all who knew him well called him Joe Thole.

John B. (Joe) Thole, worked as a pressman or Printer, in 1880. In 1883 he purchased a 125 acre farm in Napoleon, Indiana (Ripley County). He purchased it from his then future father-in-law, Louis Monter. Sometime after this purchase he allowed his sister Philomena and her husband Mathias Rutt, to live in the house and Manage the farm. Sometime around 1890 John and Philomena's parents, John Otto and Mary Anna (Lamping) Thole, went to live with Mathias and Philomena in Napoleon, Indiana. John Otto Thole died on April 23, 1892, in Napoleon, and is buried in the St. Maurice Cem. there is no marker for his grave.

On October 11, 1892, John Bernard Thole was married to Caroline (Carrie) Monter in St. Ludwigs Catholic Church in Cincinnati, Ohio. The wedding ceremony was performed by Father Stoeppelman. They lived in the Camp Washington Area.

Maria Caroline (Carrie) Monter was born on September 11, 1870 at Cincinnati, Ohio. She was the daughter of Louis and Maria Anna (Doll) Monter. Her parents were married on July 6, 1869 at St. Francis church in Cinn. Ohio. Later when Carrie's brother Louis Monter became widowed, Carrie and John took in his two year old daughter, Marie Monter, and raised and cared for her as one of their own.

In 1902 John Bernard and Carrie (Monter) Thole moved to his farm just outside town of Napoleon. Mathias and Philomena near this time went to live with their daughter Mary, who had married Frank Hessler.

John Bernard was not familiar with farming but soon caught on quite well. He had built for him a large two story white frame house which. In those days a house like this was very expensive to have built and that when they moved into this house, they were considered by their neighbors to be quite wealthy.

They were the parents of eight children: 1. Mary Louise b/Aug. 9, 1893 d/Oct. 25, 1893 Cinn. Ohio. 2. Caroline Mary (Carrie) b/Oct. 25, 1894 d/Nov. 23, 1935 Greensburg, In., 3. Mary Cecilia b/April 12, 1897 Cinn. Ohio d/ March 29, 1960 she married Matthias Johanningman, 4. Mary Loretta b/Aug. 8, 1899 d/April 10, 1986 she married Adolph Vincent Komescher, 5. Joseph Mathias b/May 26, 1902

married Catherine White., 6. Louis Charles b/March 4,1905 d/Jan. 26,1984 he married Hilda Schneider,(Louis and Al Thole are twins)
7. Aloysious b/ March 4,1905 d/May 26,1988 he was married Esther Bruns. 8. John Bernard b/1908 d/ still living. He is married to Alma Kohlman.

John B. Thole enjoyed reading western Novels by Louis Lamour and had quite a collection. He passed away on April 28,1928 of TB in Napoleon, Indiana. After his death Carrie sold the farm to their son Al Thole, who was married and would continue the farm. Carrie moved around 1933 to a home in the town of Millhousen, in Decatur County. Her daughter Carrie and Marie Monter, were both school teachers, and taught near there.

On Saturday November 23, 1935, John and Carrie's daughter Carrie, died in a tragic accident. (AS TOLD BY MARIE MONTER)

" On that Saturday morning, Nov. 23,1935, I took Aunt Carrie to Napoleon because she was to play the organ in Requiem Mass. Carrie was still in bed when we left. While we were gone, she got up and lit a small oil heating stove for warmth, her clothes caught on fire and she was badly burned. We had her taken to the hospital in Greensburg, and there she died, in the afternoon."

Carrie and her niece Marie continued to live there until 1941, when they moved into another home down the street.

Carrie(Monter) Thole loved to play the piano, but unfortunately, had vvery bad arthritis in her hands. This didn't stop her from playing however, and she was quite good. She passed away in Millhousen, Indiana, in Decatur County, on December 28,1959.

CHILDREN OF MARY CECILIA (THOLE) AND MATTHIAS JOHANNIGMAN

Cecilia married Mathias Johannigman on Oct.16,1926 in St. Maurice Catholic Church at Napoleon, Indiana, in Ripley Co. Mathias was born 6/8/1893 near Millhousen, Indiana. He was the son of Mathias (Mart) and Anna Kuhlman Johannigman. Matt died Dec. 4,1935 in Hines Veterans Hospital near Chicago Cecilia died April 29,1960 in Greensburg In.

1.Urban Joseph Johannigman born on Sept.24,1927 married Marjorie Catherine (Veerkamp) born Feb.11,1928; on Oct.19,1949. They had 11 children.

Elizabeth Ann (Betty)Johnnigman b/Oct.16,1950 married Richard Marcus Silcox b/Apr.10,1949 ;on Oct.9,1971. They had 5 children;Jennifer Ann b/Dec.19,1972;Richard Marcus, Jr. b/Sept.8,1974;Jeffery Leon b/Nov.29,1975;Christina Marie b/Aug.15,1978;Brian Jasper b/June 5,1981.

Margaret Mary Johannigman b/May 2,1952 married David Terry Ledford b/Sept.18,1946 on Sept.7,1970. They had 4 children; David William b/Jan.9,1972;Robert Wayne b/Jan.1,1973;Michael Allen b/ Nov.6,1974;Eric Lee b/Feb.4,1979.

Donna Marie Johannigman b/June 21,1953, married Raymond Bernard Schwering b/Sept.6.1946, on July 28,1973. They had 2 children;Andrew James b/Aug.19,1974;Patrick William b/June 14, 1976.

Marilyn Rose Johannigman b/Sept.9,1954, married Paul Joseph Bedel b/Feb.11,1952, on Aug.2,1975. They had one child;Jeremy Paul b/Feb.9,1987.

Catherine Jean Johannigman b/Nov.3,1955, married Ambrose Matthew Bedel b/Mar.10,1954, on May 29,1976. They had 5 children; Alexander Jacob (A.J.) b/May 31,1977;Stacie Marie b/Apr.30,1979; Jessica Rose b/Oct.7,1980;Tina Jean b/July 6,1983;Lesanne b/Oct.5,1989.

Janet Diane Johannigman b/June 30,1957, married Mark John Bedel b/Jan.28,1960, on Apr.17,1982. They had 4 children;Marcus John b/Apr.30,1986;Nicholas Urban b/Mar.11,1988;Theresa Rose b/ Aug.31,1989;Dennis Jacob b/May 21,1992.

Darlene Kay Johannigman b/May 9,1958, married Robert Eugene Engleking b/Aug.17,1951, on Sept.20,1980. They had 2 children; Andrea Kay b/Mar.9,1983;Ryan Eugene b/Mar.6,1987.

Urban Dale Johannigman b/ Jan.19,1963.

Charles Edward Johannigman b/Apr.7,1964, married Cheryl Katherine Powers b/Dec.9,1968,on Oct.10,1987. They had 2 children;Christen Joan b/Jan.21,1987; Charles Craig b/Sept.5, 1989, died Oct.21,1989.

Dorothy Sue Johannigman b/Nov.30.1969,married Kenneth Allen Hellmich b/Nov.6,1964, on Aug.13,1987. They had 2 children; Deidre Lynn b/Nov.17,1987;Jared Allen b/May 18,1992.

Laurie Lynn Johannigman b/Oct.4,1971.

2.Roman Johannigman b/March 15,1929,at Millhousen In, and Marjorie Scheidler. They had 10 children.

Roman Joseph Johannigman b/Sept.17,1955,married Margaret Jean Wallpe b/Nov.11,1955, on May,15,1976. They had 2 children: Nathan John b/Apr.21,1981;Aaron Matthew b/Apr.22,1985.

John Johannigman b/Sept.4,1957, married Cynthia Diane Koors b/July 7,30,1958, on Aug.5,1978. They had 4 children;Robert John b/Oct.2,1980;Lisa Marie b/July 29,1982;Kelly Ann b/Dec.2,1986; Trent Joseph b/Nov.2,1992.

Edward Johannigman b/July3,1959,married June Ann Brancamp b/Aug.13,1961,on May 9,1981. They had 4 children;Bradley Robert b/Jan.14,1983;Abigail Marie b/June 2,1985;Emily Louise b/Nov. 30, 1987;Leanna

Rose b/Sept.24,1990.

Paul Johannigman b/June 8,1961,married Marsilla Louise Kohlman b/Apr.7,1958, on Apr.12,1980. They had 4 children;Rebecca Lynn b/May 2,1981;Jessica Louise and Jennifer Louise (twins) b/ March 2,1983;Vanessa Marie b/Dec.2,1987.

Jane Ann Johannigman b/June 4,1963,married Kevin Ray Faulconer b/Nov.10,1958,on Sept.27,1986. They had one child; April Dawn b/Sept.13,1989.

James Aloysius Johannigman b/Aug.26,1964,married Peggy Lee Nighbert b/Nov.6,1968, on June 4,1988. They had 2 children; Megan Kay b/ Jan.3,1990;Jamie Lee b/Jan.4,1993.

Jean Ann Johannigman b/Nov.8,1965,married Michael Lee Hooton b/Apr.6,1961,on May 20,1989. They had one child;Chelsae Leann b/ Dec.29,1990.

Joan Cecilia Johannigman b/Aug.21,1968.

Joseph Johannigman b/Aug.18,1969.

William Carl Johannigman b/Oct.12,1971, married Nicole Lynn Rupp b/May 28,1970, on May 22,1993.

3.Justin Johannigman b/Nov. 25,1930 and Evelyn Schwering. They had 7 children.

Susan Mary Johannigman b/Apr.19,1954,married Stephen David Koors b/Feb.7,1952, on June 18,1977. They had 4 children;Matthew Stephen b/Sept.22,1978;Andrew Stephen b/Sept.11,1980;Amy Sue b/ March 7,1983;Beth Ann b/July 25,1986.

Thomas Justin Johannigman b/Jan.13,1956,married Lois Jean Merkel b/May 4,1957, on Apr.22,1978. They had 4 children; Jennifer Lynn b/July 16,1979;Kristie Sue b/Oct.22,1980;Michael Thomas b/March 3,1983;Craig Thomas b/Oct.5,1984.

Mary Evelyn Johannigman b/March 26,1957, married Michael Moorman b/Sept.9,1951, on Dec.10,1977. They had 3 children; Rebecca b/Dec.24,1978;Jeffrey b/March 5,1980;Maria b/Jan.29,1984.

Linda Marie Johannigman b/July 7,1958, married James Harvey Hollis b/Jan.25,1959, on Aug.14,1982. They had one child; Catherine Mary b/May 7,1992.

Julie Ann Johannigman b/Aug.2,1962 married Kevin Richard Bower b/June 29,1959, on May 14,1983.They had 3 children; Joshua Adam b/Feb.1,1985;Kimberly Ann b/May 17,1987;Jessica Elizabeth b/ Oct.8,1990.

Karen Elizabeth Johannigman b/Nov.3,1963, married William C. Brown b/April 26,1964, on Sept.14,1985. They had 3 children; Rachel Elizabeth b/Apr.8,1987;Eric Justin b/Nov.23,1989;Tyler William b/Dec.23,1992.

Mark Justin Johannigman b/Feb.27,1969.

4.Carolyn Johannigman b/June 12,1933 and Paul H.Gallagher. They had 3 children.

Paul Hugh Gallagher, Jr. b/Jan.9,1963,married Lenora Meese b/ Dec.2,1963, on Oct.5,1985. They had 2 children;Elizabeth Ann b/ Dec. 4,1989;Gregory Paul b/Jan.8,1993.

Cecilia Marie Gallagher b/Sept.24,1965,married Jonathan Wayne Crone b/Jan.2,1966, on Sept.10,1988. They had one child; Allison Marie b/July 16,1992.

Joseph Mathias Gallagher b/ Sept 7,1967.

LOUIS CHARLES THOLE
by Daniel Thole

Louis Charles Thole was my father. He was born on March 4, 1905, in Napoleon, Ind. and was raised on his father's farm. He was the son of John Bernard and Carrie(Monter) Thole. He attended the Napoleon St. Maurice Catholic Church school. He had 7 brothers and sisters:Carrie,Cecilia,Loretta,Mathias,Al(his twin), and John. He graduated on June 30,1921, at age 16. His teacher was Aunt Marie Monter, when he was about 13, dad took a job working in a stone quarry carrying boxes of dynamite out to the blasting area. He was paid ten cents per hour,he quit and took a job as a carpenter with the Batesville Casket Co.

When dad was about 17, he left his father's farm and went to Cincinnati to find work. He was one of the hardest working men I have known. I think it was the call of the big city, and the chance for him to be on his own and make his own way in life. When dad arrived in Cincinnati, he stayed with his sister Loretta while he looked for a job and until he could earn enough money to live on his own. He soon found full time work with the American Laundry Co. and a part time job with the A&P Grocery Co. as a stock clerk. While dad was at Sunday Mass one day, he noticed a young girl during the throat blessing ceremony and followed her home. He talked to the girl's sister, Marie, and found out the girl's name was Hilda Schneider. Mom told me that when daddy asked her out that first date, Grandpa Schneider questioned daddy quite closely as to his religion, background, etc.,and that when Grandpa Schneider found out that dad was both Catholic and German, he was in good stead.

Grandpa Schneider soon learned that his daughter's boy friend worked for his competitor, The A&P Grocery Co.,and decided that this would never do. He asked daddy if he would come to work for him at the Schneider Grocery Co. Dad quit the A&P Co. and went to work for Schneider's while maintaining his other job at American Laundry. Within a year or two, mom and dad were married at St. Elizabeth Church in Norwood, Ohio, on Oct. 15, 1929. Daddy continued to work at both jobs until an opening for a store manager occurred at the Schneider's store on Smith Road in Norwood. It happened that the store manager at the time had been caught once again drinking on the job and had been terminated. Dad was offered the job and he quit the American Laundry Co. Eventually, he was promoted to Store Supervisor.

My Uncle Joe Schneider had a house in Wyoming (a part of Cincinnati), with about a acre of land in back of it, and during the 2nd World War, dad as most people, started a Victory Garden. Every Wednesday afternoon, dad would grab one or two of his older boys,Jerry,Jacky,or Louie, and go the Uncle Joe's to weed and hoe the garden. Pop loved to work in that garden, and he not only fed our own family off of it, but gave a lot of it away as well. I guess it was the farmer coming out in him. Jacky told me that Pop would always take his rifle with him. He never missed a chance to go shooting. It was a Model 63 Winchester, that Mom gave to him for a Christmas present in 1937.

In 1951 Dad was diagnosed as having cancer of the colon. Jerry told me "I can remember it like it was yesterday, because Dad and Mom told all of us kids as we sat around the table for my 21st birthday party." What a birthday present! Dad was operated on and they preformed a colostomy. After the operation, dad continued to work for Schneider's until the company closed in 1952. With Schneider's having closed down, he went to work for a grocery store called King Duffy in Pleasant Ridge, but as luck would have it, it too went out of business, and dad was again out of work. After that, dad had a hard time finding a job due to his age, he was about 49 years old, unemployment was high and time were tough. My dad took a job selling Fuller Brushes from door to door in order to pay the bills, while he continued to look for work in the grocery business. I used to help did pack his brush orders when they arrived for his customers in our basement on Greenland Place. A number of times I helped him deliver them.In 1955, Dad found a job with Albert Grocery co.and quit Fuller Brush. He worked for

Albert as the produce manager until he retired in 1970. After retirement he took a job working at a produce market called the Big Tree. Daddy worked at the Big Tree for six years, by this time he was 71 and must have figured enough was enough. For the next 10 years he sat back and enjoyed his children and grandchildren. Dad loved to listen to the baseball games on the radio, and rarely missed one of the Cincinnati Reds. He really enjoyed baseball, and was very good at it when he was a young man. I can remember playing pitch with dad in our backyard on Greenland Place. I was about 13 or 14 and dad would practice with me using his curve ball.

Pop would buy a wooden box of Remington Long Rifle bullets for his rifle. There were 10,000 rounds in a box and he would use at least one per year. Pop, and Uncles Joe and Lou Schneider, would take some of the excess cats from the Schneider warehouse out to the farm, give the cats about a 25 yard head start, and then would shoot the hell out of them. They also shot down one of the chimneys on Aunt Celia's farm one Sunday afternoon. Pop was an excellent shot with that rifle. He would practice driving nails into a fence post by shooting at the nail head. I once saw him shoot a wood pecker from a tree at 110 paces on the farm, and another time I saw him shoot a flying sparrow from the air. Pop told me that when he and his friends went rabbit hunting, he would get as many with his model 63 as his friends got with their shotguns. One day he got lost in the woods while hunting and before he found his way out, he had shot 11 rabbits.

Dad was extremely hard working, he'd be gone in the morning before I left for school, and wouldn't come home until 7 or 8 O'clock at night. IN May of 1983, Cancer was once again diagnosed in Dad, but this time it was in his spine and dad progressed to far, by December he was almost totally bed ridden, On January 26, 1984. Daddy died.

HILDA ANNE SCHNEIDER THOLE
by Charles Thole

Hilda Schneider, is my mother and was born in Norwood, Ohio on Nov. 4, 1905. She was one of eleven children, and has many interesting stories to tell of her childhood in the early 1900's. I guess her brothers and sisters were somewhat mischievous and she told a number of stories of their escapades. I suspect her brothers Joe and Martin were the worst of the lot, and must have thought most service men were overweight and needed exercise. In the early 1900's there were no electric refrigerators, and ice was put in insulated boxes along with the food to keep it cool. The iceman would deliver 50 lbs kegs of ice to each home as often as the housewife would need it. One of Mom's brothers favorite tricks, was to lean out the window and yell out "50 pounds please". The Poor iceman would lug that block of ice up the stairs, only to find out that Mrs. Schneider didn't need any. I imagine he could have killed those boys if he could have got his hands on them. Another favorite trick of theirs, when the circus came to town and paraded down the street, was to inspire the horses of the circus to greater heights, by shooting them in the rump with their slingshots. When Grandma graduated from high school, she took a job as a private secretary to the sales manager of a company called Kemper-Thomas Co. She worked this job for four years until she married Louis Thole.

After mom married dad, she soon had her hands full raising us kids, and knowing my brothers and sisters, I'm sure she was kept very busy. Early in their marriage, mom and dad would take us kids to Grandma Schneider's house on a weekly basis. On day during the Christmas Season, they were at Grandma's house with Jerry. Mom and Jerry was being a real brat that day, and she couldn't control him, so she went upstairs to their attic, and put on the Santa Claus suit that her dad always used to wear at Christmas, She then went around to the front of the house and knocked on the window to get Jerry's attention. When Jerry look at her, there was Santa Claus shaking his finger at him. Mom said Jerry was so worried, that he was a little angel for the rest of the week.

Mary Loretta Thole was born 8 August 1899 in Cincinnati, Hamilton County, Ohio, the fourth child of John Bernard Thole and Maria Carolina Monter. Her father, John Bernard, was born in Cincinnati 5 April 1861. He died in Napoleon, Indiana 28 April 1928.

John Bernard married Maria Carolina (Carrie) Monter 10 October 1892 at St. Ludwig Church, Cincinnati, Ohio. Carrie was born 11 September 1870 to Ludwig Monter and Mary Anna Doll. She died 28 December 1959 in Millhousen, Indiana.

In 1903 the family moved to Napoleon, Indiana to a farm Loretta's father had purchased prior to his marriage. A new house awaited the family, and John Bernard was anxious to become a farmer.

Loretta attended parochial school in Napoleon, a walk of a mile or more. The family was very musical and many evenings they gathered around the piano while her mother played and the children sang.

In her early 20's Loretta worked in Cincinnati, Ohio and often visited her uncle, Rev. Aloysius Monter, pastor of St. Agnes Church in the city. There she met Adolph Vincent Kohmescher, who often did odd jobs at the church for Rev. Monter. Adolph and Loretta were married 6 June 1922 at St. Maurice Church, Napoleon, Indiana. The couple took up residence in Norwood, a suburb of Cincinnati, Ohio.

Adolph was born 25 January 1895 in Cullman, Alabama to Francis and Mary Elizabeth (Honebrink) Kohmescher. He died 26 January 1966 in Cincinnati, age 71 years. Loretta died 10 April 1986 in Gunter, Grayson County, Texas, age 86 years.

Three children were born to this union. Jerome Joseph Kohmescher was born 21 March 1923 in Cincinnati. He joined the U.S. Air Force in 1943 and was commissioned an officer in January 1944. He married Ruth E. Von Holle 15 January 1944. Jerry was a builder of luxury homes. He is an avid golfer, winning many championships. Their children:

1. Bonita S. Kohmescher b. 20 May 1945; m. John Strunk 18 June 1966
2. Gregory H. Kohmescher b. 28 April 1947
3. Judith M. Kohmescher b. 1 September 1950; m. Bruce Berris 17 June 1978
4. Carol A. Kohmescher b. 11 October 1952; m. Steven Tedeschi 31 Mar 1979
5. Paul H. Kohmescher b. 17 Oct 1957; m. Barbara Bateson 8 Sept 1990
6. Diane C. Kohmescher b. 27 Dec 1963; m. Robert Vorbroker 10 March 1990

Adele Marie Kohmescher was born 25 October 1925 in Cincinnati, Ohio. She married George Ernest Porteck Jr. 25 July 1952. They moved to Dallas, Texas, where their three sons were born. George was a commercial real estate broker, operating his own firm. Adele was a residential real estate broker. In 1993 they retired in Tucson, Arizona. Their sons:

- Jeffrey J. Porteck b. 7 May 1953; m. Mary Issacson 15 May 1976
Kevin G. Porteck b. 2 May 1956; m. Kathryn Gathany 25 September 1982
Gregory E. Porteck b. 7 September 1961

Their third child, Joan Mary Kohmescher, was born 11 July 1927 in Cincinnati, Ohio. Joan was born mentally retarded and died 15 December 1992 in Gunter, Grayson County, Texas.

AL AND ESTHER(BRUNS) THOLE

Aloysius Christopher Thole was born on March 4, 1905 at Napoleon In. The son of John Bernard and Carrie(Monter) Thole.

Al's father, John Bernard was the son of John Otto and MaryAnna(Lamping) Thole. One of six children, John and his sister Philomena(Thole) Rutt were the only children to reach maturity.

Al Thole and his twin brother Louis Charles Thole were both around 3 lbs at birth. His grandparents Louis and Mary(Doll)Monter, lived with them. Their Grandpa Monter baptised them after they were born "just in case". They were fine.

He attended the St. Maurice Catholic School in Napoleon. One of his school mates was Esther Bruns. After he got out of school he helped at home and hired out as a farmhand. He was also a good mechanic and did all his own repairs.

Al and Esther Bruns were married on Oct. 21, 1933 at St. Maurice church at Napoleon. Esther was born on May 4, 1908 four miles West of Napoleon, at home. She was the daughter of William Herman and Mary Gertrude (Hahn) Bruns. She was one of seven children: Elmer, Bernetta, Charles, Sylvester, Elizabeth, Irene. Esther worked for a time as a maid and as a nursemaid for two children in the household in Cinn. Ohio. After returning she was courted by and married Aloysius Thole.

After they were married, Al's mother, Carrie(Monter) Thole sold the family farm to Al and moved with her daughter Carrie and her niece Marie Monter, moved to Millhouse. Al took over the care of the family farm.(80 acres) He also did custom work, combining wheat, Shred corn. He raised pigs, chickens, cows, and sold eggs and milk.

Al and Esther attended the St. Maurice Catholic Church at Napoleon. They had no electricity and no water in the house for about two years. Esther cooked on a coal@oil stove in the summer and otherwise she used the old Iron stove. She did laundry on an old washboard. They did their own butchering and made their own laundry soap with grease and lye. They finally got electric. in the early 1940's.

Around 1956 they sold their farm and bought another 80 acre farm farther down the road. The stone quarry was getting close and rocks would fly and hit the roof and such, the new land also had a much better well.

Al became ill around 1983 with alzheimers, then he came down with bone cancer. He passed away May 26, 1988 at Batesville, In. Esther presently resides at the old homeplace, now owned by their son Paul Thole.

Al and Esther Thole were the parents of 7 children: Eileen, Jane, Marie, Rita, Martha, Anita, Paul.

1. •Eileen Marie Thole• was born Sept. 21, 1934 at home in Ripley Co. In. She was married to Cletus Wagner on Sept. 10, 1956. She works at the Napoleon Bank. Her husband Cletus is retired. They attend the Catholic church and live between Napooleon and Osgood. Eileen and Cletus Wagner are the parents of six children: 1. Marlene K. who married Joe Prickle and have 3 child: Vanessa, Jarred, Ernie. 2. Thomas who married Carol Hues and has 4 child: Chris, Ashly, Ben, Kelsey. 3. Kenny who married Donna Vanausdale and has 2 child: Jeramy and baby in Sept. 4. Janice who married Mike Simon and has one child: Tanaha. 5. Robert who married Linda Meyers. 6. Jeffery who married Susan Brancamp.

2. Jane Carolyn Thole was born on Sept. 27, 1935 in Ripley Co. IN. She was married on July 6, 1963 to Wayne Reeder. They live in Indianapolis. She works at the Indianapolis news office and Wayne works in Naval avionics. They have 3 children: Alan, Amy, David.

3. Marie Esther Thole was born on Dec. 31, 1938 at home in Ripley Co. In. She was married on Oct. 8, 1960 to Robert Joseph Haunert. Her husband is a farmer at Clarksburg. They farm a large family farm. They are the parents of two children: 1. Kirt 2. Belinda who married Larry Hagar and have two children: Jessica and Landon.

4. Rita Thole was born on Dec. 21, 1942 in Ripley Co. IN. She was married on June 2, 1962 to Cyrial Duerstock. (Div.) Rita lives outside of Napoleon just one mile down the road from the old Thole homestead. She has an associate degree in Human Services and works in BCA a factory in Greensburg. She and Cyrial had four children: 1. Kevin who married Kathy Schoettmer and has a dau. Kristin. 2. Michael who married Joan and has two child: Natasha and Travis. 3. Dr. Doug Duerstock who is not married and lives in Batesville. 4. Jennifer who is not married.

5. Martha Thole was born on Jan. 23, 1941 in Ripley Co. In. She was married on Oct. 13, 1962 to Donald B. Moorman. Martha and Donald live a little ways out of St. Maurice. Donald works at Delta faucet. Martha does housecleaning. They are the parents of four child: 1. Dennis, who is studying for the priesthood. 2. Bryan is not married 3. Melany who married Don Warner. 4. Sheila, who is studying to be a nun.

6. Anita Thole was born on April 18, 1946 in Ripley Co. In. She was married on June 26, 1976 to Doug Holley. (Div.) Her husband is a construction worker. Anita works as a beautician at J.C. Penny's Styling Salon in Columbus, In. They had two child: a daughter Tallia and a son Tyler.

7. Paul Thole was born on March 11, 1950 in Ripley Co. IN. He attended college and is presently a teacher and administrator at Jac@Cen@Del High School in Osgood. He was married on Aug. 2, 1980 to Marjorie Meyer. Marjorie is a first grade teacher at Jac@Cen@Del grade school. Paul has purchased the family farm where he and his family currently live. He rents out the farmland. Paul and Marjorie are the parents of four children: Michelle, Michael, Adam and Abby. All attend the Jac@Cen@Del school system.

JOHN BERNARD AND ALMA(KOHLMAN) THOLE

John Bernard Thole was born in 1908, the son of Bernard and Carrie(Monter) Thole. He grew up on his parents farm just out of the town of Napoleon, in Ripley County Indiana. He was one of seven children: Mary Louise, Carrie, Mary Cecilia, Loretta, Joe Mathias, Louis and Aloysious(twins), and John Bernard.

His family were Catholic ans attended the St. Maurice Catholic Church in the town of Napoleon. He attended the Catholic school in Napoleon, and this is where he first met a schoolmate Alma Kohlman.

When he was young he helped his dad out on the farm. He later worked on the highway and also at the Napoleon Stone Quarry which was very near their house.

John Bernard Thole was married to Alma Kohlman on Oct. 10, 1936 at Napoleon, Indiana. Alma was the daughter of Charles and Marie (Meyer) Kohlman, of Napoleon. Both John and Alma were born and raised in the area.

He purchased his own home and fourty-eight acres of land. The land fell partly in Ripley County and partly in Decatur County.

John and Alma had one child, a daughter, Patricia Ann Thole who was stillborn on Feb. 28, 1942.

John and Alma Thole are members of the St. Maurice Catholic Church in Napoleon.

John Bernard belonged to the Eagles for most of his life. John and Alma Thole currently reside at their home near Napoleon, Ind.



AL AND ESTHER THOLE, AND
BROTHER LOU AND HILDA THOLE
AL_ESTHR.TIF



AL AND ESTHER THOLE
AL ESTR2.TIF



JOHN BERNARD THOLE
J_B_THLE.TIF



JOHN AND ALMA THOLE
JOHN_ALM.TIF



JOHN B. THOLE AND WIFE CAROLINA (MONTER)
JHN_BERN.TIF

MATHIAS AND PHILOMENA (THOLE) RUTT

Mathias Rutt was born in Germany on December 1, 1841. at Vussem County in the district of Aachen in Rhineland Germany. This is very near the town of Mechernich and about twenty miles from Cologne. Mathias told stories of Alsace-Lorraine. He told the grandchildren stories of how the berry bushes were so full of berries that you just sat your pail under it and shook the bush and your bucket would be full of berries.) He mentioned that they lived near the Rhine River and that they could see the river from their house.

He was the son of Johann Rutt b/1810, and Mary Anna [Steffens] Rutt b/1815. His father Johann was a coal miner. His mother, Mary Anna Steffens, was French.(This was what he told his grandchildren.) They were German speaking.

Mathias worked in the coal mines of the Rhineland area also. He was the third oldest child of a large family. Mathias was the oldest son.(It is thought that possibly one of his brothers may have come to America also, but at a later date.) There were 11 children in all. Maria, Maragret, Mathias, Wilhelm, Johann, Werner Joseph, John, Peter, Anna Maria, Johann, Werner.

In 1860 Mathias Rutt's father Johann Rutt was killed in an accident in the coal mines, when Mathias was 19 years old. Mathias worked in the coal mines and helped with taking care of the family.

The area of Rhineland where they lived was a rich and fertile land. It was also very near to the French border. There were numerous wars between Germany and France over this area.(Alsace - Lorraine) It would be considered Germany or France, he said, depending on who had won the last battle.

Mathias had fought in four of these battles and had been wounded twice. He had a nick in his shoulder where a wound by a musketball had taken a chunk out. He did not like the wars.

In 1869, at the urging of his mother, who told him to, "go to America," He had been in four skirmishes and she said that," he had fought enough and he should go to America while he could." He asked her to go also, but she declined, saying that she had too many young children still at home to care for.

Matthias came to America in 1869, but he continued to keep in touch with his family through letters with his mother. He and his mother coresponded until the time of her death. I believe this to be sometime after 1884.

Matthias boarded the Ship Hommonia from Hamburg, and Harve-France and arrived on June 29,1869 at New York Harbor. He was 28 years old. He traveled to and settled in Cincinnati, Ohio at Mount Adams. He became employed as an Iron Moulder. He had a blue spot on his index finger where he had a piece of metal imbedded in it, and never got it out.

He met a young woman named Philomena Thole. They began seeing each other, and were married in Cinn. Ohio, on Aug. 13, 1872 at the St. Philomena, Catholic church in Mount Adams. (This church has since been torn down to build a highway.)

Philomena Thole was born on December 4, 1851 in Cinn. Ohio, the daughter of John Otto Thole, born on Sept. 23, 1815 in Germany and Mary Anna[Lamping] Thole, born in June of 1820, in Germany. She was one of five children but had only one brother, John Bernard(Joe) Thole, living. Her brother had married Carrie Monter.

Matthias called Philomena, " Mene", and she called him Mattius. They resided with Philomena's brother Joe Thole and his wife Carrie. They had a son born on December 24, 1872. He was not well at birth, he lived only a short time, he died the same day. I believe he was named Charles.

Their second child, Mary Anna Rutt, was born on Jan. 4, 1874 at Cinn. Ohio. in Hamilton County. She was baptised at the St. Philomena church there.

They lived at Mount Adams in Cinn. Ohio until Mary was ten years old, in 1884. At this time, Philomena's brother John purchased a farm in Ripley County Indiana, in Jackson township. Mathias moved first to Napoleon to manage the farm for his brother-in-Law. Joe Thole followed later, bringing his family to Ripley Co. Indiana.

Matthias and Philomena Rutt's daughter, Mary Anna Rutt, married Frank John Hessler on Sept. 21, 1897 at the St. Maurice Catholic church in Napoleon. They moved to a small town called Millhousen, not far away. Frank's father owned a farm there and They set up housekeeping in his fathers old log cabin on the farm. Frank and Mary(Rutt) Hessler were the proud parents of 15 children.

Around 1903 the Thole household had grown. Carrie's parents had come to live with them also. There was

a tension in the house. One day when Frank Hessler came to visit them, and found Philomena in the barn shucking corn. [She would work furiously when she was upset about something.] It was too crowded there.

Frank asked her and Matthias to come home to live with he and Mary at Millhousen. With their family growing they could use the help. They agreed and Matthias and Philomena moved that day. At their new home their daughter Mary was very busy with the young children. Philomena took over the cooking and much of the canning and perserving. Mary cared for the children and the house cleaning chores. It worked quite pleasantly for all. I believe mathias was naturalized in Cinn. Ohio.

Matthias helped with the feeding , milking, and various chores around the farm. This freed Frank to get more work done in the fields.

They became members of the Millhousen Catholic church, and they attended regularly.

They spoke English and German but more German. Mathias spoke only low German, but Philomena was fluent in both High and low German. They also sang many German songs. Mary Cecilia (Hessler) Dwenger. said that she did not learn to speak English until she started to school, where they spoke only English. Her father said that at school you speak English as they tell you to, but at home you are to speak German.

They moved with Frank and Mary, when they moved from the farm into a home in the town of Millhousen.

Grandma(Philomena), worked very hard, helping to care for the children, the house, and sewing until around 1919, when she got arthritis in her knees. After that she sewed, patched, and quilted.

She worked and sang songs to the blessed mother for the most part. Usually she sang in German. She prayed the rosery often.

One day when Mary Cecilia, her granddaughter had been planting beans. She returned to the house for dinner with the left over beans in a brown sack. While grandma Rutt(Philomena) was praying, Mary put the sack on grandma's head, and as Grandma bowed her head at the Glory be to the father, the beans went all over the table.

Grandpa Matthias would tell stories to the grandchildren about Alsace Lorane, and his home in Germany. He would tell them that there the berry bushes were so full that all you had to do was put your pail under the bush and shake the bush and your pail would fill up with berries, you didn't even have to pick them.

Philomena, when hearing him tell these stories would scold him for it. " You shouldn't tell the children such lies." "They aren't lies, not really, just streaching the truth a bit."

Grandpa(Matthias) for the most part, read books and papers, prayed the Rosery and was just peaceful. He and Grandma Rutt, (Philomena) were good to the children.

When Helen Hessler was a young child, she was the baby of the family. When many of her older brothers and sisters were out with jobs. She had an old tin headed doll, (named Susie), that had been painted over and was not too good looking. Her older working brothers and sisters bought her 5 or 6 new nice dolls. She liked the new dolls alright, but she continued to play with her Susie. Her brothers and sisters wanted her to get rid of the old beat up doll and play with a nice new ones.

She did not want to, so they told her teasingly that when she went to bed at night that they were going to take the old doll and throw it away so she would have to use a new one. This worried her terribly, and Grandpa Matthias (who always called her honey babe) asked her what was wrong. She told him of the danger to her baby doll Susie.

He offered her a solution. " Why don't you leave her with me each night, and I will keep her safe under my pillow, and in the mornings you can come and get her."

So this was what they did. He always went to bed earlier than the others. He would put Susie under his pillow. He always slept late in the mornings, and when she would get up she would go to him and get Susie from under his pillow. And nothing ever happened to her this way.

When Matthias and Philomena grew older they would sit, Philomena with her sewing, crocheing or darning, singing softly, and Matthias reading his Newspaper.

Philomena, after a time would stop singing and ask, " Mattias, what are the neighbors doing?" (She would call each by name.)

Matthias would say, "I don't know Mena" She would say, "Well surely you know something!" "No" He would assure her. "No, he did not know anything."

Finally Grandma(Philomena) would say, " Mattias, it looks like you could put that paper down and talk to me sometimes." Where upon would put the paper down, carefully folding it up, and say, "Now Mena,

what shall I say?"

By this time Philomena was aggravated and would say, "Oh, What shall I say!"

Dead silence would follow, and in a few minutes, she would go back to singing and he would pick up his paper and begin reading again. All was over. This was basically a regular routine with the two of them.

Their granddaughter Christine, told that she often picked up the green apples and pounded them soft and gave them to grandpa.

Grandpa, Matthias, was a good kind, old man, but he liked to have a drink and there went the little money they had. He for the most part, read books and papers, prayed the rosary and was just peaceful. All Grandpa Rutt required in his days were to sit in his rocking chair, with his newspaper, a plug of tobacco, and his rosary.

Matthias Rutt passed away on Sept. 7, 1927 at Millhousen Indiana and was buried in the far Eastern corner of the Millhousen Cemm.

Philomena continued to live with her daughter Mary at their house in Millhousen.

When the great grandchildren would get into trouble, she would often come to their rescue, at times stoping a spanking.

Philomena(Thole) Rutt, died at the home of her daughter, Mary Hessler, on Dec.1, 1935, and was buried beside Matthias at the Millhousen Cemm. Two large wooden crosses were put up to Mark the graves, but both gone now.



Mathias Rutt b/1841 Germany
 Philomena(Thole)Rutt b/1851 Ohio
 parents of Mary(Rutt)Hessler



Mary Rutt age 18
 born July 5, 1874 Ohio



Clara, Matilda, Francis, Ceal, Rose
 Grandmother, Grandfather, Mother, Daddy

Chris, Joe, Helen, Gertrude

Prank Hessler family
 sitting on ground: Chris, Joe, Helen, Gertrude
 middle: Philomena and Mathias Rutt, Prank and Mary
 standing: Clara, Matilda, Francis, Ceal, Rose



Anna Mary Rutt (Hessler) age 6 1880
 dau. of Mathias and Philomena Rutt Mary Rutt's Uncle John Bernard
 Thole took Mary to get her picture taken. Her mother dressed her
 up in a pretty dress. Her Uncle didn't think to take off her coat.

RÜTT

married *Jean (Johann) Rutt b/1735? Prussia, Germany
around 1760's

Elizabeth Muller b/1727 prussia, Germany
d/Sept. 15, 1826 Vussem, Ger.

daughter of:
Thomas Muller
and Catherine
Volm

*** Children of Johann and Elizabeth:

1. b/1769 Vussem Anton Rutt d/Feb. 24, 1820 m/1800 Anna Catharin Mieszen child: 1. Anna Catharina b/July 4, 1802 M/11 Feb. 26, 1829 Johann Esihweiler (died) M/12 May 3, 1834 Heinrich Vogelburg child: Warner Vogelburg Maria Elizabeth Vogelburg Johann William Vogelburg Wilhelm Vogelburg 2. Maria Anna Rutt b/Oct. 25, 1804 M/May 3, 1834 Johann William Vogelburg child: Anton Vogelburg 3. Mathieu Rutt b/Aug. 4, 1807 4. Jean (Johann) Rutt b/Jan. 5, 1810 m/Sept. 15, 1835 Mary Anna Steffens b/March 17, 1815 child: (Wilhelm, Johann, Werner, Mathias, Johann, Peter, Anna m., Margareta, Mary Anna, Johann, Webner) 5. Wernerus Rutt b/1806 Rhineland m/Oct. 20, 1828 Christine Sistig child: (Martha, Johann, Elizabeth, Heinrich, Anna Catharina)	2. b/? d/July 20, 1833 Anna Maria Rutt m/ Johann Kolbenbach child: 1. Hubert Kolbenbach b/Aug. 10, 1802 Vussem, Rhineland 2. Jean Kolbenbach b/Oct. 11, 1804 Vussem, Rhineland 3. Anne Catherine b/April 7, 1806 Vussem, Rhineland 4. Anton Kolbenbach b/July 3, 1808 d/Feb. 1812 Vussem, Rhineland Prussia d. 1814 5. Mathieu Werner Kolbenbach b/	3. b/1760? d/Apr. 1808 Johann (Jean) Rutt m/Aug. 20, 1781 Catherine Mieszen child: 1. Anna Elizabeth b/Jan. 12, 1796 m/Aug. 25, 1831 Franz Hiessler d/1832 child: Johan Hiessler 2. Hubertus Rutt b/Dec. 23, 1798 Vussem, Prussia Rhineland 3. John Rutt b/Feb. 24, 1802 m/June 1, 1837 Anna Sibilla Cremer child: Constant b/1838 Gertrude b/1840 Wilhelm b/1843 4. Anna Catherine b/Oct. 27, 1804 Vussem, Prussia Rhineland 5. Elizabeth Rutt b/1811 Vussem d/Sept. 12, 1812	4. b/177- Jean Rutt d/Dec. 1811 m/ child: not married died at Vussem in Hartzheim, Aachen Germany
---	---	---	--

children of Anton and Anna Cath. (Mieszen) Rutt:

1. b/1802 d/9/22/1833 Anna Catharine Rutt M/1/Johann Esihweiler M/2/Heinrich Vogelburg child: 1. Mathias Esihweiler D/Feb. 19, 1833 2. Werner Vogelsburg 3. Maria Eliz. Vog. 4. Johann Wilhelm Vog. died/1872 5. Wilhelm Vogelsburg	2. b/1804 Maria Anna Rutt M/Johann Wm. Vogelburg child: 1. Anton Vogelsburg (died young)	3. b/1807 Mathieu Rutt M/? died after 1820	4. b/1810 Jean (Johann) Rutt m/Mary Anna Steffens child: 1. Maria Anna 2. Margaretha 3. Mathias 4. Wilhelm 5. Peter Joseph 6. Johann 7. Werner 8. Werner Joseph 9. Johann 10. Anna Maria 11. Johann	5. b/1816 Wernerus Rutt m/Christine Sistig child: 1. Maria Cath. b/Aug. 21, 1829 2. Johann b/Apr. 2, 1831 3. Elizabeth b/Apr. 3, 1834 4. Heinrich b/Sept. 5, 1835 5. Anna Catherine b/Aug. 10, 1837	6. Jehul(?) Rutt died Dec/ 2, 1811 M7
---	--	--	--	---	---

Children of Johann and Mary Anna (Steffens) Rutt:

1. Maria Anna Rutt b/June 20, 1837 Vussem d/April 16, 1841 age 3½	2. Margaretha Rutt b/April 17, 1839 Vussem died on Jan. 20, 1848 Vussem (age 9)	3. Mathias Rutt b/Nov. 11, 1841 Vussem D/1927 Indiana m/1871 Philomena Thole child: 1. Charles b/1872 Ohio d/1872 Ohio 2. Mary Anna b/July 5, 1874 Ohio m/1897 Frank Hessler (15 children)	4. Wilhelm Rutt b/Nov. 11, 1843 Vussem	5. Peter Joseph Rutt b/Aug. 16, 1846 Vussem (Prussia) Aachen Rhineland	6. Johann Rutt b/Jan. 24, 1849 prob. died young	7. Werner Rutt b/Aug. 15, 1850 d/May 10, 1860 at age 9yrs. 9mos. old	8. (twins) Werner Joseph Rutt b/Jan. 6 1853 d/Feb. 23, 1853 age 1 Mon. 17 days	9. Johann Rutt b/Jan. 6 1853 d/March 19, 1853 age 2mos. 13 days	10. Anna Maria Rutt b/May 26, 1854 Vussem	11. Johann Rutt b/Nov. 28, 1856 Vussem Rhineland Prussia (Germany)
---	---	---	--	--	---	---	---	---	--	---

Children of Mary (Rutt) and Frank J. Hessler:

1. Philomene b/1894	2. Francis b/1900	3. Mary b/1901	4. Matilda b/1903	5. Ceal b/1905	6. Rose b/1907	7. Clara b/1908	8. Joseph b/1909	9. Gertrude b/1910	10. Christine b/1911	11. Hildegard b/1913	12. Lawrence (b/twins) 1914	13. Al. 1914	14. Helen Marg. b/1916	15. Agnes b/1918
---------------------------	-------------------------	----------------------	-------------------------	----------------------	----------------------	-----------------------	------------------------	--------------------------	----------------------------	----------------------------	--------------------------------------	--------------------	------------------------------	------------------------

(for more information see Frank and Mary (Rutt) Hessler)
History and Graph:

1 CM = 2 KM

Germany (Aachen- RÜTT FAMILY) (Vüsse)

Carte 202 Plis (15-16)

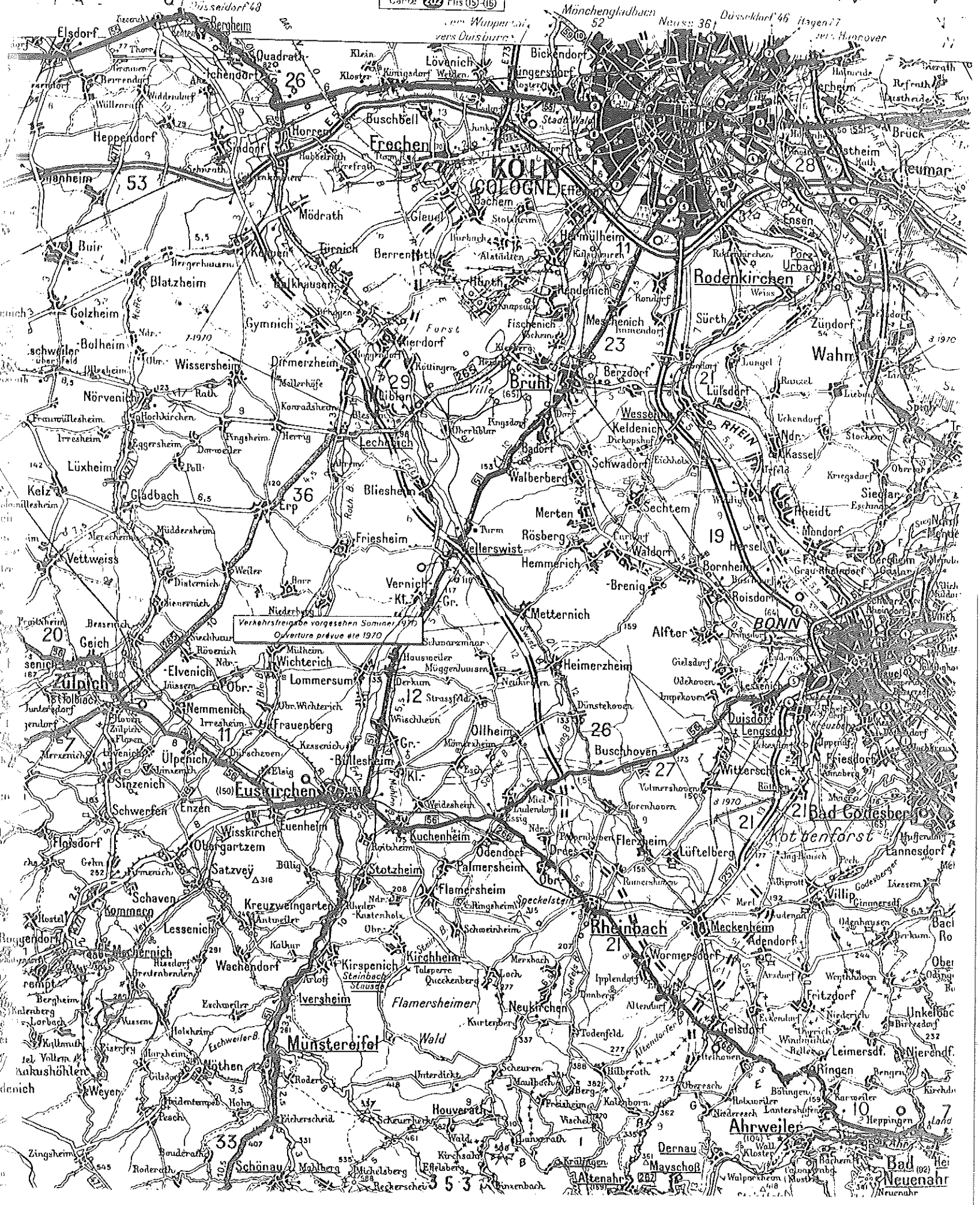

ANTON AND ANNA CATHERINE(NIESSSEN) RUTT

Anton Rutt was born in 1769 at the municipality of Vussem, in the district of Schlesden, region of Aachen, in Rhineland, Germany. He was the son of Johann Rutt, born before 1749, and Elizabeth (Muller) Rutt.

His mother Elizabeth Muller Rutt, was born around 1727. She was the daughter of Thomas Muller and Catherine(Volm) Muller. She passed away on Sept.15,1826 at Vussem, Germany, Aachen. Her death certificate read that she was 99 years old at the time of her death. (* the small town of Vussem in in the very outer edge of the district of Aachen.)

Anton Rutt was one of four children of John and Elizabeth (Muller) Rutt., that we know of:

1. Anton Rutt(Subject of sketch) m/Catherine Niessen.
2. Johann(Jean) Rutt b/Aug.20,1781. He was married to Catherine Nissens. They were Katholisch. They had 5 children: Anna Elizabeth b/Jan.12,1796, Hubertus b/Dec.23,1798, John b/Feb.24,1802, Anna Catherine b/Oct.27,1804 who married Ludwig Missler , Anna Cath. died in Aug. of 1845 Vussem Germany., Elizabeth b/1811 and d/Sept.4,1812 at age one.
3. Jean Rutt b/? d/December of 1811 at Vussem, Hartzheim, Rhineland prussia. He was not married.
4. Anna Maria Rutt b/1775 Vussem, She was married to Johann Kolbenbach. They had 5 children: Hubbert Kolbenbach b/June 26,1802, Jean Joseph b/Oct.11,1804, Anne Catherine b/April 7,1806, Anton b/July 3,1808, Mathew Werner b/June 26,1810. Anna Maria(Rutt) Kolbenbach died on July 19,1833 at Vussem.

Anton was married around 1795 in Rhineland Prussia, to Anna Catherina Niessen.

Anna Catherina Niessen was born around 1776 in Aachen Germany. She was the daughter of Johann Niessen and Barbra (Schmitz) Niessen. Catherine passed away on Jan. 12,1844 at Vussem. Her son Matthew Rutt and son-in-Law Johann Wm. Vogelsburg, signed her death certificate.

He and Anna Catherina were members of the Catholic church.

Anton Rutt was a coal Miner, as it appears that most men of this area were.

Anton and Anna Catherine Rutt were the parents of eight children: Elizabeth, Hubertus, Anna Catherina, Maria Anna, Jean(Johann), Johann, Werner.

Anton passed away on Feb. 24,1820 at Vussem, Germany, in the district of Aachen. He died at 7:00 in the evening, and he was 51 years old at the time of his death. His youngest son (Jean) Johann Rutt, was only 10 years old at the time.

Children of Anton and Anna Catherine(Niessen) Rutt: (* the information was taken from birth, Christening, death and marriage records, from Germany. Some of the birth dates listed are birth dates and some are Christening dates, which could be a little off from the date of the actual birth.)

1. Anna Catherina Rutt was born on July 24, 1802 at Vussem, Schlesden, Rhineland Prussia. She was married twice. #1 to Johann Esihweiler on Feb. 26, 1829. He passed away in Feb. of 1833 and she remarried. #2 to Heinrich Vogelburg on May 3, 1834. They were the parents of four children: Werner Vogelsburg, Maria Elizabeth Vogelsburg, Johann William Vogelsburg who died on Jan. 16, 1842, Wilhelm Vogelsburg.

2. Maria Anna Rutt was born on Oct. 25, 1804 at Vussem in Rhineland Prussia. She was married on May 3, 1834 at Vussem, to Johann William Vogelsburg of Vussem. Johann was born in 1812. They were the parents of a son Anton who died young.

3. Werner Rutt was born in 1806 Rhineland, Prussia. He was married on Oct. 20, 1828 to Christine Ann Sistig. Christine was the daughter of Henick and Catherine (Hass) Sistig. Werner and Christine Rutt were the parents of five children: Maria Catherine b/Aug. 21, 1829 and died in May of 1837 at age 8, Johann b/April 2, 1831, Elizabeth b/April 3, 1834, Heinrich b/Sept. 5, 1835 and died in May of 1837 at age 2., Anna Catherine b/Aug. 10, 1837.

4. Matieu Rutt was born on Aug. 4, 1807 at Vussem in Rhineland Prussia. He was a Wittness at his brother Johann Rutt's wedding, in 1835 and his mothers in 1844.

5. Jean (Johann) Rutt was born on Jan. 5, 1810, at Vussem in Rhineland, Prussia. He was a coal miner. He was married on Sept. 15, 1835 at Vussem, to Maria Anna Catherine Steffens. They were the parents of eleven children: Maria Anna b/1837, Margaretha b/1839, Mathias b/1841, Wilhelm b/1843, Peter Joseph b/1846, Johann b/1849, Werner b/1850, twins-Werner Joseph and Johann b/1853, Anna Maria b/1854, Johann b/1856, Johann died in an accident in the coal mines in 1860. (For more information see John and Mary Anna (Steffens) Rutt History.)

JOHANN AND MARIA ANNA (STEFFENS) RUTT

Johann Rutt(Jean) was born on Jan. 5,1810 in the district of Aachen, at Vussem County in Rhineland, Prussia. He was the son of Anton Rutt and Anna Catherina(Niessen) Rutt. John was one of five children. His father was a coal miner. They were listed as "Katolisch" which is Catholic.

At an early age John took up the occupation of coal miner, which was the major means of employment for men in that region.

When John Rutt was 25 years old he was married Mary Anna Catherina Steffens. They were married at 5:00 p.m., on Sept. 15,1835 in a civil ceremony at the courthouse in the county of Vussem by the Burgemeister Franz Schmitz. The necessary Banns had taken place. Both the bridegroom and the bride were questioned seperately if they wished to be married and both answered the question in the affirmative, and were joined in marriage on that day.

Mary Anna Catherina Steffens was born on March 17,1815 at Mechernich, at Vussem in Rhineland Prussia. She was the daughter of Hubert Steffens and Anna Catherine(Henselers)Steffens. She was one of five children that we know of. Her father Hubert Steffens was also a coal Miner.

Johann and Mary Anna Rutt settled in Vussem near their families. John continued as a coal miner. Their first child, Maria Catherina Rutt was born on June 20, 1837 at Vussem, Rhineland Germany, followed by another daughter Margaretha Rutt on April 17,1839 in Vussem.

On April 16, 1841 for an unknown reason little Maria Catherine who was only four years old, died at home in Vussem.

On Dec. 1,1841 their first son, Mathias Rutt, was born at Vussem, in Aachen, Rhineland Prussia.(Our ancestor). Another child, Wilhelm Rutt, was born on Nov.11, 1843 at Vussem, followed by Peter Joseph Rutt who was born on Aug. 16,1846.

Tragedy struck when another daughter, Margaretha died(reason unknown) on Jan. 20, 1848 at Vussem at age eight.

Another son Johann Rutt was born on Jan. 24,1849 but he died young. Werner Rutt was born on Aug. 15,1850 at Vussem.

John and maria were blessed with the birth of twins on Jan. 6,1853. Johann and Werner Joseph Rutt. The twins were not well at birth, and Werner Joseph passed away on Feb. 23,1853 when only 17 days old and Johann passed away on March 19,1853. at 2 monthes and 13 days old.

A daughter, Anna Maria Rutt was born on May 26, 1854 at Vussem in Rhineland. Another son, born on Nov. 28,1856 was named Johann.

Their son, Werner Rutt, died on May 10,1860(reason unknown) at the age of 9 years and 9 months old at Vussem.

While the family were still in mourning over the death of their son Werner, another tragidy struck. On September 20,1860, Johann had went to work in the coal mines as usual. Around ten O'Clock there was an accident, the details of which are unknown. Johann Rutt was killed, leaving a widow and children, the youngest being only four years old.

Mathias, being the oldest boy, fell to the duty of helping to support the family. There also near this time was a war being waged. Germany and France were once again, fighting over the region known as alsace Loraine and the Rhineland areas. Mathias became a soldier in this war, (It is unknown weather he enlisted or was drafted, but the latter is assumed.)

Mathias fought in three battles in this war, and was wounded twice. One, where a musket ball had taken a small chunk out of his shoulder, and it had healed that way. He still had the obvious diformity as an old man. He later retold the stories to his grandchildren, and showed them his scar.

With each battle there was also the fear felt by his mother Mary Anna, that this time he might not come home. After three battles, she told him, "Go to America, Get away from the war, You fought enough in this war!" Mathias agreed to go, but tried to convince Mary Anna to come also, but she felt that she could not as she had to many young children at home yet.

And so she watched as her oldest son left for the far off land of America. He left on a ship called the Hammonia, in May of 1869, with the promise to write when he reached America.

They wrote letters back and forth, Matthias had settled in a town Called Cincinnati, in Ohio.

Mary Ann kept writing to Mathias, and when she was very old, one of her sons who stayed at home, wrote them for her. It is unsure of the exact date oof her death, but a guess would be sometime in the 1880's. No other information is known. All touch with the family has been lost thus far.

BIRTH RECORD OF MATTHIAS RÜTT

Geburts- und Urkunde

Vussem Kreis *Schlesden*
Im Jahre tausend achthundert ein und vierzig, den ersten
des Monats *December*
Um *mittags* Uhr, erschien vor mir *Franz Schmitz*

Regierungsbezirk *Aachen*

Bürgermeister von *Vussem* als Beamten des Per-
sonenstandes, *Johann Friedrich Schmidt*
Schmitt Jahre alt, Standes
Leinweber, wohnhaft zu *Vussem*
welcher mir ein Kind männlichen Geschlechts vorzeigte und mir er-
klärte, daß dies Kind den *ersten* Tag
des Monats *December* Jahres tausend achthundert ein und
vierzig *Morgens* Uhr geboren ist, von *sein*

BIRTH CERTIFICATE (German)

Municipality: *Vussem*
District: *Schlesden*
Admin. district: *Aachen*

In the year 1841, on the first day of the month of December, at 11:00 A.M., there appeared before me (Franz Schmitz, Mayor of Vussem, in my capacity as officer of statistics) one Johann Rutt, thirty one years old Occupation Miner. Residing in Vussem; who presented a male child to me and declared that the child was born on the first day of December, 1841, at 5:00 a.m., of Johann Rutt himself and Mary Anna Steffens, his wife, occupation miner resideing in Vussem in ---- street, and declared further that the child was to be given the first name Matthias. This presentation, and declaration have taken place in the presence of Johann Wilhelm Vogelsberg, 29 years old, occupation ?, residing in Vussem. And of Martin Joseph Hack, 35 years old, occupation --?, residing in Holzheim. After a complete reading of this certificate I have signed the same with the father and these eyewitnesses.

Johann Friedrich Schmidt und von
Maria Anna Steffens
seiner Ehefrau, Standes *Leinweber* wohnhaft zu
Vussem in der ----- Straße, und erklärte
ferner diesem Kinde den Vornamen *Matthias*
zu geben.

Diese Vorzeigung und Erklärung haben Statt gehabt in Beisein des
Johann Wilhelm Vogelsberg
29 Jahre alt, Standes *Leinweber* wohnhaft zu
Vussem und des *Martin Joseph Hack*
35 Jahre alt, Standes
Leinweber wohnhaft zu *Holzheim*

Nach geschehener Vorlesung dieser Urkunde habe ich dieselbe mit *dem*
Nachher unterschrieben.
Johann Rutt
Martin Joseph Hack
Johann Wilhelm Vogelsberg

Heiraths-Urkunde.

Wegscheider, Kreis, Walden, Regierungsbezirk Nachen.

Am Tage, Sonntag, den zweiten September 1857, und dreißig, den zweyten Oktober 1857, erschien vor mir Therese Wegscheider Bürgermeister von Walden als Beamteter des Personenstandes, in dem Gemeindefaule daselbst.

Erstereits die Jungfrau Johann Rath geboren zu Walden am zweiten September 1857 zwey und dreißig Jahre alt, Standes Lehrerin wohnhaft zu Walden Regierungsbezirk Nachen Ständes Lehrerin wohnhaft zu Walden und dessen Ehefrau Catharina Rath Ständes Lehrerin wohnhaft zu Walden (sind einmüthig ein)

andererseits die Jungfrau Anna Catharina Steffens geboren zu Walden am zweiten September 1857 zwey und dreißig Jahre alt, Standes Lehrerin wohnhaft zu Walden Regierungsbezirk Nachen Ständes Lehrerin wohnhaft zu Walden und dessen Ehefrau Anna Catharina Steffens Ständes Lehrerin wohnhaft zu Walden (sind einmüthig ein)

und forderten mich auf, die zwischen ihnen verabredete Heirath gesetzlich abzuschließen. In Erwägung, daß die erforderlichen beiden öffentlichen Ankündigungen dieser Heirath vor dem Gemeindefaule des Gemeindefaules zu Walden statt gehabt haben, nämlich die erste am zweiten September 1857 und die andere am zweiten Oktober 1857 (sind einmüthig ein)

legt hin, daß ferner die Urkunden über die Ankündigung dieses Ehevertrages vorschristsmäßig öffentlich angeheftet gewesen sind und mir kein Zweifel gegen diese Verheirathung eingereicht worden ist. In der heidmüthigen Einsicht des Abzuges von den Requirirenten zur Nachweise ihres Alters und ihres gesetzlichen Befugniß zur Eingehung dieser Heirath beigebrachten Urkunden, nämlich:

1. Das Heirathsbuch des Gemeindefaules zu Walden vom zweiten September 1857 Seite 12 und 13 unter dem Datum zweiten September 1857 unter dem Namen Johann Rath und Anna Catharina Steffens eingetragen ist.

2. Das Heirathsbuch des Gemeindefaules zu Walden vom zweiten Oktober 1857 Seite 12 und 13 unter dem Datum zweiten Oktober 1857 unter dem Namen Johann Rath und Anna Catharina Steffens eingetragen ist.

3. Das Heirathsbuch des Gemeindefaules zu Walden vom zweiten September 1857 Seite 12 und 13 unter dem Datum zweiten September 1857 unter dem Namen Johann Rath und Anna Catharina Steffens eingetragen ist.

4. Das Heirathsbuch des Gemeindefaules zu Walden vom zweiten Oktober 1857 Seite 12 und 13 unter dem Datum zweiten Oktober 1857 unter dem Namen Johann Rath und Anna Catharina Steffens eingetragen ist.

5. Das Heirathsbuch des Gemeindefaules zu Walden vom zweiten September 1857 Seite 12 und 13 unter dem Datum zweiten September 1857 unter dem Namen Johann Rath und Anna Catharina Steffens eingetragen ist.

STEFFENS

JOSEPH STEFFENS B/ before 1756 FRANCE
 married/ before 1776
 ANNA MARGARETHA SCHMITZ B/ before 1757

child:

- | | | | |
|---|----|----|----|
| 1. <u>Hubert Steffens</u>
b/ 1776 Mechernich
d/April 5, 1835 Vussem,
Huheruss
married/around 1801
Germany,
<u>Anna Caterine Henselers</u>
b/
d/ | 2. | 3. | 4. |
|---|----|----|----|

children of Hubert and Anna C.

1. Elizabeth
2. Margariette
3. Antoine
4. Pier (Peter)
5. Anna Mary Catherine

- | | | | | |
|--|--|--|--|--|
| 1. Elizabeth
b/April 6, 1802
Vussem, Rhineland
Germany (Aachen)
m/ | 2. Margarette
b/Nov. 24, 1804
Vussem, Rhineland
Germany, (Aachen)
m/ | 3. Antoine
b/Jan. 26, 1809
Vussem, Rhineland
Germany (Aachen)
was a witness
at his fathers
death in 1835 | 4. Pier (Peter)
b/Oct. 6, 1811
Vussem,
Rhineland
d/Ju 24, 1821
Vussem | 5. Mary Anne Catherine
b/March 17, 1815 Vussem
d/ after 1875 Ger.
m/Sept. 15, 1835
Johann Rutt
child:
Mary Catherine Rutt
Margaretta Rutt
Mathias Rutt
Wilhelm Rutt
Peter Joseph Rutt
Johann Rutt
Werner Rutt
Johann Rutt
Werner Joseph Rutt
Anna Maria Rutt
Johann Rutt |
|--|--|--|--|--|

Children of Mary Anna and Johann Rutt:

- | | | | | | | | | | | |
|---|---|---|-------------------------------------|--|---|------------------------------------|--|---|--|-------------------------------------|
| 1. Mary Catherine
b/June 20, 1837
m/
died
young | 2. Margaretha
b/April 17, 1839
m/ | 3. Mathias
b/Dec. 1, 1841
m/1872
Ohio
Philom.
Thole
child:
1. Chas.
2. Mary
m/
Frank
Hessler | 4. Wilhelm
b/Nov. 11, 1843
m/ | 5. Peter Jos.
b/Aug. 16, 1846
m/ | 6. Johann
b/Jan. 24, 1849
m/
died
young | 7. Werner
b/Aug. 15, 1850
m/ | 8. Johann
Jan. 6, 1853
m/
died
young | 9. Werner
Joseph
Jan. 8, 1853
m/ | 10. Anna Maria
b/May 26, 1854
m/ | 11. Johann
b/Nov. 28, 1856
m/ |
|---|---|---|-------------------------------------|--|---|------------------------------------|--|---|--|-------------------------------------|

CHILDREN OF FRANK AND MARY (RUTT) HESSLER (Grandchildren of Mathias RUTT)

- | | | | | | | | | | | | | | | |
|--|--|---|--|---|--|--|---|--|--|---------------------------|--------------------------|-------------------------|---------------------------|---------------------------------|
| 1. Philomena
b/1894
m/
Herman
Veerkamp
child:
Gathy
Rita
Herman
Norbert
Stan
Mary
Cyril
Ralph
Mary P.
Marg.
Tony
Barb | 2. Francis
b/1900
m/
Theresa
Hardebeck
child:
Margie
Bertha | 3. Mary C.
b/1901
m/
Harry
Dwenger
child:
Kathy
Esther
Rosie
Ruth
Annie
Dick
Betty
Leonard
Mary E.
Ed. Joe | 4. Matilda
b/1903
m/
Clem
Struhenburg
child:
Mary Agnes
Bernard
Dorothy
Vincent
Maurice
Mary E.
Beth
Mary | 5. Cecilia
b/1905
m/
Bernard
Harpring a
child:
Joan
Edgar
Irma
Lois
Luella
Elvera
Bernard
Vernon | 6. Rose
b/1907
m/
George
Naderman
child:
Justin
Rose M.
Jane
Edna Ann
Albert
John
Esther | 7. Clara
b/1908
m/
George
Wenning
child:
Bernice
Clem
Koors
Cord
Francis
Deloris
Carolyn | 8. Joseph
b/1909
m/
Bernice
Wenning
child:
James
Sylvester
Don
Louis | 9. Gertrude
b/1910
m/
Clem
Alvin
died
died | 10. Chris
b/1911
m/
Alvin
died
died | 11. Hilda
b/1913
m/ | 12. Law.
b/1914
m/ | 13. Al.
b/1914
m/ | 14. Helen
b/1915
m/ | 15. Marg.
A.
b/1916
m/ |
|--|--|---|--|---|--|--|---|--|--|---------------------------|--------------------------|-------------------------|---------------------------|---------------------------------|

HUBERT AND ANNA CATERINA (HENSELERS) STEFFENS

Hubert Steffens was born around 1776 in the Rhineland, and was a native of Germany. (Supposedly of French ancestry). He was born the son of Joseph Steffens of French decent and Anna Margaret Schmitz. His mother passed away on Sept. 14, 1832. I have no definite brothers and sisters at this time.

Hubert Steffens was married to Anna Catherine Henselers around 1801 in Rhineland Germany.

Hubert was a coal miner by occupation. (This area seems to be a coal mining dominated area, most men were miners)

Hubert and Catherine Steffens lived in the region on Aachen (on the very edge of Aachen), in the district of Schlesden, in Vussem Co. Rhineland, Prussia. They resided for a time in the town of Mechernich.

Hubert Steffens passed away on April 5, 1835, at Hüherüss, in the region of Aachen, district of Schlesden, (Rhineland). He passed away at the age of fifty-nine years old. His son Anton had signed the death certificate that he was a witness at the time of death.

Hubert and Anna Catherine Steffens had five children that we know of.

1. Elizabeth Steffens who was born on April 6, 1802 at Vussem in Rhineland, Prussia.

2. Margarete Steffens who was born on Nov. 24, 1804 civil, Vussem, Rhineland, Prussia.

3. Antoine Steffens was born on Jan. 26, 1809 at Vussem, Rhineland, Prussia.

4. Pier (Peter) Joseph Steffens was born on Oct. 6, 1811 at Vussem Co. in Rhineland, Prussia. Pier passed away on June 21, 1821. (He should have only been ten years old, but he was listed as a coal miner on his death certificate.)

5. Mary Anna Catherine Steffens was born on March 17, 1815 at Hohnich, civil Vussem, Rhineland, Prussia. She married Johann Rutt in 1835 and was the mother of our Matthias Rütt. (see Rütt)

April 5, 1836 Death record For Hubert STEFFENS
(Father of Mary Anna (STEFFENS) RUTH)
N^o 23. **S t e r b e u r k u n d e**

Gemeinde Vußern Kreis Schleiden Regiers

Im Jahre tausend achthundert neun und dreißig, den neun
des Monats April

Am mittags zwey Uhr, erschienen vor mir Anton
Schmitz

Bürgermeister von Vußern als Beamten des Pers
sonenstandes, der Anton Steffens neun und

zwey Jahre alt, Standes Leinwand
wohnhaft zu Glehnich, Anton

des Verstorbenen, und der Elisabeth Osterwey neun
und sechzig Jahre alt,

Standes Leinwand wohnhaft zu Glehnich, Anton
Steffens des Verstorbenen und haben diese beide

mir erklärt, daß am sechzig ten
des Monats April des Jahres tausend achthundert

neun und dreißig, um mittags zwey Uhr, verstorben ist, dem
Hubert Steffens gebürtig zu

Glehnich, Anton und sechzig Jahre alt, Standes
Leinwand, wohnhaft zu Glehnich. Regierugsbezirk

Aachen, Anton von Joseph Steffens,
Leinwand und von Anna Margaretha

Schmitz, Elisabeth und sechzig
und Bartharina Henseler, Leinwand zu

Glehnich
Nach gescheneer Vorlesung dieser Urkunde habe ich dieselbe zugleich
mit den Anton Leinwand

Anton Schmitz unterschrieben.

Joseph Schmitz und Anton Leinwand

Regierungsbezirk Aachen
Heilig, den neun
April
Anton
als Beamten des Pers
sonenstandes
Anton
Steffens
neun
und
sechzig
Jahre alt,
Anton
und haben diese beide
Anton
des. tausend achthundert
verstorben ist, dem
gebürtig zu
Jahre alt, Standes
Regierungsbezirk
Aachen, Anton
Schmitz
ich. dieselbe zugleich
Anton
unterschrieben.
unterschrieben zu
Anton

207
JAMES 41,41
AARON JOSEPH ABELL 139
BECKY ABELL 139
DANNY WAYNE ABELL 139
GARY WAYNE ABELL 139
JESSE WAYNE ABELL 139
MATTHEW DAVID ABELL 139
NICHOLAS WAYNE ABELL 139
AARON ABLE 140
BECKY ABLE 140
DANNY ABLE 140
JESSIE ABLE 140
MATT ABLE 140
NICHOLAS ABLE 140
STEPHANY ABLE 140
DANNY ARLESOPD 140
PAUL ADAMS 115
DAVID ADDISON 44
HILLARY ADDISON 44
KAREN ADDISON 44
VIRGINIA ADKINS 117
MARGARET ALBERTSON 71,21,22
JACK ALBRICK 87
SANDRA ALBRINCH 87
EDWARD ALFRING 33,33
JOSHUA ALFRING 33
LISA ALFRING 33
PATTY ALFRING 33
PAULA ALFRING 33
JANE ALGOE 267
RUTH (LIME) ALLARDYCE 195,195
BONNIE ALLEN 8,196
BRIAN ALLEN 8,196
CLARENCE ALLEN 7,8,24,36,196
DEBORAH ALLEN 55
EDNA ALLEN 8
HOLLY ALLEN 196
HOLLY LYNN ALLEN 8
JAMES ALLEN 17
JEFFERY ALLEN 55
KATHLEEN ALLEN 8,196
KENNETH ALLEN 8,196
MABEL ALLEN 8,36,193,196
MABLE ALLEN 7
MICHELLE ALLEN 55
RALPH ALLEN 55
REBECCA ALLEN 8,196
RUDNEY ALLEN 7,8,24,36,196
SAM ALLEN 7,8,24,36,196
SAMUEL ALLEN 196
SCOTT ALLEN 196
SCOTT DEAN ALLEN 8
THELMA ALLEN 7,8,24,36,196
DIANE ALLGEIER 39
KEITH ALLGEIER 39
RICK ALLGEIER 39
SHANNON ALLGEIER 39
DAVID ALSBAUGH 68
SHARON ALSBAUGH 68,68
TONI ALSBAUGH 68
JUDY ALSOP 332
LOIS ALTEPETER 21
RONALD ALTON 55
KATHY ALWERTSON 248
BRANDON AMMERMAN 87
JULIE AMMERMAN 87
RYAN AMMERMAN 87
STEVEN AMRHINE 18
PHILIP ANTHOY 247
RANDY ARDEN 30,30
ANNA ARKINS 27
JAMES ARKINS 27
ROBERT H.D. ARROL 2
MARY CORNELIA ASHER 111
FEROL AULT 332
BETTY BAAS 268
FLOYD BAAS 268
KELLY BAAS 268
MARY BAAS 268
KARL BACHHOLZ 82
DONNA BACK 169

BLANCA BAKER 17
CAROLYN BAKER 294
CHARLES BAKER 75,294,294
CLARENCE BAKER 326
DONNA BAKER 75
JOE BAKER 18
JOSEPHINE BAKER 326
LORI BAKER 75
ROBERT BAKER 326
ANDREW BALDWIN 67
GWENDOLYN BALDWIN 67
HELEN BALDWIN 67
MOLLY BALDWIN 67
RANDALL BALDWIN 67
ROBERT BALDWIN 67
THOMAS BALDWIN 67
TARA BALTZER 311,312
CATHERINE BARBER 284
GARY BARKER 204
JEANETTE BARKER 204
CATHERINE BARKSHOLT 160
BILL BARNHORST 2
FRANK BARNHORST 176
JOSEPHINE BARNHORST 176
JAMES BATES 177
JEANNE BATES 177
DANIEL PAUL BATTI 247
DAVID HOWARD BATTI 247
GEORGE RICHARD BATTI 247
KAREN DOROTHY BATTI 247
MARY JANE BATTI 247
NICHOLAS CARL BATTI 247
RICHARD BATTI 247
ROGER JOSEPH BATTI 247
ANN MARIE BAUER 287
ANTHONY BAUER 287
EDWARD BAUER 287
JOHN EDWARD BAUER 287
ROSE MARIE BAUER 287
MIKE BAUMAN 193
ELSIE BAYLES 17
ELSIE BAYLIS 17
EDITH BEACON 41
BILL BEAGLE 197
DARLENE BEAGLE 197
FRANK BEAGLE 192,197
JOHN BEAGLE 192,197
KAREN BEAGLE 197
MARY BEAGLE 188,197
MARY (SEIBEL) BEAGLE 180
ULLIE BEAGLE 197
PEGGY BEAGLE 197
PHYLLIS BEAGLE 177,197
CHRISM BEARD 153
JEFF BEARD 153
SHIRLEY (HASH) BEARD 153
STIEVE BEARD 153
WILLIAM BEASLY 39
BEN BECKER 157
BENJAMIN BECKER 156
JAY BECKER 156
JEANIE BECKER 106,106
SHIRLEY BECKER 157,156
ZACHERY BECKER 157,156
MARCIA BECKETT 298
CATHERINE BECKSCHULTE 174
KATHERINE BECKSCHULTE 163
JANE KATRYN BECRAFT 107
ROXANNE BECRAFT 107
WILLARD BECRAFT 107
BEDAL 13
ALEXANDER BEDAL 340
AMBROSE BEDAL 340
CATHERINE BEDAL 340
CLARA BEDAL 39,166
DENNIS BEDAL 340
EMUND BEDAL 49
JANET BEDAL 340
JEREMY BEDAL 340
JESSICA BEDAL 340
JOAN BEDAL 39
JOHN BEDAL 340
JOHN ADAM BEDAL 224,224
KENNETH BEDAL 39

LESA BEDAL 340
MARILYN BEDAL 340
MARK BEDAL 340
MARYANN BEDAL 47,49
NICHOLAS BEDAL 340
NORBERT KENNETH BEDAL 169
PAUL BEDAL 340
STACIE BEDAL 340
THERESA BEDAL 340
THOMAS BEDAL 169
TINA BEDAL 340
VIRGINIA BEDAL 49
CLARA BEDEL 166
ANNE BEITZ 317
DOROTHY BENGE 227
TILLIE BENSON 176
DAVIS BENZ 44
DEBRA BENZ 44
JANET BENZ 44
LINDA BENZ 44
LOE BENZ 44
MARY BENZ 44
STEPHAN BENZ 44
JEANNE BENZ/FRASE 44
MARGUERITE BERENS 291
ANNA BERKEMEIER 166
BERNARD BERKEMEIER 167
EILEEN BERKEMEIER 167
ELOISE BERKEMEIER 167
FRANCIS BERKEMEIER 167
JOSEPH BERKEMEIER 167
DANIEL BERNARD 78
CHRISTY BICKWELL 150
DORIS BIDDLE 44
HENRY BIDDLE 44,44
HOWARD BIDDLE 44
PENNY JEAN BIDDLE 146
HOLLIE BILL 80
KERI BILL 80
MATTHEW BILL 80
TIM BILL 80
KAREN BINGHAM 55,55,55
EVA BARBRA BISHOP 200
ROSE BISHOP 45,45
MAGDELINA BITTNER 188
PETER BITTNER 179,188
ELLEN BLACKBURN 306
RICHARD BLACKBURN 306
MARY BLANKER 18
ROGER BLANKER 18
CAROL BLANKMAN 171
ELIZABETH BLANKMAN 287
FRED BLANKMAN 171
JOE BLANKMAN 287
JOHN BLANKMAN 171
LINDA BLANKMAN 171
MARTHA BLANKMAN 32,171
PAUL BLANKMAN 300
SUSAN BLANKMAN 171
LILLIE BLANTON 73
BARBRA BLARE 198
GEORGE BLARE 198
SUSAN BLARE 198
JANET BLEDSOE 123
GINA BLINE 333
HEIDI BLINE 333
TRINE BLINE 333
RACHEL BLUM 46
HARRY BOELOCK 227
MARY CAROLINE BOELOCK 227
VIOLA BOELOCK 227
CHARLES BOESCHE 193
WALTER BOESCHE 193
DICK BOHMAN 18
JO ANN BOHMAN 18
DONALD BOHN 8,30
JOHN BOLTZ 231
EMANUEL BOMBEN 18
RECHARD WES BORGERS 79
RICHARD WALTER BORGERS 79
RAYMOND MONSIGNOR BOSLER 315
EVA BOSTIC 198
HARRY BOSTIC 198
MAE (BURTON) BOSTIC 198

RUTHIE BOSTIC 190
 ROLAND BOSTIC 198
 RUSSEL BOSTIC 198
 RUTH BOSTIC 198
 ANNA BOUCHER 331
 BESSIE BOWMAN 42
 W.H. BRACKEN 182
 EDNA BRADBURY 8,196
 ANGIE BRADLY 46
 JUNE BRANCAMP 340
 BERNARD BRANDEWIEDE 202
 LUCILLE BRAUN 2,245
 PATRICIA BRAUN 245,154
 THOMAS BRAUN 245
 VIRGINIA BRAUN 245
 JOSEF (FATHER) BRETZ 209
 ELIZABETH BRICKNER 184
 FRANK BRICKNER 13
 CHRISTIAN BRINKMAN 18
 LUCILLE BRINKMAN 18
 MARY BRINKMAN 201
 PATTY BRINKMAN 317
 WILLIAM BRINKMAN 18
 KATE BROCKMAN 165
 ROSE BROCKMAN 38
 DANIEL BROGAN 117
 DAVID BROGAN 117
 JENNIFER BROGAN 117
 JOHN BROGAN 117
 MARY ROSE BROGAN 117
 SHIPLEY BROGAN 117
 JOHANN BROST 20
 LEONA BROST 20
 CAMERON BROWN 287
 EVA BROWN 297
 THERESA BROWN 287
 CLARA BRUNER 292
 DONALD BRUNER 292
 VIRGINIA BRUNER 292
 ALTA MAE ((FEETZ)) BRUNNER 122
 ALMA BRUNS 203
 BERNADETTE BRUNS 203
 CANDICE BRUNS 65
 CARRIE BRUNS 54
 CHRISTOPHER BRUNS 54
 CINDY BRUNS 65
 DONNA BRUNS 332
 EDNA BRUNS 60,64,65
 EDWARD BRUNS 65
 ELMER BRUNS 54
 ESTHER BRUNS 203,339
 GREGG BRUNS 65
 JEROME BRUNS 54
 KIRT BRUNS 65
 LEAH BRUNS 65
 LOUISE BRUNS 54
 MARY BRUNS 290,293
 NANCY BRUNS 54
 ROBERT BRUNS 65
 SHIRLEY BRUNS 65
 STEPHANIE BRUNS 65
 STEVE BRUNS 65
 VIRGINIA BRUNS 54
 WILLIAM BRUNS 203
 BETTY BRYANT 21
 BRIAN BSWAYZEE 55
 CORY BUCHHOLZ 82,82
 STEPHANIE BUCHHOLZ 82
 TOM BUCKLY 177
 ETHEL BUENING 312
 JOANNE BUENING 311
 KAREN BUENING 54
 MARK BUENING 54
 STEPHEN BUENING 54
 TRINA BUENING 54
 FANNY AGNES BUETTNER 228
 WILLIAM BUETTNER 228
 RICHARD BULLARD 169
 VELMA BULTMAN 326,327,327
 AGNES BUNNEMEYER 168
 CLEMENS BUNNEMEYER 168
 MARY BUNNEMEYER 163,166,168
 MICHELL BURCHETTON 117
 MONICA BURDICK 326,327

LILUE BURGAN 331
 ARLENE BURGMIEER 154
 DANIEL BURGMIEER 154
 DAFLENE BURGMIEER 154
 DONALD BURGMIEER 154
 EDWIN J. BURGMIEER 154
 JANET BURGMIEER 8,278
 JANET (GUS) BURGMIEER 102,102,154
 JANET (GUSSY) BURGMIEER 90
 NORA M. BURGMIEER 154
 ALYSSA BURKE 289
 JULIE ANN BURKE 289
 MARK BURKE 289
 ALMA BURKHART 308,308
 ANNETTE BURKHART 311,312
 CARL BURKHART 311
 CARL JOSEPH BURKHART 311
 CHARLES BURKHART 308,311,311
 CHARLES EDWARD BURKHART 311,312
 DARRIN BURKHART 311,312
 DAVID BURKHART 310
 DEANNA BURKHART 311,312
 ELIZABETH BURKHART 311
 ETHAL BURKHART 311,312
 JARED BURKHART 311,312
 JOANNE BURKHART 311,312
 JOHANNA BURKHART 310,311
 JOSEPH BURKHART 311
 KAREN BURKHART 311,312
 KATHY BURKHART 311,312
 LEONA BURKHART 310
 LUELLA BURKHART 311
 MAMIE BURKHART 311,312
 MARGARET BURKHART 308
 MARTHA BURKHART 311,312
 MICHAEL BURKHART 311,312
 NICK BURKHART 310
 PATRICIA BURKHART 312
 PATRICIA BURKHART 311
 PAUL BURKHART 310
 REGINA BURKHART 311,312
 ROSEMARY BURKHART 311
 RYAN BURKHART 311,312,315
 SARAH BURKHART 311,312
 THERESA BURKHART 308,310,311
 THOMAS BURKHART 311,311,312
 WILLIAM BURKHART 311,311,312
 BRINDA BUSH 298
 BETTY BUSSBURG 318
 DEULAH BUTCHER 331
 ELMER BUTCHER 331
 GEORGIA BUTCHER 331
 THERESA BUTLER 30
 MAGDELINA BUTNER 229,231
 AGNES BUTZ 292
 MAE BUTZ 296
 ELLA BYRUM 32
 EDNA CAFFEE 318
 MARGARET CAHILL 7,8,27,28
 CHRISTY CAMPBELL 150
 CLARA CAMPBELL 292
 CONSTANCE CAMPBELL 203
 ELDON CAMPBELL 17
 EDNA ANN CARDINAL 287
 JAMES CARDINAL 287
 SCOTT CARDINAL 287
 THERESA CARDINAL 287
 JEREMY CARROL 45
 JOHN CARROL 45
 JOSEPH CARROL 45,45
 RITA MAE CARROL 45
 STEVEN CARROL 45
 BARBRA CARROLE 329
 R.W. CARROLE 329
 HENRIETTA CARROLL 177
 RAE CARROLL 177
 CHRISTINA CARSON 143
 CLARENCE CARSON 142
 CRAIG CARSON 143,143
 DEBRA CARSON 142
 DIANE CARSON 142
 ELIZABETH CARSON 143
 HELEN CARSON 143
 HELEN (HALEY) CARSON 142

JODI CARSON 143
 MARK CARSON 2,140,141,142,143
 PATTY CARSON 1,2,2,134
 PATTY (MCCULLOUGH) CARSON 141
 PATTY (MCCULLOUGH) CARSON 143
 PATTY A (MCCULLOUGH) CARSON 2,2,1,
 1,100,100
 PATTY A. (MCCULLOUGH) CARSON 1,1,1
 REBECCA CARSON 143
 WALTER CARTEE 176
 HUBERT CAUDILL 46
 JANICE CAUDILL 46
 PHYLLIS CAUDILL 46
 DEBBIE CHANDLER 248
 MARGARET CHANEY 284
 JASON CHASTAIN 70
 MARK CHASTAIN 70
 MATTIE CHASTAIN 70
 ORAN CHASTAIN 70
 SANDRA CHASTAIN 70
 SHANNON CHASTAIN 70
 SANDRA CHASTINE 70
 JOYCE CHEEK 332
 MARITA CHERRY 177
 ROBERT CHERRY 177
 CHARLENE CLARK 332
 DAVID CLARK 198
 DEREK CLARK 198
 MANDY CLARK 198
 MARK CLARK 332
 MARTHA CLARK 176
 MATTHEW CLARK 332
 OLLIE CLARK 197
 SARAH CLARK 332
 VICKY CLARK 198
 REBECCA LYNN CLAXTON 151
 ELIZABETH CLEMENTZ 227
 MARY ELIZABETH CLINE 21
 MICHELLE CLINE 21
 RENEE CLINE 21
 TILFORD CLINE 21
 TODD CLINE 21
 DUSTIN COBLENTZ 117
 STEVE COBLENTZ 117
 CHARLENE COBURN 332
 CHARLES COBURN 332
 SUSANNAH COBURN 332
 JOHN MICHAEL COHEN 244
 ROSE COLEMAN 165
 ANN COLLINS 153
 EMERSON COLLINS 153
 KELLI ANN COLLINS 153
 BARBRA COLSON 49,50
 JERYD COLSON 73
 JOSHUA COLSON 73
 JUDY COLSON 73,74
 LINDA COLSON 50
 RAY COLSON 50
 SUE COLSON 73
 TODD COLSON 73
 TRAY COLSON 73
 VIRGINIA COLSON 73
 CHRIS COMBS 153
 DAWN COMBS 153
 RONNIE COMBS 153
 SHARDN COMBS 153,153
 DUANE COMER 284
 JOYCE COMER 284
 ROSE COMER 272
 DENNIS CONK 284
 GARY CONK 284
 MARY CONK 284
 JOLEEN CONNER 2,177
 ARLENE COOK 154
 HILDA COOK 326
 JACOB COOK 326
 DEBORAH COOMES 111,115,115
 DONNA (TONEY) COOMES 111
 KAREN COOMES 298
 KAREN (RUNYAN) COOMES 111
 MALCOLME L. COOMES 111
 MARY CORNELIA COOMES 111
 SANDY (WEBB) COOMES 111
 WILLIAM COOMES 111,111

ANNA COFFMAN 231
HENRY COFFMAN 231
ALVIN COFD 203, 205, 204
ANNA COFD 294
CAROLYN COFD 294
CHRIS COFD 110
CHRISTINE COFD 265, 203, 294
DELOPAS COFD 294
FRANCIS COFD 294
FRANK COFD 294
PAMELA COFD 73
ADELL COPPA 177
JOHN COPPA 177
MARTHA COX 103
AGNET COYLE 328
ANNA MARY COYLE 328
ARTHUR COYLE 328
BARBARA COYLE 329
BRUCE COYLE 329
GEORGE COYLE 328
JACK COYLE 329
JAMES COYLE 328
JOHN A. COYLE 329
JOHN A. COYLE 328
JOSEPH COYLE 328
LEO F. COYLE 329
LIDA COYLE 329
LUCILLE COYLE 328
RAYMOND COYLE 328
ROSE CECILIA COYLE 328
SUSAN COYLE 329
ELLA MAE CRAMER 166, 171
WALTER CRAMER 167
JEAN CRAWFORD 84
JEFFERY LANE CRAWFORD 84
JERRY CRAWFORD 84
JILL CRAWFORD 84
JOSHUA SCOTT CRAWFORD 84
CHARLES S. CROGHAM 75
JOANTHAN WAYNE CRONE 341
CHRISTINA CRONIN 73
DON CRONIN 73
JUDITH CRONIN 73
MICHAEL CRONIN 73
BEVERLY CROSS 203
JOYCE CROSS 18
JUDY CROTHERS 39
LOUISE CRUM 326, 327
ROLLIN CRUM 326, 327
DOROTHY CRUSEMEYER 326
ELIZABETH CRUSEMEYER 325, 326
JOHN CRUSEMEYER 326
LEONARD CRUSEMEYER 326
MARTHA CRUSEMEYER 326
MARY CRUSEMEYER 326
RAYMOND CRUSEMEYER 326
A.J. CULLIN 192
KERRY CULVER 311
JAMES CURD 30
JAMES G. CURD 8
JUDITH LOUISE ((ISAACS)) CUTLER 151
ARTHUR CUTLER 19
RUTH CUTLER 19
BERTHA DAEGER 19
THEODORE DALBERG 218
BILL DANIELS 139
ANNA MARY DANNACHER 221
CARIE DANNACHER 221
CATHERINE DANNACHER 221
EDWARD DANNACHER 221
EVA DANNACHER 221
GEORGE DANNACHER 221
JOSEPH DANNACHER 221
LENA DANNACHER 221
OLIVER DANNACHER 221
JIM DARBY 295
THELMA DARBY 295, 296
JACK DAUER 80, 86, 87
MARION DAUER 60, 60
MARION (PIES) DAUER 86
MARY JO DAUER 87
IRMA (GEIGER) DAUER 87
ERT DAUER 87
MICHAEL DAUMER 231

ADAM DAVENPORT 55
JENNIFER DAVENPORT 55
NATHAN DAVENPORT 55
RONALD DAVENPORT 55
NOLA DAVIDSON 46
EVELYN GRACE DAVIS 177
JO DAVIS 177
JOHN DAVIS 197
JOHN PAUL DAVIS 197
MARY ALICE DAVIS 197
A. DAVISON 231
ANN DEBUZMAN 332
MARY DEHART 41
SHARON DEHART 41
DEBORAH DEHAVEN 333
LAURA DEHAVEN 333
LEON DEHAVEN 333
PATRICK DEHAVEN 333
ALBERT DELLAMANO 306
PATRICIA DELLAMANO 306
THERESA DELLAMANO 306
THERESA DELLAMAON 306
FRANK DEPHEW 184
VERONICA DEPHEW 184
BRANDI DERFLINGER 144
BRITTANY DERFLINGER 148
BRITTANY RICHELLE DERFLINGER 144, 144
CHRISTOPHER DERFLINGER 148
CHRISTOPHER RONALD DERFLINGER 144
CLARENCE DERFLINGER 144
CLARENCE RONALD DERFLINGER 144
MARGARET MARY DERFLINGER 144
MARGARET DERFLINGER 134, 148
MICHELLE DERFLINGER 144, 148
NANNIE (TOLLIVER) DERFLINGER 144
TANNER RONALD DERFLINGER 144
HAZEL IRMA ((PEETZ)) DETERS 122
MARILYN DEWHERST 198
RANDY DEWHERST 198
EILEEN DICK 21
MICHELLE DIEKHOF 156
CATHERINE DIETZ 184
JOHN DIETZ 180, 184
BERTHA DILKS 277
BILL DILKS 276
CATHY DILKS 276
JIM DILKS 276, 276
JO ANN DILKS 276
JOAN DILKS 276
OLIE DILKS 276
OPAL DILKS 276
ALLAN DILLOW 41
BECKY DILLOW 41
BESSIE DILLOW 42
DANIEL DILLOW 42
DAVID DILLOW 41, 41
DENISE DILLOW 41
JAMES DILLOW 41, 41
JENNIFER DILLOW 41
JEREMY DILLOW 41
JOSHUA DILLOW 41
MARY ANN DILLOW 41
MARY FRANCIS DILLOW 41
NORMA JEAN DILLOW 42
RICHARD DILLOW 41
ROBERT DILLOW 41
YONG FI DILLOW 41
CATHY DOCKTER 176
CHRISTINE DOCKTER 176
E.J. DOCKTER 176
JAMES DOCKTER 176
SUSAN DOCKTER 176
THOMAS DOCKTER 176
LORETTA DOHMESCHER 344
ALMA DOHR 269
JOSEPH DOHR 269
RITA DOHR 266, 269
MARIA ANNA DOLL 338
MARY ANNA DOLL 344
JOSHUA HARRISON DONNERMEYER 87
KATHLEEN DONNERMEYER 87
MOLLY ELIZABETH DONNERMEYER 87
SAM DOUGLAS 8

DORIS ANN DOYLE 166
ELEANORA DOYLE 166
ELEANORA BERNADINE DOYLE 165
JAMES WILLIAM DOYLE 165
WILLIAM DOYLE 166
CYRIL DUERSTOCK 254
HELEN DUERSTOCK 253
KENNETH DUERSTOCK 253
LAWRENCE DUERSTOCK 253
MARGARET DUERSTOCK 253
MARVIN DUERSTOCK 254
NORBERT DUERSTOCK 253
PITA DUERSTOCK 254
URRAN DUERSTOCK 254
VINCENT DUERSTOCK 254
TERES DUNN 273
AMBIA DUNNINGTON 20, 20, 21
ALONZO M. DUTTON 331
CHLOE DUTTON 331
EVELYN (WILKINS) DUTTON 78
JACK DUTTON 78
LUCILLE DUTTON 331
SUSAN DUTTON 78
AARON DWENGER 69
ARRIE DWENGER 55
ADA DWENGER 23
ADELHEIDE DWENGER 31
ADOLPH DWENGER 7, 8, 38, 43, 45
AGNES DWENGER 21
ALBERT DWENGER 13, 16
ALFRED DWENGER 7, 8, 24, 37, 38, 41, 42, 42, 58
ALFRED (EARL) DWENGER 38
ALICE DWENGER 16, 21
ALISHA DWENGER 46
ALMA DWENGER 7, 8, 24, 34
ALMIRA DWENGER 32
ALVINA DWENGER 7, 8, 16, 24, 37, 39, 58, 250
AMANDA DWENGER 16
AMILIA DWENGER 10
AMY DWENGER 44
ANDREW DWENGER 158
ANGELA DWENGER 16, 45
ANGIE DWENGER 46
ANN DWENGER 17
ANN AMELIA DWENGER 7
ANN MAE DWENGER 136, 136
ANNA DWENGER 7, 17, 23, 24, 24, 27, 37, 38, 38, 41, 42, 45, 46, 46, 52, 54, 54, 5, 56, 59, 60, 64, 66, 68, 70, 73, 79, 99, 101, 114, 117, 118, 136, 190, 192, 193, 155, 16
ANNA (HESSLER) DWENGER 239
ANNA (SEIBEL) DWENGER 22, 23, 86
ANNA (SEILBEL) DWENGER 74
ANNA AMILIA DWENGER 17
ANNA CAROLINE DWENGER 8
ANNA CATHERINE DWENGER 22
ANNA KATHERINE DWENGER 12
ANNA M. ((WILMERING)) DWENGER 7, 7
ANNA MAE DWENGER 8
ANNA MARIE DWENGER 17, 17
ANNA MARY (AMELIA) DWENGER 16, 20
ANNE DWENGER 44
ANNIE DWENGER 60, 89, 100
ANTHONY DWENGER 163
BARBARA DWENGER 8
BARTHOLAMEW DWENGER 69
BERNADINE DWENGER 7, 8, 23, 32
BERNARD DWENGER 7, 7, 8, 8, 9, 9, 10, 11, 12, 13, 15, 16, 18, 22, 23, 25, 27, 31, 32, 34, 34, 35, 37, 77, 163, 172, 174
BERNARD EDWARD DWENGER 16
BERNARD H. DWENGER 20
BERTHA DWENGER 16, 17
BERTRAM DWENGER 17
BESSIE DWENGER 2, 7, 8, 24, 38, 41, 42, 43, 44, 45, 50, 50, 50, 52, 56, 58
BETTY DWENGER 7, 8, 21, 38, 43, 43, 46, 60, 99, 100, 118
BLAIR DWENGER 44
BLANCA DWENGER 17
BOB DWENGER 60
BONNIE DWENGER 73

BRADLY DWENGER 21
 BRANDI DWENGER 46,73
 BRENDA DWENGER 158,278
 BRIAN DWENGER 44,278
 BRIAN EDWARD DWENGER 158
 BRODDI DWENGER 158
 BRUCE DWENGER 44,44
 BRYAN DWENGER 46
 CANDI DWENGER 46
 CARL DWENGER 102
 CARLA DWENGER 44
 CAROL DWENGER 7,21,60,72
 CAROL (PETERS) DWENGER 196
 CAROL NOREEN DWENGER 75
 CAPOLINE DWENGER 7,23,27,38
 CAPOLYN DWENGER 8
 CARRIE DWENGER 7,8,10,22,24,27,28,
 29,29,31,36,37,58,59,163,172,174,
 180,188,195,196,28
 CATHERINE DWENGER 7,8,9,10,10,12,
 15,20,20,22,23,24,25,26,27,31,37,43,
 46,59,160,161,163,168,172,174,188,
 195,28
 CATHERINE (RAVER) DWENGER 10
 CHARLES DWENGER 10,152,153,278
 CHARLES (CARL) DWENGER 17
 CHRISTINA DWENGER 73
 CHRISTOPHER DWENGER 278
 CHRISTOPHER MICHAEL DWENGER 158
 CLARA DWENGER 8,24,27,37,38,43,46,
 47,52,57
 CLARENCE DWENGER 2,7,8,13,21,24,37,
 38,41,42,43,44,45,50,56,58
 CLARRISA DWENGER 17
 COLEEN DWENGER 69
 DALAS DWENGER 44
 DANA DWENGER 45
 DANCE' DWENGER 69
 DANIEL DWENGER 69
 DARLENE DWENGER 46
 DARYL DWENGER 46
 DAVID DWENGER 30,44,44
 DAVID JOSEPH DWENGER 21
 DAWN DWENGER 152,153
 DEANNA DWENGER 46
 DEBBIE DWENGER 7,8,38,158
 DEBORAH DWENGER 55
 DEBRA DWENGER 44
 DELORES DWENGER 65
 DENNIS DWENGER 57
 DIANE DWENGER 43,44,152,278
 DICK DWENGER 7,60,93,99,100,103,117
 DONALD DWENGER 7,7,8,8,8,21,43,43,
 44,60,64,65,66,69
 DONNA DWENGER 65
 DONNY DWENGER 38
 DORIS DWENGER 7,8,38,43,44
 DOROTHY DWENGER 7,8,60,63,72,193
 DOUGLAS DWENGER 69
 DUSTIN DWENGER 44
 EARL DWENGER 7,8
 ED DWENGER 23,42,52
 EDDIE DWENGER 24,112
 EDDIE JOE DWENGER 99
 EDNA DWENGER 7,8,60,64,65,65,66
 EDWARD DWENGER 8,38,44,57,57,58,58,
 65,118
 EDWARD J. DWENGER 7
 EDWARD JOSEPH DWENGER 8,60,89,103,
 155,158,158,278
 EDWIN DWENGER 7,8,23,31,34
 EILEEN DWENGER 21
 ELEANOR DWENGER 62,62,63,72,193
 ELEANORA DWENGER 73
 ELENOR DWENGER 7,19
 ELENORA DWENGER 7
 ELIZABETH DWENGER 7,8,12,20,22,23,
 25,25,31,32,32,34,34,34,35,38,163
 ELIZABETH (BETTY ULM) DWENGER 24
 ELLEN DWENGER 7,8,8,23,30,64,72,86,
 88,88,193,194
 ELLEN (RIES) DWENGER 76
 ELLENA (RIES) DWENGER 80
 ELMER SHERMAN DWENGER 7
 ELSIE DWENGER 17
 EMILY DWENGER 8,30
 EMMA DWENGER 7,8,24,38,38,46,57,58
 EMMA AMILIA DWENGER 37
 EMMA EMILIA DWENGER 41
 EMMA ROSE DWENGER 46
 ERIC DWENGER 44
 ERICH DWENGER 67
 ESTHER DWENGER 7,7,8,60,99,100,101,
 103,110,112,113,114,117,118,136,263,
 155,278
 ESTHER ANN DWENGER 89
 FLORA DWENGER 7,8,23,60,62,63,64,
 65,66,68,69,70,71,71,71
 FLORENCE DWENGER 7,8,38,55,55,55
 FRANCIS DWENGER 7,10,17,22,27,31,
 37,43,59,174
 FRANCIS D. DWENGER 100
 FRANK DWENGER 7,8,10,10,31,60,74,
 76,79,80,86,101,190,190,163
 FRANK B. DWENGER 59
 FRANK J. DWENGER 22,23,25,27,37,59,
 64,66,68,70,94,172,174,180,194
 FRANKLIN DWENGER 17,17
 SAYLA DWENGER 46
 GEORGANNA DWENGER 7
 GEORGE DWENGER 7,16,20,21
 GEORGE WILLIAM DWENGER 16,17
 GEORGEANNE DWENGER 31
 GEORGIANNE DWENGER 8
 GERHART DWENGER 7,9
 GINNY DWENGER 73
 GLADYS DWENGER 7,8,24,38,41
 GREGORY DWENGER 7,10
 GREGORY DWENGER 46,66
 GWENDOLYN DWENGER 66,67
 HAROLD DWENGER 2,7,8,23,27,28,29,
 30,193,203,28
 HARRY DWENGER 72,76,80,88,89,89,98,
 98,100,131
 HARRY HERMAN DWENGER 16
 HARRY J. DWENGER 7,8,12,23,59,60,
 62,63,64,97,99,106,110,117,118,283,
 152,154,158,194,278
 HARRY JOSEPH DWENGER 155
 HARRY J. DWENGER 100
 HAZEL DWENGER 7,8,38,46,46
 HELEN DWENGER 7,7,8,17,60,64,65,66,
 68,100,100
 HENRY DWENGER 7,7,8,9,10,12,20,22,
 24,25,27,31,38,43,45,46,46,52,54,59,
 93,163,172
 HENRY B. (MR.&MRS.) DWENGER 3,37,
 41,42,44,56,57,58
 HENRY CARL DWENGER 16,17
 HENRY J. DWENGER 20,188
 HILDA DWENGER 7,8,24,37
 HILLARY DWENGER 44
 HILMAR DWENGER 23
 HILMER DWENGER 7,8,59,62,63,64,72,
 73,75,76,80,88,194
 HILMER JR. DWENGER 7,8,60,72,73
 HILMERL DWENGER 74
 HOLLY DWENGER 16
 IRENE DWENGER 16
 IRWIN DWENGER 16
 J. BERNARD DWENGER 9,10
 J.H. DWENGER 27
 JACKIE DWENGER 42
 JAMES DWENGER 8,21,43,43,45,153,278
 JAMES RICHARD DWENGER 152
 JANCIE DWENGER 38
 JANE DWENGER 7,8,31
 JANET DWENGER 21,158,158
 JANET (GUS) DWENGER 154,278
 JANICE DWENGER 7,8,55,55
 JASON DWENGER 43,278
 JAYNE ANN DWENGER 69
 JEAN DWENGER 7,7,8,8,23,29,30,31,
 38,44,203
 JEANNE DWENGER 44
 JEFFERY DWENGER 46
 JEROME DWENGER 73
 JESSICA DWENGER 46
 JIM DWENGER 38
 JOAN DWENGER 7,45
 JOAN (SIS) DWENGER 152,278
 JOANNA DWENGER 23,32
 JODI DWENGER 46
 JOE DWENGER 2,23,46
 JOHANNA DWENGER 7,8,34
 JOHN DWENGER 7,8,8,8,10,22,23,25,
 27,27,28,29,31,37,59,73,97,283,172,
 174,228,239
 JOHN FRANK DWENGER 16
 JOHN HENRY DWENGER 59,278
 JOHN JOSEPH DWENGER 16,17
 JOHN PETER DWENGER 17
 JOHNNY DWENGER 46
 JOSEPH DWENGER 7,7,8,10,16,20,23,
 29,30,31,31,34,46,57,203,278
 JOSEPH GERHARD ((BISHOP)) DWENGER 9
 JOSHUA DWENGER 43
 JUANITA DWENGER 2,8,23,31,34
 JUDITH DWENGER 73
 JUDY DWENGER 46,73
 JULIANA DWENGER 73
 JULIE DWENGER 158
 KAREN DWENGER 7,8,8,31,34,44
 KATE DWENGER 55
 KATHERINE DWENGER 7,8,20,36
 KATHILEEN DWENGER 106,114,118,155,
 278
 KATHRYN (SIS) DWENGER 153
 KATHY DWENGER 7,16,60,99,101,117
 KATY DWENGER 100
 KELLI ANN DWENGER 153
 KELLY DWENGER 44
 KEN DWENGER 7
 KENNETH DWENGER 8,30,55
 KEVIN DWENGER 16
 KIMBERLY DWENGER 69
 KRISTEN DWENGER 8,30
 KYLE DWENGER 158
 LADYS DWENGER 8,8
 LAURA DWENGER 17
 LAWRENCE DWENGER 152,153,278
 LEE DWENGER 44
 LENA DWENGER 21
 LEO DWENGER 7,8,24,37,38,45
 LEONA DWENGER 20,23
 LEONARD DWENGER 7,17,60,89,99,100,
 101,102,117,118,154,155,278
 LEONE DWENGER 8,29,30,28
 LESIA DWENGER 43
 LEZA DWENGER 73
 LILLIE DWENGER 73
 LINDA DWENGER 7,8,23,29,30,65,203
 LINDA KAY DWENGER 21
 LISA DWENGER 44,46,55,69
 LISA ANN DWENGER 44
 LLOYD DWENGER 7,38,43,45
 LOIS DWENGER 21
 LORETTA DWENGER 7,8,23,32,34
 LOUISE DWENGER 7,8,32
 LUCILLE DWENGER 21
 MABEL DWENGER 38,43,45
 MABLE DWENGER 7
 MAGDELINA DWENGER 7,22,23,27,29,163
 MARCELLA DWENGER 21
 MARGARET DWENGER 7,7,16,21,22,23,
 24,31,31
 MARILYN DWENGER 7,8,31
 MARK DWENGER 46
 MARRY (HESSLER) DWENGER 99
 MARTHA DWENGER 7,7,8,23,23,29,30,
 59,59,62,64,67,72,77,80,89,193,194,
 203,278,278
 MARTHA (STIER) DWENGER 80
 MARTHA ELIZABETH ((BETTY)) DWENGER
 8,89,155
 MARTHA MARY DWENGER 8
 MARY DWENGER 7,23,24,27,28,32,34,
 60,62,89,89,100,101,106,110,117,118,
 193,263,152,154,158,174,194,207,207,
 209,227,270,336
 MARY (HESSLER) DWENGER 2,8,80,94,
 97,98

MARY BETH DWENGER 16
MARY CATHERINE ((WIRDT)) DWENGER 7, 7, 8, 9, 9, 10, 12, 16, 18
MARY CECILIA ((HESSLER)) DWENGER 1 31, 131
MARY ELIZABETH DWENGER 10, 16, 21
MARY ELLEN DWENGER 60, 89, 117, 118, 136, 155, 278
MARY FRANCIS DWENGER 30, 41, 163
MARY JANE DWENGER 7, 60, 64, 65, 66, 69
MARY LOU DWENGER 66, 68
MARY PHILOMENA DWENGER 16, 17
MARY ROSE DWENGER 44
MARY CECILIA ((HESSLER)) DWENGER 94
MARY ELLEN DWENGER 99
MARY JANE DWENGER 8
MATILDA DWENGER 17, 19
MATTHEW DWENGER 42
MAURICE DWENGER 7, 8, 29, 31, 34
MELISSA DWENGER 45, 158
MELVIN DWENGER 46
MICAH DWENGER 21
MICHAEL DWENGER 8, 21, 44, 69
MILDRED DWENGER 21
MITCHEL DWENGER 67
MYRTLE VIVIAN DWENGER 38
MYRTLE DWENGER 41
NAN DWENGER 17
NANCY DWENGER 73
NATHAN DWENGER 42
NICHOLAS DWENGER 45, 69
NILI DWENGER 158
NITA ((O'MARA)) DWENGER 7
NOLA DWENGER 46
NORA DWENGER 8, 23, 60, 63
NORA ((WALKER)) DWENGER 74, 75
NORBERT DWENGER 7, 8, 24, 37, 38, 52
NORBERT H. DWENGER 3
NORMA JEAN DWENGER 21
OLIVIA DWENGER 7, 8, 24, 37, 38, 41
OTILIA CATHERINE DWENGER 27
PAMELA DWENGER 16, 66, 67, 73
PARIS DWENGER 7, 8, 38, 46
PAT DWENGER 64
PATRICIA DWENGER 7, 8
PATRICIA ((PAT)) DWENGER 65, 65
PAUL DWENGER 7, 8, 24, 52, 55, 55, 55, 58, 66
PAULA DWENGER 44
PAULINE ((PAT)) DWENGER 66, 71
PETER DWENGER 37, 38, 54, 55
PETER CATHERINE DWENGER 27
PETER EDGAR DWENGER 17
PETER LEO DWENGER 17
PETER WALDO DWENGER 37, 38, 45, 46
PHILIP DWENGER 45, 69
PHILOMENA DWENGER 7, 10, 19
PHYLLIS DWENGER 46
RACHEL DWENGER 46
RALPH DWENGER 2, 7, 8, 21, 60, 64, 65, 66, 67, 68
RANDALL DWENGER 55, 66, 67
RANDY DWENGER 7, 7, 7, 8, 38
RAY DWENGER 62
RAYMOND DWENGER 7, 8, 23, 63, 64, 64, 64, 65, 66, 68, 69, 70, 71, 72, 76, 80, 88, 194
RENAE DWENGER 42
RICHARD DWENGER 7, 8, 8, 31, 55, 55, 118, 278
RICHARD ((DICK)) DWENGER 8, 152, 153, 155, 158
RICHARD FRANCIS DWENGER 89, 89
RICHELLE DWENGER 69
RICK DWENGER 7, 8, 38, 66, 67
RITA DWENGER 7, 8, 38, 43, 44
RITA MAE DWENGER 45
ROBERT DWENGER 7, 7, 8, 8, 17, 38, 43, 43, 43, 64, 65, 66
ROBERT EUGENE DWENGER 17
ROGER DWENGER 46
ROMAN DWENGER 7, 8, 23, 32, 34
ROMILDA DWENGER 7, 24, 38, 38
RONALD DWENGER 66, 67
ROSA DWENGER 10, 20
ROSE DWENGER 7, 24, 38, 38, 60, 100, 103
ROSE MARIE DWENGER 16
ROSELLA DWENGER 118, 155
ROSELLA DWENGER 278
ROSELLA CECILIA DWENGER 89
ROSTE DWENGER 7, 8, 99, 100, 101, 114, 117, 117
ROSINA DWENGER 16
RUSSEL DWENGER 7
RUSSELL DWENGER 8, 64, 65, 66
RUTH DWENGER 7, 7, 8, 23, 29, 30, 31, 60, 99, 100, 100, 117, 118, 121, 155, 203, 278
RUTH ANN DWENGER 8
RUTH ELENORA DWENGER 89
SALLY DWENGER 7, 8, 31
SANDRA DWENGER 8
SARA DWENGER 8, 30
SARAH DWENGER 19
SCOTT DWENGER 45
SEVERUS DWENGER 17
SHANNON DWENGER 73
SHIRLEY DWENGER 7, 8, 23, 152, 153
SIS DWENGER 103
SKYLAR DWENGER 158
SPORT DWENGER 13
STANLEY DWENGER 17
STELLA DWENGER 7, 8, 23, 24, 37, 52, 53, 57, 58, 59, 64, 72, 76, 80, 88, 89, 193, 193, 194
STELLA EMMA DWENGER 57
STEVE DWENGER 21
STEVEN DWENGER 8, 73
SUE DWENGER 73
SUSAN DWENGER 7, 8, 8, 31, 34
TAMMY DWENGER 44, 46
TERRICA DWENGER 154, 278
THEODORE DWENGER 7, 10, 20, 21
THERESA DWENGER 16, 16
THOMAS DWENGER 7, 8, 43, 44, 73
TIMOTHY DWENGER 46
TODD DWENGER 278
TOM DWENGER 7, 38, 43
TRACY DWENGER 44, 158, 278
TRISHA DWENGER 46
URBAN DWENGER 21
VERONICA DWENGER 17
VICKI DWENGER 30
VICTOR DWENGER 7, 8, 24
VINCENT DWENGER 7, 20, 22, 24, 31, 37, 59, 163, 172
VIRGINIA DWENGER 7, 8, 31, 73
WALDO DWENGER 7, 8, 8, 24, 38, 46, 46, 58
WALDO JR. DWENGER 46
WAYNE DWENGER 44, 44
WENDY DWENGER 45
WILLIAM DWENGER 3, 7, 10, 12, 13, 20, 22, 23, 24, 25, 26, 28, 29, 31, 36, 37, 38, 43, 44, 46, 57, 58, 59, 73, 160, 161, 163, 168, 172, 174, 195, 28
WILLIAM B. DWENGER 7, 23
WILLIAM BERNARD DWENGER 8, 10, 27, 27
WILLIAM EDWARD DWENGER 37
JOANNE DYER 117
ANGELINE EBBING 317
CHARLES EDWARD EBBING 317
DANIEL EBBING 317
DAVID EBBING 317
DEBRA EBBING 317
DENNIS EBBING 317
ERIC EBBING 317
JENNIFER EBBING 317
KATHERON EBBING 317
KATHLEEN EBBING 317
KATHY EBBING 317
KELLY EBBING 317
KENNETH EBBING 317
KENT EBBING 317
LESLIE EBBING 317
LOUISE EBBING 317
MARIE EBBING 317
MELANIE EBBING 317
PATTY EBBING 317
ROMAN EBBING 317
GEORGE EBERHARD 102
REVEREND EBERHARD 3
FRANCIS EBERHART 203
JOHN EBERHART 203
THELMA ECKHART 36
BRANDI ECKEL 40
LINDA ECKEL 40
RANDY ECKEL 40
RONALD ECKEL 40
CONRAD ECKHART 196
DEBBIE ECKHART 8, 196
DENNIS ECKHART 8, 196
RALPH ECKHART 8, 196
THELMA ECKHART 8, 196
PAM ECKSTEIN 154, 154
SUSAN EDDINGTON 196
JAMES EDGAR 196
KIMBERLY EDGAR 196
TIMOTHY EDGAR 196
CATHERINE EFFING 292
DEBBIE EFFING 38
MARY B. EFFING 249
FRANCIS EFFINGER 40, 40, 41
LUCILLE EFFINGER 40, 41
SCOTT EFFINGER 41
SHARON EFFINGER 41
DONNA EGGENOFF 169
FREDERICK EHRHART 313
VERNA EICHACKER 203
CRYSTAL OMA ((PEETZ)) EISERT 122
HELEN ELDER 17, 17
HALEY ELLIS 332
JILL ELLIS 332
MEGAN ELLIS 332
WALTER ELLIS 332
JOSEPH ELROD 196
LINDA ELROD 36, 36, 196
MARK ELROD 196
MIGGAN ELROD 196
ASHLY EMSWELLER 285
CHAD EMSWELLER 285
CHARLES EMSWELLER 285
ELIZABETH ENDERLINE 316
GEORGE ENDERLINE 316
GEROME ENDERLINE 316
IGNATIUS ENDERLINE 316
JOHN ENDERLINE 316
KATHERINE ENDERLINE 316
ROSALEE ENDERLINE 316
ANDREA ENGELKING 340
DARLENE ENGELKING 340
ROBERT ENGELKING 340
RYAN ENGELKING 340
ERIC ENGSTROM 314
MADELAINE ENGSTROM 314
EMIL ENNEKILY 18
HELEN ENNEKILY 18
LISA EPFS 69, 69
HENRIETTA ERNSTES 176
CLARA ERPSTES 176
JOHANN ESIHWEILER 355
BARBRA ESSLINGER 16
DAVID ESSLINGER 16
DENNIS ESSLINGER 16
EDWARD ESSLINGER 16
JAMES ESSLINGER 16
JERRY ESSLINGER 16
JOHN ESSLINGER 16
JUDITH ESSLINGER 16
LARRY ESSLINGER 16
MARY ALICE ESSLINGER 16
TERRY ESSLINGER 16
THERESA ESSLINGER 16
THOMAS ESSLINGER 16
ANITA ETTER 171
ANTHONY ETTER 166, 171
EDWARD ETTER 171
RITA ETTER 166, 171
DAVID EULER 298
RICKY EULER 298
ROSE EULER 298
JULIE EVANS 73
CATHERINE FAHEY 329
JERRY FASBINDER 7, 38
ROSE FASBINDER 7, 8, 38

EVELYN FECHER 47
 ANTHONY FEDERLE 167
 FAT FEDERLE 19
 ROMAN FEDERLE 167
 MARCIA FEHLINGER 38
 ELEANOR FEHRMAN 19
 CLEONORA FEHRMAN 17,17
 ELIZABETH FEHRMAN 163
 HENRY FEHRMAN 163
 BARRY JOSEPH FELDMAN 311
 BLAISE FELDMAN 311
 EPAD FELDMAN 311,312
 BRENT FELDMAN 311,312
 BRIAN FELDMAN 311,312
 BRITTANY FELDMAN 311,312
 BRUCE FELDMAN 311,312
 KELSEY FELDMAN 311,312
 KERRY FELDMAN 311
 LUELLA FELDMAN 311
 LYDIA FELDMAN 311
 MARVIN FELDMAN 311
 NANCY FELDMAN 311,312
 ROSS FELDMAN 311
 TARA FELDMAN 311,312
 JAMES FENN 333
 MARY ELLEN FENN 333
 RICHARD FENN 333
 ROBERT FENN 333
 (FATHER) FERNEDING 220
 JOSEPH FERNEDING 224
 ROSE FERRENDER 24
 MARY ROSE FERRY FRAZER 149
 WAYNE FIELD 169
 MARGARET FIFFER 321
 JANICE (ANITA) FIRSICH 19
 CAROLINA FISCHER 163
 CLARA FISCHER 39,166,166
 CLEMENS FISCHER 163
 F.B. FISCHER 3
 FRANK FISCHER 166,166
 MARIA FISCHER 166
 MARIE FISCHER 166
 BETTY FISHER 333,333
 JOANNA FISHER 32,32,32,32,32
 JOHN FISHER 3
 CHARLES FISSE 167
 EILEEN FISSE 167
 ALICE FIVECOAT 332
 ANNA MARIA FLECKENSTEIN 222
 ANNA MARIA FLECKENSTEIN 208,212,226
 ANNA MARIA FLECKENSTEIN 222,223
 JOHANN FLECKENSTEIN 223
 ALMA FLESCH 269
 EVELYN FLETCHER 47,47
 ANITA FLICK 16
 BRIAN FLICK 16
 DENNIS FLICK 16
 GREG FLICK 16
 KATHY FLICK 16
 MARY AGNES FLICK 16
 PATRICK FLICK 16
 RICHARD FLICK 16
 DELORES FLINT 294
 DOUG FLINT 294
 NATHAN FLINT 294
 ROB FLINT 294,294
 AMANDA FLODDER 52
 ANNA MAE FLODDER 52
 HARRY FLODDER 165
 MARY FLODDER 165
 MELANIE FLODDER 52
 ROBERT FLODDER 52
 TIM FLODDER 52
 CHARLES (REV.) FLORY 52
 AMANDA FODDER 51
 MELANIE FODDER 51
 TIM FODDER 51
 ROSE FORBENDER 8
 JOE FORSTER 203
 CHERYL FORTNER 297
 MILDRED FOSTVEDT 231
 BRADLY FOX 312
 DEANNA FOX 312
 JASON FOX 312
 JOHN FOX 312
 JOHN PETER FRANK 17
 ROSE FRAND 34
 AMY FRAZER 149
 CHRISTINA FRAZER 149
 FRANK FRAZER 149
 MICHELLE FRAZER 149
 ROSANNA CATHERINE ((BURKE)) FRAZER 149
 AMY FRAZIER 148
 CHRISTINE FRAZIER 148
 NICHELLE FRAZIER 148
 JACQUELINE FREERS 333
 BRIAN FRENCH 158
 CHRIS FRENCH 158
 JANET FRENCH 158
 EVELYN FRIELING 19
 ANN FRY 6-1,66
 ANNA MARY FRY 70
 MARY M. FRY 233
 THERESA FRY 233
 WILLIAM FRY 233
 ADELAIDE FUNKE 287
 ELIZABETH FURUETH 273
 CECILIA MARIE GALLAGHER 341
 JOSEPH MATHIAS GALLAGHER 341
 PAUL HUGH GALLAGHER 341
 CORA GARD 183
 SARA GARD 200
 HARVEY GARDNER 54
 KITTY GARDNER 54
 SHERRY GARDNER 54
 ALLEN GARRISON 44
 DEBRA GARRISON 44
 HILDA GARRISON 288
 TIM GARRISON 44
 BRITNIE GARRITY 54
 HEATHER GARRITY 54
 ANNA GATES 203
 AARON GATEWOOD 317
 BETTY GATEWOOD 317
 BRYAN GATEWOOD 319
 DARIAN GATEWOOD 319
 GAYLE GATEWOOD 317,319
 MARY ELIZABETH GATEWOOD 319
 MARGARET GAUCK 166
 QUIRIN GAUCK 166
 ANDY GAULK 171
 BART GAULK 171
 BONITA GAULK 171
 BRENDA GAULK 171
 BRIAN GAULK 171
 CHRISTINE GAULK 171
 DIANNA GAULK 171
 DON GAULK 171
 DONNA GAULK 171
 ERNIE GAULK 171
 GERALD GAULK 171
 JEFF GAULK 171
 JOE GAULK 171
 MARGARET GAULK 171
 MARY GAULK 171
 PAUL GAULK 171
 QUIEN GAULK 171
 ROSEMARY GAULK 171
 RUTH GAULK 171
 STEVEN GAULK 171
 TIM GAULK 171
 MARIA ELIZABETH GEINERS 231
 COLEEN GEIRLACK 69
 MARGARET GEIS 179
 MARION GEIS 166,171,171
 ANETTE GENDER 33
 MARY GENTRY 40
 MARY ANN GEORGE 232,232,232
 MAUDE GERHART 329
 B. GIGOS 231
 ELASIVS GIGOS 224
 KATE GIGRICH 13
 MATILDA GIGRICH 165,166
 EMILY LOUISE GILB 82
 LAURA GILB 82
 MICHAEL DAVID JR. GILB 82
 RUSSELL GILB 82,82
 ANGIE GILLAN 46
 CARMELITA GINDLING 18
 MARY LOU GINDLING 66
 MICHAEL GINDLING 66
 ROSINA GINDLING 66
 MARGARET GLAAB 220
 MARGARETA GLAAB 221
 STEPHAN GLASER 52
 MAGDELINA GODAKA 203
 SANDRA GODFREYSON 268
 DANIEL JOSEPH GODIN 291
 JULIANNE GODIN 291
 MARY LEE GODIN 291
 FREDA GOIN 177
 GOLDSCHMIDT 187
 ALBERT GOLDSCHMIDT 231
 ANNA GOLDSCHMIDT 231
 BERNARD GOLDSCHMIDT 231
 ESTELLA GOLDSCHMIDT 231
 JOHN GOLDSCHMIDT 231
 JOSEPHINE GOLDSCHMIDT 231
 ROSA GOLDSCHMIDT 231
 AL GOLDSMITH 7
 MARIA GOLDSMITH 10
 JULIA GOODWIN 177
 STEVE GORDON 171
 CAROLYN GORMAN 85
 JOHN GORMAN 84,84,85
 RATHDUZ GRASSER 281
 VIRGINIA GRASSER 200,201
 GEOFFREY GRAUE 319,319
 GREGG GRAUE 317
 GREGORY GRAUE 319
 HELEN GRAUE 317,319
 JEFF GRAUE 317
 RONALD GRAUE 317,319
 MAMIE GRAY 311,312
 ALICE LOVE GREEN 227
 BETTY GREEN 197
 DAVID JOHN GREEN 197
 LAURA BELL GREEN 197
 BERNARD GREGORY 227
 CATHERINE GREINER 322
 CHARLES MRS. GREIWE 221
 JANET GREIWE 158
 CECILIA GRIDER 305
 MYRTILDIA CECILA GRIDER 309
 JEFFERY GRIESHOP 167
 LISA GRIESHOP 167
 RITA GRIESHOP 167
 SANDY GRIESHOP 167
 THOMAS GRIESHOP 167
 TOMOTHY GRIESHOP 167
 JANET GRIEWE 8
 CATHERINE GRIFFIN 43
 CHRISTOPHER GRIFFIN 43
 JESSICA GRIFFIN 43
 ALICE GRIFFITH 150
 ALICE JEAN GRIFFITH 150
 AMANDA GRIFFITH 150
 CARL JAMES GRIFFITH 150
 CAROLYN JANE GRIFFITH 150
 CHRISTY GRIFFITH 150
 DANIEL ALEXANDER GRIFFITH 150
 EARL GRIFFITH 150
 GEORGE GRIFFITH 150
 GEORGE JR. GRIFFITH 150
 JAMES GRIFFITH 150
 MICHELLE GRIFFITH 150
 RUTH GRIFFITH 2,134,150
 CINDY GRIGANVICIUS 305
 VIC GRIGANVICIUS 305
 CATHERINE GRIMES 322,321,331
 CATHERINE GRINER 237
 ANGELA GROCHALSKI 306
 JOSEPH GROCHALSKI 306
 LORETTA GROCHALSKI 306
 LORETTA JOSEPH GROCHALSKI 306
 NORBERT GROCHALSKI 306
 ROSIE GROCHALSKI 306
 SHIRLEY GROCHALSKI 306
 SUSANNE GROCHALSKI 306
 KATHLEEN GUPPY 317
 JAVIER GUTIERRIZ 273

JOAN H 177
BEVERLY HAFNEY 82
CYNTHA ANN HAFNEY 82
DIANE MARIE HAFNEY 82
EDWARD J. HAFNEY 82
EVELYN (RIES) HAFNEY 86
JO ANN HAFNEY 60
JOANNE (RIES) HAFNEY 82, 86, 86
HAGDELINA HAHAMAN 203
A. HAHN 225
ALBERT HAHN 29, 204
ALBERT DANIEL HAHN 203
ALFRED HAHN 29, 203
ANDREW HAHN 204, 203
ANDREW ERNEST HAHN 78
ANNA HAHN 29, 187
ANNA MARIA HAHN 201
ANTHONY HAHN 204, 199, 200, 201, 202,
203
ANTON HAHN 231
BARBARA HAHN 200, 201
BEVERLY HAHN 203
BROCK EDWARD HAHN 78
CARLA HAHN 203
CARLOTTA HAHN 203
CAROL HAHN 203
CAROLINE HAHN 201
CAROLYN HAHN 204
CATHERINE HAHN 201
CHARLES HAHN 204, 201
CHRISTINA HAHN 201
CONSTANCE HAHN 203
DANIEL HAHN 203
DAVID HAHN 28
DAVID NORBERT HAHN 78
DORA HAHN 204, 203
EDNA HAHN 201
ELIZABETH HAHN 190, 204, 187, 200, 201,
203
ELIZABETH (WORST) HAHN 201
ERNEST HAHN 203, 203
EVA BARBRA HAHN 200
EVA FRANCIS HAHN 199, 201
EVA FRANCIS HAHN 200
FELDA HAHN 28
FRANCIS HAHN 187, 203
FRANK HAHN 203
FREDERICK HAHN 200
GEORGE HAHN 187, 200
GORDON HAHN 203
GORDON HAROLD HAHN 78
HENRY HAHN 204, 204, 204, 187, 200, 203
HERBERT HAHN 203
HILBERT HAHN 200
IDA HAHN 204, 201
JOHN HAHN 187, 199, 200, 201, 203
JOSEPH HAHN 187, 199, 200, 200, 201
JOSEPHINE HAHN 78, 201, 203
KEVIN HAHN 203
KEVIN ANDREW HAHN 78
LAWRENCE HAHN 203
LAWRENCE JOHN HAHN 78
LEO HAHN 29
LEO DAVID HAHN 203
LEONA HAHN 23
LEONARD HAHN 203
LEONE HAHN 8, 27, 28, 29, 30, 203, 28
LORETTA HAHN 203
LOUIS HAHN 203
MAGDELINA HAHN 23, 36, 190, 190, 193,
179, 187, 188, 195, 199, 200, 200, 203
MARGARETTA HAHN 200
MARGIE HAHN 2, 60, 203
MARIA HAHN 203
MARIA ANNA HAHN 200
MARK HAHN 203
MARK RALPH HAHN 78
MARY HAHN 29, 204, 180, 203, 28
MARY ANNA HAHN 190, 204, 200, 201, 202
MARY MAGDELINE HAHN 201
MATTHEW LOUIS HAHN 78
MAURILE HAHN 203
MICHAEL LAWRENCE HAHN 78
MIKE HAHN 203

MILDRED HAHN 203
MINNIE HAHN 203
NADMI HAHN 203
NICOLE HAHN 203
NORBERT HAHN 76, 203
NORBERT VALENTINE HAHN 78
PATRICK HAHN 78, 203
RALPH HAHN 203
ROBIN HAHN 203
ROLAND HAHN 203
ROLLIN HAHN 29, 29, 203
RUSE HAHN 203
SARA HAHN 200
SARAH HAHN 203
SIBILLA HAHN 199, 200, 201
SUSAN ELIZABETH HAHN 78
SUSANNA HAHN 203, 203
SUSANNAH HAHN 204
THEODORE HAHN 203
THOMAS JEFFREY HAHN 78
TIMOTHY JACKSON HAHN 78
TONI O'MARA HAHN 78
VALENTINE HAHN 29, 190, 187
VALENTINE (FELDA) HAHN 204, 187, 199,
200, 201, 201, 203, 225
WILFRED HAHN 204, 203
ANTHONY HAINY 45
KEVIN HAINY 45
HABLL HAINY 43, 43, 43
CALVIN HALCOMB 100
CARRIE HALEY 142
MORTON HALEY 142
ANN HALL 177
ROBERT HALL 177
ANNA MAE HALLARD 18
ANN HAMILTON 118, 278
BARB HAMILTON 121
BARBARA HAMILTON 118, 278
CAROL HAMILTON 118, 278
CAROL MARIE HAMILTON 123, 126
CHARLES HAMILTON 8, 97, 97, 99, 99, 102,
118, 119, 120, 121, 123, 123, 127, 278
CHARLES (CHUCK) HAMILTON 118
CHARLES HERMAN HAMILTON 122
CHARLES WILLIAM HAMILTON 122
CHUCK HAMILTON 119, 120, 121
CINDY HAMILTON 119
CLEM HAMILTON 118
CLEMENT HAMILTON 232
COLTON HAMILTON 119
COLTON LEO HAMILTON 123
DALE HAMILTON 118, 120, 121, 123, 278
DALE JOSEPH HAMILTON 122
DAN HAMILTON 121
DIANA HAMILTON 119
DONALD HAMILTON 118
ELBERT HAMILTON 118
ETHAN HAMILTON 119, 119
ETHAN THOMAS HAMILTON 123
HELEN HAMILTON 118, 278
JAMES HAMILTON 118, 119, 120, 121, 123,
123, 278
JAMES DOANLD HAMILTON 122
JASON HAMILTON 119
JEFF HAMILTON 119
JENNY HAMILTON 119
JOE HAMILTON 119, 120, 121, 123
JORDAN HAMILTON 119
JOSEPH HAMILTON 118, 123, 123, 278
JOSEPH LEO HAMILTON 122
JOYCE HAMILTON 118, 121, 278
JOYCE ELIZABETH HAMILTON 127
KAREN HAMILTON 119, 121
KAREN (HAMILTON) HAMILTON 123
LEONAN HAMILTON 233
LINDA HAMILTON 118, 121, 278
LOIS HAMILTON 118
MARILYN HAMILTON 118, 119, 120, 121,
278
MARY HAMILTON 118
MILDRED HAMILTON 118
NICOLE HAMILTON 119
NATALIE HAMILTON 119
PHILIP HAMILTON 118, 120, 121, 123,
123, 278

RENAE HAMILTON 119
RUTH HAMILTON 99, 101, 103, 118, 119,
120, 121, 123, 123, 127, 155, 278
RUTH (DWENSER) HAMILTON 102
RUTH ELENORA HAMILTON 122, 122
SAMUEL HAMILTON 119
SU ANN HAMILTON 123
SU-ANN HAMILTON 121
SUANN HAMILTON 119
SUE HAMILTON 121
SUE ANN (SHARP) HAMILTON 123
SUSAN HAMILTON 119
SUSAN (HEATER) HAMILTON 123
LORRAINE HAMFSON 106
CATHERINE HAMFSSON 44
LEWIS HAMFSSON 44
MARY HAMPTON 197
MARY (BEAGLE) HAMPTON 180
CATHERINE HANDEL 327
CATHERINE HANDLE 321, 325
ANNA MARY HANLIN 328
ARTHUR HANLIN 328
AUSTIN HANNA 285
GINA HANNA 285
KYLE HANNA 285
TERRA HANNA 285
JOSHUA HANSEN 52
MICHAEL DR. HANSEN 52
SHIRLEY HANSEN 65
PEGGY HANSON 69
CELLA HARBAUGH 315
CHARLES HARBAUGH 315
MAYME HARBAUGH 315
ANDREW HARDEBECK 297
ANNA HARDEBECK 296
ANNA MARY HARDEBECK 201
BARNEY HARDEBECK 201
BEN HARDEBECK 296
BETTY HARDEBECK 296
BILL HARDEBECK 296, 297
BILLY HARDEBECK 298
CHERYL HARDEBECK 297
CLARA HARDEBECK 296
CLARENCE HARDEBECK 295, 297
CLARENCE JOHN HARDEBECK 296
DANIEL HARDEBECK 297
DONALD HARDEBECK 298
DOROTHY HARDEBECK 296, 297
EDNA HARDEBECK 201
EDWARD HARDEBECK 277
ELIZABETH HARDEBECK 290
ELMER HARDEBECK 296
EVA HARDEBECK 297
FRANCIS HARDEBECK 277
GEORGE HARDEBECK 201, 296
HELEN HARDEBECK 296, 297
HILDA HARDEBECK 155, 296
JAMES HARDEBECK 296
JAMES JOSEPH HARDEBECK 297
JASON HARDEBECK 297
JENNY HARDEBECK 297
JOAN HARDEBECK 297
JOHN HARDEBECK 201, 296, 297
JOSEPHINE HARDEBECK 110, 296
KAREN HARDEBECK 296, 297, 298
KENNETH HARDEBECK 298
MAE HARDEBECK 296
MARCIA HARDEBECK 298
MARGARET HARDEBECK 296, 298
MARIE HARDEBECK 296
MARIETTA HARDEBECK 296
MARY ANN HARDEBECK 296, 298
MATTHEW HARDEBECK 298
MICHAEL HARDEBECK 297, 297
NORA HARDEBECK 296
NORMAN HARDEBECK 297
NORMAN JOSEPH HARDEBECK 296
PATRICIA HARDEBECK 296, 297
REBECCA HARDEBECK 297
ROBERT HARDEBECK 296, 297, 298
RONALD HARDEBECK 298
ROSE HARDEBECK 203, 295, 296, 297
SHELLY HARDEBECK 297
STEVEN HARDEBECK 298
TERESA HARDEBECK 298

THERESA HARDEBECK 274,277
 THOMAS HARDEBECK 290
 TONY HARDEBECK 114,114,296
 WILLIAM HARDEBECK 297,297,298
 ANNA HARDING 331
 LOGAN HARDING 331
 NELLIE HARDING 332
 VIRGINIA HARDING 331
 DARNARD HARMeyer 167
 ELEANOR HARMeyer 166
 LORETTA HARMeyer 166
 ANDREA HARPRING 284
 ANNA HARPRING 285
 ANTHONY HARPRING 284
 ASILY HARPRING 285
 BEN HARPRING 287
 BERNARD HARPRING 284,285
 BLINDA HARPRING 285
 CATHERINE HARPRING 292
 CECILIA HARPRING 284
 CRYSTAL HARPRING 285
 DAVID HARPRING 284
 DIANA HARPRING 285
 EDGAR HARPRING 284
 ELVERA HARPRING 284,285
 ERMA HARPRING 285
 GINA HARPRING 285
 OWEN HARPRING 285
 HELEN HARPRING 177
 IRMA HARPRING 284
 JANIEY HARPRING 285
 JAY HARPRING 285
 JEAN HARPRING 284
 JENNIFER HARPRING 204
 JEREMY HARPRING 285
 JODI HARPRING 285
 JOHN HARPRING 284,285
 JOSEPHINE HARPRING 203
 LEE HARPRING 285
 LOIS HARPRING 284,285
 LUELLE HARPRING 284,285
 MARK HARPRING 285
 MARY HARPRING 284
 MARY JOAN HARPRING 284
 MAUREEN HARPRING 285
 PERRY HARPRING 285
 REBECCA HARPRING 285
 RITA HARPRING 292
 ROSE HARPRING 287
 ROSETTA HARPRING 205
 SAMUEL HARPRING 284,285
 SARAH HARPRING 284
 SHARON HARPRING 285
 SUE HARPRING 285
 SUSAN HARPRING 284,285
 TARESA HARPRING 285
 THELMA HARPRING 284
 TODD HARPRING 285
 TONYA HARPRING 285
 TRACY HARPRING 285
 VERNON HARPRING 284,285
 VICKI HARPRING 284
 WILLIAM HARPRING 292
 BETTY HARRIS 2,8,99,155,278
 CYNTHIA HARRIS 278
 EDWARD HARRIS 278
 ELIZABETH BETTY ((DWENGER)) HARRIS 130
 FAMILY HARRIS 130,130
 FRANK (ED) HARRIS 128
 FRANK ED HARRIS 8,90,100
 FRANK EDMUND HARRIS 128
 GREG HARRIS 2,278
 GREGORY WAYNE HARRIS 129
 JUANITA MARIE HARRIS 128
 KENNETH HARRIS 278
 KENNETH EUGENE HARRIS 129
 LAWRENCE HARRIS 278
 LAWRENCE JOSEPH HARRIS 129
 MARTHA ELIZABETH ((DWENGER)) HARRIS 128
 NITA HARRIS 278
 OLIVER HARRIS 34
 RICHARD JOHN HARRIS 128,128
 RICK HARRIS 278
 RUBY HARRIS 34
 RUTH HARRIS 34
 RICHARD EDWARD HARROLL 79
 THOMAS RADER HARROLL 79
 MARJARIE HARTMAN 47
 MARJORIE HARTMAN 47,48
 FRANZ HARTMANN 224
 ANNA HARVEY 333
 REMA HARVEY 333
 ROSALIE HARVEY 333
 TRACY HARVEY 44
 WILLIAM HARVEY 333
 SHIRLEY HASH 153
 ANNA MARIA HASKAMP 19
 ANNA MARIE HASKAMP 17
 BLN HASKAMP 7,17,17,17,19
 BERNARD HASKAMP 17,19,23,31
 BERTHA HASKAMP 19
 CARL HASKAMP 17
 CARL JOSEPH HASKAMP 19
 CORA HASKAMP 17,19
 DEBBIE HASKAMP 19
 DOREEN HASKAMP 19
 EDWARD HASKAMP 17,19,36
 ELEANOR HASKAMP 165
 LLLANORA HASKAMP 19
 ELIZABETH HASKAMP 7,8,22,23,25,25,31,32,34,34,172
 ETHEL HASKAMP 19
 EUGENE HASKAMP 19
 EVELYN HASKAMP 19
 FLORINE HASKAMP 165
 GWENAVEVE HASKAMP 19
 HAROLD HASKAMP 19
 HENRY HASKAMP 31
 JANICE HASKAMP 19
 JOE HASKAMP 19
 JOHN HASKAMP 19
 JOSEPH HASKAMP 31,165,182
 LEWIS HASKAMP 19
 LOUISE HASKAMP 19
 LUCILLE HASKAMP 19
 LUELLE HASKAMP 19
 MARGARET HASKAMP 19
 MARJORIE HASKAMP 19
 MARTHA HASKAMP 17,19
 MARY HASKAMP 19,31
 NANCY HASKAMP 19
 PAM HASKAMP 19
 PHILOMENA HASKAMP 10,17,19
 RAY HASKAMP 19
 RAYMOND HASKAMP 19
 REGINA HASKAMP 19
 ROBERT HASKAMP 19
 ROSALINE HASKAMP 19
 RUTH HASKAMP 19
 SARAH HASKAMP 17,19
 SHARON HASKAMP 19
 SYLVESTER HASKAMP 165
 TIM HASKAMP 19
 TOM HASKAMP 19
 VIRGIL HASKAMP 19
 ALICE HASSER 21
 ALOYSIOUS HASSER 21
 MARY ELIZABETH HASSER 21
 CURTIS HASTY 281
 MARY JOAN HASTY 281
 NICKOLAS HASTY 281
 CHERYL HATFIELD 32
 J. HATFIELD 32
 JOHN HATFIELD 32
 JEAN ELIZABETH HAWKINS 85
 ABBY HEACOCK 70
 AUDREY HEACOCK 70
 RONNIE HEACOCK 70
 SUE HEATER 121
 BARBRA HEATON 66
 BRENT HEATON 66
 BRIAN HEATON 66
 DAVID HEATON 66
 HUBERT HEATON 66
 KAY HEATON 66
 JOHN HEIDENBLUT 314
 PAT HEIDENBLUT 314
 ELSIE HEIL 71
 BEVERLY HELLER 248
 ALBERT HELLMICH 177
 ANN HELLMICH 177
 BERNARD HELLMICH 177
 CATHERINE HELLMICH 176,177
 DAVID HELLMICH 177
 DEIDRE HELLMICH 340
 DORA HELLMICH 177
 DOROTHY HELLMICH 340
 EDITH HELLMICH 177
 FRANK HELLMICH 166
 FREDA HELLMICH 177,177
 GLADYS HELLMICH 177
 HELEN HELLMICH 166
 HENRY HELLMICH 176,177
 JAMES HELLMICH 177
 JANET HELLMICH 177
 JARED HELLMICH 340
 JEANNE HELLMICH 177
 JO HELLMICH 177
 JOAN HELLMICH 177
 JOHN HELLMICH 177
 KATHERINE HELLMICH 177
 KENNETH HELLMICH 340
 LEO HELLMICH 177
 LEONA HELLMICH 177
 LOU HELLMICH 177
 MARY LOU HELLMICH 177
 MAURICE HELLMICH 177
 NAOMI HELLMICH 177
 PAULINE HELLMICH 177
 PHYLLIS HELLMICH 177
 RICHARD HELLMICH 177
 ROBERT HELLMICH 177
 SOUNDR A HELLMICH 177
 TOM HELLMICH 177
 VERONICA HELLMICH 166
 WILLIAM HELLMICH 177
 DICK HELMICH 197
 FRANK HELMICH 171
 HELEN HELMICH 171
 MARY LOU HELMICH 171
 PHYLLIS HELMICH 197
 VERONICA HELMICH 171
 ANNA MARY HEMBROCK 220
 CHERRY ((TWIG)) HEMENWAY 332
 NORA HENNINGER 296
 CARRIE HENRY 36
 MAGDELINA HENRY 36
 SEIBEL HENRY 36
 ANNA HERBERT 295
 BARBRA HERBERT 200,200
 EDGAR HERBERT 200
 ELSIE HERBERT 200
 FRANCIS HERBERT 277
 GUSTIE HERBERT 200
 HARRY HERBERT 200
 JOE HERBERT 200
 MARION HERBERT 200
 MATHIAS HERBERT 200,200
 WILL HERBERT 200
 CATHERINE HERMAN 118
 ELIZABETH HERMAN 201,203
 HENRY HERMAN 118
 LOUISE HERMAN 327
 MARY HERMAN 118
 OLIVIA HERMAN 293
 RAY HERMAN 326,327
 SUSANNA HERMAN 201
 BETTY HERMESCH 115
 BETTY ROSE HERMESCH 111
 CHARLES HERMESCH 111
 DONALD HERMESCH 106
 EDWIN HERMESCH 166
 HENRY HERMESCH 165
 HILDA HERMESCH 166
 JEANIE HERMESCH 106
 JOHN HERMESCH 165,166
 LEONA HERMESCH 166
 LINDA HERMESCH 166
 MARGARITA HERMESCH 166
 MARY HERMESCH 163,165,166

PHILOMENA HERMESCH 111
 ROSE HERMESCH 165
 SHARI HERMESCH 106
 VERONICA HERMESCH 165
 WILLIAM HERMESCH 163, 165
 DALE HEPHESCH 169
 (STISLEP) JOSEPH (MARIE) HESSLER 206
 ADAM HESSLER 237, 230, 239, 263, 303,
 304, 300, 220, 221, 221, 222, 224, 224, 225,
 226, 228, 229, 230, 231, 273, 299, 299, 300,
 306, 316, 331
 ADAM (ED) HESSLER 299, 321
 ADAM J. HESSLER 299, 299
 ADAM JOHN HESSLER 207, 227, 228, 229,
 236, 295, 296, 300, 321, 331
 ALBERT HESSLER 303, 308, 310, 229, 300,
 300, 305, 313, 315, 321
 ALICE HESSLER 227, 228
 ALOYSIOUS HESSLER 261, 266, 204, 290
 ALVIN HESSLER 295, 296
 ANDREAS HESSLER 221, 222, 223
 ANDREW HESSLER 238, 222, 228, 258, 295,
 299
 ANDREW ADAM HESSLER 316, 318, 321
 ANGELINE HESSLER 316, 316, 317
 ANN HESSLER 7
 ANNA HESSLER 8, 239, 222, 231, 235, 299
 ANNA MARIA HESSLER 207, 208, 212, 221,
 226, 227, 331
 ANNA MARIE HESSLER 330, 228, 323
 ANNA MARY HESSLER 223, 230, 321, 321,
 331
 ANNA MARIA HESSLER 222
 ANTHONY HESSLER 227
 APEALEA HESSLER 316
 AUGUST HESSLER 208, 209
 BARNEY HESSLER 228
 BARRY LEE HESSLER 209
 BERNARD HESSLER 227
 BERNICE HESSLER 265, 283, 288, 209
 BERTHA HESSLER 274, 275, 277
 BILL HESSLER 303, 308, 309, 310, 306,
 313, 314
 BRIAN HESSLER 305
 BRIGET HESSLER 227
 CARL HESSLER 303, 304, 300, 309, 310,
 207, 219, 229, 300, 300, 301, 306, 306, 313
 CAROL HESSLER 314
 CAROLYN HESSLER 289
 CARRIE HESSLER 229
 CATHERINE HESSLER 237, 238, 263, 302,
 302, 303, 308, 322, 322, 207, 221, 222, 227,
 228, 230, 231, 236, 260, 279, 295, 296, 299,
 300, 321, 331
 CATHERINE (STAHL) HESSLER 324
 CEAL HESSLER 97, 266, 288, 290
 CECILIA HESSLER 262, 263, 283, 283,
 309, 351, 261, 284, 284, 305
 CELIA HESSLER 221
 CHARLES HESSLER 2, 304, 207, 222, 224,
 227, 300, 306, 306, 315
 CHRIS HESSLER 110, 288, 290
 CHRISTIAN HESSLER 220
 CHRISTINA HESSLER 284
 CHRISTINE HESSLER 209, 262, 263, 265,
 351, 261, 266, 294
 CLARA HESSLER 239, 263, 265, 351, 231,
 261, 266, 275, 284, 287, 288, 290
 CLARENCE HESSLER 229, 321
 CONRAD HESSLER 235, 207, 208, 212, 220,
 221, 224, 226, 227, 229, 233, 234, 236
 CRESSIE HESSLER 316, 317
 CURTIS HESSLER 227
 CYNTHIA HESSLER 305
 DAVID HESSLER 265, 310, 288, 289
 DIANA HESSLER 305
 DOROTHY HESSLER 227
 EARL HESSLER 227
 EDWARD HESSLER 238, 221
 EDWARD (ADAM) HESSLER 239
 ELIZABETH HESSLER 220, 221, 227, 229
 ELSIE HESSLER 239, 228, 295, 296
 EMMY HESSLER 314
 ERNA HESSLER 213
 ETHEL MAY HESSLER 221
 EVA HESSLER 209, 213, 213, 223, 227
 EVA CATHERINE HESSLER 331
 FANNY AGNES HESSLER 228
 FLORENCE HESSLER 220, 231
 FRANCIS HESSLER 262, 263, 351, 222,
 228, 261, 266, 274, 277, 284, 288, 290
 FRANCIS (BUDD) HESSLER 97
 FRANK HESSLER 239, 221, 231, 260, 260,
 261, 277, 295, 348, 349
 FRANK J. HESSLER 94, 230, 262, 263,
 351, 266, 278, 279, 284, 286, 287, 288, 290,
 293, 294, 300, 301, 321, 338
 FRANK JOHN HESSLER 258
 FRANK AND MARY (RUTT) HESSLER 257
 FRANKLIN HESSLER 221
 FRANZ HESSLER 220, 221
 FELD HESSLER 228, 296
 FREDA HESSLER 308, 309, 310, 300, 315
 FREDERICK HESSLER 321
 GERHARD HESSLER 310
 GEORGE HESSLER 238, 221, 222, 228, 231,
 258, 314, 321, 328
 GEORGE (DOB) HESSLER 295, 296, 321
 GEORGE ADAM HESSLER 220
 GERHARD HESSLER 238, 239, 302, 303,
 207, 222, 227, 228, 230, 230, 231, 300, 301,
 303, 306, 311, 313, 315
 GERHART HESSLER 258, 321, 331
 GERTRUDE HESSLER 351, 261, 284, 288
 GERTRUDE (BOBBIE) HESSLER 262, 263,
 265, 266, 290, 292, 293
 GRACE HESSLER 227
 HARRY HESSLER 227
 HEINRICH HESSLER 213, 222
 HELEN HESSLER 239, 262, 259, 260, 261,
 266, 284, 336, 349
 HELMUT HESSLER 319
 HENRY HESSLER 220, 221, 222, 228, 229,
 250, 295, 296, 299, 321
 HILDA HESSLER 304, 309, 310, 306, 306,
 315
 HILDEGARDE HESSLER 261, 266, 284, 288,
 290
 IDA HESSLER 221, 228, 299
 ISOLDE HESSLER 213
 J. HESSLER 225
 JACOB HESSLER 209, 221
 JAMES HESSLER 221, 305, 305
 JANE HESSLER 304, 209, 213, 306
 JOHANN HESSLER 213, 221, 222, 223, 226
 JOHN HESSLER 235, 304, 207, 208, 209,
 220, 224, 224, 227, 228, 229, 230, 231, 258,
 295, 299, 306, 321, 321, 320, 331
 JOHN ADAM HESSLER 237
 JOHN FRANCIS HESSLER 227
 JOHN GERHARD HESSLER 306
 JOHN JOSEPH HESSLER 227
 JOSEPH HESSLER 239, 262, 263, 265, 283,
 351, 220, 221, 229, 261, 266, 284, 288, 288,
 289, 290, 301, 321
 JUDITH HESSLER 288, 289
 JUDY HESSLER 265
 JULIE ANN HESSLER 289
 KATHERINE HESSLER 305, 306, 316
 KATHRYN HESSLER 304, 306, 306, 306
 KATIE HESSLER 239, 304, 308, 309, 310,
 311, 313, 315
 KAY HESSLER 314
 KAZUKO HESSLER 313
 KENNETH HESSLER 288, 289
 KENNY HESSLER 265
 KONRAD HESSLER 223
 LAWRENCE HESSLER 261, 266, 284, 288,
 290
 LEO HESSLER 219, 321
 LESTER HESSLER 220, 295, 296
 LINDA HESSLER 221
 LISA HESSLER 305
 LORENZ HESSLER 219
 LOUIS HESSLER 227
 LOUISE HESSLER 227
 LYDIA HESSLER 300, 301
 MAE HESSLER 228
 MAGDELINA HESSLER 221, 229, 230, 231
 MARCELLA HESSLER 316, 317
 MARGA HESSLER 261
 MARGARET HESSLER 208, 221, 226, 229,
 233, 261, 261, 284, 331
 MARGARET AGNES HESSLER 266, 288, 290
 MARGARET MARY ((HELEN)) HESSLER
 SISTER 2, 288, 290, 306
 MARGARET MARY (HELEN) HESSLER 11
 0, 262, 263, 265, 351, 274, 275, 286, 286
 MARGARETA HESSLER 227
 MARGARETHA HESSLER 222
 MARIA HESSLER 221, 223, 223
 MARIETTA HESSLER 316, 317, 318
 MARYLYN HESSLER 313, 314
 MARJORIE HESSLER 275, 276, 277
 MARK HESSLER 303, 304, 305, 306
 MARTHA HESSLER 314
 MARY HESSLER 3, 7, 8, 23, 100, 110, 138,
 238, 239, 243, 245, 262, 263, 265, 283, 351,
 155, 207, 220, 220, 229, 238, 258, 261, 266,
 266, 277, 278, 284, 288, 290, 294
 MARY (RUTT) HESSLER 09, 270, 279, 284,
 286, 288, 290, 293, 348
 MARY A. HESSLER 94
 MARY ANN HESSLER 265, 288, 289
 MARY ANNA HESSLER 237, 238
 MARY CECILIA HESSLER 261
 MARY J. HESSLER 287
 MARY ANN HESSLER 236
 MATILDA HESSLER 97, 262, 263, 283, 351,
 259, 261, 266, 279, 280, 282, 284, 288, 290
 MAUDE HESSLER 221
 MAYME HESSLER 315
 MELINDA HESSLER 221
 MELODY HESSLER 305
 MYRTLE DIA HESSLER 305
 NICHOLAS HESSLER 222
 OLIVER HESSLER 221
 PEARL HESSLER 227
 PETER HESSLER 220, 220
 PHILIP HESSLER 221
 PHILOMENA HESSLER 262, 263, 351, 261,
 266, 269, 270, 284, 288, 290
 RALPH HESSLER 229
 RAYMOND HESSLER 303, 303, 310, 300,
 301, 305
 RICK HESSLER 305
 ROBERT HESSLER 227, 288, 289
 ROSA HESSLER 229
 ROSE HESSLER 100, 262, 263, 265, 283,
 351, 227, 261, 266, 284, 286, 288, 290, 295,
 296
 ROSEMARY HESSLER 308, 309, 310, 313,
 314
 ROSIE HESSLER 221, 228
 ROSINA HESSLER 230, 231
 RUTH HESSLER 228
 RUTH CATHERINE HESSLER 227
 SHIRLEY HESSLER 305, 306
 SISTER GRETCHEN ((ALICE)) HESSLER
 228
 SUE HESSLER 289
 SUSANNA HESSLER 214, 214, 212, 222
 SYLVESTER HESSLER 227
 THELMA HESSLER 239, 228, 295, 296
 THERESA HESSLER 304, 308, 310, 274,
 277, 300, 306, 311
 TODDLES HESSLER 314
 URBAN HESSLER 231
 VIOLA HESSLER 228, 295, 296
 WALTER HESSLER 227, 306
 WERNER HESSLER 217, 217, 213, 219
 WILLIAM HESSLER 300, 220, 221, 227,
 231, 300, 301, 305
 WILLIAM GERHARD HESSLER 313
 BARBARA HICKMAN 333
 BRENT HICKMAN 333
 DEDORAH HICKMAN 333
 HELEN HICKMAN 333
 MARK HICKMAN 333
 TAMARA HICKMAN 333
 THOMAS HICKMAN 333
 JOHN P. HILL 177

JOYCE HILL 8
 SOUNDR HILL 177
 ANNA (ROBER) HILLEFORD 163
 JENNIFER HINDMAN 289
 KARYN HINDMAN 289
 MARY ANN HINDMAN 289
 NEIL C. HINDMAN 289
 SUSANNE HINDMAN 289
 TRICIA HINDMAN 289
 MARGARET HITCHINGS 266, 267, 270, 272
 PETER HITTEL 13
 MARTIN P. HITTEL 158
 NATHANEIL PAGE HITTEL 158
 TRACY HITTEL 158
 TRENDIA JO HITTEL 158
 ELIZABETH HOARSON 231
 BEFYL HOATSON 231
 DIANA HOBBS 121
 DANNY HOBBS 152
 MARY JEAN HOBBS 152
 FRANCIS HODAPP 229
 JEREMY HODGES 285
 PAUL HODGES 285
 TRACY HODGES 285
 MATTIE HODGSON 70
 AGNES HOEING 292
 BARBARA HOEING 169
 DALE HOEING 169
 HELEN HOEING 289
 JOSEPH HOEING 292
 MARIEDA CATHERINE HOEING 292
 MARILYN HOEING 39
 MAURICE HOEING 169, 171
 NANCY HOEING 169
 RANDY HOEING 39
 RONALD HOEING 169
 ROSELYN HOEING 169
 THERESA HOEING 39
 WAYNE HOEING 169
 ESTHER HOFFMAN 83, 83
 EVELYN (RIES) HOFFMAN 86
 EVELYN MARIE HOFFMAN 83
 FRANK HOFFMAN 83
 JACK HOFFMAN 83
 JEFFREY THOMAS HOFFMAN 83
 JILLIAN HOFFMAN 84
 JOHN F. HOFFMAN 83
 SHARON MARIE HOFFMAN 83, 83
 STEVEN MICHAEL HOFFMAN 83
 DELOKAS HOGS 294
 ESTELLA HOLDREITH 231
 DIANE HOLLAND 47, 51
 AMANDA HOLMS 7
 CHERYL HOLT 287
 JOHN G. HOLTEL 3
 THERESA HOLTEL 13
 MARY GERTRUDE HOLTHAUS 20
 BARBARA HOLTKAMP 171
 BILL HOLTKAMP 171
 CHARLES HOLTKAMP 171
 DAVID HOLTKAMP 171
 DENNIS HOLTKAMP 171
 ELLA HOLTKAMP 171
 ELLA MAE HOLTKAMP 166
 HOLLY HOLTKAMP 171
 JOYCE HOLTKAMP 171
 LEDNARD HOLTKAMP 166, 171
 LORETTA HOLTKAMP 166, 171
 MAURICE HOLTKAMP 171
 MAURICE JOHN HOLTKAMP 166
 MICHAEL HOLTKAMP 171
 PATRICIA HOLTKAMP 171
 PAUL HOLTKAMP 171
 PAULINE HOLTKAMP 171
 RAY HOLTKAMP 171
 RAYMOND HOLTKAMP 166
 ROBERT HOLTKAMP 166, 171
 WALTER HOLTKAMP 166, 171
 WILLIAM HOLTKAMP 171
 WILLIAM HOLTKAMP 166
 KATHY HOLTZER 317
 DRYAN HOOTEN 285
 CHRIS HOOTEN 285
 MONICA HOOTEN 285
 BARBARA HOOVER 333
 MARY HORNBIACH 106
 AARIN HORNBERGER 198
 BILL HORNBERGER 198
 CHRISTINA HORNBERGER 198
 ROBIN HORNBERGER 198
 JOHANN HORNICK 222, 223
 MARIA HORNICK 222, 223
 LISA HORTEMILLER 169
 BROCK HOUSEHOLDER 268
 HEATH HOUSEHOLDER 268
 JEAN HOUSEHOLDER 268
 WARREN HOUSEHOLDER 268
 LORETTA HOWARD 333
 BARBARA HOWSE 285
 BRET HOWSE 285
 DAMIEN HOWSE 285
 SARAH HOWSE 285
 CHERYL HUYI 291
 ANTHONY HUDOK 39
 CHERYL HUDOR 39
 CRAIG HUBOR 39
 CYNTHIA HUBOR 39
 JUDY HUBOR 39
 JUSTIN HUBOR 39
 NATASHA HUBOR 39
 RHODA HUBOR 39
 ROBERT HUBOR 39
 THEODORE HUBOR 39
 LARRY HUDGEN 196
 SONORA HUDGEN 36
 LAURA HUES 197
 DARLENE HUFF 154
 DIANE HUFF 171
 KEN HUFF 171
 MARY (HOFF) HUFF 221
 MARY ANNA HUFF 200, 202
 ANNA MARIA HUGAL 201
 DALTHASER HUGAL 231
 CHRISTINA HUGAL 201
 JOHN HUGAL 231
 JOSEPH HUGAL 201
 LEWIS HUGAL HUGAL 201
 LEWIS WILLIAM HUGAL 201
 MAGDELINA HUGAL 201, 231
 MARY HUGAL 231
 MARY CHRISTINA HUGAL 201
 KARYN HUME 289
 MARK HUME 289
 MARY (KOETTER) HUMPERT 171
 ROBERTO HUNG 273
 GLEN HUNGATE 203
 MARTHA HUNGATE 203
 ANNETTE HUNGER 311, 312
 GARY HUNGER 311, 312
 MARY (KOETTER) HUPERT 163
 ANNA HUSER 167
 JOE HUSER 163, 167
 JOHN HUSER 167
 JOSEPH HUSER 168
 ALBERT HUSSKE 280, 281
 CHRISTOPHER HUSSKE 280
 DENISE HUSSKE 280, 281
 KATHLEEN HUSSKE 280, 281
 LUANN HUSSKE 280, 281
 MARY HUSSKE 280, 281
 MARY AGNES HUSSKE 280, 281
 MARY JOAN HUSSKE 281
 PATRICIA HUSSKE 280, 281
 RICHARD HUSSKE 280, 281
 GEORGE HUTCHINSON 70
 MARY HUTCHINSON 70
 AMILIA HUTH 10
 ANNA HUTH 8, 24, 27, 37, 41, 42, 46, 56, 172
 ANNA MARY HUTH 7
 BERTHA HUTH 17
 CARL ELMER HUTH 17, 17
 DOMINO HUTH 46
 ELDON HUTH 17
 FRANK ALPHONSE HUTH 17, 17
 HOWARD HUTH 17, 17
 JOHN PETER HUTH 17, 17
 MARGARET HUTH 22
 MARY HUTH 7
 PETER HUTH 7, 17, 17, 223
 PETER JR. HUTH 17
 PETER JUNIOR HUTH 17
 PHILOMENA HUTH 17
 PHILOMENA HUTH 17
 THELMA HUTH 17, 17
 VERONICA HUTH 17, 46
 BRYAN IFON 46
 EDDIE IFON 46
 GARY IFON 46
 JANICE IFON 46
 SHAWN IFON 46
 NITZI ILDEWINE 297
 CLAUD TAYLOR ISAACS 151
 THELMA CATHERINE (STARLEY) ISAKS 151
 CECIL ISON 73
 DELMUN ISON 73
 EVERETT ISON 73
 GENEA ISON 73
 JUDITH ISON 73
 KATHY ISON 73
 SHEYLEA ISON 73
 DARLENE JANTE 266, 270
 HENRY JANTE 270
 LOUISE JANTE 270
 JERE JASIN 284
 JANET JEFFERY 332
 KRISTINE JENSEN 273
 SCOTT JENSEN 273
 GEORGE JESEL 227
 ELSIE JESSUP 333
 CHARLES JEWELL 74
 DOROTHY JEWELL 63, 63
 DOROTHY (DWENGER) JEWELL 75
 DOROTHY DWENGER JEWELL 74
 JOYCE ANN JEWELL 74, 75
 MATTHEW CHARLES JEWELL 75
 MICHAEL JEWELL 75
 MICHAEL WAYNE JEWELL 74
 MICHAEL WAYNE II JEWELL 75
 CAROLYN JOHANNIGMAN 341
 JAMIE ANN JOHANNIGMAN 341
 JANE ANN JOHANNIGMAN 341
 JEAN ANN JOHANNIGMAN 341
 JOAN CECILIA JOHANNIGMAN 341
 JULIE ANN JOHANNIGMAN 341
 KAREN ANN JOHANNIGMAN 341
 MARK JUSTIN JOHANNIGMAN 341
 MARY EVELYN JOHANNIGMAN 341
 PAUL JOHANNIGMAN 34, 341
 SUSAN MARY JOHANNIGMAN 341
 THOMAS JUSTIN JOHANNIGMAN 341
 AARON JOHANNIGMAN 340
 ABIGAIL JOHANNIGMAN 340
 BRADLY JOHANNIGMAN 340
 CATHERINE JOHANNIGMAN 340
 CECILIA JOHANNIGMAN 262, 262, 338
 CHARLES JOHANNIGMAN 340, 340
 CHERYL JOHANNIGMAN 340
 CHRISTIAN JOHANNIGMAN 340
 CYNTHIA JOHANNIGMAN 340
 DARLENE JOHANNIGMAN 340
 DONNA MARIE JOHANNIGMAN 340
 DOROTHY JOHANNIGMAN 340
 EDWARD JOHANNIGMAN 340
 ELIZABETH JOHANNIGMAN 340
 EMILY JOHANNIGMAN 340
 J. JOHANNIGMAN 225
 JANET JOHANNIGMAN 340
 JOHN JOHANNIGMAN 340
 JUNE JOHANNIGMAN 340
 KELLY JOHANNIGMAN 340
 LAURIE JOHANNIGMAN 340
 LEANNA JOHANNIGMAN 340
 LISA JOHANNIGMAN 340
 MARGARET JOHANNIGMAN 340
 MARILYN JOHANNIGMAN 340
 MARJORIE JOHANNIGMAN 340
 MARY CECILIA JOHANNIGMAN 340
 MARY ELIZABETH JOHANNIGMAN 10
 MATTHIAS JOHANNIGMAN 338, 340
 NATHAN JOHANNIGMAN 340

ROBERT JOHANNINGMAN 340
 ROMAN JOHANNINGMAN 340
 STEVE JOHANNINGMAN 7
 TRENT JOHANNINGMAN 340
 URBAN JOHANNINGMAN 340
 ROBERT JOHN 11,11,11,175
 JULIE JOHNSON 73
 MICHAEL JOHNSON 169
 AMANDA JONES 333
 CANDANCE JONES 271
 CHRISTINA JONES 271
 EDITH JONES 177
 JAMES JONES 271
 RYAN JONES 333
 SHERYL JONES 271
 TONI JONES 333
 WILLIAM JONES 333
 ANNA BARBRA JUNG 222
 HEINRICH JUNG 222
 EITHA KABAGE 271
 JOSEPH KABAGE 271
 LAURA MAE KABAGE 266
 HELENA CATHERINE KAISLER 336
 STEVE KAISER 18
 CATHERINE KALB 313
 CLARENCE KALB 308
 FLORENCE KALB 308
 GEORGE KALB 313
 ROSEMARY KALB 308,313
 JANE KANABLE 333
 CHARLES F. KAPPES 165
 VERONICA KAPPES 165
 ANNA MARY KEALY 330
 CAROLINE KEELEY 54
 ETHEL KEIHN 152
 DANIELL KEILLOR 285
 JULIE KEILLOR 285
 THOMAS KEILLOR 285
 SHIPLEY KELL 332
 FERDINAND KELLER 231
 MARY KELLER 231
 BARBRA KELLY 198
 SHIRLEY KEMP 272
 LILLY KEMPER 227
 LOUISE (DICKMAN) KEMPER 227
 DANA KENCER 45
 CLARA KENNETH 166
 ANNA MARY KERBY 329
 ANNA MARY KERBY 329
 CATHERINE KERBY 329
 JAMES KERBY 328,329
 JOSEPH KERBY 329
 MICHAEL KERBY 329
 AGNES KERN 333
 CHARLES KERN 333
 DAVID KERN 333
 GINA KERN 333
 HERMAN KERN 333
 CLIFFORD KERSKEN 193
 ROSE KERSKEN 193
 CAROLYN KERSKER 7,36,196
 CLIFF KERSKER 7,36
 CLIFFORD KERSKER 196
 LINDA KERSKER 7,36,196
 ROSEMARY KERSKER 7,36,196
 SANDRA KERSKER 7
 SONDRA KERSKER 36,196
 ELVIRA KILGENSTEIN 219
 MELANIE KINE 317
 MARCELLA KINDEL 326
 STANLEY KINDEL 326
 MARCELLA KINDELL 327
 STANLEY KINDELL 327
 NANCY KINKER 169
 JOYCE KINN 54
 KAITLAN KINN 53,54
 PATRICK KINN 54
 TANARA KINN 54
 TAMMY KINN 53
 TIMOTHY KINN 54
 ANNA MARIE KINNEY 333
 CHARLES KINNEY 333
 CHRISTINE KINNEY 333
 DAVID KINNEY 333
 GEORGE KINNEY 333
 HENRY KINNEY 333
 JARED NATHAN KINNEY 332
 JILL KINNEY 332
 LAVINA KINNEY 330
 LUCILLE KINNEY 331
 MARJORIE KINNEY 333
 MARTHA KINNEY 333
 MARY KINNEY 333
 MARY LILLIE KINNEY 333
 RACHEL KINNEY 333
 RACHEL MARTHA KINNEY 332
 RICHARD KINNEY 333
 ROBERT KINNEY 333
 ROBERT JOSEPH KINNEY 332
 WILLIAM F. KINNEY 333
 BRINDA KIPPER 298
 DAVID KIPPER 298
 DONALD KIPPER 298
 JAMES KIPPER 108
 JANET KIPPER 108
 JENNIFER KIPPER 100
 MARGARET KIPPER 296,298
 ROSE KIPPER 298
 SHAWN KIPPER 298
 WILLIAM JOSEPH KIPPER 298
 ANNA MARY KIRBY 330
 BRUCE KIRKPATRICK 65
 LINDA KIRKPATRICK 65
 CAROLYN KIRSCHNER 8,24
 CLIFF KIRSCHNER 8
 LINDA KIRSCHNER 8,24
 ROSEMARY KIRSCHNER 24
 SANDRA KIRSCHNER 8,24
 ELIZABETH KLEINE 52,52
 VERONICA KLEINFELDER 46
 DELORES KLENE 65
 LUCILLE WILLA KLHE 328
 HAROLD KLOSTERKEMPR 166
 HELEN MARIE KLOSTERKEMPR 166
 ROSA KLOSTERKEMPR 287
 HELEN KLOSTERKEMPR 171
 HERALD KLOSTERKEMPR 171
 MARY KLOSTERKEMPR 171
 KAY KNARR 39
 CATHRY KNOBBE 19
 DEBBIE KNOBBE 19
 ED KNOBBE 19
 GARY KNOBBE 19
 JOHN KNOBBE 19
 MATILDA KNOBBE 17
 MATT KNOBBE 17
 NANCY KNOBBE 19
 NORMAN KNOBBE 19
 TIM KNOBBE 19
 DORA KNUEVEN 176
 MOLLY KNUEVEN 176
 AL KOCH 194
 ELSIE KOCH 194
 VERA KOCH 194
 MARY KOEHNE 167
 ELEANOR KOETTER 51
 MARY KOETTER 163
 ALMA KOILMAN 339
 ADELE MARIE KOHMECHER 344
 ADOLPH VINCENT KOHMECHER 344
 BONITA S. KOHMECHER 344
 CAROL A. KOHMECHER 344
 DIANE C. KOHMECHER 344
 GREGORY H. KOHMECHER 344
 JOAN MARY KOHMECHER 344
 JUDITH M. KOHMECHER 344
 PAUL H. KOHMECHER 344
 ANN MARGARET KOHN 184
 KATHY KOHRMAN 123
 MARY ANN KOHRMAN 279
 JAN KULODZEJEJ 314
 ADOLPH VINCENT KOMESCHER 338
 LORETTA KOMESCHER 338
 DOROTHY KOOR 10
 ALVIN KOORS 203
 B.H. KOORS 225
 BECKY KOORS 203
 BOBBIE KOORS 2
 BOBBY KOORS 157
 BRADLY KOORS 292
 BRENDA KOORS 292
 BRIAN KOORS 293
 CARL KOORS 265,290,293
 CATHERINE KOORS 201
 CHRISTOPHER KOORS 291
 CLEM KOORS 265,290,292,293
 CLETUS KOORS 292
 CRAIG KOORS 157,156
 CYNTHIA KOORS 340
 DALE KOORS 39
 DARYL KOORS 292
 DAVID KOORS 290
 DAVID ALLEN KOORS 292
 DEBBIE KOORS 203
 DONALD KOORS 265,290,291
 DORIS KOORS 203
 GERALDINE KOORS 291
 GERTRUDE (BOBBIE) KOORS 265,290,291
 HERBERT KOORS 203
 JAMES KOORS 265,290,292
 JANNICE KOORS 293
 JEFF KOORS 203
 JENNIFER KOORS 157,156
 JERRY KOORS 203
 JOHN KOORS 201
 JOSEPH KOORS 290,291
 JULIA KOORS 293
 JULIANNE KOORS 291
 KAREN KOORS 157,156,292
 KATHLEEN KOORS 291
 KEVIN KOORS 292
 KRISTEN KOORS 157,156,156
 KYLE DONALD KOORS 292
 LAWRENCE KOORS 39
 LOUIS KOORS 265,290,292
 MARIETA KOORS 292
 MARY KOORS 290,293
 MICHAEL KOORS 292
 MICHAEL (CHARLIE) KOORS 248
 MILDRED KOORS 203
 PATRICIA KOORS 291
 PAUL KOORS 290
 RICHARD KOORS 203
 RICKY KOORS 292
 RITA KOORS 292
 ROBERT KOORS 156
 ROGER EDWARD KOORS 156
 ROSE MARIE KOORS 292
 ROSEMARY KOORS 39
 RYAN KOORS 292
 SHEILA KOORS 292
 SHERRY KOORS 292
 SHIRLEY KOORS 292
 SUSAN KOORS 39
 SYLVESTER KOORS 290
 TERESA KOORS 291
 TOM KOORS 203
 VIRGINIA KOORS 292
 ALEXANDER KOTICHAS 306
 LORETTA KOTICHAS 306
 NICHOLAS KOTICHAS 306
 HERMAN KOTTER 200,201,201
 DAVID KRAMAN 314
 DONALD KRAMAN 314
 JUDITH KRAMAN 314
 MADELAINE KRAMAN 314
 MICHAEL KRAMAN 314
 ROSEMARY KRAMAN 314
 TAMMY KRAMAN 314
 CLARA KRAMER 43
 MARY ANN KRAMER 32,33
 RITA KRAMER 18
 RAY KRIECH 17
 WILLIAM KRINS 329
 CARL KROEGER 274
 HENRY KRONE 167
 ANGIE KRONER 46
 BILL KRONER 46
 BRYAN KRONER 46
 DAVID KRONER 46
 EMMA KRONER 46
 MICHAEL KRONER 46