

INSTRUCTION MANUAL FOR

BLUED &
STAINLESS
STEEL



CALIBER
.457 Round Ball
Black Powder Only

RUGER® OLD ARMY® “CAP & BALL” BLACK POWDER PERCUSSION REVOLVER



FIXED AND ADJUSTABLE
SIGHT MODELS



**READ THE INSTRUCTIONS AND
WARNINGS IN THIS MANUAL CAREFULLY
BEFORE USING THIS FIREARM**

**For Product Service on this Model Please Call:
(603) 865-2442 (See p. 28)**

THIS INSTRUCTION MANUAL SHOULD ALWAYS ACCOMPANY THIS FIREARM AND BE
TRANSFERRED WITH IT UPON CHANGE OF OWNERSHIP, OR WHEN THE FIREARM IS LOANED OR
PRESENTED TO ANOTHER PERSON.

**CB & KCB/3-09
R11**

State-By-State Warnings

Certain states require by law that their own specified warning notices in larger-than-normal type be conspicuously included by the manufacturer, distributor, or retail dealer with firearms sold in that state. Sturm, Ruger sells its products in compliance with applicable laws and regulations. Because our products may be sold in these states, we include the following:

California:

⚠ WARNING

“Children are attracted to and can operate firearms that can cause severe injuries or death. Prevent child access by always keeping guns locked away and unloaded when not in use. If you keep a loaded firearm where a child obtains and improperly uses it, you may be fined or sent to prison.”

⚠ ADVERTENCIA

“A los niños los atraen las armas de fuego y las pueden hacer funcionar. Ellos pueden causarse lesiones graves y la muerte. Evite que los niños tengan acceso a las armas de fuego guardándolas siempre con llave y descargadas cuando no las esté utilizando. Si usted tiene un arma de fuego cargada en un lugar en que un niño tiene acceso a ella y la usa indebidamente, le pueden dar una multa o enviarlo a la cárcel.”

Connecticut:

“UNLAWFUL STORAGE OF A LOADED FIREARM MAY RESULT IN IMPRISONMENT OR FINE.”

Florida:

“IT IS UNLAWFUL, AND PUNISHABLE BY IMPRISONMENT AND FINE, FOR ANY ADULT TO STORE OR LEAVE A FIREARM IN ANY PLACE WITHIN THE REACH OR EASY ACCESS OF A MINOR UNDER 18 YEARS OF AGE OR TO KNOWINGLY SELL OR OTHERWISE TRANSFER OWNERSHIP OR POSSESSION OF A FIREARM TO A MINOR OR A PERSON OF UNSOUND MIND.”

Maine:

“ENDANGERING THE WELFARE OF A CHILD IS A CRIME. IF YOU LEAVE A FIREARM AND AMMUNITION WITHIN EASY ACCESS OF A CHILD, YOU MAY BE SUBJECT TO FINE, IMPRISONMENT OR BOTH. KEEP FIREARMS AND AMMUNITION SEPARATE. KEEP FIREARMS AND AMMUNITION LOCKED UP. USE TRIGGER LOCKS.”

Maryland:

“WARNING: Children can operate firearms which may cause death or serious injury. It is a crime to store or leave a loaded firearm in any location where an individual knew or should have known that an unsupervised minor would gain access to the firearm. Store your firearm responsibly!”

Massachusetts:

“WARNING FROM THE MASSACHUSETTS ATTORNEY GENERAL: This handgun is not equipped with a device that fully blocks use by unauthorized users. More than 200,000 firearms like this one are stolen from their owners every year in the United States. In addition, there are more than a thousand suicides each year by younger children and teenagers who get access to firearms. Hundreds more die from accidental discharge. It is likely that many more children sustain serious wounds, or inflict such wounds accidentally on others. In order to limit the chance of such misuse, it is imperative that you keep this weapon locked in a secure place and take other steps necessary to limit the possibility of theft or accident. Failure to take reasonable preventive steps may result in innocent lives being lost, and in some circumstances may result in your liability for these deaths.”

“IT IS UNLAWFUL TO STORE OR KEEP A FIREARM, RIFLE, SHOTGUN OR MACHINE GUN IN ANY PLACE UNLESS THAT WEAPON IS EQUIPPED WITH A TAMPER-RESISTANT SAFETY DEVICE OR IS STORED OR KEPT IN A SECURELY LOCKED CONTAINER.”

New Jersey:

“IT IS A CRIMINAL OFFENSE TO LEAVE A LOADED FIREARM WITHIN EASY ACCESS OF A MINOR.”

New York City:

“THE USE OF A LOCKING DEVICE OR SAFETY LOCK IS ONLY ONE ASPECT OF RESPONSIBLE FIREARM STORAGE. FOR INCREASED SAFETY, FIREARMS SHOULD BE STORED UNLOADED AND LOCKED IN A LOCATION THAT IS BOTH SEPARATE FROM THEIR AMMUNITION AND INACCESSIBLE TO CHILDREN AND OTHER UNAUTHORIZED PERSONS.”

North Carolina:

“IT IS UNLAWFUL TO STORE OR LEAVE A FIREARM THAT CAN BE DISCHARGED IN A MANNER THAT A REASONABLE PERSON SHOULD KNOW IS ACCESSIBLE TO A MINOR.”

Texas:

“IT IS UNLAWFUL TO STORE, TRANSPORT, OR ABANDON AN UNSECURED FIREARM IN A PLACE WHERE CHILDREN ARE LIKELY TO BE AND CAN OBTAIN ACCESS TO THE FIREARM.”

Wisconsin:

“IF YOU LEAVE A LOADED FIREARM WITHIN THE REACH OR EASY ACCESS OF A CHILD YOU MAY BE FINED OR IMPRISONED OR BOTH IF THE CHILD IMPROPERLY DISCHARGES, POSSESSES, OR EXHIBITS THE FIREARM.”

* * * * *

Please check with your licensed retailer or state police for additional warnings which may be required by local law or regulation. Such regulations change constantly, and local authorities are in the best position to advise you on such legal matters.

LOCKING DEVICE INSTALLATION INSTRUCTIONS



WARNING – USE OF LOCKING DEVICES



- Always keep your firearm pointed in a safe direction, including when you are installing or removing your locking device.
- Always verify that your firearm is completely **unloaded** before installing your locking device.
- Do **not** install locking devices in the trigger guard; always keep your fingers and locking device outside the trigger guard during device installation and removal.
- Store firearms, ammunition and keys separately and securely, away from children and careless adults; do **not** store your firearm with the keys in the locking device.
- Do not attempt to work the action of your firearm with the locking device in place; this may damage your firearm.
- While locking devices are an important aid to security measures, they are not a substitute for safe firearm handling and proper storage. Remember that any mechanical device can be bypassed with enough time, knowledge, determination and equipment.

**LOCKING DEVICES MUST BE USED
SAFELY AND RESPONSIBLY**

Use the Correct Lock: While the basic locking device is substantially similar for all Ruger firearms, due to the different shapes of the many Ruger firearms, some firearms utilize different locking devices. The 1 1/2" lock is for use with **RUGER® OLD ARMY®** Revolvers. **It is very important to use the correct locking device!**

To Install the Factory-Supplied Locking Device:

1. **Keep the muzzle pointed in a safe direction and your fingers outside the trigger guard at all times!**
2. **Be sure the firearm and its cylinder are completely unloaded and contain no cartridges or cartridge cases!**

3. Completely remove the cylinder. (See “To Remove Cylinder,” page 20.)
4. Apply the lock by placing the shackle of the lock onto your firearm as shown below.
5. Close the lock by pressing the shackle into the body of the lock (the part that receives the key) as tightly together as possible. The lock has bumpers and the shackle is coated with a non-marring material that will not harm the metal finish of your firearm; be careful not to dent or scratch wooden grips.
6. Once the lock is securely closed, remove the key and pull firmly on the lock to test the connection and be sure it is locked. **Do not leave or store your firearm with the key in the lock!** Store your locked unloaded firearm and the key in secure, separate locations, away from ammunition, children, or unauthorized adults.

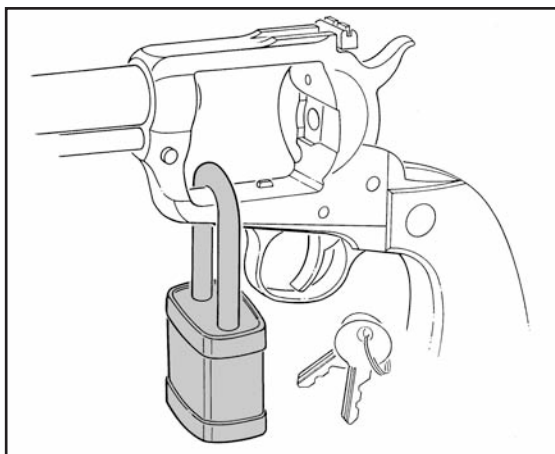

*Correct Installation of Lock
For Ruger Old Army® Revolvers Only*

FIREARMS SAFETY-YOUR RESPONSIBILITY
SAFETY MUST BE THE FIRST AND CONSTANT
CONSIDERATION OF EVERY PERSON WHO HANDLES
FIREARMS AND AMMUNITION.

This Instruction Manual is designed to assist you in learning how to use and care for your **RUGER® OLD ARMY®** percussion revolver properly. Please contact us if you have any questions about it.

Only when you are certain you fully understand the Manual and can properly carry out its instructions should you practice loading, unloading, etc. with live powder, ball and caps. If you have any doubts about your ability to handle or use a particular type of gun safely, then you should seek supervised instruction.

Such personalized instruction is often available from gun dealers, gun clubs or police departments. If none of these sources can help you, write to the National Rifle Association, Training Division, Washington D.C. 20036. They will assist you.

The person possessing a gun has a full-time job. You cannot guess; you cannot forget. You must know how to use your firearm safely. **Do not use any firearm without having a complete understanding of its particular characteristics and safe use.**

Remember: There is no such thing as a foolproof gun.

TABLE OF CONTENTS

	Page
State-By-State Warnings	2
Locking Device Installation Instructions	5
General Information and Mechanical Characteristics	8
Ammunition	10
Powder Charge	11
Percussion Caps	12
Eye and Ear Protection	12
To Load and Fire	13
To Uncock (Decock) The Revolver	18
To Unload	19
To Remove Cylinder	20
Disassembly	22
Reassembly	23
To Clear a Malfunction ("Jam")	23
Care and Cleaning	24
Storage	25
Care of Stainless Steel Revolvers	26
Sights	27
Service and Parts Policy	28
Shipping Firearms For Repair	28
Ordering Parts	29
Parts List	31 - 33
Parts Drawing	34
The Basic Rules of Safe Firearms Handling	35 - 38
Warranty Information	40

"RUGER" and "Old Army" are registered U.S. trademarks.



WARNINGS OF GREAT IMPORTANCE ARE FOUND ON THE FOLLOWING PAGES:

Locking Device	5	Cocked Gun	16
Alterations	8	Indexing	17
Lead Exposure	10	Firing	17
Black Powder	11	Disassembly	22
Ammunition	11	Lubrication	25
Capped Cylinders	12	Storage	26
Muzzle Direction	13	Shipping	28
Handling	16	Parts Purchasers	29

OTHER CAUTIONS AND WARNINGS APPEAR THROUGHOUT THE MANUAL.

**FIREARMS ARE DANGEROUS WEAPONS—
READ THE INSTRUCTIONS AND WARNINGS IN THIS
MANUAL THOROUGHLY AND CAREFULLY BEFORE USING.**



WARNING—ALTERATIONS



This product was designed to function properly in its original condition. Alterations can make it unsafe. Do not alter any part or add or substitute parts or accessories not made by Sturm, Ruger & Co. Inc.

DO NOT ALTER ANY GUN

GENERAL INFORMATION AND MECHANICAL CHARACTERISTICS

The **RUGER® OLD ARMY®** percussion revolver is an original Ruger design and is manufactured to our regular standards of strength and reliability, entirely in modern Ruger factories in the U.S.A. The best quality steels and coil springs are used throughout, the same as in our centerfire cartridge revolvers. Stainless steel nipples are standard and grip panels are genuine American Walnut.

The mechanism of the “Old Army” has been carefully designed to retain traditional handling and firing characteristics of the old-time “cap and ball” revolvers while at the same time incorporating improvements (U.S. and Foreign Patents) which mark the first significant advance in percussion revolver construction in more than a century.

The **RUGER® OLD ARMY®** is a muzzle loading, percussion revolver intended for use with black powder, percussion caps, and soft lead projectiles. It does not fire conventional cartridges, but is instead loaded from the front of the cylinder. It is of single-action operation, and the hammer must manually be cocked before normally firing the revolver.

Like any such revolver, it is to be used with **Black Powder only**, and its safe use requires that the shooter be thoroughly familiar with its characteristics.

The mechanism of the **RUGER® OLD ARMY®** provides for security against accidental discharge when properly handled. As with any other firearm, however, the “Old Army” must be used with strict attention to correct safety practices. In addition, the revolver should be inspected frequently to assure that it is working properly.

NOMENCLATURE

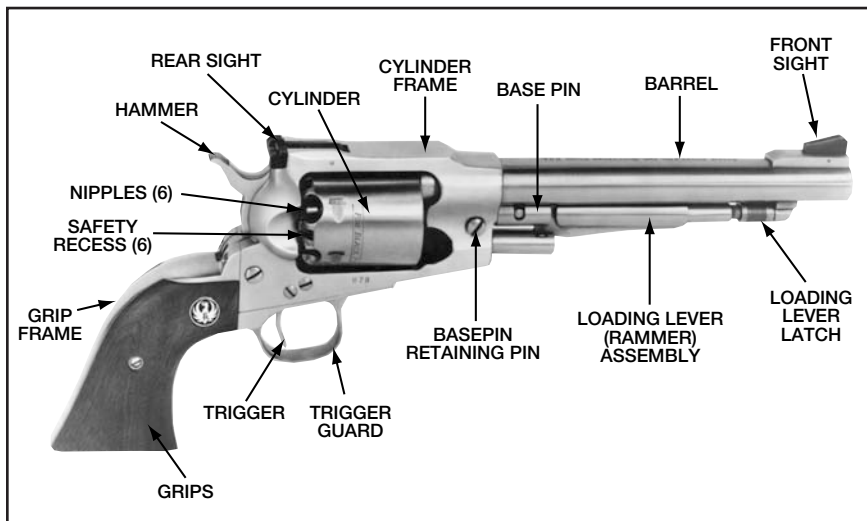



Parts referred to frequently are indicated by arrows.

AMMUNITION

The “Old Army” is a muzzle loading, percussion revolver intended solely for use with Black Powder. **It should never, under any circumstances, be loaded with any type of smokeless powder as the result could be damage to the revolver and injury to the shooter or bystanders.** Black Powder is usually classified by powder grain size, with “Fg” being the largest granulation and “FFFFg” being the smallest granulation normally available. Any granulation within these gradations could be used in the “Old Army”; normally, however, “FFFg” is the preferred grain size. Replica black powder such as Pyrodex may be used, so long as suggested loading data is strictly adhered to.

The “Old Army” is designed to use a .457” diameter round ball or .454” conical bullet of pure lead. Bullets of either type can be purchased from your dealer, ready to use, or can easily be cast at home with a small investment in equipment. Information on bullet casting is available from the manufacturers of moulds and casting equipment and from various authoritative handbooks. Your dealer should be able to provide you with any equipment which you may require. (See “Warning - Lead Exposure,” below.) The use of jacketed or alloy bullets is not recommended as accuracy is generally not as satisfactory as with the pure lead bullets.

 WARNING—LEAD EXPOSURE	
	Discharging firearms in poorly ventilated areas, cleaning firearms, or handling ammunition may result in exposure to lead and other substances known to the state of California to cause birth defects, reproductive harm, and other serious physical injury. Have adequate ventilation at all times. Wash hands thoroughly after exposure.
	SHOOTING OR CLEANING GUNS MAY EXPOSE YOU TO LEAD

AMMUNITION NOTICE



WE SPECIFICALLY DISCLAIM RESPONSIBILITY FOR ANY DAMAGE OR INJURY WHATSOEVER OCCURRING IN CONNECTION WITH, OR AS THE RESULT OF, THE USE IN RUGER REVOLVERS OF FAULTY, OR NONSTANDARD, OR “REMANUFACTURED” COMPONENTS, OR OF POWDERS OTHER THAN THOSE FOR WHICH THIS BLACK POWDER FIREARM WAS ORIGINALLY DESIGNED.

POWDER CHARGE

It is safe to use as much Black Powder as the chamber will hold, leaving room for the bullet. This maximum loading is not usually the most accurate loading, however.

A good starting accuracy load, using a pure lead .457" diameter ball, is 20 grains of FFFg and sufficient filler (corn meal is frequently used as a filler material) to seat the ball approximately 1/16" below the chamber mouth. You may find that some minor adjustment of this charge upwards or downwards is more accurate in your "Old Army."

Filler is not required and can be completely dispensed with if the powder charge takes up at least 1/2 of the cylinder.

 WARNING—BLACK POWDER	
	<p>Black Powder is an extremely sensitive propellant and is readily ignited by heat, spark, static electricity, friction, pressure, impact, etc. Unlike smokeless powder, Black Powder will ignite with great violence and rapidity even when unconfined. Black Powder should be handled only in very small quantities. <u>Never pour powder directly from a flask or powder horn into any muzzle loading firearm!</u></p> <p>Many shooters pre-weigh single charges into medicine vials for use on the range or in the field. Never fire the revolver near an open powder container, or an explosion may result.</p> <p>If you are not familiar with safe handling procedures for Black Powder and for muzzle loading firearms in general, you should obtain one of the authoritative muzzle loaders' Manuals and study it carefully <i>before</i> beginning to shoot.</p>
BLACK POWDER IS EXPLOSIVE	

 WARNING—AMMUNITION	
	<p>Death, serious injury, and damage can result from the use of wrong ammunition, bore obstructions, powder overloads, or incorrect components. <u>Always</u> wear shooting glasses and hearing protectors.</p> <p>Never use smokeless powder in any muzzleloader!</p>
	IMPROPER AMMUNITION DESTROYS GUNS

PERCUSSION CAPS

A percussion cap is a small metal cup, the interior top of which is coated with a priming mixture. This priming mixture is usually covered with a foil or paper liner. It fires when struck a blow.

The cap is placed on a cylinder nipple and when struck by the hammer, the priming compound explodes, igniting the powder charge.

The cap should fit the nipple only tightly enough so that it does not fall off when the barrel is elevated. Do not attempt to use caps which are too tight or try to force or pound caps onto the nipples, as a premature discharge could result. The suggested cap size for the Old Army revolver is No. 10 or No. 11 (U.S.) or equivalent.

Since percussion caps have an open end (which is placed on the cylinder nipple when you are ready to fire), they are susceptible to contamination. Be careful when handling percussion caps, especially with oily fingers, and try to keep water, grease, dirt and other contaminants out of the open end of the caps. Failure to do so is the main cause of misfires in cap and ball muzzleloading firearms.

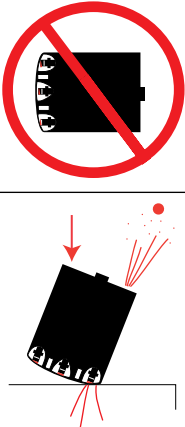
 WARNING—CAPPED CYLINDERS	
	<p>Percussion caps are designed to fire as the result of a blow “percussion”.</p> <p>A capped cylinder loaded with powder and ball is, in effect, a small firearm.</p> <p>Never clean, lubricate, disassemble, or work on a revolver while it is loaded.</p> <p>Never install, remove, or carry a loaded and capped cylinder.</p> <p>A loaded and capped cylinder can discharge if dropped or struck. Read instructions before disassembling gun.</p>
NEVER CARRY A CAPPED CYLINDER	

EYE AND EAR PROTECTION

Safety glasses must be used when loading and firing the “Old Army,” or any percussion firearm. Small pieces of the percussion cap are frequently blown away when a percussion arm fires. Always wear hearing protection when firing any firearm, in order to avoid permanent hearing damage.

TO LOAD AND FIRE



WARNING: Please re-read carefully the paragraph entitled “Warning - Black Powder,” p. 11.

In the interests of both performance and safety, it is important that steps which follow be performed in sequence and with attention to detail:

 WARNING – MUZZLE DIRECTION	
	Always hold the gun well away from yourself when loading or firing. Never permit the barrel to point in an unsafe direction. Even though the revolver is sometimes called a “muzzle-loader,” it is never loaded through the muzzle. Only load through the front of the cylinder.
	KEEP AWAY FROM MUZZLE

1. BEFORE LOADING:

Check revolver to ensure that:

- A. Nipples are uncapped.
- B. Cylinder chambers are empty.
- C. Chambers, bore and nipples are free of grease, oil or other obstruction.

2. CLEARING THE NIPPLES:

Without loading the chambers, place a percussion cap on each nipple. Point the gun in a safe direction and fire all six caps. This is done to ensure that the nipple passage is clear and dry.

Remove all percussion caps and cap fragments.

3. CHARGING THE CHAMBERS:

- A. Starting with the hammer in its full forward position, place hammer in half-cock (loading) position by drawing it to the rear until a “click” is heard (see Fig. 1). The cylinder is now free to rotate in a clockwise direction. (If the hammer is brought back too far, or if the hammer is put into the loading position by easing it forward from full cock, the cylinder will not be free to rotate.) Do not touch the trigger while placing the hammer in the half cock notch.

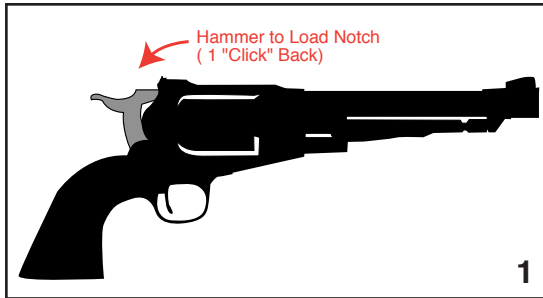

- B. With one hand, hold the revolver by the grip with the barrel pointing upwards.
- C. Using a dipper or other single-charge measure, pour the desired amount of powder into the front opening of one chamber of the cylinder (see Fig. 2). Then, if desired, fill balance of chamber with filler, leaving room for the bullet to be seated.
- D. Place the bullet in the mouth of the charged chamber and rotate the cylinder until that chamber is aligned with the rammer (see Figs. 3 & 4).

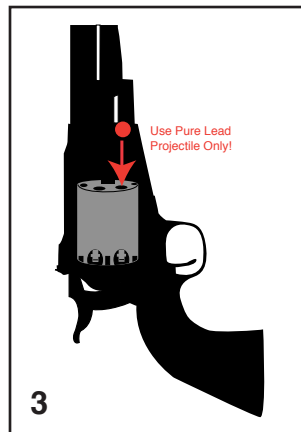
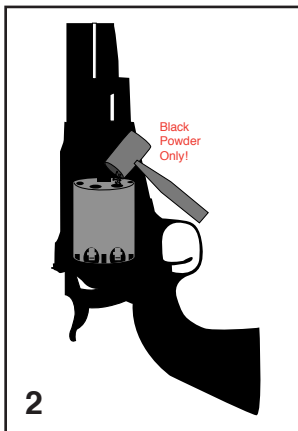

- E. Grasp the rammer lever and, with a firm even stroke, seat the bullet firmly on the powder charge (see Fig. 4). For maximum accuracy, the powder charge should be very lightly compressed by the bullet. Be sure that the bullet is seated deeply enough so that it does not interfere with the barrel and the cylinder can rotate freely. Do not leave an airspace between the powder and the bullet.

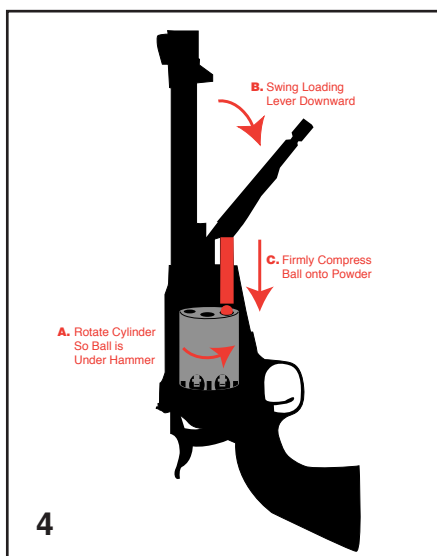

Repeat this procedure until all chambers you wish to load are loaded with powder and ball. Remember that the safest way to carry any old style revolver is with the hammer down on an empty chamber. See “Warning - Handling,” p. 16.

- F. Using one of the commercially available bullet greases or other stiff grease (some automotive water pump greases have proven satisfactory), apply a liberal coating of grease to each chamber mouth so as to cover the bullet and seal the chamber. The purpose of this is twofold:
1. To decrease leading and barrel fouling, and;
 2. To reduce the possibility of multi-chamber discharge (“flash over”) when firing.

4. CAPPING THE NIPPLES:

Be sure you use only pistol caps of good quality and correct size. The caps should be completely, but without undue pressure, seated on the nipples. Caps should only be tight enough so that they do not fall off the nipple when the barrel is elevated (see Fig. 5).

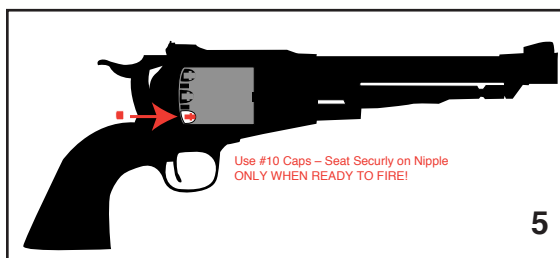

WARNING: *It is dangerous to attempt to use caps which are too small. Never force a cap on to the nipple. Since caps fire by percussion, excess force or a blow in seating them can cause the caps to discharge, firing the gun, and forcing hot gas out of the nipple, which can cause injury.*



WARNING – HANDLING

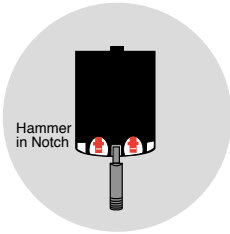

If these revolvers are to be carried loaded, certain precautions must be observed in the interest of safety. (These precautions apply to all the older types of revolvers.) Load only five chambers, placing the hammer down on the empty and uncapped chamber, or with the hammer resting in a safety recess between chambers.

The gun should never be carried with the hammer resting on a percussion cap. Under such circumstances, a light accidental blow on the hammer can readily cause the gun to discharge.

The half-cock loading notch provides only partial security from accidental discharge. If damaged, as it may be by “fanning”, it offers no security. Never depend upon this or any other mechanical device to justify careless handling of any firearm. “Fanning” is unsafe for you and abusive to your revolver.

NEVER PUT THE HAMMER DOWN ON A CAPPED OR LOADED CHAMBER.

5. COCKING:

To fire the revolver, the hammer must first be manually cocked. When cocking the hammer, have a firm hold on the grip with the shooting hand, and **DO NOT TOUCH THE TRIGGER WHILE COCKING THE HAMMER. TOUCH THE TRIGGER ONLY WHEN YOU ARE READY TO FIRE.** With the fore portion of your thumb firmly on the hammer spur, draw the hammer fully to the rear until it stops. Then permit the hammer to move forward (it will only move slightly) until the trigger engages in the hammer at full cock.



WARNING – COCKED GUN



Any time the revolver is loaded, the hammer is cocked and the trigger is pulled and held to the rear, it will fire. Cocking the gun or pulling the trigger should only be done when you are ready to fire immediately.



NEVER DROP OR STRIKE ANY REVOLVER – COCKED OR UNCOCKED. CARRY AND HANDLE THE REVOLVER IN SUCH A MANNER THAT THE HAMMER WILL NOT BE STRUCK.



NEVER CARRY ANY REVOLVER WITH THE HAMMER COCKED.

6. FIRING:

The “Old Army” is now ready to fire. Once the hammer is cocked, a light pressure on the trigger will cause the hammer to fall forward, striking a percussion cap, and the revolver will fire.

7. After firing, the hammer will remain down. To fire subsequent shots, fully release the trigger and repeat steps 5 and 6 above for each shot.

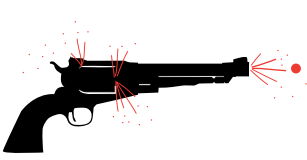
 WARNING – INDEXING	
 <p>Never Rest Hammer on Cap!</p>	<p>If the gun is to be fired immediately after loading, ease the hammer forward into one of the safety recesses in the cylinder <u>before</u> the hammer is drawn back to the full cock position for the first shot. The hammer should be drawn with a firm, positive motion to the full cock position for each shot; thus actuating the working parts for complete indexing. Unless this procedure is followed in any single action revolver, the cylinder is apt to be out of index when fired.</p> <p>If you do not desire to fire immediately, the hammer nose should be lowered onto an <u>empty</u> chamber or eased into one of the safety recesses which is provided on the rear of the cylinder between the nipples. This operation should be performed very cautiously, as, should the hammer fall onto a capped nipple, the revolver will fire. Be sure that the hammer is fully down in the safety recess and not just resting on the edge. The half-cock notch is provided for ease of loading only and should never be used as a safety notch.</p>
 <p>Hammer in Notch or on Empty Chamber</p>	<p>BE SURE HAMMER IS IN CORRECT POSITION</p>

 WARNING – FIRING	
	<p>When firing any revolver, be sure all persons are a safe distance to the rear of the shooter. When fired, all revolvers discharge gas and particles through the clearance gap between the cylinder and the rear of the barrel. These particles of lead, powder grains or lubricant are projected broadly sideways at high speed and thus can injure a person who is standing too close to the revolver. When firing any revolver, always be certain that nothing – including either of your hands – is in the path of the hot gas and particles which are discharged from the front and sides of the cylinder. Safety glasses <i>must</i> be used by shooters and bystanders when loading and firing the “Old Army”, or any percussion firearm. Small pieces of the percussion cap are frequently blown away when a percussion arm fires. Always wear hearing protection when firing any firearm, in order to avoid permanent hearing damage.</p>
	<p>HOT GASES EXIT BARREL/CYLINDER GAP AND NIPPLES</p>

DRY-FIRING: Going through the actions of cocking, aiming, and pulling the trigger of an unloaded gun is known as “Dry Firing.” It can be useful to learn the “feel” of your revolver. **Be certain the revolver is unloaded and that the gun is pointing in a safe direction even when practicing by dry-firing.** The Ruger Old Army can be dry-fired without damage to the firing components.

“FANNING”: **NEVER** fan the Ruger Old Army revolver. Fanning is an unsafe way to fire a gun and it is abusive to the revolver mechanism.

TO ‘UNCOCK’ (DECOCK) THE REVOLVER

If your revolver is cocked, and you wish to let the hammer down to a notch in the cylinder between nipples, proceed as follows: **USE EXTREME CARE WHEN ATTEMPTING TO DECOCK THE REVOLVER, AS THE THUMB SLIPPING DURING THIS PROCESS CAN RESULT IN AN ACCIDENTAL DISCHARGE IF THE TRIGGER IS HELD TO THE REAR.**

1. **Make certain that the revolver is pointing in a safe direction** (see Rule 2, Page 35).
2. Make certain both hands are dry and not impeded in any way – gloves, bandages, cold, etc.
3. Grasp the revolver (if right handed) so that the thumb and forefinger of your left hand are firmly holding the frame, forward of the trigger guard. Thus, your left hand is in full control of the revolver (see Figure a, below).

DECOCKING (UNCOCKING) THE REVOLVER

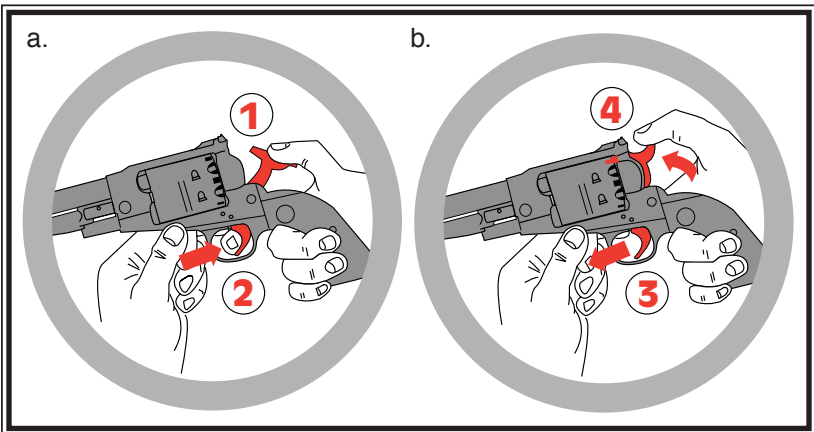

- a. With the thumb controlling the hammer as shown above (1), squeeze trigger to permit hammer to ‘break free’ (2).
- b. When hammer is free, **IMMEDIATELY** release trigger (3). Then lower hammer slowly to its resting position completely into a notch **between** each nipple (4). **Never** lower the hammer so that it rests on a percussion cap!

- Place your right thumb firmly on the hammer spur and, with your thumb securely in control of the hammer, squeeze the trigger only enough to permit the hammer to 'break free' of the trigger. Keep the trigger pulled only until the hammer clears the loading notch ("half cock") position. At that instant, IMMEDIATELY RELEASE THE TRIGGER and then slowly permit the hammer, STILL SECURE UNDER YOUR THUMB, to move forward into one of the notches in the cylinder between the nipples. NOTE: It is imperative that finger pressure be removed from the trigger just as soon as it is free of the loading notch in the hammer. Then, properly, the trigger and hammer will move towards their forward positions together (see Figure b, below).

Practice this important gun handling skill with an unloaded revolver until you have developed the proper control and 'touch' to decock your revolver safely. The key to safe decocking is having the weight of the revolver controlled with one hand, while the thumb and forefinger of the 'shooting hand' control the hammer and trigger.

Remember - Never lower the hammer fully down onto a percussion cap or loaded chamber! See "Warning - Handling," p 16.

TO UNLOAD

(Keep revolver pointed in a safe direction)

It is much easier and safer to fire all chambers in any muzzle loading firearm rather than attempt to unload it. However, if this is impossible, the revolver may be unloaded in accordance with the following steps.

- Be sure the revolver is pointing in a safe direction.
- Carefully lower hammer into a notch in the cylinder and then pull the hammer back one "click" to place hammer in half-cock loading notch (see Fig. 6). **Keep fingers away from trigger!**
- Carefully remove percussion caps from all nipples (see Fig. 7).
- Using the nipple wrench supplied, carefully unscrew the nipple from the chamber aligned with the cut-out on the right side of the frame (see Fig. 8).

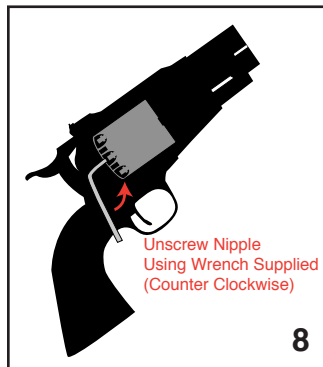
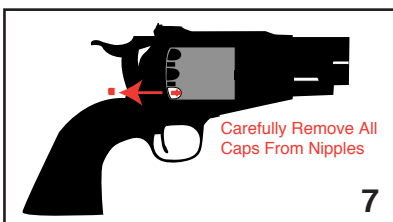
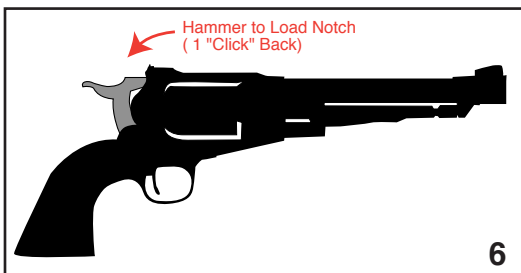

5. *Carefully* elevate the muzzle and dump the powder out of the rear of the cylinder into a container (see Fig. 9).
6. Repeat for each chamber.
7. When all chambers are empty of powder, remove cylinder (see Fig. 10 & “To Remove Cylinder,” below).

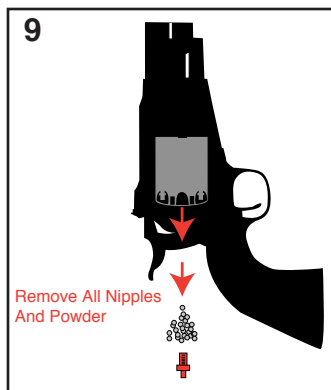
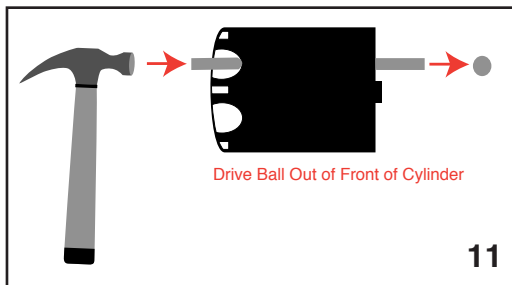
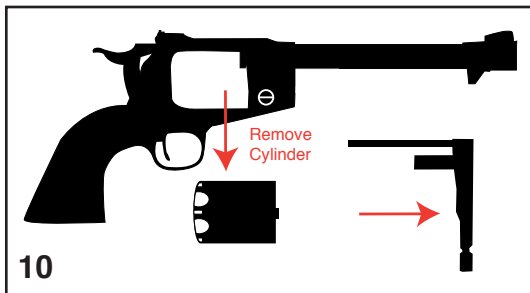

8. Place some lubricating oil into each chamber. Now place a rod into the rear of a chamber, taking care not to damage the nipple threads. Gently tap the rear of the rod until the ball comes out the front of the cylinder (see Fig. 11). Repeat for each chamber.
9. An alternative unloading method is to **remove the percussion caps** and remove the cylinder as described below. Then, use the nipple wrench to remove the nipples, dump the powder out of the cylinder, and follow step #8 above.

TO REMOVE CYLINDER

WARNING: *Never attempt to remove a capped and loaded cylinder. If the cap is struck, the cylinder will fire even if it is not in the gun. See “Warning - Capped Cylinders,” p. 12.*

1. Starting with the hammer fully forward, pull it back one “click” to the half-cock loading notch (see Fig. 12). **Keep fingers away from trigger!** Be sure that the cylinder rotates freely.

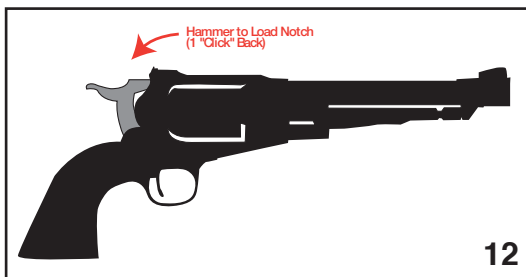

2. On the right side of the frame, forward of the cylinder, you will see a large slotted pin that resembles a screw head (Part #CB02800). With a suitable tool turn this pin counterclockwise until it stops (about 160°). (See Fig. 13.)

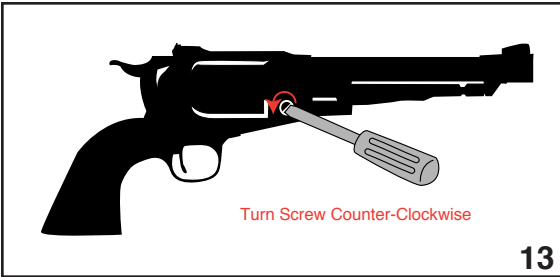

3. Unlatch the rammer lever and swing downward 90°. (See Fig. 14.)

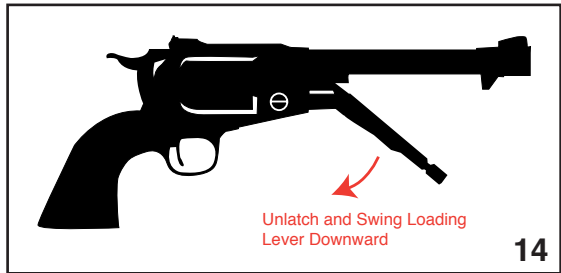

4. Pull rammer/base pin assembly forward, towards the muzzle, until it comes free of the revolver. (See Fig. 15.)

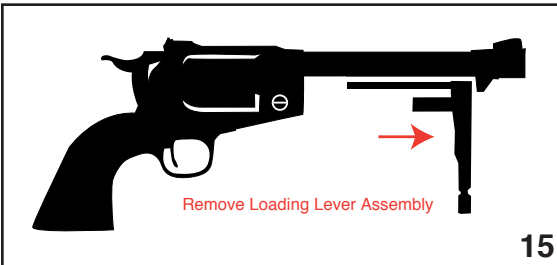

5. The cylinder may then be removed from the right side of the frame. (See Fig. 16.)

To reassemble, simply reverse this procedure.

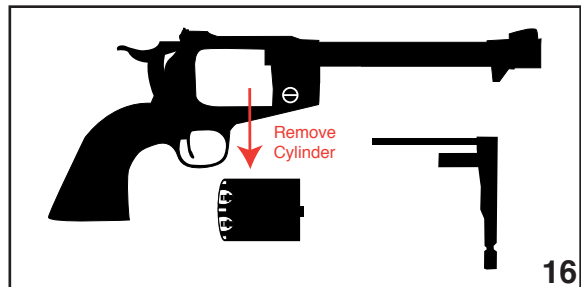



The user of a **RUGER® OLD ARMY®** cap and ball revolver should carefully read all disassembly directions and study all the illustrations and the Parts List in this manual before attempting to take the gun apart. Know the names and location of the parts before removing any of them. Although the revolver mechanism is composed of only a few parts, it is essential that the disassembly and reassembly operations be carried out with knowledge and care.

Only a few tools are required: A screwdriver or two to remove the grip panel screw, grip frame screws, and to remove the hammer and trigger pivot screws.

The tip of the screwdriver blade should perfectly fit the screw slots. A tip too large will scrape away metal, while too small a tip will damage the screw slots.

Before taking the gun apart, set up to do it properly. Cover the work surface with a soft cloth so that the gun finish (and sights) will not be damaged, and provide a tray into which the parts can be put as they are removed from the gun.

 WARNING – DISASSEMBLY	
 LOADED	<p>Never clean, lubricate, disassemble or work on a revolver while it is loaded. Never install or remove a loaded cylinder. A loaded cylinder can discharge if dropped or struck. Read instructions before disassembling gun.</p>
UNLOAD BEFORE CLEANING OR DISASSEMBLING	

DISASSEMBLY

(Make Sure Revolver is Unloaded!)

DETAILED DISASSEMBLY:

1. Remove cylinder (see “To Remove Cylinder,” p. 20), rammer assembly and base pin.
2. Push base pin retaining pin through from the left side.
3. Remove grip panel screw and lift grip panels away from grip frame.
4. Bring hammer back to full cock position and insert any convenient nail or pin into the small hole at the lower end of the hammer strut; then press the trigger and permit the hammer to move to a forward position. (It will be observed that the pin which has been placed in the hammer strut hole serves to confine the mainspring.)
5. Remove the five screws which fasten the grip frame to the cylinder frame. In separating the grip frame from the cylinder frame take care to prevent loss of

the pawl spring and plunger. These parts are located in a hole drilled from the rear face of the cylinder frame, adjacent to the upper left screw hole.

6. Remove hammer pivot screw and hammer by unscrewing counter-clockwise.
7. Remove trigger pivot screw and trigger by unscrewing counter-clockwise.
8. With a small screwdriver free the fixed leg of the cylinder latch spring from its anchoring hole on the left side wall of the cylinder frame.
9. Remove cylinder latch pivot, cylinder latch and spring.
10. It will be noted that the trigger spring and plunger are positioned in a hole in the grip frame at the rear of the trigger guard bow. The innermost coil of the trigger spring is enlarged to prevent its loss during disassembly and reassembly, and care should be observed in removing the plunger and spring to prevent deformation of the spring.
11. The hammer plunger is retained in the hammer by means of a pin which may be removed by means of a small drift.

The revolver is, at this stage, disassembled as far as it needs to be for major cleaning and maintenance.

NOTE: Always use a good quality screwdriver which properly fits the screw slots to avoid unsightly deformation of the screw heads.

REAR SIGHT: The adjustable rear sight (on models so equipped) can be removed from the frame by drifting out the pivot pin (MR05600) and removing the elevation screw (MR05902). Unless it is essential, the rear sight should not be removed because there is a risk of losing the very small elevation springs. If the sight is removed, when reassembling it is helpful to put a very tiny dab of lubricating gun grease in the recesses of the sight base. The grease will 'hold' the springs upright when the sight is positioned on the frame as the rear sight pivot pin is being reinstalled.

REASSEMBLY

(Make Sure Revolver is Unloaded!)

Simply follow "Disassembly" (see pp. 22 & 23) and then "To Remove Cylinder" (see p. 20) instructions in reverse order.

TO CLEAR A MALFUNCTION ("JAM")

If the revolver becomes difficult to cock, this can usually be traced to four basic causes (followed by the appropriate corrective action):

1. Accumulated black powder fouling (cease firing & clean gun).
2. Percussion cap fragments between cylinder & frame (carefully remove).
3. Percussion caps not fully seated on nipples (carefully reseal).
4. Projectile not fully seated into front of cylinder (carefully reseal *after* removing all caps from cylinder).

If it becomes necessary to disassemble the revolver for clearing a jam, be sure to unload it first. Never remove a capped cylinder from the revolver!

CARE AND CLEANING

Always be certain the revolver is completely unloaded before cleaning.

The chemical compounds formed by Black Powder residue are extremely corrosive; under some conditions of humidity rusting will begin within a very few hours after firing, if the revolver is left uncleaned. It is, therefore, important that your "Old Army" be cleaned thoroughly and without delay after each use.

Timely attention to the simple procedures which follow will ensure that your revolver remains in top condition for many years of use:

1. *Be sure revolver is unloaded!*
2. Remove rammer/base pin assembly and cylinder from revolver (see p. 20).
3. Place cylinder, base pin and bullet rammer in pan filled with hot water and soap solution to soak.
4. Remove base pin retaining pin from frame (CB02800).
5. With muzzle pointed down so that water cannot enter the lockwork, flush the barrel from the inside of cylinder frame with warm water, until water runs clear from the muzzle.
6. Using a bristle or brass brush wetted with soap and water solution, thoroughly scrub bore to remove all traces of fouling. Then, flush bore again with very hot water. *Do not permit water to enter the lockwork.* Dry bore and barrel/frame assembly thoroughly with clean cloth and set aside.
7. Thoroughly scrub cylinder and other parts in pan, flush with very hot water, and then wipe dry.
8. Inspect all parts (including frame, hammer, etc.) to be sure that these are clean and dry.
9. Oil the bore and all parts thoroughly with a good quality gun oil, then re-assemble.

NOTE: Several firms offer Black Powder solvents and these may be used in place of the soap and water solution. However, not all smokeless powder solvents will render the fouling left by Black Powder non-corrosive. Be sure you use a solvent specifically intended for black powder fouling.

Sometimes, lead build-up can occur in the chamber throats, in the forcing cone of the barrel, and in the bore. If 'leading' is noted in your revolver, clean it out before it builds up and interferes with reliable functioning and accuracy. A special 'lead removing' cleaning tool (for bore and chambers) is available from gun stores.

The revolver's internal mechanism can be lubricated without disassembly. A few drops of light oil recommended as suitable for firearms, applied periodically about the various frame openings, will work its way into the mechanism parts. The exterior of the revolver should be cleaned with a solvent and then wiped with an oily cloth.



WARNING – LUBRICATION



Firing a revolver with oil, grease, or any other material even partially obstructing the bore may result in damage to the revolver and injury to the shooter and those nearby.

Do not spray or apply lubricants directly on ammunition. If the powder charge of a cartridge is affected by the lubricant, it may not be ignited, but the energy from the primer may be sufficient to push the bullet into the bore where it may become lodged. Firing a subsequent bullet into the obstructed bore may damage the revolver and cause injury to the shooter and those nearby. Use lubricants properly. You are responsible for the proper care and maintenance of your firearms.

**IMPROPER LUBRICATION
DESTROYS GUNS**

STORAGE



GUNS SHOULD NOT BE STORED LOADED!

**USE THE LOCKING DEVICE SUPPLIED
WITH THE REVOLVER TO RENDER IT
INOPERATIVE FOR SAFE STORAGE.**

(SEE PAGE 5)

Do not keep your revolver in a leather, fabric or canvas holster when it is stored. These materials attract moisture, even though the holster may appear to be perfectly dry.

Sturm, Ruger also offers gun safes for sale as a means to secure more than one firearm. Please call the Heritage Safe Company at 1-800-515-7233 for details and ordering information.

 WARNING – STORAGE	
	<p>Never place or store any firearm in such a manner that it may be dislodged. Firearms should always be stored securely and unloaded, away from children and careless adults. Use the locking device originally supplied with this firearm for storage.</p> <p>The use of a locking device or safety lock is only one aspect of responsible firearms storage. For increased safety, firearms should be stored unloaded and locked in a location that is both separate from their ammunition and inaccessible to children and any other unauthorized person.</p>
	STORE SECURELY & UNLOADED

CARE OF STAINLESS STEEL REVOLVERS

Firearms made of stainless steel are relatively more resistant to corrosion than blued steel firearms. However, you should still inspect it frequently and clean, lubricate and apply an appropriate rust preventative as required.

Sometimes surface discoloration may be noted, particularly in the grip area of stainless steel handguns, resulting from perspiration. Contact with some types of holsters can also cause stains or rusting. Rusting may also occur as a result of the handgun being exposed to moisture, humidity, salt air or chemicals.

Minor discoloration can usually be removed by rubbing the stained area with an abrasive ink eraser, crocus cloth, or a “metal polishing” compound. When using any of these abrasives, proceed with care and use light pressure to achieve a blending of ‘color’ with those areas that are not discolored.

Exposed surfaces on the firearm should be cleaned and wiped dry after use or after exposure to adverse conditions. If the firearm is to be stored, coat it with a light film of oil or preservative.

Where the firearm is in continuing use, and the presence of oil or grease would be objectionable, then the external surfaces can be coated (after cleaning and drying) with a paste wax formulated for use on metals. Apply the wax sparingly, allow time for it to dry hard, then buff lightly with a soft cloth. When applying the wax take care that it does not get into the mechanism or on the functioning parts such as the bolt, trigger, magazine, etc. A properly applied hard wax coating will not interfere with comfortable gun handling and it will provide a measure of protection against the formation of rust.

SIGHTS

(ADJUSTABLE SIGHT MODELS ONLY)

ADJUSTMENT – Each click of the sight adjustment screw (either windage or elevation) will move the point of impact of the bullet approximately 3/4" at a range of 25 yards. The height of the front sight has been set to take advantage of the elevation adjustment in the rear sight, considering the various ranges at which the gun is most likely to be used. Barrel length and load used affects trajectory. Therefore the shooter should determine sight settings by firing trials.

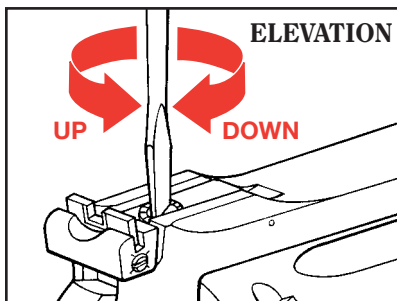

To raise point of impact: turn screw counterclockwise.

To lower point of impact: turn screw clockwise.

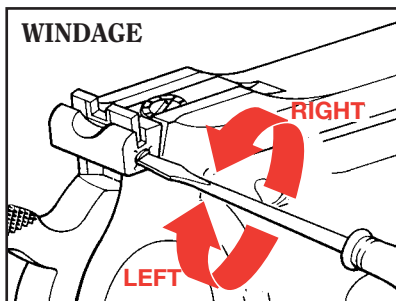

To move the point of impact to the right: turn screw counterclockwise.

To move the point of impact to the left: turn screw clockwise.

SUGGESTED SIGHT PICTURE

Top of front sight even with top of rear sight blade.
Front sight centered in notch of rear sight blade. Target bullseye centered on top of front sight.

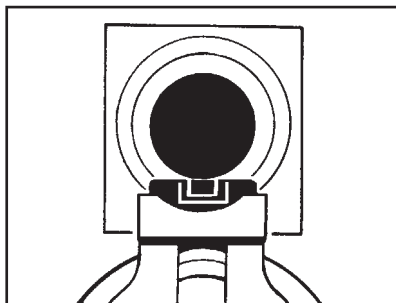

FIXED SIGHTS

(RUGER OLD ARMY FIXED SIGHT MODEL ONLY)

These revolvers feature a blade front sight and a fixed rear sight. They are factory set to be on target at 25 yards and cannot be further adjusted.

SERVICE AND PARTS POLICY

If you have any questions with regard to the performance of your revolver, please write or call (603-865-2442) our Newport, New Hampshire Product Service Department, fully describing all circumstances. If you should return your revolver to the factory for repair, or order parts for it, please comply with the following suggestions for prompt service:

SHIPPING FIREARMS FOR REPAIR



WARNING: BEFORE SHIPPING ANY FIREARM, BE ABSOLUTELY CERTAIN THAT IT AND ITS CYLINDER ARE UNLOADED. DO NOT SHIP BLACK POWDER OR PERCUSSION CAPS WITH A FIREARM.

RUGER® OLD ARMY® CAP-AND-BALL revolvers returned to the factory for repair should be sent to: Sturm, Ruger & Company, Inc., Product Service Department, 411 Sunapee Street, Newport, New Hampshire 03773. Telephone (603) 865-2442. The complete revolver should be shipped. Please do not send your holster, custom grip panels or other accessories with any revolver being shipped to us. Guns should be sent prepaid. We will not accept collect shipments.

The Federal Gun Control Act, as well as the laws of most States and localities, do not prohibit an individual (who is not otherwise barred from purchasing or possessing a firearm) from shipping a firearm directly to the manufacturer for repair. However, before shipping your firearm to us, be certain that your State or locality does not have a law or regulation which will prohibit you from receiving it from us after it has been repaired. If such receiving is prohibited, then please have a Federally Licensed Firearms dealer ship the gun to us. If your gun is sent to us by a dealer, it will be returned to that dealer after being repaired. If a handgun (pistol or revolver) is shipped by an individual who does not hold a Federal Firearms License, it must be shipped for overnight delivery via U.P.S., Federal Express or other, similar private overnight service. NOTE: Firearms may not be shipped via U.S. Mail. Persons who do not hold a Federal Firearms License are prohibited by Federal law from shipping a handgun by mail. Handguns mailed in violation of the law are impounded by the Post Office.

Please do not include revolver case, sling, telescopic sights or custom accessories with a firearm being shipped to the factory for service. **DO NOT SEND GUN BOXES OR LITERATURE THAT YOU CONSIDER TO BE COLLECTOR'S ITEMS – THESE ARE INVARIABLY DAMAGED OR DESTROYED IN SHIPMENT.** Always insure your shipment.

Enclose a letter which includes your name, address, telephone number, serial number and model of the firearm. Describe in detail the trouble you have experienced with your firearm, or the work you wish to have done. Merely stating that the firearm "needs repair" is inadequate information.

All work performed is subject to a minimum labor charge and charges for shipping and handling. Most models can be reblued, but custom gunsmithing service or nonstandard alterations are NOT AVAILABLE from Ruger Product Service Departments. Please contact the Product Service Department for pricing information.

 WARNING – PARTS PURCHASERS	
	<p>It is the purchaser's responsibility to be absolutely certain that any parts ordered from the factory are correctly fitted and installed. Firearms are complicated mechanisms and IMPROPER FITTING OF PARTS MAY RESULT IN A DANGEROUS MALFUNCTION, DAMAGE TO THE FIREARM, AND SERIOUS INJURY TO THE SHOOTER AND OTHER PERSONS. The purchaser and installer of parts must accept full responsibility for the correct adjustment and functioning of the revolver after such installation.</p>
	PARTS MUST FIT CORRECTLY

ORDERING PARTS

Please contact the New Hampshire Product Service Department for parts availability and current prices. All parts orders for the **RUGER® OLD ARMY® CAP-AND-BALL** revolver should be sent to : Sturm, Ruger & Co., Inc., Product Service Department, 411 Sunapee Street, Newport, New Hampshire, 03773, 603-865-2442.

We cannot comply with open account or C.O.D. orders. Payment in full via credit card (Visa or MasterCard only), money order or certified bank check (no personal checks, please) is required before any service will be performed. Please provide your name as it appears on the credit card along with the expiration date of the card. All parts orders are subject to a minimum charge and charges for shipping and handling. Order parts by Part Name and Part Number and include the entire serial number of the firearm for which the parts are being ordered. There is a minimum labor charge plus a shipping and handling charge if the parts are factory fitted. All factory fitted parts are fit on an exchange basis only. We will not return the replaced parts. Please contact the Product Service Department for pricing information.

Barrels, cylinders and a number of other component parts must be fitted at the factory. Company policy is to proof-test and/or function fire all barrels after fitting to the receivers in which they are to be used. This procedure ensures maximum protection to our customers. The special proof-test ammunition used in this testing is sold only to bonafide firearms manufacturers and is not available to gun shops, gunsmiths, or individuals.

Because it is a serial numbered part, the cylinder frame of **RUGER® NEW MODEL SINGLE ACTION** revolvers is defined as a ‘firearm’ by Federal Law and is not offered for sale as a component part.

Parts designated by an (*) must be factory fitted. These parts are fitted on an exchange basis only. We will not return the replaced parts. We will not return any part that is broken, malfunctioning, badly worn or has been modified. See “Warning – Parts Purchasers,” p. 29.

IMPORTANT – REGARDING PARTS ORDERING. Ruger Old Army Percussion revolvers are manufactured in Blued steel and Stainless steel versions. **WHEN ORDERING PARTS BE SURE TO STATE WHETHER YOUR REVOLVER IS BLUED OR STAINLESS. ALSO, INCLUDE THE COMPLETE SERIAL NUMBER.**

NOTE: A few components, as example sight blades and grip panels, are the same for blued and stainless models.

BARREL NOTE: All barrels are marked with a safety message, (“Before using gun, read warnings in Instruction Manual available free from Sturm, Ruger & Co. Inc., Southport, CT, USA”).



CAUTION: Firearm users are cautioned that a gun containing modified, broken, malfunctioning, or badly worn parts should not be fired.

RUGER® OLD ARMY®

PARTS LIST

Design, prices and specifications subject to change without notice.

SPECIFY MODEL WHEN ORDERING

(See Exploded View on Page 34.)

Part Name	Part No.	Model
* Barrel Assembly, Complete – 7 1/2" barrel	CB-6	Blued Model
* Barrel Assembly, Complete – 7 1/2" barrel	KCB-6	Stainless Model
* Barrel Assembly, Complete – 5 1/2" barrel	CB-6-5	Blued Model
* Barrel Assembly, Complete – 5 1/2" barrel	KCB-6-5	Stainless Model
Base Pin	CB02900	Blued Models
Base Pin	KCB02900	Stainless Models
Base Pin Retaining Pin Assembly	CB02800	Blued Models
Base Pin Retaining Pin Assembly	KCB02801	Stainless Models
Bullet Rammer	CB00900	Blued Models
Bullet Rammer	KCB00900	Stainless Models
* Cylinder	CB-1	Blued Models
* Cylinder	KCB-1	Stainless Models
Cylinder Latch	CB04500	Blued Models
Cylinder Latch	KCB04500	Stainless Models
Cylinder Latch Pivot	CB03400	Blued Models
Cylinder Latch Pivot	KCB03402	Stainless Models
Cylinder Latch Spring	KCB04600	All Models
Front Sight, Adjustable	CB-36	Adjustable Sight Models
Front Sight, Fixed, Not Illustrated	CB03610	Fixed Sight Blued Models
Front Sight, Fixed, Not Illustrated	KCB03610	Fixed Sight Stainless Models
Front Sight Base, Adjustable	KMR13601	Adjustable Sight Models
Front Sight, Fixed, Not Illustrated	CB03610	Fixed Sight Blued Models
Front Sight, Fixed, Not Illustrated	KCB03610	Fixed Sight Stainless Models

Part Name	Part No.	Model
Front Sight Base, Adjustable	KMR13601	Adjustable Sight Models
Front Sight Blade, Adjustable	CB03600	Adjustable Sight Models
Front Sight Cross Pin, Adjustable	KE-26	Adjustable Sight Models
Grip Frame — Standard	CB00300	Blued Models
Grip Frame — Standard	KCB00300	Stainless Models
Grip Frame Screw-A-Front	XR01700	Blued Models
Grip Frame Screw-A-Front	KXR01700	Stainless Models
Grip Frame Screw-B-Back (2 Req'd.)	XR01800	Blued Models
Grip Frame Screw-B-Back (2 Req'd.)	KXR01800	Stainless Models
Grip Frame Screw-C-Bottom	XR01900	Blued Models
Grip Frame Screw-C-Bottom	KXR01900	Stainless Models
Grip Panels, Sold in Pairs Only	XR01000	All Models
Grip Panels, Simulated Ivory, Sold in Pairs Only	XR01000SI	All Models
Grip Panel Dowel	KXR01400	All Models
Grip Panel Ferrule, Left	XR01200	All Models
Grip Panel Ferrule, Right	XR01100	All Models
Grip Panel Screw	KXR01300	All Models
* Hammer	CB04000	Blued Models
* Hammer	KCB04000	Stainless Models
Hammer Pivot	CB01600	Blued Models
Hammer Pivot	KCB01601	Stainless Models
Hammer Plunger	KCB04102	All Models
Hammer Plunger Pin	KE-22	All Models
Hammer Plunger Spring	KCB04300	All Models
Hammer Strut	XR01500	Blued Models
Hammer Strut	KXR01500	Stainless Models
Loading Lever – 7 1/2" barrel	CB00800	Blued Models
Loading Lever – 7 1/2" barrel	KCB00800	Stainless Models
Loading Lever – 5 1/2" barrel	CB00805	Blued Models
Loading Lever – 5 1/2" barrel	KCB00805	Stainless Models
Loading Lever Latch	CB06700	Blued Models
Loading Lever Latch	KCB06701	Stainless Models

Part Name	Part No.	Model
Loading Lever Latch Screw	CB06800	Blued Models
Loading Lever Latch Screw	KCB06801	Stainless Models
Loading Lever Latch Spring	KCB06900	All Models
Mainspring	CB00400	Blued Models
Mainspring	KCB00400	Stainless Models
Mainspring Seat	XR00500	Blued Models
Mainspring Seat	KXR00500	Stainless Models
Medallion, 2 Req'd., Not Illustrated	XR05200	All Models
Nipple	KCB07200	All Models
Nipple Wrench, Not Illustrated	CB07300	All Models
Pawl	KCB00700	All Models
Pawl Plunger	XR05100	Blued Models
Pawl Plunger	KXR05100	Stainless Models
Pawl Plunger Spring	XR05000	Blued Models
Pawl Plunger Spring	KXR05000	Stainless Models
Rear Sight Assembly, Complete, Adjustable Specify whether sight has bump on underside.	MR15900	Adjustable Sight Models
Rear Sight Elevation Screw, Adjustable	MR05902	Adjustable Sight Models
Rear Sight Blade, Adjustable	MR05901	Adjustable Sight Models
Rear Sight Elevation Spring, Adjustable (2 Req'd.)	MR05906	Adjustable Sight Models
Rear Sight Pivot Pin, Adjustable	MR05600	Adjustable Sight Models
Rear Sight Windage Adjustment Screw, Adjustable	E05903	Adjustable Sight Models
Rear Sight Windage Spring, Adjustable	MR05907	Adjustable Sight Models
* Trigger	CB03900	Blued Models
* Trigger	KCB03900	Stainless Models
Trigger Pivot Screw	CB03400	Blued Models
Trigger Pivot Screw	KCB03402	Stainless Models
Trigger Plunger	CB03800	Blued Models
Trigger Plunger	KCB03800	Stainless Models
Trigger Spring	KCB03700	All Models

* PARTS SO MARKED MUST BE FACTORY FITTED.

EXPLODED VIEW RUGER® OLD ARMY®

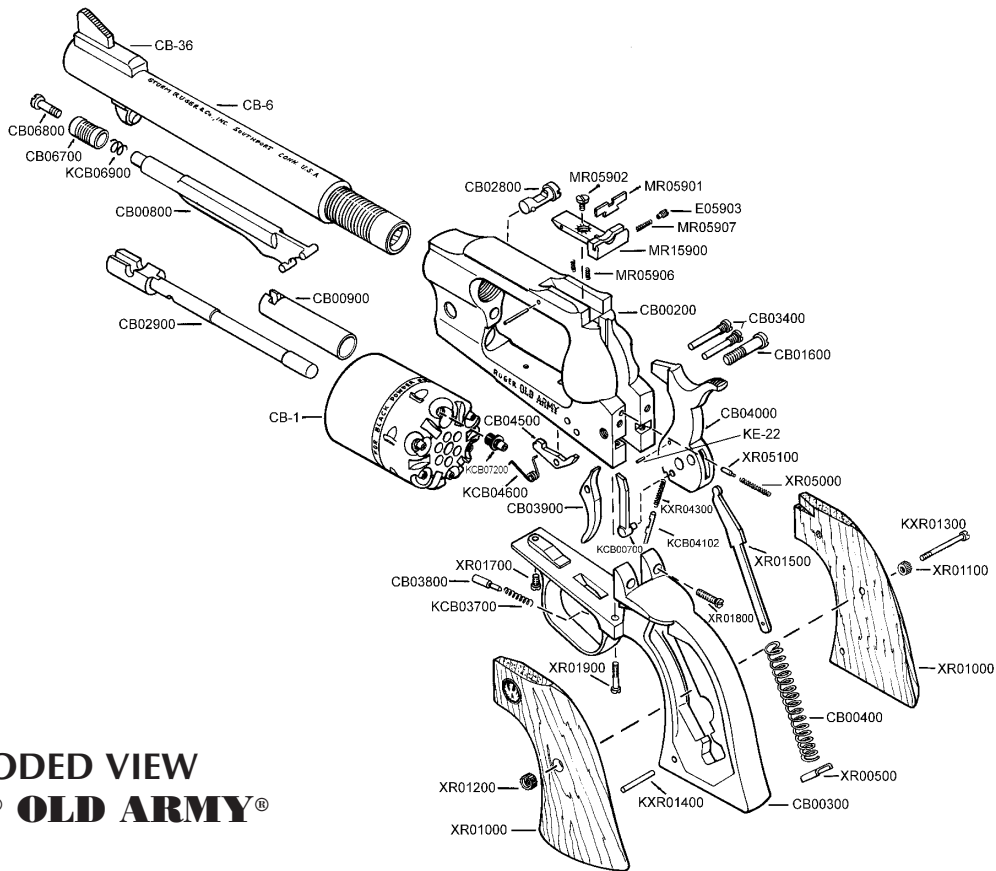

THE BASIC RULES OF SAFE FIREARMS HANDLING

We believe that Americans have a right to purchase and use firearms for lawful purposes. The private ownership of firearms in America is traditional, but that ownership imposes the responsibility on the gun owner to use his firearms in a way which will ensure his own safety and that of others. When firearms are used in a safe and responsible manner, they are a great source of pleasure and satisfaction, and represent a fundamental part of our personal liberty.

Firearms do not cause accidents! Firearms accidents are almost always found to have been the result of carelessness or ignorance on the part of the shooter of the basic rules of safe gun handling.

The following rules must be observed by gun users at all times. Safe gun handling is not just desirable, it is absolutely essential to your safety, the safety of others, and the continuation of gun ownership and sport shooting as we know it today.

1. LEARN THE MECHANICAL AND HANDLING CHARACTERISTICS OF THE FIREARM YOU ARE USING.

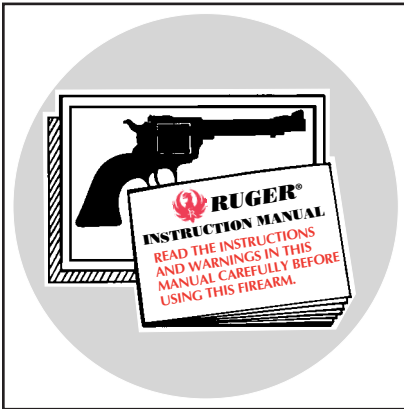

Not all firearms are the same. The method of carrying and handling firearms varies in accordance with the mechanical provisions for avoiding accidental discharge and the various proper procedures for loading and unloading. No person should handle any firearm without first having thoroughly familiarized himself with the particular type of firearm he is using, and with safe gun handling in general.

2. ALWAYS KEEP THE MUZZLE POINTED IN A SAFE DIRECTION.



Be sure of the bullet stop behind your target, even when dry-firing. Never let the muzzle of a firearm point at any part of your body or at another person. This is particularly important when loading or unloading a firearm. In the event of an accidental discharge, no injury can occur as long as the muzzle is pointing in a safe direction. A safe direction means a direction which will not permit a discharged bullet to strike a person, or to strike an object from which the bullet may ricochet.

A safe direction must take into account the fact that a bullet may penetrate a wall, ceiling, floor, window, etc., and strike a person or damage property. Make it a habit to know exactly where the muzzle of your gun is pointing whenever you handle it, and be sure that you are always in control of the direction in which the muzzle is pointing, even if you fall or stumble. Keep your finger off the trigger until you are ready to shoot.

3. FIREARMS SHOULD BE UNLOADED WHEN NOT IN USE.



Firearms should be loaded only when you are in the field or on the target range or shooting area, ready to shoot. Firearms and ammunition should be securely locked in safes, racks or cabinets, or by using the locking device supplied with the firearm, when not in use. Ammunition should be safely stored separate from firearms. Store your firearms out of sight of visitors and children. It is the gun owner's responsibility to

be certain that children and persons unfamiliar with firearms cannot gain access to firearms, ammunition, or components.

4. BE SURE THE BARREL IS CLEAR OF OBSTRUCTIONS BEFORE SHOOTING.

Even a bit of mud, snow or excess lubricating oil or grease in the bore may cause the barrel to bulge, or even burst on firing, and can cause serious injury to the shooter and bystanders. Be sure that you are using ammunition of the proper caliber and loading for the gun you are using. If the report or recoil on firing seems weak, or doesn't seem quite right, **CEASE FIRING IMMEDIATELY**, unload your firearm and check to be sure that no obstruction has become lodged in the barrel.





5. BE SURE OF YOUR TARGET BEFORE YOU SHOOT.

Don't shoot unless you know exactly where your bullet is going to strike. Be sure of the bullet stop behind your target, even when dry-firing with an unloaded gun. If you are in the field hunting, do not fire at a movement or noise. Take the time to be absolutely certain of your target before you pull the trigger.

6. WEAR SHOOTING GLASSES AND HEARING PROTECTORS WHEN YOU SHOOT.

All shooters should wear protective shooting glasses and adequate hearing protectors when shooting. Exposure to shooting noise can damage hearing, and adequate eye protection when shooting is essential.

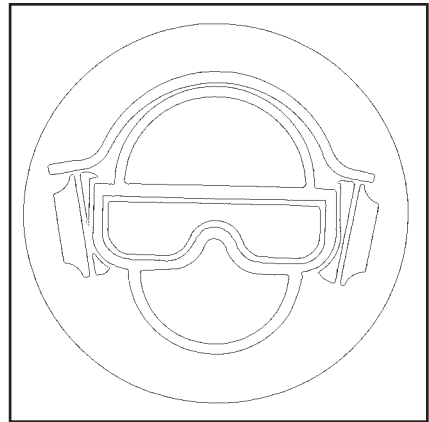

7. NEVER CLIMB A TREE OR FENCE WITH A LOADED FIREARM.

Put the firearm down carefully before climbing a fence, and unload it before climbing or descending a tree or jumping over a ditch or other obstruction. Never pull or push a loaded firearm toward yourself or another person. When in doubt, or whenever you are about to do anything awkward, unload your gun!

8. DON'T SHOOT AT A HARD SURFACE, OR AT WATER.

Bullets can glance off many surfaces like rocks or the surface of water and travel in unpredictable directions with considerable velocity.



9. NEVER TRANSPORT A LOADED FIREARM.

Firearms should always be unloaded before being placed in a vehicle. A suitable carrying case or scabbard should be used to carry an unloaded firearm to and from the shooting area.

10. AVOID ALCOHOLIC BEVERAGES WHEN SHOOTING.

Don't drink until the day's shooting is over. Handling firearms while under the influence of alcohol in any form or medications that could affect your judgement or coordination, constitutes a criminal disregard for the safety of others.



A BRIEF ACCOUNT OF AN EXTRAORDINARY ACHIEVEMENT: RUGER FIREARMS

Sturm, Ruger & Company, Inc., had its beginning in a small machine shop occupying a rented frame building in Southport, Connecticut. In January, 1949, with an initial investment of only \$50,000 and an idea, William B. Ruger and Alexander M. Sturm started production of a .22 caliber autoloading pistol—a design which was so successful that it became the cornerstone upon which one of the most comprehensive lines of sporting firearms ever made in America was established. After Alex Sturm's death in 1951, William B. Ruger continued to direct the Company until his death in 2002. William B. Ruger, Jr. continued to provide guidance, which helped make this Company a sound and successful enterprise, until his retirement in 2006. The Company has continued to prosper, under new management and guidance from our Board, with new products and fresh perspectives.

Ruger, in this relatively short time, has established itself as a leading small arms design organization, developing a unique and broad line of fine quality sporting, military and police firearms to become one of the world's most famous producers of revolvers, pistols, rifles and shotguns. Since 1949 Ruger craftsmen have built many millions of firearms.

During its five decades of growth and progress under the leadership of William B. Ruger, the Company developed a business philosophy and implemented policies which represent a constructive influence in the life of modern America. From the beginning, Ruger played a positive role in conservation efforts and has supported the interests of shooters through such groups as the National Rifle Association, National Shooting Sports Foundation, and many regional sportsmen's organizations.

The Company has always endeavored to market its firearms for constructive and recreational purposes, to emphasize the traditional and responsible aspects of shooting, to render meaningful public services, and to encourage shooters in constructive, responsible, and safe participation in the shooting sports. Its motto, "Arms Makers For Responsible Citizens," exemplifies this Company philosophy.

Today, Ruger is particularly mindful of those elements which have contributed to the creation of its success, and extends heartfelt thanks to its many loyal employees and customers.

A current catalog of Ruger firearms is available free upon request to
Ruger, Southport, CT 06890

The firearms catalog, and instruction manuals for all Ruger firearms,
can also be downloaded from our website at:

www.ruger.com

WHY NO WARRANTY CARD HAS BEEN PACKED WITH THIS NEW RUGER FIREARM

The Magnuson-Moss Act (Public Law 93-637) does not require any seller or manufacturer of a consumer product to give a written warranty. It does provide that if a written warranty is given, it must be designated as "limited" or as "full" and sets minimum standards for a "full" warranty. Sturm, Ruger & Company, Inc. has elected not to provide any written warranty, either "limited" or "full", rather than to attempt to comply with the provisions of the Magnuson-Moss Act and the regulations issued thereunder. There are certain implied warranties under state law with respect to sales of consumer goods. As the extent and interpretation of these implied warranties varies from state to state, you should refer to your state statutes. Sturm, Ruger & Company wishes to assure its customers of its continued interest in providing service to owners of Ruger firearms.



STURM, RUGER & Company, Inc.
411 Sunapee Street
Newport, New Hampshire 03773 U.S.A.
www.ruger.com

Arms Makers For Responsible Citizens®

**A COPY OF THE INSTRUCTION MANUAL FOR ANY RUGER
FIREARM IS AVAILABLE FROM THE FACTORY FREE ON REQUEST, OR IT MAY
BE DOWNLOADED FROM OUR WEBSITE AT WWW.RUGER.COM.
THESE INSTRUCTION MANUALS CONTAIN IMPORTANT
WARNINGS WHICH MUST BE UNDERSTOOD
BEFORE USING THESE FIREARMS.**

"22/45," "22 Charger," "LCP," "LCR," "Model 96," "P90," "P91," "P93," "P94," "P95," "P97," "P345D," "Mark III," and "P345PR" are RUGER TRADEMARKS. **"RUGER,"** THE STURM, RUGER LOGO, "AC-556," "Arms Makers For Responsible Citizens," "10/22," "All-Weather," "Bearcat," "Blackhawk," "Gold Label," "GP100," "Hawkeye," "M77," "Mini Thirty," "Mini-14," "Old Army," "P345," "P85," "Redhawk," "Ruger Titanium," "Ruger 77/17," "Ruger 77/22," "Ruger 77/44," "Ruger 77/50," "Ruger SP101," "Ruger Vaquero," "Security-Six," "Service-Six," "Single-Six," "Speed-Six," "SR9," the "SR" Design, "Super Redhawk Alaskan" and "Target Grey" are REGISTERED U.S. TRADEMARKS.

"DEERFIELD" is a registered trademark of Blount, Inc.

"The Frontier" is a registered trademark of new Colt Holding Corp.