



# **Zenoss Resource Manager Administration Guide**

Release 5.3.2

Zenoss, Inc.

[www.zenoss.com](http://www.zenoss.com)

# Zenoss Resource Manager Administration Guide

Copyright © 2017 Zenoss, Inc. All rights reserved.

Zenoss, Own IT, and the Zenoss logo are trademarks or registered trademarks of Zenoss, Inc., in the United States and other countries. All other trademarks, logos, and service marks are the property of Zenoss or other third parties. Use of these marks is prohibited without the express written consent of Zenoss, Inc., or the third-party owner.

Amazon Web Services, AWS, and EC2 are trademarks of Amazon.com, Inc. or its affiliates in the United States and/or other countries.

Flash is a registered trademark of Adobe Systems Incorporated.

Oracle, the Oracle logo, Java, and MySQL are registered trademarks of the Oracle Corporation and/or its affiliates.

Linux is a registered trademark of Linus Torvalds.

RabbitMQ is a trademark of Pivotal Software, Inc.

SNMP Informant is a trademark of Garth K. Williams (Informant Systems, Inc.).

Sybase is a registered trademark of Sybase, Inc.

Tomcat is a trademark of the Apache Software Foundation.

VMware is a registered trademark or trademark of VMware, Inc. in the United States and/or other jurisdictions.

Windows is a registered trademark of Microsoft Corporation in the United States and other countries.

All other companies and products mentioned are trademarks and property of their respective owners.

Part Number: 1012.17.268

Zenoss, Inc.  
11305 Four Points Drive  
Bldg 1 - Suite 300  
Austin, Texas 78726

# Contents

<b>About this guide.....</b>	<b>8</b>
<b>Chapter 1: Using Resource Manager.....</b>	<b>9</b>
Initial login.....	9
Interface and navigation.....	11
Customizing the dashboard.....	14
Search.....	17
Navigating the event console.....	18
Running a command from the browser interface.....	22
Working with triggers and notifications.....	22
Advanced user interface configuration.....	35
LDAP authentication.....	35
Verifying connectivity and credentials outside of Resource Manager.....	40
<b>Chapter 2: Visualizing your environment.....</b>	<b>41</b>
Dynamic service view.....	41
Datacenter view.....	45
<b>Chapter 3: Adding, discovering and modeling devices.....</b>	<b>49</b>
Add a single device.....	49
Add multiple devices.....	50
Discovering devices.....	50
Add Cisco UCS.....	53
Add vCloud cell.....	53
Add VMware vSphere endpoint.....	54
Modeling devices.....	55
About modeler plugins.....	58
Debugging the modeling process.....	59
<b>Chapter 4: Working with devices.....</b>	<b>60</b>
Viewing the Device List.....	60
Working with devices.....	61
Managing devices and device attributes.....	72
<b>Chapter 5: Configuration properties.....</b>	<b>76</b>
Configuration properties inheritance and override.....	76
Configuration property types.....	79
Device configuration properties.....	79
Event configuration properties.....	89
Network configuration properties.....	90
<b>Chapter 6: Monitoring templates.....</b>	<b>92</b>
Creating templates.....	92
Renaming templates.....	92

Template binding.....	92
Example: Defining templates in the device hierarchy.....	94
Example: Applying templates to multiple areas in the device hierarchy.....	94
<b>Chapter 7: Basic monitoring.....</b>	<b>95</b>
Availability monitoring.....	95
Monitoring using ZenCommand.....	104
SNMP monitoring.....	106
Monitoring devices remotely through SSH.....	107
Network map.....	109
<b>Chapter 8: Performance monitoring.....</b>	<b>111</b>
Monitoring templates.....	112
Template binding.....	112
Data sources.....	113
Data points.....	114
Data point aliases.....	115
Thresholds.....	118
Performance Graphs.....	126
Performance data retention.....	128
<b>Chapter 9: Event management.....</b>	<b>129</b>
Basic event fields.....	129
Other fields.....	131
Details.....	132
De-duplication.....	132
Auto-clear correlation.....	133
Event consoles.....	134
Event sources.....	139
Creating events manually.....	140
Event classes.....	141
Mapping and transformation.....	142
Event life cycle.....	145
Capturing email messages as events.....	147
SNMP traps and event transforms.....	148
<b>Chapter 10: Production states and maintenance windows.....</b>	<b>154</b>
Production states.....	154
Maintenance windows.....	155
<b>Chapter 11: Organizers and path navigation.....</b>	<b>158</b>
Classes.....	158
Groups.....	161
Systems.....	161
Locations.....	162
Component groups.....	165
Inheritance.....	166
<b>Chapter 12: Distributed monitoring.....</b>	<b>167</b>

About collectors.....	167
About hubs.....	167
About resource pools.....	168
Navigating collectors and hubs.....	168
Adding a hub or collector.....	170
Collector data storage.....	170
Deleting collectors.....	170
Adding devices to collectors.....	170
Moving devices between collectors.....	171
Managing collector daemons.....	171
<b>Chapter 13: User commands.....</b>	<b>172</b>
Defining global user commands.....	172
Running global user commands.....	173
Defining user commands for a single device.....	173
Running user commands for a single device.....	174
Defining user commands for all devices in an organizer.....	174
Running user commands for devices in an organizer.....	175
User command example: Echo command.....	175
<b>Chapter 14: Managing users.....</b>	<b>176</b>
Creating user accounts.....	176
Editing user accounts.....	176
User groups.....	179
Roles.....	180
Device access control lists.....	180
<b>Chapter 15: Reporting.....</b>	<b>184</b>
Organizing reports.....	185
Cisco UCS reports.....	185
Device reports.....	186
Enterprise Reports.....	188
Event reports.....	197
Performance reports.....	198
Graph reports.....	204
Multi-Graph reports.....	206
Creating a custom device report.....	210
Scheduling reports.....	211
<b>Chapter 16: ZenPacks.....</b>	<b>213</b>
Displaying the list of installed ZenPacks.....	213
ZenPack information resources.....	214
Preparing to install or upgrade a ZenPack.....	214
Installing or upgrading a ZenPack.....	215
Removing a ZenPack.....	216
Creating a ZenPack.....	217
<b>Chapter 17: General administration and settings.....</b>	<b>218</b>
Events settings.....	218
Rebuilding the events index.....	219

Audit logging.....	220
Support bundles.....	221
Working with the job manager.....	223
<b>Appendix A: Using the Appliance Administration menu.....</b>	<b>225</b>
Configure Network and DNS.....	225
Configure IPv6 Network CIDR.....	232
Configure Timezone.....	232
Change Docker Hub Credentials.....	233
Change Root Password.....	233
Change ccuser Password.....	234
Update System.....	234
Change SSL settings.....	234
Root Shell.....	236
Reboot / Poweroff System.....	236
<b>Appendix B: Managing Zope instances.....</b>	<b>237</b>
Changing the number of Zope instances.....	237
Dedicated Zope service for reporting.....	237
Dedicated Zope service for Zenoss JSON API use.....	238
Dedicated Zope service for debugging.....	240
<b>Appendix C: SNMP device preparation.....</b>	<b>241</b>
Net-SNMP.....	241
SNMP v3 support.....	241
Community information.....	242
System contact information.....	243
Extra information.....	243
<b>Appendix D: Syslog device preparation.....</b>	<b>244</b>
Forwarding syslog messages from UNIX/Linux devices.....	244
Forwarding syslog messages from a Cisco IOS router.....	244
Forwarding syslog messages from a Cisco CatOS switch.....	245
Forwarding syslog messages using syslog-ng.....	245
<b>Appendix E: TALES expressions.....</b>	<b>247</b>
Examples.....	247
TALES device attributes.....	248
TALES event attributes.....	249
<b>Appendix F: Monitoring large file systems.....</b>	<b>251</b>
Procedure.....	251
<b>Appendix G: Managing multi-realm networks.....</b>	<b>252</b>
Example system.....	252
System setup.....	253
Notes.....	254

**Glossary.....255**

## About this guide

*Zenoss Resource Manager Administration Guide* provides an overview of Zenoss Resource Manager (Resource Manager) architecture and features, as well as procedures and examples to help use and configure the system.

### Related Resource Manager publications

Title	Description
<i>Zenoss Resource Manager Administration Guide</i>	Provides an overview of Resource Manager architecture and features, as well as procedures and examples to help use the system.
<i>Zenoss Resource Manager Configuration Guide</i>	Provides required and optional configuration procedures for Resource Manager, to prepare your deployment for monitoring in your environment.
<i>Zenoss Resource Manager Installation Guide</i>	Provides detailed information and procedures for creating deployments of Control Center and Resource Manager.
<i>Zenoss Resource Manager Planning Guide</i>	Provides both general and specific information for preparing to deploy Resource Manager.
<i>Zenoss Resource Manager Release Notes</i>	Describes known issues, fixed issues, and late-breaking information not already provided in the published documentation set.
<i>Zenoss Resource Manager Upgrade Guide</i>	Provides detailed information and procedures for upgrading deployments of Resource Manager.

### Additional information and comments

If you have technical questions about this product that are not answered in this guide, please visit the [Zenoss Support](#) site or contact Zenoss Support.

Zenoss welcomes your comments and suggestions regarding our documentation. To share your comments, please send an email to [docs@zenoss.com](mailto:docs@zenoss.com). In the email, include the document title and part number. The part number appears at the end of the list of trademarks, at the front of this guide.



# Using Resource Manager

# 1

The browser interface of Resource Manager provides a variety of means for navigating and managing your environment.

## Initial login

The first time you log in to Resource Manager, you will immediately be taken to a startup wizard where you will perform the following tasks:

- Set your admin password
- Set your personal login
- Discover devices (optional)
- Add Infrastructure (optional)

- 1 Launch your Resource Manager application the first time by clicking on the Virtual Host Name in Control Center. You will be presented with the following page showing you the initial steps to follow:

**Figure 1:** Installation Wizard

### Zenoss Installation Wizard

This wizard will guide you through the initial setup of Zenoss. Click Get Started to begin.

The screenshot shows the Zenoss Installation Wizard interface. It features three main steps in light blue boxes:

- Step 1: Setup Users** (with a group of people icon): Set the admin password and create your user account.
- Step 2: Network Discovery** (with a computer icon): Discover devices to monitor.
- Step 3: Add Infrastructure** (with a server rack icon): Manually add the devices in your infrastructure.

A grey button labeled "Get Started »" is located at the bottom right of the wizard area.

- 2 Click **Get Started** to begin the wizard. The Setup Users page appears.

**Figure 2: Setup Users**

### Step 1: Setup Users

**Set admin password**

*The admin account has extended privileges, similar to Linux's root or Windows' Administrator. Its use should be limited to administrative tasks.*

**Password Must:**

- Contain 8 or more characters
- Contain at least one number
- Contain at least one upper and lower case character

Admin password:

Confirm password:

**Create your account**

*Enter information for your personal user account. You'll use this to perform most tasks.*

Username:

Password:

Retype password:

Your email:

« Previous
Next »

- 3 Set your admin password and create your personal user account. Click **Next**. The Network Discovery page appears.

**Figure 3: Network Discovery**

### Step 2: Network Discovery

*Devices found via Discovery will be placed in the /Discovered Device Class*

**Networks/Range**

Enter one or more networks (such as 10.0.0.0/24) or IP ranges (such as 10.0.0.1-50):

Discover

**SNMP**

Community Strings:

**SSH Authentication**

Username:

Password:

**Windows Authentication**

Administrator Username:

Password:

**Discoveries**

Status	Networks	Credentials	Duration	Job Log	Remove
<i>Add network discoveries using the above form</i>					

« Previous
Next »

- 4 You can discover devices by setting networks or IP ranges on this page. If you are not ready to discover devices, you can skip this page and add devices later. For more information about the fields on this page see [Adding, discovering and modeling devices](#) on page 49. When you are ready to continue, click **Next**. The Add Infrastructure page appears.

## Figure 4: Add Infrastructure

### Step 3: Add Infrastructure

**Category**

- CiscoUCS
- ControlCenter
- HTTP
- KVM
- Network
- Ping
- Power
- Printer
- Server
- Storage

**Type**

/CiscoUCS

**Connection Information**

Enter multiple similar devices, separated by a comma, using either hostname or IP Address:

Username: admin

Password: \*\*\*\*\*

Port: 443

Use SSL?:

Add

**Devices**

Status	Host	Credentials	Type	Duration	Job Log	Remove	Retry
Add infrastructure using the above form							

Previous

Finish

- You can add devices from different categories on this page. For each device, select the category, type and enter the connection information. If you are not ready to add devices, you can skip this page. When you are ready to continue, click **Done**. You will be taken to the Dashboard view of Resource Manager.

**Note** When you launch Resource Manager in the future, you will go directly to the login screen.

## Interface and navigation

After you install the system and navigate to the interface from your Web browser, the Dashboard appears. The Dashboard provides at-a-glance information about the status of your IT infrastructure. It is the primary window into devices and events that the system enables you to monitor.

Figure 5: Dashboard

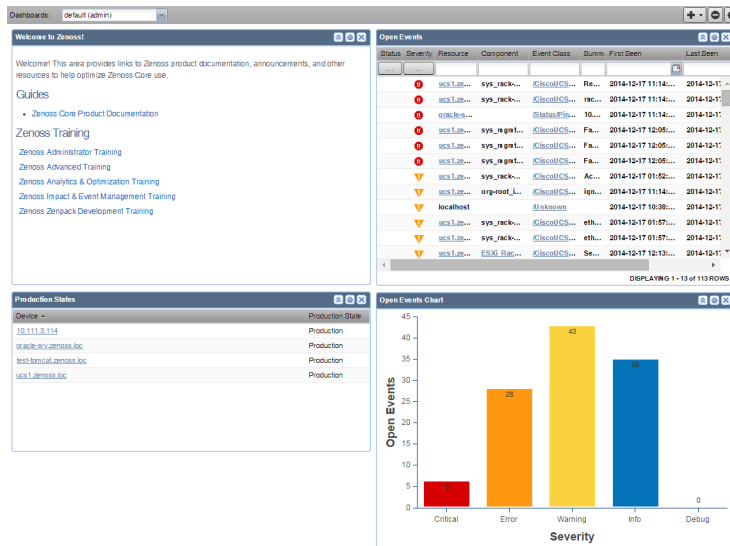

The Dashboard can be customized to display a variety of information including:

- System information resources and other Web pages, such as internal portal pages
- Important error-level device events
- Geographical high-level view
- "Troubled" devices
- Devices in a certain production state You can also create additional dashboards that can be cloned from existing dashboards and can also be restricted to certain users or user groups.

Key Dashboard and interface areas include:

- Navigation menu
- User information area
- Portlets
- System Network Map

## Navigation

The Navigation menu lets you access major system features. In addition to the Dashboard, the menu is divided among several functional areas:

- **EVENTS-** Guides you to the event management area, where you can monitor event status, triggers, and event transforms. You also can track changes made to events.
- **INFRASTRUCTURE-** Offers access to network infrastructure, including, devices, networks, processes, and services.
- **REPORTS-** Allows you access to pre-defined and configurable reports.
- **ADVANCED-** Provides access to monitoring templates, collectors, MIBs, system settings, and tuning.

## User information area

Figure 6: User information area



The user information area offers information and selections:

- **Search**- Search area to find information within the application. Click the down arrow in the search box to manage your saved searches.
- **Login ID**- The ID of the user currently logged in appears at the far left of this area. Click the ID to edit user settings, such as authentication information, roles, and groups. (You also can access user settings from the **ADVANCED > Settings > Users** page.)
- **Sign Out**- Click to log out of the system.
- **Help** icon - Click to access product documentation.

## Portlets

The main content of the Dashboard contains portlets that provide information about the system and infrastructure.

Available portlets are as follows, listed alphabetically:

### Daemon Processes Down

Contains system self-monitoring information.

### Device Chart

Allows the display of a graph of multiple data points for a selected device class.

### Device Issues

Displays a list of devices associated with color-coded events of critical, error, or warning severity levels. To view details, click a device name. To go to the event console for the device, click an event.

**Figure 7: Device Issues Portlet**

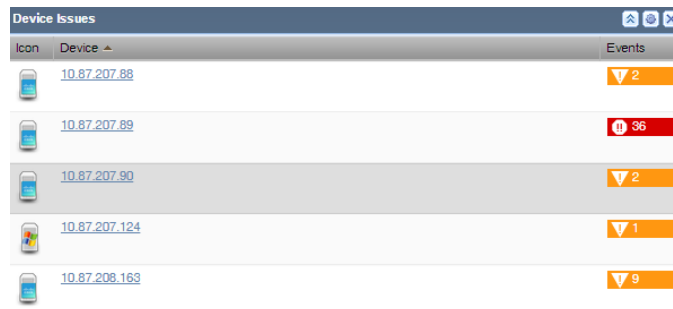

Icon	Device	Events
	<a href="#">10.87.207.88</a>	2
	<a href="#">10.87.207.89</a>	36
	<a href="#">10.87.207.90</a>	2
	<a href="#">10.87.207.124</a>	1
	<a href="#">10.87.208.163</a>	9

### Event View

Displays the list of events similar to the view on the Event console.

### Google Maps

Shows configured device locations and configured network connections.

**Figure 8: Google Maps Portlet**

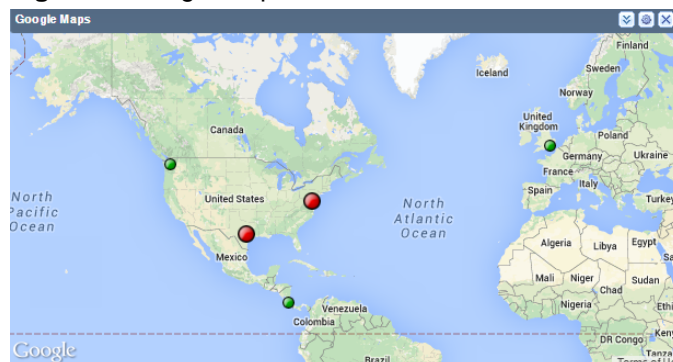

**HTML Portlet**

Displays HTML content. You must use HTML markup in this portlet. If you want to populate a portlet with content from a specific URL, use the **Site Window** portlet instead.

**Multi-Graph Report**

Displays an existing Multi-Graph Report (created by using the **Reports** page). You can choose a specific graph group from the multi-graph report and select the time range for the portlet.

**Network Map**

Displays a network map for a defined network that is being monitored. You can define the refresh interval and level of depth of the map.

**Open Events Chart**

Displays a chart of the number of open events grouped by severity. You can define the event class to be used and the number of past days for which to show events.

**Organizers**

Choose the root organizer (devices, locations, systems, groups) and then child organizer options are enabled.

**Past Events Line Chart**

Displays a line chart of past events grouped by severity. You can define the event class to be used and the number of past days for which to show events.

**Production States**

Shows devices assigned to a particular production state. If needed, you can define multiple production states to display.

**Site Window**

Initially provides links to resources such as product guides, forums, and training events.

You can customize the portlet to display content from any URL. However, Zenoss recommends that you keep a portlet with the default URL so that you can stay up-to-date with Zenoss training and product updates. You can have multiple **Site Window** portlets defined on your Dashboard.

**Watch List**

Allows the display of high-level status device classes, groups, systems, event classes, and locations that you select.

## Customizing the dashboard

---

You can customize the dashboard by:

- Creating multiple dashboards
- Selecting the portlets you want to view
- Arranging portlets
- Defining who can view the dashboard
- Changing the dashboard column layout

The following image shows the Add menu.

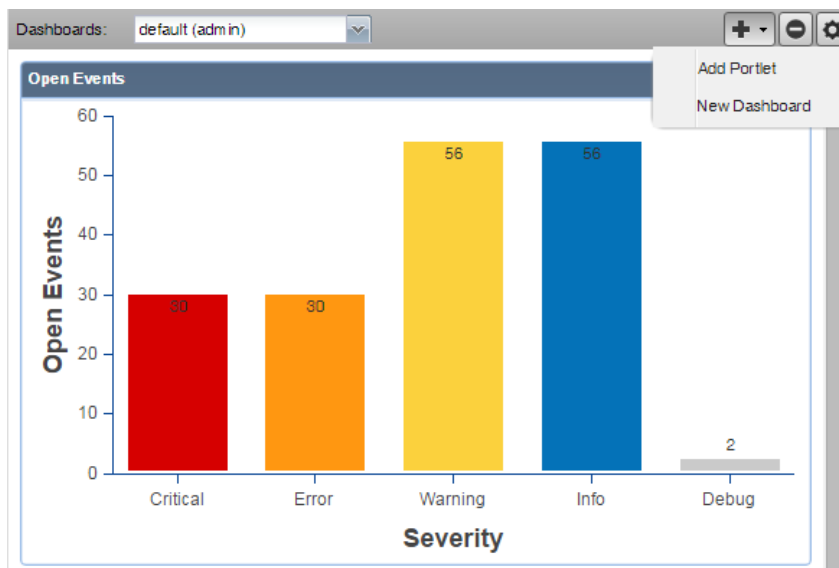

## Adding a dashboard

A default admin dashboard is created when you launch the system. Administrators can customize this dashboard. However, the default dashboard cannot be deleted.

Users that are not administrators initially see a read-only version of the default admin dashboard. Non-administrators can create dashboards that display distinctive information or are targeted to a specific type of user or to only themselves. To customize a dashboard, select who can view it, and select and customize portlets to display the most important information. The number of customized dashboards is not limited.

To create a dashboard:

- 1 From the **Add** icon on the Dashboard controls, select **New Dashboard**.
- 2 Complete fields in the **Add a New Dashboard** dialog box as follows:

### Dashboard Name

When this dashboard name is displayed in the Dashboards drop-down list, the user name who created it is appended as part of the name. This convention gives everyone who can see the dashboard an indication of who created it.

**Who can view this Dashboard?**

Choose who can view this dashboard. To specify a **User Group**, the group must exist in the system and the user name used to create this dashboard must be a member of the group. You can only assign dashboards to groups to which you belong.

**Number of Columns**

Choose the number of columns to display in the dashboard. The default is 3.

**Clone from dashboard**

If you want the new dashboard to be a clone of the dashboard you were previously viewing, select the check box. Otherwise, you begin with a completely blank dashboard.

- 3 Click **Create**.

**Adding portlets**

You can customize your dashboard by adding portlets that display information you are interested in. Your dashboard can display more than one of the same portlet type. For example, you could have several Device Chart portlets with each one showing a different device class.

To add a portlet to the Dashboard:

- 1 Click the **Add** icon in the top right of the Dashboard main area and select **Add portlet**.
- 2 Select a portlet from the drop-down list. The portlet appears at the top right of the Dashboard main area

**Arranging portlets**

To arrange portlets, click the portlet header and drag the portlet to any location on the dashboard. The other portlets are automatically rearranged.

**Editing the dashboard settings**

Customize your dashboard to display a different number of columns or limit access to the dashboard.

- 1 Click the **Action** icon in the upper-right side of the dashboard. The **Edit Dashboard** window appears.

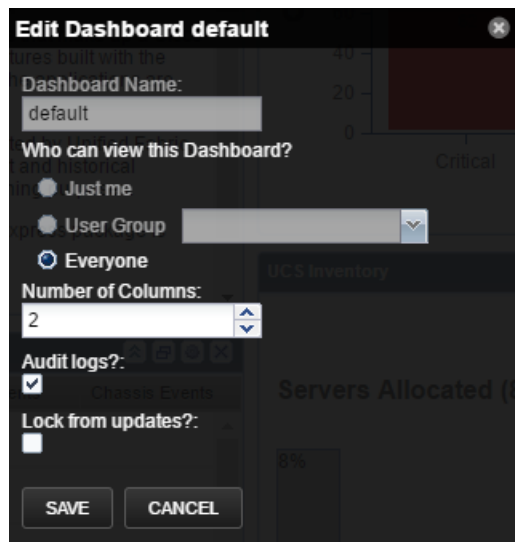

- 2 Change the value of the users who can view this dashboard.

**User groups:** To enable a user group to view the dashboard, the group must exist in the system and you must be logged in with credentials of a member of the user group.



- 3 Change the number of columns to use in this dashboard if needed.
- 4 To ensure that changes are logged properly, verify the **Audit logs** setting. Clear the check box if you do not want logging on any changes.
- 5 Select **Lock from updates** to prevent editing of the dashboard.
- 6 Click **Save**.

## Working with portlets

There are several options to control the portlet display.

**Figure 9:** Dashboard Portlet Controls

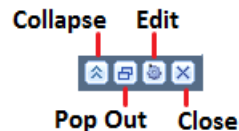

- Click the **Collapse** icon to collapse the portlet so that only the title appears on the dashboard.
- Click the **Pop Out** icon to show the portlet in a full screen view. Click **Close** to return to the dashboard view.
- Click the **Edit** icon to edit the portlet settings. You can edit the title of the portlet, its height and how often it refreshes. Some portlets may have additional configuration options. A preview of the portlet is provided on the right side of the dialog box. Click **Save** to update the portlet configuration.
- Click the **Close** icon to remove the portlet from the dashboard.

In tabular portlets, you can control the display by sorting columns as well as adding and hiding columns.

- To sort based on a column, hover over the column header and click the arrow to display the sort and display options.
- To add or hide columns, hover over the **Columns** entry and check or clear the boxes of the columns to add or hide.

Status	Severity	Resource	Component	Event Class	Summary	First Seen	Last Seen	Count
		qa-centos-7-s...		Sort Ascending	SNMP agent dow...	2016-09-27 05:08:22 ...	2016-09-27 10:48:50 ...	69
		qa-centos-5-s...		Sort Descending	SNMP agent dow...	2016-09-27 05:08:59 ...	2016-09-27 10:49:44 ...	69
		Cisco_10.171...		Columns	2016-09-27 05:09:18 ...	2016-09-27 10:47:02 ...	69	
		Cisco_10.171...	s10	/PerfIn	2016-09-27 05:09:19 ...	2016-09-27 10:47:02 ...	69	
		nexus-5k.zeno...	VSAN0080...	/Status	2016-09-27 05:09:49 ...	2016-09-27 10:48:56 ...	69	
		nexus-5k.zeno...	VSAN0001...	/Status	2016-09-27 05:09:50 ...	2016-09-27 10:48:57 ...	69	
		N6001-2	Fex-108 A/...	/Status	2016-09-27 05:12:24 ...	2016-09-27 10:47:36 ...	68	
		N6001-2	Fex-108 P...	/Status	2016-09-27 05:12:24 ...	2016-09-27 10:47:36 ...	68	
		N6001-2	Fex-109 A/...	/Status	2016-09-27 05:12:24 ...	2016-09-27 10:47:36 ...	68	
		N6001-2	Fex-115 A/...	/Status	2016-09-27 05:12:24 ...	2016-09-27 10:47:36 ...	68	
		N6001-2	Fex-131 P...	/Status	2016-09-27 05:12:24 ...	2016-09-27 10:47:36 ...	68	
		N6001-2	Fex-114 P...	/Status	2016-09-27 05:12:24 ...	2016-09-27 10:47:36 ...	68	
		N6001-2	Fex-110 A/...	/Status	2016-09-27 05:12:24 ...	2016-09-27 10:47:36 ...	68	

## Search

The Resource Manager search facility supports locating devices and other system objects, as well as events and services.

In the Resource Manager interface, the search feature is part of the user information area. Enter part or all of a name in the search box at the top right of the interface. The system displays matches, categorized by type.

**Figure 10: Search Results**

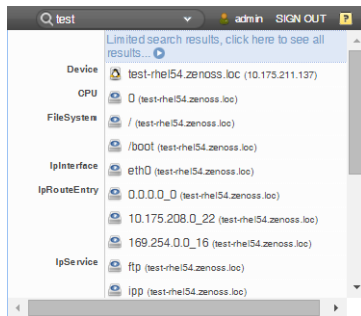

To view all search results, click the indicator at the top of the list.

**Figure 11: All Search Results**

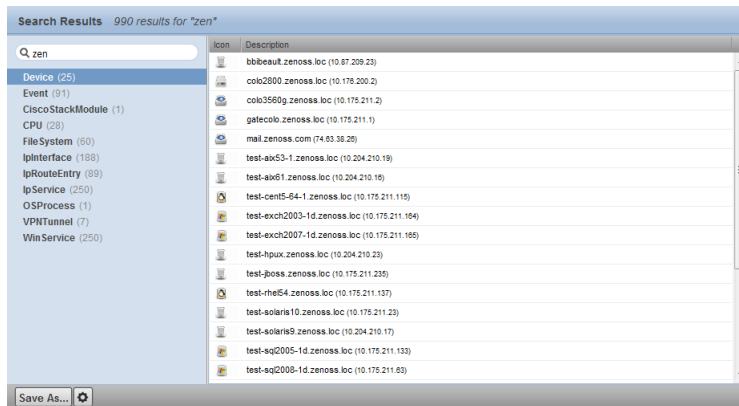

From here, you can display search results by category. Click in the left panel to filter search results by a selection.

You can save the search to access later.

- 1 Click **Save As** (at the bottom left of the Search Results page). The Save Search As dialog box appears.
- 2 Enter a name for the search, and then click **Submit**.

You can access saved searches from:

- Action menu located at the bottom of the Search Results page.
- Search box located at the top of the interface. Click the arrow, and then select **Manage Saved Searches**.

## Navigating the event console

The event console is the system's central nervous system, enabling you to view and manage events. It displays the repository of all events that are detected by the system.

To access the event console, click **Events** in the Navigation menu. The Event Console appears.

Figure 12: Event Console

Status	Severity	Resource	Component	Event Class	Summary	First Seen	Last Seen	Count
		ucs1	Fan 3/4/2		Fan 2 in Fan Module 1-4 under chassis 3 speed: lower-non-recoverable	2015-07-29 08:44:33 am	2015-07-29 10:29:40 am	3
		ucs1	extpol_reg_clients_client...		UCS Domain ucs1-faba is registered with UCS Central without a valid license.	2015-07-29 08:44:33 am	2015-07-29 10:29:40 am	4
		ucs1	Fan Module 3/4		Fan 2 in Fan Module 1-4 under chassis 3 speed: lower-non-recoverable	2015-07-29 08:45:41 am	2015-07-29 08:45:41 am	1
		ucs1	fabric_san_A_phys-fcoes...		FCoE uplink port 1/8 is down	2015-07-29 08:44:33 am	2015-07-29 10:29:40 am	4
		ucs1	Fan 3/4/2		Fan 2 in Fan Module 1-4 under chassis 3 operability: inoperable	2015-07-29 08:44:33 am	2015-07-29 10:29:40 am	3

## Sorting and filtering events

You can sort and filter events that appear in the event console to customize your view.

You can sort events by any column that appears in the event console. To sort events, click a column header. Clicking the header toggles between ascending and descending sort order.

Filter options appear below each column header. A match value can be any full string or a subset of a string, optionally with the wildcard (\*) contained in the values in that column. You can also use " | |" (OR), or " ! !" (NOT) expressions to further target your filters. For example, typing ! ! windows in the Event Class filter will return all the non-Windows device events.

Figure 13: Event Console filter options

Status	Severity	Resource	Component	Event Class	Summary	First Seen	Last Seen	Count
<input checked="" type="checkbox"/>		ucs1	Fan 3/4/2		Fan 2 in Fan Module 1-4 under chassis 3 speed: lower-non-recoverable	2015-07-29 08:44:33 am	2015-07-29 10:29:40 am	3
<input checked="" type="checkbox"/>		ucs1	extpol_reg_clients_client...		UCS Domain ucs1-faba is registered with UCS Central without a valid license.	2015-07-29 08:44:33 am	2015-07-29 10:29:40 am	4
<input type="checkbox"/>		ucs1	Fan Module 3/4		Fan 2 in Fan Module 1-4 under chassis 3 speed: lower-non-recoverable	2015-07-29 08:45:41 am	2015-07-29 08:45:41 am	1
<input type="checkbox"/>		ucs1	fabric_san_A_phys-fcoes...		FCoE uplink port 1/8 is down	2015-07-29 08:44:33 am	2015-07-29 10:29:40 am	4
<input type="checkbox"/>		ucs1	Fan 3/4/2		Fan 2 in Fan Module 1-4 under chassis 3 operability: inoperable	2015-07-29 08:44:33 am	2015-07-29 10:29:40 am	3
<input type="checkbox"/>		ucs1	Fabric FC SAN Port Chan...		san port-channel 5 on fabric interconnect A oper state: failed, reason: No operatio...	2015-07-29 08:44:33 am	2015-07-29 10:29:40 am	4
<input type="checkbox"/>		ucs1	Fabric FC SAN Port Chan...		san Member 1/27 of Port-Channel 5 on fabric interconnect A is down, membership:...	2015-07-29 08:46:12 am	2015-07-29 10:29:40 am	4

You can filter the events that appear in the list in several ways, depending on the field type:

- **Resource** - Enter a match value to limit the list.
- **Component** - Enter a match value to limit the list.
- **Event Class** - Enter a match value to limit the list.
- **Summary** - Enter a match value to limit the list.
- **First Seen** - Enter a value or use a date selection tool to limit the list.
- **Last Seen** - Enter a value or use a date selection tool to limit the list.
- **Count** - Enter a value to filter the list, as follows:
  - *N* - Displays events with a count equal to *N*.
  - *:N* - Displays events with a count less than or equal to *N*.
  - *M:N* - Displays events with a count between *M* and *N* (inclusive).
  - *M:* - Displays events with a count greater than or equal to *M*.

To clear filters, select **Configure > Clear filters**.

You also can re-arrange the display order of columns in the event console. Click-and-drag column headers to change their display.

## Creating an actionable view

For users that are not Administrators, an option filters the list of events to show only those that are not read-only for the user's permission level, and enable the action buttons above the event table header.

To turn on the actionable view, click **Configure** and select the **Only show actionable events** check box. The view is changed to show only events that can have an action performed on them based on the user's permission level. For more information, see [Managing events](#) on page 21.

## Saving a custom view

Save a custom event console view by bookmarking it for quick access.

- 1 Select **Configure > Save this configuration**.
- 2 In the dialog box, select the link, and then drag it to the bookmarks area of the browser window.

**Figure 14:** Saving a custom view (bookmark)

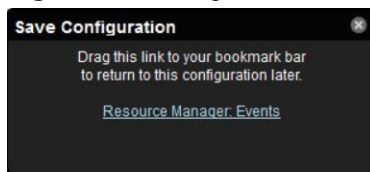

The browser adds a link to the bookmarks list.

- 3 Change the title of the bookmark to distinguish this event console view.

## Refreshing the view

You can refresh the list of events manually or specify that they refresh automatically. To manually refresh the view, click **Refresh**. You can manually refresh at any time, even if you have an automatic refresh increment specified.

To configure automatic refresh, select one of the time increments from the Refresh list. By default, automatic refresh is enabled and set to refresh each minute.

**Figure 15:** Automatic refresh selections

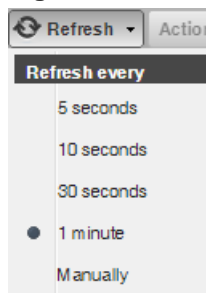

## Viewing event details

You can view details for any event in the system. To view details, double-click an event row.

---

**Note** Do not double-click on or near the device (resource) name, component, or event class in the row. Doing this displays details about that entity, rather than information about the event.

---

The Event Detail area appears.

Figure 16: Event Detail

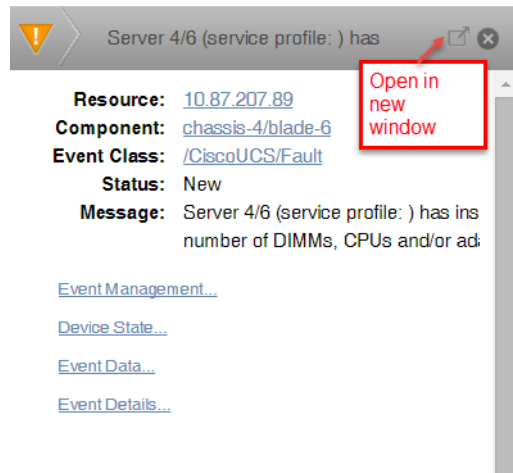

To see more information about the event, click **Event Details**.

You can use the Log field (located at the bottom of the area) to add specific information about the event. Enter details, and then click **Add**.

## Selecting events

To select one or more events in the list:

- To select a single event, click a row.
- To select multiple events, Ctrl-click each row or Shift-click rows to select a range of events.
- To select all events, click **Select > All**.

## Managing events

Use the event console to manage events or add an event. Click an event row and use the following tools to perform actions.

Figure 17: Event Management Options

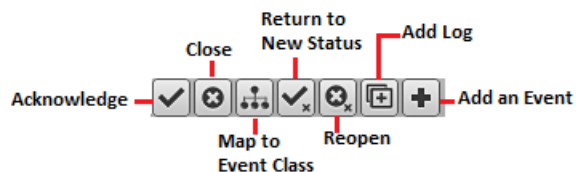

- Acknowledge the event.
- Close the event.
- Reclassify the event by associating it with a specific event class.
- Return the event to New status (revoke its Acknowledged status).
- Reopen the event.
- Add a note to the log.
- Add an event. This feature is useful for testing a specific condition by simulating an event.

You also can

## Running a command from the browser interface

Resource Manager allows commands to be run through the browser interface. You can run commands on a single device or on a group of devices.

The system includes several built-in commands, such as `ping` and `traceroute`.

To run commands from the browser interface:

- 1 Navigate to the **INFRASTRUCTURE** tab.
- 2 In the **Devices** list, select one or more devices.  
To select a device, click anywhere in the row—except on the link.
- 3 Click **Commands** and select a command from the list.

**Figure 18: Command Output**



You can resize the command output window. You also can stop automatic scrolling by de-selecting the Autoscroll option at the bottom right corner of the output window.

## Working with triggers and notifications

You can create *notifications* to send email or pages, create SNMP traps, or execute arbitrary commands in response to an event. Use notifications to notify other management systems and execute arbitrary commands to drive other types of integration. How and when a notification is sent is determined by a *trigger* that specifies a rule (one or more conditions).

To set up a notification:

- Create a trigger by defining rules.
- Create a notification by selecting one or more triggers that cause it to run.
- Choose appropriate options and subscribers depending on the notification type.

### Working with triggers

Setting up a trigger involves:

- Creating the trigger and the rules that define it
- Setting trigger permissions

## Creating a trigger

This procedure describes how to create a trigger.

- 1 Select **EVENTS > Triggers**.

The Triggers page displays all defined triggers.

- 2 Click the **Add** icon.

- 3 In the **Add Trigger** dialog, enter a name for the trigger, and then click **Submit**.

Only uppercase letters, lowercase letters, digits, and underscores are allowed in trigger names.

The trigger is enabled and added to the list.

To complete the trigger, proceed to the next task.

## Editing a trigger

This procedure describes how to edit a trigger.

- 1 Select **EVENTS > Triggers**.

The Triggers page displays all defined triggers.

- 2 Open the **Edit Trigger** dialog box of the trigger to edit.

In the **Triggers** table, double-click a trigger, or select a trigger and then click the **Action** icon.

**Figure 19:** Edit Trigger dialog box

- 3 Define rules for the trigger, and then click **SUBMIT**.

Trigger rules combine Boolean logic with event values to decide whether to send notifications. A trigger can use any or all of its rules to make a decision, and each rule can have subordinate rules or branches.

---

**Note** Device production states can change during maintenance windows. If you want the same trigger to apply during maintenance windows, be sure to edit your trigger to account for all production states that apply to your trigger.

---

## Setting global trigger permissions

You can set global permissions for viewing, editing, and managing triggers. Global permissions are given to any user with "manage" permission, which includes:

- Admin, Manager, and ZenManager roles
- Trigger owner

Edit global permissions from the Users tab on the Edit Trigger dialog.

Global options are:

- **Everyone can view** - Provides global view permission.

- **Everyone can edit content** - Provides global update permission.
- **Everyone can manage users** - Provides global manage permission.

**Figure 20:** Edit Trigger - Users tab

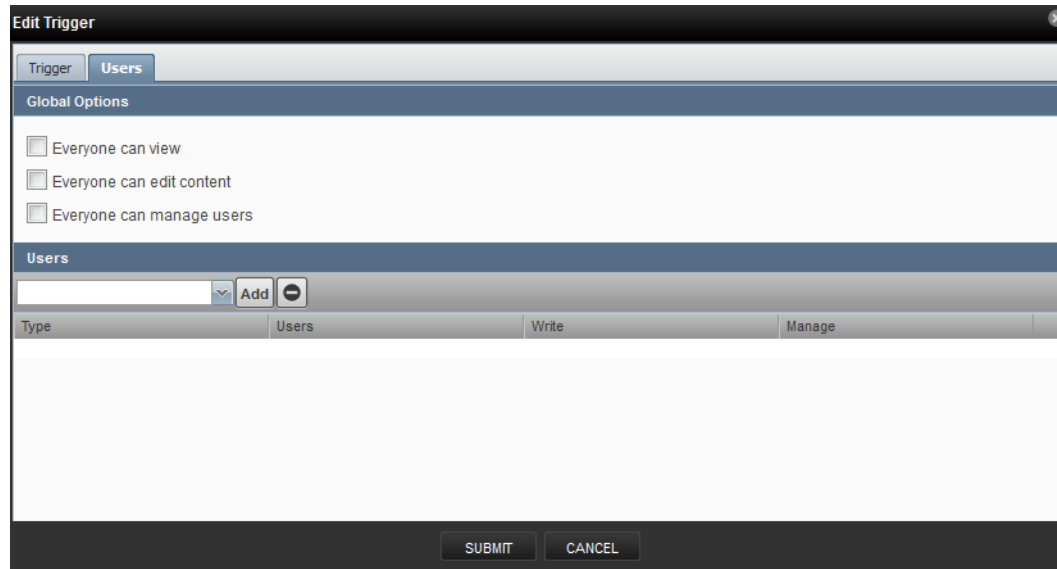

### Setting individual trigger permissions

You can grant permissions to individual users.

- **Write** - Select this option to grant the user permission to update the trigger.
- **Manage** - Select this option to grant the user permission to manage the trigger.

To set an individual's trigger permissions:

- 1 In the **Edit Trigger** dialog box **Users** section, choose a user.
- 2 Click **Add**.
- 3 Select check boxes for the permissions to assign.
- 4 Repeat these steps to add more user trigger permissions.
- 5 Click **Submit**.

To remove an individual's trigger permissions:

- 1 Select the row of the user's permissions.
- 2 Click the **Remove** icon.
- 3 Repeat these steps to remove other user trigger permissions.
- 4 Click **Submit**.

## Working with notifications

Setting up a notification includes the following tasks:

- Create the notification.
- Define notification content (for email- or page-type notifications).
- Define the SNMP trap host (for SNMP trap-type notifications).
- Define commands to run (for command-type notifications).
- Set notification permissions.



- Set up notification schedules.

### Creating a notification

This procedure describes how to edit a notification.

- 1 Select **EVENTS > Triggers**.
- 2 In the left panel, select **Notifications**.

**Figure 21: Notifications**

Notifications		Notification Schedules					
Enabled	ID	Trigger	Action	Subscribers	Enabled	ID	Start
Yes	rancid-run	rancid-run	command	0	No	test	1/14/2015

The **Notifications** area includes a table of notifications and a table of notification schedules.

- 3 Click the **Add** icon.
- 4 In the **Add Notification** dialog, provide a name and specify an action.
  - a Enter the **Id** of the notification.  
Spaces are not allowed in notification Ids.
  - b Associate an action with the notification.  
For more information, see [Notification actions](#) on page 25.
  - c Click **SUBMIT**.

To complete the notification, proceed to the next task.

### Notification actions

Action	Description
Command	Invoke a shell command when events occur. Common uses of this action include: <ul style="list-style-type: none"> <li>■ <i>Auto-remediation of events.</i> You can use <code>ssh</code> or <code>wincommand</code> to restart services on Linux and Windows devices.</li> <li>■ <i>Integration with external systems.</i> For example, opening tickets in an incident management system.</li> <li>■ <i>Extending alerting mechanisms.</i> Resource Manager supports email and pagers as alerting mechanisms "out of the box" through normal alerting rules.</li> </ul>
Email	Sends an HTML or text email message to authorized subscribers when an event matches a trigger rule.
Syslog	Sends a message to the syslog.
SNMP Trap	Sends an SNMP trap when an event matches a trigger rule.
WinCommand	Sends or clears a Windows CMD command.

### Editing a notification

This procedure describes how to edit a notification.

- 1 Select **EVENTS > Triggers**.
- 2 In the left panel, select **Notifications**.

**Figure 22: Notifications**

Triggers		Notifications				Notification Schedules		
+		+				+		
Enabled	ID	Trigger	Action	Subscribers	Enabled	ID	Start	
Yes	rancid-run	rancid-run	command	0	No	test	1/14/2015	

The **Notifications** area includes a table of notifications and a table of notification schedules.

- 3 Open the **Edit Notification** dialog of the notification to edit.  
In the **Notifications** table, double-click a notification, or select a notification and then click the **Action** icon.

**Figure 23: Edit Notification**

**Edit Notification - ExampleNotification (email)**

Notification | Content | Subscribers

Enabled:  Delay (seconds): 0

Send Clear:  Repeat (seconds): 0

Send only on Initial Occurrence?:

Triggers

Trigger: [ ] Add

SUBMIT CANCEL

- 4 Define the settings for the notification.  
For more information, see [Notification settings](#) on page 26.

**Notification settings**

Setting	Description
Enabled	Check the checkbox to enable the notification.
Send Clear	Send a notification when the problem is resolved by a clearing event.
Send only on Initial Occurrence	Send a notification only when the first triggering event occurs.
Delay (seconds)	The minimum number of seconds to wait before performing a notification. A delay prevents notifications of transient problems and multiple notifications of the same problem.  For example, if five events that match the trigger occur in 45 seconds, a delay of 60 seconds ensures that only one notification is sent. Also, if a triggering event repeats 15 seconds after the initial event, followed by a clearing event at 45 seconds, a 60-second delay ensures that no notifications are sent.
Repeat (seconds)	The interval between repetitions of the notification, in seconds. The notifications repeat until the triggering event is resolved.

## Defining notification content

To define notification content, click the **Content** tab.

For email-type notifications, you can use the default configuration for the following fields, or customize them:

- **Body Content Type** - Select HTML or text.
- **Message (Subject) Format** - Sent as the subject of the notification.
- **Body Format** - Sent in the notification.
- **Clear Message (Subject) Format** - Sent when a notification clears.
- **Body Format** - Sent when a notification clears.
- **From Address for Emails** - Sent as the sender's email address.
- **Various SMTP settings** - Used to define SMTP host, port, user name, and password. To set these system-wide, use the **ADVANCED > Settings** page.

**Figure 24:** Define notification content (email)

**Edit Notification - ExampleServiceEmailNotification (email)**

Notification **Content** Subscribers

Body Content Type:

Message (Subject) Format:

Body Format:

```
Device: ${evt/device}
Component: ${evt/component}
Severity: ${evt/severity}
Time: ${evt/lastSeen}
Message:
${evt/message}
<a tal:attributes="href urls/eventUrl">Event Detail</a>
<a tal:attributes="href urls/ackUrl">Acknowledge</a>
<a tal:attributes="href urls/closeUrl">Close</a>
<a tal:attributes="href urls/eventsUrl">Device Events</a>
The following events are causes of this event:
<tal:block tal:repeat="item esa/causes">
Impact Chain: ${item/impactChain}
Device: ${item/evt/device}
Component: ${item/evt/component}
Severity: ${item/evt/severity}
Time: ${item/evt/lastSeen}
Message:
${item/evt/message}
<a tal:attributes="href item/urls/eventUrl">Event Detail</a>
<a tal:attributes="href item/urls/ackUrl">Acknowledge</a>
<a tal:attributes="href item/urls/closeUrl">Close</a>
<a tal:attributes="href item/urls/eventsUrl">Device
Events</a>
</tal:block>
```

Clear Message (Subject) Format:

Body Format:

```
Event: '${evt/summary}'
Cleared by: '${evt/id}'
At: ${evt/stateChange}
Device: ${evt/device}
Component: ${evt/component}
Severity: ${evt/severity}
Message:
${evt/message}
<a href="${urls/reopenUrl}">Reopen</a>
```

SUBMIT CANCEL

For page-type notifications, you can use the default configuration for the following fields, or customize them:

- **Message (Subject) Format** - Sent as the subject of the notification.
- **Clear Message (Subject) Format** - Sent when a notification clears.

**Figure 25:** Edit Notification content (page)

### Notification content variables

Within the body of email, page, and command notifications, you can specify information about the current event in the following form:

```
'${objectname/objectattribute}'
```

**Note** Do not escape event command messages and event summaries. For example, write this command as: `${evt/summary}` (rather than `echo '${evt/summary}'`).

Object names can be `evt`, `evtSummary`, or `urls`; or for clearing event context, `clearEvt` and `clearEventSummary`. For each object name, the following lists show valid attributes (for example, `'${evt/DevicePriority}'`):

**Table 1:** `evt/` and `clearEvt/`

Value	Description
DevicePriority	value of the priority of the device
agent	Typically the name of the daemon that generated the event. For example, an SNMP threshold event has <i>zenperfsnmp</i> as its agent.
clearid	id of the event this clear event will clear
component	component this event is related to
count	how many times this event occurred

Value	Description
created	when the event was created
dedupid	dynamically generated fingerprint that allows the system to perform de-duplication on repeating events that share similar characteristics
device	device this event is related to
eventClass	class of this event
eventClassKey	Free-form text field that is used as the first step in mapping an unknown event into an event class.
eventGroup	Free-form text field that can be used to group similar types of events. This is primarily an extension point for customization. Currently not used in a standard system.
eventKey	Free-form text field that allows another specificity key to be used to drive the de-duplication and auto-clearing correlation process.
eventState	state of the event
evid	unique id for the event
facility	the syslog facility
firstTime	UTC Time. First time that the event occurred.
ipAddress	IP address
lastTime	UTC time. Most recent time that the event occurred.
manager	value of manager
message	a message communicated by the event
ntevid	windows event id
ownerid	ownerid
priority	syslog priority
prodState	production state of the device
severity	the severity of the event expressed as a number (0, 1, 2, 3, 4, or 5)
severityString	the severity of the event expressed as a string (Clear, Debug, Info, Warning, Error, or Critical)
stateChange	last time that the event status changed
status	the status of the event
summary	a short message summarizing the event

**Note** Some of the values in the following table are direct duplicates of fields on `evt`. For example, `uuid` -> `evt.evid`.

**Table 2: eventSummary/ and clearEventSummary/**

Value	Description
uuid	evt.evid

Value	Description
occurrence	evt.count
status	evt.eventState
first_seen_time	evt.firstTime
status_change_time	evt.stateChange
last_seen_time	evt.lastTime
count	evt.count
current_user_uuid	UUID of the user who acknowledged this event
current_user_name	name of the user who acknowledged this event
cleared_by_event_uuid	UUID of the event that cleared this event (for events with status == CLEARED)
notes	event notes
audit_log	event audit log
update_time	last time a modification was made to the event
created_time	evt.lastTime
fingerprint	evt.dedupid
event_class	evt.eventClass
event_class_key	evt.eventClassKey
event_class_mapping_uuid	If this event was matched by one of the configured event class mappings, it contains the UUID of that mapping rule.
actor	event actor
summary	evt.summary
message	evt.message
severity	evt.severity
event_key	evt.eventKey
event_group	evt.eventGroup
agent	evt.agent
syslog_priority	evt.priority
syslog_facility	evt.facility
nt_event_code	evt.ntevid
monitor	evt.monitor
tags	event tags

**Table 3: urls/**

Value	Description
ackUrl	URL for acknowledging the event

Value	Description
closeUrl	URL for closing the event
reopenUrl	URL for reopening the event
eventUrl	URL for viewing the event
eventsUrl	URL for viewing events for the relevant device, or all events

ZenPacks can define additional notification actions and can extend the context that is available to notifications to add objects or attributes.

### Defining the SNMP trap host

For SNMP trap-type notifications, on the **Edit Notification Content** tab, provide the following information:

- **SNMP Trap Destination** - Specify the host name or IP address to which the trap should be sent.
- **SNMP Community**- Specify the SNMP community. By default, this is public.
- **SNMP Version**- Select v2c (default) or v1.
- **SNMP Port**- Specify the SNMP port. Typically, this is 162.

SNMP traps sent as a result of this notification are defined in the ZENOSS-MIB file. You can find this MIB file on any Resource Manager server at `$ZENHOME/share/mibs/site/ZENOSS-MIB.txt`.

**Figure 26:** Edit Notification Content (SNMP trap)

The screenshot shows a dialog box titled "Edit Notification - test\_trap (trap)". It has three tabs: "Notification", "Content", and "Subscribers". The "Content" tab is selected. The form contains the following fields:

- SNMP Trap Destination:
- SNMP Community:
- SNMP Version:  (dropdown menu)
- SNMP Port (usually 162):  (spin box)

At the bottom of the dialog, there are two buttons: "SUBMIT" and "CANCEL".

### Defining commands to run

For command-type notifications, specify the command to run when configured triggers are matched. On the **Edit Notification Content** tab, provide the following information:

For SNMP trap-type notifications,

- **Command Timeout** - By default, 60 seconds.
- **Command** - Command to run when a trigger is matched.
- **Clear Command** - Optional command to run when the triggering event clears.
- **Environment variables** - Optional field to define any environmental variables.

**Figure 27: Edit Notification Content (command)**

### Global notification permissions

By establishing permissions, you can control which users have the ability to view, manage, and update notifications. Permissions are granted based on the user's assigned role. The following table lists account roles and their associated notification permissions:

Role	Permissions
Admin, Manager, ZenManager	Users assigned the Admin, Manager, or ZenManager roles can view, update, and manage any notification.
Notification owner	When a user creates a notification, that user is designated the owner of that notification. During the life of the notification, the owner can view, update, and manage it.
All other users (including those assigned ZenUser and ZenOperator roles)	Must be specifically granted permissions through the interface to view, edit, or manage notifications.

You can set global permissions for viewing, updating and managing a notification. Global permissions are given to any user with "manage" permission, which includes:

- Admin, Manager, and ZenManager roles
- Notification owner

Edit global permissions from the Subscribers tab on the Edit Notification Subscription panel.

Global options are:

- **Everyone can view** - Provides global view permission.



- **Everyone can edit content** - Provides global update permission.
- **Everyone can manage subscriptions** - Provides global manage permission.

Permission checks occur when the data is sent to the browser and when any action occurs. To determine where a user can make modifications to a particular tab, permission checks are performed on global roles, then managerial roles, and then individual roles. Any role that provides the required permission will allow that permission's associated behavior.

**Figure 28: Edit Notification**

Type	Subscribers	Write	Manage
user	adm in (User)	<input type="checkbox"/>	<input type="checkbox"/>

### Setting individual notification permissions

You can grant permissions to individual users or groups.

- **Write** - Select this option to grant the user or group permission to update the notification.
- **Manage** - Select this option to grant the user or group permission to manage the notification.

You can manually enter in the name of a user or group, or select one from the list of options.

### Adding notification schedules

You can establish one or more notification schedules for each defined notification. These notification schedules allow you to receive bulk email notifications at a specific time.

---

**Note** If a notification has one or more notification schedules, then notifications are sent only if a schedule is active when a notification arrives.

---

To set up a schedule:

- 1 In the **Notifications** area on the left, select a notification.
- 2 In the **Notification Schedules** area on the right, click **Add**.

**Figure 29:** Add Schedule Window dialog box

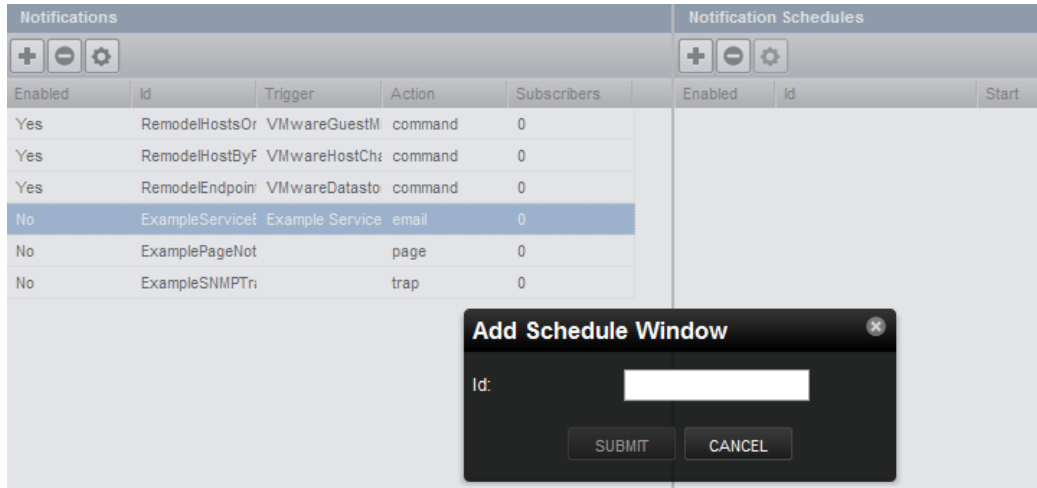

- 3 In the **Add Schedule Window** dialog box, enter an identifier for the schedule, and then click **Submit**.
- 4 In the **Notification Schedules** area, double-click the new schedule.  
The **Edit Notification Schedule** dialog box opens. For information about the fields, see the next topic.

**Figure 30:** Edit Notification Schedule

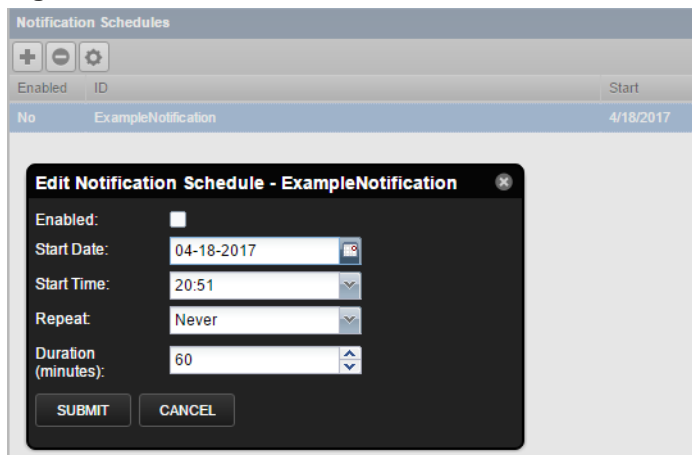

- 5 Click **Submit**.

**Notification schedule fields**

Field	Description
<b>Enabled</b>	Check the box to enable the schedule.
<b>Start Date</b>	The calendar date of the start of the schedule.
<b>Start Time</b>	The time of day of the start of the schedule.
<b>Repeat</b>	The schedule frequency, one of the following values: <ul style="list-style-type: none"> <li>■ Never</li> <li>■ Daily</li> <li>■ Every Weekday</li> <li>■ Weekly</li> <li>■ Monthly</li> </ul>

Field	Description
	<ul style="list-style-type: none"> <li>■ First Sunday of the Month</li> </ul>
<b>Duration (Minutes)</b>	The period of time during which the notification window is active.

## Advanced user interface configuration

To access advanced user interface configuration options, select **ADVANCED > Settings**, and then select **User Interface**. Configure options such as how data loads, how much data is loaded, and filter and search options.

- **Enable Hyperlinks in Event Fields**- Click to enable this option to show hyperlinks in event fields. By default, this feature is disabled.
- **Enable Infinite Grids for Events**- Disable this option to turn off infinite grids for events. By default, this feature is enabled.
- **Enable Infinite Grids for Components**- Disable this option to turn off infinite grids for components. By default, this feature is enabled.
- **Enable Live Filters**- Disable this option to turn off the live filters feature. If you disable this feature, you will need to press enter on all search and filter inputs.
- **Enable Incremental Tree Loading on the Infrastructure Page**- Enable this option to load the infrastructure tree one node at a time. If disabled (the default), then the infrastructure tree is loaded all at once. You might enable this option if you have a complex hierarchy of organizers and device classes and want to improve your UI load response time.
- **Show Tree Event Severity Icons**- Disabling this option may speed up page loading.
- **Enable Tree Filters**- If disabled, then tree filters (the text input area that allows you to filter the information displayed) are hidden on all pages. This option is enabled by default.
- **Show Page Statistics**- Enable this option to show debugging information. By default, this option is not enabled.
- **Device Grid Buffer Size**- Specify the number of device data rows to fetch from the server for each buffer request. The default buffer size is 100 rows.
- **Component Grid Buffer Size**- Specify the number of component data rows to fetch from the server for each buffer request. The default buffer size is 50 rows.
- **Event Console Buffer Size**- Specify the number of event rows to fetch from the server for each buffer request. The default buffer size is 200 rows.
- **Device Move Job Threshold**- Specify the limit at which devices are moved immediately. If the number of devices to be moved exceeds this threshold, then the move occurs in a job; otherwise, they are moved immediately. The default value is 5 devices.
- **Job Notification Refresh Interval**- Specify the refresh interval for the job notification dialog. The default time is 10 seconds.
- **Job Grid Buffer Size**- Specify the number of job data rows to fetch from the server for each buffer request. The default buffer size is 100 rows.

When complete, click **Save** to save your changes.

## LDAP authentication

You can use your existing LDAP authentication infrastructure, such as Active Directory or OpenLDAP, to enable single sign-on to the Resource Manager interface. With this capability, you can use the user management tools with which you are familiar to enable your Windows users to use their Windows credentials to authenticate to the Resource Manager interface. This saves you from having to manually create user accounts and separately maintain passwords.

For those LDAP properties that are mapped, changes you make in LDAP are updated in Resource Manager. (You must clear your browser cache, or log out and back in, for properties changes to propagate immediately.)

## LDAP configuration information

Before configuring LDAP authentication, gather the following information from your LDAP or Active Directory administrator:

- Host name or IP address of an Active Directory global catalog server (for Active Directory authentication)
- Host name or IP address of an LDAP server (for other LDAP server authentication)
- User's base distinguished name (DN)
- Manager DN
- Manager password
- Groups base DN
- Optionally, list of Active Directory groups to map to Resource Manager roles

## Configuring LDAP authentication

You can configure LDAP authentication at initial setup, or from the **Settings** area of the browser interface as follows:

- While in the setup wizard, at Step 2: Specify or Discover Devices to Monitor, click **LDAP Setup** (located at the bottom right of the wizard panel).
- From the interface, select **ADVANCED > LDAP** and click **Add**.

The first panel (Add LDAP Servers) of the LDAP Configuration wizard appears.

**Figure 31:** LDAP Configuration Wizard (Add LDAP Servers)

1 Enter information and make selections:

- **Host**- Enter the host name or IP address of an Active Directory global catalog server (for Active Directory authentication) or the host name or IP address of an LDAP server (for Other LDAP server types).
- **Port**- Optionally, change the server port number. By default, the port number is 389.
- **SSL**- Select if using SSL. When you select this option, the default port number adjusts to 636.

- **Skip cert verification?**- If you are using a self-signed certificate, select this check box to skip its verification. Requires OpenLDAP 2.4 or higher.
- 2 To add another LDAP server, click **Add Server**. To remove a server from the list, click **Remove**.
  - 3 In the **Manager Credentials** area, provide the following information:
    - **Server Type**- Select a server type (Active Directory or Other LDAP).
    - **Manager DN**- Enter the distinguished name of a user in the domain administrators group. The following example follows the user's base DN:
 

```
cn=admin, cn=users, dc=example, dc=com
```
    - **Manager Password**- Enter the password for the Manager DN.
  - 4 To ensure that your setup is valid, click **Validate**.
  - 5 Click **Next**. The second panel (Configure LDAP Plugin) of the LDAP Configuration wizard appears.

**Figure 32:** LDAP Configuration Wizard (Configure LDAP Plugin)

**New LDAP Configuration**

**2. Configure LDAP Plugin**

LDAP Configuration ID: win2008-ad.example.com

Login Name Attribute: sAMAccountName

Users Base DN: dc=Users, dc=example, dc=com  
Example: dc=Users, dc=example, dc=com

Groups Base DN: dc=Groups, dc=example, dc=com  
Example: dc=Groups, dc=example, dc=com

User Filter: (cn=Organization.\*)  
Example: (cn=Organization.\*)

Group Filter: (cn=IT Admins)  
Example: (cn=IT Admins)

Default User Roles: ZenUser

PREVIOUS NEXT CANCEL

- 6 Provide the following information:
  - **Login Name Attribute**- Select the LDAP record attribute used as the user name.

---

**Note** To edit the list of selections, add attributes on the **Mappings** page of the LDAP configuration area (**ADVANCED > LDAP**).

---

- **Users Base DN**- Enter the user's base distinguished name. For example, if your domain is ad.example.com, then your user's base DN might be:

```
dc=Users, dc=example, dc=com
```

- **Groups Base DN**- Enter the DN for the branch of your LDAP database that contains group records. These group records are of the LDAP class "groupOfUniqueNames," and the entry CN attribute constitutes the group name.
  - **User Filter**- Specify a free-form LDAP filter expression to be added to the default user search filter. The default user search filter and this additional search filter are combined as an AND expression. Records must satisfy both filters to be found using the various user searches. Any value specified in this field must follow correct LDAP search filter syntax.
  - **Group Filter**- Specify a free-form LDAP filter expression to be added to the default group search filter. The default group search filter and this additional search filter are combined as an AND expression. Records must satisfy both filters to be found using the various group searches. Any value specified in this field must follow correct LDAP search filter syntax.
  - **Default User Roles**- Specify one or more roles (by multi-selecting from the drop-down list) to be given to all users authenticated from your LDAP tree. Zope expects all users - anonymous as well as authenticated - to have the role Anonymous.
- 7 Click **Next**. The third panel (Map LDAP Groups to Local Groups) of the LDAP Configuration wizard appears.

**Figure 33:** LDAP Configuration Wizard (Map LDAP Groups to Local Groups)

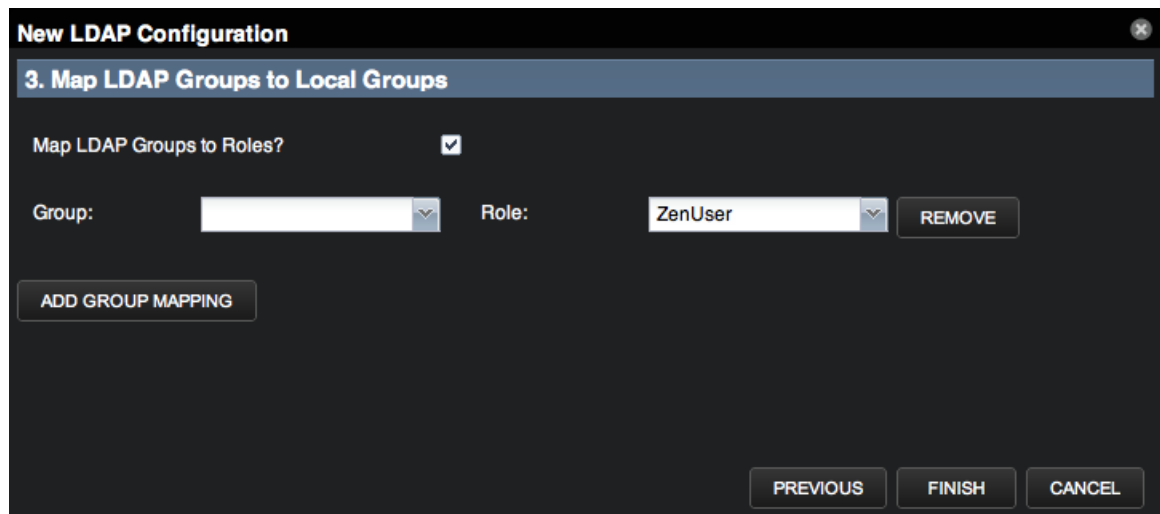

- 8 Provide the following information:
- **Map LDAP Groups to Roles?**- Select this option if you want to control user roles within the Resource Manager Web interface by using Active Directory groups, instead of controlling the roles directly from within the system.
- If you choose to use this option, add the following groups to LDAP:
- Resource Manager Managers
  - Resource Manager Users
  - **Group**- Select the LDAP group to map to a Resource Manager role.
  - **Role**- Select the Resource Manager role to map the LDAP group.
- 9 To map another group, click **Add Group Mapping**. To remove a mapped group, click **Remove**.
- 10 Click **Finish**.

After setup, you can edit your LDAP configuration settings from the Settings, Configuration Options, and Mappings tabs.

The Search tab allows you to locate user records on your LDAP server. Select from the list of search parameters, and optionally enter a search term, and then click **Search**. Search results return on the lower portion of the page.

**Figure 34:** LDAP Configuration - Search

dn	cn	memberOf	sn	mail	givenName	sAMAccountName
CN=User1,CN=Users,D...	User1	CN=Group1,CN=Users,...	User	user1@zenoss-testing...	Number1	User1
CN=User2,CN=Users,D...	User2	CN=Group1,CN=Users,...	User	user2@zenoss-testing...	Number2	User2
CN=User3,CN=Users,D...	User3	CN=Group1,CN=Users,...	User	user3@zenoss.zenoss...	Number3	User3
CN=User4,CN=Users,D...	User4	CN=Group1,CN=Users,...	User	user4@zenoss-testing...	Number4	User4
CN=User5,CN=Users,D...	User5	CN=Group1,CN=Users,...	User	user5@zenoss-testing...	Number5	User5
CN=User6,CN=Users,D...	User6	CN=Group1,CN=Users,...	User	user6@zenoss-testing...	Number6	User6
CN=User7,CN=Users,D...	User7	CN=Group1,CN=Users,...	User	user7@zenoss-testing...	Number7	User7
CN=User8,CN=Users,D...	User8	CN=Group1,CN=Users,...	User	user8@zenoss-testing...	Number8	User8
CN=User9,CN=Users,D...	User9	CN=Group1,CN=Users,...	User	user9@zenoss-testing...	Number9	User9
CN=User10,CN=Users,...	User10	CN=Group1,CN=Users,...	User	user10@zenoss-testing...	Number10	User10
CN=User11,CN=Users,...	User11	CN=Group2,CN=Users,...	User	user11@zenoss-testing...	Number11	User11
CN=User12,CN=Users,...	User12	CN=Group2,CN=Users,...	User	user12@zenoss-testing...	Number12	User12
CN=User13,CN=Users,...	User13	CN=Group2,CN=Users,...	User	user13@zenoss-testing...	Number13	User13
CN=User14,CN=Users,...	User14	CN=Group2,CN=Users,...	User	user14@zenoss-testing...	Number14	User14

## Configuring local authentication as a fallback

Use local authentication as a fallback in the event that the LDAP server is unavailable. The local authentication plugin is called `userManager`.

- 1 Verify that the `userManager` plugin is available.
  - a In a web browser, navigate to the Zope Management Interface.  
Replace *Zenoss-Host* with the hostname or IP address of your Resource Manager server:

```
https://Zenoss-Host/zport/acl_users/manage
```

- b In the **Name** column, click **plugins**.
- c Click **Authentication Plugins**.

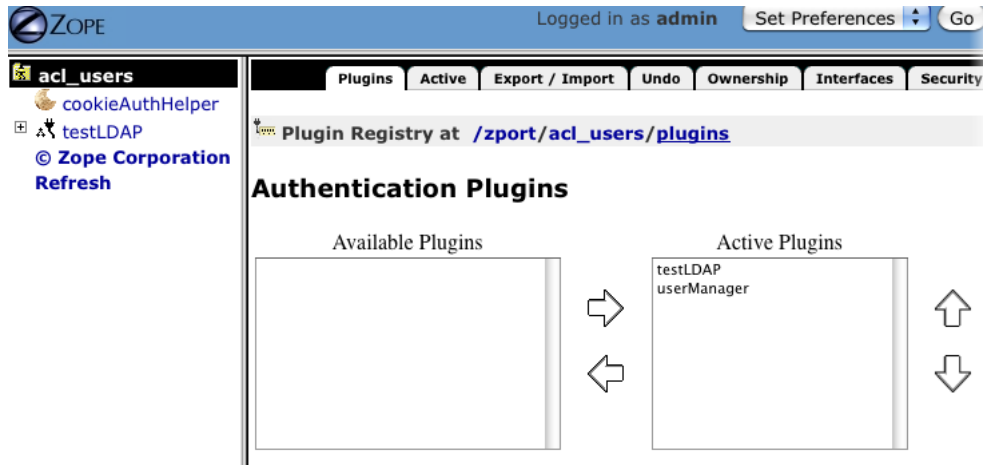
**Figure 35: Authentication Plugins**

- d Verify that your LDAP plugin is first in the list of active plugins, and that the userManager plugin is second.
- 2 Create one or more user accounts.
 

The accounts created in this step enable access when the LDAP server is unavailable. If you use the same account name in this step as the LDAP account name, the user need only remember the "fallback" password.

    - a In Resource Manager, navigate to **ADVANCED > Users > Add > New User**.
    - b Create one or more user accounts.

---

**Note** This account must be created before the account with the same name is authenticated by the LDAP server. The passwords defined when creating accounts in Resource Manager are only valid when the LDAP server is unavailable.

---

## Verifying connectivity and credentials outside of Resource Manager

Verify that your credential information is valid from the Resource Manager server by using the `ldapsearch` command. To install this command, use the following commands for RPM-based systems:

```
# yum install openldap-clients
```

As the `zenoss` user on the Resource Manager server:

```
ldapsearch -LLL -x -b 'BaseDN' -D 'Bind DN' -W -H ldap://LDAP_server-name \
"sAMAccountName=*" member
```



# Visualizing your environment

---

# 2

## Dynamic service view

---

Resource Manager provides a dynamic visualization of system objects and their relationships to other objects.

You can access the dynamic view from groups, systems, and locations. Depending on the object type, different relationships are illustrated. Each dynamic view shows related objects in a graph. Each object in that graph displays its associated event information. See the following procedures for creating a particular dynamic view you are interested in. The following figures show some example dynamic service views and navigation aides.

**Figure 36:** Dynamic service view: Locations graph

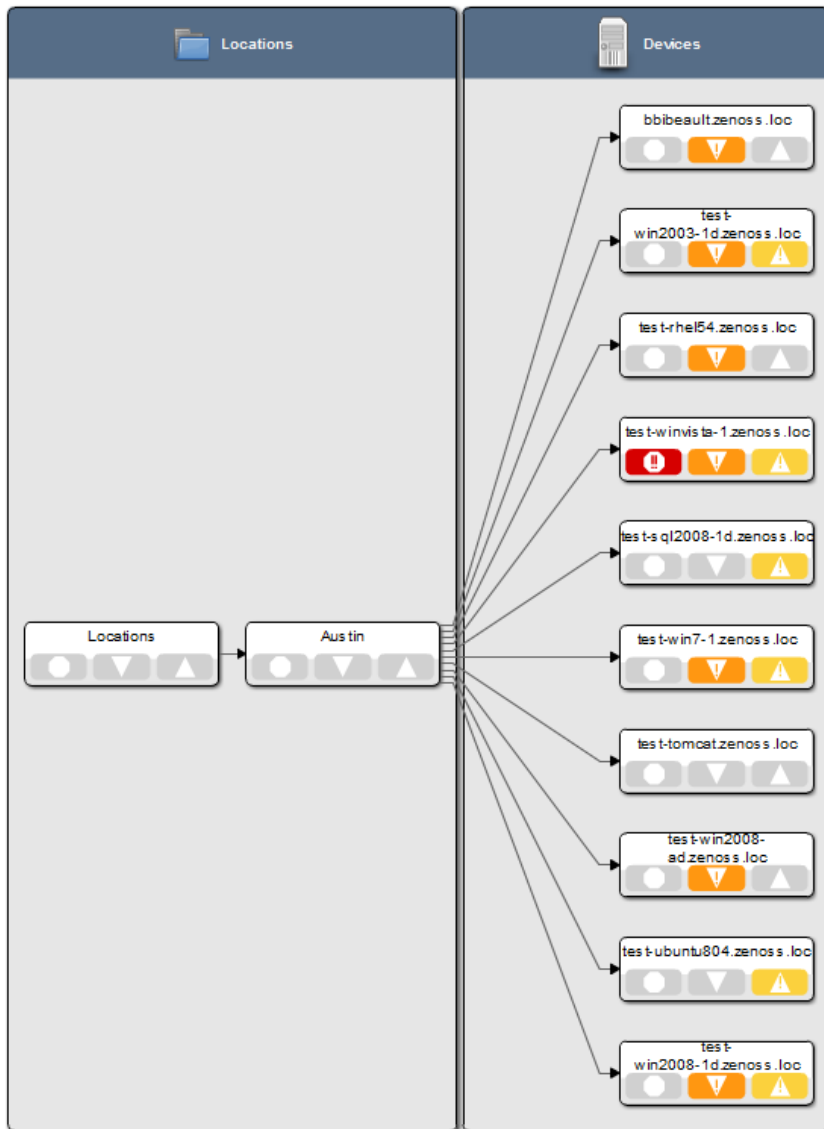

When you click an object in the graph, the "inspector" panel appears. This panel provides detailed information about the object and links directly to it. Information that appears in the inspector depends on the object type selected.

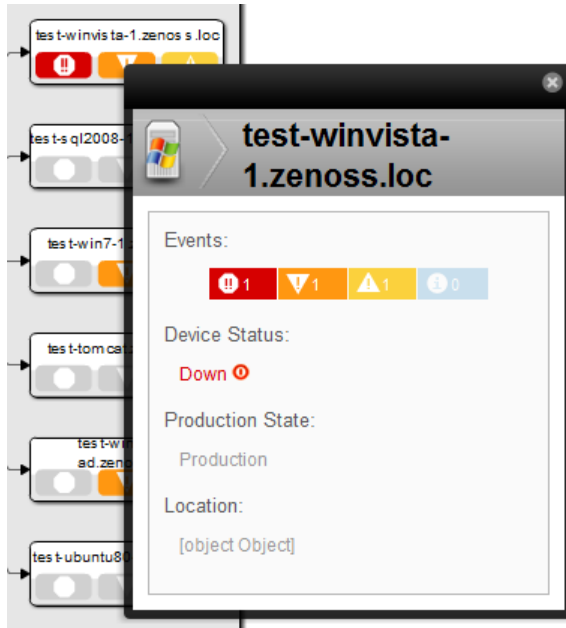
**Figure 37:** Dynamic service view: Inspector panel

View controls appear to the right of the graph. These allow you to adjust your view:

- **Overview** - Toggles display on and off of the graph overview illustration.
- **Magnifier** - Toggles on and off the magnifier, which allows you to magnify selected portions of the graph.
- **Zoom In** - Zooms in on the graph.
- **Zoom Out** - Zooms out on the graph.
- **Fit View** - Fits the graph to the browser page.
- **Refresh** - Refreshes the graph.

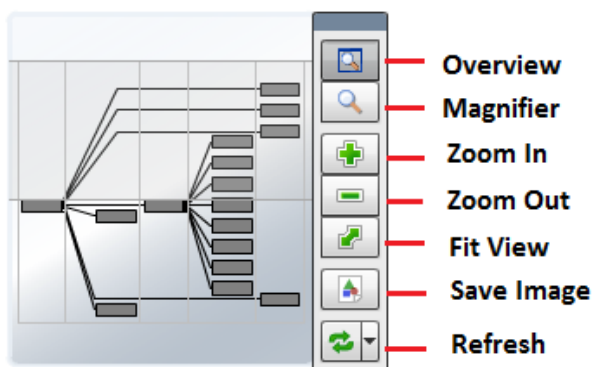
**Figure 38:** Dynamic view controls

## Dynamic view of organizers

The dynamic view of organizers shows objects that can impact the status of the organizer, such as other organizers and devices. This view also shows relationships between devices and a virtual infrastructure, such as VMware or Cisco UCS objects monitored by the system, as well as storage information.

To access the dynamic view for an organizer (such as a group, system, or location):

- 1 From Infrastructure > Devices, select the organizer in the devices hierarchy.
- 2 Click **Details**.

- 3 Select Dynamic Service View.

## Dynamic view of devices

The dynamic view of devices shows the relationship between a device and monitored components.

To access the dynamic view for a device:

- 1 From **INFRASTRUCTURE > Devices**, click a device in the device list. The device overview page appears.
- 2 Select **Dynamic View** in the left panel.

### Dynamic view of Cisco UCS devices

On Cisco UCS devices, the dynamic view shows the components and relationships that make up a Cisco UCS domain. The following list describes the components that are listed in the Dynamic View for various types of UCS devices:

- UCS Classic
  - UCS Domains
  - UCS Fabric Interconnects
  - UCS Fabric Ports
  - UCS IO Cards
  - UCS Fabric Extenders
  - UCS Chassis
  - UCS Blades
  - UCS Racks
  - UCS Service Profiles (only those bound to servers)
- UCS Mini
  - UCS Domains
  - UCS FI-IO Modules
  - UCS Chassis
  - UCS Blades
  - UCS Service Profiles (only those bound to servers)

### Dynamic view of VMware hosts

On VMware Hosts (ESX servers), the dynamic view shows the relative VMware elements that are connected to the host, such as:

- VMs that currently are running on the Host
- Data stores that are mounted by the Host
- Clusters to which the Host belongs

### Dynamic view of storage devices

Storage devices such as NetApp Filers have two dynamic views:

- **Physical Storage View** - Shows the device's storage enclosures and associated hard disks.
- **Logical Storage View** - Shows the logical storage arrangement that the storage device presents, such as file systems and raid groups.

## Datacenter view

Resource Manager provides a visual representation of devices (such as servers or blades) and device containers (such as racks or chassis).

With this feature, you can create a custom view that represents a physical space (such as a data center) by customizing the view background. You can then overlay this view with active representations of your devices and device containers.

**Figure 39: Custom view**

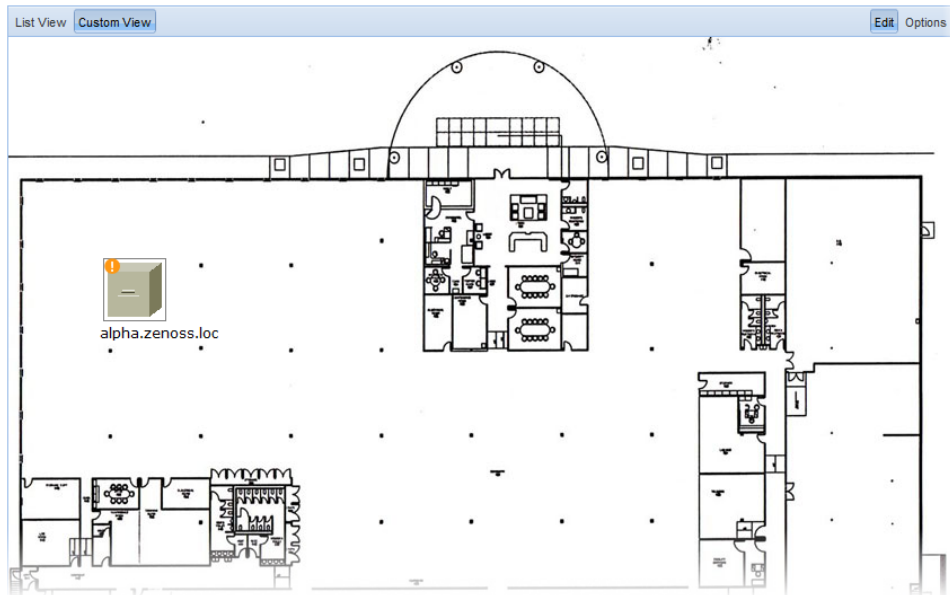

For each device or device container, the system can generate a rack view, which diagrams the physical location of devices in a chassis or rack. Each represented device provides at-a-glance information about its status.

**Figure 40: Rack view**



## Configuring

Before a device or sub-location can appear in Datacenter View:

- At least one organizer must be configured
- At least one device or sub-organizer must be included in a location

To see the auto-generated rack view, you must set a rack slot value for the device.

## Working with the List View

The List View provides a view of your devices (or, if configured, the Rack View). Follow these steps to access the List View:

- 1 From the interface, select **Infrastructure**.
- 2 In the Devices hierarchy, select a location, group, or system.
- 3 Click **Details**.
- 4 Select **Datacenter View**.

---

**Note** After you create a Custom View, that view appears by default.

---

## Working with the Custom View

The Custom View lets you create a visual representation of your physical space (such as a data center).

To access the Custom View, from the Diagram selection, click Custom View.

You can edit the Custom View to:

- Add or change a background image
- Move or resize device images
- Remove the view

### Adding a background image to a custom view

Follow these steps to create a custom view and add a background image to the view:

- 1 From the Datacenter View page (accessed from the Diagram selection), click **Custom View**.
- 2 Click **Edit** to enable edit mode.  
The Edit button highlights to indicate that it is active, and Options selections become available.
- 3 Select **Options > Change Background**.
- 4 In the **Change Background** dialog, select **Background Image from URL**.
- 5 In the **Image URL** field, enter an image location, and then click **Save**.

Any image format and size supported by your browser can be used.

**Figure 41: Change Background**

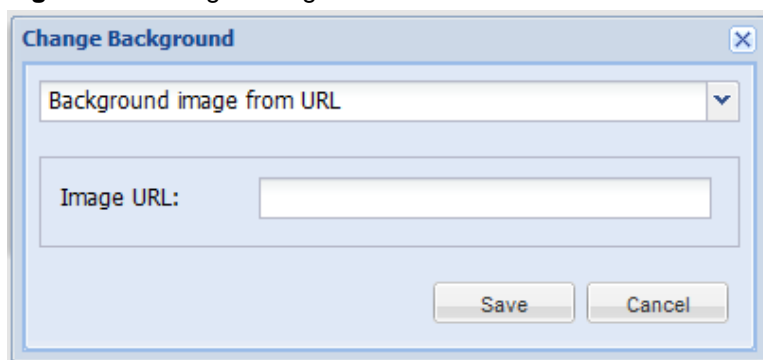

### Removing a custom view background image

To remove the current background image from the Custom View:

- 1 From the Custom View area, click **Edit**.
- 2 Select **Options > Change Background**.

- 3 In the Change Background dialog, select No background image from the list of options.
- 4 Click **Save**.  
The image no longer appears in the view.

### Working with devices in the custom view

Devices in the custom view can be moved and resized. To work with devices in this view, click **Edit**. You can then drag devices to a specific location in the view, and resize them to accurately represent your physical space.

You also can view device details from this view. Click the device to go to its Status page.

---

**Note** To access device status, you cannot be in edit mode.

---

### Removing a custom view

Removing the custom view removes the view and custom background image, if any. To remove a custom view:

- 1 From the Datacenter View page (accessed from the Diagram selection), click **Custom View**.
- 2 Click Edit to enable edit mode.
- 3 Select **Options > Remove Custom View**.  
The custom view no longer appears by default. If you select **Custom View**, devices still appear in the view; however, they are reset to default positions and sizes.

## Activating the auto-generated rack view

First, ensure that the device is included in a location. Then follow these steps to make devices visible in Datacenter View.

- 1 Select a device, from the list of Devices, click **Details**, and then click **Edit**.
- 2 Enter values for Rack Slot.  
For more information about specifying values, see the next topic.
- 3 Click **Save**.

The device appears in Datacenter View.

- In the List View, it appears as part of a rack illustration. The rack illustration becomes the default image in the List View.
- In the Custom View, it appears as a single device image.

---

**Note** You can customize the device image by modifying the zIcon configuration property in the device class.

---

### Rack view specification syntax

The specification of a rack view features two required and two optional key-value pairs, which are described in the following table. The value for each key is a positive integer.

Key	Type	Description
ru	Required	The lowest rack unit used by the device.
rh	Required	The height of the device, in rack units.
st	Optional	The rack slot.
sc	Optional	The slot capacity; only for chassis devices.

The syntax of a rack view specification is a comma-separated list. The following example specifies a 1u device in the second rack unit for a device named `beta.zenoss.loc`:

```
ru=2, rh=1
```

**Figure 42:** Example rack view specification

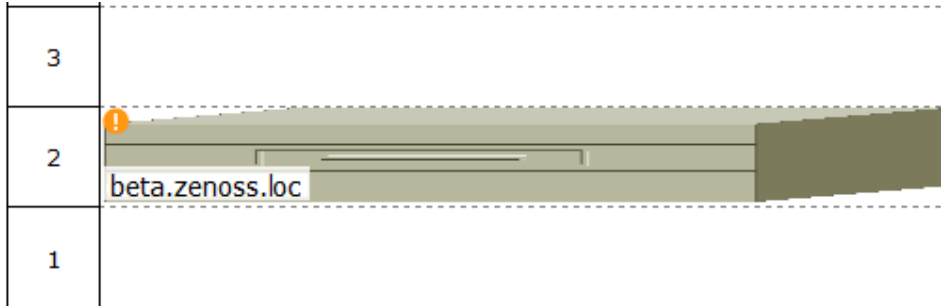

In the preceding example, no rack slot value is included, because there is only one device.



## 3

## Adding, discovering and modeling devices

---

Modeling is the process by which the system:

- Populates the device database
- Collects information about the devices in the system (such as operating system type or file system capacity)

The system models devices when they are added to the database, either manually or through the discovery process.

### Add a single device

---

Follow these steps to add a single device:

- 1 From the Navigation menu, select **Infrastructure**. The Devices page appears.
- 2 Select **Add a Single Device** from the Add Devices icon . The Add a Single Device dialog box appears.

**Figure 43:** Add a Single Device

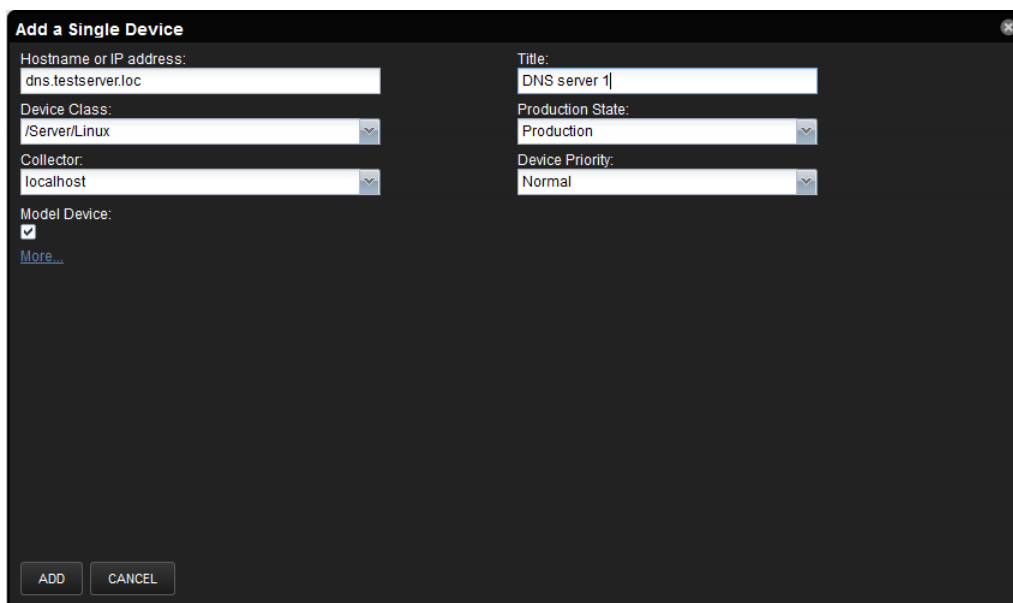

**Add a Single Device**

Hostname or IP address: dns.testserver.loc

Device Class: /Server/Linux

Collector: localhost

Model Device:

[More...](#)

Title: DNS server 1

Production State: Production

Device Priority: Normal

ADD CANCEL

- 3 Enter information or make selections to add the device:

- **Hostname or IP address** - Enter the network (DNS) name or IP address of the device.
  - **Device Class** - Select a device class to which this device will belong. For example, if the new device is a Linux server, then select `/Server/Linux`.
  - **Collector** - By default, this is `localhost`. Select a collector for the device.
  - **Model** - By default, this option is selected. If you do not want the device to be modeled when it is added, de-select this option.
- 4 Optional: To display additional fields, click **More**. On the expanded page, you can:
- Enter device-specific details.
  - Edit SNMP settings.
  - Set hardware and operating system information.
  - Add device comments.

---

**Note** **Hostname or IP address**, **Device Class**, and **Model** are the only required selections when adding a device. Information you add might conflict with information the system discovers about the device. Therefore, you can continue (click **Add**) without additional information or selections.

An exception is if you are adding a Cisco router in a device class other than `/Network`. In this case, before adding the device, set the value of the `zIfDescription` configuration property to `True`. Changing the value gives you additional information about Cisco routers. By default, this option is set to `True` for the `/Network` class.

---

- 5 Click **Add**.
- 6 Optional: To view the Add Device job in progress, click **View Job Log** in the notification that appears when you add the device.  
When the job completes, the device is added in the selected device class.

## Add multiple devices

---

Follow these steps to manually add multiple devices:

- 1 From the Navigation menu, select **Infrastructure**. The Devices page appears.
- 2 From the Add Devices icon , select **Add Multiple Devices**. The Add Infrastructure page appears.
- 3 Select the category, type, and connection information for each device you want to add.
- 4 Click **Add** to add the device to the system. You will see the status at the bottom of the page. Continue to add more devices until you are done.
- 5 When you have completed adding your devices, click **Done**.

## Discovering devices

---

You can provide network or IP address range information so that the system can discover your devices.

Follow these steps to discover devices:

- 1 From the Navigation menu, select **Infrastructure**. The Devices page appears.
- 2 Click the Add Devices icon  and select **Discover Networks** from the drop-down list. The **Network Discovery** page appears.

## Network Discovery

Devices found via Discovery will be placed in the /Discovered Device Class

Networks/Range	SNMP	SSH Authentication	Windows Authentication
Enter one or more networks (such as 10.0.0.0/24) or IP ranges (such as 10.0.0.1-50): <input type="text"/>	Community Strings: <input type="text" value="public"/> <input type="text" value="private"/>	Username: <input type="text"/> Password: <input type="text"/>	Administrator Username: <input type="text"/> Password: <input type="text"/>
<input type="button" value="Discover"/>			

- For each network or IP range in which you want the system to discover devices, enter an address or range. For example, you might enter a network address in CIDR notation `192.0.2.0/24` or a range of IP addresses `192.0.2.1-50`

**Note** Trying to add a /16 or /8 network can take a very long time, and may have unintended consequences.

- For each network or IP range, specify the Windows, SSH, or SNMP credentials you want Resource Manager to use on the devices it discovers. You can enter only one of each. Resource Manager will attempt to use the same credentials on each device it discovers within the networks or IP ranges specified, but will not try to automatically classify the devices.
- Click **Discover**. The discovery process iterates through every IP address in the networks and IP ranges you specify, adding each device that responds to a ping request. Further, the process adds information to any device that responds to an SNMP, WinRM, or SSH request.

**Note** Resource Manager uses Advanced Encryption Standard (AES) with a 256-bit key size to encrypt all passwords, and stores them in the Zope object database.

The system places discovered routers in the device path `/Network/Router`. Devices are placed in the `/Discovered` device class.

## Classifying discovered devices

Once discovery is complete, you must move discovered devices (placed, by default, in the `/Discovered` class) to an appropriate device class in the hierarchy. Moving devices to their correct hierarchy location makes it possible for monitoring to begin.

Servers are organized by operating system. If the system discovers Windows devices, for example, you might choose to relocate them to `/Server/Windows`. Similarly, you might choose to classify discovered Linux devices in `/Server/Linux` (if you want to monitor and model using SNMP), or `/Server/SSH/Linux` (if you want to monitor and model using SSH).

To classify discovered devices:

- Select one or more discovered devices (highlight one or more rows) in the device list.
- Drag the selected devices to the new device class in the tree view.

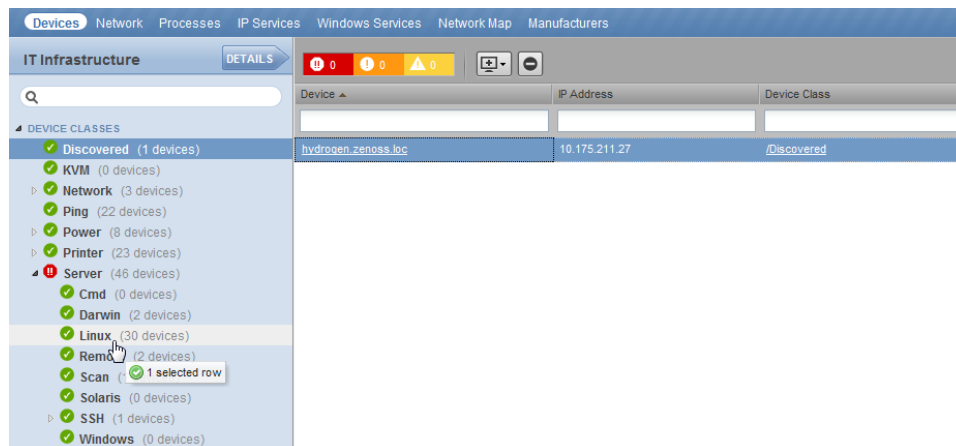
**Figure 44:** Classifying Discovered Devices

The Move Devices dialog box appears.

- 3 Click **OK**. The list of devices refreshes, and the devices now appear in the newly selected class.

## Updating device authentication details

For each device added to the database and set to its proper device class, Resource Manager may require additional or different authentication information before it can gather device information and monitor the device.

For example, for a device in the `/Server/Windows` class, you must supply your Windows user name and password before the system can monitor the device. To do this:

- 1 Click a device name in the devices list. The Device summary page appears.
- 2 Select **Configuration Properties** from the left panel.
- 3 Double-click the `zWinRMUser` configuration property to display the Edit Config Property dialog.
- 4 Enter your Windows user name in the Value field, and then click **Submit**.
- 5 Double-click the `zWinRMPasswd` configuration property to display the Edit Config Property dialog.
- 6 Enter your Windows password in the Value field, and then click **Submit**.

Similarly, for a device in the `/Server/SSH/Linux` class, you must supply your SSH user name and password. Set these values in the device's `zCommandUsername` and `zCommandPassword` configuration properties.

---

**Note** After making changes, you should remodel the device to ensure the authentication changes are valid.

---



---

**Note** Resource Manager uses Advanced Encryption Standard (AES) with a 256-bit key size to encrypt all passwords, and stores them in the Zope object database.

---

## Adding or editing information on a device record

To add or edit information:

- 1 Click a device name in the devices list. The Device overview page appears.
- 2 You can select values to change, or click the "edit" link adjacent to a label to edit that value. Enter or change information in one or more areas, and then click **Save** to save your changes.

## Add Cisco UCS

---

The Cisco Unified Computing System (UCS) is a data center server computer product line composed of computing hardware, virtualization support, switching fabric, and management software. You can add a UCS Manager and/or a Cisco Integrated Management Controller (CIMC), which manages/monitors C-Series and E-Series rack servers.

Perform the following to add a Cisco UCS device:

- 1 From the Navigation menu, select **Infrastructure**. The Devices page appears.
- 2 From the Add Devices icon , select **Add Cisco UCS**. The Add Cisco UCS page appears.

**Figure 45:** Add Cisco UCS

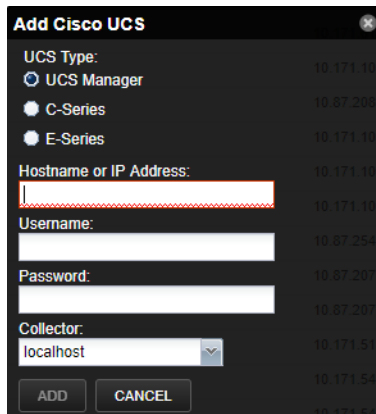

- 3 Select the UCS type:
  - UCS Manager
  - C-Series
  - E-Series
- 4 Complete the dialog with the hostname or IP address, the username and password, and select the collector for this device.
- 5 Click **Add**.
- 6 Optional: To view the Add Device job in progress, click **View Job Log** in the notification that appears when you add the device.  
When the job completes, the device is added to the applicable `/CiscoUCS` device class.

## Add vCloud cell

---

A VMware vCloud Director cluster contains one or more vCloud Director servers, which are referred to as "cells".

Follow these steps to add a vCloud cell:

- 1 From the Navigation menu, select **Infrastructure**. The Devices page appears.
- 2 From the Add Devices icon , select **Add vCloud Cell**. The Add vCloud Cell page appears.

**Figure 46:** Add vCloud Cell

- 3 Complete the dialog with the hostname or IP address, the port number, the username and password, and select the collector for this device.
- 4 Click **Add**.
- 5 Optional: To view the Add Device job in progress, click **View Job Log** in the notification that appears when you add the device.  
When the job completes, the device is added to the /vCloud device class.

## Add VMware vSphere endpoint

---

Follow these steps to add a vSphere endpoint:

- 1 From the Navigation menu, select **Infrastructure**. The Devices page appears.
- 2 From the Add Devices icon , select **Add VMware vSphere Endpoint**. The Add VMware vSphere Endpoint page appears with the Add Single Device tab selected.

**Figure 47:** Add VMware vSphere Endpoint - Single Device

- 3 If you want to just add a single device, complete the dialog with the appropriate information, then click **Add**.
- 4 If you want to add multiple devices at once, click the **Add Multiple Devices** tab.

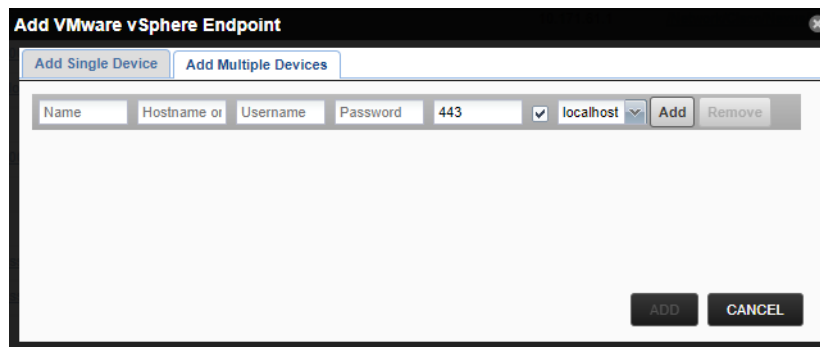
**Figure 48:** Add VMware vSphere Endpoint - Multiple Devices

- 5 Fill out the information in the row for a device and click **Add**. A new row appears and you can add another device. When you are finished be sure to click the **Add** button at the bottom of the dialog to add all of your devices.

## Modeling devices

---

To model devices, the system can use:

- SSH
- WinRM
- SNMP (legacy option)

---

**Note** SSH and WinRM are the recommended options.

---

The modeling method you select depends on your environment, and on the types of devices you want to model and monitor.

By default the system remodels each known device every 720 minutes (12 hours).

---

**Note** You can change the frequency with which devices are remodeled. Edit the value of the Modeler Cycle Interval in the collector's configuration.

---

For larger deployments, modeling frequency may impact performance. In such environments, you should set the `startat` configuration setting inside the `zenmodeler.conf` file to change the scheduling of the daemon. The `startat` value only dictates the initial start time of `zenmodeler`. Each subsequent run interval is determined by the `zenmodeler` cycle time (number of minutes between runs) configured on the daemon settings page inside the parent's collector folder which can be accessed in Control Center. See the following KB article for more information: [How To Edit The Zenmodeler File To Configure Model Scheduling In Zenoss 5.x](#)

---

The following figure shows how the `zenmodeler` daemon fits into the modeling devices portion of the Resource Manager architecture. Note that MariaDB has replaced ZenDS (MySQL) in version 5.x and stores the object database (ZODB).

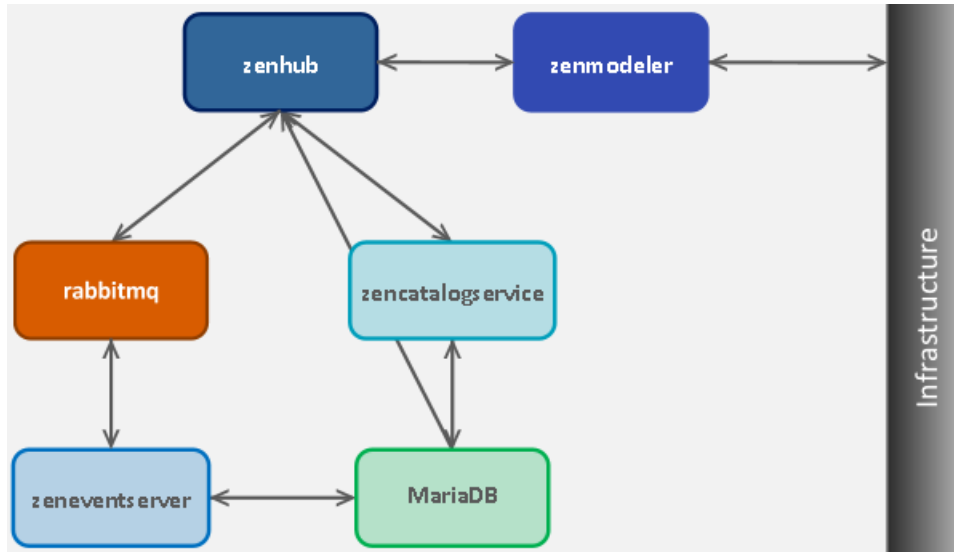
**Figure 49: Device Modeling Architecture**

## Configuring Windows devices to provide data through SNMP

To monitor Microsoft Windows Server 2008 R2 systems, Resource Manager uses SNMP v1/v2 or WinRM. (There is no SNMP v3 support.) For Windows 2012, there is no SNMP support.

By default, Windows may not have SNMP installed. To install SNMP on your particular version of Windows, please refer to the Microsoft documentation.

After setting up and configuring the SNMP service, you must set the `zSnmCommunity` string in Resource Manager to match, to obtain SNMP data.

If you want processor and memory monitoring, install *SNMP-Informant* on the device.

To collect Windows event logs or log files from a Windows box using `syslog`, install the *SyslogAgent* Windows add-on.

## Configuring Linux devices to provide data through SNMP

To configure a Linux machine for monitoring, it must have SNMP installed. A good Linux SNMP application is `net-snmp`. Download, install, and configure `net-snmp` to then use SNMP to monitor Linux devices.

## Modeling devices using SSH/CMD

You can gather additional information by running commands on the remote device and interpreting the results. This provides a more scalable and flexible way to gather information that may not be available through any other means.

Each built-in modeling command plugin is differentiated by the platform on which it runs. To determine the platform for the device you want to model, run the `uname` command in a shell on the device.

To model a device using command plugins, first add the device by using the protocol "none," and then choose the plugins you want to apply:

- 1 From the Navigation menu, select **Infrastructure**.
- 2 Click the Add Devices  icon and select **Add a Single Device** from the drop-down list. The Add a Single Device window appears.
- 3 Enter values for Name or IP and Device Class.



- 4 Clear the Model Device option.
- 5 Click **Add**.
- 6 After adding the device, select the device name in the devices list. The Device Overview page appears.
- 7 In the left panel, select **Configuration Properties**.
- 8 If necessary, set the values of the zCommandUsername and zCommandPassword configuration properties to the user name and password of the device (or set up authentication by using RSA/DSA keys.)

---

**Note**    `~/.ssh/id_rsa`

---

- 9 In the left panel, select **Modeler Plugins**. The list of plugins appears. The left column displays available plugins; the right column shows those currently selected.
- 10 Select `zenoss.cmd.uname` from the Available list, and then use the right arrow control to move it to the Selected list on the right. Use the controls to place it at the top of the list.

**Figure 50: Add plugin**

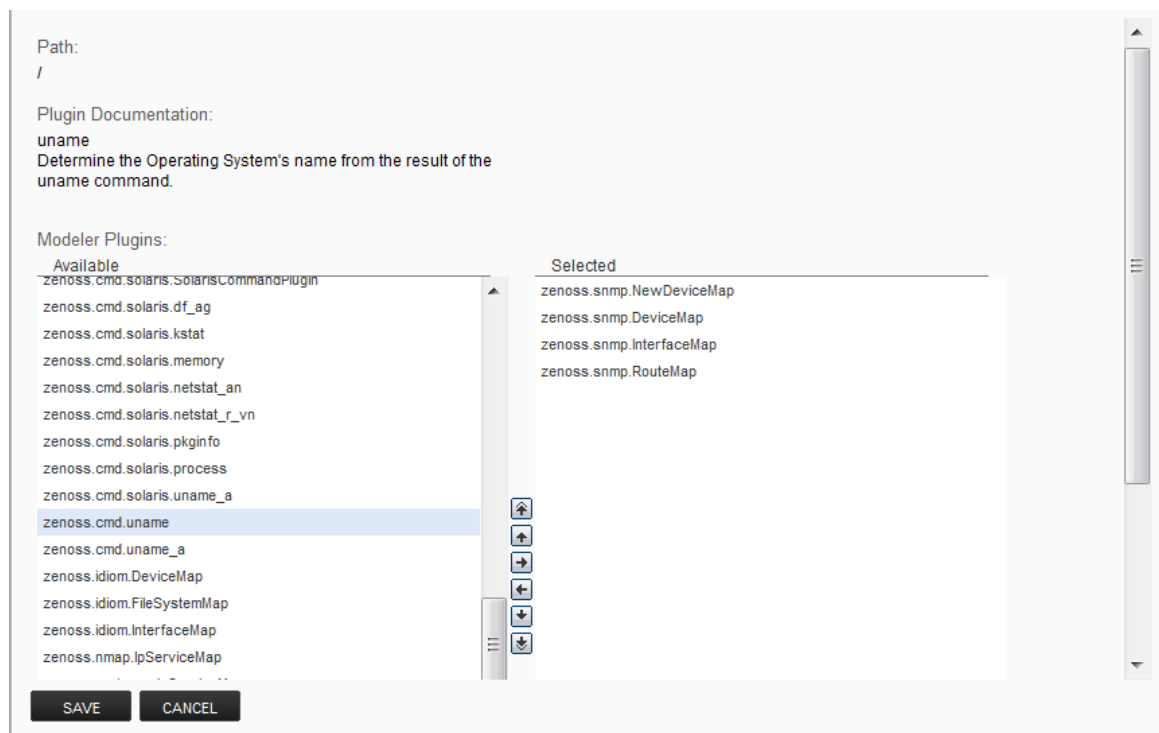

- 11 Use the left arrow control to move the other Selected plugins from the Selected list to the Available list.
- 12 Click **Save**.
- 13 Model the device by clicking the **Model Device** button.

## Using device class to monitor devices using SSH

The `/Server/Command` device class is an example configuration for modeling and monitoring devices using SSH. The `zCollectorPlugins` have been modified (see the section titled "Modeling Using SSH/Command"), and the device, file system, and Ethernet interface templates used to gather data over SSH have been created. You can use this device class as a reference for your own configuration; or, if you have a device that needs to be modeled or monitored via SSH/Command, you can place it in this device class to use the pre-configured templates and configuration properties. You also must set the `zCommandUsername` and `zCommandPassword` configuration properties to the appropriate SSH login information for each device.

## Modeling devices using port scan

You can model IP services by doing a port scan, using the *Nmap Security Scanner*. You must provide the full path to your system's `nmap` command.

To determine where `nmap` is installed, at the command line, enter:

```
which nmap
```

If your system returns a result similar to:

```
/usr/bin/which: no nmap in (/opt/zenoss/bin:/usr/kerberos/bin:/usr/local/bin:/bin:/usr/bin:/opt/zenoss/bin)
```

then `nmap` is not installed. Install it, and then try again.

After locating the `nmap` command (including the directory beginning with `/`), enter the following as the `zenoss` user on the Resource Manager server:

```
cd $ZENHOME/libexec ln -s
    Full_Path_to_nmap
```

---

**Note** To execute a command using `$ZENHOME` (`/opt/zenoss` for the `zenoss` user), you must be attached to the container holding the Resource Manager application. See the Control Center documentation for `serviced` commands.

---

To model a device using a port scan:

- 1 Select the device in the device list.
- 2 In the left panel, select **Modeler Plugins**.
- 3 Select the `zenoss.nmap.ipServiceMap` plugin in the list of Available plugins, and then use the right arrow control to move it to the list of Selected plugins.
- 4 Click **Save**.
- 5 Remodel the device by clicking the **Model Device** button.

## Using the `/Server/Scan` device class to monitor with port scan

The `/Server/Scan` device class is an example configuration for modeling devices by using a port scan. You can use this device class as a reference for your own configuration; or, if you have a device that will use only a port scan, you can place it under this device class and remodel the device.

## About modeler plugins

---

Resource Manager uses plug-in maps to map real world information into the standard model. Input to the plug-ins can come from SNMP, SSH or Telnet. Selection of plug-ins to run against a device is done by matching the plug-in name against the `zCollectorPlugins` configuration property.

- **DeviceMap**– Collects basic information about a device, such as its OS type and hardware model.
- **InterfaceMap**– Collects the list of network interfaces on a device.
- **RouteMap**– Collects the network routing table from the device.
- **IpServicesMap**– Collects the IP services running on the device.
- **FileSystemMap**– Collects the list of file systems on a device.

## Viewing and editing modeler plugins for a device

Plugins are controlled by regular expressions that match their names. To view a list of plugins for any device:

- 1 Click the device name in the devices list.
- 2 In the Device summary page, select **Modeler Plugins**.

The Modeler Plugins page appears.

### Adding plugins

To add a plugin to a device:

- 1 Use the right arrow control to move one or more plugins from the Available list (on the left) to the Selected list (on the right).
- 2 Click **Save**.

### Reordering plugins

Plugins run in the order in which they are listed. To re-order plugins, use the up and down arrow controls, and then click **Save**.

### Deleting plugins from a device

To delete a plugin from a device, use the left arrow control to move the plugin from the Selected list to the Available list.

## Debugging the modeling process

---

You can run the modeler from the command line against a single device. This feature is useful when debugging issues with a plugin.

By passing the `--collect` command to the modeler, you can control which modeler plugins are used. For example, the following command runs only the interface plugin against the `build.zenoss.loc` device:

- 1 Log in to the Control Center host as a user with `serviced` CLI privileges.
- 2 Attach to the `zenmodeler` service.

```
serviced service attach zenmodeler
```

- 3 Change to the `zenoss` user.

```
su - zenoss
```

- 4 Run the `zenmodeler` command.

```
$ zenmodeler run -v10 --collect=IpInterface -d build.zenoss.loc
```

If the command returns any stack traces, forward these details to Zenoss Support for assistance:

- Command you ran
- Stack trace or stack traces returned
- Version of your Resource Manager instance
- OS version and patch level for the remote device

## Working with devices

This chapter provides information and procedures for managing devices in the system.

### Viewing the Device List

The device list shows all devices in the system. From this view, you can search for devices and perform a range of management tasks on all devices.

To access the device list, select **INFRASTRUCTURE** from the Navigation menu.

**Figure 51:** Device List

Device	IP Address	Device Class	Production State	Events
32-bit Machines		/VMware/Esxwin2_Colo	Production	
64-bit Machines		/VMware/Esxwin2_Colo	Production	
austinbot.zenoss.loc	10.87.209.6	/Server/Linux	Production	
Dev_Resource_Pool		/VMware/Esxwin2_Colo	Production	
doc-dev.zenoss.loc	10.175.211.217	/Server/Linux	Production	▲ 1
ec2-50-16-148-220.compute-1.amazonaws.com	50.16.148.220	/Server/Linux	Production	⚠ 1
ec2-50-19-130-2.compute-1.amazonaws.com	50.19.130.2	/Server/Linux	Production	⚠ 1
ec2-72-44-49-24.compute-1.amazonaws.com	72.44.49.24	/Server/Linux	Production	▼ 1
EC2Manager		/AWS/EC2	Production	
esx1.zenoss.loc		/VMware/Esxwin2_Colo	Production	
esx10.zenoss.loc		/VMware/Esxwin2_Colo	Production	
esx10.storage1		/VMware/Esxwin2_Colo	Production	
esx12.zenoss.loc		/VMware/Esxwin2_Colo	Production	
esx12.storage1		/VMware/Esxwin2_Colo	Production	
esx13.zenoss.loc		/VMware/Esxwin2_Colo	Production	
esx13.storage1		/VMware/Esxwin2_Colo	Production	
esx14.Storage1		/VMware/Esxwin2_Colo	Production	
esx14.zenoss.loc		/VMware/Esxwin2_Colo	Production	
esx15.zenoss.loc		/VMware/Esxwin2_Colo	Production	

### Devices hierarchy

Devices are organized in the tree view by:

- Devices
- Groups
- Systems

- Locations
- Component Groups

Click the indicator next to each category name to expand it and see included devices.

## Managing multiple devices from the device list

You can perform some management tasks for more than one device at a time. You can:

- Move devices to a different class
- Assign devices to groups, systems, and locations
- Remove devices
- Perform actions such as assigning priority, production state, or collector
- Lock devices

## Working with devices

To view details for a single device, click its name in the device list. The device overview page appears.

**Figure 52:** Device overview

The screenshot displays the 'Device overview' page for the device 'ucs1.zenoss.loc'. At the top, there is a navigation bar with tabs for 'Devices', 'Networks', 'Processes', 'IP Services', 'Windows Services', 'Network Map', and 'Manufacturers'. Below this, the device name 'ucs1.zenoss.loc' is shown along with its IP address '10.87.208.163' and a status indicator 'Up'. The page is divided into several sections:

- Overview:** Contains fields for Device ID, Connection Information (jwhitworth 443 True), Uptime (Unknown), First Seen (2016-11-30 02:29:16 pm), Last Change (2016-11-30 02:30:01 pm), Model Time (2016-12-06 01:08:55 am), and Locking (Unlocked). It also includes a 'Connect to this device' link and a description field.
- Device Name:** A text input field containing 'ucs1.zenoss.loc'.
- Production State:** A dropdown menu set to 'Production'.
- Priority:** A dropdown menu set to 'Normal'.
- Tag:** An empty text input field.
- Serial Number:** An empty text input field.
- Rack Slot:** An empty text input field.
- Collector:** A text input field containing 'localhost'.
- OS Model:** A text input field containing 'UCSM 2.2(5b)T'.
- Hardware Manufacturer:** A text input field containing 'Cisco'.
- Hardware Model:** A text input field containing 'UCS'.
- UCSM Domain Type:** A text input field containing 'Classic'.

At the bottom of the page, there are 'Save' and 'Cancel' buttons, and a 'Comments' section with a text area.

Event status is shown in the "event rainbow" at the top of the page. Other key information that appears at the top of the device overview page includes:

- Device name
- IP address used to communicate with the device
- Device status (shows the current results of a ping test)

- Production state (Pre-Production, Production, Test, Maintenance, or Decommissioned)
- Priority

When you open the page, device overview information displays. This view provides classification and status information. From here, you can edit device information (indicated by text fields or edit links). Editable fields include:

- Device Name
- Production State
- Priority
- Tag
- Serial Number
- Rack Slot
- Collector
- Hardware and software manufacturer and model
- Systems
- Groups
- Location

The Links area displays links between the device and other external systems. Click **Show Links** to view the links.

The left panel of the device overview page allows you to access other device management views, such as:

- Events
- Components
- Graphs (Performance)
- Component Graphs
- Modeler Plugins
- Software
- Custom Properties
- Configuration Properties
- Device Administration
- Dynamic View
- Dependency View
- Monitoring Templates

Information that appears here varies depending on device type.

## Dependency view

The dependency view of a device shows the resources that are dependent on the selected device as well as those resources that the device is dependent on. In this view, you can see the resource, associated component, and any events related to the component.

There are several places where you can see a dependency view:

- Device Overview page
  - Navigate to the device overview page and select **Dependency View**
- Device Component page
  - Navigate to the device overview page and select the component you are interested in. In the **Display** drop-down list, select **Dependencies**.

- Group Details page (including Groups, Systems, and Locations)
  - Navigate to the Group, System or Location name and click **Details**. Then, select **Dependency View**

Regardless of how you navigate to the Dependency View, the functionality remains the same. The following shows a sample Dependency View.

**Figure 53:** Dependency View

- 1 Click **Dependents** to see the resources that are dependent on the selected device or component. Click **Dependencies** to see the resources that this device or component is dependent on. For example, if you click the Dependency View of a Hyper-V server, you will see that VMs, datastores, and other resources are dependent on the Hyper-V server, while the server itself is dependent on the Host CPUs, HDDs, and Network Adapters (seen after clicking **Dependencies**).
- 2 Click on a Component to expand its dependents or dependencies.
- 3 Click **Groups** to select the resources that you want to display in the view.
- 4 Export the data displayed by clicking the **Export** button. A `.csv` file is exported with the data as it is presented in the view.
- 5 Click a resource name to be taken to its overview page which displays performance graphs and other details.

All selections made with respect to the display of the view will be saved so that when a particular user selects another dependency view, Resource Manager renders the dependency view using the same parameters. This is only applicable for the same user. There is no global setting available for the dependency view.

## Dynamic view

Resource Manager provides a dynamic visualization of system objects and their relationships to other objects.

You can access a dynamic view from a device overview, a group, a system, or a location. Depending on the object type, different relationships are illustrated. Each dynamic view shows related objects in a graph. Each object in that graph displays its associated event information.

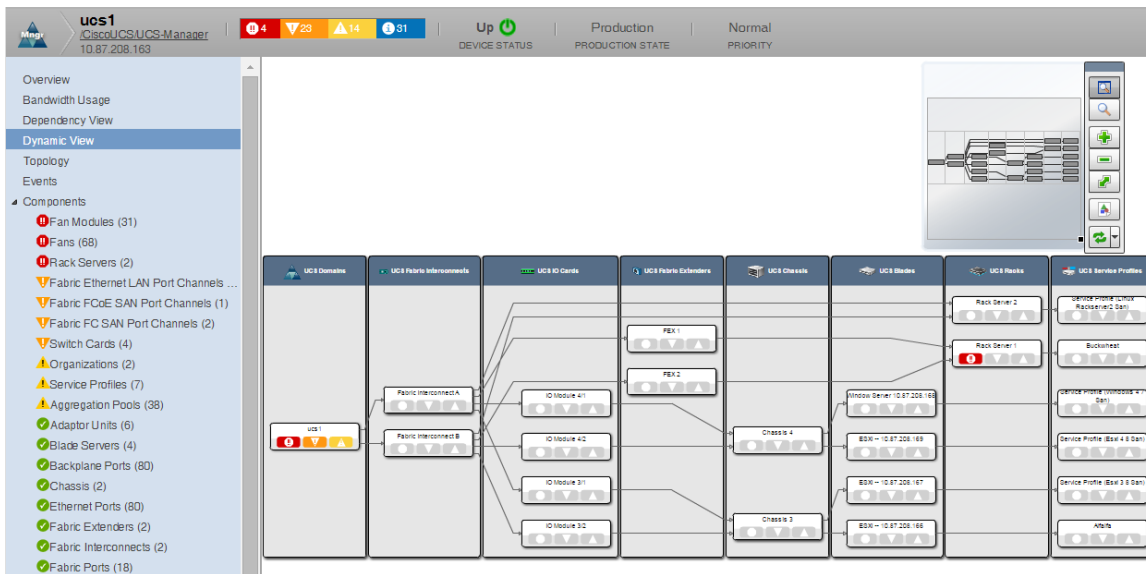

When you click an object in the graph, the "inspector" panel appears. This panel provides detailed information about the object and links directly to it. Information that appears in the inspector depends on the object type selected.

**Figure 54:** Dynamic view: Inspector panel

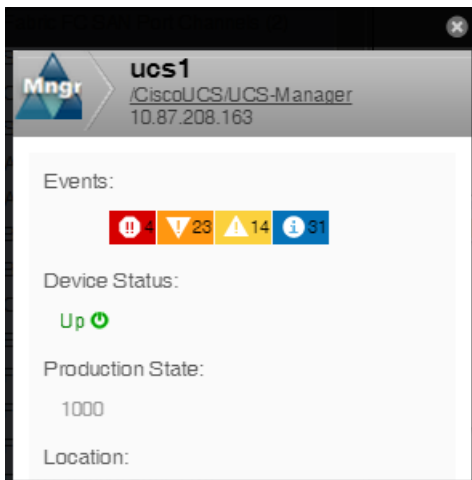

View controls appear to the right of the graph. These allow you to adjust your view:

- **Overview** - Toggles display on and off of the graph overview illustration.
- **Magnifier** - Toggles on and off the magnifier, which allows you to magnify selected portions of the graph.
- **Zoom In** - Zooms in on the graph.
- **Zoom Out** - Zooms out on the graph.
- **Fit View** - Fits the graph to the browser page.
- **Save Image** - Saves the dynamic view as a .png image.
- **Refresh** - Refreshes the graph.

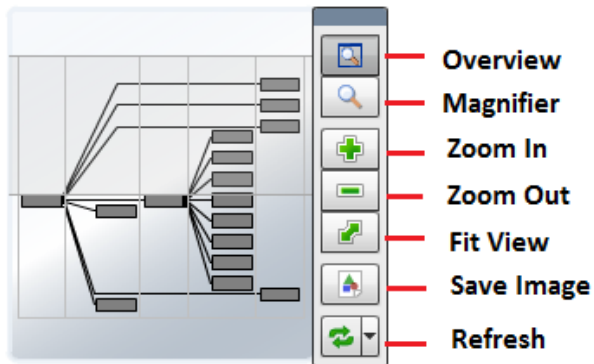

**Figure 55:** Dynamic view controls

### Dynamic view of devices

The dynamic view of devices shows the relationship between a device and monitored components.

To access the dynamic view for a device:

- 1 From **INFRASTRUCTURE > Devices**, click a device in the device list. The device overview page appears.
- 2 Select **Dynamic View** in the left panel.

### Events

Detailed information about events, scoped to the device, appears in the Events view. From here, you can:

- Sort event and event archive information by a range of categories
- Classify and acknowledge events
- Filter events by severity, state, or by one of several categories

### Components

The Components view provides information about the different types of device components, including:

- IPService
- WinService
- IpRouteEntry
- IpInterface
- CPU
- FileSystem

To access components information, select Components in the left panel, and then select a component type. The components available will vary based on the type of device.

Figure 56: Device (Components)

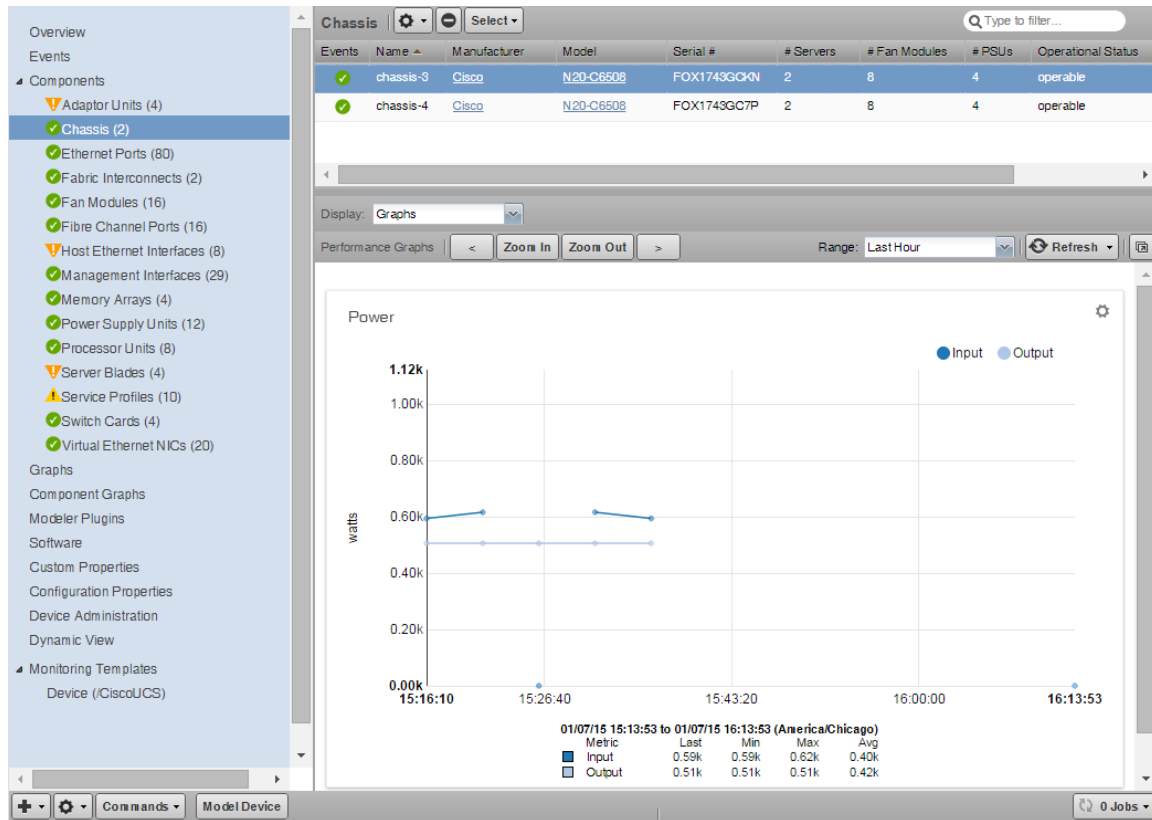

The status of each device component type, as shown by the color of its indicator, is determined by the collective status of the monitored components of the same type. For example, if the IpService status is green, then all monitored IpServices on the device are functioning normally. If there is an event related to a monitored IpService, then the highest severity event associated with that component is displayed.

**Note** If there is an event unrelated to a known component, then the system places it in the component type Other.

From this view, you can:

- Lock components
- Turn on or off component monitoring
- Delete components

### Disabling component monitoring

There may be occasions when you want to stop monitoring certain components of your monitored resources.

To disable monitoring on one or more components:

- 1 On the Device overview page, select the component group.
- 2 In the Component list, select the components for which you want to disable monitoring.
- 3 Click **Action > Monitoring**.
- 4 Click **NO** to disable monitoring.

You may want to clean up the Event log of any events that were created by these components prior to the disabling of monitoring, see [Closing events](#) on page 139.

## Graphs (Performance)

The Graphs view shows performance graphs that are defined for the device or component. To access graphs, in the left panel, select **Graphs**.

**Figure 57: Performance Graph (Device)**

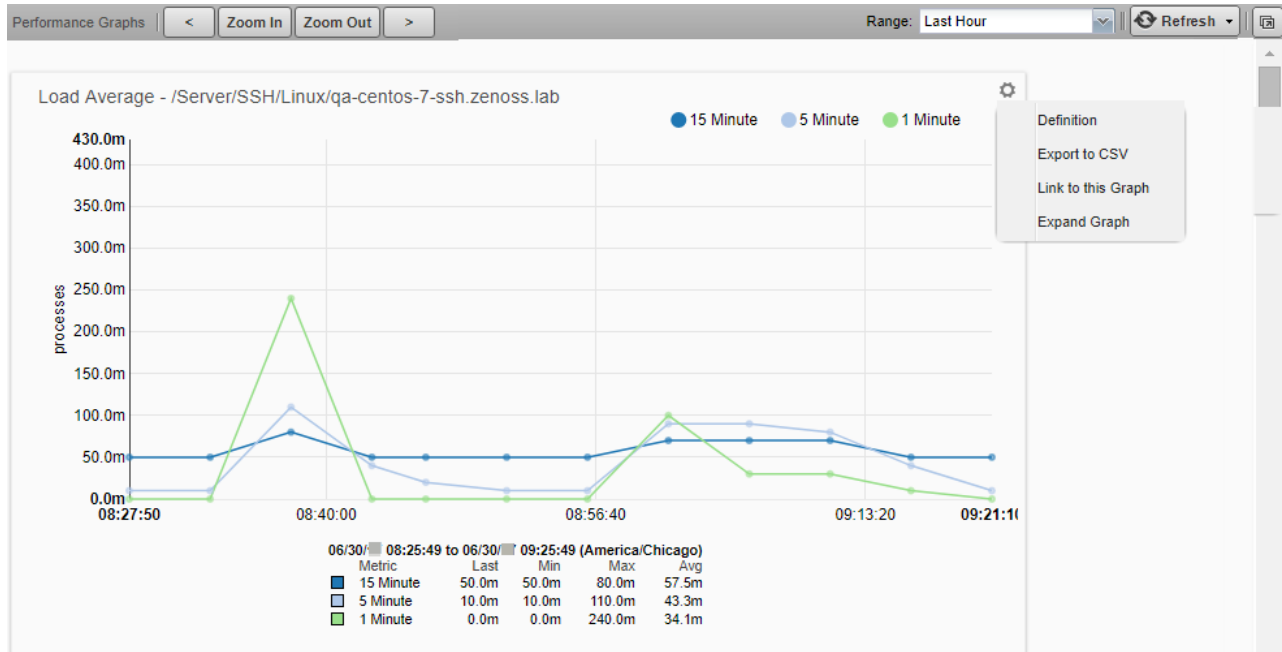

**Note** To change the graph view, scroll through, or zoom in or out of a graph, use the arrow key and magnifying glass controls.

You can control the following performance graph options:

- **Time range controls** - To narrow or expand the size of the time range, click **Zoom In/Zoom Out**. To scroll through time on the graph, click the forward and back arrowheads. Clicking these controls automatically puts you into a custom time range.
- **Range** - Select the span of time that the graph displays, as follows:
  - Last Hour
  - Yesterday
  - Last Week
  - Last 30 days
  - Last Year
  - Custom - Select the Start and End time to display. To set the end time to the current time, check **Now**. After changing a custom range setting, click **Refresh** to update the graph.
- **Refresh** - To modify the refresh value (by default, 30 minutes), click the drop-down list. If you set the refresh rate to manual, click **Refresh** each time you want an updated graph.
- **Pop-out** - To render the current graphs in full-screen mode, click the icon in the upper right corner of the page.
- **Action (gear)** - To open a submenu of the following actions, click the icon in the upper right corner of the graph.
  - **Definition** - View the JSON definition.

- **Export to CSV** - Export the datapoints as a .csv file for use in a spreadsheet. Only data contained in the defined range will be included.
- **Link to this Graph** - Generate a link to this graph to save in browser bookmarks or use the URL to directly point to the graph in another Web page or dashboard. For example, to show the graph in the Dashboard, create a **Site Window** portlet and insert the URL to the graph.
- **Expand graph** - Render the current graph in full-screen mode.
- **Table Legend** - To highlight a particular data set, hover the pointer over a legend description. To toggle the displayed legend description, click it. A solid dot indicates that data will be displayed. A hollow dot indicates data will be hidden.

For more information about performance monitoring and performance graphs, see [Performance monitoring](#) on page 111.

## Component graphs

The component graphs view shows component graphs defined for the device. To access these graphs, select **Component Graphs** in the left panel. The following figure shows a fabric extender utilization graph that has all metrics displayed on the same graph.

**Figure 58: Component graph (Device)**

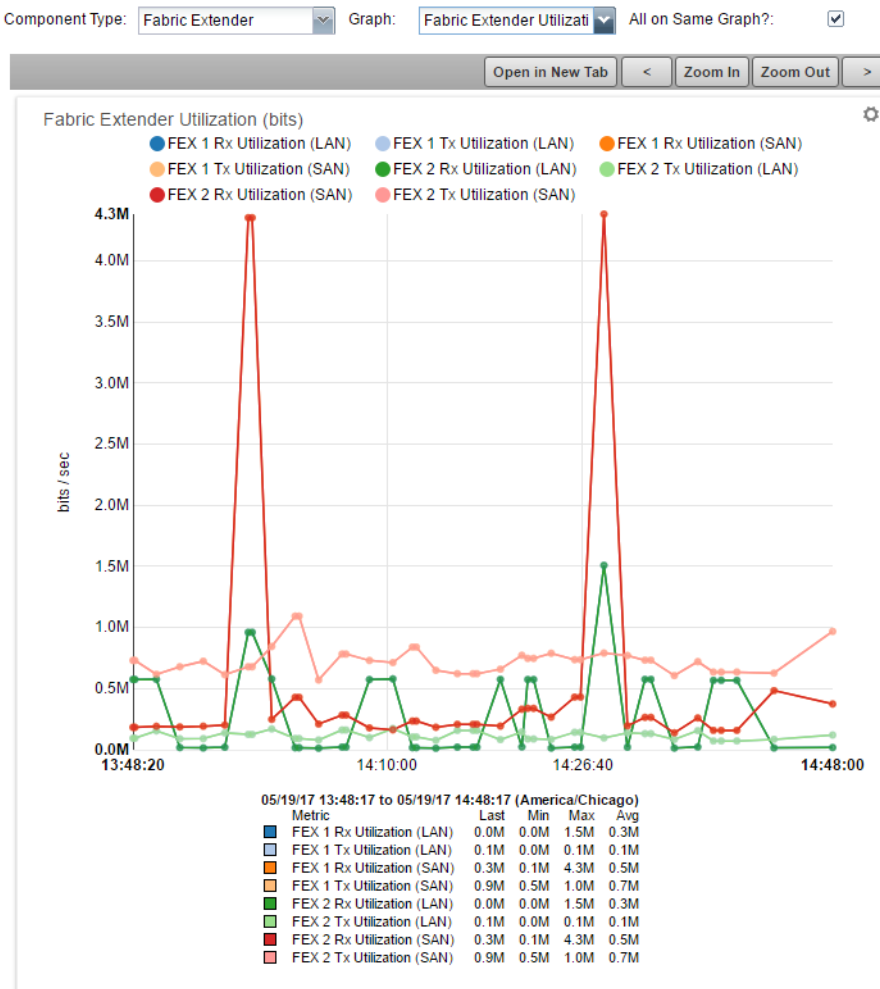

**Note** You can use the arrow key and magnifying glass controls on the sides of each graph to change the graph view, scrolling through or zooming in or out of a graph.

You can control these component graph options:

- **Component Type** - Drop-down of available components based on the type of device being monitored.
- **Graph** - Drop-down of available graphs based on the selected component type.
- **All on Same Graph?** - Select this check box to display all the metrics on one graph. Clear this check box to have a separate graph for each metric.

## Modeler plugins

Use the Modeler Plugins view to manage plugins that are run against a device. To access plugins, select Modeler Plugins in the left panel.

**Figure 59:** Device (modeler plugins)

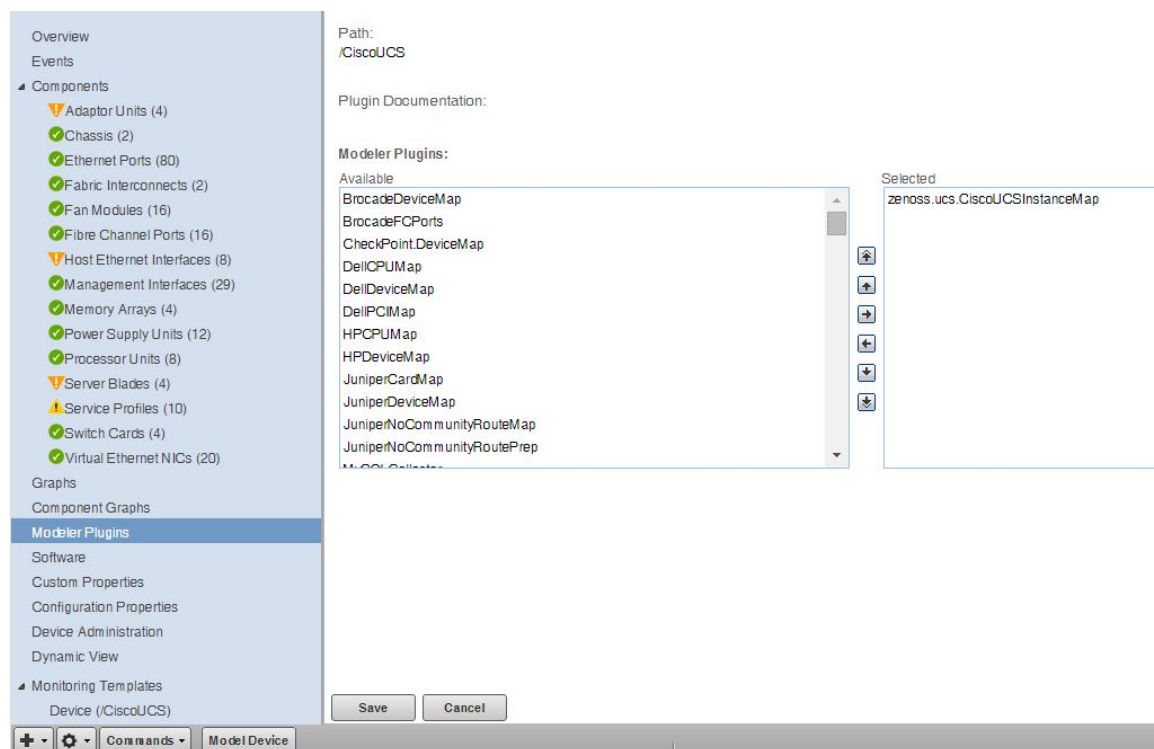

## Software

The Software view lists software installed on the device. The details provided in this area depend on the method used to model the device.

Listed software links into the system's inventory of software in your IT infrastructure. You can view this inventory from the Manufacturers link on the sub-navigation menu.

To access software information, select Software in the tree view.

## Custom properties

Use the Custom Properties view to edit the values of custom properties associated with a device.

To display the Custom Properties view, click on a device name in the device list, and then select **Custom Properties** in the left panel. You can perform the following actions on custom properties:

- Add
- Edit
- Refresh
- Delete

**Figure 60:** Device (custom properties)

Property Name	Description	Value	Path	Type	Is Local
cDateTest		1900/01/01 00:00:00 US/Central	/	date	

**Note** The Custom Properties view allows you to edit the value of a custom property on an individual device, but not to define new custom properties for device classes. For more information about custom properties, refer to knowledge base article ["How To Add Custom Properties"](#) on the [Zenoss Support](#) site.

## Configuration properties

From the Configuration Properties view, you can configure certain configuration properties for a device, and delete local properties from a device.

To access configuration properties, select Configuration Properties in the left panel.

**Figure 61:** Device (configuration properties)

Is Local	Category	Name	Value	Path
	Cisco	zCiscoACEUseSSL	true	/
	Cisco	zCiscoRemodelEventClassKeys		/
	Cisco UCS	zCiscoUCSCIMCEventsInterval	60	/
	Cisco UCS	zCiscoUCSCIMCPerfInterval	300	/
	Cisco UCS	zCiscoUCSMManagerPort	443	/
	Cisco UCS	zCiscoUCSMManagerUseSSL	true	/
	Cisco UCS	zCiscoUCSMManagerUser	admin	/
	Modeler Controls	zCollectorClientTimeout	180	/
	Modeler Controls	zCollectorDecoding	utf-8	/
	Misc	zCollectorLogChanges	false	/
	zencmmand	zCommmandCommmandTimeout	15	/
	zencmmand	zCommmandExistenceTest	test -f %s	/
	zencmmand	zCommmandLoginTimeout	10	/
	zencmmand	zCommmandLoginTries	1	/
	zencmmand	zCommmandPassword		/
	zencmmand	zCommmandPath	\$(here/managerlibexec)	/
	zencmmand	zCommmandPort	22	/
	zencmmand	zCommmandProtocol	ssh	/
	zencmmand	zCommmandSearchPath		/
	zencmmand	zCommmandUsername		/
	Control Center	zControlCenterHost	\$(here/managerip)	/
	Control Center	zControlCenterModelCycle	3600	/
	Control Center	zControlCenterPassword		/
	Control Center	zControlCenterPerfData	onn	/

For detailed information about working with configuration properties, see [Configuration properties](#) on page 76.

## Device administration

Use the Device Administration view to:

- Add, delete, and run custom user commands
- Manage maintenance windows
- Determine who holds administration capabilities for the device, and their roles

To access administration options, select **Device Administration** in the left panel.

**Figure 62:** Device administration

The screenshot displays the Device Administration interface. On the left is a navigation menu with 'Device Administration' selected. The main area is divided into three sections:

- Maintenance Windows:** A table with columns: Enabled, Name, Start, Duration, Repeat, State.
 

Enabled	Name	Start	Duration	Repeat	State
No	1st of Month	2014/12/01 02:00:00	01:00:00 hrs	Monthly: day of month	Maintenance
Yes	Every Thursday Night	2014/12/11 22:00:00	30:00 mins	Weekly	Maintenance
Yes	One Time Testing	2014/12/20 08:00:00	04:00:00 hrs	Never	Test
- User Commands:** A table with columns: Name, Command.
 

Name	Command
DNS forward	host \${device/id}
DNS reverse	host \${device/managerip}
ping	\${device/pingCommand} -c2 \${device/mana...
snmpwalk	snmpwalk -\${device/zsnmpVer} -c\${device/z...
traceroute	\${device/tracerouteCommand} -q 1 -w 2 \${d...
- Administrators:** A table with columns: Name, Role, Email, Pager.
 

Name	Role	Email	Pager
cgilchrist	Manager	cgil...	

For more information about device administration tasks, see the following topics:

- [Maintenance windows](#) on page 155
- [Defining user commands for a single device](#) on page 173
- [Defining user commands for all devices in an organizer](#) on page 174
- [Adding administrators](#) on page 178

## Overridden objects

Use the Overridden Objects view to see the objects that have overrides on their configuration properties. This view is available when looking at details of all devices.

To display the Overridden Objects view, navigate to the **Infrastructure > Devices** pages and click **Details**. Then, click **Overridden Objects** from the left-column menu.

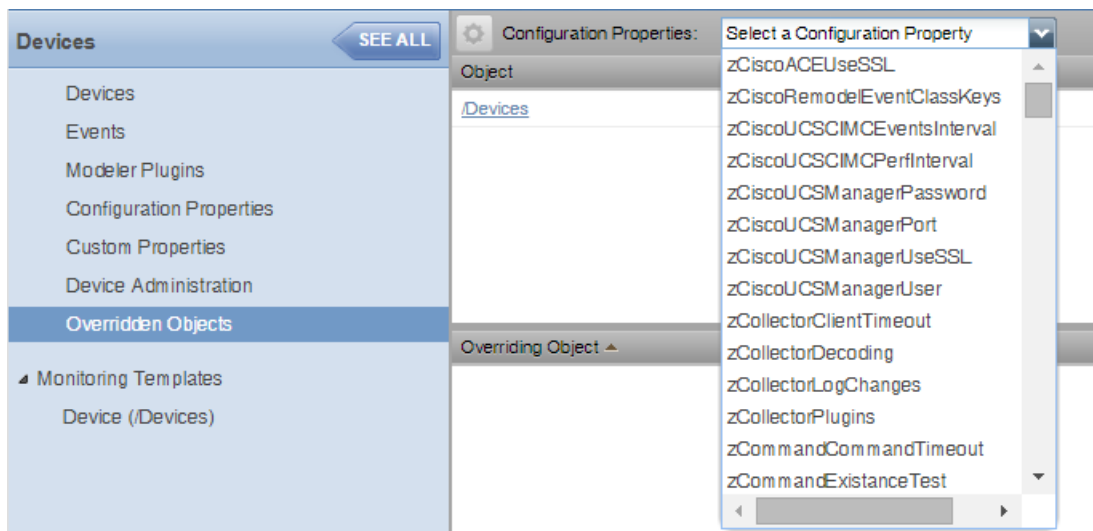

Select a configuration property from the drop-down list to view the overridden objects for that property. Double-click the row of the overriding object to open an edit dialog box.

**Note** Do not click the link of the overriding object. You will be taken to that object's page in the infrastructure view. Instead, double-click the clear area of the row of the overriding object to view the Edit Configuration Property dialog.

## Monitoring templates

Monitoring templates determine how the system collects performance data for devices and device components.

To access monitoring templates, expand Monitoring Templates in the left panel, and then select Device. The page shows all of the monitoring templates that are bound by name to this device.

**Figure 63:** Device (monitoring templates)

Data Sources				Thresholds	
Data Points by Data Source ▲				Name	
Source	Enabled	Type			
laLoadInt1	true	SNMP	high load		
laLoadInt15	true	SNMP	low CPU idle		
laLoadInt5	true	SNMP			
memAvailReal	true	SNMP			
memAvailSwap	true	SNMP			
memBuffer	true	SNMP			
memCached	true	SNMP			
ssCpuIdle	true	SNMP			
ssCpuRawWait	true	SNMP			
ssCpuSystem	true	SNMP			
ssCpuUser	true	SNMP			
ssiORawReceived	true	SNMP			
ssiORawSent	true	SNMP			
sysUpTime	true	SNMP			

Graph Definitions	
Name	
Load Average	
CPU Utilization	
Memory Utilization	
IO	

For detailed information about monitoring templates, see [Performance monitoring](#) on page 111.

## Managing devices and device attributes

Read the information and procedures in this section to learn about specific device management tasks, including:



- Clearing heartbeat events
- Pushing configuration changes to the system
- Locking device configuration
- Renaming devices
- Remodeling devices
- Setting the device manage IP address

## Clearing heartbeat events

If you have devices configured to send a recurring event that is mapped to a heartbeat class, you can clear stale heartbeat events.

To clear the heartbeat events associated with a device:

- 1 Navigate to **ADVANCED > Settings**.
- 2 In the left panel, select **EVENTS**.
- 3 At the bottom of the Event Configuration page, click the **Clear** button in the Clear Event Heartbeats section. The system displays a brief message banner.

## Locking device configuration

You can lock a device's configuration to prevent changes from being overwritten when remodeling the device. Two levels of locking are available. You can lock the configuration from deletion and updates, or solely from deletion.

---

**Note** Device locking prevents changes and deletion due to remodeling. It does not prevent manual changes and deletion.

---

To edit lock selections for a device configuration:

- 1 Navigate to the device in the device list.
- 2 At the bottom of the device overview page, select **Locking** from the Action menu. The Lock Device dialog box appears.

**Figure 64:** Lock Device Dialog

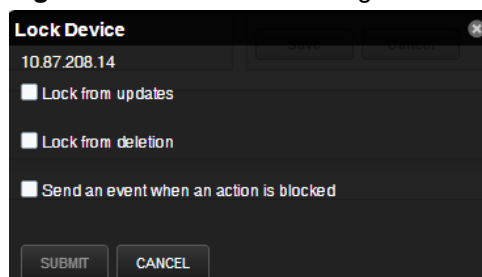

- 3 Select the type of lock you want to implement or remove.
- 4 To send events when actions are blocked by a lock action, select the "Send an event..." option. The lock or unlock action is implemented on the device, and the system displays a confirmation message of the action.

## Renaming a device

Because the system uses the manage IP to monitor a device, the device name may be different than its fully qualified domain name (FQDN). The device name must always be unique in the system.

To rename a device:

- 1 Navigate to the device in the device list. Click the device name.
- 2 On the device overview page, edit the Device Name field with the new device name.
- 3 Click **Save**. The system renames the device and displays a confirmation message of the action.

## Re-identifying a device

Changing the device ID in the system is different from changing the device name. If you change the ID, you lose all graph data for this device.

To re-identify a device:

- 1 Navigate to the device in the device list. Click the device name to open the Device Overview page.
- 2 At the bottom of the Device Overview page, select **Reidentify Device** from the Action menu.
- 3 Enter a new ID for the device.
- 4 Click **Submit**.

## Remodeling a device

Remodeling forces the system to re-collect all configuration information associated with a device. Normally, the system models devices every 720 minutes; however, if you want to remodel a device immediately, follow these steps:

- 1 Navigate to the device in the device list and click on the Device name.
- 2 At the bottom of the Device Overview page, click the **Model Device** button. The system remodels the device. A dialog box appears that shows progress of the action.

## Resetting the device manage IP address

You might reset the manage IP address if the IP address of a device changed and you want to maintain the historical data at the original IP address. To reset the manage IP address of a device:

- 1 Navigate to the device in the device list.
- 2 At the bottom of the device overview page, select Reset/Change IP Address from the Action menu. The Reset IP dialog box appears.

**Figure 65:** Reset IP dialog box

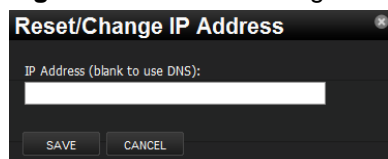

- 3 Enter the new IP address for the device, or leave the field blank to allow the IP address to be set by DNS.
- 4 Click **Save**. The IP address for the device is reset.

## Deleting a device

To delete a device from the system:

- 1 Navigate to the **INFRASTRUCTURE** page.
- 2 Select the device you want to remove from the system by clicking on its row. You can select multiple devices by Ctrl-clicking or Shift-clicking the devices. Be sure to click on the row in an area that is not defined by a link. The Delete Device dialog appears.

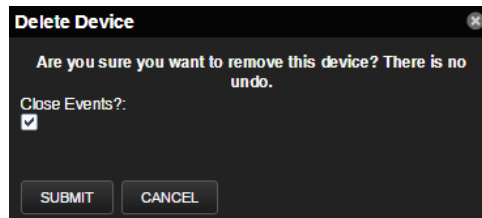
**Figure 66: Delete Device**

- 3 Optional: Change the selection to close current events for the device. By default, event data is removed.
- 4 Click **Submit**. The system removes the devices and associated data (if selected), and displays a confirmation message of the action.

## Dumping and loading devices

The system allows you to export a list of your devices to a text file to import into another system instance. You can do this by using the `zenbatchdump` command on the CLI.

- 1 Log in to the Control Center host as a user with `serviced` CLI privileges.
- 2 Attach to the `zenhub` service.

```
serviced service attach zenhub
```

- 3 Change to the `zenoss` user.

```
su - zenoss
```

- 4 Export the device list to a text file.

```
zenbatchdump > mydevicelist.txt
```

This command writes the names of your devices (including their device classes, groups, and systems) to a file named `mydevicelist.txt`.

To load these devices into another instance (or reload them into the same instance), while attached to the `zenhub` service of the system instance where you want the devices to be discovered, run the command:

```
zenbatchload mydevicelist.txt
```

The system attempts to discover each of the devices in the text file.

For additional ways to add and discover devices, see [Adding, discovering and modeling devices](#) on page 49.

## Configuration properties

---

- **Devices** *Device configuration properties* control the way that devices are monitored.
- **Events** *Event configuration properties* control the rules that process events as they are received by the system.
- **Networks** *Network configuration properties* control options that are used when you perform network discovery.

Configuration properties and values can be added to the ZenPacks you create, allowing you to customize the system when you add ZenPacks.

### Configuration properties inheritance and override

---

The following diagram illustrates a portion of the standard device class hierarchy. (A *device class* is a special type of organizer used to manage how the system models and monitors devices.)

At the root of the device hierarchy is the **Devices** object. All device class configuration properties are defined here. Their values are the default values for the entire hierarchy.

**Figure 67:** Device class hierarchy

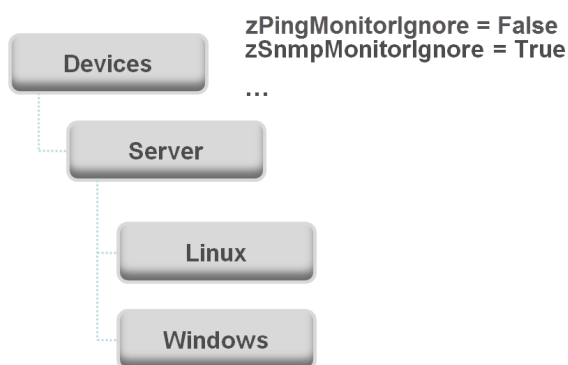

The illustration shows two defined configuration properties:

- **zPingMonitorIgnore**- Turns off all daemons that use ping. By default, its value at the root of the hierarchy is False.
- **zSNMPMonitorIgnore** - Turns off all daemons that use SNMP. By default, its value at the root of the hierarchy is True.

Through *inheritance*, properties that are defined at the root of the hierarchy apply to all objects beneath that node. So, at the `/Devices/Server/Linux` level of the device class hierarchy, the value of these two properties is the same as at `/Devices`, even though the property is not set explicitly at `/Devices/Server/Linux`. Inheritance simplifies system configuration because default values that are set at the root level apply to all devices regardless of their device class.

To further customize the system, you can change a specific configuration property further down the hierarchy without having to change the definitions of other configuration properties. As shown in the following illustration, the value of `zPingMonitorIgnore` is changed so that ping monitoring is performed at the `/Devices/Server/Windows` level.

**Figure 68:** Device Class Hierarchy - Locally Defined Value (Override)

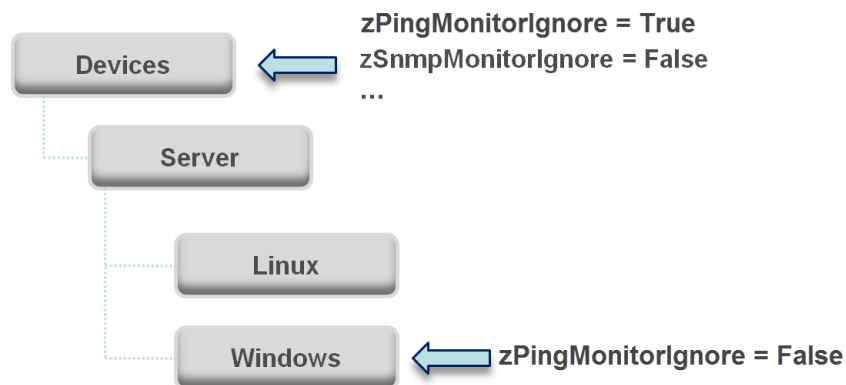

This locally defined value for `zPingMonitorIgnore` *overrides* the value that is set at the root of the hierarchy. No other properties at this level are affected by this local change; they continue to inherit the value that is set at the root.

Configuration properties allow you to configure the system at a very granular level, down to a particular device. For example, in the following illustration, the device named `dev.zenoss.com` has the value of SNMP community set to private. This value overrides the root value of public.

**Figure 69:** Device Class Hierarchy - Value Set on Device

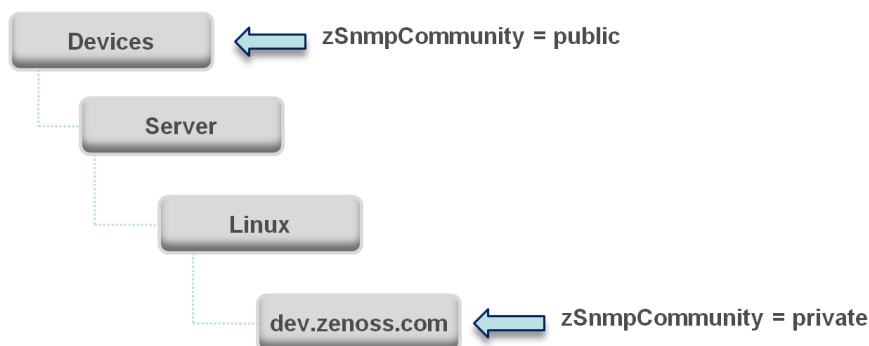

If you change the SNMP Community value of `dev.zenoss.com` to public, it matches the value that is set at the root, but is still explicitly defined. Only if you remove the locally defined property does it again inherit the value of the property that is set at the root.

## Viewing properties from the browser interface

This section further illustrates the characteristics of configuration properties from the browser interface perspective. The following figure shows device configuration properties that are defined at the root level.

To view configuration properties:

- 1 From the Navigation bar, select **Infrastructure**.

The Devices page appears.

- 2 Click **Details**.
- 3 Select **Configuration Properties**.

**Figure 70:** Defined device configuration properties - root level

Configuration Properties <span>⚙️</span> <span>🔄</span> <span>Delete Local Copy</span>				
Is Local	Category	Name ▲	Value	Path
Yes	CiscoUCS	zCiscoUCSManagerPassword		/
Yes	CiscoUCS	zCiscoUCSManagerPort	80	/
Yes	CiscoUCS	zCiscoUCSManagerUseSSL	false	/
Yes	CiscoUCS	zCiscoUCSManagerUser		/
Yes	Modeler Controls	zCollectorClientTimeout	180	/
Yes	Modeler Controls	zCollectorDecoding	latin-1	/
Yes	Misc	zCollectorLogChanges	false	/
Yes	zencommand	zCommandCommandTimeout	15	/
Yes	zencommand	zCommandCycleTime	60	/
Yes	zencommand	zCommandExistenceTest	test -f %s	/
Yes	zencommand	zCommandLoginTimeout	10	/
Yes	zencommand	zCommandLoginTries	1	/
Yes	zencommand	zCommandPassword		/
Yes	zencommand	zCommandPath	\$ZENHOME/libexec	/
Yes	zencommand	zCommandPort	22	/
Yes	zencommand	zCommandProtocol	ssh	/
Yes	zencommand	zCommandSearchPath		/
Yes	zencommand	zCommandUsername		/
Yes	Misc	zDeviceTemplates	Device	/
Yes	Misc	zEC2Secret		/
Yes	Modeler Controls	zFileSystemMapIgnoreNames		/
Yes	Modeler Controls	zFileSystemMapIgnoreTypes	other ram virtualMemory removableDisk floppyDisk compactDisk ramDisk f	/
Yes	Misc	zFileSystemSizeOffset	1	/

DISPLAYING 1 - 22 OF 127 ROWS

As shown in the figure above, the `zCollectorClientTimeout` configuration property has a default value of 180. In the following figure, the value is set to 170 at the `/Server/Linux` device class, which overrides the default value at this node of the hierarchy.

**Figure 71:** zCollectorClientTimeout configuration property - local value set

Configuration Properties					
Is Local	Category	Name	Value	Path	
	CiscoUCS	zCiscoUCSManagerPassword		/	
	CiscoUCS	zCiscoUCSManagerPort	80	/	
	CiscoUCS	zCiscoUCSManagerUseSSL	false	/	
	CiscoUCS	zCiscoUCSManagerUser		/	
Yes	Modeler Controls	zCollectorClientTimeout		/Server/Linux/devices/t-cent5a-64.zeno	
	Modeler Controls	zCollectorDecoding		/	
	Misc	zCollectorLogChanges		/	
	zencommand	zCommandCommandTimeout	15	/	
	zencommand	zCommandCycleTime	60	/	
	zencommand	zCommandExistenceTest	test -f %s	/	
	zencommand	zCommandLoginTimeout	10	/	
	zencommand	zCommandLoginTries	1	/	

DISPLAYING 1 - 13 OF 127 ROWS

Shows the node at which the default value is overridden

To remove the override and once again inherit the value from the root of the hierarchy:

- 1 Select the property in the list.
- 2 Click **Delete Local Copy**.

The Delete Local Property dialog box requests confirmation of the action.

- 3 Click **OK**.

## Configuration property types

Configuration properties can be one of the following types:

- **String**- Text value that can be ASCII or Latin-1 encoded
- **Integer**- Whole number
- **Float**- Number that can have a decimal value
- **Boolean**- True or False
- **Lines**- List of values separated by a return. The system stores these as an array.
- **Password**- Character-masked password value

## Device configuration properties

To view and edit device configuration properties at the root level:

- 1 From the Navigation bar, select **Infrastructure**.
- 2 In the tree view, click **Details**.
- 3 Select **Configuration Properties**.

To view and edit device configuration properties that are set at a specific device class, navigate to that class, click **Details**, and then select **Configuration Properties**.

You can also view and edit device configuration at the individual device level. Select the device from the device list, and then select **Configuration Properties** from the left panel.

The following table lists device configuration properties.

**Table 4: Device configuration properties**

Property Name	Property Type	Description
zCiscoACEUseSSL	boolean	Whether to use SSL when connecting to ACE XML API.
zCiscoNXAPIInterval	int	Value in seconds of the rediscovery interval using the Cisco NX-API protocol. Default value is 300.
zCiscoRemodelEventClassKeys	lines	Allows you to modify the list of SNMP traps that will cause Zenoss to schedule an immediate remodeling of the device from which the trap was sent.
zCiscoUCSCIMCEventsInterval	int	Event collection interval in seconds. Default is 60.
zCiscoUCSCIMCPerfInterval	int	Metric collection interval in seconds. Default is 300.
zCiscoUCSManagerPassword	password	UCS Manager username password
zCiscoUCSManagerPerfInterval	int	Seconds between UCS Manager statistics collections. Default value is 300.
zCiscoUCSManagerPort	int	Port used to connect to the UCS Manager or CIMC XML APIs. Default is 443 and typically should not be changed.
zCiscoUCSManagerUseSSL	boolean	Whether to use SSL when connecting to the UCS Manager or CIMC XML APIs. Default is true and typically should not be changed.
zCiscoUCSManagerUser	string	UCS Manager username
zCollectorClientTimeout	int	Allows you to set the timeout time of the collector client in seconds
zCollectorDecoding	string	Converts incoming characters to Unicode.
zCollectorLogChanges	boolean	Indicates whether to log changes.
zCommandCommandTimeout	float	Specifies the time to wait for a command to complete.
zCommandExistenceTest	string	DEPRECATED - No longer used.
zCommandLoginTimeout	float	Specifies the time to wait for a login prompt.
zCommandLoginTries	int	Sets the number of times to attempt login.
zCommandPassword	password	Specifies the password to use when performing command logins and SSH.
zCommandPath	string	Sets the default path where ZenCommand plug-ins are installed on the local Resource Manager box (or on a remote box where SSH is used to run the command).
zCommandPort	int	Specifies the port to connect to when performing command collection.
zCommandProtocol	string	Establishes the protocol to use when performing command collection. Possible values are SSH and telnet.
zCommandSearchPath	lines	Sets the path to search for any commands.



Property Name	Property Type	Description
zCommandUsername	string	Specifies the user name to use when performing command collection and SSH.
zControlCenterHost	string	Control Center Host Name. Defaults to device name.
zControlCenterModelCycle	int	Control Center Modeling interval. Defaults to 3600s.
zControlCenterPassword	password	Control Center username password
zControlCenterPerfCycle	int	Control Center Performance Collection interval. Defaults to 300s.
zControlCenterPort	int	Port for Control Center. Defaults to HTTPS TCP/443
zControlCenterUser	string	Control Center username
zDBInstances	***	***instancecredentials. This setting is only relevant when the <code>zenoss.winrm.WinMSSQL</code> modeler plugin is enabled. Multiple instances can be specified to monitor multiple SQL Server instances per server. The default instance is <code>MSSQLSERVER</code> . Fill in the user and password to use SQL authentication. Leave the user and password blank to use Windows authentication.
zDeviceTemplates	lines	Sets the templates associated with this device. Linked by name.
zEnablePassword	boolean	True or False to specify use of password for Cisco routers.
zFileSystemMapIgnoreNames	string	Sets a regular expression of file system names to ignore.
zFileSystemMapIgnoreTypes	lines	Do not use.
zFileSystemSizeOffset	int	SNMP typically reports the total space available to privileged users. Resource Manager (like the <code>df</code> command) reports capacity based on the space available to non-privileged users. The value of <code>zFileSystemSizeOffset</code> should be the fraction of the total space that is available to non-privileged users. The default reserved value is 5% of total space, so <code>zFileSystemSizeOffset</code> is preset to <code>.95</code> . If the reserved portion is different than 5%, then adjust the value of <code>zFileSystemSizeOffset</code> accordingly. The fraction should be set according to the value $(Used + Avail) / Size$ when the <code>df -PkH</code> command is run at the command line.
zHardDiskMapMatch	string	Regular expression that uses the disk ID in the <code>diskstats</code> output to filter disk activity statistics for inclusion in performance monitoring.
zIcon	lines	Specifies the icon to represent the device wherever device icon is shown, such as on the network map and device status page.
zIdiomPassword	password	IDIOM API password for Cisco IDS/IPS devices.

Property Name	Property Type	Description
zIdiomUsername	string	IDIOM API username for Cisco IDS/IPS devices.
zIfDescription	boolean	Shows the interface description field in the interface list.
zInterfaceMapIgnoreDescriptions	string	Filters out interfaces based on description.
zInterfaceMapIgnoreNames	string	Filters out interfaces that should not be discovered. If you want to use an expression to define this property, note that only Python regular expressions are valid.
zInterfaceMapIgnoreTypes	string	Filters out interface maps that should not be discovered.
zIpServiceMapMaxPort	int	Specifies the highest port to scan. The default is 1024.
zJBossJmxManagementAuthenticate	boolean	DEPRECATED - No longer used.
zJBossJmxManagementPassword	password	JMX password
zJBossJmxManagementPort	int	The port number used to gather JMX information
zJBossJmxManagementUsername	string	JMX username for authentication.
zJmxAuthenticate	boolean	True or False to enable/disable authentication.
zJmxManagementPort	int	Port that enables JMX management
zJmxPassword	password	JMX username password
zJmxUsername	string	JMX username
zKeyPath	string	Sets the path to the SSH key for device access.
zLDAPBaseDN	string	The Base Distinguished Name for your LDAP server. Typically this is the organization's domain name (for example, dc=foobar,dc=com)
zLDAPBindDN	string	The Distinguished Name to use for binding to the LDAP server, if authentication is required.
zLDAPBindPassword	string	The password to use for binding to the LDAP server, if authentication is required.
zLDMsAutodiscover	boolean	Specify true or false for autodiscovery of LDMs.
zLTMVirtualServerIgnoreNames	string	Regular expression that can be used to prevent matching LTM Virtual Servers from being modeled.
zLinks	string	Specifies a place to enter any links associated with the device.
zLocalInterfaceNames	string	Regular expression that uses interface name to determine whether the IP addresses on an interface should be incorporated into the network map. For instance, a loopback interface "lo" might be excluded.
zLocalIpAddresses	string	Specifies IP addresses that should be excluded from the network map (for example, 127.x addresses). If you have addresses that you reuse for connections between clustered machines they might be added here as well.

Property Name	Property Type	Description
zMaxOIDPerRequest	int	Sets the maximum number of OIDs to be sent by the SNMP collection daemons when querying information. Some devices have small buffers for handling this information so the number should be lowered.
zMySQLConnectionString	string	Enables setting the path, type and credentials for the MySQL connections. For example: <b>Path:</b> <i>/server/Linux/devices/localhost.localdomain</i> , <b>Type:</b> <i>mysql</i> , <b>MYSQL connection credentials:</b> <i>User Password Port</i>
zMySQLPassword	password	MySQL user password
zMySQLPort	string	MySQL connection port
zMySQLTimeout	int	MySQL timeout. Default value is 30s.
zMySQLUsername	string	MySQL username
zNetAppSSL	boolean	Boolean true or false to enable SSL use with the NetApp Monitor.
zNmapPortscanOptions	string	Options used on nmap when scanning ports. Used in IpServiceMap.
zPingMonitorIgnore	boolean	Whether or not to ping the device.
zProdStateThreshold	int	Production state threshold at which Resource Manager will begin to monitor a device.
zPropertyMonitorInterval	int	Polling interval of the configured property data sources. System-wide setting. Default is 300s.
zPythonClass	string	DO NOT USE
zRancidGroup	string	RANCID group attribute. Controls what <code>router.db</code> file the device is written to. Can be set at the device class or device level. Default is <code>router</code> on the <code>/Network/Router/Cisco</code> class.
zRancidRoot	string	File system directory where RANCID is installed. It may be NFS mounted from the RANCID server. Default is <code>/opt/rancid</code>
zRancidType	string	RANCID type attribute. Controls what device type is written to the <code>router.db</code> file. Can be set at the device class or device level. Default is <code>cisco</code> on the <code>/Network/Router/Cisco</code> class.
zRancidUrl	string	Base URL
zRouteMapCollectOnlyIndirect	boolean	Only collect routes that are indirectly connected to the device.
zRouteMapCollectOnlyLocal	boolean	Only collect local routes. (These usually are manually configured rather than learned through a routing protocol.)

Property Name	Property Type	Description
zRouteMapMaxRoutes	int	Sets maximum number of routes to collect. Default value is 500.
zSnmpAuthPassword	password	The shared private key used for authentication. Must be at least 8 characters long.
zSnmpAuthType	string	Use "MD5" or "SHA" signatures to authenticate SNMP requests
zSnmpCollectionInterval	int	Defines, in seconds, how often the system collects performance information for each device.
zSnmpCommunities	lines	Array of SNMP community strings that ZenModeler uses when collecting SNMP information. When you set this property, communities are tried in order; the first in the list that is successful is used as zSnmpCommunity. If none is successful, then the current value of zSnmpCommunity is used. The default value for the entire system is "public."
zSnmpCommunity	string	Community string to be used when collecting SNMP information. If it is different than what is found by ZenModeler, it will be set on the modeled device.
zSnmpContext	string	Configures zSNMP context to map logical network entity such as a topology or protocol instance.
zSnmpDiscoveryPorts	int	List of UDP ports to try when performing SNMP discovery. Defaults to 161 if not set.
zSnmpEngineId	string	SNMPv3 engine ID for the device. Will be discovered when SNMPv3 is used.
zSnmpMonitorIgnore	boolean	Whether or not to ignore monitoring SNMP on a device.
zSnmpPort	int	Port that the SNMP agent listens on.
zSnmpPrivPassword	password	The shared private key used for encrypting SNMP requests. Must be at least 8 characters long.
zSnmpPrivType	string	"DES" or "AES" cryptographic algorithms.
zSnmpSecurityName	string	The Security Name (user) to use when making SNMPv3 requests.
zSnmpTimeout	float	Timeout time in seconds for an SNMP request
zSnmpTries	int	Amount of tries to collect SNMP data
zSnmpVer	string	SNMP version used. Valid values are v2c, v1
zSshConcurrentSessions	int	Maximum number of sessions supported by the remote device's MAX_SESSIONS parameter. Common values for AIX are 2 or 10.
zStatusConnectTimeout	float	The amount of time that the zenstatus daemon should wait before marking an IP service down.
zSugarCRMBase	-	DEPRECATED - No longer used.

Property Name	Property Type	Description
zSugarCRMPassword	password	Password for the zSugarCRMUsername user.
zSugarCRMTestAccount	-	DEPRECATED - No longer used.
zSugarCRMUsername	string	Username allowed to log in to the Sugar CRM server.
zSysedgeDiskMapIgnoreNames	string	Regular expression used by zenoss.snmp.SysedgeDiskMap modeler plugin. Disks with matching names will not be modeled.
zTelnetEnable	boolean	When logging into a Cisco device issue the enable command to enable access during command collection.
zTelnetEnableRegex	string	Regular expression to match the enable prompt.
zTelnetLoginRegex	string	Regular expression to match the login prompt.
zTelnetPasswordRegex	string	Regular expression to match the password prompt.
zTelnetPromptTimeout	float	Time to wait for the telnet prompt to return.
zTelnetSuccessRegexList	lines	List of regular expressions to match the command prompt.
zTelnetTermLength	boolean	On a Cisco device, set term length to Zero.
zTomcatJ2EEApplicationName	string	Used to construct MBean names for a specific application deployed on Tomcat, typically used for JSP and Servlet statistics.
zTomcatJ2EEServerName	string	Used to construct MBean names for a specific application deployed on Tomcat, typically used for JSP and Servlet statistics.
zTomcatJmxManagementAuthenticate	-	DEPRECATED - No longer used.
zTomcatJmxManagementPassword	password	JMX password.
zTomcatJmxManagementPort	int	The port number used to gather JMX information.
zTomcatJmxManagementUsername	string	JMX username for authentication.
zTomcatListenHost	string	The hostname on which Tomcat is listening for web requests. This is used to construct MBean names
zTomcatListenPort	string	The Tomcat connector, which is a port and protocol (http, jk...) that Tomcat is listening on. This is used to construct MBean names that monitor bytes, error and requests on that connector.
zTomcatServletName	string	Specific Servlet name to monitor.
zTomcatServletUri	string	URI of Servlet to monitor.
zTomcatWebAppUri	string	URI path for a Tomcat web application. Used to construct MBean names.
zVCloudPassword	password	Password for the zVCloudUsername user.
zVCloudPort	int	Value of the cell port number

Property Name	Property Type	Description
zVCloudUsername	string	Username for the cell in the form <code>username@organization</code> . For example, if you want to define the cell administrator, enter <code>administrator@system</code> .
zVSphereEndpointHost	string	vSphere host name
zVSphereEndpointPassword	password	vSphere username password
zVSphereEndpointPort	int	Port that is used to connect to vSphere Endpoint.
zVSphereEndpointUseSsl	boolean	vSphere boolean true or false for SSL use
zVSphereEndpointUser	string	vSphere username
zVSphereHostCollectionClusterWhitelistlines		The whitelist filters the hosts that are monitored, based on cluster names.
zVSphereHostPingBlacklist	lines	List of regular expressions to control which management IP address to ping (matches against <code>hostname:nicname:ip</code> ).  <b>Note</b> zVSphereHostPingWhitelist takes precedence over zVSphereHostPingBlacklist.
zVSphereHostPingWhitelist	lines	List of regular expressions to control which management IP address to ping (matches against <code>hostname:nicname:ip</code> ).  <b>Note</b> zVSphereHostPingWhitelist takes precedence over zVSphereHostPingBlacklist.
zVSphereHostSystemPassword	password	Password that is used to access ESX hosts via ssh and API.
zVSphereHostSystemUser	string	User name that is used to access ESX hosts via ssh and API.
zVSphereLUNContextMetric	boolean	Controls whether to use LUN-specific metric names when storing performance data.  <b>Note:</b> The default value is False. Changing the value to True causes historical metrics to become inaccessible. For more information, contact Zenoss Support.
zVSphereModelCache	lines	vSphere model cache
zVSphereModelIgnore	lines	vSphere model ignore
zVSphereModelMpIndexObjs	int	Advanced tuning parameter. For more information, contact Zenoss Support.
zVSphereModelMpLevel	int	Advanced tuning parameter. For more information, contact Zenoss Support.
zVSphereModelMpObjs	int	Advanced tuning parameter. For more information, contact Zenoss Support.

Property Name	Property Type	Description
zVSpherePerfDelayCollectionMinutes	int	Value of how long to lag performance data collection. Default value is 0.
zVSpherePerfMaxAgeMinutes	int	Default value is 28 minutes.
zVSpherePerfParallelQueries	int	Default value is 6.
zVSpherePerfQueryChunkSize	int	Value of how many performance requests to make at a time. Default value is 250.
zVSpherePerfQueryRaw20	boolean	Default value is <code>true</code> .
zVSpherePerfQueryTimeout	int	Default value is 200.
zVSpherePerfQueryVcChunkSize	int	Default value is 64.
zVSpherePerfQueryVcRaw20	boolean	Default value is <code>false</code> .
zVSpherePerfRecoveryMinutes	int	Default value is 240 minutes.
zVSpherePerfTimeoutRecoveryMinutes	int	When a timeout error occurs in querying a specific metric, it is "blacklisted" for this number of minutes before it is retried. This action avoids repeated errors due to attempts to query a metric that is not working properly. The default is one hour. If gaps appear in the graphs, you can safely lower the value.
zVSphereVMContextMetric	boolean	Controls whether to use VM-specific metric names when storing performance data.  <b>Note:</b> The default value is <code>False</code> . Changing the value to <code>True</code> causes historical metrics to become inaccessible. For more information, contact Zenoss Support.
zVSpherePerfWindowSize	int	DEPRECATED - No longer used.
zWBEMPassword	password	WBEM password
zWBEMPort	int	Value of the WBEM port number. Default value is 5989.
zWBEMUseSSL	boolean	True or false value to use SSL. Default value is <code>true</code> .
zWBEMUsername	string	WBEM username
zWebLogicJmxManagementAuthenticate-		DEPRECATED - No longer used.
zWebLogicJmxManagementPassword	password	JMX password
zWebLogicJmxManagementPort	int	The port number used to gather JMX information
zWebLogicJmxManagementUsername	string	JMX username for authentication
zWebTxAgent	string	Default value is <code>ZenWebTx/1.0</code> .
zWebTxPassword	password	WebTx password
zWebTxRealm	string	WebTx realm
zWebTxUser	string	WebTx user

Property Name	Property Type	Description
zWebsphereAuthRealm	string	Used for HTTP basic authentication. This field is not required, and is <b>empty</b> by default.
zWebsphereNode	string	Used by the provided template to build the queries for the data to collect. You must supply a value for this field. For example: <i>serverA</i>
zWebspherePassword	password	Used for HTTP basic authentication. This field is not required, and is <b>empty</b> by default.
zWebsphereServer	string	Used by the provided template to build the xpath queries for the data to collect. You must supply a value for this field. For example: <i>serverAB</i> , There is no default value.
zWebsphereURLPath	string	Path to the PMI servlet on a WebSphere instance. The default value is the default path on a WebSphere installation: <code>wasPerTool/servlet/perfservlet</code>
zWebsphereUser	string	Used for HTTP basic authentication. This field is not required, and is <b>empty</b> by default.
zWinKDC	string	IP address or Fully Qualified Domain Name of a valid Windows domain controller. Must be set if domain authentication is used.
zWinKeyTabFilePath	string	This property is currently used and reserved for future use when keytab files are supported.
zWinPerfmonInterval	int	Interval, in seconds, at which Windows Perfmon datapoints will be collected. Default value is 300. It is possible to override the collection interval for individual counters.
zWinRMPassword	password	Password for the user defined by <code>zWinRMUser</code>
zWinRMPort	int	The port on which the Windows server is listening for WinRM or WS-Management connections. Default value is 5985. It is uncommon for this to be configured as anything else.
zWinRMServerName	string	This property should only be used in conjunction with domain authentication when the DNS PTR record for a monitored server's managed IP address does not resolve to the name by which the server is known in Active Directory. For example, if <code>myserver1</code> is known as <code>myserver1.ad.example.com</code> by Active Directory and is being managed by IP address <code>192.51.100.21</code> , but <code>192.51.100.21</code> resolves to <code>www.example.com</code> , you will have to set <code>zWinRMServerName</code> to <code>myserver1.ad.example.com</code> for domain authentication to work.

If many Windows servers in your environment do not have DNS PTR records that match Active Directory,



Property Name	Property Type	Description
		<p>it is recommended that you set the name of the Zenoss device to be the fully-qualified Active Directory name and set <code>zWinRMServerName</code> to <code>\${here/titleOrId}</code> at the <code>/Server/Microsoft/Windows</code> device class. This avoids the necessity of setting <code>zWinRMServerName</code> on every device.</p> <p>It is recommended to leave <code>zWinRMServerName</code> blank if local authentication is used, or DNS PTR records match Active Directory. This allows Zenoss to not rely on DNS resolution while monitoring, and avoids the overhead of configuring <code>zWinRMServerName</code>.</p>
<code>zWinRMUser</code>	string	The syntax used for <code>zWinRMUser</code> controls whether Zenoss will attempt Windows local authentication or domain (kerberos) authentication. If the value of <code>zWinRMUser</code> is <i>username</i> , local Windows authentication will be used. If <code>zWinRMUser</code> is <i>username@example.com</i> , domain authentication will be used. The <code>zWinKDC</code> and potentially the <code>zWinRMServerName</code> properties become important.
<code>zWinScheme</code>	string	This must be set to either <code>http</code> or <code>https</code> . Default value is <code>http</code> .
<code>zWinTrustedKDC</code>	string	Windows Trusted KDC
<code>zWinTrustedRealm</code>	string	Windows Trusted Realm

## Event configuration properties

To view and edit event configuration properties at the root level:

- 1 From the Navigation menu, select **Events**, and then select **Event Classes**.
- 2 From the drop-down list, select **Configuration Properties**.

To view and override event configuration properties for a specific event class:

- 1 Navigate to that class, and then select **Configuration Properties**.
- 2 Double-click the configuration property that you want to change. The **Edit Config Property** dialog box appears.
- 3 Make your changes and click **Submit**. The presence of **Yes** in the **Is Local** column indicates an overriding value. If you want to later remove the override, select the configuration property and click **Delete Local Copy**.

The following table lists event configuration properties.

**Table 5: Event configuration properties**

Property Name	Property Type	Description
<code>zEventAction</code>	string	Specifies the database table in which an event will be stored. Possible values are: <code>status</code> , <code>history</code> and <code>drop</code> . Default is <code>status</code> , meaning the event will be an “active” event. <code>History</code> sends the event directly

Property Name	Property Type	Description
		to the history table. Drop tells the system to discard the event.
zEventClearClasses	lines	Lists classes that a clear event should clear (in addition to its own class).
zEventSeverity	int	Overrides the severity value of events from this class. Possible values are 5-Critical, 4-Error, 3-Warning, 2-Info, 1-Debug, 0-Clear, and -1-Default.
zFlappingIntervalSeconds	int	Defines the time interval to check for event flapping (changing severity level repeatedly). Default value is 3600 seconds.
zFlappingSeverity	int	Drop-down list to set the severity to check for event flapping. If the severity level on an event changes from this value a certain number of times (zFlappingThreshold) within a certain time range (zFlappingIntervalSeconds) then an event flapping event is generated. Possible values include: 5-Critical, 4-Error, 3-Warning, 2-Info, 1-Debug, and 0-Clear.
zFlappingThreshold	int	Number of times an event severity must flap within an interval. One of the parameters to define in order to generate event flapping events.

## Network configuration properties

To view and edit network configuration properties, from the Navigation menu, select **Infrastructure > Networks**. The Networks page appears, listing networks by IP address.

Figure 72: Networks

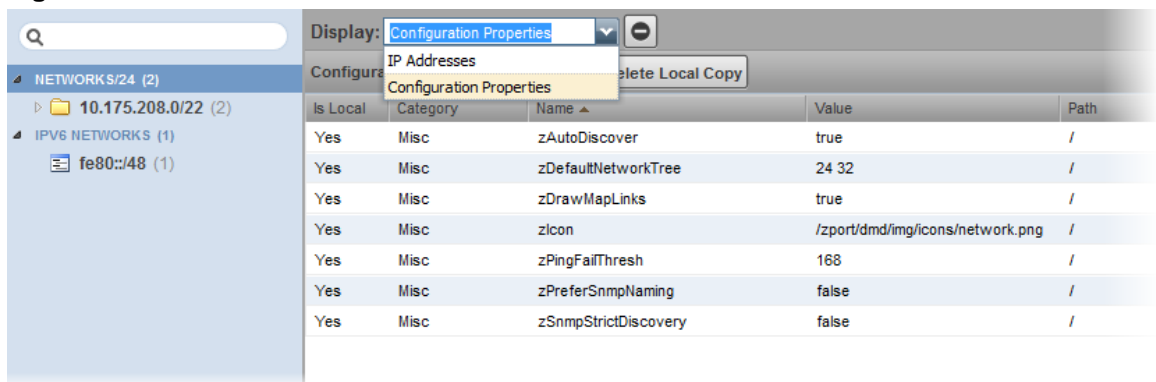

You can view and change network configuration property values and inheritance selections. From the **Display** menu, select **Configuration Properties**.

The following table lists network configuration properties.

**Table 6: Network configuration properties**

Property Name	Property Type	Description
zAutoDiscover	boolean	Specifies whether zendisc should perform auto-discovery on this network. (When performing network discovery, this property specifies whether the system should discover devices and subnetworks on the network.)
zDefaultNetworkTree	lines	A network subnet is automatically created for each modeled device, based on that device's subnet mask setting. To create higher-level subnets automatically from the discovery and modeling processes, add the specific subnet mask breakpoints. For example: 8, 16. If you then model a device with, for example, an IP address of 192.0.2.0, and a subnet mask of 255.255.255.0 (corresponding to a /24 subnet), device discovery will create a 192.0.0.0/8 network containing 192.0.2.0/16, containing 192.0.2.0/24, containing your device.
zDrawMapLinks	boolean	Calculating network links "on the fly" is resource-intensive. If you have a large number of devices that have been assigned locations, then drawing those map links may take a long time. You can use this property to prevent the system from drawing links for specific networks (for example, a local network comprising many devices that you know does not span multiple locations).
zIcon	string	Use to specify device icons that appear on the device status page, Dashboard, and network map.
zPingFailThresh	int	Specifies the number of pings sent without being returned before zendisc removes the device.
zPreferSnmpNaming	boolean	Specifies that when network discovery occurs, it uses the device name comes from SNMP rather than reverse DNS.
zSnmpStrictDiscovery	boolean	Specifies that if SNMP does not exist on the device during network discovery, ignore the device.

## Monitoring templates

---

The system stores performance configuration data in *templates*. Templates contain other objects that define where and how to obtain performance data, thresholds for that data, and data graphs.

You can define a template anywhere in the device class hierarchy, or on an individual device.

Templates are divided among three types:

- Device
- Component
- Interface

### Creating templates

---

You can create a template by overriding an existing template. To override a template:

- 1 Navigate to the template you want to copy.
- 2 From the Action menu, select **Copy/Override Template**. The Copy/Override dialog box appears.
- 3 Select the bound template to override, and then click **Submit**. The copied template appears in the list of templates as locally defined.

### Renaming templates

---

To rename an existing template:

- 1 Select **Advanced > Monitoring Templates**.
- 2 Expand the organizer containing the template to be renamed, and then the class containing the template.
- 3 From the Action menu, select **View and Edit Details**. The Edit Template Details dialog box appears.
- 4 Enter a new name in the Name field.
- 5 Click **Submit**.

### Template binding

---

The determination of which templates apply to what objects is called *binding*. Templates are bound in different ways, depending on the objects to which they are bound.

## Device templates

Device templates are applied to devices, one to each device. The system employs a single rule to bind device templates to devices: the value of the zDeviceTemplates property. For most device classes, this is "Device."

Common device templates are:

- Device
- MySQL
- Apache
- Active Directory
- MExchangeIS
- MSSQLServer
- IIS

For the Server/Linux/MySQL device class, the zDeviceTemplates property might contain, for example, "Device" and "MySQL." The system would collect CPU and memory information by using the Device template, and MySQL-specific metrics by using the MySQL template.

### Binding templates

To bind a device template to a device class or device:

- 1 From the devices list, select a device class or device.
- 2 On the Overview page, select **Bind Templates** from the Action menu. The Bind Templates dialog box appears.

**Figure 73:** Bind Templates

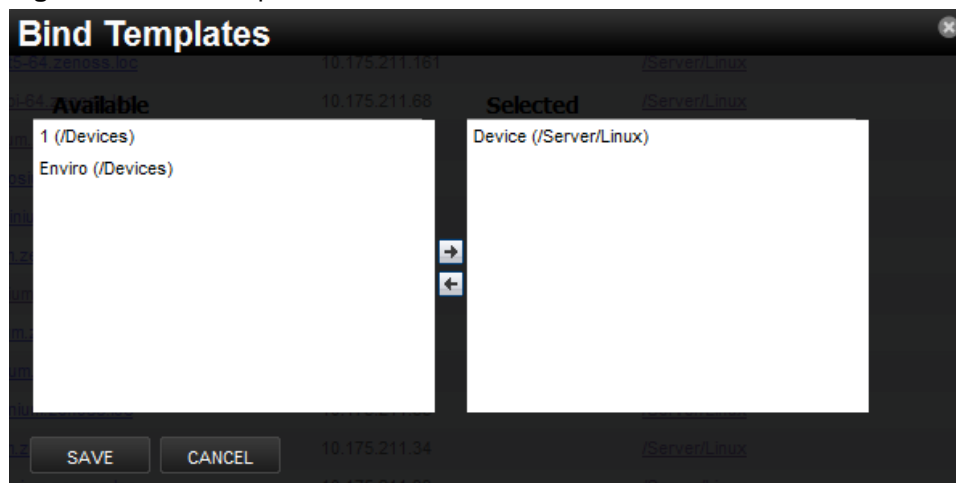

- 3 Move templates between the Available and Selected lists using the arrows.
- 4 Click **Save**.

### Resetting bindings

Resetting template bindings removes all locally bound templates and uses the default template values. To reset bindings for a selected device or device class:

- 1 Select **Reset Bindings** from the Action menu.  
The Reset Template Bindings dialog box appears.
- 2 Click **Reset Bindings** to confirm the action.

## Component templates

Component templates are named exactly according to the name of the underlying class that represents a component. For example, the FileSystem template is applied to file systems. Component templates can be applied multiple times to each device, depending on how many of the device's components match the template. Configuration properties do not control the application of component templates.

---

**Note** Do not manually bind component templates.

---

Common component templates are:

- FileSystem, HardDisk, IPService, OSProcess, WinService
- Fan, PowerSupply, TemperatureSensor
- LTMVirtualServer, VPNTunnel

## Interface templates

Interface templates are applied to network interfaces by using a special type of binding. Instead of using the name of the underlying class, the system looks for a template with the same name as the interface type. You can find this type in the details information for any network interface.

If Resource Manager cannot locate a template that matches the interface type, then it uses the ethernetCsmacd template.

## Example: Defining templates in the device hierarchy

---

You add a new device at /Devices/Server/Linux named Example1Server. You have not edited the value of its zDeviceTemplates property, so it inherits the value of "Device" from the root device class (/Devices). Resource Manager looks to see if there is a template named Device defined on Example1Server itself. There is not, so it checks /Devices/Server/Linux. There is a template named Device defined for that device class, so that template is used for Example1Server. (There also is a template named Device defined at the root level (/Devices), but the system does not use this one because the template at /Devices/Server/Linux overrides it.)

## Example: Applying templates to multiple areas in the device hierarchy

---

You want to perform specific monitoring of servers running a certain Web application, but those servers are spread across several different device classes. You create a template at /Devices called WebApplication with the appropriate data sources, thresholds and graphs. You then append the name "WebApplication" to the zDeviceTemplates configuration property for the devices classes, the individual devices running this Web application, or both.

# Basic monitoring

---

## Availability monitoring

---

The availability monitoring system provides active testing of the IT infrastructure, including:

- Devices
- Network
- Processes
- Services

Availability monitoring is facilitated by:

- **Zenping**- The system's Layer-3 aware, topology-monitoring daemon. Zenping performs high-performance, asynchronous testing of ICMP status. The most important element of this daemon is that Resource Manager has built a complete model of your routing system. If there are gaps in the routing model, the power of Zenping's topology monitoring will not be available. If there are gaps, this issue can be seen in the `zenping.log` file. Zenping uses Nmap to build a ping tree and perform Layer 3 suppression.
- **Zenstatus**- Performs active TCP connection testing of remote daemons.

### zenping correlation

By default, zenping attempts to correlate all zenping instances on the same collector host. If zenping instances are on different physical hosts, they must share the same redis instance. In this case, the setting `--redis-url` which controls what redis instance zenping is talking to needs to be set to point to the same redis instance.

There are other correlation settings to use on the command line that you need to be aware of:

- `--disable-correlator`: This will set the ping correlation value to False and will turn off correlation.
- `--correlation-backend`: Default value is `distributed`, which is the default behavior when using the redis instance. If you set this to `simple`, no communication with redis is available and correlation will only be performed within the same zenping instance.
- `--connected-ip-suppress`: Defaults to disabled. This is used when zenping does not or cannot monitor all the interfaces of routers along a traceroute path. In this case, zenping can use the model information to infer if an IP along the traceroute path belongs to a device (like a router). It will use this information to determine whether the root cause for a ping down is the "connected" device.
- `--delay-count`: Defaults to 0. This means that as soon as a ping down is detected an event is sent. When using distributed ping correlation, zenping instances are not in sync. `--delay-count` can be set to 1 or higher in order to allow zenping instances to share the ping state before sending events. It can also be used

to avoid sending events after N ping downs. For example, you may only want to send an event after 3 ping downs.

## Controlling ping cycle time

Follow these steps to modify the ping cycle time:

- 1 Open Control Center and click your instance of Resource Manager to open the application overview page.
- 2 In the Services section, click **zenping** to open the zenping Overview page.
- 3 In the Configuration Files section, click **Edit** next to the `/opt/zenoss/etc/zenping.conf` file. The Edit Configuration window appears.
- 4 Uncomment the `zenhubpinginterval` line and edit the default value of 30 to your desired ping cycle time.
- 5 Click **Save**.

## Using the predefined /Ping device class

The `/Ping` device class is a configuration for devices that you want to monitor only for availability. The system does not gather performance data for devices placed in this class. You can use the `/Ping` device class as a reference for your own configuration; or, if you have a device that you want to monitor solely for availability, you can place it under this class.

## Monitoring processes

Resource Manager provides process availability monitoring for hosts that support SNMP or SSH access. Process monitoring features include:

- Process classes, defined by Python regular expressions. Classes may generate one or more process sets, each containing one or more process instances.
- Process sets may include process instances running on multiple hosts. This captures related or redundant processes, enabling a more wholistic view of data center services.
- Process set names, to replace the often-cryptic names of process instances with descriptive labels.
- Process set locking, to maintain continuity of data collection if the members of a given process set are not running during modeling.
- A testing dialog, to discover and refine the sets a class generates.

Use the Processes page (**Infrastructure > Processes**) to create and manage process classes and process sets.



Figure 74: Processes page

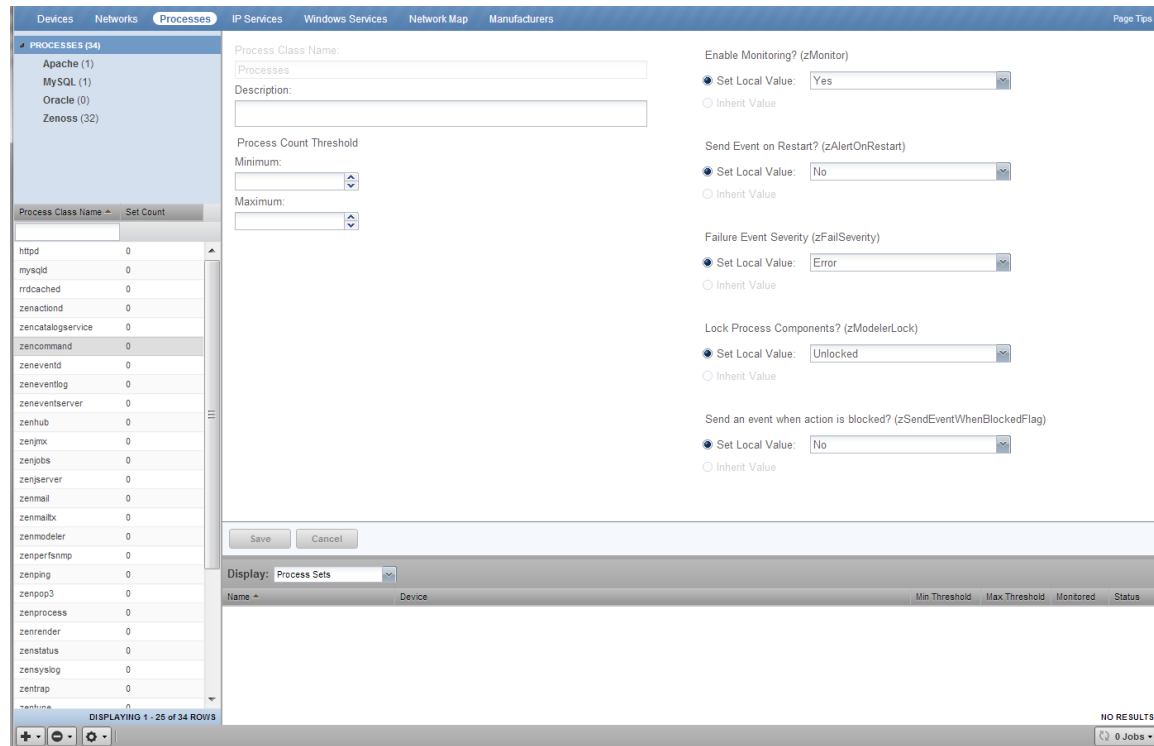

The tree view shows process class organizers (at the top) and the list of process classes in each organizer (the rest of the view). You may filter the list with the active search field, at the top of the list.

### Example: Creating a process class

This section provides an example of using process availability monitoring to create a new process class, for database processes. The database runs on a Linux host, and the following output is a partial list of the results of the `ps axho args` command on the database host. Process monitoring uses the output of that command (or its equivalent) as input for regular expression matching.

```
ora_pmon_orcl ora_psp0_orcl ora_vktm_orcl ora_gen0_orcl ora_diag_orcl
ora_dbrm_orcl ora_dia0_orcl ora_mman_orcl ora_dbw0_orcl ora_lgwr_orcl
ora_ckpt_orcl ora_smon_orcl ora_reco_orcl ora_rmon_orcl ora_rmn1_orcl
ora_d000_orcl ora_s000_orcl ora_s001_orcl ora_s002_orcl ora_s003_orcl
ora_s004_orcl ora_s005_orcl ora_s006_orcl ora_s007_orcl ora_s008_orcl
ora_s009_orcl ora_p000_orcl ora_p001_orcl ora_p002_orcl ora_p003_orcl
ora_p004_orcl ora_qmnc_orcl ora_n000_orcl ora_l000_orcl ora_l001_orcl
ora_l002_orcl ora_l003_orcl
```

The following subsections provide procedures for creating a process class that captures a selection of the preceding process instances in process sets.

#### Test existing process classes

The existing process classes may already capture the process sets you want. Follow these steps to test the existing process classes.

- 1 Log in to the Resource Manager user interface.
- 2 Navigate to **Infrastructure > Processes**.
- 3 In the lower-left corner of the tree view, click the Action menu, and select **Test All Process Classes Regular Expressions**.

Figure 75: Test all process classes dialog

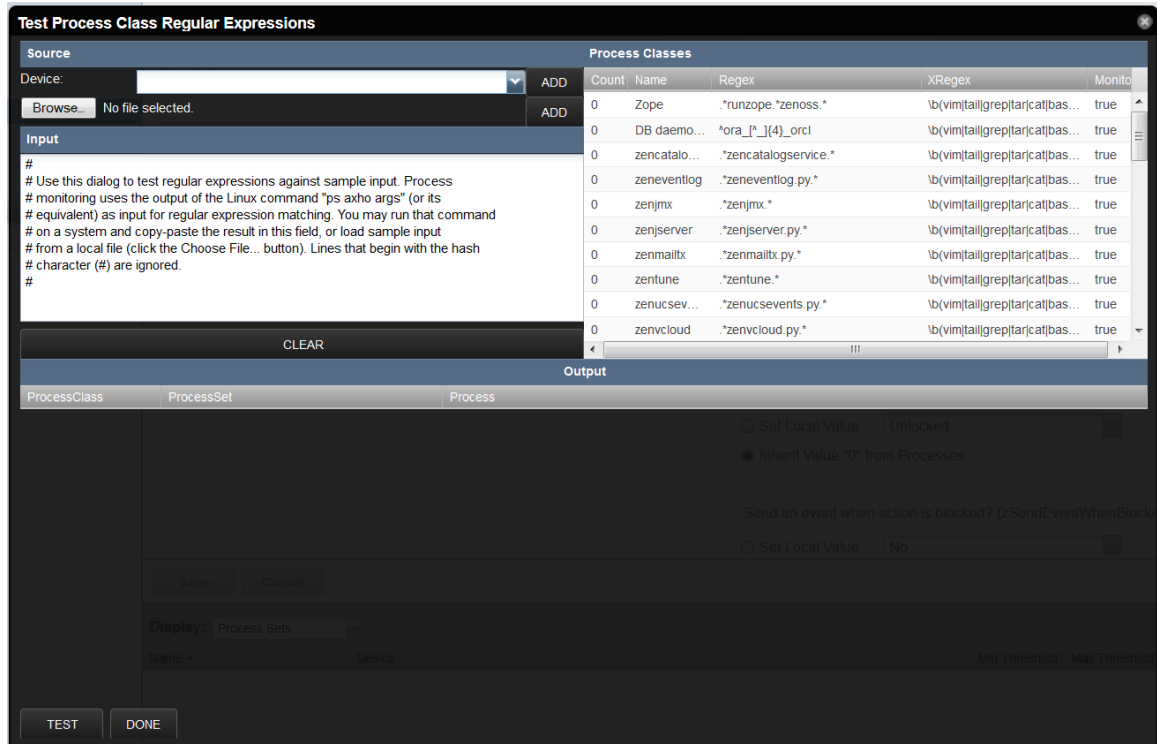

The top-right portion of the dialog box displays all of the process classes, in the order in which they are evaluated.

- 4 Select the process names in the previous section, and copy them into a paste buffer.
- 5 In the **Test Process Class Regular Expressions** dialog, select all of the existing text in the **Input** area, and then paste the process names from the buffer. Alternatively, you may paste the process names into an empty file, save the file on the system from which your browser is launched, and then use the **Choose File** button to insert the process names.
- 6 At the bottom-left corner of the dialog, click **Test**.
- 7 If any process sets are created, they are displayed in the list area, above the **Test** button.

### Create an organizer

Complete the previous section, and then follow these steps to create a process class organizer.

- 1 Log in to the Resource Manager user interface.
- 2 Navigate to **Infrastructure > Processes**.
- 3 In the lower-left corner of the tree view, click the **Add** menu, and select **Add Process Class Organizer**.
- 4 In the **Add Process Class Organizer** dialog, enter `Database`, and then click **Submit**.

### Create a process class

Complete the previous section, and then follow these steps to create a process class.

- 1 At the top of the tree view, double-click **Processes**, the root organizer to open it.
- 2 Select **Database**.
- 3 In the lower-left corner of the tree view, click the **Add** menu, and select **Add Process Class**.
- 4 In the **Add Process Class** dialog, enter `DB daemons`, and then click **Submit**.
- 5 At the top of the tree view, double-click **Processes** to open it, and then select **Database**.

## Define the regular expression series of a process class

Complete the previous section, and then follow these steps to create the series of regular expressions that define a process class, and generate process sets.

- 1 In the list area of the tree view, select **DB daemons**.

**Figure 76:** Process class definition page

Process Class Name:

Description:

Matching Rules (performance metrics will start over if changed)

Include processes like:

Exclude processes like:

Replace command line text:

With:

Process Count Threshold

Minimum:

Maximum:

Enable Monitoring? (zMonitor)

Set Local Value:

Inherit Value "Yes" from Processes

Send Event on Restart? (zAlertOnRestart)

Set Local Value:

Inherit Value "No" from Processes

Failure Event Severity (zFailSeverity)

Set Local Value:

Inherit Value "Error" from Processes

Lock Process Components? (zModelerLock)

Set Local Value:

Inherit Value "0" from Processes

Send an event when action is blocked? (zSendEventWhenBlockedFlag)

Set Local Value:

Inherit Value "No" from Processes

- 2 In the **Description** field, enter `Database daemons`.
- 3 In the **Include processes like** field, replace `DB daemons` with a *Python regular expression* that selects the database processes. For example, `ora_[^_]{4}_orcl`. The example regular expression selects all of the processes in the sample process instance list.
- 4 In the **Exclude processes like** field, enter a regular expression to remove processes from the results of the preceding regular expression. The default entry excludes common user commands. The default entry does not exclude any of the processes in the sample process instance list.
- 5 The next two fields, **Replace command line text** and **With**, work together to simplify the names of process sets.
  - In the **Replace command line text** field, enter a regular expression containing one or more pattern groups.
  - In the **With** field, enter replacement text, along with the sequence number of one or more of the pattern groups defined in the previous field.

For example, to create four pattern groups for database processes, enter the following regular expression in the **Replace command line text** field:

```
^(ora_) ([a-z]) (.{4}) (orcl)
```

To use two of the pattern groups in the replacement text, enter the following text in the **With** field:

```
DB [\4] daemons starting with [\2]
```

Each unique replacement generated by the combination of the text plus the inserted pattern sequences becomes a process set. In the case of this example, pattern group 4 does not vary, but pattern group 2 does. So the number of process sets generated by this class will equal the number of unique alphabetic characters found in the first position after the first underscore.

## 6 Click **Save**.

### Test a process class

Complete the previous section, and then follow these steps to test a single process class.

- 1 In the lower-left corner of the tree view, click the Action menu, and select **Test Process Class Regular Expressions**.

**Figure 77:** Test process class dialog

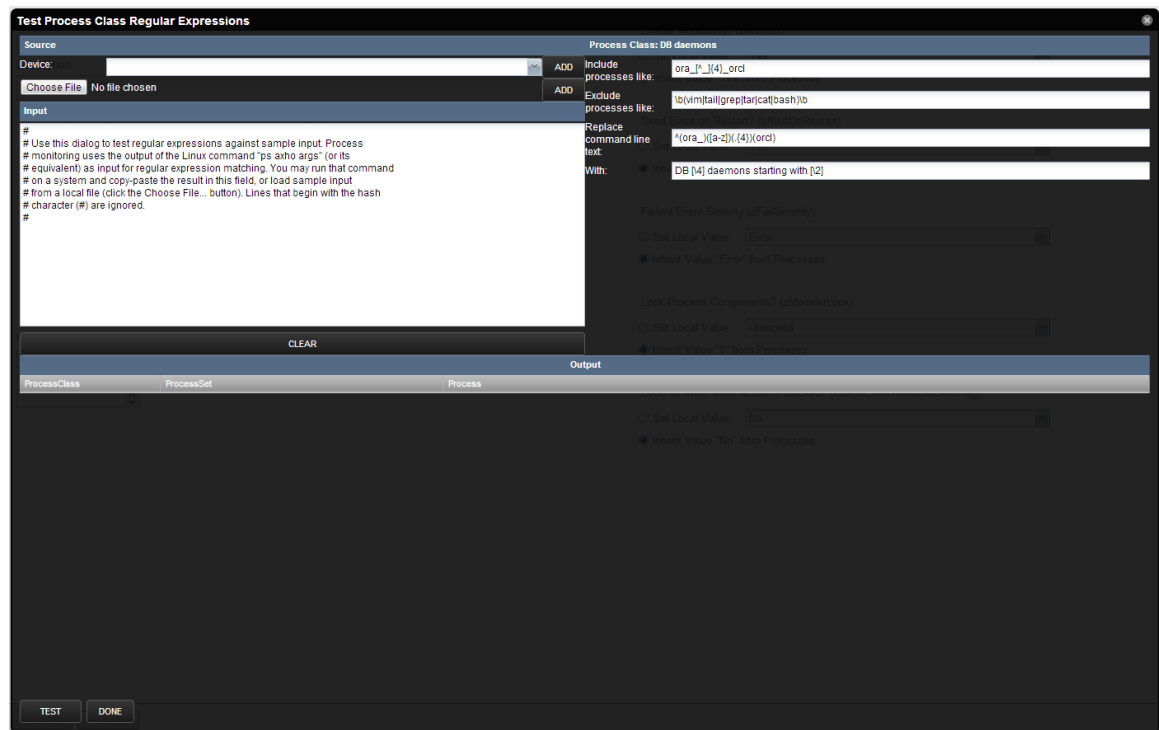

The top-right portion of the dialog box displays the regular expression series that defines this process class.

- 2 Select the process names in the previous section, and copy them into a paste buffer.
- 3 In the **Input** area, select all of the existing text, and then paste the process names from the buffer.
- 4 At the bottom-left corner of the dialog, click **Test**.
- 5 The **Output** area displays each individual match, along with the count of unique process sets. You may refine the regular expressions and retest as often as you like.
- 6 Click **Done**. Changes made to regular expressions in this dialog are copied to the process class definition page. However, the changes are not saved until you click the **Save** button on that page.

### Test and review the process class sequence

The order in which process classes are evaluated is significant. During modeling, each time a process matches a class, the matching process is put into a process set, and then removed from the list of processes that are

passed on to the next class in the sequence. New process classes are inserted into the process class sequence automatically, and may not be in the appropriate position in the sequence.

Complete the previous section, and then follow these steps to test and review the process class sequence.

- 1 In the lower-left corner of the tree view, click the Action menu, and select **Test All Process Classes Regular Expressions**.
- 2 Select the process names in the previous section, and copy them into a paste buffer.
- 3 In the **Input** area, select all of the existing text, and then paste the process names from the buffer.
- 4 At the bottom-left corner of the dialog, click **Test**.
- 5 The number of processes matched and process sets created in this test should be identical to the results of testing the process class alone. If they are not, follow these steps to adjust the process class sequence.
  - a In the **Test Process Class Regular Expressions** dialog, click **Done**.
  - b From the Action menu, select **Change Sequence**.

**Figure 78:** Sequence dialog

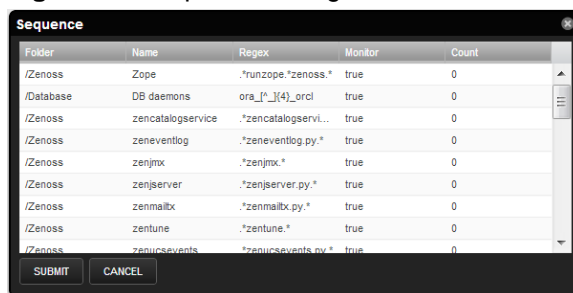

Folder	Name	Regex	Monitor	Count
/Zenoss	Zope	*runzope.*zenoss.*	true	0
/Database	DB daemons	ora_*_[4]_orcl	true	0
/Zenoss	zencatalogservice	*zencatalogservi...	true	0
/Zenoss	zeneventlog	*zeneventlog.py.*	true	0
/Zenoss	zenjmx	*zenjmx.*	true	0
/Zenoss	zenjserver	*zenjserver.py.*	true	0
/Zenoss	zenmailx	*zenmailx.py.*	true	0
/Zenoss	zentune	*zentune.*	true	0
/Zenoss	zenjsevents	*zenjsevents.py.*	true	0

- c Scroll through the list of process classes, and then select the class to move.
  - d Drag the class to an earlier (higher) location in the sequence.
  - e Click **Submit**.
- 6 Re-open the **Test Process Class Regular Expressions** dialog, and re-test the sequence.

### Test the process class on a host

Process sets are created during modeling. To test a process class, choose a device host that is configured for SNMP or SSH access, and model it manually.

---

**Note** For more information about device support for process monitoring, refer to the release notes.

---

Complete the previous section, and then follow these steps to test the process class on a host.

- 1 Navigate to **Infrastructure > Devices**.
- 2 Select a host that is configured for SNMP or SSH access, and is running process that match the new class. For example, the list of processes used in this section is collected from a VirtualBox virtual appliance downloaded from the [Oracle Technology Network](#).
- 3 Open the host's **Overview** page. From the Action menu, select **Model Device**. When modeling completes, the **OS Processes** section of the tree view is updated to include the new process sets.
- 4 Navigate to **Infrastructure > Processes**.
- 5 In the tree view, select the **DB daemons** class.

**Figure 79:** Process class page with process sets

Process Class Name:

Description:

Matching Rules (performance metrics will start over if changed)

Include processes like:

Exclude processes like:

Replace command line text:

With:

Process Count Threshold

Minimum:

Maximum:

Enable Monitoring? (zMonitor)

Set Local Value:

Inherit Value "Yes" from Processes

Send Event on Restart? (zAlertOnRestart)

Set Local Value:

Inherit Value "No" from Processes

Failure Event Severity (zFailSeverity)

Set Local Value:

Inherit Value "Error" from Processes

Lock Process Components? (zModelerLock)

Set Local Value:

Inherit Value "0" from Processes

Send an event when action is blocked? (zSendEventWhenBlockedFlag)

Set Local Value:

Inherit Value "No" from Processes

Display: Process Sets

Name	Device	Min Threshold	Max Threshold	Monitored	Status
DB [orc] daemons starting with [c]	10.87.110.103			true	Up
DB [orc] daemons starting with [d]	10.87.110.103			true	Up
DB [orc] daemons starting with [g]	10.87.110.103			true	Up
DB [orc] daemons starting with [i]	10.87.110.103			true	Up
DB [orc] daemons starting with [l]	10.87.110.103			true	Up
DB [orc] daemons starting with [m]	10.87.110.103			true	Up
DB [orc] daemons starting with [n]	10.87.110.103			true	Up
DB [orc] daemons starting with [p]	10.87.110.103			true	Up
DB [orc] daemons starting with [q]	10.87.110.103			true	Up
DB [orc] daemons starting with [r]	10.87.110.103			true	Up
DB [orc] daemons starting with [s]	10.87.110.103			true	Up
DB [orc] daemons starting with [v]	10.87.110.103			true	Up

DISPLAYING 1 - 13 OF 13 ROWS

The process sets found on the host are displayed in the list at the bottom of the page.

## Process class options

The process class page includes the options described in the following sections.

### Process Count Threshold

You may set minimum and maximum values for the number of process instances included in a process set. The threshold values apply to all of the process sets generated by a class. The minimum and maximum values are inclusive. That is, if the minimum is 3 and the maximum is 5, then 3, 4, and 5 are all valid process instance counts.

You may define a threshold as an exclusive range. If the minimum is 5 and the maximum is 3, then 4 is an invalid process instance count.

### Monitoring Options

- **Enable Monitoring (zMonitor)**

To disable monitoring for all process sets generated by this class, set the local value to No.

- **Send Event on Restart (zAlertOnRestart)**

To send an event when monitoring restarts, set the local value to Yes.

- **Failure Event Severity (zFailSeverity)**

To specify a non-default event severity for the failure of process sets generated by this class, set a local value.

## Process Set Locking

Process sets are generated at modeling time. Since modeling recurs regularly, a given modeling run may result in a missing process set, due to a transient absence of one or more process instances. To prevent this from happening, set the local value of the **Lock Process Components? (zModelerLock)** field to one of the following options.

- **Lock from Deletes**

Prevent deletion of process sets generated by this process class if modeling returns empty sets.

- **Lock from Updates**

Prevent updates to process sets generated by this process class if modeling returns new process sets.

The final option, **Send an event when action is blocked? (zSendEventWhenBlockedFlag)**, is used only when a process set is locked. If you lock the process sets of a class, you may set the local value of this field to Yes, and an event will be created when a process set would have been either deleted or updated during modeling.

## Monitoring IP services

The IP Services page (**Infrastructure > IP Services**) lets you manage and monitor IP services that are running on your network.

**Figure 80: IP Services**

The screenshot shows the IP Services configuration page. On the left, a tree view shows the hierarchy: IP SERVICE (3796) > Privileged (684) > Registered (3069). Below this is a table of service instances:

Name	Port	Count
1ci-smcs	3091	0
3com-amp3	629	0
3com-net-mgmt	2391	0
3Com-nsd	1742	0
3com-tsmux	106	0
3com-webview	2399	0
3comfaxrpc	3446	0
3d-nfsd	2323	0
3ds-lm	1538	0
3i-11	1511	0
3m-image-lm	1550	0

The details form on the right includes:

- Name: IpService
- Description: (empty)
- Enable Monitoring? (zMonitor):
  - Set Local Value: Yes
  - Inherit Value "No" from Services
- Failure Event Severity (zFailSeverity):
  - Set Local Value: Error
  - Inherit Value "Critical" from Services

At the bottom, there are 'Save' and 'Cancel' buttons, a 'Display:' dropdown set to 'Service Instances', and a table header for 'Name', 'Device', 'Monitored', and 'Status'.

The tree view lists all monitored IP services. Filter this list by using the active search area at the top of the view.

The details area shows:

- Service class description
- TCP port

- Associated service keys

To add or change details for a service class, enter or change information, and then click **Save**.

The lower section of the page lists currently running services in this class (by device), and shows their monitoring status. You can also display Configuration Properties by selecting that from the drop-down list.

### Enabling IP service monitoring

You can choose to monitor:

- Individual services
- Service classes

When monitoring a service class, you can choose not to monitor one or more individual services in the class. For example, the SMTP service class is monitored by default, but may not be a critical service on some devices. In this case, you can disable its monitoring on those devices.

---

**Note** If a service is configured to listen only on local host (127.0.0.1), then it is not monitored by default.

---



---

**Note** When adding a new IP service that uses a port value higher than 1024, you need to increase the value of `zIpServiceMapMaxPort` to a number higher than the port you are monitoring.

---

To enable monitoring for a service class or service:

- 1 In the tree view, select the service class or service to monitor.
- 2 Make one or more selections:
  - **Enable Monitoring (zMonitor)** - By default, Inherit Value is selected for all services below the IPService node. When selected, the service class or service will inherit monitoring choices from its parent. If you want to individually enable monitoring choices, select the Set Local Value option, and then select a value.
  - **Failure Event Severity (zFailSeverity)** - By default, Inherit Value is selected for all services below the IPService node. When selected, the service class or service will inherit severity level choices from its parent. If you want to individually select severity levels, select the Set Local Value option, and then select a value.
- 3 Click **Save** to save your choices.

### Using the predefined /Server/Scan device class

The predefined /Server/Scan device class is an example configuration for monitoring TCP services on devices using a port scan. If you have a device that you want to monitor for service availability alone, you can place it under this device class. The system will not collect performance data for devices in this class.

## Monitoring Windows Services

The Windows Services page (**Infrastructure > Windows Services**) has been updated to use the WinService monitoring template.

## Monitoring using ZenCommand

---

Resource Manager has the ability to run Nagios® and Cacti plug-ins through the ZenCommand process. ZenCommand can run plugins locally and remotely by using a native SSH transport. When run, the system tracks the return code of each plug-in and then creates events with plug-in output. Additionally, it can track performance information from a plug-in.

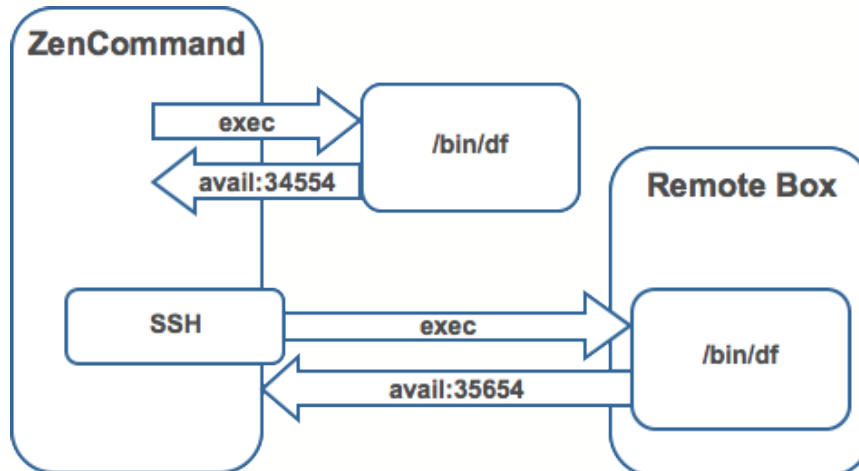

**Figure 81:** Running ZenCommand

## Plugin format for ZenCommands

Nagios® plugins are configured by using a command template.

A template named “Device” will bind to all devices below the template definition. Within each template is a list of commands that will run. The commands can be any program that follows the Nagios® plug-in standard. Inputs are command line arguments; output is the first line of stdout, plus a return code.

**Note** Resource Manager return codes differ from Nagios® return codes, as follows:

Value	Resource Manager	Nagios
0	Clear	OK
1	Data Source	WARNING
2	Data Source+1	CRITICAL
3	Data Source	UNKNOWN

For comprehensive information about Nagios® plugins, refer to the [Nagios Plugin Development Guidelines](#).

A Nagios® command has several fields:

- name – Specifies the name of the command object.
- enabled – Indicates whether this command should be used on a given device.
- component – Specifies the component name to use when zencommand sends events to the system.
- event class – Specifies the event class to use when sending events to the system.
- severity – Sets the default severity to use when sending events to the system.
- cycle time – Sets the frequency a command should be run (in seconds).
- command template – Specifies the command to run.

The command template string is built by using Zope TALES expressions. Several variables are passed when evaluating the template. They are:

- zCommandPath – Path to the zencommand plug-ins on a given box it comes from the configuration property zCommandPath. zCommandPath is automatically added to a command if a path is absent from the beginning of the command.
- devname – Device name of the device against which the command is being evaluated.
- dev – Device object against which the command is being evaluated.

- here – Context of evaluation. For a device, this is equivalent to dev for a component (such as a file system or interface). This is the component object.
- compname – If this command evaluates against a component, specifies its name as a string.
- now – Current time.

Template values are accessed like shell variables. They are the same as the expression syntax used in the appendix titled TALEX Expressions (in this guide).

## Testing ZenCommands

You can test ZenCommand data sources by using the `zetestcommand` shell script.

- 1 Log in to the Control Center host as a user with `serviced` CLI privileges.
- 2 Attach to the `zenhub` service.

```
serviced service attach zenhub
```

- 3 Change to the `zenoss` user.

```
su - zenoss
```

- 4 Run the `zetestcommand` script.

```
zetestcommand -d DeviceID --datasource=DataSourceName
```

where `DeviceID` is the ID of the device on which you want to run the command, and `DataSourceName` is the name of a data source on a template associated with the device.

The `zetestcommand` script prints the results of the command to standard output.

## SNMP monitoring

---

OID represent the data points where the data for the graphs comes from. Sometimes the reason that a graph is not appearing is because the OID for the particular graph is not valid for the device. You can test this validity using the command line to see if you can return a value. To test the validity of an OID data point giving performance data:

- 1 Log in to the Control Center host as a user with `serviced` CLI privileges.
- 2 Attach to the `Zenoss.resmgr` service.

```
serviced service attach Zenoss.resmgr
```

- 3 Change to the `zenoss` user.

```
su - zenoss
```

- 4 Run the `snmpget` command for one of the OIDs

In this case, use the command:

```
$ snmpget -v 2c -cpublic build .1.3.6.1.4.1.2021.4.14.0
```

where, `build` should be a valid server/ip address

If the OID is valid it will return a value.

Here are some basic SNMP commands to gather certain information.

- a** Walk a basic system MIB.

```
snmpwalk -v 2c -cpublic <device_name_or_ip_address> system
```

- b** Walk an interface description

```
snmpwalk -v 2c -cpublic <device_name_or_ip_address> ifDescr
```

- c** Get a single value.

```
snmpget -v 2c -cpublic <device_name_or_ip_address> ifDescr.2
```

- d** Detailed description of an OID value.

```
snmptranslate -Td RFC1213-MIB::ifDescr
```

- e** Convert a name to a raw OID.

```
snmptranslate -On RFC1213-MIB::ifDescr
```

- f** Convert a raw OID to a short name

```
snmptranslate -OS .1.3.6.1.2.1.2.2.1.2
```

## Monitoring devices remotely through SSH

---

You can monitor devices remotely through SSH. Follow the steps in the following sections to set up remote monitoring.

### Changing Resource Manager to monitor devices remotely using SSH

You must edit system properties for the group where you want to collect remote information using SSH.

- 1 Navigate to the device class path you want to monitor remotely. You can apply this monitoring for a device or a device class path.
- 2 Change the configuration properties value for the group. After selecting the device class, click **Details**, and then select **Configuration Properties**. The Configuration Properties page appears.

**Figure 82:** Device class configuration properties

Is Local	Category	Name	Value	Path
	Cisco	zCiscoACEUseSSL	true	/
	Cisco	zCiscoRemoteEventClass/keys		/
	Cisco UCS	zCiscoUCSOMCEventsInterval	60	/
	Cisco UCS	zCiscoUCSOMCPerInterval	300	/
	Cisco UCS	zCiscoUCSManagerPassword	*****	/
	Cisco UCS	zCiscoUCSManagerPort	443	/
	Cisco UCS	zCiscoUCSManagerUseSSL	true	/
	Cisco UCS	zCiscoUCSManagerUser	admin	/
	Modeler Controls	zCollectorClientTimeout	180	/
	Modeler Controls	zCollectorDecoding	utf-8	/
	Misc	zCollectorLogChanges	false	/
	zencommand	zCommandCommandTimeout	15	/
	zencommand	zCommandExistenceTest	test -f %s	/
	zencommand	zCommandLoginTimeout	10	/
	zencommand	zCommandLoginTries	1	/
	zencommand	zCommandPassword		/
	zencommand	zCommandPath	\$ZENHOME/libexec	/
	zencommand	zCommandPort	22	/
	zencommand	zCommandProtocol	ssh	/
	zencommand	zCommandSearchPath		/
	zencommand	zCommandUsername		/
	Control Center	zControlCenterHost	\$(here/managerip)	/

You must make changes to the following configuration properties:

- zCollectorPlugins
- zCommandPassword
- zCommandPath
- zCommandUsername
- zSnmplMonitorIgnore

The following table lists sample values set up for remote devices. These have a pre-shared key (with no password) set up from the collector to the remote boxes. (It also can use password authorization if the password is entered into zCommandPassword.)

Configuration properties	Value
zCollectorPlugins	snmp portscan
zCommandPassword	The SSH password for the remote machine.
zCommandPath	The path to zenplugin.py
zCommandUsername	The SSH user name for the remote machine.
zSnmplMonitorIgnore	True

Two passes are required for full modeling. The first pass obtains the platform type (so that the system knows which plugins to run). The second pass provides detailed data on interfaces and file systems.

- 1 Log in to the Control Center host as a user with serviced CLI privileges.
- 2 Attach to the zenmodeler service.

```
serviced service attach zenmodeler
```

- 3 Change to the zenoss user.

```
su - zenoss
```

- 4 Run the zenmodeler command.

```
$ zenmodeler run -d DeviceName
```

where *DeviceName* is the fully qualified device name.

- 5 Run the zenmodeler command a second time to use the plugins the command gathered on the first pass.

## Using the predefined /Server/Command device class

The /Server/Command device class is an example configuration for modeling and monitoring devices using SSH. The configuration properties have been modified (as described in the previous sections), and device, file system, and Ethernet interface templates that gather data over SSH have been created.

You can use this device class as a reference for your own configuration; or, if you have a device that needs to be modeled or monitored via SSH/Command, you can place it under this device class to use the pre-configured templates and configuration properties. You must set the `zCommandUsername` and `zCommandPassword` properties to the appropriate SSH login information for each device.

## Network map

The network map represents your network's layer 3 topology. From the map, you can quickly determine the status of each device by its highlighted color.

To access the network map, select **INFRASTRUCTURE > Network Map**.

**Figure 83:** Network Map

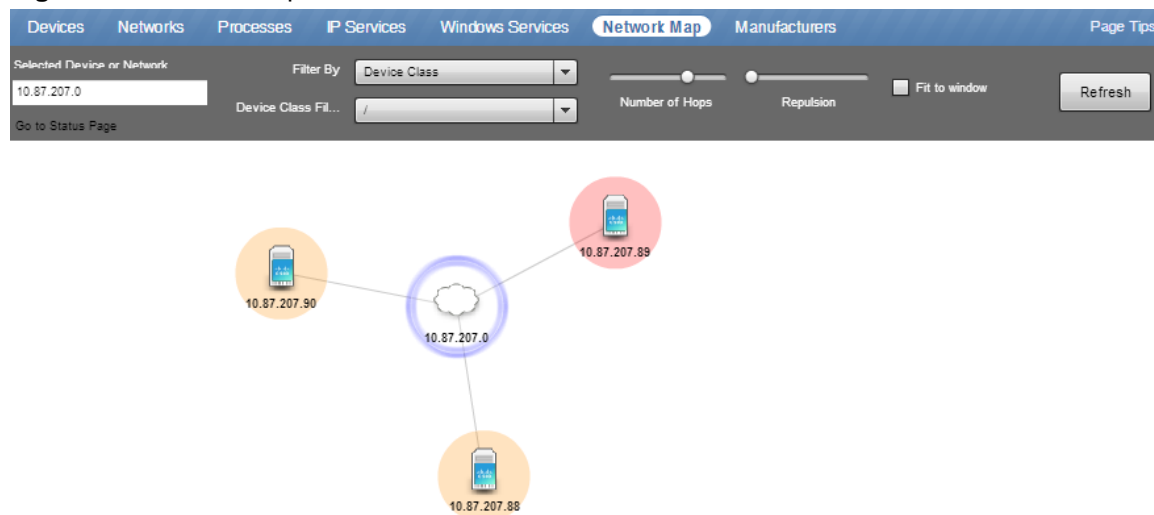

## Choosing the network to display

The network displayed is configured for each user. From user preferences, modify Network Map Start Object to select a network, and then click **Save**.

## Viewing device and network details

Double-click a device or network icon in the map to focus on it. Focusing on a node:

- Centers it on the map
- Shows links from the node, based on the number of hops selected

Alternatively, you can type the name or IP address of a device or network in the Selected Device or Network field, and then click **Refresh** to focus on that node.

To see detailed information about a device or network, select it in the map, and then click **Go to Status Page**.

---

**Note** When you select a node, the network map displays only the links that are currently loaded into the map. It does not download and display new link data.

---

## Loading link data

To load link data for a node:

- 1 Double-click the node on the map to focus on it, or enter the device name or IP address in the Selected Device or Network field.
- 2 Select the number of hops to download and display by sliding the counter.
- 3 Click **Refresh**.

## Filtering by device type

You can filter the devices that appear on the network map. To do this, select a filter from the Device Class Filter list of options. For example, to show only Linux devices on the map, select /Server/Linux from the list of options, then click **Refresh**.

## Adjusting viewable hops

You can adjust the number of hops that appear on the network map. Use the Number of Hops slider, which adjusts the number of hops from 1 to 4.

## Adjusting the network map

Use the Repulsion slider to expand or contract the icons that appear on the map. Move the slider right to expand the icons, or left to contract them.

Select the **Fit to Window** option to bring all displayed icons into the viewable area.

# Performance monitoring

The following image shows how the collector daemons fit into the data collection portion of the Resource Manager architecture.

**Figure 84:** Data collection simplified architecture

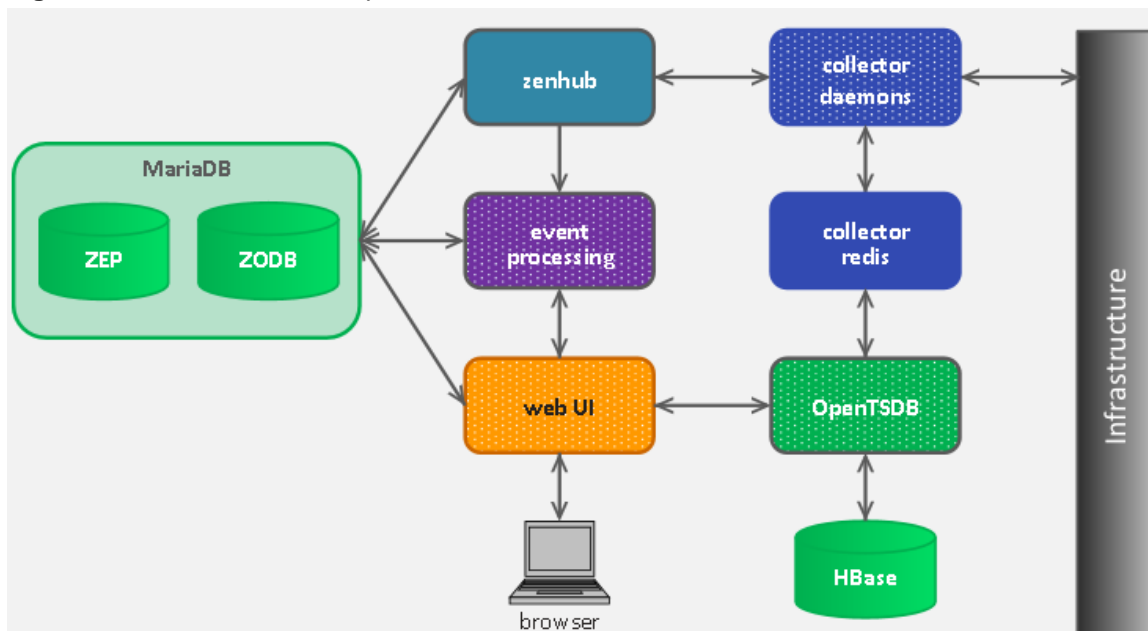

Resource Manager uses the following methods to monitor performance metrics of devices and device components:

- **ZenPerfSNMP**- Collects data through SNMP from any device that is correctly configured for SNMP monitoring.
- **ZenWinPerf**- ZenPack that allows performance monitoring of Windows servers.
- **ZenCommand**- Logs in to devices (by using telnet or ssh) and runs scripts to collect performance data.
- **Other ZenPacks**- Collect additional performance data. Examples include the ZenJMX ZenPack, which collects data from enterprise Java applications, and the HttpMonitor ZenPack, which checks the availability and responsiveness of Web pages.

Regardless of the monitoring method, the system stores performance monitoring configuration information in *monitoring templates*.

## Monitoring templates

Monitoring templates determine how the system collects performance data for devices and device components. You can define monitoring templates for device classes and individual devices.

Templates comprise the following types of objects:

- **Data sources**- Specify the exact data points to collect and the collection method to use.
- **Thresholds**- Define expected bounds for collected data, and specify events to be created if the data does not match those bounds.
- **Graph definitions**- Describe how to graph the collected data on the device or device components.

Before the system can collect performance data for a device or component, it must use the *template binding* process to determine which monitoring templates apply.

## Viewing monitoring templates

From the main navigation menu, choose **Advanced > Monitoring Templates**.

**Figure 85:** Monitoring template for Load Average graph

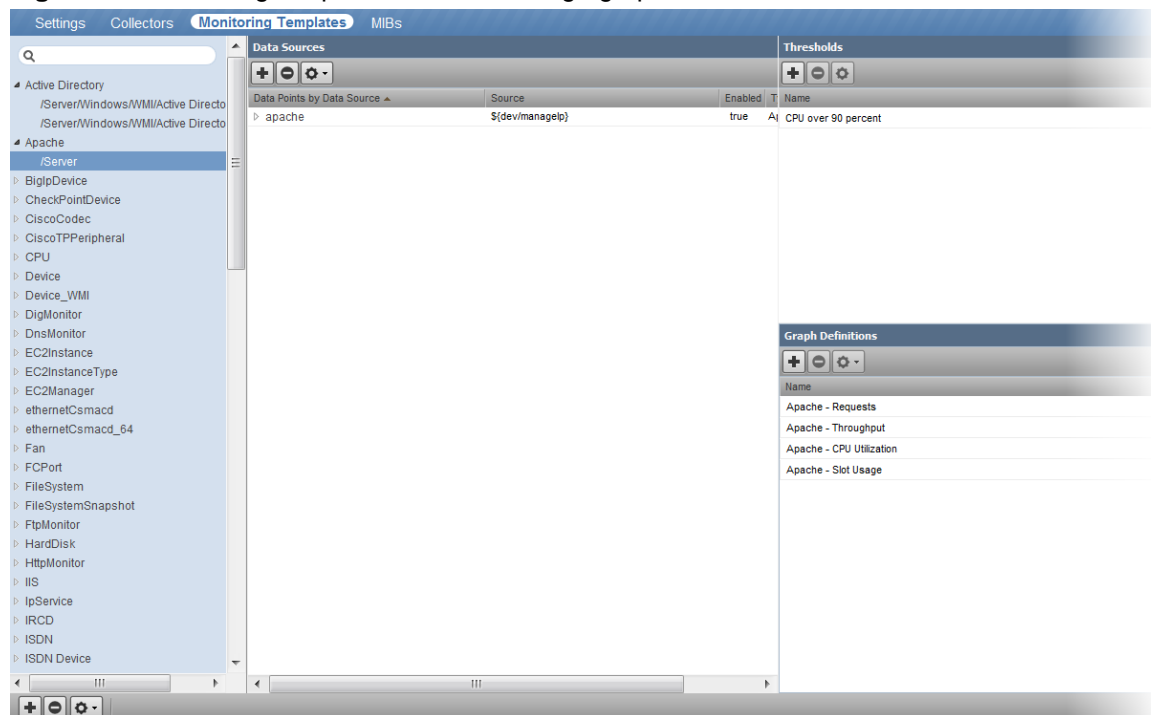

## Template binding

The system determines the list of template names that apply to a device or component.

For device components, the list is defined by the meta type of the component (for example, FileSystem, CPU, or HardDisk). For devices, the list is defined by the `zDeviceTemplates` configuration property.

After defining the list, the system locates templates that match the names on the list. For each name, it searches the device and then searches the device class hierarchy. Resource Manager uses the lowest template in the hierarchy that it can locate with the correct name, ignoring others of the same name that might exist further up the device class hierarchy.



## Editing templates bound to a device

- 1 From the main navigation menu, select **Infrastructure**.
- 2 From the device list in the left pane, choose a device.
- 3 Below the device list, click the context-sensitive actions menu and choose **Bind Templates**.
- 4 In the **Bind Templates** dialog box list of available templates, move one or more templates to the selected list.

**Figure 86:** Bind Templates dialog box

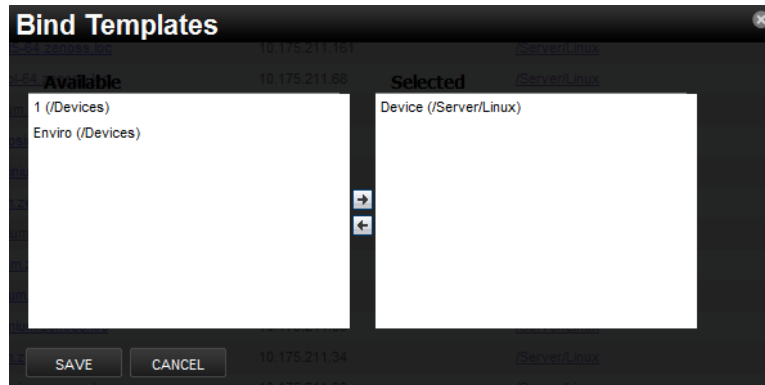

- 5 Click **Save**.  
The templates are bound to the selected device.

## Data sources

Data sources specify which data points to collect and how to collect them. Each monitoring template comprises one or more data sources.

The system provides the following built-in data source types. ZenPacks provide other data source types.

- **SNMP**- Define data to be collected via SNMP by the ZenPerfSNMP daemon. They contain one additional field to specify which SNMP OID to collect. (Many OIDs must end in .0.) Because SNMP data sources specify only one performance metric, they contain a single data point.
- **Command**- Specify data to be collected by a shell command that is executed on the Resource Manager server or on a monitored device. The ZenCommand daemon processes COMMAND data sources. A COMMAND data source can return one or more performance metrics, and usually has one data point for each metric.

Shell commands that are used with COMMAND data sources must return data that conforms to the Nagios plug-in output specification. For more information, see [Monitoring using ZenCommand](#) on page 104.

## Adding a data source

To add a data source to a monitoring template:

- 1 Select **Advanced** from the Navigation menu, and then select **Monitoring Templates**.
- 2 In the tree view, select the monitoring template to which you want to add a data source.
- 3 In the Data Sources area, click the **Add** button. The Add Data Source dialog box appears.
- 4 Enter a name for the data source and select the type, and then click **Submit**. The data source is added to the list in the Data Sources area.
- 5 Double-click the data source in the list. The Edit Data Source dialog box appears. This dialog box will vary based on the type of data source you are editing. For example, the following is the Edit Data Source dialog box for a COMMAND data source.

- 6 Enter or select values to define the data source. In the example of the COMMAND data source, there are a few things to note in particular. Be sure to select the **Use SSH** check box. If you do not select this, the commands will only be run locally on the collector assigned to the device that has the monitoring template bound to it. The **Command Template** field is where you enter command to run. Be aware that any script you enter here is run through TALEs before being run. You may have to escape certain characters. For more information, see [TALES expressions](#) on page 247.

## Data points

Data sources can return data for one or more performance metrics. Each metric retrieved by a data source is represented by a data point.

You can define data points to data sources with all source types except SNMP and VMware. Because these data source types each rely on a single data point for performance metrics, additional data point definition is not needed.

To add a data point to a data source:

- 1 From the Navigation menu, select **Advanced > Monitoring Templates**.
- 2 In the Data Sources area, highlight the row containing a data source.
- 3 Select **Add Data Point** from the Action menu. The Add Data Point dialog box appears.
- 4 Enter a name for the data point, and then click **Submit**.

---

**Note** For COMMAND data points, the name should be the same as that used by the shell command when returning data.

---

- 5 Double-click the newly added data point to edit it. Enter information or make selections to define the data point:
  - **Name**- Displays the name you entered in the Add a New DataPoint dialog.
  - **RRD Type**- Specify the RRD data source type to use for storing data for this data point. Available options are:

- **COUNTER**- Saves the rate of change of the value over a step period. This assumes that the value is always increasing (the difference between the current and the previous value is greater than 0). Traffic counters on a router are an ideal candidate for using COUNTER.
- **GAUGE**- Does not save the rate of change, but saves the actual value. There are no divisions or calculations. To see memory consumption in a server, for example, you might want to select this value.

---

**Note** Rather than COUNTER, you can define a data point using DERIVE and with a minimum of zero. This approach creates the same conditions as COUNTER, with one exception. Because COUNTER is a "smart" data type, it can wrap the data when a maximum number of values is reached in the system. An issue can occur when there is a loss of reporting and the system (when looking at COUNTER values) thinks it should wrap the data. This creates an artificial spike in the system and creates statistical anomalies.

---

- **DERIVE**- Same as COUNTER, but additionally allows negative values. If you want to see the rate of change in free disk space on your server, for example, then you might want to select this value.
  - **ABSOLUTE**- Saves the rate of change, but assumes that the previous value is set to 0. The difference between the current and the previous value is always equal to the current value. Thus, ABSOLUTE stores the current value, divided by the step interval.
  - **Create Command**- Enter an RRD expression used to create the database for this data point. If you do not enter a value, then the system uses a default applicable to most situations.
  - **RRD Minimum**- Enter a value. Any value received that is less than this number is ignored.
  - **RRD Maximum**- Enter a value. Any value received that is greater than this number is ignored.
- 6 Click **Save** to save the defined data point.

## Data point aliases

---

Performance reports pull information from various data points that represent a metric. The report itself knows which data points it requires, and which modifications are needed, if any, to put the data in its proper units and format.

The addition of a data point requires changing the report.

**Figure 87: CPU Utilization Report**

**CPU Utilization Report**

For the Linux data point:  
 Divide the total CPU idle percentage by the number of cores, and subtract from 100.

For the Windows data point:  
 Report the CPU utilization unmodified.

Adding ESX requires adding another rule to fetch it and divide the value by 100, because the utilization is reported on a scale from 0 to 10000.

Device	Utilization
linux.example.com	20%
windows.example.com	34%

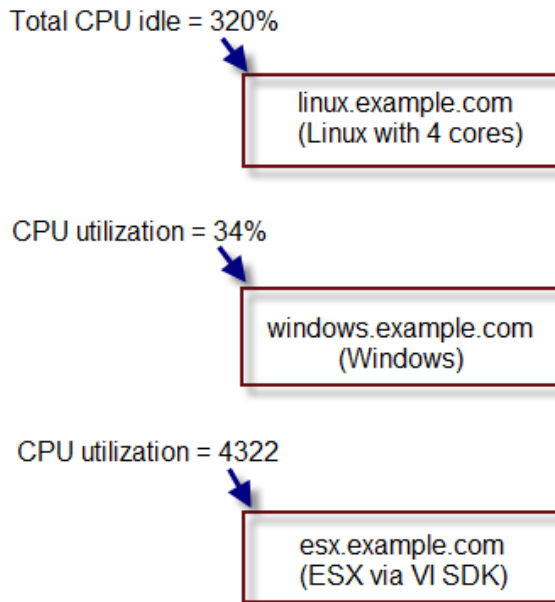

To allow for more flexibility in changes, some reports use *data point aliases*. Data point aliases group data points so they can be more easily used for reporting. In addition, if the data points return data in different units, then the plugin can normalize that data into a common unit.

An alias-based report looks up the data points that share a common alias string, and then uses them. This approach allows you to add data points without changing the report.

**Figure 88: Alias-based CPU Utilization Report**

**CPU Utilization Report (using aliases)**

Get values for all data points with the *cpu\_pct* alias.

Adding ESX to the report is now just a matter of applying the alias *cpu\_pct* with a formula for dividing by 100.

Device	Utilization
linux.example.com	20%
windows.example.com	34%

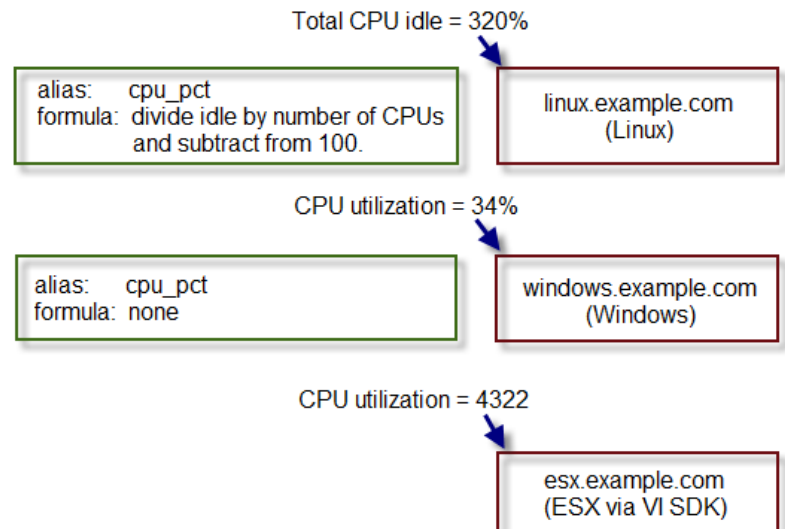

In the simplest cases, data from the target data points are returned in units expected by a report. For cases in which data are not returned in the same units, an alias can use an associated formula at the data point. For example, if a data point returns data in kilobytes, but the report expects data in bytes, then the formula multiplies the value by 1024.

## Alias formula evaluation

The system evaluates the alias formula in three passes.

### Reverse polish notation

When complete, the alias formula must resolve to a Reverse Polish Notation (RPN) formula. For the simple conversion of kilobytes into bytes, the formula is:

```
1024, *
```

For more information about RPN formulas, refer to the [documentation](#).

### Using TALES expressions in alias formulas

For cases in which contextual information is needed, the alias formula can contain a TALES expression that has access to the device as context (labeled as "here"). The result of the TALES evaluation should be an RRD formula.

For example, if the desired value is the data point value divided by total memory, the formula is:

```
${here/hw/totalMemory}, /
```

For more information about TALES, see [TALES expressions](#) on page 247.

### Using Python in alias formulas

You also can embed full Python code in an alias formula for execution. The code must construct a string that results in a valid RRD formula. To signal the system to evaluate the formula correctly, it must begin with:

```
__EVAL:
```

Using the same example as in the previous section (division by total memory), the formula is:

```
__EVAL:here.hw.totalMemory + ", /"
```

## Adding a data point alias

To add an alias to a data point:

- 1 Navigate to a data source on a monitoring template.
- 2 Double-click a data point in the list to edit it. The Edit Data Point dialog appears.
- 3 Enter the alias name and the formula.

---

**Note** If the data point returns values in the preferred units, then leave the Formula value blank.

---

**Figure 89:** Add data point alias

- 4 Click **Save**.

## Reports that use aliases

For information about reports that use aliases, refer to the chapter titled "Reporting."

The following table shows performance reports that use aliases, and the aliases used. To add data points to a report, add the alias, and then ensure the values return in the expected units.

### CPU utilization

Alias	Expected units
loadAverage5min	Processes
cpu_pct	Percent

## Thresholds

Thresholds define expected bounds for data points. When the value returned by a data point violates a threshold, the system creates an event. There are several threshold types available:

- MinMax
- ValueChange
- CiscoStatus
- PredictiveThreshold

There are many thresholds already defined in the system. You can see all the defined thresholds in the Defined Thresholds report which can be accessed on the **REPORTS > Enterprise Reports** menu.

The following sections describe each type of threshold and how to create a new one and edit an existing one.

Additional threshold types may be provided through installed ZenPacks.

### MinMax threshold

MinMax thresholds inspect incoming data to determine whether it exceeds a given maximum or falls below a given minimum. You can use a MinMax threshold to check for these scenarios:

- *The current value is less than a minimum value.* To do this, you should set only a minimum value for the threshold. Any value less than this number results in creation of a threshold event.
- *The current value is greater than a maximum value.* To do this, you should set only a maximum value for the threshold. Any value greater than this number results in creation of a threshold event.
- *The current value is not a single, pre-defined number.* To do this, you should set the minimum and maximum values for the threshold to the same value. This will be the only "good" number. If the returned value is not this number, then a threshold event is created.

- *The current value falls outside a pre-defined range.* To do this, you should set the minimum value to the lowest value within the good range, and the maximum value to the highest value within the good range. If the returned value is less than the minimum, or greater than the maximum, then a threshold event is created.
- *The current value falls within a pre-defined range.* To do this, you should set the minimum value to the highest value within the bad range, and the maximum value to the lowest value within the bad range. If the returned value is greater than the maximum, and less than the minimum, then a threshold event is created.

## ValueChange threshold

ValueChange thresholds inspect incoming data to determine whether a status change has occurred and if so issues an event based on the defined severity.

## CiscoStatus threshold

The CiscoStatus threshold is a special threshold that uses preconfigured maps of numeric values returned by SNMP datasources to Resource Manager event severities. The following is an example OID and its mapped values. For the complete list of supported OIDs and values, refer to the [CiscoStatus Threshold](#) page.

### CISCO-ENTITY-FRU-CONTROL-MIB::cefcModuleOperStatus

- (1) unknown - Critical
- (2) OK - Clear
- (3) disabled - Clear
- (4) OK (diag failed) - Warning
- (5) boot - Warning
- (6) self-test - Warning
- (7) failed - Critical
- (8) missing - Critical
- (9) mismatch w/parent - Critical
- (10) mismatch w/config - Critical
- (11) diag-failed - Critical
- (12) dormant - Critical
- (13) out of service (admin) - Info
- (14) out of service (environ) - Critical
- (15) powered down - Critical
- (16) powered up - Critical
- (17) power denied - Critical
- (18) power cycle - Warning
- (19) OK (power warning) - Warning
- (20) OK (power critical) - Critical
- (21) sync in progress - Clear
- (22) upgrading - Critical
- (23) OK (auth failed) - Critical

## PredictiveThreshold

The predictive threshold allows you to use data from the past to project a value in the future and send an event if the future projected threshold is breached during a pre-defined time period. Resource Manager uses a linear projection algorithm for all projections. For example, you could predict total raw storage capacity of a disk or the bandwidth utilization percentage. Several predictive thresholds are already defined in the system. You can see all the defined thresholds in the Defined Thresholds report which can be accessed on the **REPORTS > Enterprise Reports** menu.

Predictive thresholds are also used for creating a trendline on a graph. You can add the threshold to the management of graph points so that a trendline will be added to the graph.

## Adding thresholds

To define a threshold for a data point:

- 1 From the Navigation menu, select **ADVANCED > Monitoring Templates**.
- 2 Click on the template that contains the data point you want to use in your threshold. The Data Sources window is populated with folders containing all the data points being collected.
- 3 Select the data point by opening the appropriate folder in the data source and clicking on the data point row.
- 4 In the Thresholds area, click the **Add** icon. The Add Threshold dialog box appears.
- 5 Enter a name and select the threshold type, then click **Add**. The threshold name and type is displayed in the Thresholds window.

## Editing MinMax thresholds

The threshold must be created by the Add Threshold functionality or already be defined in the system before you can edit it.

To edit a MinMax threshold:

- 1 Double-click the threshold in the list. The Edit Threshold dialog box appears.



Figure 90: Edit Threshold

**Edit Threshold**

Name: High Utilization Rx

Description:

Type: MinMaxThreshold

Explanation:

Resolution:

DataPoints:

fcErrStats_crcRx		fcStats_bytesRx
fcErrStats_discardRx		
fcErrStats_discardTx		
fcErrStats_linkFailures	↑	
fcErrStats_rx	↑	
fcErrStats_signalLosses	→	
fcErrStats_syncLosses	←	
fcErrStats_tooLongRx	↓	
fcErrStats_tooShortRx	↓	
fcErrStats_tx	↓	
fcStats_bytesTx		
fcStats_packetsRx		
fcStats_packetsTx		

Severity: Warning

Enabled

Minimum Value:

Maximum Value: (here .linkSpeed or 1e10) / 8 \* .9

Event Class: /Perf/Interface

Escalate Count: 0

SAVE CANCEL

2 Enter or select values to define the threshold:

- **Name-** Displays the value for the ID you entered on the Add a New Threshold dialog.
- **Description-** Description of the threshold that you entered on the Add a New Threshold dialog. The description is included in each event that is created from this threshold.
- **Type-** Type of threshold that you selected. You cannot change the type of threshold. If you want a different type of threshold, you need to create a new one and assign the correct type.
- **Explanation-** Information field where a user can enter information about what the event means. This field is included in each event that is created from this threshold
- **Resolution-** Information field where a user can enter information about what to do to resolve the event. This field is included in each event that is created from this threshold.
- **Data Points-** Select one or more data points to which this threshold will apply and click the right-arrow button to move them to the selected column.
- **Severity-** Select the severity level of the first event triggered when this threshold is breached.

- **Enabled**- Select the check box to enable the threshold, or clear the check box to disable it.
- **Minimum Value**- If this field contains a value, then each time one of the select data points falls below this value an event is triggered. This field may contain a number or a Python expression. When using a Python expression, the variable *here* references the device or component for which data is being collected. For example, a 90% threshold might be specified as:

```
(here.linkSpeed or 1e10) /8 * .9
```

The division by 8 is needed because interface speed frequently is reported in bits/second, where the performance data is bytes/second.

- **Maximum Value**- If this field contains a value, then each time one of the selected data points goes above this value an event is triggered. This field may contain a number or a Python expression.
  - **Event Class**- Select the event class of the event that will be triggered when this threshold is breached.
  - **Escalate Count**- Enter the number of consecutive times this threshold can be broken before the event severity is escalated by one step. A value of zero (0) indicates that the severity will not escalate.
- 3 Click **Save** to confirm the edits.

## Editing ValueChange thresholds

The threshold must be created by the Add Threshold functionality or already be defined in the system before you can edit it.

To edit a ValueChange threshold:

- 1 Double-click the threshold in the list. The Edit Threshold dialog box appears.

**Figure 91:** Edit Threshold

- 2 Enter or select values to define the threshold:
  - **Name**- Displays the value for the ID you entered on the Add a New Threshold dialog.
  - **Type**- Type of threshold that you selected. You cannot change the type of threshold. If you want a different type of threshold, you need to create a new one and assign the correct type.

- **Data Points**- Select one or more data points to which this threshold will apply and click the right-arrow button to move them to the selected column. When the data point changes status, an event will be triggered.
  - **Severity**- Select the severity level of the first event triggered when this threshold is breached.
  - **Enabled**- Select the check box to enable the threshold, or clear the check box to disable it.
  - **Event Class**- Select the event class of the event that will be triggered when this threshold is breached.
- 3 Click **Save** to confirm the edits.

## Editing CiscoStatus thresholds

The threshold must be created by the Add Threshold functionality or already be defined in the system before you can edit it.

To edit a ValueChange threshold:

- 1 Double-click the threshold in the list. The Edit Threshold dialog box appears.

**Figure 92:** Edit Threshold

**Edit Threshold**

Name:

Type:

DataPoints:

- cvnVethIfAdditionalState\_cvnVethIfAdditional
- ifHCInBroadcastPkts\_ifHCInBroadcastPkts
- ifHCInMulticastPkts\_ifHCInMulticastPkts
- ifHCInOctets\_ifHCInOctets
- ifHCInUcastPkts\_ifHCInUcastPkts
- ifHCOutBroadcastPkts\_ifHCOutBroadcastPkt
- ifHCOutMulticastPkts\_ifHCOutMulticastPkts
- ifHCOutOctets\_ifHCOutOctets
- ifHCOutUcastPkts\_ifHCOutUcastPkts
- ifInDiscards\_ifInDiscards
- ifInErrors\_ifInErrors
- ifOutDiscards\_ifOutDiscards
- ifOutErrors\_ifOutErrors

ifOperStatus\_ifOperStatus

Severity:

Event Class Key:

Enabled

Event Class:

- 2 Enter or select values to define the threshold:
  - **Name**- Displays the value for the ID you entered on the Add a New Threshold dialog.
  - **Type**- Type of threshold that you selected. You cannot change the type of threshold. If you want a different type of threshold, you need to create a new one and assign the correct type.

- **Data Points**- Select one or more data points to which this threshold will apply and click the right-arrow button to move them to the selected column. When the data point changes status, an event will be triggered.
  - **Severity**- Select the severity level of the first event triggered when this threshold is breached.
  - **Event Class Key**- The event class key from the data point you selected will be shown here.
  - **Enabled**- Select the check box to enable the threshold, or clear the check box to disable it.
  - **Event Class**- Select the event class of the event that will be triggered when this threshold is breached.
- 3 Click **Save** to confirm the edits.

## Editing PredictiveThresholds

The threshold must be created by the Add Threshold functionality or already be defined in the system before you can edit it.

- 1 Double-click the threshold in the list. The Edit Threshold dialog box appears.

**Figure 93:** Edit Threshold

**Edit Threshold**

Name: Projected High Pct Rx

Description:

DataPoint: bandwidthUtilizationPctRx\_bandwidthUtilizationPctF

Event Class: /Capacity

Type: PredictiveThreshold

Enabled

Severity: Info

Aggregate Function: max

Projection Algorithm

Algorithm: linear

Projection Algorithm Parameters:

Alerting

Amount of Data Used in Projection: 10 days

Send an Event if the Threshold is Breached in the Next: 10 days

Minimum Value:

Maximum Value: 90

SAVE CANCEL

- 2 Enter or select values to define the threshold:
- **Name**- Displays the value for the ID you entered on the Add a New Threshold dialog.
  - **Description**- Description of the threshold that you entered on the Add a New Threshold dialog. The description is included in each event that is created from this threshold.
  - **Data Point**- Select the data point to which this threshold will apply.
  - **Event Class**- Select the event class of the event that will be triggered when this threshold is breached.
  - **Type**- Type of threshold that you selected. You cannot change the type of threshold. If you want a different type of threshold, you need to create a new one and assign the correct type.
  - **Enabled**- Select the check box to enable the threshold, or clear the check box to disable it.
  - **Severity**- Select the severity level of the first event triggered when this threshold is breached.

- **Aggregate Function**- The type of function to use when analyzing the past data. For example, do you look at the peak values in the past or average values. The default value is `max`.
- **Algorithm**- Algorithm to use for the projection. Value is `linear`.
- **Projection Algorithm Parameters**- Some algorithms need additional parameters. Enter them as required.
- **Amount of Data Used in Projection**- Set the amount of historical data to be used when calculating the projection.
- **Send an Event if the Threshold is Breached in the Next**- Set the timeframe in days, weeks, or months. If the threshold is breached within this time period in the future, an event will be sent.
- **Minimum Value**- If this field contains a value, then each time one of the select data points falls below this value an event is triggered. This field may contain a number or a Python expression. An expression is required when using gauge or calculated values. When using an expression, the variable *here* references the device or component for which data is being collected. For example, a 90% threshold for interface speed might be specified as:

```
(here.linkSpeed or 1e10) / 8 * .9
```

The division by 8 is needed because interface speed frequently is reported in bits/second, where the performance data is bytes/second.

- **Maximum Value**- If this field contains a value, then each time one of the selected data points goes above this value an event is triggered. This field may contain a number or a Python expression. An expression is required for gauge or calculated values.

- 3 Click **Save** to confirm the edits.

## Adding a trendline to a graph

Trendlines show you the projected utilization of a device or component over a specified range of time. The following procedure is tailored to be performed on a CiscoUCS device. In order to add a trendline to a graph, the threshold that you want to use must already be created in the system.

To add a trendline to an existing graph:

- 1 Navigate to **Infrastructure > Devices**, then select a **CiscoUCS** device. The selected device's overview page appears.
- 2 From the Devices panel, select **Components > Chassis**, and then select a chassis from the Chassis list.
- 3 Change the **Display** drop-down menu to **Templates**.
- 4 To the right of **Graph Definitions**, click **+** to create a new graph.
- 5 In the **Add Graph Definition** dialog, enter a name for the graph.

Alternatively, click the name of an existing graph to add the trendline to that graph.

- 6 Select the new graph, then from the gear icon, select **Manage Graph Points**. The Manage Graph Points dialog box appears.
- 7 Click **+ > Threshold**.

**Figure 94:** Manage Graph Points

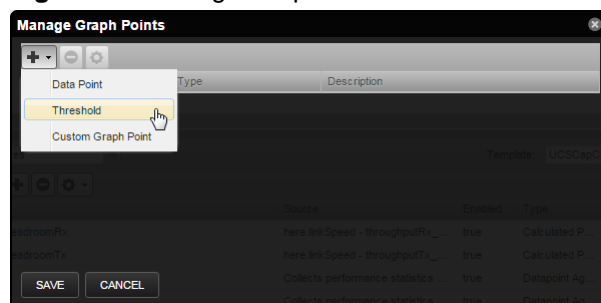

- 8 Select the name of the new predictive threshold and click **Submit**.
- 9 In the **Manage Graph Points** dialog, click **Save**.
- 10 To view the trendline, change the **Display** drop-down menu to **Graphs**.
- 11 Scroll down to the new (or existing graph) to view the newly added trendline.

---

**Note** By default only the last 10 days of data is used in the trendline calculation. There may not be enough data to see the trendline appear on the graph. However, you can view the projected exhaustion dates in the lower right corner.

---

## Performance Graphs

---

You can include any of the data points or thresholds from a monitoring template in a *performance graph*.

Graphs are no longer static images, but are rendered using the NVD3.js JavaScript library.

To define a graph:

- 1 From the navigation menu, select **ADVANCED > Monitoring Templates**.
- 2 In the left column, select the monitoring template in which you want to create a graph.
- 3 In the Graph Definitions area, click the **Add** icon. The Add Graph Definition dialog box appears.
- 4 Enter a name for the graph, and then click **Submit**.
- 5 Double-click the graph name in the list to edit it. Enter information or select values to define the graph:
  - **Name**- Optionally edit the name of the graph you entered in the Add a New Graph dialog. This name appears as the title of the graph.
  - **Height**- Enter the height of the graph, in pixels.
  - **Units**- Enter a label for the graph's vertical axis.
  - **Logarithmic Scale**- Select True to specify that the scale of the vertical axis is logarithmic. Select False (the default) to set the scale to linear. You might want to set the value to True, for example, if the data being graphed grows exponentially. Only positive data can be graphed logarithmically.
  - **Base 1024**- Select True if the data you are graphing is measured in multiples of 1024. By default, this value is False.
  - **Min Y**- Enter the bottom value for the graph's vertical axis.
  - **Max Y**- Enter the top value for the graph's vertical axis.
  - **Description**- Enter a description of the graph.
  - **Has Summary**- Select True (default) to display a summary of the data's current, average, and maximum values at the bottom of the graph.

**Figure 95:** Graph Definition

The screenshot shows a dialog box titled "View and Edit Graph Definition". It contains the following fields and controls:

- Name:** Throughput
- Height:** 500
- Units:** (empty)
- Logarithmic Scale:**
- Base 1024:**
- Min Y:** -1
- Max Y:** -1
- Description:** (empty)
- Has Summary:**

At the bottom of the dialog are two buttons: **SUBMIT** and **CANCEL**.

- 6 Click **Submit** to save the graph.

## Graph points

Graph points represent each data point or threshold that is part of a graph. You can add any number of graph points to a graph definition by adding data points or thresholds.

From the Graph Definitions area of the Monitoring Templates page:

- 1 From the Action menu, select **Manage Graph Points**. The Manage Graph Points dialog box appears.
- 2 From the Add menu, add a data point, threshold, or custom graph point.
- 3 Select values, and then click **Submit**.

---

**Note** Thresholds are always drawn before other graph points.

---

### Re-sequencing graph points

To re-sequence graph points, drag a graph point row in the Manage Graph Points dialog box. (Click-and-drag from an "empty" part of the row.)

### DataPoint graph points

DataPoint graph points draw the value of data points from the template on a graph.

#### Adding DataPoint graph points

To define a DataPoint graph point:

- 1 From the **Add** menu on the Manage Graph Points dialog, select **Data Point**. The Add Data Point dialog box appears.
- 2 Select one or more data points defined in this template. On data point graph point is created for each data point you select from the list.
- 3 Optional: Select the **Include Related Thresholds** option. If selected, then any graph points are created for any thresholds that have been applied to the selected data points as well.
- 4 Click **Submit**.

#### Editing DataPoint graph points

Double-click the name of the graph point to go to its edit page. Enter information or select values to edit the graph point:

- **Name**- This is the name that appears on the Graph Definition page. By default, it appears in the graph legend.
- **Line Type**- Select Line to graph the data as a line. Select Area to fill the area between the line and the horizontal axis with the line color. Select None to use this data point for custom RRD commands and do not want it to be explicitly drawn.
- **Line Width**- Enter the pixel width of the line.
- **Stacked**- If selected, then the line or area is drawn above the previously drawn data. At any point in time on the graph, the value plotted for this data is the sum of the previously drawn data and the value of this data point now. You might set this value, for example, to assess total packets if measuring packets in and packets out.
- **Format**- Specify the RRD format to use when displaying values in the graph summary. For more information about formatting strings, refer to its [documentation](#).
- **RPN**- Optionally enter an RPN expression that alters the value of the data being graphed for the data point. For example, if the data is stored as bits, but you want to graph it as bytes, enter an RPN value of "8,/" to divide by 8. For more information about RPN notation, refer to the [RRDTool RPN tutorial](#).
- **Limit**- Optionally specify a maximum value for the data being graphed.

- **Consolidation**- Specify the RRD function used to graph the data point's data to the size of the graph. Most of the time, the default value of AVERAGE is appropriate.
- **Color**- Optionally specify a color for the line or area. Enter a six-digit hexadecimal color value with an optional two-digit hex value to specify an alpha channel. An alpha channel value is only used if 'stacked' is True.
- **Legend**- Name to use for the data in the graph legend. By default, this is a TALES expression that specifies the graph point name. The variables available in this TALES expression are here (the device or component being graphed) and graphPoint (the graph point itself).
- **Available RRD Variables**- Lists the RRD variables defined in this graph definition. These values can be used in the RPN field.

### Editing threshold graph points

Threshold graph points graph the value of thresholds from the template.

To edit a threshold graph point, double-click it in the list:

You can edit values for Name, Color, and Legend for a threshold graph point. Refer to the definitions in the section titled Editing DataPoint Graph Points for more information.

## Performance data retention

---

Resource Manager stores all performance data (a.k.a., metrics) in HBase using OpenTSDB. The default retention policy saves performance data for 90 days. To change the default, the time to live (TTL) must be adjusted on the OpenTSDB column families in HBase.

---

**Note** TTL is defined in seconds.

---

Once a TTL value is changed, the data retention will adjust on the next major HBase compaction, which by default is once per day.

### Changing the performance data retention time

To change the performance data retention time from the default value of 90 days:

- 1 Log in to the Control Center master host as a user with `sudo` and `docker` privileges.
- 2 Stop the openTSDB writer service.

```
serviced service stop opentsdb/writer
```

- 3 Execute the following command to list all the services and their SERVICEID values. Take note of the SERVICEID for the openTSDB reader service. It will be used as an argument in the following step.

```
serviced service list
```

- 4 Execute the following command, where `$id` is the openTSDB reader SERVICEID and `$ttl` is your TTL value, in seconds.

```
serviced service shell $id /opt/opentsdb/set-opentsdb-table-ttl.sh $ttl
```

- 5 Start the openTSDB writer service.

```
serviced service start opentsdb/writer
```



# Event management

---

Events, and the graphs generated from performance monitoring, are the primary operational tools for understanding the state of your environment.

## Basic event fields

---

To enter the event management system, an event must contain values for the device, severity, and summary fields. Resource Manager rejects events that are missing any of these fields.

Basic event fields are as follows:

- Summary
- Device
- Component
- Severity
- Event Class Key
- Event Class
- Collector

## Device field

The device field is a free-form text field that allows up to 255 characters. Resource Manager accepts any value for this field. If the device field contains an IP address or a hostname, then the system will automatically identify and add the event to the corresponding device.

Resource Manager automatically adds information to incoming events that match a device. Fields added are:

- **prodState** - Specifies the device's current production state.
- **Location** - Specifies the location (if any) to which the device is assigned.
- **DeviceClass** - Classifies the device.
- **DeviceGroups** - Specifies the groups (if any) to which the device is assigned.
- **Systems** - Systems (if any) to which the device is assigned.
- **DevicePriority** - Priority assigned to the device.

For more information about these fields, refer to the following chapters:

- [Production states and maintenance windows](#) on page 154
- [Organizers and path navigation](#) on page 158

## Status field

The Status field defines the current state of an event. This field is often updated after an event has been created. Values for this numeric field are 0-6, defined as follows:

Number	Name	Description
0	New	State given to an event when it is initially created in the system.
1	Acknowledged	State given to an event when a user has acknowledged the event.
2	Suppressed	State given to an event that has been suppressed via an event transform.
3	Closed	State given to an event that was closed as the result of a user action.
4	Cleared	State given to an event that was cleared by a corresponding clear event.
5	Dropped	State given to an event that was dropped via an event transform. These events are never persisted by the system.
6	Aged	State given to an event that was automatically closed by the system according to the severity and last seen time of the event.

## Severity field

The Severity field defines the severity of the event. Values for this numeric field are 0-5, defined as follows:

Number	Name	Color
0	Clear	Green
1	Debug	Grey
2	Info	Blue
3	Warning	Yellow
4	Error	Orange
5	Critical	Red

## Summary and message fields

The summary and message fields are free-form text fields. The summary field allows up to 255 characters. The message field allows up to 4096 characters. These fields usually contain similar data.

The system handles these fields differently, depending on whether one or both are present on an incoming event:

- If only summary is present, then the system copies its contents into message and truncates summary contents to 128 characters.
- If only message is present, then the system copies its contents into summary and truncates summary contents to 128 characters.
- If summary and message are both present, then the system truncates summary contents to 128 characters.

As a result, data loss is possible only if the message or summary content exceeds 65535 characters, or if both fields are present and the summary content exceeds 128 characters.

To ensure that enough detail can be contained within the 128-character summary field limit, avoid reproducing information in the summary that exists on other fields (such as device, component, or severity).

## Other fields

Events include numerous other standard fields. Some control how an event is mapped and correlated; others provide information about the event.

The following table lists additional event fields.

Field	Description
dedupid	Dynamically generated fingerprint that allows the system to perform de-duplication on repeating events that share similar characteristics.
component	Free-form text field (maximum 255 characters) that allows additional context to be given to events (for example, the interface name for an interface threshold event).
eventClass	Name of the event class into which this event has been created or mapped.
eventKey	Free-form text field (maximum 128 characters) that allows another specificity key to be used to drive the de-duplication and auto-clearing correlation process.
eventClassKey	Free-form text field (maximum 128 characters) that is used as the first step in mapping an unknown event into an event class.
eventGroup	Free-form text field (maximum 64 characters) that can be used to group similar types of events. This is primarily an extension point for customization. Currently not used in a standard system.
stateChange	Last time that any information about the event changed.
firstTime	First time that the event occurred.
lastTime	Most recent time that the event occurred.
count	Number of occurrences of the event between the firstTime and lastTime.
prodState	Production state of the device, updated when an event occurs. This value is not changed when a device's production state is changed; it always reflects the state when the event was received by the system.
agent	Typically the name of the daemon that generated the event. For example, an SNMP threshold event will have zenperfsnmp as its agent.
DeviceClass	Device class of the device that the event is related to.
Location	Location of the device that the event is related to.
Systems	Pipe-delimited list of systems that the device is contained within.
DeviceGroups	Pipe-delimited list of systems that the device is contained within.
facility	Only present on events coming from syslog. The syslog facility.
priority	Only present on events coming from syslog. The syslog priority.
nteventid	Only present on events coming from Windows event log. The NT Event ID.
ownerid	Name of the user who acknowledged this event.

Field	Description
clearid	Only present on events in the archive that were auto-cleared. The evid of the event that cleared this one.
DevicePriority	Priority of the device that the event is related to.
eventClassMapping	If this event was matched by one of the configured event class mappings, contains the name of that mapping rule.
monitor	In a distributed setup, contains the name of the collector from which the event originated.

## Details

In addition to the standard fields, the system also allows events to add an arbitrary number of additional name/value pairs to events to give them more context.

## De-duplication

Resource Manager uses an event "de-duplication" feature, based on the concept of an event's fingerprint. Within the system, this fingerprint is the "dedupid." All of the standard events that the system creates as a result of its polling activities are de-duplicated, with no setup required. However, you can apply de-duplicating to events that arrive from other sources, such as syslog, SNMP traps, or a Windows event log.

The most important de-duplication concept is the *fingerprint*. An event's fingerprint (or dedupid) is composed of a pipe-delimited string that contains these event fields:

- device
- component (can be blank)
- eventClass
- eventKey (can be blank)
- severity
- summary (omitted from the dedupid if eventKey is non-blank)

When the component and eventKey fields are blank, a dedupid appears similar to:

```
www.example.com||/Status/Web||4|WebTx check failed
```

When the component and eventKey fields are present, a dedupid appears similar to:

```
router1.example.com|FastEthernet0/1||/Perf/Interface|threshName
```

When a new event is received by the system, the dedupid is constructed. If it matches the dedupid for any active event, the existing event is updated with properties of the new event occurrence and the event's count is incremented by one, and the lastTime field is updated to be the created time of the new event occurrence. If it does not match the dedupid of any active events, then it is inserted into the active event table with a count of 1, and the firstTime and lastTime fields are set to the created time of the new event.

The following illustration depicts a de-duplication scenario in which an identical event occurs three times, followed by one that is different in a single aspect of the dedupid fingerprint.

**Figure 96:** Event de-duplication

	Event	dedupid	count
Warning Threshold	device: router1 eventClass: /Perf/CPU eventKey: cpuThresh severity: 3	router1//Perf/CPUcpuThreshold3	1
Warning Threshold		router1//Perf/CPUcpuThreshold3	2
Warning Threshold		router1//Perf/CPUcpuThreshold3	3
Error Threshold	device: router1 eventClass: /Perf/CPU eventKey: cpuThresh severity: 4	router1//Perf/CPUcpuThreshold4	1

If you want to change the way de-duplication behaves, you can use an event transform to alter one of the fields used to build the dedupid. You also can use a transform to directly modify the dedupid field, for more powerful cross-device event de-duplication.

## Auto-clear correlation

The auto-clearing feature is similar to the de-duplication feature. It also is based on the event's fingerprint. The difference is which event fields make up the fingerprint, and what happens when a new event matches an existing event's fingerprint.

All of the standard events created as a result of polling activities do auto-clearing by themselves. As with de-duplication, you would invoke auto-clearing manually only to handle events that come from other sources, such as syslog, a Windows event log, or SNMP traps.

If a component has been identified for the event, then the auto-clear fingerprint consists of these fields:

- If component UUID exists:
  - component UUID
  - eventClass (including zEventClearClasses from event class configuration properties)
  - eventKey (can be blank)
- If component UUID does not exist:
  - device
  - component (can be blank)
  - eventKey (can be blank)
  - eventClass (including zEventClearClasses from event class configuration properties)

When a new event comes into the system with a special 0 (Clear) severity, Resource Manager checks all active events to see if they match the auto-clear fingerprint of the new event. All active events that match the auto-clear fingerprint are updated with a Cleared state, and the clearid field is set to the UUID of the clear event. After a configurable period of time, all events in a closed state (Closed, Cleared, and Aged) are moved from the active events table to the event archive.

If an event is cleared by the clear event, it is also inserted into the active events table with a status of Closed; otherwise, it is dropped. This is done to prevent extraneous clear messages from filling your events database.

The following illustration depicts a standard ping down event and its associated clear event.

**Figure 97:** Event auto-clear

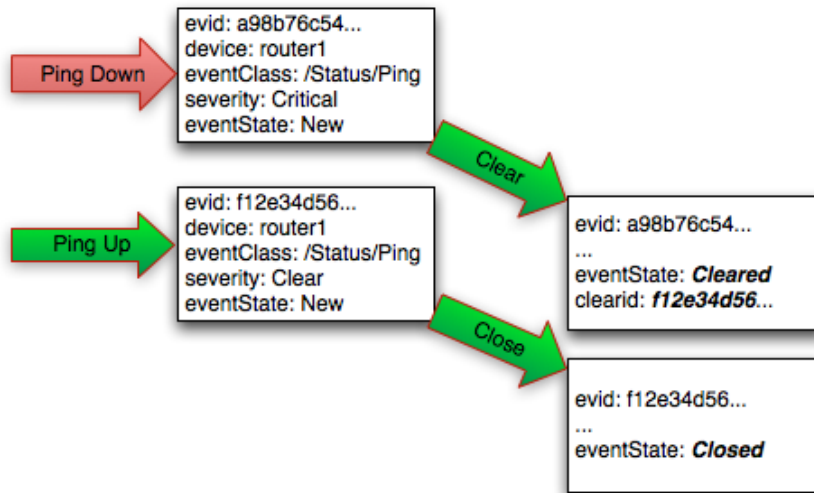

If you need to manually invoke the auto-clearing correlation system, you can use an event transform to make sure that the clear event has the 0 (Clear) severity set. You also need to ensure that the device, component, and eventClass fields match the events you intend to clear.

**Note** To prevent inadvertently clearing a wider range of events than intend, avoid making clear events too generic.

## Event consoles

Resource Manager features multiple event consoles that allow you to view and manage events. Each console shows different events subsets, depending on your current context.

Event consoles are:

- **Master-** To access this console, click Events on the Navigation menu. You can view all events from this console.
- **Contextual-** Contextual event consoles are found throughout the system. Each time you see an Events selection for a device, device organizer, component, or event class, you can view event information that has been automatically filtered to show events specific to the current context.

## Master event console

The master event console is Resource Manager's central nervous system, enabling you to view and manage events. It displays the repository of all events that have been collected.

**Figure 98:** Event Console

Status	Severity	Resource	Component	Event Class	Summary	First Seen	Last Seen	Count
...	...	...	...	...	...	...	...	...
...	...	...	...	...	...	...	...	...
...	...	...	...	...	...	...	...	...
...	...	...	...	...	...	...	...	...
...	...	...	...	...	...	...	...	...

## Customizing the event console

You can add or delete data columns to customize your event console view. The order of the selected column names determines the left-to-right display on the Event Console.

- 1 Navigate to **Events > Event Console**.
- 2 Click the **Configure** button and select **Adjust columns** from the drop-down list.  
The Column Configuration window appears.

**Figure 99:** Event Console Column Configuration

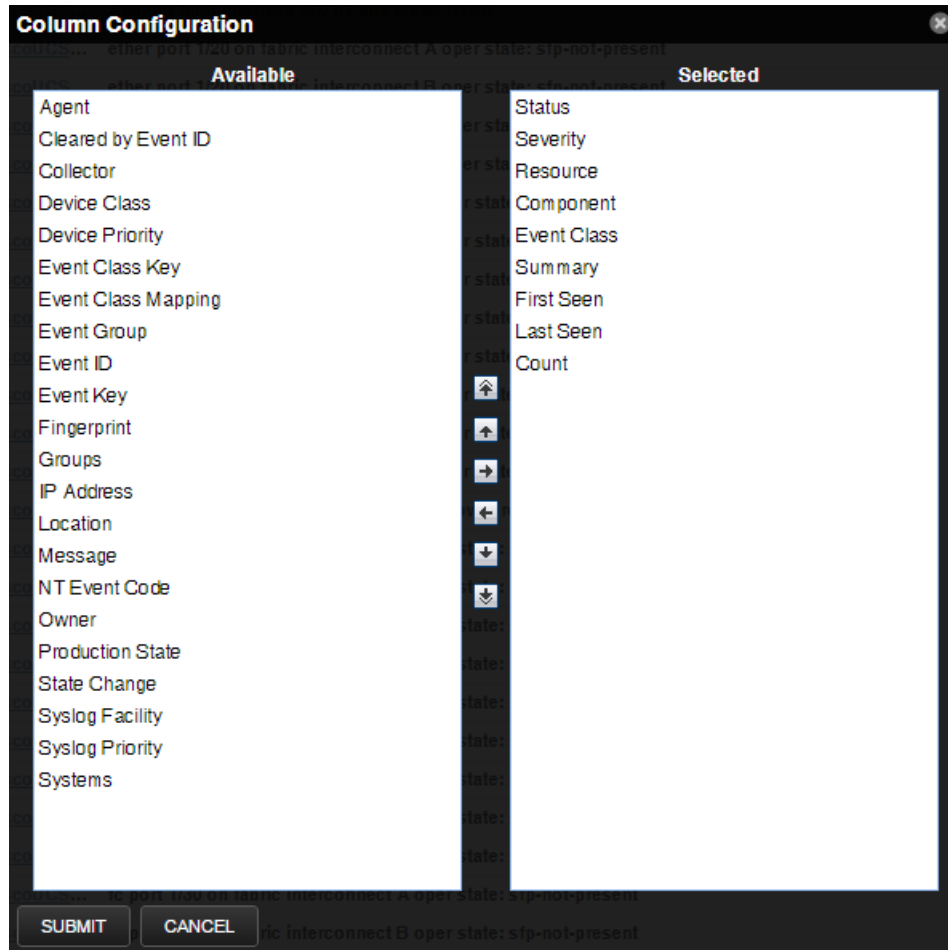

- 3 To select a column, double-click the name in the **Available** list to move it to the **Selected** list.
- 4 In the **Selected** list, to re-order the columns, use the arrow keys.
- 5 Click **Submit**.

## Selecting events

To select one or more events in the event console, you can:

- Click a row to select a single event
- Ctrl-click rows to select multiple events, or Shift-click to select a range of events

## Sorting and filtering events

You can sort and filter events by any column that appears in the master event console.

To sort events, click a column header. Clicking the header toggles between ascending and descending sort order. Alternatively, hover over a column header to display its control, and then select Sort Ascending or Sort Descending.

Filter options appear below each column header.

**Figure 100:** Event Console filter options

The screenshot shows the Zenoss Event Console interface. At the top, there are tabs for 'Event Console', 'Event Archive', 'Event Classes', and 'Triggers'. Below the tabs is a toolbar with icons for refresh, search, and other actions. The main area is a table with columns: Status, Severity, Resource, Component, Event Class, Summary, First Seen, Last Seen, and Count. Each column has a filter dropdown menu. The table contains several rows of event data, including details about fan modules, UCS domains, and fabric interconnects.

Status	Severity	Resource	Component	Event Class	Summary	First Seen	Last Seen	Count
<input checked="" type="checkbox"/>	New	ics1	Fan 3/4/2		Fan 2 in Fan Module 1-4 under chassis 3 speed: lower-non-recoverable	2015-07-29 08:44:33 am	2015-07-29 10:29:40 am	3
<input checked="" type="checkbox"/>	Acknowledged	ics1	extpo1_reg_clients_client...		UCS Domain ucs1-faba is registered with UCS Central without a valid license.	2015-07-29 08:44:33 am	2015-07-29 10:29:40 am	4
<input type="checkbox"/>	Suppressed	ics1	Fan Module 3/4		Fan 2 in Fan Module 1-4 under chassis 3 speed: lower-non-recoverable	2015-07-29 08:45:41 am	2015-07-29 08:45:41 am	1
<input type="checkbox"/>	Closed	ics1	fabric_san_a_phys-fcoes...		FCoE uplink port 1/8 is down	2015-07-29 08:44:33 am	2015-07-29 10:29:40 am	4
<input type="checkbox"/>	Cleared	ics1	Fan 3/4/2		Fan 2 in Fan Module 1-4 under chassis 3 operability: inoperable	2015-07-29 08:44:33 am	2015-07-29 10:29:40 am	3
<input type="checkbox"/>	Aged	ics1	Fabric FC SAN Port Chan...		san port-channel 5 on fabric interconnect A oper state: failed, reason: No operatio...	2015-07-29 08:44:33 am	2015-07-29 10:29:40 am	4
		ics1	Fabric FC SAN Port Chan...		san Member 1/27 of Port-Channel 5 on fabric interconnect A is down, membership...	2015-07-29 08:46:12 am	2015-07-29 10:29:40 am	4

You can filter the events that appear in the list in several ways, depending on the field type. Date fields (such as First Seen and Last Seen) allow you to enter a value or use a date selection tool to limit the list. For other fields, such as Device, Component, and Event Class, enter a match value to limit the list.

The Count field allows you to filter the list when compared to a value. To search on count:

- *N*- Displays events with a count equal to *N*.
- *:N*- displays events with a count less than or equal to *N*.
- *M:N*- Displays events with a count between *M* and *N* (inclusive).
- *M:-* Displays events with a count greater than or equal to *M*.

To clear filters, select **Configure > Clear filters**.

### Working with live search

By default, the system uses a "live search" feature to help you locate information. From the event console, you can search for information by:

- **Device** (name) and **Component** - Device name and Component searches:
  - Are case-insensitive.
  - Are tokenized on whitespace (meaning that any searches that span whitespace and do not start with a complete token will return no results).
  - If quoted, return only exact matches.
- **Summary** - Summary searches:
  - Are case-insensitive.
  - Are tokenized on whitespace (meaning that any searches that span whitespace and do not start with a complete token will return no results).
- **Event class** - Event class searches:
  - Are case-insensitive.
  - Are tokenized on / (slash). If the search begins with a slash, and ends with a slash or asterisk, then event classes are searched by using a "starts with" approach. If a search starts with a slash and ends with any other character, then event classes are searched by using an exact match for the event class. If a search does not begin with a slash, then event classes are searched by using a sub-string match on each event class.
- **IP Address** - IP address searches (for IPv4 and IPv6 values):



- Are tokenized by . (period) and : (colon). For example, the following searches would return a result of 129.168.1.100:
  - 168
  - 168.1
  - 129.16\*
  - \*29
- **Time fields**
  - **First Seen** - This is always the time of the first occurrence of the event and does not change.
  - **Last Seen** - This is the most recent occurrence of the event, and is updated each time the event occurs.
  - **State Change** - This is the time that the event state was modified, most commonly when the event is closed.

Entering a datetime in one of these filters formatted as YYYY-MM-DD HH:MM:SS displays events that have a timestamp that is equal to, or newer than the input datetime. Note that while the input field accepts a 24-hour format, the system displays it in 12-hour format by default (using am/pm).

Additionally you can also configure a time range to display events by using the following format 'start datetime TO end datetime': "YYYY-MM-DD HH:MM:SS TO YYYY-MM-DD HH:MM:SS". An example might look like: "2017-07-21 12:00:00 TO 2017-07-22 12:00:00". This would include all events that the timestamp occurred within a 24 hour period between 12:00:00 on July 21st through 12:00:00 on July 22nd.

With live search enabled (the default behavior), the system filters available information immediately. It presents increasingly refined information with each character you type in the search window. When disabled, search responds only after you enter one or more characters and then press Enter.

### Saving an event console view

Save a custom event console view by bookmarking it for quick access.

- 1 Select **Configure > Save this configuration**.
- 2 In the dialog box, select the link, and then drag it to the bookmarks area of the browser window.

**Figure 101:** Saving a custom view (bookmark)

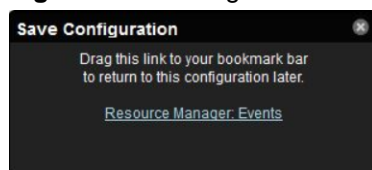

The browser adds a link to the bookmarks list.

- 3 Change the title of the bookmark to distinguish this event console view.

### Refreshing the view

You can refresh the list of events manually or specify that they refresh automatically. To manually refresh the view, click **Refresh**. You can manually refresh at any time, even if you have an automatic refresh interval specified.

To set up automatic refresh, select one of the time increments from the Refresh list.

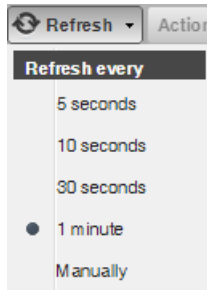
**Figure 102:** Automatic refresh selections

### Viewing event details

You can view details for any event in the system.

- 1 To view details, double-click an event row.

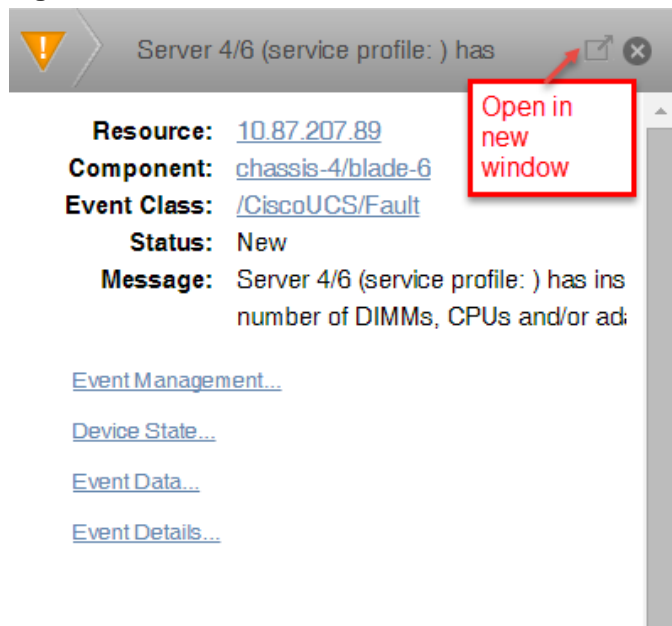
**Figure 103:** Event details

- 2 To display the event information in a new window, click the pop-out icon.
- 3 To see more information about the event, click the link for **Event Management**, **Device State**, **Event Data**, or **Event Details**.
- 4 In the log area, enter information about the event, and then click **Add**.

### Acknowledging events

You may want to mark an event as "acknowledged" to indicate, for example, that you have taken action to remedy a problem. To mark events as acknowledged:

- 1 Select one or more events in the event console view.
- 2 Click the **Acknowledge Events** icon. A check mark appears for each acknowledged event.

### Returning events to new status

Returning a previously acknowledged event to "new" status revokes its "acknowledged" status.

- 1 Select one or more events in the event console view.

- 2 Click the **Unacknowledge Events** icon. A check mark no longer appears in the event row, and the event is returned to "new" status.

### Classifying events

Classifying events lets you associate events shown as /Unknown with a specific event class. To classify an unknown event, an event class key must be specified for the event.

- 1 Select one or more /Unknown events in the event console view.  
You can also classify events from the event archive.
- 2 Click the **Reclassify an Event** icon. The Classify Events dialog appears.
- 3 Select an event class from the list of options, and then click **Submit**.

### Closing events

When you no longer want to actively monitor an event (after you acknowledge it, for example), you can specify to close the event and move it to the event archive according to a configured event archive interval. To do this:

- 1 Select one or more events in the event console view.
- 2 Click the **Close Events** icon.  
The selected events are closed and moved to the archive at the specified interval.

To view events in the event archive, select **EVENTS > Event Archive**.

---

**Note** Users with no assigned role can view all events in the archive.

---

- 3 Click the **Refresh** icon to update the event list.  
The closed events are removed from the display in the event console view.

### Reopening events

You can reopen events in the active event console that are in the Closed, Cleared, or Aged state.

You cannot re-open a closed event if another active event with the same fingerprint exists. Before you can re-open the closed event, you must close the new event.

- 1 Select one or more Closed, Cleared, or Aged events.
- 2 Click the **Reopen Events** icon. The selected events are returned to active status.

### Exporting event data

You can export data from the event console to a comma-separated value (.csv) or XML file. You can select individual events (to export only those events), or make no selections (to export all events that match the current filter criteria).

- 1 Select one or more events.
- 2 Select **Export > CSV** or **Export > XML**. By default, the exported file is named `events.Extension`.

## Creating events

To create events from the event console, click the **Add an Event** icon.

For more information about manual event creation, see [Creating events manually](#) on page 140.

## Event sources

---

Events enter the system as follows:

- *Generated events* are created as a result of active polling.
- *Captured events* are transmitted by external actions into the system.

## Generated events

The following standard daemons are responsible for generating events. They automatically perform appropriate de-duplication and auto-clearing.

- **zenping** - Ping up/down events
- **zenstatus** - TCP port up/down events
- **zenperfsnmp** - SNMP agent up/down events, threshold events
- **zencommand** - Generic status events, threshold events
- **zenprocess** - Process up/down events, threshold events
- **zenwin** - Windows service up/down events

## Captured events

Captured events are those events that the system does not specifically know will occur in advance. De-duplication is performed on these events, but might require tuning. By default, no auto-clearing is done on captured events. Event transforms must be used to create the auto-clear correlations.

The following standard daemons are responsible for collecting captured events:

- **zensyslog**- Events created from syslog messages.
- **zentrap**- Events created from SNMP traps and informs.

ZenPacks that you install might include their own daemons.

## Creating events manually

---

You can manually create events. Though not required for normal system operation, creating events is useful when you have created mappings and transforms and need to test them.

### Creating events in the browser interface

- 1 Navigate to **Events**, and then click the **Add an Event** icon.
- 2 In the **Create Event** dialog box, complete the event fields, and then click **SUBMIT**.

**Figure 104:** Create Event dialog box

Required fields: Summary, Device, Severity, and Collector.

Event class mappings are applied only for events that do not already have an event class.

## Creating events from the command line interface

To send events from the command line, use the `zensendevent` command.

Common options include:

- `-d DEVICE, --device=DEVICE`
- `-i IPADDRESS, --ipAddress=IPADDRESS`
- `-y EVENTKEY, --eventkey=EVENTKEY`
- `-p COMPONENT, --component=COMPONENT`
- `-k EVENTCLASSKEY, --eventclasskey=EVENTCLASSKEY`
- `-o OTHER, --other=OTHER`
- `-s SEVERITY, --severity=SEVERITY`
- `-c EVENTCLASS, --eventclass=EVENTCLASS`
- `-f INPUT_FILE, --file=INPUT_FILE`

1 Log in to the Control Center host as a user with serviced CLI privileges.

2 Attach to the zenhub service.

```
serviced service attach zenhub
```

3 Change to the `zenoss` user.

```
su - zenoss
```

4 Run the `zensendevent` command.

```
zensendevent Options "Event_Summary_Text"
```

### Example: Simulate a ping down event

The following example shows how to use the `zensendevent` script to simulate a ping down event:

```
zensendevent -d router1.example.com -s Critical -c /Status/Ping "Router down"
```

## Event classes

---

*Event classes* are a simple organizational structure for the different types of events that the system generates and receives. This organization is useful for driving alerting and reporting. You can, for example, create an alerting rule that sends you an email or pages you when the availability of a Web site or page is affected by filtering on the `/Status/Web` event class.

Following is a subset of the default event classes. You can create additional event classes as needed.

- `/Status` - Used for events affecting availability.
  - `/Status/Ping` - Ping up/down events
  - `/Status/Snmp` - SNMP up/down events
  - `/Status/Web` - Web site or page up/down events
- `/Perf` - Used for performance threshold events.
  - `/Perf/CPU` - CPU utilization events

- /Perf/Memory - Memory utilization or paging events
- /Perf/Interface - Network interface utilization events
- /Perf/Filesystem - File system usage events
- /App - Application-related events.
- /Change - Events created when the system finds changes in your environment.

## Event class configuration properties

Just as device classes and devices have configuration properties, so do event classes and event class mappings. Configuration properties are applied hierarchically, with the most specific property being applied.

The following configuration properties are available on event classes and class mappings.

- **zEventAction**- How and where affected events are stored when they occur.
  - **status**- Active events table with original event state
  - **history**- Active events table with closed event state
  - **drop**- Events are not stored
- **zEventClearClasses**- Optional list of event class names whose active events will be cleared by clear events occurring in this class.
- **zEventSeverity**- The severity of affected events is changed to this value unless the Default value (-1) is used.
- **zFlappingIntervalSeconds**- Defines the time interval to check for event flapping (changing severity level repeatedly). Default value is 3600 seconds.
- **zFlappingSeverity**- Define the severity to check for event flapping. If the severity level on an event changes from this value a certain number of times (zFlappingThreshold) within a certain time range (zFlappingIntervalSeconds) then an event flapping event is generated. Possible values include: 5-Critical, 4-Error, 3-Warning, 2-Info, 1-Debug, and 0-Clear.
- **zFlappingThreshold**- Number of times an event severity must flap within an interval. One of the parameters to define in order to generate event flapping events.

A good example of how the system uses the event class configuration properties is found in the /Status event class. Within the /Status event class' configuration properties, zEventAction is set to "history" and zEventSeverity is set to "Default". This means that events sent with this event class are sent into the active events table with an initial state of closed, and the event severity unchanged.

For more information about event manipulation techniques, see [Mapping and transformation](#) on page 142.

## Mapping and transformation

---

The event mapping and transformation system allows you to perform a wide range of operations, from altering the severity of certain events to altering nearly every field on an event, based on complex rules.

You cannot alter the following fields through event transformation. (This is because they are set after transformation has been performed.)

- evid
- firstTime
- lastTime
- count

The following illustration shows the path followed by an incoming event in the event mapping system.

Figure 105: Event processing

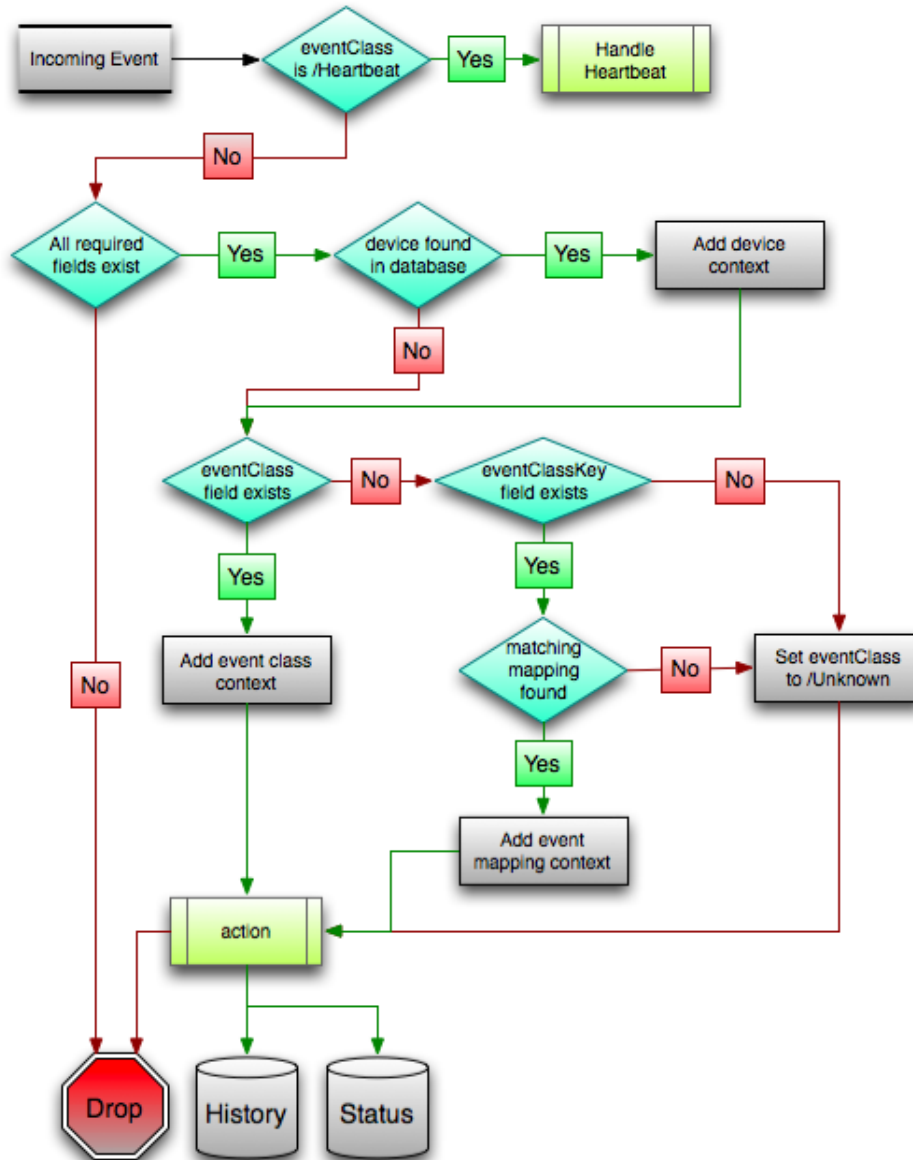

The mapping and transformation process begins with the "eventClass field exists" decision. This also is one of the more important differentiators in how you must handle a particular type of event.

## Event class mappings

To view event class mappings, select **EVENTS > Event Classes**, and then select **Mapping Instances** in the drop-down list. This allows you to see all event class mappings in a single location. The ID column shows the mapping's event class.

You can create event class mappings directly from the event classes, but this requires that you know the event class key. A simpler way to create event class mappings is through the event console:

- 1 Select an event that you want to match in the event console.
- 2 Click the **Reclassify an Event** icon. The Classify Events dialog appears.

- 3 Select the event class to which you want to map the event, and then click **Submit**. This creates the event class mapping with the correct event class key, and example text against which you can develop your regular expression.

When editing an event class mapping, you can control which events it will match, as well as other properties:

- **Matching tab**

- **Event Class Key**- Must match the incoming event's Event Class Key field for this mapping to be considered as a match for events.
- **Rule**- Provides a programmatic secondary match requirement. It takes a Python expression. If the expression evaluates to True for an event, this mapping is applied.
- **Regex**- The regular expression match is used only in cases where the rule property is blank. It takes a Perl Compatible Regular Expression (PCRE). If the regex matches an event's message field, then this mapping is applied.
- **Explanation**- Free-form text field that can be used to add an explanation field to any event that matches this mapping.
- **Resolution**- Free-form text field that can be used to add a resolution field to any event that matches this mapping.
- **Transforms tab**- Takes Python code that will be executed on the event only if it matches this mapping. For more details on transforms, see the section titled "Event Class Transform."
- **Configuration Properties tab**- Listing of Configuration Properties defined for this event class.
- **Sequence tab**- Sequence number of this mapping. This number determines the order in which mappings with the same event class key are evaluated.

Mappings have the same configuration properties as event classes. Any configuration property set locally on a mapping will override the same property set on the event class. This works in the same hierarchical, most specific match, concept that device class and device configuration properties work.

When a captured event occurs, it will not have a pre-defined event class. For this type of event, you must create an event class mapping if you want to affect the event. If a captured event occurs and none of the event class mappings in the system match it, its event class will be set to `/Unknown`, and it will retain all of the default properties with which it began.

The next step of evaluation for events without an event class is to check the Event Class Key field. This controls which event class mapping the event will match. If the event has a blank event class key, or its event class key does not match any event class mappings in the system, the special "defaultmapping" event class key is searched for instead. This provides for a way to map events even if they have a blank or unpredictable event class key.

## Event class mapping sequence

The sequence area of an event class mapping (select Sequence in the left panel) allows you to provide more than one mapping for the same event class key. In this case, the sequence is evaluated in ascending order until a full (rule or regex) match is found.

For example, suppose a router is sending in unclassified events that need to be mapped to two event classes:

- `/Events/Router/fanDown`
- `/Events/Router/fanUnknown`

The event class key for both has been sent to "router", but one has a message of "Fan Down" and the other has no message at all. The mapping on `/Events/Router/fanDown` has an event class key of "router" and a regex of "Fan Down." The mapping on `/Events/Router/fanUnknown` has only an event class key of "router" and (in this example) no regex. Because the fanUnknown mapping matches the fanDown events, the evaluation of fanDown needs to occur first.



You can modify the evaluation of mappings with the same event class key in the Sequence area of any of those event class mappings. In the previous example, you could go to either mapping, select Sequence, and both mappings would be displayed. You can set one to 0, and the other to 1. (You can enter other values, but they will be changed to the shortest list of integers, starting with 0.) Setting `fanDown` to 0 and `fanUnknown` to 1 will ensure that the events will be mapped properly.

## Event class transform

When a generated event occurs, it has an event class assigned to it. This causes the event class mapping step to be skipped. The only way to affect the fields of one of these events is through the event class' configuration properties and transform.

To access the transform for an event class:

- 1 Navigate to the event class from **Events > Event Classes**.
- 2 From the drop-down list, select **Transforms**.
- 3 Enter information into the dialog box (as Python code), and then click the **Save** button in the upper-right corner. As you develop your transform, you can revert back to the last saved state by clicking the **Revert this Transform** button.

The objects available in this Python context are `evt` (the event); and, if the event matches a device that exists in the system database, a `device` object.

The following example shows how you can validate that a device object exists before using it to drop events from a particular location.

```
if device and "Hawaii" in device.getLocationName(): evt._action = "drop"
```

## Event life cycle

---

In addition to manual methods for getting events into the status table or event archive, there are automated processes that move events from status into the archive. The *event life cycle* is defined as all of the ways that events can be added to, moved in, and deleted from the database.

The following illustration depicts the event life cycle.

Figure 106: Event life cycle

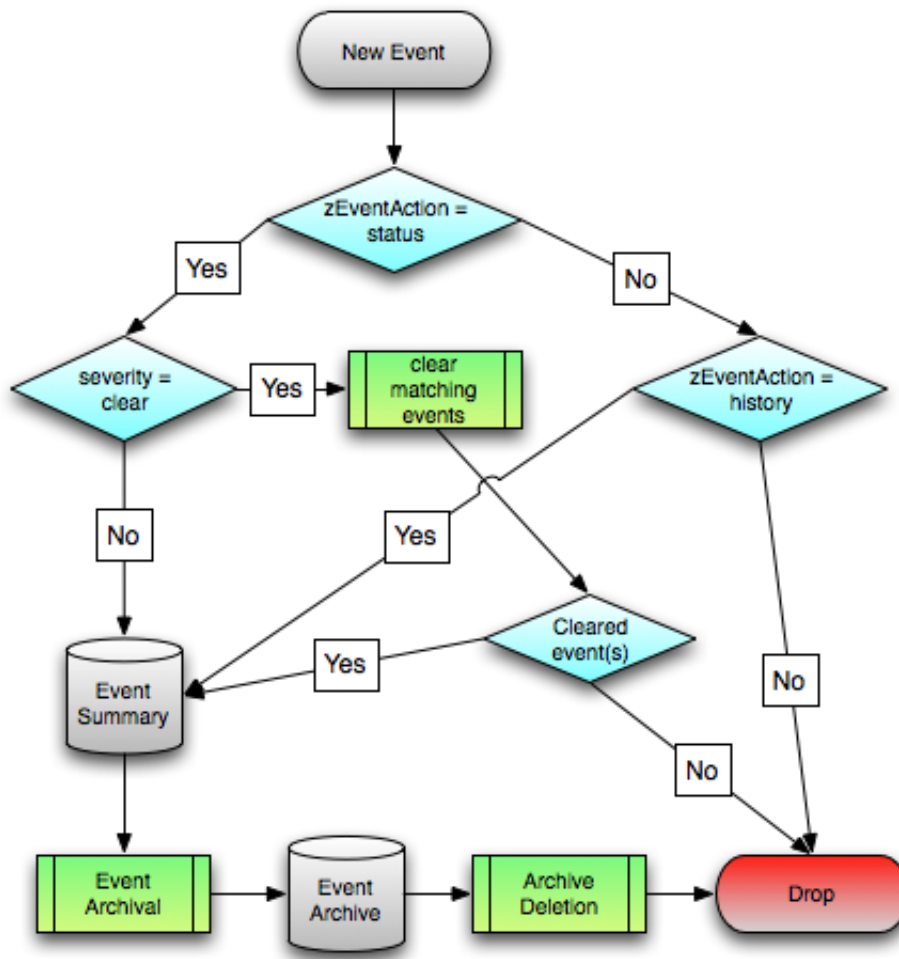

## Automatic event aging

From the Event Configuration page (**ADVANCED > Settings > Events**), you can set up automatic aging of events. Aging of events will automatically update active events that match the severity and aging threshold to a status of Aged. After the configured event archive interval, all Closed, Aged, and Cleared events are moved to the event archive.

Properties that control this behavior are:

- **Don't Age This Severity and Above** - Options are Age All Events, Critical, Error, Warning, Info, Debug, and Clear. By default, this value is set to Error, meaning that all events with a status of Error or Critical are not aged.
- **Event Aging Threshold (minutes)** - Set the time value, in minutes, that an event must reach before it is aged. By default, this is 240 minutes.
- **Event Aging Interval (milliseconds)** - The interval when events are scanned to perform autoaging. By default, this is 60000 milliseconds (60 sec).
- **Event Aging Limit** - The maximum number of events to age in each interval. The limit should be kept relatively low to prevent large database transactions. By default, this is 1000 events.
- **Event Archive Threshold (minutes)** - Specify the number of minutes since a closed event was last seen before it is moved to the event archive. The minimum value is 1; the maximum value is 43200.
- **Event Archive Interval (milliseconds)** - The interval when events are scanned for moving to the archive. By default, this is 60000 milliseconds (60 sec).

- **Event Archive Limit** - The maximum number of events to archive in each interval. The limit should be kept relatively low to prevent large database transactions. By default, this is 1000 events.
- **Delete Archived Events Older Than (days)** - The number of days that events in the event archive are saved. By default, they are kept in the archive for 90 days. The minimum value is 1 and the maximum value is determined by the range of event archive partitions. With the default configuration, the maximum value is 1000 days.
- **Default Syslog Priority** - Specify the default severity level assigned to an event coming from zensyslog if no priority can be determined from the event.
- **Default Availability Report (days)** - Enter the number of days to include in the automatically generated Availability Report. This report shows a graphical summary of availability and status.
- **Max Event Size in Bytes** - The maximum size of an event that will be processed in bytes. Events that are too large will be logged and dropped. Events that will become too big will have their details overwritten with new details. By default, this is 32768 bytes.
- **Summary Index Interval (milliseconds)** - The default indexing interval of the event summary in milliseconds. By default, this is 1000 milliseconds (1 sec).
- **Archive Index Interval (milliseconds)** - The default indexing interval of the event archive in milliseconds. By default, this is 30000 milliseconds (30 sec).
- **Index Limit** - The number of events to index in each index interval. By default, this is 1000 events.
- **Event Time Purge Interval (days)** - The number of days that event occurrence time are kept. By default, they are kept for 7 days. The minimum value is 1 and the maximum value is determined by the range of event time partitions. With the default configuration, the maximum value is 7 days.
- **Enable Event Flapping Detection** - Select this check box if you wish to enable event flapping detection. If an event is created and then cleared *flapping\_threshold* times in *event\_flapping\_interval* time then an event of event flapping event class is created.
- **Event Flapping Event Class** - The event class under which generated flapping events belong.
- **Clear Event Heartbeats** - Click **Clear** to clear the event heartbeats.

## Automatic archived event cleanup

You can set up automatic purging of events from the event archive from the Event Configuration page (**ADVANCED > Settings > Events**). When events are purged, they can be recovered only from backups.

The property that controls this behavior is Delete Archived Events Older Than (days). Acceptable values are between 1 and 1000 (days).

## Capturing email messages as events

---

ZenMail and ZenPop allow you to capture email messages as events. This capability can be useful for situations in which embedded systems (such as WAPs, NAS devices, or RAID controllers) rely on email notification for events.

### ZenMail

ZenMail serves as an SMTP server that you can bind to a specific TCP port. You can then configure your embedded system to send mail to the Resource Manager server explicitly by using the server's IP address as the relay.

ZenMail supports these configuration directives:

- `${ZENHOME}/bin/zenmail` (no arguments) - Default operation. Binds to port 25 on all ports and listens for email messages to arrive. Ignores the TO field in the email and uses the FROM address as the device IP address.
- `${ZENHOME}/bin/zenmail --listenPort` - Bind to the port provided. Useful in situations in which an SMTP server is already running on the Resource Manager server and you do not want to interfere with the

existing mail delivery system. Semantics are the same as the no argument version (FROM address is used as the device IP).

---

**Note** To execute a command using `$ZENHOME (/opt/zenoss` for the zenoss user), you must be attached to the container holding the Resource Manager application. See the Control Center documentation for `serviced` commands.

---

## ZenPop3

ZenPop3 allows you to retrieve event email from a POP server. ZenPop3 supports these configuration directives:

- `--usessl`- Issue the STARTTLS command to the POP server and attempt to transfer email messages using SSL encryption. This is required if retrieving mail from Google.
- `--nodelete`- Do not issue the DELE command after retrieving all messages. Typically this is used during initial testing so that you do not have to resend test messages to the POP account. Some email systems (such as Google) do not actually delete messages when the DELE command is issued.
- `--pophost`- The hostname or IP address of the POP server from which to retrieve messages.
- `--popport`- The TCP port the POP server listens on. Defaults to 110. Used in situations where the POP provider listens on another port (for example, Google on port 995).
- `--popuser`- The user name that contains email messages to retrieve.
- `--poppass`- The password to use for the user name provided.
- `--cycletime`- The time to sleep between polls. After all email is retrieved, ZenPop3 sleeps for this amount of time before waking up and attempting to pull new email.

## Translating message elements to the event

Resource Manager translates various message elements to the event, as follows:

- **FROM Field**- If the FROM field is an IP address, then the system associates the event with the device with the same IP address. If the FROM field is a fully qualified domain name, then the system resolves it to an IP address, and then performs the device association using the resolved IP address. The resolution of hostname uses "A" records rather than "MX" records.
- **TO Field**- The system ignores the TO field in the email message. ZenMail accepts email to any user and domain name combination. ZenPop also drops the TO field, and uses only the FROM field.
- **SUBJECT Field**- ZenMail and ZenPop use the SUBJECT as the event summary.
- **Message Body**- ZenMail and ZenPop use the first mime attachment as the event details. The system ignores secondary message bodies (typically HTML-encoded versions of the message). It also ignores attachments (such as files).

## SNMP traps and event transforms

---

An SNMP trap is a message that is initiated by a network element and sent to the network management system. Often, traps indicate a failure of some sort, such as a router message indicating a power supply failure, or a printer message indicating an "out-of-ink" condition.

If an SNMP trap enters the system, and Resource Manager cannot identify the event (the event is classified as "/Unknown"), then you can classify the event so that the system handles it consistently.

### Classifying SNMP traps

To classify an SNMP trap event:

- 1 From the Event Console, select the unknown event or events.

- 2 Click the **Reclassify an event** icon. The Classify Events dialog appears.
- 3 Select /App, and then click **Submit**.

To edit this classification:

- a From the Navigation area, select **Events > Event Classes**.
- b Ensure Mapping Instances appears.
- c Select the event map you created.
- d In the left panel, select **Edit** from the **Action** icon.

The edit page appears. This page contains rules used to map the event to the /App category. This rule, since it matches the trap by a specific OID, is all that is needed.

In the Transform area, you can enter code to modify the summary. For example, if you want to set the summary string to "Spam Filter Detects Virus," then you can enter:

```
evt.summary = "Spam Filter Detects Virus"
```

A trap has a header with some standard information, followed by a sequence of attribute/values.

You have indicated you want the value for the OID ".1.3.6.1.4.1.9789.1500.2.5" as the summary. If you had the MIB loaded, you could do this:

```
evt.summary = evt.spamFilterDetectsVirus
```

However, the OID and the data is still in there. Instead, use the slightly more cryptic:

```
evt.summary = getattr(evt, ".1.3.6.1.4.9789.1500.2.5", "Unexpected missing OID")
```

The "device" object for the event has been made available, as well:

```
evt.summary = getattr(evt, ".1.3.6.1.4.9789.1500.2.5", "Unexpected missing OID") \ + " from device " + device.getId()
```

Resource Manager uses MIBs to translate SNMP traps that contain raw OID values. Loading a MIB into the system allows it to translate numeric OIDs such as .1.3.6.1.2.1.1.6 into descriptive phrases like "sysLocation". It also makes it easier to manipulate the events in an event mapping.

---

**Note** After loading MIBs into the system, be sure to restart the `zentrap` service so that it can retrieve the new MIB information.

---

Figure 107: SNMP TRAP transform

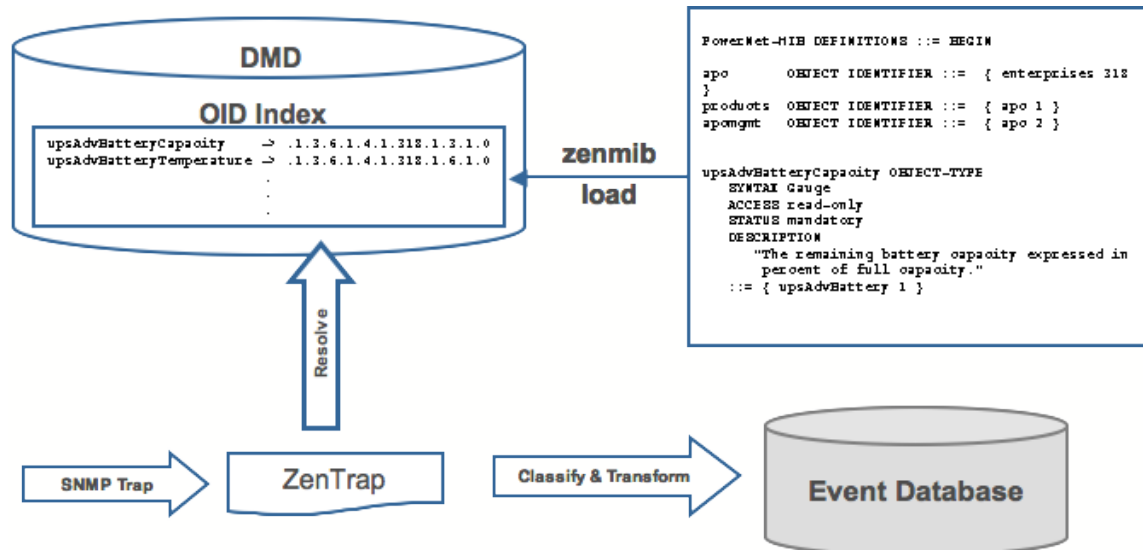

Following is a small demonstration MIB.

```

NOTIFICATION-TEST-MIB DEFINITIONS ::= BEGIN
IMPORTS
ucdavis FROM UCD-SNMP-MIB
NOTIFICATION-TYPE FROM SNMPv2-SMI
;
demonotifs OBJECT IDENTIFIER
 ::= { ucdavis 991 }
demo-notif NOTIFICATION-TYPE
OBJECTS { sysLocation }
STATUS current
DESCRIPTION "Just a test notification"
 ::= { demonotifs 17 }
END

```

### Example: Sending test traps

To send an SNMP trap:

- 1 From the command line, enter the following command:

```

$ snmptrap -v 2c -c public localhost '
1.3.6.1.4.1.2021.991.1.3.6.1.2.1.1.6 s \ "Device in Austin"

```

- 2 Save this demonstration MIB into a file.
- 3 Send the trap.
- 4 Open the Event Console and find the trap you sent.
- 5 Send this event to the event archive.
- 6 Load some MIBs into the system so that this OID is translated into a better format:
  - a Copy the demonstration MIB into \$ZENHOME/share/mibs/site.

---

**Note** To execute a command using \$ZENHOME (/opt/zenoss for the zenoss user), you must be attached to the container holding the Resource Manager application. See the Control Center documentation for serviced commands.

---

- b** Run zenmib to load it:

```
$ zenmib run -v 10 DEBUG:zen.zenmib:TRAP-TEST-MIB.mib
INFO:zen.zenmib:Unable to find a file \ providing the MIB UCD-SNMP-
MIB ...
```

- c** The MIB loaded, but is missing some other definitions. Copy them:

```
$ cp /usr/share/snmp/mibs/SNMPv2-MIB.txt $ZENHOME/share/mibs/site \
$ cp /usr/share/snmp/mibs/UCD-SNMP-MIB.txt $ZENHOME/share/mibs/site
```

- d** Run zenmib again and load the definitions into the system:

```
$ zenmib run -v 10
```

- e** Restart the zentrap daemon to retrieve the new MIB information:

```
$ zentrap restart
```

- f** Send the trap a second time:

```
$ snmptrap -v 2c -c public localhost '
1.3.6.1.4.1.2021.13.991 .1.3.6.1.2.1.1.6 s \ "Device in Austin"
```

- g** Check the event. Make sure the count is 1. If the count is 2, send the event to the event archive and send the trap again. Look at the Details tab. Now you should see something like this:

```
sysLocation Device in Austin
```

You should also see that the event summary changes from:

```
snmp trap 1.3.6.1.4.1.2021.13.991 from localhost
```

to:

```
snmp trap ucdExperimental from localhost
```

## Transforming events with event mappings

To modify events as they arrive, create an event map through the user interface:

- 1 Create an event class.
- 2 Go to the event console and create an event mapping in this class from the existing event.
- 3 Edit the map.
- 4 In the Transform area, update the event with detail data. The entry field allows you to insert Python scripts. The event is provided as "evt" and the device as "dev." In this case, extract the sysLocation event detail and make it the summary with:

```
evt.summary = evt.sysLocation
```

- 5 Save the event mapping.

If you move the event to the event archive and resend the trap, the summary for the trap should now read the device name in the location you assigned.

If you encounter problems with the transform, check the `zentrap.log` file for errors that occurred.

## Event transforms based on event class

When an event arrives in the system, you can change values (such as severity). For example, you can make the summary more informative, or change severity according to text within the summary.

Each event class allows for a short Python script to be executed when an event arrives.

### Example

A user may want full file system threshold events on `/data` to be critical. Add the following Python script in the Threshold Transform of `/Events/Perf/Filesystem`:

```
if evt.component == '/data' and evt.severity != 0: evt.severity = 5
```

Like event mappings for event class keys, "evt" and "dev" objects are available in the script of the transform.

## SNMP trap filtering at the collector level

`zentrap` supports SNMP trap filtering. For details on the filter definition, see the `/opt/zenoss/etc/zentrap.filter.conf` file in the `zentrap` service definition. For more information about enabling this feature, refer to the following KB article: ["How To Setup A Filter For SNMP Traps At The Collector Level \(Zentrap\) In Resource Manager 5.1.1"](#).

## Configuring SNMP trap forwarding

For multi-host systems, you must enable the `zentrap` service container to move between delegate hosts in the resource pool. Otherwise, the container is bound to a specific host, and if that host fails, you cannot receive traps. For resource pools with a single host, following this best practice allows for expansion without changing or moving IP addresses.

Before completing this task, obtain IP addresses for `zentrap` on the same network as your delegate hosts.

- 1 Log in to the Control Center browser interface.
- 2 In the main navigation menu, click **Applications**.
- 3 In the **Applications** table, click **Zenoss.resmgr**.
- 4 In the **IP Assignments** table under **Resource Pool**, choose the resource pool that contains the `zentrap` service.
- 5 In the **Virtual IPs** table, click **Add Virtual IP**.
- 6 In the **Add Virtual IP** dialog box, provide information about your IP address, and then click **Add Virtual IP**.
- 7 In the main navigation menu, click **Applications**.
- 8 In the **Applications** table, click **Zenoss.resmgr**.
- 9 In the **Services** table, expand the **Zenoss** service and subservices, locate `zentrap` and click the service name.

The page for the `zentrap` service opens.

- 10 In the **IP Assignments** table under **Actions**, click **Assign**.
- 11 In the **Assign IP** dialog box, provide information about the virtual IP address that you added to the pool, and then click **Assign IP**.
- 12 On the service page, click **Restart**.
- 13 When forwarding SNMP traps to Resource Manager, use this IP address.



## Configuring syslog message forwarding

For multi-host systems, you must enable the `zensyslog` service container to move between delegate hosts in the resource pool. Otherwise, the container is bound to a specific host, and if that host fails, you cannot receive syslog messages. For resource pools with a single host, following this best practice allows for expansion without changing or moving IP addresses.

Before completing this task, obtain IP addresses for `zensyslog` on the same network as your delegate hosts.

- 1 Log in to the Control Center browser interface.
- 2 In the main navigation menu, click **Applications**.
- 3 In the **Applications** table, click **Zenoss.resmgr**.
- 4 In the **IP Assignments** table under **Resource Pool**, choose the resource pool that contains the `zensyslog` service.
- 5 In the **Virtual IPs** table, click **Add Virtual IP**.
- 6 In the **Add Virtual IP** dialog box, provide information about your IP address, and then click **Add Virtual IP**.
- 7 In the main navigation menu, click **Applications**.
- 8 In the **Applications** table, click **Zenoss.resmgr**.
- 9 In the **Services** table, expand the **Zenoss** service and subservices, locate `zensyslog` and click the service name.

The service page for `zensyslog` opens.

- 10 In the **IP Assignments** table under **Actions**, click **Assign**.
- 11 In the **Assign IP** dialog box, provide information about the virtual IP address that you added to the pool, and then click **Assign IP**.
- 12 On the service page, click **Restart**.
- 13 When forwarding syslog messages to Resource Manager, use this IP address.

# Production states and maintenance windows

# 10

*Production state* determines the level of monitoring and alerting applied to an individual device. Typically, alerting rules specify that the system will monitor and create events for devices that are in the "Production" production state.

*Maintenance windows* are planned time periods used to temporarily modify alerting rules so that event-generated alerts are temporarily halted during the window.

## Production states

Production state determines whether a device is monitored, and can be used to control several elements of the event system, such as whether an event will produce a remote alert (email or page).

Choose a production state for a device based on whether you want:

- The device to be monitored
- The device to appear on the dashboard
- Alerting to occur

The following table lists production states and their characteristics.

Production state	Devices monitored?	Appear on dashboard?
Production	yes	yes
Pre-Production	yes	no
Test	yes	no
Maintenance	yes	may appear
Decommissioned	no	no

When you add a device to the system, its default state is Production. You may want to add triggers and notifications to alert you to various conditions that occur in the system, such as production state changes or a severity level being reached. For example, you can set up a trigger when a device is in either a production or a maintenance state and has a severity of Error or higher. You can then notify users when this trigger condition is met. For more information, see [Working with triggers](#) on page 22.

## Setting the production state for devices

To set the production state for a device:

- 1 Click a device name in the list of devices. The Device Overview page appears.
- 2 Select a production state from the list of options, and then click **Save**.
- 3 Optional: To set the production state for a group of devices, perform the following:
  - a Select a category of devices (by class, group, system, or location) from the hierarchy.
  - b Click the **Actions** button and select **Set Production State** from the drop-down menu.
  - c Select a production state from the drop-down list and click **OK**.
  - d To filter the display of devices with a certain production state, click the button underneath the Production State column header and check the production states you want to see in the display.

**Figure 108:** Select production state (multiple devices)

Device	IP Address	Device Class	Production State	Events
<a href="#">ucs-central13</a>	10.87.208.139	<a href="#">CiscoUCS/UCS-Central</a>	<input type="checkbox"/> Production	1
<a href="#">ucs-central132</a>	10.87.209.144	<a href="#">CiscoUCS/UCS-Central</a>	<input type="checkbox"/> Pre-Production	10
<a href="#">aus-ucs11</a>	10.87.208.11	<a href="#">CiscoUCS/UCS-Manager</a>	<input type="checkbox"/> Test	9
<a href="#">aus-ucs14</a>	10.87.208.14	<a href="#">CiscoUCS/UCS-Manager</a>	<input type="checkbox"/> Maintenance	16
<a href="#">aus-ucs20</a>	10.87.208.20	<a href="#">CiscoUCS/UCS-Manager</a>	<input type="checkbox"/> Decommissioned	1
<a href="#">ucs-mini3</a>	10.87.209.202	<a href="#">CiscoUCS/UCS-Manager</a>	Production	3
<a href="#">ucs1</a>	10.87.208.163	<a href="#">CiscoUCS/UCS-Manager</a>	Production	2
<a href="#">ucspm-stable.zenoss_loc</a>	10.87.208.152	<a href="#">ControlCenter</a>	Production	

## Maintenance windows

Maintenance windows allow scheduled production state changes of a device or all devices in a system, group, or location. You might want to set up a maintenance window, for example, to change a device's production state while you perform configuration changes or reboot a device.

**Note** In lieu of setting up a maintenance window, you can change the production state for a device manually at the time you want to make changes.

When the maintenance window starts, the production state of the device is set to the value of Start Production State (for example, *Maintenance*). When the maintenance window closes, the production state of the device reverts to the value of Stop Production State (the state the device was in prior to *Maintenance*).

Maintenance windows do not prevent notifications from being triggered on the device. If you want to define the notifications you receive during the maintenance window, you will need to set up an appropriate trigger for the device production state that you set during your maintenance window. For more information, see [Working with triggers](#) on page 22.

## Maintenance window events

When a maintenance window starts, an event is created with the following information:

- `depuid - zenactions | Resource | MaintenanceWindowName | TargetOrganizerOrDevice`
- `prodState - StartProductionState`
- `severity - Info`
- `summary/message - Maintenance window starting MaintenanceWindowName for TargetOrganizerOrDevice`
- `eventClass - /Status/Update`
- `eventClassKey - mw_change`

- `maintenance_devices` - *TargetOrganizerOrDevice*
- `maintenance_window` - *MaintenanceWindowName*

When a maintenance window stops, an event is created with the following information:

- `severity` - `Clear`
- `summary/message` - Maintenance window stopping *MaintenanceWindowName* for *TargetOrganizerOrDevice*
- `prodState` - `-99` (meaning "unknown.")

Maintenance window events auto-clear, meaning that stop events clear start events.

## Creating and using maintenance windows

You can create a maintenance window for an individual device or group of devices (all devices, a device class, group, system, or location) in the devices hierarchy.

### Create a maintenance window for a single device

Use this procedure to create a maintenance window for a device.

- 1 Log in to the Resource Manager browser interface, and then navigate to **INFRASTRUCTURE > Devices**.
- 2 In the content area, click the name of the device.
- 3 In the sidebar, click **Device Administration**.
- 4 In the Maintenance Window toolbar, click **Add**.
- 5 In the **Add New Maintenance Window** dialog box, specify the attributes of the new maintenance window.
 

The attributes allow you to specify whether or not to enable the window, the time of day and date when the maintenance window starts (in UTC format), the duration of the window, and whether and how the window repeats.

The **Window Production State** field allows you to categorize the production state of the device during the maintenance window. When the window ends, the device is returned to the production state it was in when it entered the maintenance window.
- 6 At the bottom of the **Add New Maintenance Window** dialog box, click **SUBMIT**.

### Create a maintenance window for a group of devices

Use this procedure to create a maintenance window for a group of devices.

- 1 Log in to the Resource Manager browser interface, and then navigate to **INFRASTRUCTURE > Devices**.
- 2 In the content area, select a group of devices, and then click **DETAILS**, located at the top of the sidebar.
- 3 In the sidebar, click **Device Administration**.
- 4 In the Maintenance Window toolbar, click **Add**.
- 5 In the **Add New Maintenance Window** dialog box, specify the attributes of the new maintenance window.
 

The attributes allow you to specify whether or not to enable the window, the time of day and date when the maintenance window starts (in UTC format), the duration of the window, and whether and how the window repeats.

The **Window Production State** field allows you to categorize the production state of the device during the maintenance window. When the window ends, the device is returned to the production state it was in when it entered the maintenance window.
- 6 At the bottom of the **Add New Maintenance Window** dialog box, click **SUBMIT**.

### Managing maintenance windows

Once you have created maintenance windows for your devices or groups of devices, you can quickly manage these instances on the Maintenance Windows screen.

- 1 Navigate to the Maintenance Window screen. This is the same place where you initially created the maintenance window (Device Administration link on Device Overview page). On this screen you can perform any of the following by clicking the appropriate icon:

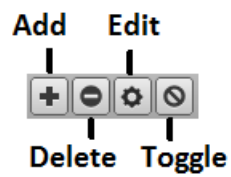

- Add a new maintenance window
  - Delete the selected maintenance window
  - Edit the selected maintenance window (can also double-click a maintenance window row)
  - Toggle the selected maintenance window from enabled to disabled and vice-versa. The Enabled column will switch values.
- 2 Ensure that your changes are reflected in the Maintenance Window screen.

## Organizers and path navigation

---

You can group system objects, including devices, sub-systems, components, configuration properties, and templates. A device, for example, can belong to multiple classifications, including:

- Device classes
- Groups
- Systems
- Locations

In the following illustration, the device `tilde.zenoss.loc` belongs to five different classifications. Configuration properties and monitoring settings for each of these groups are applied to this device.

**Figure 109:** Device Groupings

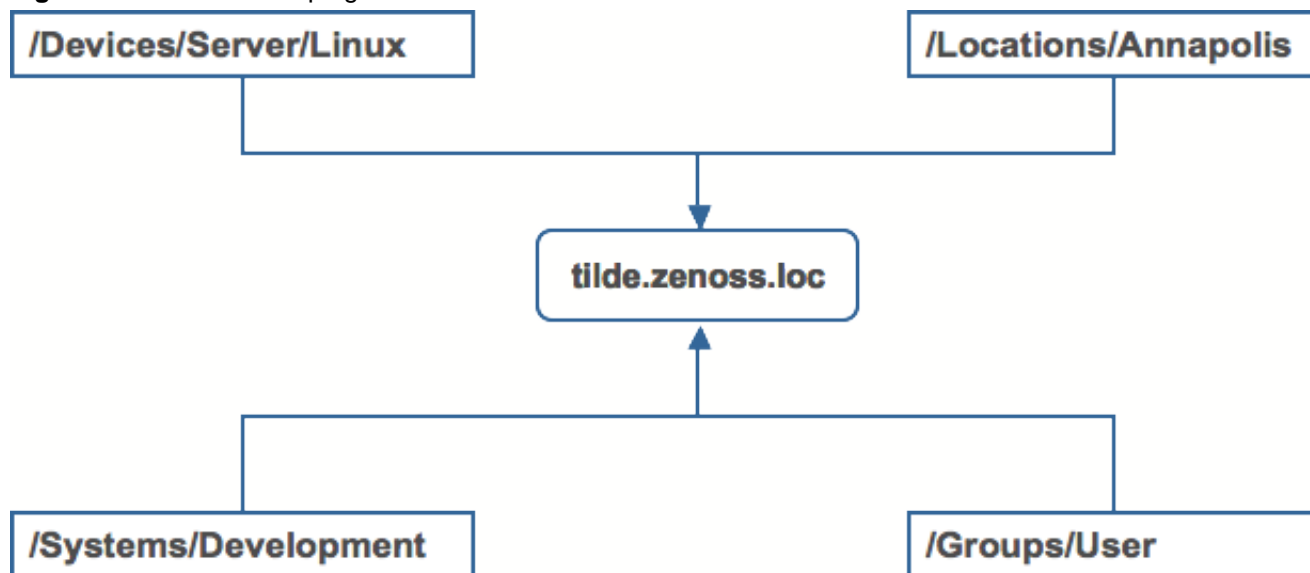

### Classes

---

The most important organizers are *classes*, which comprise:

- Device classes
- Event classes
- Service classes

- Product classes

Templates and configuration properties can be inherited based on class. These attributes can be overwritten further down the class hierarchy, all the way down to the individual component level. The class hierarchy includes all defined and standard classes and sub-classes.

The following procedures are illustrated using device classes and sub-classes, but the same concepts apply to event classes, service classes, and product classes. When you add a device to the system, you should (after providing the network name or IP address) specify its device class. Templates and configuration properties can be set at any level in the device class hierarchy.

## Viewing device classes

To view device classes and the devices they contain, select INFRASTRUCTURE from the Navigation menu.

The device list appears. The top of the devices hierarchy lists device classes. Click a class name to view devices in that class, or expand it to show sub-classes.

**Figure 110:** Devices hierarchy

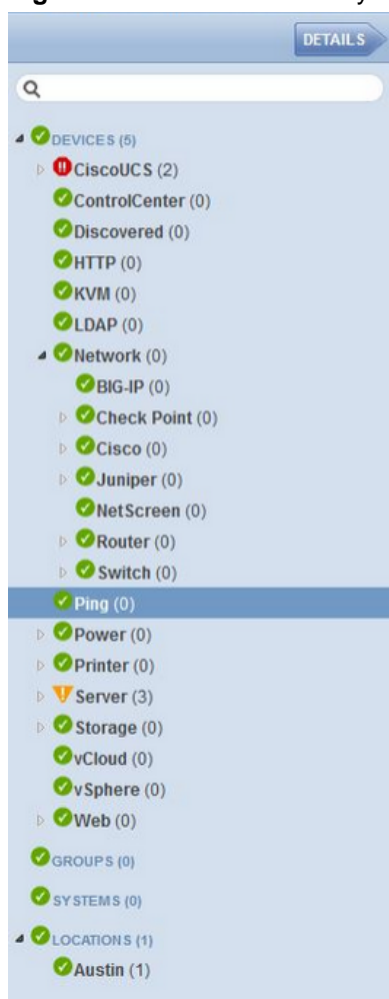

An indicator appears to the left of each listed class to show the most severe type of event associated with any device in that class.

## Adding a class

To create a device class:

- 1 Select **Infrastructure** from the Navigation menu. The device list appears.
- 2 Select the parent location in the device class hierarchy where you want to add a new child class.
- 3 Click the **Add** icon. The Add Device Class dialog box appears.
- 4 Enter a name and description for the new device class, and then click **Submit**. The new device class appears in the hierarchy under the parent device class. You can now move devices into this class. Select one or more devices in the device list, and then drag them to the new class.

## Moving a class

To move a class in the hierarchy:

- 1 Select the class in the hierarchy.
- 2 Drag the class to its new location. The Move Organizer confirmation dialog appears.
- 3 Click **OK** to confirm the action. The class appears at its new location in the hierarchy.

## Setting configuration properties at the class level

To set configuration properties at the device class level:

- 1 Select a device class in the devices hierarchy.
- 2 Click **Details > Configuration Properties**. The Configuration Properties page for the selected device class appears.

**Figure 111:** Device class configuration properties

Is Local	Category	Name	Value	Path
	Cisco	zCiscoACEUseSSL	true	/
	Cisco	zCiscoRemodeEventClassKeys		/
	Cisco UCS	zCiscoUCSIMEEventsInterval	60	/
	Cisco UCS	zCiscoUCSIMEPerInterval	300	/
	Cisco UCS	zCiscoUCSManagerPassword	*****	/
	Cisco UCS	zCiscoUCSManagerPort	443	/
	Cisco UCS	zCiscoUCSManagerUseSSL	true	/
	Cisco UCS	zCiscoUCSManagerUser	admin	/
	Modeler Controls	zCollectorClientTimeout	180	/
	Modeler Controls	zCollectorDecoding	utf-8	/
	Misc	zCollectorLogChanges	false	/
	zencommand	zCommandCommandTimeout	15	/
	zencommand	zCommandExistenceTest	test -f %s	/
	zencommand	zCommandLoginTimeout	10	/
	zencommand	zCommandLoginTries	1	/
	zencommand	zCommandPassword		/
	zencommand	zCommandPath	\$ZENHOME/libexec	/
	zencommand	zCommandPort	22	/
	zencommand	zCommandProtocol	ssh	/
	zencommand	zCommandSearchPath		/
	zencommand	zCommandUsername		/
	Control Center	zControlCenterHost	\$(here/managerip)	/

- 3 Edit configuration properties definitions as desired, and then click **Save**. Definitions are applied to all devices currently in, and added to, this class (unless overridden at a lower level in the hierarchy).



## Groups

---

Groups are functional divisions that allow you to assign attributes to multiple objects with similar functions. Groups can be used, for example, to arrange objects along departmental lines. Groups do not appear on the Dashboard.

### Adding a group

To add a group:

- 1 Select **Infrastructure** from the Navigation menu. The device list appears.
- 2 Select the parent location in the groups hierarchy where you want to create a child group.
- 3 Click the **Add** icon. The Add Group dialog box appears.
- 4 Enter a name and description for the group, and then click **Submit**. The group appears in the hierarchy. You can now move devices to this group. Select one or more devices in the device list, and then drag them to the new group.

### Moving a group

To move a group:

- 1 Select the group in the hierarchy.
- 2 Drag the group to its new location. The Move Organizer confirmation dialog appears.
- 3 Click **OK** to confirm the action. The group appears at its new location in the hierarchy.

## Systems

---

Systems are intended to follow virtual setups, such as those in a network setup or systems grouped by functionality.

### Adding a systems

To add a system or sub-system:

- 1 Select **Infrastructure** from the navigation menu. The device list appears.
- 2 Select the parent location in the systems hierarchy where you want to create a new child system.
- 3 Click the **Add** icon. The Add System dialog box appears.

**Figure 112:** Add System

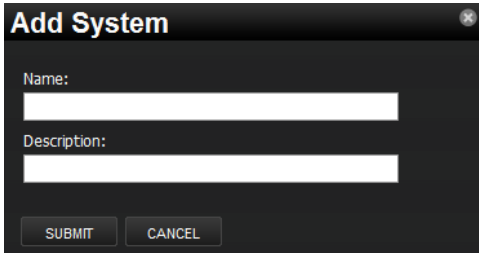

- 4 Enter a name and description for the system, and then click **Submit**. The system appears in the hierarchy. You can now move devices to this system. Select one or more devices in the device list, and then drag them to the new system.

### Moving a system

To move a system:

- 1 Select the system in the hierarchy.

- 2 Drag the system to its new location. The Move Organizer confirmation dialog appears.
- 3 Click **OK** to confirm the action. The system appears at its new location in the hierarchy.

## Locations

---

Locations are logical groupings for physical systems. They can be as general as city and state, or as specific as rack or closet. Locations do not appear on the Dashboard.

### Adding a locations

To add a location:

- 1 Select **Infrastructure** from the Navigation menu. The device list appears.
- 2 Select the parent level in the Locations hierarchy where you want to create a child location.
- 3 Click the **Add** icon. The Add Location dialog box appears.
- 4 Enter a name and description for the location, and then click **Submit**. The location appears in the hierarchy. You can now move devices to this location. Select one or more devices in the device list, and then drag them to the new location.

### Moving a location

To move a location:

- 1 Select the location in the hierarchy.
- 2 Drag the location to its new place. The Move Organizer confirmation dialog appears.
- 3 Click **OK** to confirm the action.

### Integration with Google Maps

The system can map locations by using a Google Maps mashup feature that sets the location's Address property to a valid Google Maps address. The selected location appears on the map as a dot. The color of the dot represents the highest severity of any event on any device in that location.

Network connections that span locations are represented on the map by lines. Each line color matches the status of the connection it represents.

Figure 113: Network location - Google Map

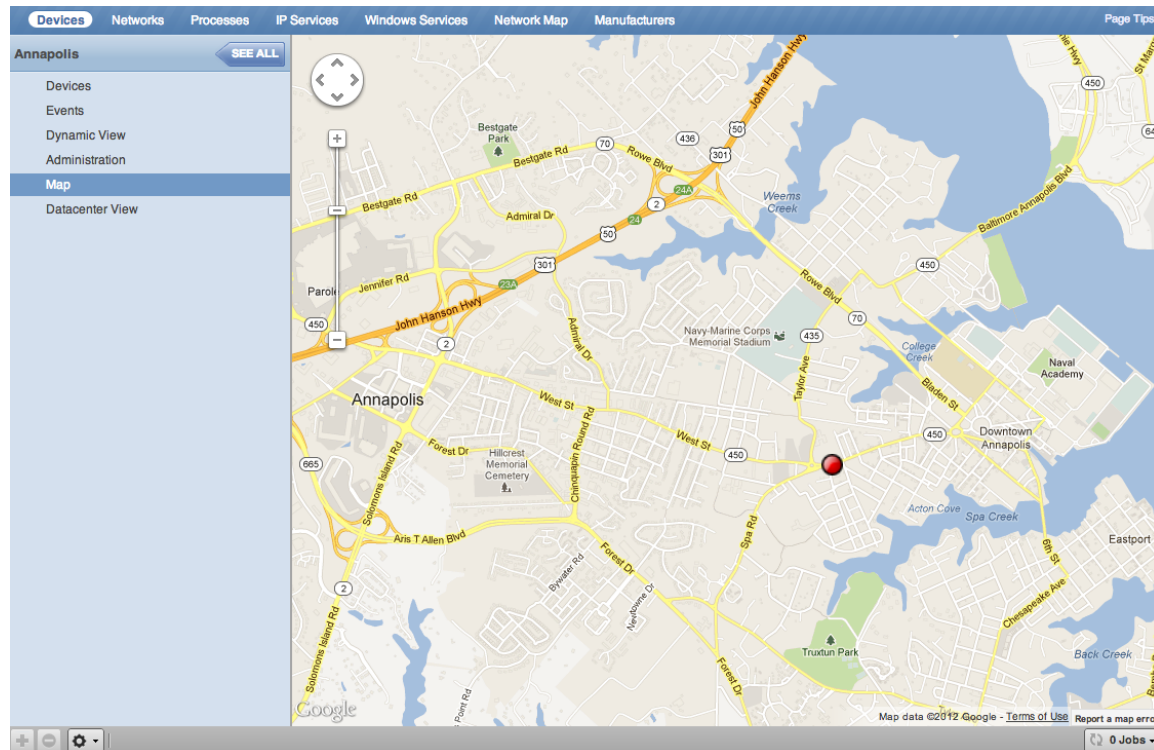

To view the Google Map for a network location:

- 1 From the Navigation menu, select Infrastructure.
- The device list appears.
- 2 In the hierarchy, select a location.
- 3 Click **Details**.
- 4 Select **Map**.

The network map appears.

---

**Note** You also can view the network location map from the Google Maps portlet on the dashboard.

---

### Enabling Google Maps

You can use the Google Maps feature by using a fully qualified domain name to access your Resource Manager server, and the top level domain name must be one that Zenoss has registered (e.g., .com, .net, .org, etc.). If an unknown top level domain is used, you should contact Zenoss Support so that we can register it with our Google API account.

### Setting an address for a location

To set a location address:

- 1 Select **Infrastructure** from the navigation menu. The device list appears.
- 2 Select a location in the hierarchy.
- 3 Select **Edit** from the **Action** icon. The Edit Organizer dialog box appears.
- 4 In the Description field, enter a description for the location.
- 5 In the Address field, enter a complete address that can be resolved by [Google Maps](#). The address must include a valid zip code.

- 6 Click **Submit**. The selected address for the location is created. You must add at least one device to the location for the location "dot" to appear on the map.

### Clearing the Google Maps cache

Sometimes there are issues with drawing the maps and seeing the network status of locations or connections. Clearing the Geocode cache will solve these problems. To clear the Geocode cache:

- 1 Select **Infrastructure** from the Navigation menu. The device list appears.
- 2 Select a location in the hierarchy.
- 3 Select **Clear Geocode Cache** from the **Action** icon. A confirmation dialog box appears.
- 4 Click **OK**.

### Network links

If two devices in the same network are in different map-able locations, a line is on the map representing a network connection between the two. If there are multiple separate network connections between the same two locations, only one line is drawn. The color of the line represents the highest severity of any events affecting the connection. These are determined by:

- A ping down event on the device at either end of the connection; or
- Any event on the interface at either end of the connection.

### Drawing map links (zDrawMapLinks configuration property)

Calculating network links on the fly is an time-intensive procedure. If you have a large number of devices that have been assigned locations, drawing those links on the map may take a long time.

To save time, you can tell the system not to attempt to draw links for specific networks. You might want to do this, for example, for a local network comprising many devices that you know does not span multiple locations.

To edit the value for this property:

- 1 Select **Infrastructure** > **Networks** from the Navigation menu. The Networks page appears.
- 2 Select a network or sub-network for which you want to disable map links.
- 3 Display configuration properties for the network.
- 4 Double-click the zDrawMapLinks configuration property in the list. The Edit Config Property dialog box appears.
- 5 De-select the value (uncheck the box), and then click **Submit**.

---

**Note** This setting will be inherited by networks or sub-networks below this selection in the hierarchy. If you have few networks for which links would be drawn, you might want to disable map links on /Networks, enabling it only on a network where you know a location-spanning WAN connection exists.

---

### Google Maps example

This example will show you how to:

- Create and display Google map links of devices
  - Send a test event to see how map links are affected by system changes
- 1 Disable map links. (Refer to the procedure in Drawing Map Links for instructions.)
  - 2 Create two locations: "New York" and "Los Angeles." (Refer to the procedure in Adding Locations for instructions.)
  - 3 Enter the following values in the Address field of the Add Location dialog: "New York, NY" and "Los Angeles, CA" respectively.

- 4 Set the location of a device to New York. Locate another device on the same network and set its location to Los Angeles.
- 5 Select Locations in the hierarchy, click **Details**, and then select Map.

New York and Los Angeles are represented by dots on the map; however, no link is drawn between these locations.

- 6 Select Networks and re-enable map linking.
- 7 Select Infrastructure, then select Locations in the hierarchy.
- 8 Click **Details**, and then select Map.

A green line is now drawn between New York and Los Angeles.

- 9 Send an event with a severity of Critical to the device in New York. (For information about creating events, refer to the chapter titled Event Management.) Do not specify a component.
- 10 Return to the Locations map.

The dot representing New York is now red, but the link between New York and Los Angeles remains green.

- 11 Navigate to the New York device and determine the ID of the component that is connected to the network shared with the Los Angeles device.
- 12 Send another test event, this time specifying that component.
- 13 Return to the Locations map.

The link between New York and Los Angeles is now red.

## Component groups

---

Use Component Groups to view or manage component resources as a logical group. When you add components to a component group, you can view all of the events for the group in a single location, display component graphs with all of the components on the same graph, and use the Dynamic and Dependencies views to see the group's dependents and dependencies. You can also monitor or lock individual components in the group or the entire group itself.

### Creating and viewing component group information

To create and view information about component groups:

- 1 Navigate to **INFRASTRUCTURE > Devices**.
- 2 Select **COMPONENT GROUPS**, then click the **Add** icon at the bottom of the page. The **Add Component Group** dialog box appears.
- 3 Enter a suitable **Name**, and an optional **Description**, then click **SUBMIT**. The new component group appears under **COMPONENT GROUPS**.
- 4 Under **COMPONENT GROUPS** at the top of the page, click the **Add** icon to open the **Add to Component Group** dialog.
- 5 In the dialog's search field, enter a component type, such as Blade Servers. A list of components appears in the **Search Results** table.
- 6 Select one or more components, then click **ADD**.
- 7 Continue to search for and add components or click **CLOSE**. The components are added to the group. You can now work with the new component group. For example:
- 8 To view Component Graphs:
  - a Highlight the new group and click **Details** at the top of the page.
  - b Click **Component Graphs**, then check **All on Same Graph**.

---

**Note** When using the **All on Same Graph** functionality, ensure that no more than 10 items are being displayed on the same graph for best usability.

---

- 9 To view events for the component group, click **EVENTS**.
- 10 To disable monitoring on one or more components:
  - a Select the components you want to disable.
  - b Click **Action > Monitoring**.
  - c Click **NO** to disable monitoring.

## Inheritance

---

Inheritance is defined by how many attributes are applied to a device at different levels in the device hierarchy.

The following diagram shows an example of how and where configuration properties can be set throughout the device class tree.

**Figure 114:** Device class tree and inheritance

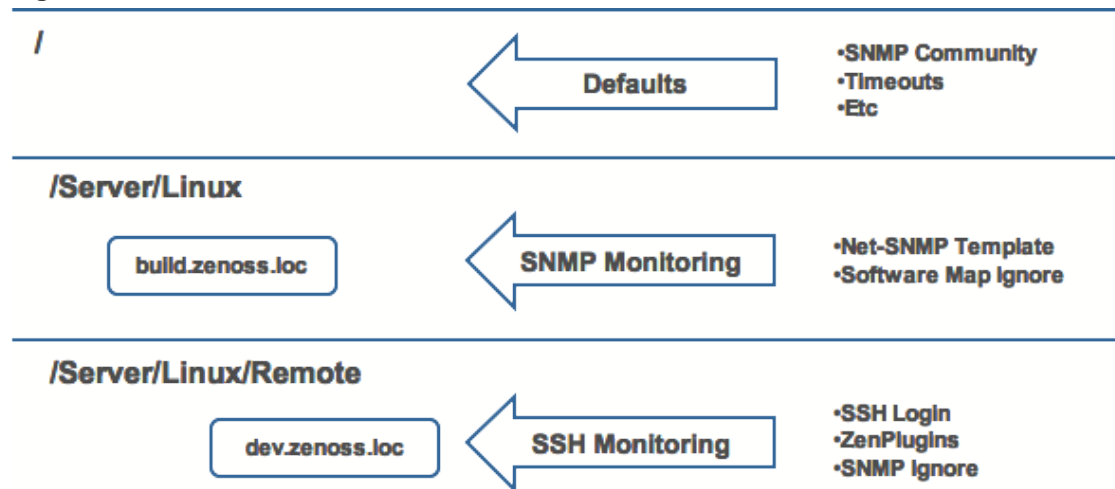

In this example, you can see that the default properties can be set at the highest level (`/`). However, as you travel further down the hierarchy, you see that you can override any of the configuration properties that are set at the root level.

The next two lines show how the device tree further defines properties for Linux servers. For example, to set up and use SNMP monitoring for all Linux servers (inclusive of) `build.zenoss.loc`, you could change these properties at the `/Server/Linux` level.

Further, if you wanted to change how you collect information for remote Linux servers, you could create a sub-group in `/Server/Linux` called `/Server/Linux/Remote`, setting these servers to use SSH monitoring and changing the associated properties for that sub-group.

All of these configuration properties and groupings co-exist, with any changes made lower in the hierarchy taking priority.

## Distributed monitoring

---

Resource Manager supports additional performance collection and event monitoring daemons, on the Resource Manager master host, and on other hosts.

This feature allows you to:

- Distribute processor, disk, and network load across multiple servers.
- Collect performance and event data from remote networks that cannot be reached by the Resource Manager master host.
- Configure more than one set of monitoring settings, such as different cycle times, for the `zenperfsnmp` daemon.

At installation, Resource Manager is configured with one hub and one collector (each named `localhost`) on the master host. The initial hub and collector may not be removed.

### About collectors

---

A *collector* is a set of collection daemons, on the Resource Manager host or another host, that shares a common configuration. That configuration contains values, such as:

- Number of seconds between SNMP collections cycles
- Default discovery networks
- Maximum number of `zenprocess` parallel jobs

Each collector has its own copy of each of the Resource Manager collection daemons. For example, Resource Manager initially contains collection daemons with names like `zenperfsnmp`, `zenprocess`, and `zenping`.

### About hubs

---

Resource Manager supports multiple hubs. A *hub* represents an instance of the `zenhub` daemon, through which all collector daemons communicate with the object and event databases. Hubs are now associated with a resource pool which helps with better collector distribution.

All collectors must belong to exactly one hub; however, a hub can have many collectors associated with it. All hubs (and indirectly all collectors) refer to the same object and event databases. Typically, only very large systems with more than five collectors (or more than 1,500 devices) benefit from multiple hubs.

The `ZooKeeper` service on the HBase cluster now maintains configuration data and provide distributed synchronization and group services.

## About resource pools

A resource pool is a collection of compute, network, and storage resources that allows for better collector distribution. A default single resource pool is defined at startup. You can create additional resource pools by identifying them with a unique pool ID. You can then add hosts and assign them to the desired pool as well as adding collectors directly into a resource pool for better distribution.

There is no longer any need to update hubs or collectors with software updates. As soon as a service is restarted it will use the latest committed changes from the resource pool.

## Navigating collectors and hubs

To view and manage collectors and hubs:

- 1 Log in as the Resource Manager user.
- 2 From the navigation menu, select **ADVANCED > Control Center**. The Control Center All Services page appears.

**Figure 115:** Control Center - All Services

The screenshot shows the 'All Services' page in the Control Center. At the top, there are navigation tabs: Settings, Move Devices, Control Center (selected), Monitoring Templates, and Jobs. Below the tabs is a toolbar with icons for adding, deleting, and refreshing services, along with buttons for Start, Stop, and Restart. The main content is a table with the following columns: Name, Type, Uptime, AutoStart, Restart, State, and Host.

Name	Type	Uptime	AutoStart	Restart	State	Host
CentralQuery	daemon	6 days, 9:06:34.813614	<input checked="" type="checkbox"/>		Up	ucspm-stable.zenoss.loc
HMaster	daemon	6 days, 9:06:26.678772	<input checked="" type="checkbox"/>		Up	ucspm-stable.zenoss.loc
Imp4MariaDB	daemon		<input type="checkbox"/>		Down	
Imp4OpenTSDB	daemon		<input type="checkbox"/>		Down	
localhost	hub				...	
localhost	collector				...	
collectorredis	daemon	6 days, 9:06:15.053303	<input checked="" type="checkbox"/>		Up	ucspm-stable.zenoss.loc
MetricShipper	daemon	6 days, 9:06:33.888581	<input checked="" type="checkbox"/>		Up	ucspm-stable.zenoss.loc
zencommand	daemon	6 days, 9:06:17.002472	<input checked="" type="checkbox"/>		Up	ucspm-stable.zenoss.loc
zenmail	daemon		<input type="checkbox"/>		Down	
zenmodeler	daemon	6 days, 9:06:15.942412	<input checked="" type="checkbox"/>		Up	ucspm-stable.zenoss.loc
zenperfsnmp	daemon	6 days, 9:06:15.928226	<input checked="" type="checkbox"/>		Up	ucspm-stable.zenoss.loc
zenping	daemon	6 days, 9:06:16.972205	<input checked="" type="checkbox"/>		Up	ucspm-stable.zenoss.loc
zenpropertymon...	daemon	6 days, 9:06:17.017761	<input checked="" type="checkbox"/>		Up	ucspm-stable.zenoss.loc
zenpython	daemon	6 days, 9:06:16.987216	<input checked="" type="checkbox"/>		Up	ucspm-stable.zenoss.loc
zenucsevents	daemon	6 days, 9:06:16.956418	<input checked="" type="checkbox"/>		Up	ucspm-stable.zenoss.loc
zensphere	daemon	5 days, 0:15:49.037176	<input checked="" type="checkbox"/>		Up	ucspm-stable.zenoss.loc
zminion	daemon	6 days, 9:06:15.901294	<input checked="" type="checkbox"/>		Up	ucspm-stable.zenoss.loc
zenhub	daemon	6 days, 9:06:15.875667	<input checked="" type="checkbox"/>		Up	ucspm-stable.zenoss.loc
mysqli-events	daemon	6 days, 9:06:24.785442	<input checked="" type="checkbox"/>		Up	ucspm-stable.zenoss.loc
mysqli-modeler	daemon	6 days, 9:06:24.798263	<input checked="" type="checkbox"/>		Up	ucspm-stable.zenoss.loc

The page lists existing hubs and collectors in hierarchical form. Hubs are listed at the top level; collectors are nested below the hub to which they belong.

From this page, you can:

- Add a hub or a collector
- Delete a hub (which also deletes its associated collectors) or a collector

**Note** You cannot delete the default hub and collector (localhost)

- View and edit hub settings
- Configure associated monitoring and performance templates



Select a hub to display details and graphs. The Resource Pool ID for the hub appears and can be changed if needed. You can add a description and password if needed.

**Figure 116: Control Center - hub details**

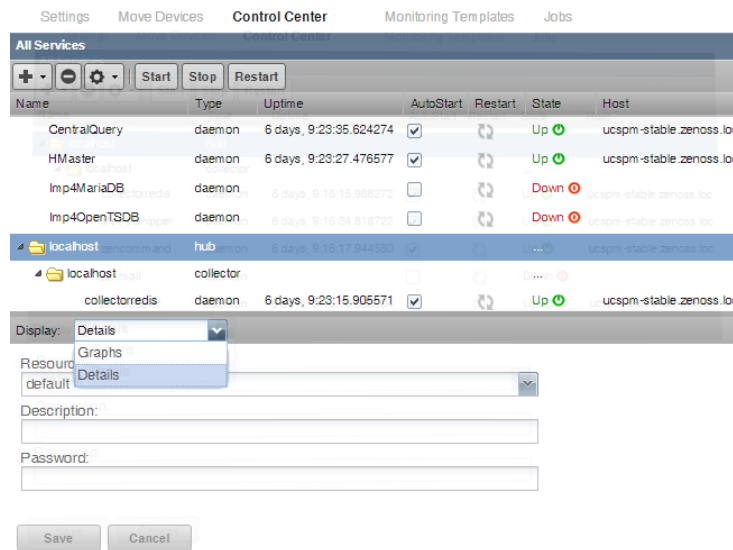

Select the zenhub daemon to view the details about the daemon, its logs, and to view and edit its configuration. Use the buttons on the top of the window to start, stop, or restart it.

**Figure 117: Control Center - daemon details**

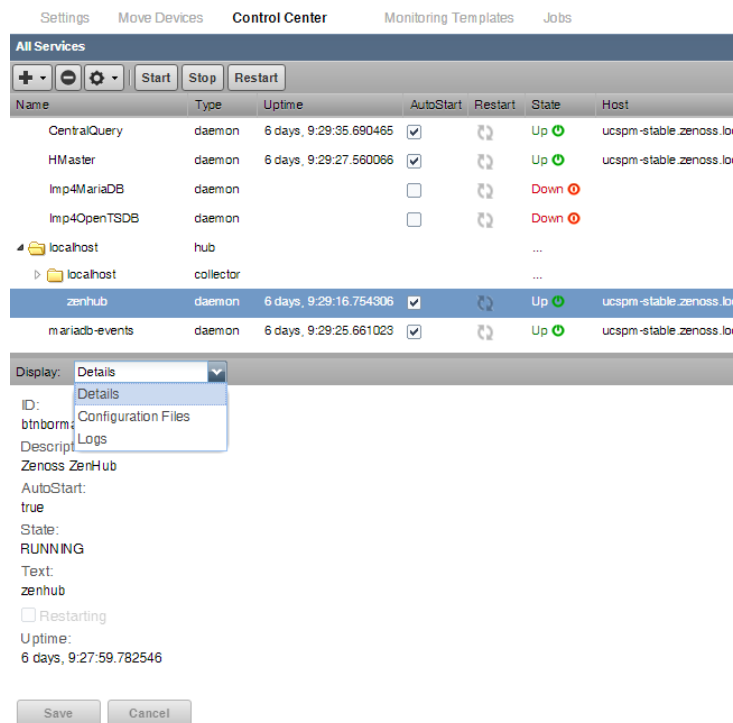

## Adding a hub or collector

---

See the *Control Center Planning Guide*, for more information about the sizing of your system and when you should consider adding more hubs and collectors.

To add a new hub or collector:

- 1 From the **ADVANCED > Control Center** page, click the **Add** button and select either **Add a new Collector** or **Add a new Hub**.
- 2 Enter the requested information:
  - For a collector:
    - Name - Name of the new collector
    - Hub - Name of the hub to associate the collector with
    - Resource Pool - Resource pool to be associated with
    - Clone collector from - Collector to clone configuration information from
  - For a hub:
    - Name - Name of the new hub
    - Resource Pool - Resource pool to be associated with
    - Clone hub from - Hub to clone configuration information from
- 3 Click **SUBMIT** to create the new collector or hub.

## Collector data storage

---

Resource Manager no longer uses RRD files on the collectors for data storage. We have created a centralized storage framework for this data which uses a Redis key-value store on the collector and then ships that data to an OpenTSDB (time series database) instance that runs on Hadoop and HBase.

## Deleting collectors

---

When you delete a collector, its devices are left without an assigned collector. Zenoss recommends that you reassign assigned devices prior to deleting a collector.

To delete a collector, click the name of the hub where the collector exists from the main collectors page. The Hub overview page appears. From the list of Collectors, select the collector you want to delete. From the Action menu, select Delete Collector.

When you delete collectors using this Resource Manager instance, they are not removed or "uninstalled" in any way from the collector device. They continue to exist on the device until manually removed through the file system.

## Adding devices to collectors

---

Adding devices to collectors occurs when you add the device to Resource Manager.

- 1 Log in to the Resource Manager user interface as a user with ZenManager or Manager privileges.
- 2 Navigate to **Infrastructure > Devices**.
- 3 From the **Add Device** icon, select **Add a Single Device**.
- 4 In the **Add a Single Device** dialog, use the **Collector** field to select a local or remote collector for the device.
- 5 Populate the remaining fields as required, and then click **Add**.

The device appears in the **Devices** list, located at the bottom of the Collector Display Devices page.

## Moving devices between collectors

---

To move devices from one collector to another.

- 1 From the Navigation menu, select **ADVANCED > Move Devices**. The Move Devices screen appears.

**Figure 118:** Move Devices

Name	Hub/Collector	Device Count
localhost	Hub	1
localhost	Collector	1

- 2 Select the source collectors you want to move, then select a target collector to move the devices to from the drop-down list.
- 3 Click **Submit** to confirm. Resource Manager moves the devices to the newly selected collector.

## Managing collector daemons

---

Collector daemons appear under the collector name on the Control Center All Services page and can be started, stopped and restarted from there. You can click on the name of a daemon to display details, configuration files, and logs.

---

**Note** Only one `zentrap` instance can be run on a server, as it must bind to the SNMP trap port (162).

---

## User commands

---

User commands allow you to execute arbitrary shell commands from Resource Manager. A user command is executed in its appropriate container rather than the remote device unless the command explicitly uses SSH to connect to the remote device.

You can define and run user commands on a device or organizer (device class, system, group, location, or component group). You also can define commands globally. The User Commands menu bar shows the various functions that can be used in the User Commands screen. See the following sections for detailed instructions on adding and running user commands on specific devices or groups of devices.

**Figure 119:** User commands menu bar

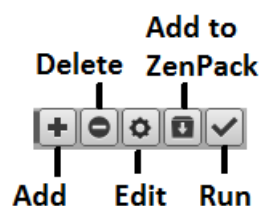

## Defining global user commands

---

Global commands appear in the Commands list of options located at the top of the Devices page.

To define global user commands:

- 1 Select **Advanced > Settings** from the Navigation menu.
- 2 In the left panel, select **Commands**.
- 3 In the Define Commands area, select **Add User Command** from the Action menu. The Add User Command dialog box appears.
- 4 Enter a name for the command, and then click **OK**. Only letters, numbers, and underscores are allowed in command names. Spaces are not allowed. The Define Commands page appears.
- 5 In the Description field, enter a description of what the command will do.
- 6 In the Command section, enter the TALES expression-based command you want to run on the device.
- 7 Enter your system account password for confirmation, and then click **Save**.  
The command is saved and added to the commands menu.

Global commands also can be edited from a specific device. Changes to a global command from a device are not limited to that device.

## Running global user commands

To run a global user command, select one or more devices in the devices list, and then select a command from the Commands list of options.

**Figure 120:** Global user commands

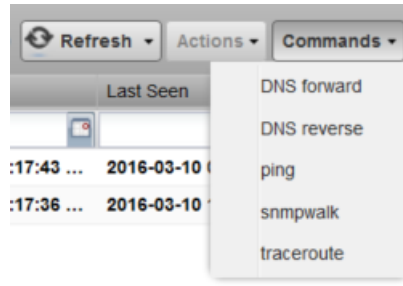

## Defining user commands for a single device

To define a user command for a device:

- 1 Select **INFRASTRUCTURE** from the Navigation menu. The Devices page appears.
- 2 Click a device name from the list to open the Device Overview page.
- 3 In the left panel, select **Device Administration**.
- 4 In the User Commands area, click the **Add a User Command** icon. The Add New User Command dialog box appears.

**Figure 121:** Add New User Command

- 5 Enter the following information about the user command:
  - **Name** - Name of the user command.
  - **Description** - Description of what the command will do.
  - **Command** - TALEs expression-based command you want to run.
  - **Confirm Password** - Enter your system account password for confirmation.
- 6 Click **Submit**. The command is saved and added to the user commands menu.

- Optional: Test the command by selecting the command from the list and clicking the **Run** icon.

## Running user commands for a single device

---

To run a command defined for a single device:

- Navigate to the **Infrastructure > Devices** page.
- Click the device name in the device list to open the Device Overview page.
- Select the command from the Commands list of options located at the bottom of the page.

**Figure 122:** Global User Commands Menu

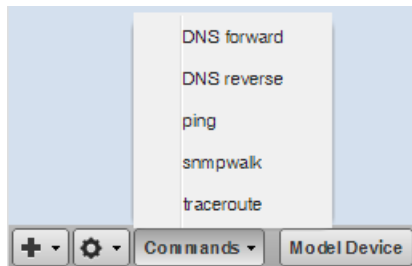

## Defining user commands for all devices in an organizer

---

To define a user command for all devices in an organizer:

- On the **INFRASTRUCTURE** page, select a device organizer in the devices hierarchy; for example, / Server/Linux.
- Click **Details**.
- In the left panel, select **Device Administration**.
- In the User Commands area, click the **Add a User Command** icon. The Add New User Command dialog box appears.

**Figure 123:** Add New User Command

- Enter the following information about the user command:
  - **Name** - Name of the user command.
  - **Description** - Description of what the command will do.
  - **Command** - TALES expression-based command you want to run.
  - **Confirm Password** - Enter your system account password for confirmation.

- 6 Click **Submit**. The command is saved and added to the user commands menu.
- 7 Optional: Test the command by selecting the command from the list and clicking the **Run** icon.

## Running user commands for devices in an organizer

---

To run a command defined for devices in an organizer:

- 1 On the Infrastructure page, select a device organizer.
- 2 Select one or more devices in the filtered view.
- 3 Select the command from the Commands list located at the top of the page.

**Figure 124:** Global user commands

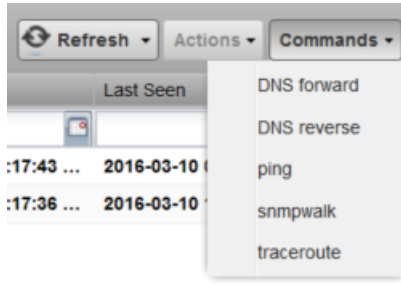

## User command example: Echo command

---

This example shows how to create an echo user command. You can see the use of TALES expressions in the definition of this command.

- 1 Add a command called "echoDevice"
- 2 In the command definition, echo the name and IP address of the device:

```
echo name = ${here/id} ip = ${here/manageIp}
```

In a TALES expression, `here` is the object against which the expression is executed. Some TALES expressions in the system have other variables (such as `evt` for event, and `dev` or `device` for the device). See the Appendix titled TALES Expressions for more information about TALES expressions syntax.

- 3 Select a device and then run the command.
- 4 Edit the command to add more information:

```
echo name = ${here/id} ip = ${here/manageIp} hw = ${here/getHWproductName}
```

- 5 Run the command against a group of devices and view the command outputs.

## Managing users

---

Every user within Resource Manager has a unique user ID, which allows an administrator to assign group permissions and alerting rules that are unique to each user. Unique IDs also help ensure secure access to the system.

To create and manage user accounts, you must be logged in to the system `admin` account, or as a user with extended privileges.

### Creating user accounts

---

To create a user account:

- 1 From the Navigation menu, select **ADVANCED**. The Settings page appears.
- 2 In the left panel, select **Users**. The users and groups administration page appears.
- 3 From the Action icon, select **Add New User**. The Add User dialog appears.
- 4 In the Username field, enter a unique name for the account.
- 5 In the Email field, enter the user account email address. Any alerts that you set up for this user will be send to this address.
- 6 Click **OK**. The user appears in the User List.

After creating the account, edit the account to provide a password and additional user details.

### Editing user accounts

---

To access and edit user account information:

- 1 In the Users list, click the name of the user you want to edit. The edit user page appears. The following example shows the admin user.



Figure 125: Edit user

ZenUsers > admin

State at time: 2017-04-06 22:24:18

Automatically generate a new password and send it to the email listed below.

**USER PREFERENCES**

Reset all preferences such as grid columns and filters to their default values.

**USER SETTINGS**

Roles: Manager, ZenManager, ZenOperator, ZenUser

Groups: test\_group

Email:

Pager:

Default Page Size: 40

Default Admin Role: ZenUser

Network Map Start Object:

Time Zone: America/Chicago

Date format: MM/DD/YY

Time format: HH:mm:ss

Set New Password:

Confirm New Password:

Current Password for admin:

2 Make changes to one or more settings:

- **Reset Password** - Facilitates user self-service by allowing a user to reset his or her own password. Click to reset and email the new password to the email address associated with the user's account.
- **User Preferences** - Resets all preferences such as grid columns and filters to their default values.
- **Roles** - Assign one or more roles (user privileges) to the user. To edit or assign roles, you must be a system Admin or be assigned the Manager role. For more information about user roles, and for a list of available roles and the privileges they provide, see [Roles](#) on page 180.
- **Groups** - Specify one or more groups to which this user belongs.
- **Email** - Enter the user's email address. To verify that the address is valid, click the test link.
- **Pager** - Enter the user's pager number.
- **Default Page Size** - Controls how many entries (by default) appear in tables. Enter a value for the default page size. The default value is 40.
- **Default Admin Role** - Select the default role that this user will have for administered objects associated with him or her.
- **Network Map Start Object** - Specify the default view for this user in the network map.
- **Time Zone** - Specify the time zone to be displayed on all charts and graphs within the product.
- **Time Format** - Select the time format. Options include 24-hour time (HH:mm:ss) or 12-hour time using a.m. and p.m. (hh:mm:ss a).
- **Set New Password / Confirm New Password** - Enter a new password for the user and confirm the entry.

3 Enter your password, and then click **Save** to confirm and save the changes for the user.

## Associating objects with specific users

You can associate any object in the system with a particular user, for monitoring or reporting purposes. Once associated with a user, you can then assign the user a specific role that applies to his privileges with respect to that object.

For more information about object-specific roles, see [Roles](#) on page 180.

To create an object association:

- 1 From **ADVANCED > Settings**, select **Users** in the left panel.
- 2 Click the name of a user.
- 3 From the Edit page, select **Administered Objects** in the left panel. The list of administered objects appears.

**Figure 126:** Administered objects - add object

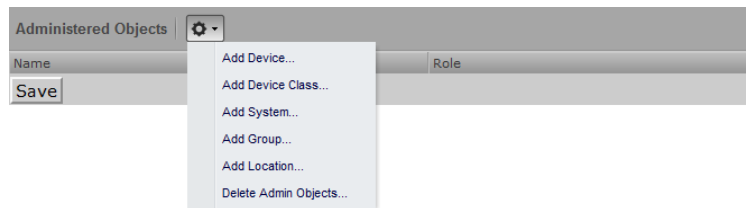

- 4 Select an object type from the Administered Objects Action menu. You can add:
  - Device
  - Device class
  - System
  - Group
  - Location
- 5 Specify the component you want to add as an administered object, and then click **OK**. The object appears in the Administered Devices list for the user.

**Figure 127:** Administered Objects - Objects Added



- 6 Optional: Change the role that is associated for this user on this object.

---

**Note** The default role assigned to the user for an administered object is specified by the Default Admin Role field on the Edit page.

---

- 7 Click **Save** to save changes.

### Adding administrators

You also can associate an object with a user by adding an administrator to the object. Perform the following:

- 1 Navigate to the object you want to add to the user's list of administered objects.
- 2 Select **Device Administration**.

**Figure 128:** Administered objects - add administrator

The screenshot displays the 'Administered objects' page in the Network Manager. The left sidebar is under 'Device Administration'. The main content area is split into three sections:

- Maintenance Windows:** A table with columns: Enabled, Name, Start, Duration, Repeat, State. It contains three rows:
 

Enabled	Name	Start	Duration	Repeat	State
No	1st of Month	2014/12/01 02:00:00	01:00:00 hrs	Monthly: day of month	Maintenance
Yes	Every Thursday Night	2014/12/11 22:00:00	30:00 mins	Weekly	Maintenance
Yes	One Time Testing	2014/12/20 08:00:00	04:00:00 hrs	Never	Test
- User Commands:** A table with columns: Name, Command. It contains five rows:
 

Name	Command
DNS forward	host \$(device/Id)
DNS reverse	host \$(device/managerIp)
ping	\$(device/pingCommand) -c2 \$(device/mana...
snmpwalk	snmpwalk -\$(device/zShmpVer) -c\$(device/z...
traceroute	\$(device/tracerouteCommand) -q 1 -w 2 \$(d...
- Administrators:** A table with columns: Name, Role, Email, Pager. It contains one row:
 

Name	Role	Email	Pager
cgilchrist	Manager	cgil...	

- 3 Click the **Add Administrator** icon in the Administrators area. The Add Administrator dialog box appears.
- 4 Select an administrator from the list and change the role if desired, then click **SUBMIT**. The administrator appears in the object's Administrators list. The object is added to the administrator's Administered Objects list.

## User groups

Resource Manager allows you to create user groups. By grouping users, you can aggregate rules and apply them across multiple user accounts.

### Viewing user groups

To view user groups, select **ADVANCED > Settings**, and then select **Users** from the left panel.

The groups area shows each user group and the users assigned to that group.

### Creating user groups

You can create user groups to aggregate rules and apply them across multiple user accounts.

To create a user group:

- 1 Navigate to **ADVANCED > Settings**.
- 2 In the left panel, select **Users**. The Users page appears.
- 3 From the Groups area Action menu, select **Add New Group**. The Add Group dialog box appears.
- 4 In the Group field, enter a name for this user group, and then click **OK**. The group name appears in the Groups list.
- 5 Click the name of the group you created. The Users in Group page appears.
- 6 From the Action menu, select **Add User**. The Add User to Group dialog box appears.

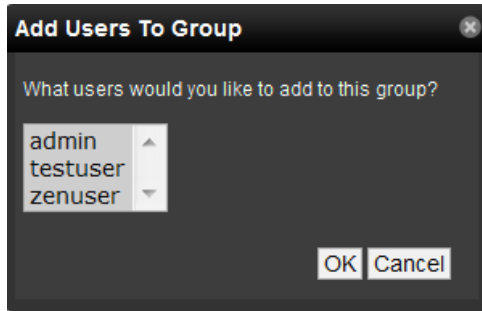
**Figure 129: Add User to Group**

- From the User list of selections, select one or more users you want to add to the group, and then click **OK**. The user or users you select appear in the list of users for this group.

You also can choose administered objects and alerting rules for this user group. These alerting rules will apply to all users in the group. The user's original alerting rules and objects will also apply.

## Roles

---

A role is a group of permissions that you can assign to users or groups.

The following table lists available roles.

Role	Permissions
ZenUser	Provides global read-only access to system objects.
ZenManager	Provides global read-write access to system objects.
Manager	Provides global read-write access to system objects. Additionally provides read-write access to the Zope object database.
ZenOperator	Provides event management. Combine the ZenOperator role with the ZenUser role to allow users read-only access to the system, but also allow them to acknowledge and close events, move events to history, and add log messages to events. You can associate the ZenOperator role with an individual device, a device class, or a group of devices.

## Device access control lists

---

### About device access control lists (ACL)

Resource Manager supports fine-grained security controls. For example, this control can be used to give limited access to certain departments within a large organization or limit a customer to see only his own data. A user with limited access to objects also has a more limited view of features within the system. As an example, most global views, such as the network map, event console, and all types of class management, are not available. The device list is available, as are the device organizers: systems, groups, and locations. A limited set of reports can also be accessed.

### Permissions and roles

Actions in the system are assigned permissions. For instance to access the device edit screen you must have the "Change Device" permission. Permissions are not assigned directly to a user; instead, permissions are granted to roles, which are then assigned to a user. A common example is the ZenUser role. Its primary permission is "View," which grants read-only access to all objects. ZenManagers have additional permissions such as

“Change Device,” which grants them access to the device edit screen. When you assign a role to a user using the Roles field (on the Edit page), it is global.

## Administered objects

Device ACLs provide limited control to various objects within the system. Administered objects are the same as the device organizers: Groups, Systems, and Locations and Devices. If access is granted to any device organizer, it flows down to all devices within that organizer. To assign access to objects for a restricted user, you must have the Manager or ZenManager roles. The system grants access to objects is granted using the user's or user group's administered objects. To limit access, you must not assign a “global” role to the user or group.

## Users and groups

Users and user groups work exactly as they would normally. See the section in the User Management section of this guide dealing with users and groups.

## Assigning administered object access

For each user or group there is an Administered Objects selection, which lets you add items for each type of administered object. After adding an object you can assign it a role. Roles can be different for each object, so a user or group might have ZenUser on a particular device but ZenManager on a location organizer. If multiple roles are granted to a device through direct assignment and organizer assignment the resulting permissions will be additive. In the example above, if the device was within the organizer the user would inherit the ZenManager role on the device.

## Portlet access control

Within Resource Manager, portlet access can be controlled. This is important for device ACLs.

### Example: Restricted user with ZenUser role

To create a restricted user with a ZenUser role:

- 1 As admin or any user account with Manager or ZenManager role, create a user named acltest. Set a password for the user.
- 2 Make sure that no role is assigned to the user.
- 3 Edit the user's administered objects.
- 4 Add an existing device to the user. The device's role will default to ZenUser.
- 5 Log out of your browser, or open a second browser and then log in as acltest.
- 6 Select **INFRASTRUCTURE**. You should see only the device you assigned to acltest.
- 7 Navigate to the device and notice that the edit capabilities are not available. This is because you are in read-only mode for this device.

### Example: Restricted user with ZenOperator role

The ZenUser role from the previous section allows read-only access to devices. By adding the ZenOperator role to specific devices, device classes, or groups of devices, a user will be able to acknowledge and close events, move events to history, and add log messages to events.

To add the ZenOperator role to specific devices, device classes, or groups of devices:

- 1 Select the user name whose role must be changed on certain devices.
- 2 In the left-hand pane, click Administered Objects.
- 3 Click the Action icon and choose the device, device class, or other device organizer to which you want to grant the ZenOperator role.

- 4 Select the ZenOperator role from the drop-down menu for the newly selected device, device class, or device organizer.

The user now has the ZenUser role for all devices in this instance, with the exception of the devices selected above which function under the ZenOperator role.

### Example: Restricted user with ZenManager role

To restrict a user to a specific role:

- 1 Change the acltest user's role to "ZenManager" on the device. (You must do this as a user with ZenManager global rights.)
- 2 Go back to the acltest user's administered objects and set the role on the device to ZenManager.
- 3 As acltest, navigate back to the device. You now have access to edit the device.

### Example: Adding device organizers

To add a device organizer:

- 1 Go to Groups and create a group called "RestrictGroup."
- 2 Go to the acltest user's administered objects and add the group to the user.
- 3 Logged in as acltest, notice that groups can be added to a user.
- 4 Place a device within this group and as acltest you should not only see the device within the group but also in the device list.

### Restricted user organizer management

- 1 Give the acltest user ZenManager on your restricted group.
- 2 As acltest, you can now add sub-organizers under the restricted group.

### Viewing events

A user in restricted mode does not have access to the global event console. The available events for the user can be seen under his organizers.

### Detailed restricted screen functionality

#### Dashboard

By default, the dashboard is configured with three portlets:

- Object Watch List
- Device Issues
- Production State

These have content that will be restricted to objects for a given user.

#### Device list

The device list is automatically filtered to devices of a restricted user scoped to accessible devices. No menu items are available.

#### Device organizers

Device organizers control groups of devices for a restricted user. Every device added to the group will be accessible to the user. Permissions will be inherited down multiple tiers of a device organizer.

## Reporting

Reports are limited to device reports and performance reports.

## Reporting

The **REPORTS** tab of the Resource Manager browser interface provides summaries of monitored resources in a tree view. Expand an organizer to see reports in that category.

You can organize reports and the display order of the report organizers by drag-and-drop within the tree view.

**Figure 130:** Reports list

Name	Class	First Seen	Collection	Change
qa-centos-7-events-ssh.zenoss.loc	/Server/SSH/Linux	2016-10-20 18:16:45	2016-10-20 18:17:22	2016-10-20 18:17:20
Juniper_J2350	/Network/Juniper	2016-10-20 17:50:00	2016-10-20 17:50:20	2016-10-20 17:52:14
Solaris_5_10	/Server/Linux	2016-10-20 17:45:59	2016-10-20 17:46:18	2016-10-20 17:48:02
ucs1.zenoss.loc	/Cisco/UCS/UCS-Manager	2016-10-20 16:19:18	2016-10-20 16:20:29	2016-10-20 16:20:18
ucs1-4-7.zenoss.loc	/Server/Microsoft/Windows	2016-10-20 15:15:21	1970-01-01 00:00:00	2016-10-20 15:15:41
perf2-vcenter.zenoss.loc	/vSphere	2016-10-20 15:09:45	2016-10-20 15:13:27	2016-10-20 18:22:31
qa-suburbi-12.zenoss.loc	/Server/Linux	2016-10-20 15:06:16	2016-10-20 15:06:32	2016-10-20 15:06:32
qa-suse-12.zenoss.loc	/Server/SSH/Linux	2016-10-20 15:03:53	2016-10-20 15:05:13	2016-10-20 15:05:09
qa-rhel-7.zenoss.loc	/Server/SSH/Linux	2016-10-20 15:02:02	2016-10-20 15:02:48	2016-10-20 15:02:42
test-rhel6.zenoss.loc	/Server/Linux	2016-10-20 15:00:37	2016-10-20 15:00:53	2016-10-20 15:00:52
test-rhel54.zenoss.loc	/Server/Linux	2016-10-20 14:59:18	2016-10-20 14:59:35	2016-10-20 14:59:35
qa-cisco-Nexus-5000-snmpp-v3.zenoss.loc	/Network/Cisco/Nexus/5000	2016-10-20 14:42:00	2016-10-20 14:44:54	2016-10-20 14:44:47
qa-cisco-Nexus-7000-snmpp-v3.zenoss.loc	/Network/Cisco/Nexus/7000	2016-10-20 14:40:11	2016-10-20 14:40:44	2016-10-20 14:40:40
N6001-2	/Network/Cisco/Nexus/6000	2016-10-20 14:35:49	2016-10-20 14:38:52	2016-10-20 14:37:42
nexus-5k.zenoss.loc	/Network/Cisco/Nexus/5000	2016-10-20 14:33:31	2016-10-20 14:34:12	2016-10-20 14:34:11
CUSQIU001CN3B5	/Network/Cisco/Nexus/3000	2016-10-20 14:30:55	2016-10-20 14:32:08	2016-10-20 14:31:45
N1ky-Orch	/Network/Cisco/Nexus/1000V	2016-10-20 14:29:18	2016-10-20 14:29:38	2016-10-20 14:29:38
Cisco_10.171.100.14	/Network/Cisco/6500	2016-10-20 14:26:51	2016-10-20 14:28:11	2016-10-20 14:27:49
10.87.254.1	/Network/Cisco	2016-10-20 14:24:23	2016-10-20 14:25:37	2016-10-20 14:25:32
perf3-switch.zenoss.loc	/Network/Cisco	2016-10-20 14:22:51	2016-10-20 14:23:18	2016-10-20 14:23:16
perf2-switch.zenoss.loc	/Network/Cisco	2016-10-20 14:21:09	2016-10-20 14:21:45	2016-10-20 14:21:43
qa-centos-7-snmpp-v3.zenoss.loc	/Server/Linux	2016-10-20 14:16:01	2016-10-20 14:18:27	2016-10-20 14:18:27
qa-centos-7.zenoss.loc	/Server/SSH/Linux	2016-10-20 14:13:52	2016-10-20 14:58:49	2016-10-20 14:58:48
qa-centos-7-snmpp.zenoss.loc	/Server/Linux	2016-10-20 14:13:06	2016-10-20 14:13:21	2016-10-20 14:13:21
qa-centos-6.zenoss.loc	/Server/SSH/Linux	2016-10-20 14:11:11	2016-10-20 14:11:55	2016-10-20 14:11:47
qa-centos-6-snmpp-v3.zenoss.loc	/Server/Linux	2016-10-20 14:06:54	2016-10-20 14:09:04	2016-10-20 14:09:04
qa-centos-6-snmpp.zenoss.loc	/Server/Linux	2016-10-20 14:05:27	2016-10-20 14:05:43	2016-10-20 14:05:42
qa-centos-5.zenoss.loc	/Server/SSH/Linux	2016-10-20 14:03:30	2016-10-20 14:04:12	2016-10-20 14:04:06
10.171.54.15	/Server/Linux	2016-10-20 14:00:05	1970-01-01 00:00:00	2016-10-20 14:00:05
qa-centos-5-snmpp.zenoss.loc	/Server/Linux	2016-10-20 13:59:20	2016-10-20 13:59:41	2016-10-20 13:59:40
resmar-510.zenoss.loc	/ControlCenter	2016-10-20 13:56:32	2016-10-20 13:58:07	2016-10-20 13:57:22

### Troubleshooting problems with report generation

If you experience stair-stepping in graphs, consider changing the reporting collection interval in Resource Manager. For example, setting the reporting collection interval to 60 minutes tells Resource Manager to update the API-driven reporting data at that interval, which is different from the native collection interval.



If browser interface responsiveness slows during report generation, consider increasing instances of the Zope web application server. By default, Resource Manager provides one dedicated instance for reporting. For more information, see [Managing Zope instances](#) on page 237.

## Organizing reports

---

You can organize reports by creating organizers and moving reports into them. You can create report organizers at multiple levels, even within another organizer. To create a report organizer:

- 1 Select an existing organizer or the top of the reports hierarchy, and then click **Add**.
- 2 Click **Add Report Organizer**.
- 3 In the **Create Report Organizer** dialog box, enter the name of the new report organizer, and then click **Submit**.  
The report organizer appears in the tree view.
- 4 Move reports into the organizer, or create new reports.

## Cisco UCS reports

---

For each of the following Cisco UCS reports, you can click **Export all** to generate a CSV file showing the data in spreadsheet form.

### Free Memory Slots

This report lists the number of free memory slots in each component grouped by domain. No filtering capability is provided in this report.

#### Report contents

Column	Content
<b>Unnamed column</b>	The domain name.
<b>Server</b>	The component being reported on.
<b>Free Slots</b>	The number of free memory slots on the corresponding component. At the bottom of this column, a list of total free memory slots is displayed.

To export the report as a CSV file, click **Export all**.

### Hardware Inventory

This reports lists the inventory of the UCS devices that are being monitored.

#### Report contents

Column	Content
<b>UCS Manager</b>	The name of the UCS Manager. Clicking the link takes you to the overview page.
<b>Component</b>	Lists components and related sub-components of the device. Clicking a link takes you to the appropriate device component page.
<b>Manufacturer</b>	The manufacturer of the component.
<b>Model</b>	The model number of the component.
<b>Serial #</b>	The serial number of the component.

Column	Content
<b>Description</b>	Detailed information about the component.

To export the report as a CSV file, click **Export all**.

## Device reports

### All Devices

A summary of each device that Resource Manager is monitoring.

Column	Content
<b>Name</b>	The name of the device.
<b>Class</b>	The Resource Manager device class associated with the device.
<b>Product</b>	The hardware model information associated with the device, which is provided by the device's SNMP MIB, or entered manually. If the value in this column is an SNMP OID, the Resource Manager database does not include a definition of the object.
<b>State</b>	The device's production state. Valid states include <code>Production</code> , <code>Pre-Production</code> , <code>Test</code> , and <code>Maintenance</code> .
<b>Ping</b>	The result of the most recent ping of the device.
<b>SNMP</b>	The result of the most recent attempt to gather data through the device's SNMP agent.

### All Monitored Components

A summary of each component Resource Manager is monitoring.

Column	Content
<b>Device</b>	The name of the device which contains the component, with a link to its overview page.
<b>Component</b>	The name of the component, with a link to its overview page.
<b>Type</b>	The class associated with the component.
<b>Description</b>	A description of the component; typically, the component's name.
<b>Status</b>	The state of the component as of the most recent attempt to gather monitoring data.

### Device Changes

A summary of the devices in which changes were detected during the most recent collection of model data.

Column	Content
<b>Name</b>	The name of the changed device, with a link to its overview page.
<b>Class</b>	The Resource Manager device class associated with the device.
<b>First Seen</b>	The timestamp of the initial collection of modeling data for the device.
<b>Collection</b>	The timestamp of the collection in which a change was detected before the most recent collection.
<b>Change</b>	The timestamp of the most recent collection in which a change was detected.

## MAC Addresses (MAC Address Inventory)

A list of the unique device name, interface ID, and MAC address combinations in the Resource Manager database.

Column	Content
<b>Device</b>	The name of a device, with a link to its overview page.
<b>Interface ID</b>	The ID of a network interface, with a link to its overview page.
<b>MAC address</b>	A MAC address.

## Model Collection Age

A summary of devices that were not available for modeling data collection during the most recent 48 hour period.

Column	Content
<b>Name</b>	The name of the changed device, with a link to its overview page.
<b>Class</b>	The Resource Manager device class associated with the device.
<b>First Seen</b>	The timestamp of the initial collection of modeling data for the device.
<b>Collection</b>	The timestamp of the most recent collection of modeling data.
<b>Change</b>	The timestamp of the most recent change in modeling data for the device.

## New Devices

The list of devices that were discovered and added to Resource Manager recently.

Column	Content
<b>Name</b>	The name of the changed device, with a link to its overview page.
<b>Class</b>	The Resource Manager device class associated with the device.
<b>First Seen</b>	The timestamp of the initial collection of modeling data for the device.
<b>Collection</b>	The timestamp of the most recent collection of modeling data.
<b>Change</b>	The timestamp of the most recent change in modeling data for the device.

## Ping Status Issues

A list of the devices which were down during the most recent collection of monitoring data.

Column	Content
<b>Name</b>	The name of the device.
<b>Class</b>	The Resource Manager device class associated with the device.
<b>Product</b>	The hardware model information associated with the device, which is provided by the device's SNMP MIB, or entered manually. If the value in this column is an SNMP OID, the Resource Manager database does not include a definition of the object.
<b>State</b>	The device's production state. Valid states include <code>Production</code> , <code>Pre-Production</code> , <code>Test</code> , and <code>Maintenance</code> .
<b>Ping</b>	The result of the most recent ping of the device.

Column	Content
SNMP	The result of the most recent attempt to gather data through the device's SNMP agent.

## SNMP Status Issues

A list of the devices for which no SNMP agent responded during the most recent collection of monitoring data.

Column	Content
Name	The name of the device.
Class	The Resource Manager device class associated with the device.
Product	The hardware model information associated with the device, which is provided by the device's SNMP MIB, or entered manually. If the value in this column is an SNMP OID, the Resource Manager database does not include a definition of the object.
State	The device's production state. Valid states include <code>Production</code> , <code>Pre-Production</code> , <code>Test</code> , and <code>Maintenance</code> .
Ping	The result of the most recent ping of the device.
SNMP	The result of the most recent attempt to gather data through the device's SNMP agent.

## Software Inventory

A list of the software installed in the devices and components which Resource Manager monitors.

Column	Content
Manufacturer	The name of the company that makes the software product.
Product	The name of the software product.
Count	The total number of devices or components on which the software is installed.

## Enterprise Reports

For each of the following Enterprise reports, you can click **Export all** to generate a CSV file showing the data in spreadsheet form.

### Cisco Inventory

This report lists all the Cisco devices being monitored.

#### Report filtering

Device Class:	<input type="text" value="/Network/Cisco"/>
Group:	<input type="text" value="All"/>
	<input type="button" value="Update"/>

#### Device Class

The device class to use for filtering. The default is `/Network/Cisco`.

#### Group

The specific group to consider when running the report. The default is `All`. The group could be an internal department, a location, a customer, etc.

To generate or refresh the report, click **Update**.

### Report contents

Column	Content
<b>Name</b>	The name of the Cisco device. Clicking the link takes you to the device overview page.
<b>IP Address</b>	Lists the IP address of the Cisco device.
<b>Model</b>	The model of the device. Clicking the link takes you to the Manufacturers Overview page for that product.
<b>Serial #</b>	The serial number of the Cisco device.
<b>Type</b>	The type of Cisco product; for example, Device.

### Customized performance templates

Customized Performance Templates	
Target	Template
<a href="http://www.zenoss.com">www.zenoss.com</a>	<a href="#">Ping Local Copy</a>
<a href="http://github.com">github.com</a>	<a href="#">Device</a>
<a href="http://apache1.zenoss.loc">apache1.zenoss.loc</a>	<a href="#">HttpMonitor</a>
<a href="http://localhost.localdomain">localhost.localdomain</a>	<a href="#">HttpMonitor</a>
<a href="http://oracle1.zenoss.loc">oracle1.zenoss.loc</a>	<a href="#">Device</a>
<a href="#">export all</a>	

### Data Sources in Use

This reports lists the data sources defined in the system.

#### Report contents

Column	Content
<b>Device Class</b>	The device class of the data source in use.
<b>Template</b>	The template associated with the data source in use.
<b>Data Source Name</b>	The name of the data source.
<b>Data Source Type</b>	The type of connection for the data source.
<b>ZenPack</b>	The ZenPack related to the data source.

### Datapoints Per Collector

This report shows the number of devices and data points per collector, which is useful for gauging how much monitoring load is on each collector.

Devices Per Collector				
Hub	Collector	Hostname	Device Count	Datapoint Count
<a href="#">localhost</a>	<a href="#">localhost</a>	localhost	563	45764
export all				

### Report contents

Column	Content
<b>Hub</b>	Name of the hub the collector is on
<b>Collector</b>	Name of the collector the devices are on
<b>Hostname</b>	Hostname location
<b>Device Count</b>	Total number of devices on the collector
<b>Datapoint Count</b>	Total number of data points being generated on the collector

### Defined Thresholds

The Defined Thresholds report provides details about all thresholds defined in the system. The report links to the target of each threshold. The target can be a device class, individual device, or individual component.

This report is useful for administering the system. You can use it to quickly identify which threshold events can occur within the system, and the severity of those events.

### Report contents

Column	Content
<b>Target</b>	The device class of the defined threshold.
<b>Template</b>	The template associated with the defined threshold.
<b>Threshold</b>	The name of the defined threshold. Clicking the link takes you to the Performance Template where the threshold is defined.
<b>Severity</b>	The severity level assigned to the alert when the threshold is reached.
<b>Enabled</b>	The enabled status of the threshold.

### Event Time to Resolution

This report shows, for each user, the total time taken to acknowledge or clear events. Results are organized by user. It is helpful for tracking response time SLAs in a NOC-type environment.

### Report contents

Column	Content
<b>User</b>	The user responsible for taking action on an event.
<b>Severity</b>	The severity of the event.
<b>Time to Ack</b>	The amount of time to acknowledge the event.

Column	Content
<b>Time to Archive</b>	The amount of time to clear and archive the event.

## Interface Utilization

The Interface Utilization report shows the average, maximum, and minimum input and output traffic rate. The report is generated in a tabular form with the calculations shown by each interface.

### Report filtering

Root Organizer:  Device Filter:   
 Start Date:   End Date:    
  Show All Interfaces

The following fields filter the results.

#### Device Class

The device class associated with the interfaces to include in the report. The default is `/Devices/Network`, all network devices.

#### Device Filter

A complete or partial name of the interfaces to include in the report. Letter case is ignored. A partial name matches all interface names that include it. You may also use a regular expression for this filter.

#### Start Date

#### End Date

The first and last dates of the range of dates to include in the report. To select a date from a calendar, click **select**. The default range is the week ending with the current date.

To generate or refresh the report, click **Update**. If you want to show all interfaces on the report, check the **Show All Interfaces** box before clicking **Update**.

### Report contents

Column	Content
<b>Path</b>	The path of the device class.
<b>Device</b>	The name of the device that contains the interface, with a link to its overview page.
<b>Interface</b>	The name of the interface, with a link to its overview page.
<b>Description</b>	A description of the interface.
<b>Speed</b>	The maximum transfer rate the interface supports, per second.
<b>In Avg</b>	The average input traffic through the interface, per second.
<b>Out Avg</b>	The average output traffic through the interface, per second.
<b>In Max</b>	The maximum input traffic through the interface, per second.
<b>Out Max</b>	The maximum output traffic through the interface, per second.
<b>In Min</b>	The minimum input traffic through the interface, per second.
<b>Out Min</b>	The minimum output traffic through the interface, per second.
<b>95% In</b>	Projected date of exhaustion for input traffic.

Column	Content
--------	---------

**95% Out** Projected date of exhaustion for output traffic.

**Note** For the In Max and Out Max values to be calculated, you must have at least eight hours of data; otherwise, a the value N/A is returned.

The following image shows the navigation bar at the bottom of the report. To quickly navigate to other pages, select the device name from the popup list. This example has five pages of results from device 10.171.100.107, and one page of results from device 10.171.100.109, and so on.

Device	Interface	In	Out	95% Out	95% In
10.171.100.107	Ethernet108 1_46	23.3Kb	1.4b	1.4b	3.4b
10.171.100.107	Ethernet108 1_47	22.5Kb	1.4b	1.4b	3.4b
10.171.100.107	Ethernet108 1_48	22.8Kb	1.4b	1.3b	3.0b
10.171.100.107	10.171.100.107	23.8Kb	1.4b	1.3b	3.0b
10.171.100.107	10.171.100.107	22.8Kb	1.4b	1.4b	3.4b
10.171.100.107	10.171.100.107	22.3Kb	1.3b	1.4b	3.2b
10.171.100.107	10.171.100.107	23.7Kb	1.4b	1.3b	3.0b
10.171.100.107	10.171.100.109	22.7Kb	1.4b	1.3b	3.4b
10.171.100.107	10.171.100.14	23.8Kb	1.4b	1.4b	3.3b
10.171.100.107	10.171.100.14	22.9Kb	1.3b	1.4b	3.0b
10.171.100.107	10.171.100.14	23.3Kb	1.4b	1.4b	3.3b
10.171.100.107	10.171.100.88	23.6Kb	1.4b	1.3b	3.1b
10.171.100.107	perf2-switch	23.6Kb	1.4b	1.3b	2.8b

To export the report as a CSV file, click **Export all**.

## Interface Volume

The Interface Volume report shows the total input and output traffic for the report period, along with a calculation of the input and output traffic per day. The report is generated in a tabular form with the calculations shown by each interface.

### Report parameters

Root Organizer:  Device Filter:

Start Date:   End Date:

Show All Interfaces

The following fields filter the results.

#### Device Class

The device class associated with the interfaces to include in the report. The default is /Devices/Network, all network devices.

#### Device Filter

A complete or partial name of the interfaces to include in the report. Letter case is ignored. A partial name matches all interface names that include it. You may also use a regular expression for this filter.

#### Start Date

#### End Date

The first and last dates of the range of dates to include in the report. To select a date from a calendar, click **select**. The default range is the week ending with the current date.

To generate or refresh the report, click **Update**.

### Report contents

Column	Content
--------	---------

**Device** The name of the device that contains the interface, with a link to its overview page.

**Interface** The name of the interface, with a link to its overview page.



Column	Content
<b>Description</b>	A description of the interface.
<b>Speed</b>	The maximum transfer rate the interface supports, per second.
<b>In Vol</b>	The input traffic through the interface for the time period of the report.
<b>In Vol/day</b>	The input traffic through the interface, per day.
<b>Out Vol</b>	The output traffic through the interface for the time period of the report.
<b>Out Vol/day</b>	The output traffic through the interface, per day.
<b>Total Vol</b>	Total volume of traffic through the interface for the time period of the report.

The following image shows the navigation bar at the bottom of the report. To quickly navigate to other pages, select the device name from the popup list. This example has five pages of results from device 10.171.100.107, and one page of results from device 10.171.100.109, and so on.

10.171.100.107	Ethernet108_1_46	23.3Kb	1.4b	1.4b	3.6b	3.4b
10.171.100.107	Ethernet108_1_47	22.5Kb	1.4b	1.4b	3.4b	3.2b
10.171.100.107	Ethernet108_1_48	22.8Kb	1.4b	1.3b	3.0b	3.4b
10.171.100.107	10.171.100.107	23.8Kb	1.4b	1.3b	3.0b	2.9b
10.171.100.107	10.171.100.107	22.8Kb	1.4b	1.4b	3.4b	3.3b
10.171.100.107	10.171.100.107	22.3Kb	1.3b	1.4b	3.2b	3.3b
10.171.100.107	10.171.100.107	23.7Kb	1.4b	1.3b	3.0b	3.0b
10.171.100.107	10.171.100.109	22.7Kb	1.4b	1.3b	3.4b	3.0b
10.171.100.107	10.171.100.114	23.8Kb	1.4b	1.4b	3.3b	3.2b
10.171.100.107	10.171.100.114	22.9Kb	1.3b	1.4b	3.0b	3.4b
10.171.100.107	10.171.100.88	23.3Kb	1.4b	1.4b	3.3b	3.3b
10.171.100.107	perf2-switch	23.6Kb	1.4b	1.3b	3.1b	2.8b

1 of 1017 | 10.171.100.107 | show all | export all | Page Size | 100 | ok

To export the report as a CSV file, click **Export all**.

## Maintenance Windows

This report shows all defined windows that are active during a selected time period.

To change the reporting time period, enter Start and End dates (or click **Select** to select dates from a calendar). Click **Update** to refresh the report.

### Report contents

Column	Content
<b>Name</b>	Name of the maintenance window.
<b>Target</b>	Name of the device.
<b>Start Date</b>	Date the maintenance window becomes active.
<b>Duration</b>	Length of time for the maintenance window to be in effect.
<b>Repeat</b>	Repeat interval of the maintenance window.

## Network Topology

This report shows the layout of the network according to the routes that Resource Manager understands, starting from the collector and ending at the remote devices that are associated with the collector.

### Troubleshooting this report

- The report does not return data if the host on which the Resource Manager collector is running does not have a device created in the device management database (DMD) object that stores the basic model of the network in the Zope database (ZODB).

To resolve this issue, create a device that represents the collector in the DMD, and then run the report again.

- An invalid route entry (for example, `Missing link here` value in the **Route** column) indicates that Resource Manager cannot determine how to route from one device to another.

To resolve this issue:

- 1 Add a network interface to the model (no new hardware is required).
- 2 Add a new route entry from the last device in the route to the device (the IP address shown at the far right of the table).

## Report filtering settings

**Report Settings**

Collectors: localhost ▾

Show valid routes?:

Show invalid routes?:

[Update](#)

### Collectors

Select the collector on which to base the report. Connections from this collector to associated devices is shown in the report.

### Show valid routes?

Select this check box to show valid connections between the selected collector and remote devices.

### Show invalid routes?

Select this check box to show invalid connections between the selected collector and remote devices. An invalid route indicates that a route from the collector to the device could not be determined.

To generate or refresh the report, click **Update**.

## Report contents

Column	Content
<b>Collector</b>	Name of the collector.
<b>Route</b>	Route from the collector to the device.
<b>Device IP Address</b>	IP address of the device.
<b>Device Name</b>	Name of the device.
<b>Repeat</b>	Repeat interval of the maintenance window.

## Notifications and Triggers by Recipient

This report lists all of the notifications that the system has sent.

Column	Content
<b>Name</b>	The recipient name.
<b>Address</b>	The address associated with the recipient.

Column	Content
<b>Notification</b>	The content of the notification.
<b>Triggered by</b>	The trigger that initiated the notification.

## Organizer Availability

This report provides the availability percentage of all network organizers in the system. It can be filtered by organizer, event class, component, event severity, and date.

You can report on the availability of device classes, locations, systems, or groups within a defined time frame. This report offers two reporting modes:

- **Averaged** - Defines the organizer as available for the average availability time for all devices contained in it.
- **Coalesced** - Defines the organizer as available only if all devices are available during a certain time period.

### Report filtering

#### Root Organizer

The device class to use for filtering. The default is `/Devices`.

#### Start Date

#### End Date

The first and last dates of the range of dates to include in the report. To select a date from a calendar, click **select**. The default range is the week ending with the current date.

#### Component

The specific group to consider when running the report. The default is `All`. The group could be an internal department, a location, a customer, etc.

#### Severity

The severity level to filter by. The default is `Critical`. If another level is wanted, select it from the drop-down list.

#### Summation

Select between `Averaged` and `Coalesced` depending on how you want to define the organizer as available. The default is `Coalesced`.

#### Event Class

The event class to use for filtering. The default is `/Status/Ping`.

To generate or refresh the report, click **Update**.

---

**Note** If you export the report, be sure to format the percentage columns to show percentages instead of decimal values.

---

## Report contents

Column	Content
<b>Name</b>	Name of the device class based on the root organizer selected.
<b>Availability</b>	Percent availability of the selected event class.
<b>Total</b>	Total availability of the selected event class.

## Organizer Graphs

This reports shows graphical data about a given organizer. The information displayed varies depending on the type of organizer. For example, selecting `/Devices/Network/Cisco` as an organizer displays graphs on CPU and Memory Utilization, Throughput, Errors, etc.

### Report filtering

**Organizer Graphs Filtering**

Organizer:  Filter:  Start:   End:

#### Organizer

The class to use for filtering. The default is `/Groups`.

#### Filter

Additional text filter to refine results. The default is `.*` which returns all graphs available for the selected organizer.

#### Start Date

#### End Date

The first and last dates of the range of dates to include in the report. To select a date from a calendar, click **select**. The default range is the week ending with the current date.

To generate or refresh the report, click **Update**.

## User Event Activity

A list of users or groups and the number of events each has acknowledged and archived.

### Report filtering

Start:   End:   Group By:  User  Group

The following fields define the report.

#### Start Date

#### End Date

The first and last dates of the range of dates to include in the report. To select a date from a calendar, click **select**. The default range is the week ending with the current date.

#### Group By

The type of report to create, **User** or **Group**.

To generate the report, click **Update**.

## Report contents

Column	Content
<b>User or Group</b>	The column label and content depend on the report selection. <b>User</b> The name of a user, with a link to the user's <b>USER SETTINGS</b> page. <b>Group</b> The name of a group, with a link to the group's <b>Users in Group</b> page.
<b># Acknowledged</b>	The total number of events acknowledged by the user or group during the reporting period.
<b># Archived</b>	The total number of events archived (cleared) by the user or group during the reporting period.

## Users Group Membership (User to Group Mapping)

A list of Resource Manager users and the groups to which they belong.

Column	Content
<b>User</b>	The name of a user, with a link to the user's <b>USER SETTINGS</b> page.
<b>Groups</b>	The list of groups to which the user belongs. Each name includes a link to the group's <b>Users in Group</b> page.

## Event reports

### All EventClasses (All Event Classes)

A list of each item in the event hierarchy in Resource Manager. Each item (class) includes the total number of subclasses, instances, and events associated with the class.

Column	Content
<b>Name</b>	The event class name.
<b>Sublasses</b>	The total number of subclasses associated with the event class.
<b>Instances</b>	The total number of instances of the class and its subclasses.
<b>Events</b>	The total number of events associated with the class.

### All EventMappings (All Event Mappings)

A list of each item in the event mapping hierarchy in Resource Manager. Each item (event mapping) includes its key and example text, and a count of the events associated with the event mapping.

Column	Content
<b>Name</b>	The name of the event mapping, which includes its location in the event class hierarchy, and its key.
<b>EventClassKey</b>	The unique identifier of the event mapping.
<b>Evaluation</b>	A portion of the example associated with the event mapping.
<b>Events</b>	The total number of events associated with the event mapping.

## All Heartbeats

A list of all Resource Manager daemons, showing the number of seconds elapsed since each daemon sent a heartbeat event.

Column	Content
Device	The device on which the daemon is running.
Component	The name of the daemon.
Seconds	The number of seconds elapsed since the daemon sent a heartbeat event.

## Performance reports

---



### Availability Report

Shows the percentage of time that a device is considered available. You can filter this report on a variety of criteria, including by a time period.

#### Report filtering

Device Class:	/	▼	Systems:	/	▼
Groups:	/	▼	Locations:	/	▼
Device Filter:					
Start Date:	07/17/2017	select	Severity:	Error	▼
Event Class:	/Status/Ping	▼	End Date:	07/24/2017	select
<a href="#">Generate</a>					

#### Device Class

The device class to use for filtering. The default is / (all device classes).

#### Systems

Select the systems to filter by. The default is / (all systems).

#### Groups

Select the groups to filter by. The default is / (all groups).

#### Locations

Select the locations to filter by. The default is / (all locations).

#### Device Filter

Enter the name of the device to filter by.

#### Severity

The severity level used in the availability calculation described below. The default is `Critical`. If another level is wanted, select it from the drop-down list.

#### Start Date

#### End Date

The first and last dates of the range of dates to include in the report. To select a date from a calendar, click **select**. The default range is the week ending with the current date.

#### Event Class

The event class to use for filtering. The default is `/Status/Ping`.

To generate or refresh the report, click **Generate**.

---

**Note** If you export the report by clicking **Export all**, be sure to format the percentage columns to show percentages instead of decimal values.

---

The percent availability value is calculated by first summing the duration of all events of a particular class with a production state of `Production` and with a severity greater than or equal to a specified severity in the filter criteria. This sum is then divided by the total duration of the time range, and then subtracted from 1 and multiplied by 100 to get the percent available, as in the following equation:

$$1 - ((\text{Total event down time}) / (\text{total duration})) * 100$$

**Note** Events whose `firsttime` and `lasttime` fields are the same are not used in the calculation. These could represent an event that occurs and is subsequently cleared by the next event, or an event that has happened only once in the specific date range.

### Report contents

Column	Content
Device	Name of the device based on the filter parameters selected.
Systems	Systems name if applicable to the filter.
Availability	Total availability of the selected devices.

## CPU Utilization

Shows monitored devices, load averages, % utilization, and forecasted exhaustion. You can customize start and end dates.

### Report filtering

Root Organizer:	<input type="text" value="/Devices"/>	Device Filter:	<input type="text"/>
Start Date:	<input type="text" value="07/17/2017"/> <input type="button" value="select"/>	End Date:	<input type="text" value="07/24/2017"/> <input type="button" value="select"/>
Summary Type:	<input type="text" value="Average"/>	Consolidation:	<input type="text" value="Average"/>
Trendline Type:	<input type="text" value="Linear"/>		
<input type="button" value="Generate"/>			

### Root Organizer

The device class to use for filtering. The default is `/Devices`.

### Device Filter

Enter the name of the device to filter by.

### Start Date

### End Date

The first and last dates of the range of dates to include in the report. To select a date from a calendar, click **select**. The default range is the week ending with the current date.

### Summary Type

Possible values include: `Average`, `Maximum`, `Minimum`, and `Last`.

### Consolidation

Possible values include: `Average` and `Max`.

### Trendline Type

Projection algorithm used in `Forecasted % Util Exhaustion` calculation. Possible value: `Linear`

To generate or refresh the report, click **Generate**.

---

**Note** If you export the report by clicking **Export all**, be sure to format the percentage columns to show percentages instead of decimal values.

---

This report uses data point aliases. (For more information about data point aliases, see [Data point aliases](#) on page 115.) To add data points to a report, add the alias, and then ensure the values return in the expected units.

Alias	Expected Units
loadAverage5min	Processes
cpu_pct	Percent

### Report contents

Column	Content
<b>Device</b>	Name of the device based on the filter parameters selected.
<b>Load Avg</b>	Average load on the device.
<b>% Util</b>	% CPU utilization on the device
<b>Forecasted % Util Exhaustion</b>	The amount of time before the exhaustion threshold will be breached.

---

## Filesystem Util Report

Shows mount point, total bytes, used bytes, free bytes, and percentage of utilization for each device. You can customize start and end dates and summary type.

### Report filtering

Root Organizer:	<input type="text" value="/Devices"/>	Device Filter:	<input type="text"/>
Start Date:	<input type="text" value="07/17/2017"/> <input type="button" value="select"/>	End Date:	<input type="text" value="07/24/2017"/> <input type="button" value="select"/>
Summary Type:	<input type="text" value="Average"/>		
<input type="button" value="Generate"/>			

---

#### Root Organizer

The device class to use for filtering. The default is `/Devices`.

#### Device Filter

Enter the name of the device to filter by.

#### Start Date

#### End Date

The first and last dates of the range of dates to include in the report. To select a date from a calendar, click **select**. The default range is the week ending with the current date.

#### Summary Type

Possible values include: `Average`, `Maximum`, `Minimum`, and `Last`.

To generate or refresh the report, click **Generate**.

---

**Note** If you export the report by clicking **Export all**, be sure to format the percentage columns to show percentages instead of decimal values.

---

This report uses data point aliases. (For more information about data point aliases, see [Data point aliases](#) on page 115.) To add datapoints to a report, add the alias, and then ensure the values return in the expected units.



Alias	Expected Units
usedFilesystemSpace__bytes	bytes

### Report contents

Column	Content
<b>Device</b>	Name of the device based on the filter parameters selected.
<b>Mount</b>	File systems mount point. Click the link to be taken directly to the device's components page.
<b>Total bytes</b>	Amount of total bytes
<b>Used bytes</b>	Amount of used bytes
<b>Free bytes</b>	Amount of free bytes
<b>% Util</b>	Percent utilization

## Interface Utilization

Shows the traffic through all network interfaces monitored by Resource Manager.

### Report filtering

Root Organizer:	<input type="text" value="/Devices"/>	Device Filter:	<input type="text"/>
Start Date:	<input type="text" value="07/17/2017"/> <input type="button" value="select"/>	End Date:	<input type="text" value="07/24/2017"/> <input type="button" value="select"/>
Summary Type:	<input type="text" value="Average"/>		
<input type="button" value="Generate"/>			

### Root Organizer

The device class to use for filtering. The default is /Devices.

### Device Filter

Enter the name of the device to filter by.

### Start Date

### End Date

The first and last dates of the range of dates to include in the report. To select a date from a calendar, click **select**. The default range is the week ending with the current date.

### Summary Type

Possible values include: Average, Maximum, Minimum, and Last.

To generate or refresh the report, click **Generate**.

**Note** If you export the report by clicking **Export all**, be sure to format the percentage columns to show percentages instead of decimal values.

This report uses data point aliases. (For more information about data point aliases, see [Data point aliases](#) on page 115.) To add data points to a report, add the alias, and then ensure the values return in the expected units.

Alias	Expected Units
inputOctets__bytes	bytes/sec
outputOctets__bytes	bytes/sec

## Report contents

Column	Content
<b>Device</b>	Name of the device based on the filter parameters selected.
<b>Interface</b>	Name of interface. Click the link to be taken to the Device Components page.
<b>Speed</b>	The interface's rated bandwidth, in bits per second
<b>Input</b>	Average traffic coming in to the interface, in bits per second
<b>Output</b>	Average traffic going out of the interface, in bits per second
<b>Total</b>	Total average traffic across the interface, in bits per second
<b>% Util</b>	Percentage of the interface's bandwidth consumed

## Memory Utilization

Provides system-wide information about the memory usage for devices in Resource Manager.

### Report filtering

Root Organizer:	<input type="text" value="/Devices"/>	Device Filter:	<input type="text"/>
Start Date:	<input type="text" value="07/17/2017"/> <input type="button" value="select"/>	End Date:	<input type="text" value="07/24/2017"/> <input type="button" value="select"/>
Summary Type:	<input type="text" value="Average"/>	Consolidation:	<input type="text" value="Average"/>
Trendline Type:	<input type="text" value="Linear"/>		
<input type="button" value="Generate"/>			

### Root Organizer

The device class to use for filtering. The default is /Devices.

### Device Filter

Enter the name of the device to filter by.

### Start Date

### End Date

The first and last dates of the range of dates to include in the report. To select a date from a calendar, click **select**. The default range is the week ending with the current date.

### Summary Type

Possible values include: Average, Maximum, Minimum, and Last.

### Consolidation

Possible values include: Average and Max.

### Trendline Type

Projection algorithm used in Forecasted % Util Exhaustion calculation. Possible value: Linear

To generate or refresh the report, click **Generate**.

**Note** If you export the report by clicking **Export all**, be sure to format the percentage columns to show percentages instead of decimal values.

The report uses data point aliases. (For more information about data point aliases, see [Data point aliases](#) on page 115.) To add data points to the report, add the alias, and then ensure the values return in the expected units.

Alias	Expected Units
memoryAvailable__bytes	bytes

Alias	Expected Units
memoryBuffered__bytes	bytes
memoryCached__bytes	bytes

### Report contents

Column	Content
<b>Device</b>	Name of the device based on the filter parameters selected.
<b>Total</b>	Amount of total memory
<b>Available</b>	Amount of available memory
<b>Cache Memory</b>	Amount of cache memory
<b>Buffered Memory</b>	Amount of buffered memory
<b>% Util</b>	% memory utilization on the device
<b>Forecasted % Util Exhaustion</b>	The amount of time before the exhaustion threshold will be breached.

## Threshold Summary

Provides information about the devices that are approaching or exceeding their thresholds.

### Report filtering

Start Date: 07/17/2017	<input type="button" value="select"/>	End Date: 07/24/2017	<input type="button" value="select"/>	Event Class: /Perf	<input type="button" value="▼"/>
<input type="button" value="Generate"/>					

#### Start Date

#### End Date

The first and last dates of the range of dates to include in the report. To select a date from a calendar, click **select**. The default range is the week ending with the current date.

#### Event Class

The device class to use for filtering. The default is */Perf*.

To generate or refresh the report, click **Generate**.

**Note** If you export the report by clicking **Export all**, be sure to format the percentage columns to show percentages instead of decimal values.

### Report contents

Column	Content
<b>Device</b>	Name of the device based on the filter parameters selected.
<b>Component</b>	Network interface component name, if applicable.
<b>Event Class</b>	Event class that had a threshold breach.

Column	Content
Count	Number of times a threshold was breached.
Duration	Amount of time that a threshold was breached.
%	Percentage of time that the threshold was breached for the report's time period.

## Graph reports

Graph reports allow you to assemble graphs from devices and device components into a single report. Graph reports only display those graphs that already exist on devices or components in the system. You cannot define or alter graphs in a graph report.

Graph reports are available in two views: a "normal" view (similar to the graph views for devices and device classes) and a print view.

**Figure 131: Sample graph report**

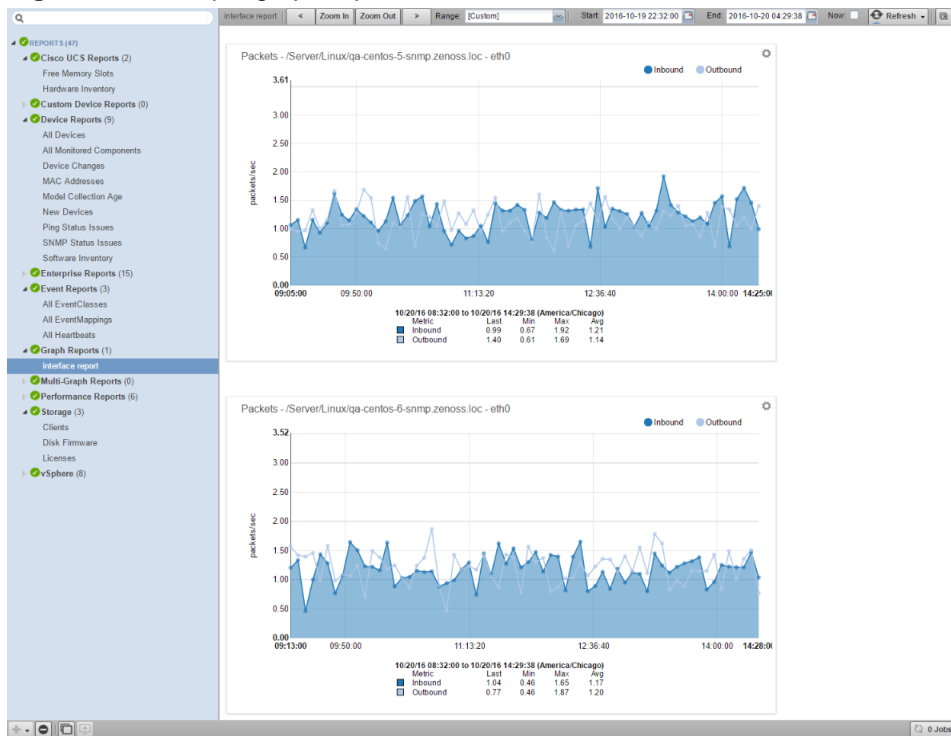

## Creating a graph report

To create a graph report:

- 1 Navigate to **REPORTS > Graph Reports**
- 2 Click **Add** and select **Add Graph Report** from the popup menu.
- 3 Enter a name for the report in the Create Graph Report dialog box and click **SUBMIT**.
- 4 In the Edit Report screen, verify or edit the following information in the Graph Report section:
  - **Name:** The name of the report as defined in the Create Graph Report dialog box.
  - **Title:** Enter a descriptive title to display in the list of reports for the report organizer.
  - **Number of Columns:** Specify the number of columns (1-3) in which graphs will be displayed on the report.

- **Comments:** Enter comments to display at the top of the printable version of the report. This is a TALEs evaluated string that can contain HTML formatting. The variables available to the TALEs expression are:
    - `now` (current date and time)
    - `report` (report object)
- 5 Click **Save** to save the new graph report.
  - 6 In the Add New Graph section, fill in the appropriate information to add a graph to the report:
    - **Device:** Select the one or more devices. You can narrow the list of devices by entering a search string and clicking **Filter**.
    - **Component:** Optionally, select one or more components from the **Component** list. This list displays the names of all components defined on at least one of the selected device. If you want to see the complete component path in the system to help with identification, select the **Show component path** check box.
  - 7 Select one or more graphs from the Graph list. This list displays the names of all the graphs available for the selected devices; or, if you have selected one or more components, the graphs available for the components.
  - 8 Click **Add Graph to Report**. The selected graphs are displayed in the Graphs section. You can resequence or delete graphs using the **Action** icon.

The screenshot shows the 'Add New Graph' interface. It has three main sections: Device, Component, and Graph. The Device section has a search box with 'Filter' and a list of devices including '10.87.254.1', 'Cisco\_10.171.100.14', 'CUSQU1001CN3B5', 'N1kv-Orch', 'N6001-2', 'nexus-5k.zenoss.loc', 'perf2-switch.zenoss.loc', and 'perf3-switch.zenoss.loc'. There is a 'Show component path' checkbox. The Component section has a list including '32 port Modular Universal Port Supervisor in Fixed Module-1', 'bfs-esx1', 'bfs-esx2', 'default', and 'ESXi\_4\_8\_SAN'. The Graph section has a list including 'CPU Utilization', 'Memory Utilization', and 'Power Consumption'. At the bottom is an 'Add Graph to Report' button.

Below the 'Add New Graph' section is a 'Graphs' section with a gear icon and a table:

Seq	Name	Device	Component	Graph
0	<input type="checkbox"/> <a href="#">nexus-5k.zenoss.loc 32 port Modular Universal Port Supervisor in Fixed Module-1 CPU Utilization</a>	nexus-5k.zenoss.loc	32 port Modular Universal Port Supervisor in Fixed Module-1	CPU Utilization

Graph reports maintain a static list of graphs. This list does not automatically change when graphs are added or deleted from monitoring templates. For example, you have two devices with associated graphs:

- DeviceA: Has a single graph (Graph1)
- Device B: Has two graphs (Graph1 and Graph2)

If you select DeviceA and DeviceB on the Graph Report edit page, the list of graphs will include Graph1 and Graph2. If you select both graphs and add them to the report, you will see three graphs:

- DeviceA - Graph1
- Device B - Graph1
- Device B - Graph2

If, at a later time, you create a second graph (Graph2) on DeviceA's monitoring templates, that new graph will not automatically appear on the graph report. You must edit the report to add it. Similarly, if you later remove a graph from DeviceB's template (or even delete DeviceB from the system), you must manually remove the graph (or device) from the graph report.

## Working with graph reports

You can customize the display of the graphs contained in any graph report you've created. You can change the graph name by clicking on the graph name in the Graphs section of the Edit Report screen. You can also edit the text that appears with the graph when viewing the report:

- **Summary:** Displays above the graph in the normal report view. It may contain TALES expressions with these variables:
  - dev - Device
  - comp - Component
  - graph - Graph
- **Comments:** Displays to the left of the graph in the printable view. May contain TALES expressions with these variables:
  - dev - Device
  - comp - Component
  - graph - Graph

On the Graph report, you can control the information displayed by selecting the Range of data to display or by clicking the **Zoom In/Zoom Out** controls. Using this latter method, automatically adjusts the data range to Custom and you can fine-tune your date range.

## Multi-Graph reports

---

Multi-graph reports combine data from different devices and components into a single report. You can create a graph definition and have it drawn once for each of a group of devices and components that you define. Alternatively, you can combine the data for those graphs into a single graph.

The groups of devices and components you assemble are called "collections". Specifying the graph definition to apply to collections is done through graph group objects. Multi-graph reports include their own graph definitions, and thus do not use the graph definitions that are defined in monitoring templates. To create a report that includes graphs defined on templates, use a Graph report instead.

## Creating a multi-graph report

- 1 Navigate to **REPORTS > Multi-Graph Reports**
- 2 Click **Add** and select **Add Multi-Graph Report** from the popup menu.
- 3 Enter a name for the report in the Create Multi-Graph Report dialog box and click **SUBMIT**.
- 4 In the report edit page, enter or select values for the following:
  - **Name:** The name of the report as defined in the Create Multi-Graph Report dialog box.
  - **Title:** Enter a descriptive title to display in the list of reports for the report organizer.
  - **Number of Columns:** Specify the number of columns (1-3) in which graphs will be displayed on the report.
- 5 Click **Save**.
- 6 Add one or more of the following to define the source you want to graph:

- **Collections:** Contain the devices and components you want to graph.
- **Graph Definitions:** Describe the graphs you want on the report.
- **Graph Groups:** Specify the collections and graph definition to use.

**Figure 132:** Multi-Graph Report Edit page

State at time: 2016/10/20 21:05:39

Name: test\_multi\_graph\_report

Title:

Number of Columns: 1

Save

**Collections** [gear icon]

Name	Number of Items
------	-----------------

**Graph Definitions** [gear icon]

Name	Graph Points	Units	Height	Width
------	--------------	-------	--------	-------

**Graph Groups** [gear icon]

Seq	Name	Collection	Graph Definition
-----	------	------------	------------------

## Adding collections

A collection comprises one or more collection items. A collection item can be a list of device classes, systems, groups, locations, or specific devices or components. A single collection may contain as many collection items as desired. A multi-graph report must contain at least one collection. Collections are shown in the Collections area of the report's Edit page.

To create a collection:

- 1 In the **Collections** area of the multi-graph report Edit page, click the **Action** icon and select **Add Collection**. The Add a Collection dialog box appears.
- 2 Enter a name for the collection, then click **OK**. The Multi-Graph Report Collection dialog box appears.

**Figure 133:** Multi-Graph report collection

State at time: 2016/10/20 21:09:44

Name: test\_collection

Save

**Add To Collection**

Item Type: Device Class

Device Class: /Discovered, /Network, /Server, /Printer, /Power, /KVM, /Ping, /HTTP, /Storage, /Web

Include Suborganizers?: True

Add to Collection

**Collection Items** [gear icon]

Seq	Name	Item Description	Number of Devices/Components
-----	------	------------------	------------------------------

- 3 In the Add To Collection area, select collection items to add to the collection:
  - a Select a value for Item Type. If you select either Device Class, System, Group, or Location, then you can select one or more of the organizers to include in the collection. If you select Specific Device/Component, you will be able to choose from a list of all the devices in the system. You can use the Filter field to narrow the selection process. Selecting one or more devices will display a list of component names that apply to the selected devices.

- b Select a value for **Include Suborganizers?**. If `true`, the collection will also include all organizers recursively beneath the selected organizer. These collection items are dynamic, when devices are added or removed from the organizers, they will appear or disappear from the report.
- 4 Click **Add to Collection** to create a new collection item for each of the selected organizers or specific device. The collection item appears in the Collection Items area. If desired, you can re-order collection items. Their listed order determines the order in which the graphs are drawn, or the order that data is drawn on a combined graph.

## Adding graph definitions

In the context of multi-graph reports, graph definitions are very similar to those in monitoring templates. Settings on the graph definition define basic parameters. Graph points are added to specify which data should be drawn. (For more information on creating graph definitions, see [Performance Graphs](#) on page 126.)

The most significant differences between graph definitions in the two contexts is how data point graph points and threshold graph points are added. When adding a data point graph point to a graph definition in a performance template, you can select from a list of data points that are defined on that template. In the context of a multi-graph report, there are no graph point definitions listed. You must enter the name of the data point on the data point graph point dialog.

- 1 Click the **Action** icon in the Graph Definitions area of the Graph edit page and select **Add Graph**. The Add a New Graph dialog box appears.
- 2 Enter a name for the graph, then click **OK**. The Edit Graph Definition page appears.

**Figure 134:** Multi-Graph Report Graph Definition

- 3 Make any changes to the graph definition values displayed, then click **Save**.
- 4 Click the **Action** icon in the Graph Points section to perform the following:
  - Add data points (see next topic)
  - Add thresholds
  - Add a custom graph point
  - Delete a graph point
  - Re-sequence graph points

### Adding data points

To add a data point to a graph definition:

- 1 Ensure that you have created a graph definition as part of your multi-graph report.
- 2 On the Graph Definition page, click the **Action** icon in the Graph Points section and select **Add DataPoint**.
- 3 Enter a DataPoint Name. The field will auto-populate based on your entry. Click **OK** to save the name.



- 4 Click the name of the graph point you want to define. The Edit screen appears.

**Figure 135: Edit DataPoint**

State at time: 2016/11/03 16:40:51

Name: usedBlocks

Type: DataPoint

DataPoint: disk\_usedBlocks

Consolidation: AVERAGE

RPN:  $\${here/getTotalBlocks},/,100,*$

Limit: -1

Line Type: Line

Line Width: 1

Stacked: False

Color (Hex value RRGGBB):

Format: %5.2lf%s

Legend:  $\${here/name | here/id} \${graphPoint/id}$

Save

Available RRD Variables: None

- 5 Edit the fields based on your datapoint and the way you want data displayed. You can enter a custom RPN expression on this screen if needed.
- 6 Click **Save**.

## Adding graph groups

Graph groups combine a graph definition with a collection to produce graphs for the report. In order for the report to show graphs, at least one graph group must be created.

To create a graph group:

- 1 Click the **Action** icon in the Graph Groups area of the Graph edit page and select **Add Group**. The Add a New Graph Group dialog box appears.
- 2 Enter a name for the graph group, then click **OK**. The Edit Graph Group Definition page appears.

**Figure 136: Multi-Graph Report Graph Group**

State at time: 2016/10/20 21:14:44

Name: test\_graph\_group

Collection: test\_collection

Graph Definition: test\_graph

Method: Separate graph for each device

Save

- 3 Make any changes to the graph group values displayed:
  - **Name:** Identifies the graph group on the multi-graph report page. It does not appear on the report.
  - **Collection:** Select a collection that has been defined for this report.
  - **Graph Definition:** Select a graph definition that has been defined for this report.
  - **Method:** Choose between having the graph drawn once for each device and component in the collection or combining the data from all devices and components into a single graph. Options are:

- **Separate graph for each device:** The graph definition is used to draw one graph for each device and component in the collection. Graphs will appear in the list in the same order they are specified in the collection.
  - **All devices on a single graph:** Draws one graph with the data from all devices and components included.
- 4 Click **Save** to save the graph group.

### Re-sequencing graph group order

Graph groups are drawn in the order listed on the multi-graph report Edit page. To change the order of the graph groups:

- 1 On the Multi-Graph Edit Report page, edit the sequence order numbers (0, 1, 2, etc.) next to the graph groups that you've defined.
- 2 From the **Action** icon, select **Re-sequence items**.  
The page refreshes and displays the graph groups in the re-sequenced order.

---

**Note** If a graph group results in multiple graphs, the graphs are drawn in the order that the collection items are listed in the corresponding collection. If a collection item specifies a device organizer, the order of devices drawn from that collection item is indeterminate.

---

## Creating a custom device report

---

To create a custom device report:

- 1 Navigate to **REPORTS > Custom Device Reports**
- 2 Click **Add** and select **Add Custom Device Report** from the popup menu.
- 3 Enter a name for the report in the Create Custom Device Report dialog box and click **SUBMIT**.
- 4 Define the following report parameters:
  - **Name:** Edit the report name if needed.
  - **Title:** Enter the report title. This title is displayed in the report and is distinct from the report name.
  - **Path:** Specify the path in the hierarchy where you want the system to store the report.
  - **Query:** Specify the actual query string for the report. For example, if you want to limit the report to just those devices with a serial number, you can set the query value to:
 

```
here.hw.serialNumber != ""
```
  - **Sort Column:** Specify the column on which you want to sort the report by default.
  - **Sort Sense:** Specify the sense that the system uses to sort: `asc` (ascending sort) or `desc` (descending sort)
  - **Columns:** Specify the data to be retrieved and displayed in the report. For example you could specify:
    - `getID`: Gets the name of any device.
    - `getManageIp`: Gets the IP addresses of the devices.
    - `getHWSerialNumber`: Gets the serial numbers of the devices.

---

**Note** For a complete list of valid options, refer to the information on the Device schema in [TALES expressions](#) on page 247.

---

## Scheduling reports

By default, all reports run on demand, presenting information in the browser interface when you run the report. You can also schedule a report to be run using the `reportmail` command line tool. You can select a report to generate and email its output to a list of recipients. Ensure that an SMTP server is configured for your environment.

To schedule a report using `reportmail`:

- 1 Log in to the Resource Manager browser interface and click **REPORTS**.
- 2 Take note of the report name you want to schedule and the folder it is in. You will need this information later in this procedure. For example, `MAC Addresses` report in the `Device Reports` folder.
- 3 Log in to the Control Center master host as a user with `serviced` CLI privileges.
- 4 Adapt the following command for your environment:

```
serviced service run zope reportmail run -u "http://localhost:8080/
zport/dmd/Reports/FolderName/ReportName" -U user -p password -
a emailaddress -f emailaddress
```

The URL must use `localhost:8080`. Use `%20` for a space in the URL. A more real-world example:

```
serviced service run zope reportmail run -u "http://localhost:8080/
zport/dmd/Reports/Device%20Reports/MAC%20Addresses" -U admin -p Pa$
$w@rd -a managers@example.com -f craig@example.com
```

The following table lists all the arguments available for the `reportmail` command:

**Table 7: Reportmail command line arguments**

Argument	Description
<code>-u URL, --url=URL</code>	Uniform Resource Locator of the report to send. This can also be the URL of any other page in the system. Use <code>localhost:8080</code> as the domain. Use <code>%20</code> for the space character.
<code>-U USER, --user=USER</code>	User to log in to the system. This user must have permission to view the supplied URL.
<code>-p PASSWD, --passwd=PASSWD</code>	Password to log in to the system.
<code>-a ADDRESS, --address=ADDRESS</code>	Email address for report delivery (may be given more than once). Default value comes from the user's profile.
<code>-s SUBJECT, --subject=SUBJECT</code>	Subject line for email message. Default value is the title of the page.
<code>-f FROMADDRESS, --from=FROMADDRESS</code>	Origination address for the email being sent.
<code>-d DIV, --div=DIV</code>	DIV to extract from the HTML at URL. The default value is <code>contentPane</code> , which works for all default reports.
<code>-c COMMENT, --comment=COMMENT</code>	Comment to include in the body of CSV reports. This is used only if the URL returns comma-separated value data. Most default reports can return

Argument	Description
	CSV-formatted data by appending <code>?doExport</code> to the end of the URL.

# ZenPacks

---

# 16

ZenPacks extend and modify the system to add new functionality. This can be as simple as adding new device classes or monitoring templates, or as complex as extending the data model and providing new collection daemons.

You can use ZenPacks to add:

- Monitoring templates
- Data sources
- Graphs
- Event classes
- User commands
- Reports
- Model extensions
- Product definitions

Simple ZenPacks can be created completely within the user interface. More complex ZenPacks require development of scripts or daemons, using Python or another programming language.

ZenPacks can be distributed for installation on other Resource Manager systems.

## Displaying the list of installed ZenPacks

---

You can display installed ZenPacks by using the browser interface or the command-line interface (CLI).

### Displaying installed ZenPacks in the browser interface

- 1 In the Resource Manager browser interface, select the **ADVANCED** tab.

---

**Note** The action menu in the left column does not include an option to create a ZenPack. For more information, see [Creating a ZenPack](#) on page 217.

---

- 2 In the left column, select **ZenPacks**.

The following figure shows an example list of ZenPacks.

Pack	Package	Author	Version	Egg
<a href="#">ZenPacks.zenoss.AdvancedSearch</a>	zenoss	Zenoss	1.1.4	Yes
<a href="#">ZenPacks.zenoss.AixMonitor</a>	zenoss	Zenoss	1.3.0	Yes
<a href="#">ZenPacks.zenoss.ApacheMonitor</a>	zenoss	Zenoss	2.1.4	Yes
<a href="#">ZenPacks.zenoss.AuditLog</a>	zenoss	Zenoss	1.3.0	Yes
<a href="#">ZenPacks.zenoss.BigIpMonitor</a>	zenoss	Zenoss	2.6.3	Yes
<a href="#">ZenPacks.zenoss.BrocadeMonitor</a>	zenoss	Zenoss	2.1.1	Yes
<a href="#">ZenPacks.zenoss.CatalogService</a>	zenoss	Zenoss	3.0.9	Yes
<a href="#">ZenPacks.zenoss.CheckPointMonitor</a>	zenoss	Zenoss	2.0.0	Yes
<a href="#">ZenPacks.zenoss.CiscoMonitor</a>	zenoss	Zenoss	5.3.1	Yes
<a href="#">ZenPacks.zenoss.CiscoUCS</a>	zenoss	Zenoss	1.9.1	Yes
<a href="#">ZenPacks.zenoss.ControlCenter</a>	zenoss	Zenoss	1.0.0	Yes
<a href="#">ZenPacks.zenoss.Dashboard</a>	zenoss	Zenoss	1.0.3	Yes
<a href="#">ZenPacks.zenoss.DellMonitor</a>	zenoss	Zenoss	2.2.0	Yes

## Displaying installed ZenPacks in the CLI

To perform this procedure, you need a user account with `serviced` command-line interface (CLI) privileges on the Control Center master host.

- 1 Log in to the Control Center master host as a user with `serviced` CLI privileges.
- 2 Display the list of installed ZenPacks:

```
serviced service run zope zenpack list
```

## ZenPack information resources

Zenoss provides numerous ZenPacks that add and extend system functionality. In the Resource Manager browser interface, the question mark icon provides a link to the documentation of the included ZenPacks. The [ZenPack catalog](#) provides detailed descriptions of all ZenPacks that are developed by Zenoss.

You can create your own ZenPacks or download and install ZenPacks that are developed by others. For more information, see the following ZenPack resources:

- [ZenPack SDK](#)
- [Zenoss Community](#), which includes a ZenPack development forum
- [Public Zenoss repositories on GitHub](#)

## Preparing to install or upgrade a ZenPack

Perform this procedure to minimize the amount of time that Resource Manager is unavailable during a ZenPack installation or upgrade.

- 1 Log in to your workstation and start a web browser.
- 2 Download the ZenPack to install or upgrade from the [Zenoss Support](#) site.  
Contact your Zenoss representative for login credentials.
- 3 Copy the ZenPack `egg` file to a local directory on the Control Center master host.
  - a Create a directory for the ZenPack `egg` file.  
The directory must be local (not mounted).

The following command creates a directory in /tmp:

```
mkdir /tmp/zenpack
```

- b** Use a file transfer command or utility to copy the file.
- c** Set full permissions on the directory and files:

```
chmod -R 0777 /tmp/zenpack
```

#### 4 Optional: Install ZenPack dependencies.

A ZenPack might require packages or other software not included in the ZenPack egg file. To ensure that the dependencies are available, perform the following substeps:

- a** Log in to the Control Center master host as a user with Control Center CLI privileges.
- b** Start an interactive shell in a Zope service container.

In the following command, the `-s` flag saves and tags the changes that you make. Replace *MyTag* with a short name that describes the dependencies that you are installing.

```
serviced service shell -i -s MyTag zope bash
```

The `serviced` daemon starts a Bash shell and logs you in as the `root` user.

- c** Install required dependencies.

For example, to install the `terminus` font for X Windows in Ubuntu Linux, enter the following command:

```
apt-get install xfonts-terminus
```

Enter any number of commands to install the required dependencies.

- d** Return to the Control Center master host shell session:

```
exit
```

- e** Create a snapshot and commit your changes:

```
serviced snapshot commit MyTag
```

- f** Restart all Resource Manager application services:

```
serviced service restart Zenoss.resmgr/Zenoss
```

## Installing or upgrading a ZenPack

Before you begin, review the following requirements and considerations:

- Complete the steps in [Preparing to install or upgrade a ZenPack](#) on page 214.
  - Do not use this procedure to install or upgrade the Zenoss Service Impact ZenPacks, *ZenPacks.zenoss.ImpactServer* and *ZenPacks.zenoss.Impact*. For more information, refer to the *Zenoss Resource Manager Installation Guide*.
- 1 Log in to the Control Center master host as a user with Control Center CLI privileges.
  - 2 Create a snapshot:

```
serviced service snapshot Zenoss.resmgr
```

On completion, the `serviced` command returns the ID of the new snapshot. If the installation of the ZenPack ends up failing, you can restore the snapshot you took in this step. For detailed instructions on restoring a snapshot, refer to the *Control Center Reference Guide*.

- 3 Change directory to the directory in which the ZenPack egg file is located.  
For example:

```
cd /tmp/zenpack
```

- 4 Install the ZenPack:

```
serviced service run zope zenpack-manager install ZenPack-File.egg
```

Daemons that a ZenPack provides are packaged in Docker containers and installed as child services of the current instance of Resource Manager.

- 5 Restart all Zenoss services:

```
serviced service restart Zenoss.resmgr/Zenoss
```

## Removing a ZenPack

---

Removing a ZenPack can have unexpected consequences, and often, the safest choice is not to remove a ZenPack. Before you begin, review the following requirements and considerations:

- Removing a ZenPack removes all objects provided by the ZenPack and all objects that depend on code provided by the ZenPack.
- Removing a newer version of a ZenPack to install an older version fails if the newer version includes migration code.
- Removing a ZenPack that installs a device class removes the device class, any contained device classes, and all devices in that class.
- Some ZenPacks provide services upon which other ZenPacks rely. Make sure the service you remove is not needed by another ZenPack.
- Do not use this procedure to remove the Zenoss Service Impact ZenPacks, *ZenPacks.zenoss.ImpactServer* and *ZenPacks.zenoss.Impact*. For more information, refer to the *Zenoss Resource Manager Installation Guide*.
- Review the documentation of the ZenPack that you want to remove for information about classes and daemons (services) associated with it.
- Delete data sources provided by the ZenPack that you want to remove.

- 1 Log in to the Control Center master host as a user with Control Center CLI privileges.
- 2 Create a snapshot:

```
serviced service snapshot Zenoss.resmgr
```

On completion, the `serviced` command returns the ID of the new snapshot. If the installation of the ZenPack ends up failing, you can restore the snapshot you took in this step. For detailed instructions on restoring a snapshot, refer to the *Control Center Reference Guide*.

- 3 Obtain the exact name of the ZenPack to remove:

```
serviced service run zope zenpack list
```

The first item of each line of output is the full name of an installed ZenPack.

- 4 Stop services that are associated with the ZenPack.



Daemons that a ZenPack provides are packaged in Docker containers and installed as child services of the current instance of Resource Manager. For example, the `zenwebtx` service is provided by the `ZenPacks.zenoss.ZenWebTx` ZenPack.

- a Log into the Resource Manager browser interface as the Resource Manager user.
- b From the navigation menu, select **ADVANCED > Control Center**.  
The Control Center **All Services** page appears.
- c Select the daemon for the service and click **Stop**.

For example, select the `zenwebtx` daemon.

- 5 Remove the ZenPack.

In the Control Center CLI, replace *ZenPack-Name* with the full name of the ZenPack to remove.

```
serviced service run zope zenpack-manager uninstall ZenPack-Name
```

The ZenPack and any daemons that it provides are removed.

## Creating a ZenPack

---

To perform this procedure, you need a user account with `serviced` CLI privileges on the Control Center master host.

This procedure demonstrates how to create a ZenPack for customized monitoring templates, customized event classes and mappings, device MIBs, and similar items which require no customized Python code. For more advanced ZenPack development, refer to the [ZenPack SDK](#) site.

- 1 Log in to the Control Center master host as a user with `serviced` CLI privileges.
- 2 Create a ZenPack.

Replace `ZenPacks.myOrg.myPackName` with the name of the ZenPack to create.

```
serviced service run zope zenpack-manager create \  
ZenPacks.myOrg.myPackName
```

- 3 Restart the Zope service.

```
serviced service restart zope
```

## General administration and settings

---

Use the information and procedures in this section for troubleshooting and performance improvement purposes.

### Events settings

---

You can adjust events settings for

- Events database connection
- Event maintenance

#### Changing events database connection information

To edit events database connection settings, make changes in the `zeneventserver.conf` file. You can edit the file directly, or run a configuration script.

Configurable database connection settings are:

- **JDBC Hostname** (`zep.jdbc.hostname`) - Specify the IP address of the host.
- **JDBC Port** (`zep.jdbc.port`) - Specify the port to use when accessing the events database.
- **JDBC Database Name** (`zep.jdbc.dbname`) - Specify the database name.
- **JDBC Username** (`zep.jdbc.username`) - Specify the user name for the database.
- **JDBC Password** (`zep.jdbc.password`) - Specify the password for the database.

To edit these values, run the `zeneventserver` configuration script, as follows:

```
zeneventserver-config -u zep.jdbc.Name=Value
```

Where *Name* is the partial setting name and *Value* is the value you want to specify for the setting.

#### Changing events maintenance settings

To edit maintenance settings, make changes to one or more fields on the Event Configuration page (**ADVANCED > Settings > Events**):

- **Don't Age This Severity and Above** - Options are Age All Events, Critical, Error, Warning, Info, Debug, and Clear. By default, this value is set to Error, meaning that all events with a status of Error or Critical are not aged.

- **Event Aging Threshold (minutes)** - Set the time value, in minutes, that an event must reach before it is aged. By default, this is 240 minutes.
- **Event Aging Interval (milliseconds)** - The interval when events are scanned to perform autoaging. By default, this is 60000 milliseconds (60 sec).
- **Event Aging Limit** - The maximum number of events to age in each interval. The limit should be kept relatively low to prevent large database transactions. By default, this is 1000 events.
- **Event Archive Threshold (minutes)** - Specify the number of minutes since a closed event was last seen before it is moved to the event archive. The minimum value is 1; the maximum value is 43200.
- **Event Archive Interval (milliseconds)** - The interval when events are scanned for moving to the archive. By default, this is 60000 milliseconds (60 sec).
- **Event Archive Limit** - The maximum number of events to archive in each interval. The limit should be kept relatively low to prevent large database transactions. By default, this is 1000 events.
- **Delete Archived Events Older Than (days)** - The number of days that events in the event archive are saved. By default, they are kept in the archive for 90 days. The minimum value is 1 and the maximum value is determined by the range of event archive partitions. With the default configuration, the maximum value is 1000 days.
- **Default Syslog Priority** - Specify the default severity level assigned to an event coming from zensyslog if no priority can be determined from the event.
- **Default Availability Report (days)** - Enter the number of days to include in the automatically generated Availability Report. This report shows a graphical summary of availability and status.
- **Max Event Size in Bytes** - The maximum size of an event that will be processed in bytes. Events that are too large will be logged and dropped. Events that will become too big will have their details overwritten with new details. By default, this is 32768 bytes.
- **Summary Index Interval (milliseconds)** - The default indexing interval of the event summary in milliseconds. By default, this is 1000 milliseconds (1 sec).
- **Archive Index Interval (milliseconds)** - The default indexing interval of the event archive in milliseconds. By default, this is 30000 milliseconds (30 sec).
- **Index Limit** - The number of events to index in each index interval. By default, this is 1000 events.
- **Event Time Purge Interval (days)** - The number of days that event occurrence time are kept. By default, they are kept for 7 days. The minimum value is 1 and the maximum value is determined by the range of event time partitions. With the default configuration, the maximum value is 7 days.
- **Enable Event Flapping Detection** - Select this check box if you wish to enable event flapping detection. If an event is created and then cleared *flapping\_threshold* times in *event\_flapping\_interval* time then an event of event flapping event class is created.
- **Event Flapping Event Class** - The event class under which generated flapping events belong.
- **Clear Event Heartbeats** - Click **Clear** to clear the event heartbeats.

## Rebuilding the events index

---

If you encounter inconsistent search results, you can rebuild the events index.

- 1 Log in to an account on the Control Center master host that has permission to use the Control Center command-line interface.
- 2 Stop zeneventserver:

```
serviced service stop zeneventserver
```

- 3 Delete the index data:

```
export SERVICE_ID=$(serviced service status Zenoss.resmgr | sed -n
'2p' | awk {'print $2'})
export SVCROOT=/opt/serviced/var/volumes/$SERVICE_ID
rm -rf $SVCROOT/zeneventserver/index
```

#### 4 Start zeneventserver:

```
serviced service start zeneventserver
```

Depending on the number of events in the database, it may take a significant amount of time for indexing to complete. Until every event is indexed, the number of events shown in the event console may be inconsistent.

## Audit logging

---

Resource Manager tracks user actions in audit log files. Resource Manager maintains logged information in a format that is optimized for searching and reporting.

Audit logging information is written to a flat file located on the Control Center master which is located at `/var/log/serviced/application-audit.log`. The information is also sent to Elasticsearch, which is then viewable through Kibana and can be viewed in the Control Center Logs tab.

The retention rules of the `application-audit.log` file are governed by the `logrotate` configuration file located at `/opt/serviced/etc/logrotate.conf`. For more information on editing the `logrotate` configuration file, refer to the *Control Center Reference Guide*.

## Examples

The following examples show logged messages for various user interactions.

### Example: Change device class

```
2017-07-14 20:17:52 INFO user=admin action=ChangeDeviceClass
  kind=Device device=/Devices/Server/Linux/devices/emailsrv05
  device_name=emailsrv05
  deviceclass=/Devices/Server/SSH/Linux old_deviceclass=/Devices/Server/
Linux
```

In this example, the admin user moved device `emailsrv05` from device class `/Server/Linux` to `Server/SSH/Linux`.

### Example: Change threshold value

```
2017-07-14 20:53:19 INFO user=admin action=Edit kind=Threshold
threshold="/Devices/Server/Microsoft/rrdTemplates/Device/thresholds/CPU
Utilization" maxval=95
old_maxval=90 thresholdtype=MinMaxThreshold
```

In this example, the admin user edited the max value of threshold "CPU Utilization" on Microsoft servers from 90 to 95.

### Searching file content

You can use Kibana to parse the audit log file content. In Control Center, click **Logs** to access Kibana. If you are interested in audit log content, you can select `fields.type:"zenossaudit"` to filter the logs. You can further refine your query by adding a filter to search for a string in the message field. For more information, refer to the *Control Center Reference Guide*.

## zensendaudit utility

You can send custom log messages using the `zensendaudit` script.

- 1 Log in to the Control Center host as a user with serviced CLI privileges.
- 2 Attach to the zope service.

```
serviced service attach zope
```

- 3 Change to the zenoss user.

```
su - zenoss
```

- 4 Run the zensendaudit script.

```
zensendaudit MessageText
```

where `MessageText` is the text you want displayed in the log.

For example, `zensendaudit Hello world.` will generate the following output:

```
Message sent: Hello world.
```

It will log the following message in the `zenosaudit fields.type` in the `application-audit.log` that can also be viewed in Kibana.

```
2017-07-14 19:10:18 INFO action=Log kind=Comment comment="Hello
world."
source=Shell process=zensendaudit logname=zenoss parameters="Hello
world."
```

## Support bundles

---

If you contact Zenoss Support about an issue with your Resource Manager system, you might be asked to send a support bundle or serviced and docker logs to help the technicians find a solution to your issue.

### Creating support bundles

- 1 As an administrator, navigate to **ADVANCED > Support**. The Support Bundles window appears.
- 2 Click **Add**. A window appears indicating that the support bundle will continue to be gathered even after closing the window.
- 3 Click **OK**. The Create Support Bundle window displays. Click **Close**. The support bundle will continue to be gathered. You can monitor the job log for progress. You can continue working with the system during this time.

**Figure 137:** Create Support Bundle window

- 4 When the completed support bundle appears in the Support Bundles window, click on its row and click **Download** to send the support bundle .zip file to your browser's downloads folder.

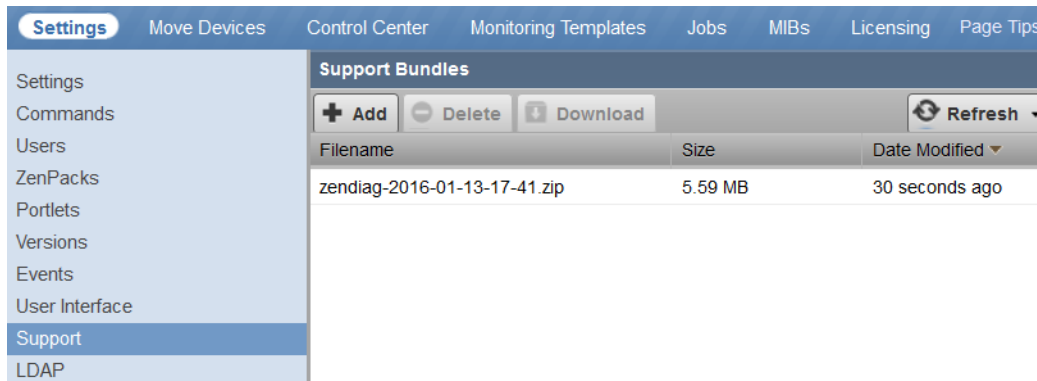
**Figure 138:** Support Bundles window

## Deleting support bundles

Occasionally clean up your system by deleting old support bundles that are no longer needed for troubleshooting purposes.

- 1 As an administrator, navigate to **ADVANCED > Support**.
- 2 In the **Support Bundles** window, click the row of the support bundles to be deleted. Be sure that you have selected the correct bundles because no confirmation window will appear.
- 3 After verifying your selections, click **Delete**.

## Gathering serviced and docker logs

You may need to gather serviced and docker logs separately to help troubleshoot an issue, since these logs cannot be collected by the support bundle process.

To get serviced logs from the system:

- 1 Start a command-line session as `root`.

- Execute the following command to create the `serviced.log` file in the `/tmp` directory.

```
journalctl -lu serviced > /tmp/serviced.log
```

- Execute the following command to create the `docker.log` file in the `/tmp` directory.

```
journalctl -lu docker > /tmp/docker.log
```

## Working with the job manager

The job manager runs background tasks, such as discovering a network or adding a device. When you ask the system to perform one of these tasks, it adds a job to the queue. Jobs are run by the `zenjobs` daemon.

Not all actions are performed in the job manager. Some jobs are run automatically in the foreground. Others, such as moving devices, depend on user interface configuration settings.

When running jobs in the foreground, do not navigate away from the current page until the action completes.

## Viewing the job manager

- From the Navigation menu, select **ADVANCED**.
- On the **Settings** page, select **Jobs**.

**Figure 139:** Job manager

The screenshot shows the 'Jobs' tab in the system interface. At the top, there are navigation tabs: Settings, Control Center, Monitoring Templates, and Jobs. A 'Page Tips' link is also visible. Below the tabs is a 'Background Jobs' section with a table of jobs. The table has columns for Status, Description, Scheduled, Started, Finished, and Created By. The jobs listed include 'Create' and 'Discover and model device' actions for various IP addresses and network configurations. The status of each job is indicated by a green checkmark (Success) or a red exclamation mark (Failure). Below the table, there is a 'Job Log' section with a log file path and several log entries showing the progress of a job.

Status	Description	Scheduled	Started	Finished	Created By
Success	Create 10.171.100.14 under /Network/Cisco/6500	2 days ago	2 days ago	2 days ago	admin
Failure	Discover and model device 10.171.100.14 as /Networ...	2 days ago	2 days ago	2 days ago	admin
Success	Create 10.171.100.92 under /Network/Cisco/Nexus/70...	2 days ago	2 days ago	2 days ago	admin
Failure	Discover and model device 10.171.100.92 as /Networ...	2 days ago	2 days ago	2 days ago	admin
Success	Create 10.171.100.88 under /Network/Cisco/Nexus/10...	2 days ago	2 days ago	2 days ago	admin
Failure	Discover and model device 10.171.100.88 as /Networ...	2 days ago	2 days ago	2 days ago	admin
Success	Create 10.171.54.9 under /Network/Cisco	2 days ago	2 days ago	2 days ago	admin
Success	Discover and model device 10.171.54.9 as /Network/...	2 days ago	2 days ago	2 days ago	admin
Success	Create 10.171.100.107 under /Network/Cisco/Nexus/6...	2 days ago	2 days ago	2 days ago	admin
Failure	Discover and model device 10.171.100.107 as /Netwo...	2 days ago	2 days ago	2 days ago	admin
Success	Create 10.171.53.1 under /Network/Cisco	2 days ago	2 days ago	2 days ago	admin
Success	Discover and model device 10.171.53.1 as /Network/...	2 days ago	2 days ago	2 days ago	admin

DISPLAYING 1 - 13 of 33 ROWS

**Job Log**

Log file: [/opt/zenoss/log/jobs/c4583592-2506-4466-b909-854ebfa20258.log](#)

2015-08-04 17:59:20,643 INFO zen.Job: Job c4583592-2506-4466-b909-854ebfa20258 (Products.ZenModel.ZDeviceLoader.CreateDeviceJob) received

2015-08-04 17:59:20,657 INFO zen.Job: Starting job c4583592-2506-4466-b909-854ebfa20258 (Products.ZenModel.ZDeviceLoader.CreateDeviceJob)

2015-08-04 17:59:21,051 INFO zen.Job: Job c4583592-2506-4466-b909-854ebfa20258 finished with result /zport/dmd/Devices/Network/Cisco/Nexus/7000/devices/10.171.100.92

The jobs list displays the following information about the jobs:

- **Status** - Shows the current job status. Status options are Pending (waiting for zenjobs to begin running), Running, Succeeded, and Failed.
- **Description** - Provides a description of the job.
- **Scheduled** - Shows when the job was scheduled to begin.
- **Started / Finished** - Provide information about the time period in which the job ran.
- **Created By** - User that created the job.

The lower section of the page displays the job log for the job that you select in the list. You can also view the information in the log file.

## Stopping and deleting jobs

To stop a job, select it in the list, and then click **Abort**. The zenjobs daemon will not run the job.

To remove a job from the system, select it and then click **Delete**.

## Configuring jobs

When you move devices, you can choose whether the action is performed immediately or as a job. By default, if you select five or more devices, the move action is performed as a job. To adjust this setting:

- 1 Select **Advanced > Settings**.
- 2 Select **User Interface** in the left panel.
- 3 Enter a value for **Device Move Job Threshold**, and then click **Save**.

## Running the zenjobs daemon

You can stop and start the zenjobs daemon from the command line, and from **Advanced > Settings**(Daemons selection).



# Using the Appliance Administration menu

---

# A

This appendix describes the curses-based Appliance Administration menu, a text user interface (TUI).

## Configure Network and DNS

---

The **Configure Network and DNS** option invokes *nmtui*, the *NetworkManager* text user interface (TUI) tool. The *nmtui* utility provides submenus for editing and activating network connections, and for changing the hostname.

---

**Note** Zenoss recommends using only the **Configure Network and DNS** option to change connection properties or the hostname, and always rebooting after making changes.

---

## Editing a connection to configure static IPv4 addressing

The default configuration for network connections is DHCP. To configure static IPv4 addressing, perform this procedure.

To navigate in the text user interface (TUI):

- To move forward or backward through options, press the arrow keys.
- To display a menu or choose an option, press **Enter**.

- 1 Gain access to the Control Center host, through the console interface of your hypervisor, or through a remote shell utility such as *PuTTY*.
- 2 Log in as the `root` user.

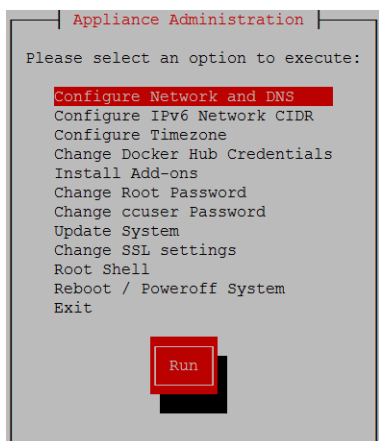

- 3 Select the **NetworkManager TUI** menu as follows:
  - a In the **Appliance Administration** menu, select **Configure Network and DNS**, and then press **Enter**.

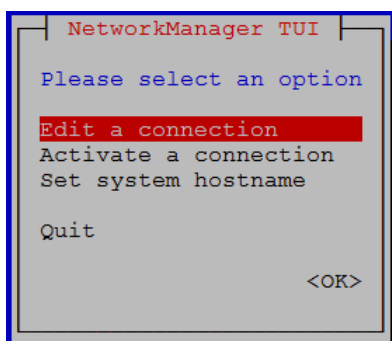

- 4 On the **NetworkManager TUI** menu, select **Edit a connection**, and then press **Enter**. The TUI displays the connections that are available on the host.

**Figure 140:** Example: Available connections

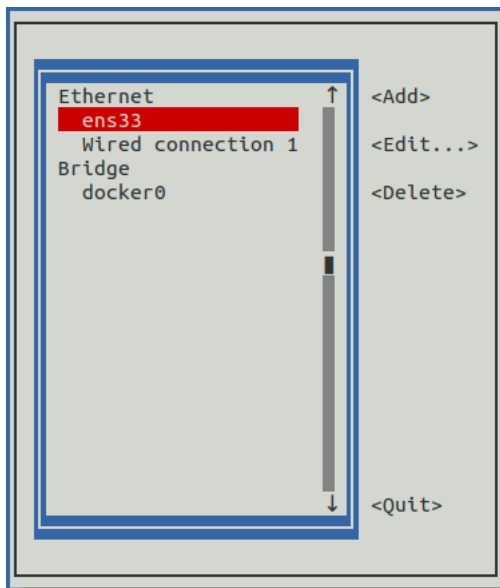



---

**Note** Do not use this procedure to modify the `docker0` connection.

---

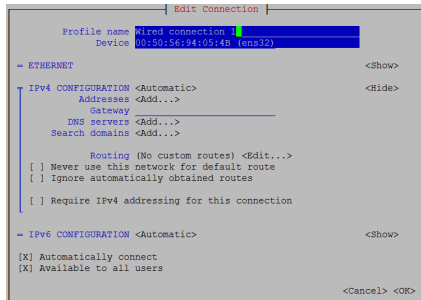
- 5 Select the virtual connection, and then press **Enter**.

**Figure 141:** Example: Edit Connection screen

- 6 Optional: If the **IPv4 CONFIGURATION** area is not visible, select its display option (<Show>), and then press **Enter**.
- 7 In the **IPv4 CONFIGURATION** area, select <Automatic>, and then press **Enter**.

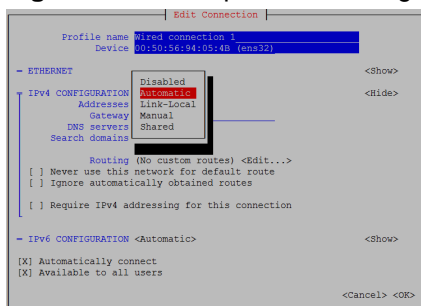
**Figure 142:** Example: IPv4 Configuration options

- 8 Configure static IPv4 networking as follows:
  - a Select **Manual**, and then press **Enter**.
  - b Beside **Addresses**, select <Add>, and then press **Enter**.
  - c In the **Addresses** field, enter an IPv4 address for the virtual machine, and then press **Enter**.
  - d Repeat the preceding two steps for the **Gateway** and **DNS servers** fields.
- 9 Tab to the bottom of the **Edit Connection** screen to select <OK>, and then press **Enter**.
- 10 Return to the **Appliance Administration** menu: On the **NetworkManager TUI** screen, select <Quit>, and then press **Enter**.
- 11 Reboot the operating system as follows:
  - a In the **Appliance Administration** menu, select **Reboot / Poweroff System**.
  - b Select **Reboot**.
  - c Select **OK**, and then press **Enter**.

## Edit a connection (Docker virtual bridge)

The default IP address space of the Docker virtual bridge is 172.17.0.1/16. To configure a different address space, perform this procedure.

- 1 Gain access to the Control Center host, through the console interface of your hypervisor, or through a remote shell utility such as *PuTTY*.
- 2 Log in as the `root` user.
- 3 Select the **NetworkManager TUI** menu as follows:
  - a In the **Appliance Administration** menu, select **Configure Network and DNS**, and then press **Enter**.

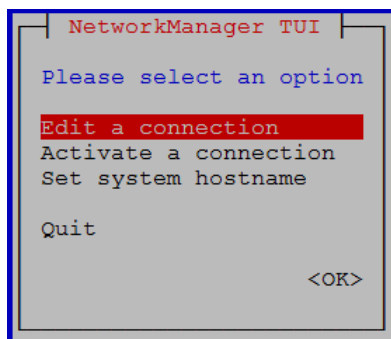

- 4 On the **NetworkManager TUI** menu, select **Edit a connection**, and then press **Enter**. The TUI displays the connections that are available on this host.

**Figure 143:** Example: Available connections

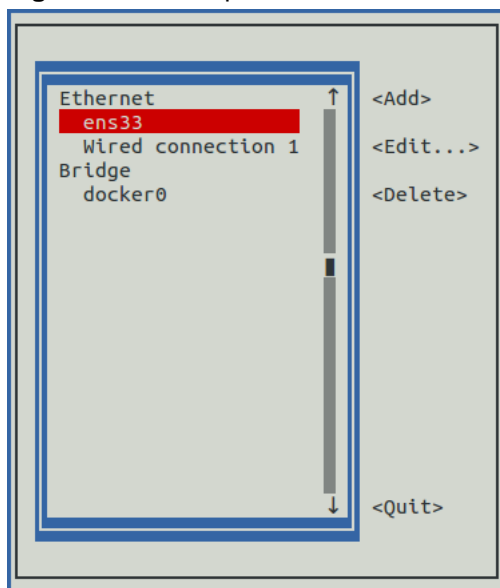

- 5 Use the down-arrow key to select **docker0**, and then press **Enter**.

**Figure 144:** Example: Edit Connection screen

```

Edit Connection

Profile name docker0
Device docker0

BRIDGE Slaves <Hide>
  veth56f9234 <Add>
  vethb5c26d0 <Edit...>
  veth35feb6f <Delete>
  veth5257cb5
  vethbd5de4e
  vethea0b21f

  Aging time 300 seconds
  [ ] Enable STP (Spanning Tree Protocol)
    Priority 32768
  Forward delay 15 seconds
  Hello time 2 seconds
  Max age 20 seconds

IPv4 CONFIGURATION <Manual> <Hide>
  Addresses 172.17.0.1/16 <Remove>
  <Add...>
  Gateway
  DNS servers <Add...>
  Search domains <Add...>

  Routing (No custom routes) <Edit...>
  [ ] Never use this network for default route
  [ ] Require IPv4 addressing for this connection

IPv6 CONFIGURATION <Link-Local> <Show>
  [ ] Automatically connect

```

Use the **Tab** key and the arrow keys to navigate among options in the **Edit Connection** screen, and use **Enter** to toggle an option or to display a menu of options.

- 6 If the **BRIDGE** area is visible, select its display option (**<Hide>**), and then press **Enter**.

---

**Note** Do not edit any of the entries in the **BRIDGE** area.

---

- 7 If the **IPv4 CONFIGURATION** area is not visible, select its display option (**<Show>**), and then press **Enter**.
- 8 In the **IPv4 CONFIGURATION** area, navigate to **Addresses**, and then enter a new IPv4 address in CIDR notation.

**Figure 145:** Example: IPv4 Configuration options

```

Edit Connection

Profile name docker0
Device docker0

= BRIDGE <Show>
├─ IPv4 CONFIGURATION <Manual> <Hide>
│   Addresses 172.17.0.1/16 <Remove>
│   <Add...>
│   Gateway
│   DNS servers <Add...>
│   Search domains <Add...>
│   Routing (No custom routes) <Edit...>
│   [ ] Never use this network for default route
│   [ ] Require IPv4 addressing for this connection
└─ = IPv6 CONFIGURATION <Link-Local> <Show>
    [ ] Automatically connect
    [X] Available to all users

<Cancel> <OK>

```

- 9 Use **Tab** or the Down Arrow key to select the **<OK>** option at the bottom of the **Edit Connection** screen, and then press **Enter**.
- 10 In the available connections screen, use **Tab** to select the **<Quit>** option, and then press **Enter**.
- 11 Reboot the operating system as follows:
  - a In the **Appliance Administration** menu, select **Reboot / Poweroff System**.
  - b Press **Tab** to select **OK**, and then press **Enter**.

#### CIDR prefix lengths for common subnet masks

Subnet mask	CIDR prefix length	Subnet mask	CIDR prefix length
255.255.0.0	/16	255.255.254.0	/23
255.255.128.0	/17	255.255.255.0	/24
255.255.192.0	/18	255.255.255.128	/25
255.255.224.0	/19	255.255.255.192	/26
255.255.240.0	/20	255.255.255.224	/27
255.255.248.0	/21	255.255.255.240	/28
255.255.252.0	/22	255.255.255.248	/29

### Activate a connection

The **Activate a connection** submenu provides options for activating and deactivating network connections.

**Note** Do not deactivate the `docker0` connection.

On selection, the **Activate a connection** submenu displays the available connections. The asterisk character (\*) at the beginning of a connection name indicates that the connection is active.

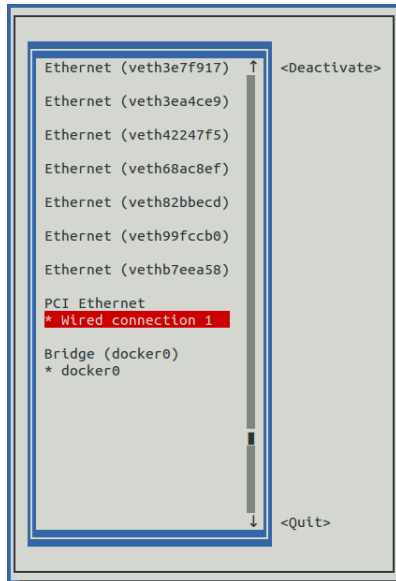
**Figure 146:** Example: Available connections

Use the arrow keys to select a connection, and then use **Tab** to navigate the options at the right side of the list. Use **Enter** to choose an option.

---

**Note** Always reboot after activating or deactivating a connection.

---

## Setting the system hostname

The default hostname is `zsd-master` for the Resource Manager master host and is `zsd-delegate` for Resource Manager delegate hosts. To change the default hostname, perform this procedure.

- 1 Gain access to the Control Center host, through the console interface of your hypervisor, or through a remote shell utility such as *PuTTY*.
- 2 Select the **NetworkManager TUI** menu as follows:
  - a In the **Appliance Administration** menu, select **Configure Network and DNS**, and then press **Enter**.

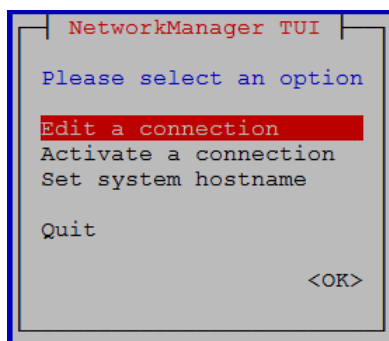

- 3 Display the hostname entry field.
  - a In the **NetworkManager TUI** menu, select **Set system hostname**.
  - b Select **OK**, and then press **Enter**.
- 4 In the **Hostname** field, enter the hostname or a fully qualified domain name.
- 5 Press **Tab** twice to select **OK**, and then press **Enter**.

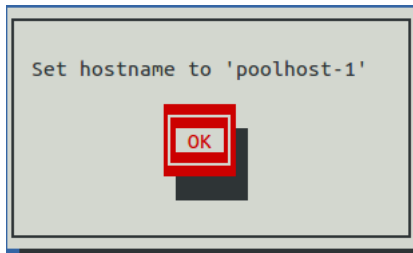

- 6 In the confirmation dialog box, press **Enter**.
- 7 Return to the **Appliance Administration** menu: On the **NetworkManager** TUI screen, select **<Quit>**, and then press **Enter**.
- 8 Reboot the operating system as follows:
  - a In the **Appliance Administration** menu, select **Reboot / Poweroff System**.
  - b Select **Reboot**.
  - c Select **OK**, and then press **Enter**.

## Configure IPv6 Network CIDR

---

The version of Docker included in the Resource Manager virtual appliance needs to know at startup the address prefix of the IPv6 network it will use. To enable monitoring of devices that use IPv6, perform this procedure on the Control Center master host, and all delegate hosts.

- 1 Gain access to the Control Center host, through the console interface of your hypervisor, or through a remote shell utility such as *PuTTY*.
- 2 Log in as the `root` user.
- 3 In the **Appliance Administration** menu, select the **Configure IPv6 Network CIDR** option.

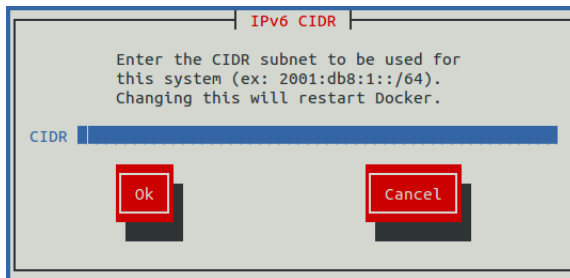

- 4 In the **IPv6 CIDR** screen, enter the address prefix of your IPv6 network in the **CIDR** field.
- 5 User **Tab** to select the **Ok** button, and then press **Enter**.  
The Docker daemon restarts, and the **Appliance Administration** disappears briefly before returning. This is normal.

## Configure Timezone

---

The default timezone of the Resource Manager virtual appliance is UTC. This procedure changes the timezone setting of a single host. All hosts in a multi-host deployment must use the same timezone.

- 1 Gain access to the Control Center host, through the console interface of your hypervisor, or through a remote shell utility such as *PuTTY*.
- 2 Log in as the `root` user.
- 3 In the **Appliance Administration** menu, select the **Configure Timezone** option.



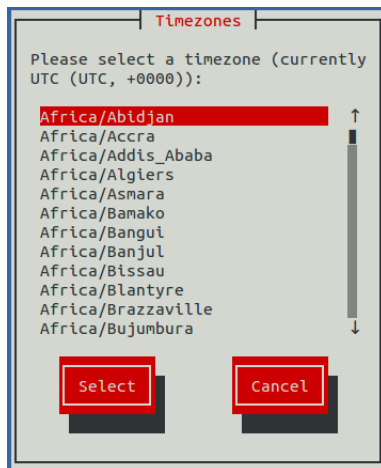

- 4 Use the **Down Arrow** key to select the desired timezone.
- 5 Press **Tab** to highlight **Select**, and then press **Enter**.

---

**Note** Always reboot after changing the timezone.

---

## Change Docker Hub Credentials

---

To perform this procedure, you need the username, email address, and password of a Docker Hub user account that is authorized to pull Resource Manager images. The information is provided by Zenoss Support when necessary.

The Control Center master host can obtain software updates over the internet from the [Docker Hub](#) registry. This option obtains a JSON web token from Docker Hub and stores it at `/root/.docker/config.json`.

- 1 Gain access to the Control Center host, through the console interface of your hypervisor, or through a remote shell utility such as [PuTTY](#).
- 2 Log in as the `root` user.
- 3 In the **Appliance Administration** menu, select the **Change Docker Hub Credentials** option.

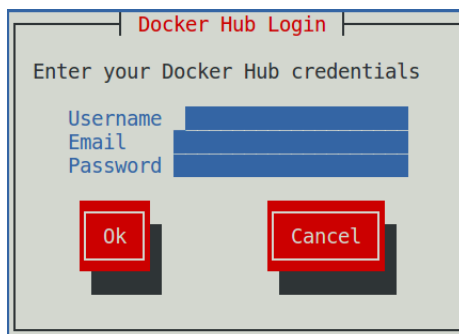

- 4 Enter the username, email address, and password of the authorized user account in the fields. Use **Tab** to advance to the next field.
- 5 Press **Tab** to highlight **OK**, and then press **Enter**.

## Change Root Password

---

This option invokes the `passwd` command to change the password of the `root` user account.

- 1 Gain access to the Control Center host, through the console interface of your hypervisor, or through a remote shell utility such as [PuTTY](#).

- 2 Log in as the `root` user.
- 3 In the **Appliance Administration** menu, select the **Change Root Password** option.  
The **Appliance Administration** menu disappears, and the system prompts for a new password:

```
Changing password for user root.
New password:
```

- 4 **Note** Passwords must include a minimum of eight characters, with at least one character from three of the following character classes: uppercase letter, lowercase letter, digit, and special.  
Enter a new password, and then press **Enter**.
- 5 Enter the password again, and then press **Enter**.  
The **Appliance Administration** menu reappears.

## Change ccuser Password

---

This option invokes the `passwd` command to change the password of the `ccuser` user account.

- 1 Gain access to the Control Center host, through the console interface of your hypervisor, or through a remote shell utility such as *PuTTY*.
- 2 Log in as the `root` user.
- 3 In the **Appliance Administration** menu, select the **Change Root Password** option.  
The **Appliance Administration** menu disappears, and the system prompts for a new password:

```
Changing password for user ccuser.
New password:
```

- 4 **Note** Passwords must include a minimum of eight characters, with at least one character from three of the following character classes: uppercase letter, lowercase letter, digit, and special.  
Enter a new password, and then press **Enter**.
- 5 Enter the password again, and then press **Enter**.  
The **Appliance Administration** menu reappears.

## Update System

---

This option updates the Control Center and Resource Manager software on a host. For more information, refer to the *Zenoss Resource Manager Upgrade Guide*.

## Change SSL settings

---

To perform this procedure, you need to be able to display the contents of the SSL certificate and key files that you want to install on the Control Center master host, and you need a copy of the root certificate file (`rootCA.pem`). In addition, Zenoss recommends logging in to the master host through SSH, rather than the hypervisor console, so that you can copy and paste content.

This option allows you to provide new content for SSL certificate and key files.

- 1 Gain access to the Control Center host, through the console interface of your hypervisor, or through a remote shell utility such as *PuTTY*.
- 2 Log in as the `root` user.
- 3 Use the **Down Arrow** key to select **Change SSL settings**, and then press **Enter**.

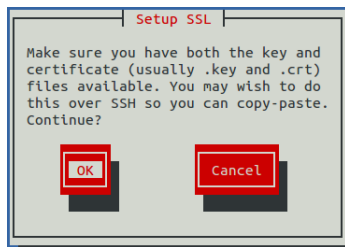

- 4 When you are ready to add the contents of your SSL certificate and key files to the Control Center master host, press **Enter**.

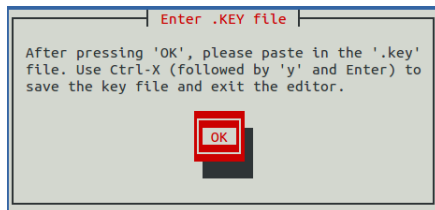

- 5 Press **Enter**.  
The **Appliance Administration** menu is replaced with the nano text editor.
- 6 Enter the contents of your SSL key file, and then save the file and exit the editor.
- Press **Ctrl-O**.
  - Press **Ctrl-X**.
  - Press **y**, and then press **Enter**.

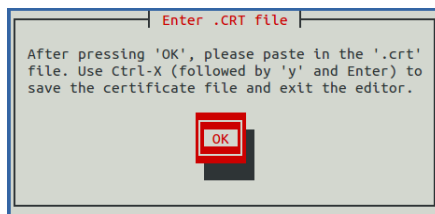

- 7 Press **Enter**.  
The **Appliance Administration** menu is replaced with the nano text editor.
- 8 Enter the contents of your SSL certificate file, and then save the file and exit the editor.
- Press **Ctrl-O**.
  - Press **Ctrl-X**.
  - Press **y**, and then press **Enter**.

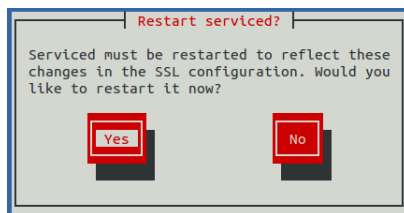

- 9 Restart the Control Center daemon (*serviced*) now or later.  
Restarting *serviced* pauses Resource Manager services briefly.
- To restart *serviced* now, press **Enter**.
  - To restart *serviced* later, press **Tab** to select **No**, and then press **Enter**.

- 10 Install the root certificate into browser clients.

The procedures for installing a root certificate into a browser client varies by browser and client operating system. For more information, refer to your browser documentation or articles such as [this one](#).

## Root Shell

This option starts a command-line session as the `root` user.

- 1 Gain access to the Control Center host, through the console interface of your hypervisor, or through a remote shell utility such as *PuTTY*.
- 2 Log in as the `root` user.
- 3 Use the **Down Arrow** key to select **Root Shell**, and then press **Enter**.  
The menu is replaced by a command prompt similar to the following example:

```
[root@resmgr-master ~]#
```

To return to the **Appliance Administration** menu, enter the `exit` command.

## Reboot / Poweroff System

This option reboots or shuts down and turns off a Control Center host.

- 1 Gain access to the Control Center host, through the console interface of your hypervisor, or through a remote shell utility such as *PuTTY*.
- 2 Log in as the `root` user.
- 3 In the **Appliance Administration** menu, select the **Reboot / Poweroff System** option.

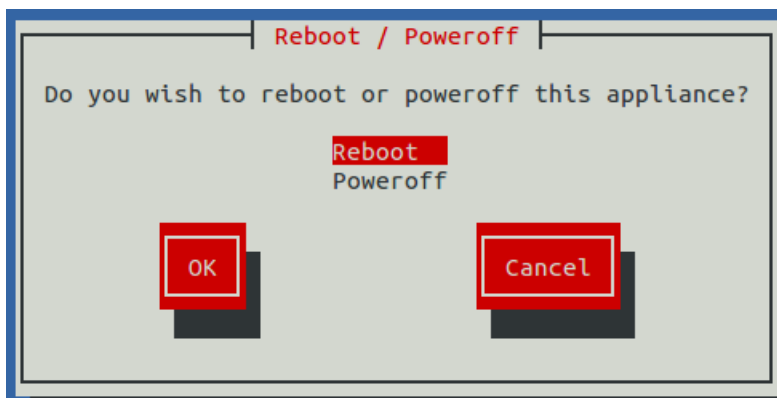

- 4 Use the **Down Arrow** key to select **Reboot** or **Poweroff System**.
- 5 Press **Tab** to highlight **OK**, and then press **Enter**.

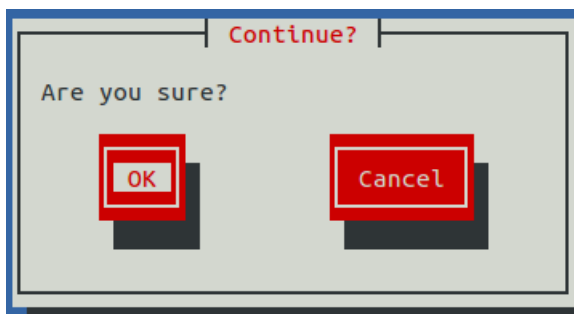

- 6 Use **Tab** to select **OK** or **Cancel**, and then press **Enter**.  
The system reboots or shuts down and powers off.

## B

## Managing Zope instances

---

Zope is the web application server that Resource Manager uses.

For general processing, the Resource Manager `zope` service provides six instances of the Zope web application server. Resource Manager browser interface performance might slow in deployments with many concurrent users, during frequent report generation, or with Zenoss JSON API use. To maintain responsiveness, Resource Manager services provide dedicated Zope instances for reporting, Zenoss JSON API use, and debugging.

You can enable or disable the services and change the number of Zope instances that Resource Manager uses. (If you increase the number of instances, monitor RAM usage.)

### Changing the number of Zope instances

---

If you need more or fewer dedicated or general-purpose Zope instances, edit the appropriate service to change the number. Debugging (the `zendebug` service) is limited to one instance.

- 1 Log in to the Control Center browser interface.
- 2 In the **Applications** table under **Application**, click the application name (**Zenoss.resmgr**).
- 3 In the **Services** table, click **Zenoss**.
- 4 In the **Services** table, click **User Interface**.
- 5 In the **Services** table, click the appropriate service as follows:
  - **zenapi**
  - **zenreports**
  - **zope**
- 6 On the service page, click **Edit Service**.
- 7 In the **Edit Service** dialog box, change the value in the **Instances** field.
- 8 Click **Save Changes**.
- 9 On the service page, click **Restart**.

### Dedicated Zope service for reporting

---

The `zenreports` service provides a Zope instance that is dedicated to report generation.

No configuration or action is required to use the `zenreports` service. By default, the service starts when you launch Resource Manager and is automatically selected to generate Resource Manager reports.

If you need more than one dedicated instance for report generation, edit the `zenreports` service to increase the number, as described in [Changing the number of Zope instances](#) on page 237.

Under the following conditions, you can disable the **zenreports** service:

- You have a small deployment or few concurrent users of the browser interface.
- You infrequently generate Resource Manager reports.

## Disabling automatic start of the reporting Zope service

By default, the **zenreports** service starts when you launch Resource Manager. You can disable automatic start of the service.

- 1 Log in to the Control Center master host as `root`, or as a user with superuser privileges.
- 2 Disable automatic start of the **zenreports** service.
  - a Edit the configuration of the service.

```
serviced service edit zenreports
```

The `serviced` command opens the service's configuration file in the default text editor.

- b Locate the line `"Launch": "auto"`, and replace `"auto"` with `"manual"` as follows:

```
"Launch": "manual"
```

- c Save the file, and then exit the text editor.

## Stopping the reporting Zope service

You can disable use of the dedicated Zope service so that Resource Manager uses general-purpose Zope instances for report generation.

- 1 Log in to the Control Center browser interface.
- 2 In the **Applications** table under **Application**, click the application name (**Zenoss.resmgr**).
- 3 Turn off rules that route report requests to the **zenreports** service as follows:
  - a In the **Configuration Files** table, locate file `zproxy-nginx.conf`, and under the **Actions** column, click **Edit**.
  - b In the configuration file, locate the following line:

```
include zopereports-proxy.conf
```

- c Add the number sign character (`#`) to the beginning of the line.

```
#include zopereports-proxy.conf
```

- d Click **Save**.
- 4 In the **Instances** table under the **Actions** column, click **Restart**. This action restarts the **zproxy** service.
- 5 Stop the **zenreports** service as follows:
  - a In the **Services** table, click **Zenoss**.
  - b In the **Services** table, click **User Interface**.
  - c In the **Services** table, locate the **zenreports** service, and under the **Actions** column, click **Stop**.

## Dedicated Zope service for Zenoss JSON API use

---

The **zenapi** service provides a Zope instance that is dedicated to Zenoss JSON API use.

The Zenoss JSON API enables advanced users to customize Resource Manager and automate tasks such as adding and removing devices and managing alerts. For more information, refer to *Working with the JSON API* and the Zenoss JSON API reference at [Zenoss Documentation](#).

By default, the **zenapi** service starts when you launch Resource Manager and provides one Zope instance. If you need more than one dedicated instance, edit the **zenapi** service to increase the number, as described in [Changing the number of Zope instances](#) on page 237.

Under the following conditions, you can disable the service:

- You have a small deployment or few concurrent users of the browser interface.
- You infrequently use the Zenoss JSON API.

## Disabling automatic start of the Zenoss JSON API Zope service

By default, the **zenapi** service starts when you launch Resource Manager. You can disable automatic start of the service.

- 1 Log in to the Control Center master host as **root**, or as a user with superuser privileges.
- 2 Disable automatic start of the **zenapi** service.
  - a Edit the configuration of the service.

```
serviced service edit zenapi
```

The **serviced** command opens the service's configuration file in the default text editor.

- b Locate the line `"Launch": "auto"`, and replace `"auto"` with `"manual"` as follows:

```
"Launch": "manual"
```

- c Save the file, and then exit the text editor.

## Stopping the Zenoss JSON API Zope service

You can disable use of the dedicated Zope service so that Resource Manager uses the general-purpose Zope instances for Zenoss JSON API processing.

- 1 Log in to the Control Center browser interface.
- 2 In the **Applications** table under **Application**, click the application name (**Zenoss.resmgr**).
- 3 In the **Public Endpoints** table, locate URL `https://zenapi.hostname`, and under the **Actions** column, click **Stop**.
- 4 Turn off rules that route Zenoss JSON API requests to the **zenapi** service as follows:
  - a In the **Configuration Files** table, locate file `zproxy-nginx.conf`, and under the **Actions** column, click **Edit**.
  - b In the configuration file, locate the following line:

```
~*zenapi apizopes;
```

- a Add the number sign character (**#**) to the beginning of the line.

```
#~*zenapi apizopes;
```

- b Click **Save**.
- 5 In the **Instances** table under the **Actions** column, click **Restart**. This action restarts the **zproxy** service.
- 6 Stop the **zenapi** service as follows:
  - a In the **Services** table, click **Zenoss**.
  - b In the **Services** table, click **User Interface**.
  - c In the **Services** table, locate the **zenapi** service, and under the **Actions** column, click **Stop**.

## Dedicated Zope service for debugging

---

The `zendebbug` service enables the Zenoss Support team to start a separate Zope instance to use for troubleshooting and debugging purposes.

By default, `zendebbug` is stopped. You can enable the service when instructed to do so by Zenoss Support. Do not remove `zendebbug` from the Resource Manager service definition.

### Enabling the Zope service for debugging

If instructed to do so by Zenoss Support, enable use of the dedicated Zope service for debugging. Resource Manager then uses all general-purpose Zope instances for other processing. The maximum number of debugging service instances is one.

- 1 Log in to the Control Center browser interface.
- 2 In the **Applications** table under **Application**, click the application name (**Zenoss.resmgr**).
- 3 In the **Public Endpoints** table, locate URL `https://zendebbug.hostname`, and under the **Actions** column, click **Start**.
- 4 Start the `zendebbug` service as follows:
  - a In the **Services** table, click **Zenoss**.
  - b In the **Services** table, click **User Interface**.
  - c In the **Services** table, locate the `zendebbug` service, and under the **Actions** column, click **Start**.





## SNMP device preparation

---

This section provides information about SNMP support and lists Net-SNMP configuration settings that are required by the system.

### Net-SNMP

---

By default, Net-SNMP does not publish the full SNMP tree. Check to see if that is currently the case on a device and configure it correctly.

- 1 Confirm `snmpd` is running:

```
> snmpwalk -v 2c -cpublic <your device name> system
```

- 2 Retrieve the IP table for the device with `snmpwalk`:

```
> snmpwalk -v 2c -cpublic <your device name> ip
```

Typical SNMP View:

```
view systemview included .1 view systemview included .1.3.6.1.2.1.25.1
access notConfigGroup "" any noauth exact systemview none none
```

### SNMP v3 support

---

Resource Manager provides support for SNMP v3 data collection.

The following configuration properties control the authentication and privacy of these requests:

- **zSnmAuthType**- Use "MD5" or "SHA" signatures to authenticate SNMP requests. If only `zSnmAuthType` and `zSnmAuthPassword` are set, then the message is sent with authentication but no privacy.
- **zSnmAuthPassword**- Shared private key used for authentication. Must be at least 8 characters long.
- **zSnmPrivType**- "DES" or "AES" cryptographic algorithms. If `zSnmPrivType` and `zSnmPrivPassword` are set, then the message is sent with privacy and authentication. You cannot set a `PrivType` and `PrivPassword` without also setting an `AuthType` and `AuthPassword`. If neither `Priv` nor `Auth` values are set, then the message is sent with no authentication or privacy.
- **zSnmPrivKey**- Shared private key used for encrypting SNMP requests. Must be at least 8 characters long.
- **zSnmSecurityName**- Security Name (user) to use when making SNMPv3 requests.

If monitoring SNMPv3 devices, make sure that `msgAuthoritativeEngineID` (also known as `snmpEngineID` or `Engine ID`) is not shared by two devices. It must be unique for each device.

## Advanced Encryption Standard

SNMPv3 encryption using the Advanced Encryption Standard (AES) algorithm is supported only if the host platform `net-snmp` library supports it.

You can determine whether your platform supports AES by using the following test:

```
$ snmpwalk -x AES 2>&1 | head -1
```

If the response is:

```
"Invalid privacy protocol specified after -x flag: AES"
```

then your platform does not support AES encryption for SNMPv3.

If the response is:

```
"No hostname specified."
```

Then your platform supports AES.

## Community information

---

Add these lines to your `snmp.conf` file.

This line will map the community name "public" into a "security name":

```
# sec.name source community
```

```
com2sec notConfigUser default public
```

This line will map the security name into a group name:

```
# groupName securityModel securityName
```

```
group notConfigGroup v2c notConfigUser
```

This line will create a view for you to let the group have rights to:

```
# Make at least snmpwalk -v 1 localhost -c public system fast again.
```

```
# name incl/excl subtree mask(optional)
```

```
view systemview included .1
```

This line will grant the group read-only access to the systemview view.

```
# group context sec.model sec.level prefix read write notif access  
notConfigGroup "" any noauth exact systemview none none
```

## System contact information

---

It is also possible to set the `sysContact` and `sysLocation` system variables through the `snmpd.conf` file:

```
syslocation Unknown (edit /etc/snmp/snmpd.conf)
```

```
syscontact Root <root@localhost> (configure /etc/snmp/snmp.local.conf)
```

```
# Added for support of bcm5820 cards. pass .1 /usr/bin/ucd5820stat
```

## Extra information

---

For more information, see the `snmpd.conf` manual page, and the output of the `snmpd -H` command.

```
trapcommunity public
```

```
trapsink default
```

## D

## Syslog device preparation

---

### Forwarding syslog messages from UNIX/Linux devices

---

Resource Manager has its own syslog server (`zensyslog`). Managed devices should point their syslog daemons to the system.

To do this, edit the `/etc/rsyslog.conf` file and add an entry, where 1.2.3.4 is the `zensyslog` IP:

- 1 Log in to the target device as a super user.
- 2 Open the `/etc/rsyslog.conf` file with a text editor (such as `vi`).
- 3 Enter `*.debug`, and then press the Tab key.
- 4 Enter the host name or IP address of the server. For example:

```
*.debug @192.168.X.X
```

- 5 Save the file and exit the file editor program.
- 6 Restart the Syslog service using the command below:

```
/etc/init.d/syslog restart
```

### Forwarding syslog messages from a Cisco IOS router

---

Here are some links to Cisco commands to turn on syslog. Typically, it is easier to use syslog than SNMP traps from network devices. The most basic IOS command to send syslog messages is:

```
logging 1.2.3.4
```

### Other Cisco syslog configurations

Following are additional configurations for other Cisco devices. To set up these configurations:

- 1 Log in to the target router.
- 2 Type the command `enable` at the prompt.
- 3 Once you are prompted for a password, enter the correct password.
- 4 Type the command `config` at the prompt.
- 5 Type the command `terminal` at the configuration prompt.

- At the prompt, Set the Syslog forwarding mechanism. See example below:

```
logging <IP address of the server>
```

- Exit out all the prompts to the main router prompt.

#### Catalyst

```
set logging server enable set logging server 192.168.1.100 set logging
level all 5 set logging server severity 6
```

#### Local Director

```
syslog output 20.5 no syslog console syslog host 192.168.1.100
```

#### PIX Firewalls

```
logging on logging standby logging timestamp logging trap notifications
logging facility 19 logging host inside 192.168.1.100
```

## Forwarding syslog messages from a Cisco CatOS switch

---

To forward a syslog message from a Cisco CatOS switch:

- Log in to the target switch.
- Type the command enable at the prompt.
- Enter the password when prompted.
- Set the Syslog forwarding mechanism; for example:

```
set logging server <IP address of the server>
```

- You can set the types of logging information that you want the switch to provide with the commands below as examples:

```
set logging level mgmt 7 default set logging level sys 7 default set
logging level filesys 7 default
```

## Forwarding syslog messages using syslog-ng

---

Here is an example for FreeBSD and Linux platforms.

- Log in to the target device as a super user.
- Open `/etc/syslog-ng/syslog-ng.conf` file with a text editor (e.g `vi`).
- Add source information to file. See the following examples:

FreeBSD:

```
source src { unix-dgram("/var/run/log"); internal ();};
```

Linux: (will gather both system and kernel logs)

```
source src { internal(); unix-stream("/dev/log" keep-alive(yes) max-connections(100)); pipe("/proc/kmsg"); udp(); };
```

- 4 Add destination information (in this case, the server). For example:

```
log { source(src); destination(zenoss); };
```

# TALES expressions

---



Use TALES syntax to retrieve values and call methods on Resource Manager objects. Several areas accept TALES syntax; these include:

- Command templates
- User commands
- Notifications
- zLinks

Commands (those associated with devices and those associated with events) can use TALES expressions to incorporate data from the related devices or events. TALES is a syntax for specifying expressions that let you access the attributes of certain objects, such as a device or an event.

For additional documentation on TALES syntax, see the TALES section of the [Zope Page Templates Reference](#).

Depending on context, you may have access to a device, an event, or both. Following is a list of the attributes and methods you may want to use on device and event objects. The syntax for accessing device attributes and methods is `${dev/attributename}`. For example, to get the `manageIp` of a device you would use `${dev/manageIp}`. For events, the syntax is `${evt/attributename}`.

A command to ping a device might look like this. (The `${ . . }` is a TALES expression to get the `manageIp` value for the device.)

```
ping -c 10 ${device/manageIp}
```

## Examples

---

- DNS Forward Lookup (assumes `device/id` is a resolvable name)

```
host ${device/id}
```

- DNS Reverse Lookup

```
host ${device/manageIp}
```

- SNMP Walk

```
snmpwalk -v 2c -c${device/zSnmpCommunity} ${device/manageIp} system
```

To use these expressions effectively, you must know which objects, attributes, and methods are available, and in which contexts. Usually there is a device that allows you to access the device in a particular context. Contexts related to a particular event usually have event defined.

## TALES device attributes

The following table lists available device attributes.

Attribute	Description
getId	The primary means of identifying a device within the system
getManageIp	The IP address used to contact the device in most situations
productionState	The production status of the device: Production, Pre-Production, Test, Maintenance or Decommissioned. This attribute is a numeric value, use getProductionStateString for a textual representation.
getProductionStateString	Returns a textual representation of the productionState
snmpAgent	The agent returned from SNMP collection
snmpDescr	The description returned by the SNMP agent
snmpOid	The oid returned by the SNMP agent
snmpContact	The contact returned by the SNMP agent
snmpSysName	The system name returned by the SNMP agent
snmpLocation	The location returned by the SNMP agent
snmpLastCollection	When SNMP collection was last performed on the device. This is a DateTime object.
getSnmpLastCollectionString	Textual representation of snmpLastCollection
rackSlot	The slot name/number in the rack where this physical device is installed
comments	User entered comments regarding the device
priority	A numeric value: 0 (Trivial), 1 (Lowest), 2 (Low), 3 (Normal), 4 (High), 5 (Highest)
getPriorityString	A textual representation of the priority
getHWManufacturerName	Name of the manufacturer of this hardware
getHWProductName	Name of this physical product
getHWProductKey	Used to associate this device with a hardware product class
getOSManufacturerName	Name of the manufacturer of this device's operating system.
getOSProductName	Name of the operating system running on this device.
getOSProductKey	Used to associate the operating system with a software product class
getHWSerialNumber	Serial number for this physical device
getLocationName	Name of the Location assigned to this device
getLocationLink	Link to the system page for the assigned Location
getSystemNames	A list of names of the Systems this device is associated with
getDeviceGroupNames	A list of names of the Groups this device is associated with



Attribute	Description
getLastChangeString	When the last change was made to this device
getLastPollSnmpUpTime	Uptime returned from SNMP
uptimeStr	Textual representation of the SNMP uptime for this device
getPingStatusString	Textual representation of the ping status of the device
getSnmpStatusString	Textual representation of the SNMP status of the device

## TALES event attributes

The following table lists available event attributes.

Attribute	Description
agent	Collector name from which the event came (such as zensyslog or zentrap).
component	Component of the associated device, if applicable. (Examples: eth0, httpd.)
count	Number of times this event has been seen.
dedupid	Key used to correlate duplicate events. By default, this is: device, component, eventClass, eventKey, severity.
device	ID of the associated device, if applicable.
DeviceClass	Device class from device context.
DeviceGroups	Device systems from device context, separated by  .
eventClass	Event class associated with this device. If not specified, may be added by the rule process. If this fails, then will be /Unknown.
eventClassKey	Key by which rules processing begins. Often equal to component.
eventGroup	Logical group of event source (such as syslog, ping, or nteventlog).
eventKey	Primary criteria for mapping events into event classes. Use if a component needs further de-duplication specification.
eventState	State of event. 0 = new, 1 = acknowledged, 2 = suppressed.
evid	Unique ID for the event.
facility	syslog facility, if this is a syslog event.
firstTime	UNIX timestamp when event is received.
ipAddress	IP Address of the associated device, if applicable.
lastTime	Last time this event was seen and its count incremented.
Location	Device location from device context.
manager	Fully qualified domain name of the collector from which this event came.
message	Full message text.
nteventid	nt event ID, if this is an nt eventlog event.
priority	syslog priority, if this is a syslog event.
prodState	prodState of the device context.

Attribute	Description
severity	the severity of the event expressed as a number (0, 1, 2, 3, 4, or 5)
severityString	the severity of the event expressed as a string (Clear, Debug, Info, Warning, Error, or Critical)
stateChange	Time the MySQLrecord for this event was last modified.
summary	Text description of the event. Limited to 255 characters.
suppid	ID of the event that suppressed this event.
Systems	Device systems from device context, separated by  .

### Configuration properties and custom properties

Configuration properties and custom properties also are available for devices, and use the same syntax as shown in the previous sections.

## F

## Monitoring large file systems

---

By default, Resource Manager uses the Host Resources MIB to monitor file systems. A defect in the implementation of the Host Resources MIB in net-snmp causes file systems larger than 16TB to report incorrect utilization metrics, such that you might observe file system utilization values greater than 100%.

---

**Note** Resource Manager uses the Host Resources MIB in the ethernetCsmacd template (rather than the UCD dskTable MIB) by default because most of the systems Resource Manager monitors do not have the UCD dskTable MIB enabled.

---

To work around this deficiency, Resource Manager can instead use the UCD dskTable MIB to monitor file system utilization.

### Procedure

---

To use the UCD dskTable MIB, you must modify the configuration of your data sources, thresholds, and graphs in your FileSystem template:

- 1 Create an SNMP data source named dskPercent.
- 2 Set the OID of the new data source to:

```
1.3.6.1.4.1.2021.9.1.9
```

- 3 Modify your thresholds to use the dskPercent data point. Remove any calculations that were associated with the Host Resource MIB data point. The dskPercent data point is reported as an integer from 0 to 100.
- 4 Modify your graphs to use the dskPercent data point and thresholds.
- 5 Enable the UCD dskTable MIB on your managed hosts:
  - a Add the following line to your `/etc/snmp/snmpd.conf` file:

```
includeAllDisks 0%
```

- b Restart the `snmpd` daemon.

The UCD dskTable MIB associates different indexes with the file systems than the Host Resources MIB. As a result, you must remodel the devices to fetch the UCD dskTable indexes, and to begin plotting data on the dskPercent graph.



## Managing multi-realm networks

---

Resource Manager supports overlapping IP namespaces through the optional *ZenPacks.zenoss.MultiRealmIP* ZenPack.

---

**Note** This ZenPack is not installed when Resource Manager is installed. To download it, visit the [Zenoss Support](#) site.

---

With this ZenPack, Resource Manager can prefix a realm identifier to the IP addresses of a network, enabling unified monitoring.

There are two primary use cases for using multi-realm IP management.

- A large company that manages multiple locations that have the same network spaces defined across these multiple locations and as a result have created multiple overlapping IP spaces and Resource Manager needs a way to identify each separate IP space in the system.
- Service Providers responsible for monitoring multiple customers where the customers have created independent networks and IP spaces that are unique to their location, but not unique to the Service Provider.

The essential work flow for creating and using IP Realms is that first you need to create the IP realms and then associate these realms with a collector. The associations between IP Realms and actual devices is made automatically by the device's association with the collector. All devices on a collector are associated with the realm for that collector.

### Example system

---

The following diagram lays out an example setup. It has a central Resource Manager server in the 10.10.10.0/24 network. The network local to the server is considered the default network within the system. The default network is treated exactly the same as a Resource Manager system without this ZenPack installed.

There are two other networks shown (r1 and r2) which are behind a firewall and have the same IP space 192.168.0.0/24. Each realm has a distributed collector located within it. The collector can be accessed from the Resource Manager server using a IP translation from the firewall to map the address accessible from in front of the firewall to an address behind the firewall. Remote collectors in a multi-realm setup must be accessible from the central server using SSH.

Figure 147: Example IP realm

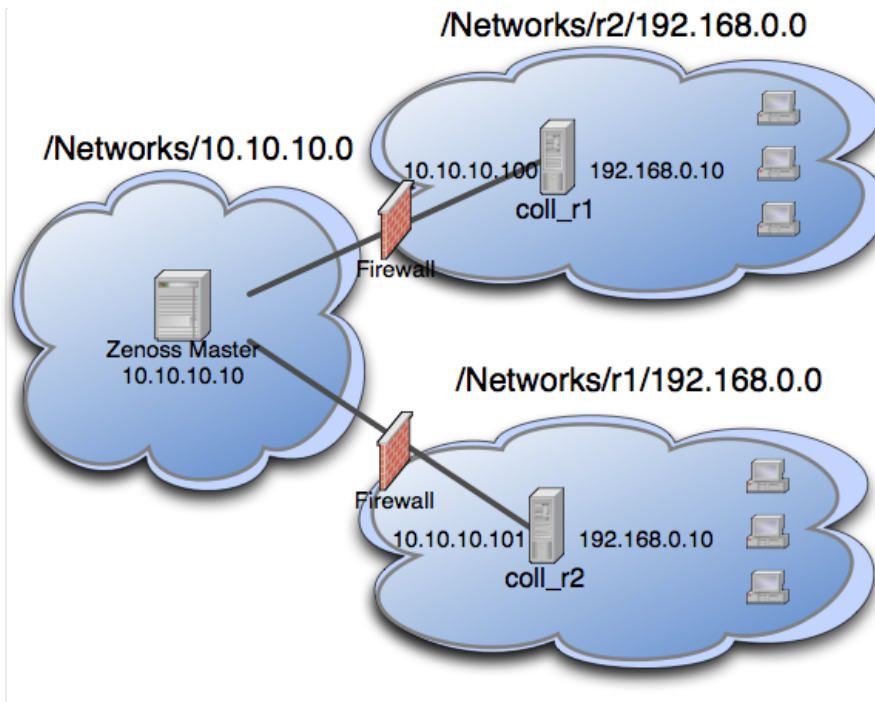

## System setup

Set up Resource Manager following the example system described previously.

**Note** Under multi-realm IP networks, device names *must* be unique even though the IP addresses will overlap.

On certain server configurations, if a distributed collector is configured, a "zenpack command failed" error occurs when installing this ZenPack. If you encounter this error, then run the following grant (as MySQL root):

```
grant super on *.* to 'zenoss'@'{FQDN_of_Zenoss_host}' identified by
'zenoss';
```

where the first 'zenoss' is the user account that Resource Manager uses to access MySQL, and the second 'zenoss' is that account's password.

## Adding realms

To add a realm:

- 1 Navigate to **Infrastructure > Networks**.
- 2 From the Add menu, select **Add IP Realm**. Add the realms r1 and r2.

## Adding collectors to realms

To add a collector to a realm:

- 1 Add the two collectors that are installed in each realm. Distributed collectors now have an **IP Realm** field on their configuration screen set each collector to the appropriate realm configured above.
- 2 Change each collector so that it is in the correct realm.

## Adding devices to realms

Perform the following to add devices to different realms:

- 1 Now we are ready to add devices to the system. As mentioned previously, adding the same device to the system twice can simulate a multi-realm setup. Add a device called `A.test` making sure that when it is added the collector is set to one of the remote collectors, and not `localhost`.
- 2 Rename the device.
- 3 Add the device a second time using a different remote collector, again not `localhost`.
- 4 After the device is loaded, select Software and follow the network link on one of the interfaces. Notice that the network has been created underneath the realm created earlier. This configuration is at the heart of multi-realm, as networks are discovered they are created within each realm. Monitoring is now happening on each representation of the device from the different collectors in different overlapping realms.

As another test try searching by IP from the top-level search. Two devices will be returned -- one within each realm.

## Notes

---

- If an event contains the unique name of a device then it is straight-forward to assign it to the proper device. If only the IP address is sent the event will be assigned by looking up the IP within the context of the realm.
- If a device is moved between realms it must be remodeled so that its IPs are placed in the proper location.
- The **Network Map** only supports the display the default realm.

# Glossary

## aggregation pools

A logical bundling of multiple physical network interfaces, commonly known as a port channel. For example, the Per Chassis Ethernet Pools includes all links from all chassis to all fabric interconnects which is used for chassis bandwidth balance comparison. For more examples, see the Aggregation Pools component section of CiscoUCS devices.

## bandwidth utilization

The total amount of bandwidth being used by an aggregation pool, a port, a fabric interconnect, a FEX, etc.

## component

Object contained by a device. Components include interfaces, OS processes, file systems, CPUs, and hard drives.

## data point

Data returned from a data source. In many cases, there is only one data point for a data source (such as in SNMP); but there may also be many data points for a data source (such as when a command results in the output of several variables).

## data source

Method used to collect monitoring information. Example data sources include SNMP OIDs, SSH commands, and perfmon paths.

## device

Primary monitoring object in the system. Generally, a device is the combination of hardware and an operating system.

## device class

Special type of organizer used to manage how the system models and monitors devices (through configuration properties and monitoring templates).

## discovery

Process by which Resource Manager gathers detailed information about devices in the infrastructure. Results of discovery are used to populate the model.

## event

Manifestation of important occurrence within the system. Events are generated internally (such as when a threshold is exceeded) or externally (such as through a syslog message or SNMP trap).

## event class

Categorization system used to organize event rules.

## event rules

Controls how events are manipulated as they enter the system (for example, changing the severity of an event). Configuration properties configure event rules.

## graph

Displays one or more data points, thresholds, or both.

## headroom

The unused bandwidth in an aggregation pool, a port, a fabric interconnect (FI), a FEX, etc. For example, if an aggregation pool including 4 ports between a chassis and the FIs has 40 GB of capacity and if the bandwidth use of that pool is 25 GB, then the headroom is 15 GB.

## managed resource

Servers, networks, virtual machines, and other devices in the IT environment.

**model**

Representation of the IT infrastructure. The model tells the system "what is out there" and how to monitor it.

**monitoring template**

Description of what to monitor on a device or device component. Monitoring templates comprise four main elements: data sources, data points, thresholds, and graphs.

**notification**

Sends email or pages to system users or groups when certain events occur.

**organizer**

Hierarchical system used to describe locations and groups within the application. Resource Manager also includes special organizers, which are classes that control system configuration.

**out of balance**

Indicates that the bandwidth use is quite different among the ports in an aggregation pool. This can often be corrected by reconfiguration, for example, by moving a service profile from one chassis to another.

**resource component**

Interfaces, services and processes, and installed software in the IT environment.

**service definition**

A service definition contains the information that Control Center needs to start and manage a service, in JavaScript Object Notation (JSON) format.

**service profile**

A service profile is a software definition of a server and its LAN and SAN network connectivity, in other words, a service profile defines a single server and its storage and networking characteristics.

**service template**

A service template contains one or more service definitions, in JavaScript Object Notation (JSON) format.

**threshold**

Defines a value beyond which a data point should not go. When a threshold is reached, the system generates an event. Typically, threshold events use the `/Capacity` event class.

**trigger**

Determines how and when notifications are sent. Specifies a rule comprising a series of one or more conditions.