

Microsoft®

Computer Basics

Student Edition
Complete



CustomGuide.com
Computer Courseware

© 2003 by CustomGuide, Inc. 1502 Nicollet Avenue South, Suite 1; Minneapolis, MN 55403

This material is copyrighted and all rights are reserved by CustomGuide, Inc. No part of this publication may be reproduced, transmitted, transcribed, stored in a retrieval system, or translated into any language or computer language, in any form or by any means, electronic, mechanical, magnetic, optical, chemical, manual, or otherwise, without the prior written permission of CustomGuide, Inc.

We make a sincere effort to ensure the accuracy of the material described herein; however, CustomGuide makes no warranty, expressed or implied, with respect to the quality, correctness, reliability, accuracy, or freedom from error of this document or the products it describes. Data used in examples and sample data files are intended to be fictional. Any resemblance to real persons or companies is entirely coincidental.

The names of software products referred to in this manual are claimed as trademarks of their respective companies. CustomGuide is a registered trademark of CustomGuide, Inc.

Table of Contents

Introduction	7
Chapter One: The Essentials	11
Lesson 1-1: Hardware, Software, and Information Technology (IT).....	12
Lesson 1-2: Computer Overview.....	14
Lesson 1-3: The Front of a Computer and Peripheral Devices.....	16
Lesson 1-4: The Inside of a Computer.....	18
Lesson 1-5: The Back of a Computer (Ports)	20
Lesson 1-6: System Bus and Expansion Cards.....	22
Lesson 1-7: Memory Cache.....	24
Lesson 1-8: Computer Performance	26
Lesson 1-9: Buying a Desktop Computer.....	28
Lesson 1-10: Buying a Notebook Computer	30
Lesson 1-11: Upgrading a Computer.....	32
Chapter One Review.....	34
Chapter Two: Understanding Hardware.....	37
Lesson 2-1: Central Processing Unit (CPU).....	38
Lesson 2-2: Memory.....	40
Lesson 2-3: RAM and ROM.....	42
Lesson 2-4: Mouse.....	44
Lesson 2-5: Keyboard.....	46
Lesson 2-6: Digital Cameras and Web Cams.....	48
Lesson 2-7: Other Input Devices	50
Lesson 2-8: Monitor	52
Lesson 2-9: Graphics Card	54
Lesson 2-10: Printer Basics	56
Lesson 2-11: Types of Printers.....	58
Lesson 2-12: Sound and Speakers	60
Lesson 2-13: Modem	62
Lesson 2-14: Input/Output Devices	63
Lesson 2-15: Hard Drive	64
Lesson 2-16: Hard Drive Maintenance.....	66
Lesson 2-17: CD-ROM Drive	68
Lesson 2-18: DVD Drive.....	70
Lesson 2-19: Floppy Drive	72
Lesson 2-20: Zip and Jaz Drives	73
Lesson 2-21: Other Storage Devices.....	74
Lesson 2-22: Formatting a Disk	75
Chapter Two Review	76
Chapter Three: Understanding Software.....	81

Lesson 3-1: Understanding Graphical User Interfaces.....	82
Lesson 3-2: Types of Software.....	83
Lesson 3-3: Operating Systems.....	84
Lesson 3-4: Word Processing.....	86
Lesson 3-5: Spreadsheets.....	87
Lesson 3-6: Databases.....	88
Lesson 3-7: Presentation Software.....	90
Lesson 3-8: Accounting.....	91
Lesson 3-9: Web Browsing.....	92
Lesson 3-10: Web Authoring.....	93
Lesson 3-11: Programming Languages.....	94
Lesson 3-12: Systems Development.....	96
Chapter Three Review.....	98
Chapter Four: Information Networks.....	101
Lesson 4-1: Introduction to Networks.....	102
Lesson 4-2: The Internet.....	104
Lesson 4-3: Intranets and Extranets.....	106
Lesson 4-4: Telephones and Networks.....	108
Chapter Four Review.....	110
Chapter Five: Introduction to Windows XP.....	113
Lesson 5-1: Starting and Logging On to Windows.....	114
Lesson 5-2: Understanding the Windows XP Screen.....	116
Lesson 5-3: Using the Mouse: Pointing, Clicking, and Double-clicking.....	118
Lesson 5-4: Using the Mouse: Dragging and Dropping.....	120
Lesson 5-5: Using the Mouse: Right-clicking.....	122
Lesson 5-6: Using the Keyboard.....	124
Lesson 5-7: Exiting Windows and Turning off Your Computer.....	126
Chapter Five Review.....	128
Chapter Six: Working with a Window.....	131
Lesson 6-1: Starting a Program.....	132
Lesson 6-2: Understanding the Parts of a Window.....	134
Lesson 6-3: Minimizing, Maximizing, and Restoring a Window.....	136
Lesson 6-4: Closing a Window.....	138
Lesson 6-5: Moving a Window.....	139
Lesson 6-6: Sizing a Window.....	140
Lesson 6-7: Switching Between Windows.....	142
Chapter Six Review.....	144
Chapter Seven: Working with Programs.....	147
Lesson 7-1: How to Use Menus.....	148
Lesson 7-2: How to Use Toolbars.....	150
Lesson 7-3: Filling Out a Dialog Box.....	152
Lesson 7-4: Entering Text in the WordPad Program.....	154
Lesson 7-5: Editing Text.....	156
Lesson 7-6: Saving and Opening a File.....	158
Lesson 7-7: Selecting, Replacing, and Deleting Text.....	160
Lesson 7-8: Using Undo.....	162
Lesson 7-9: Printing a File.....	163
Lesson 7-10: Cutting, Copying, and Pasting Text.....	164
Lesson 7-11: Changing the Font Type and Size.....	166
Lesson 7-12: Using Bold, Italics, and Underline.....	168
Lesson 7-13: Changing Paragraph Alignment.....	169
Lesson 7-14: Getting Help by Contents.....	170
Lesson 7-15: Getting Help with the Help Index and Search.....	172

Lesson 7-16: Saving and Opening Files in Different Locations	174
Chapter Seven Review	176
Chapter Eight: Working with Files and Folders	183
Lesson 8-1: Understanding Storage Devices, Folders, and Files	184
Lesson 8-2: Using My Computer to See What's in Your Computer	186
Lesson 8-3: Opening a Folder	188
Lesson 8-4: Creating and Renaming a Folder	190
Lesson 8-5: Copying, Moving, and Deleting a Folder	192
Lesson 8-6: Opening, Renaming, and Deleting a File	194
Lesson 8-7: Copying and Moving a File	196
Lesson 8-8: Restoring a Deleted File and Emptying the Recycle Bin	198
Lesson 8-9: A Closer Look at Files and Folders	200
Lesson 8-10: Changing How Information is Displayed	202
Lesson 8-11: Selecting Multiple Files and Folders	204
Lesson 8-12: Finding a File Using the Search Companion	206
Lesson 8-13: Using the Folders Pane (Windows Explorer)	208
Lesson 8-14: File Management Using the Folders Pane	210
Chapter Eight Review	212
Chapter Nine: Exploring the Internet	219
Lesson 9-1: Introduction to the Internet	220
Lesson 9-2: Connecting to the Internet	222
Lesson 9-3: Displaying a Specific Web Page	224
Lesson 9-4: Browse the Web	226
Lesson 9-5: Search the Web	228
Lesson 9-6: Adding a Web Page to Favorites and Changing your Home Page	230
Lesson 9-7: Displaying a History of Visited Web Pages	232
Lesson 9-8: Saving Pictures and Files to Disk (Downloading)	234
Lesson 9-9: Introduction to E-mail	236
Lesson 9-10: Composing and Sending E-mail	238
Lesson 9-11: Adding a Name to the Address Book	240
Lesson 9-12: Receiving E-mail	242
Lesson 9-13: Replying to a Message	244
Lesson 9-14: Forwarding and Deleting a Message	245
Chapter Nine Review	246
Index	251

Introduction

Welcome to CustomGuide: Computer Basics. CustomGuide courseware allows instructors to create and print manuals that contain the specific lessons that best meet their students' needs. In other words, this book was designed and printed just for you.

Unlike most other computer-training courseware, each CustomGuide manual is uniquely designed to be three books in one:

- Step-by-step instructions make this manual great for use in an instructor-led class or as a self-paced tutorial.
- Detailed descriptions, illustrated diagrams, informative tables, and an index make this manual suitable as a reference guide when you want to learn more about a topic or process.
- The handy Quick Reference box, found on the last page of each lesson, is great for when you need to know how to do something quickly.

CustomGuide manuals are designed both for users who want to learn the basics of the software and those who want to learn more advanced features.

Here's how a CustomGuide manual is organized:

Chapters

Each manual is divided into several chapters. Aren't sure if you're ready for a chapter? Look at the prerequisites that appear at the beginning of each chapter. They will tell you what you should know before you start the chapter.

Lessons

Each chapter contains several lessons on related topics. Each lesson explains a new skill or topic and contains a step-by-step exercise to give you hands-on-experience.

Chapter Reviews

A review is included at the end of each chapter to help you absorb and retain all that you have learned. This review contains a brief recap of everything covered in the chapter's lessons, a quiz to assess how much you've learned (and which lessons you might want to look over again), and a homework assignment where you can put your new skills into practice. If you're having problems with a homework exercise, you can always refer back to the lessons in the chapter to get help.

How to Use the Lessons

Every topic is presented on two facing pages, so that you can concentrate on the lesson without having to worry about turning the page. Since this is a hands-on course, each lesson contains an exercise with step-by-step instructions for you to follow.

To make learning easier, every exercise follows certain conventions:

- Anything you're supposed to click, drag, or press appears **like this**.
- Anything you're supposed to type appears **like this**.
- This book never assumes you know where (or what) something is. The first time you're told to click something, a picture of what you're supposed to click appears either in the margin next to the step or in the illustrations at the beginning of the lesson.

Illustrations show what your screen should look like as you follow the lesson. They also describe controls, dialog boxes, and processes.

An easy-to-understand introduction explains the task or topic covered in the lesson and what you'll be doing in the exercise.

Tips and traps appear in the margin.

Icons and pictures appear in the margin, showing you what to click or look for.

Clear step-by-step instructions guide you through the exercise. Anything you need to click appears **like this**.

24 Microsoft Excel 2000

Lesson 4-2: Formatting Values

Figure 4-3
The Numbers tab of the Format Cells dialog box.

Figure 4-4
The Expense Report worksheet values before being formatted.

Figure 4-5
The Expense Report worksheet values after being formatted.

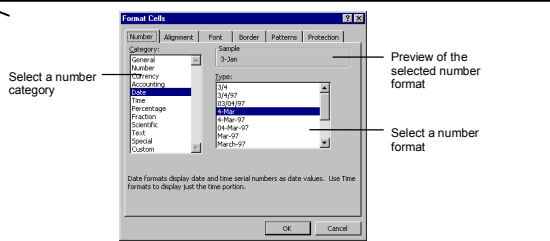

Figure 4-3

Expense Report							Expense Report						
Date	Type	Payment	Price Per	Quantity	Tax	Total	Date	Type	Payment	Price Per	Quantity	Tax	Total
1/5/99	Mileage	0.32	46	0	14.72		3-Jan-99	Mileage	\$0.32	46	0.0%		14.72
1/5/99	Parking	Cash	27	1	0	27	3-Jan-99	Parking	Cash	\$7.20	1	0.0%	7.20
1/5/99	Cell Phone	AMEX	0.15	23	0.066	4.95475	3-Jan-99	Cell Phone	AMEX	\$0.15	23	0.0%	4.96
1/5/99	Mileage	0.32	36	0	11.2		5-Jan-99	Mileage		\$0.32	36	0.0%	11.20
1/5/99	Autoln	VISA	1299	1	0.01	1302	5-Jan-99	Autoln	VISA	\$1,299.00	1	1.0%	1302.00
1/7/99	Lodging	Check	69	1	0.09	75.3	7-Jan-99	Lodging	Check	\$69.00	1	9.0%	75.30
1/7/99	Meals	AMEX	8.5	1	0.07	9.165	7-Jan-99	Meals	AMEX	\$8.50	1	7.0%	9.17
1/7/99	Taxi	Cash	22	1	0	22	7-Jan-99	Taxi	Cash	\$22.00	1	0.0%	22.00
1/8/99	Incidental's	VISA	14.99	1	0.07	16.1099	8-Jan-99	Incidental's	VISA	\$14.99	1	7.0%	16.11
1/8/99	Postage	Cash	2.75	1	0	2.75	8-Jan-99	Postage	Cash	\$2.75	1	0.0%	2.75
1/10/99	Mileage	0.32	64	0	20.48		10-Jan-99	Mileage		\$0.32	64	0.0%	20.48
1/11/99	Other	VISA	15	1	0.066	16.04	11-Jan-99	Other	VISA	\$15.00	1	0.5%	16.04
1/12/99	Cell Phone Call	0.15	10	0	1.5		12-Jan-99	Cell Phone Call		\$0.15	10	0.0%	1.50

Figure 4-4

Figure 4-5

You can also format values by using the Formatting toolbar or by selecting **Format → Cells** from the menu and clicking the **Number** tab.



In this lesson, you will learn how to apply number formats. Applying *number formatting* changes how values are displayed—it doesn't change the actual information in any way. Excel is often smart enough to apply some number formatting automatically. For example, if you use a dollar sign to indicate currency (such as \$548.67), Excel will automatically apply the currency number format for you.

The Formatting toolbar has five buttons (Currency, Percent, Comma, Increase Decimal, and Decrease Decimal) you can use to quickly apply common number formats. If none of these buttons has what you're looking for, you need to use the Format Cells dialog box by selecting **Format → Cells** from the menu and clicking the Number tab. Formatting numbers with the Format Cells dialog box isn't as fast as using the toolbar, but it gives you more precision and formatting options. We'll use both methods in this lesson.

1. **Select the cell range D5:D17 and click the **Comma Style** button on the **Formatting toolbar**.**
Excel adds a hundreds separator (the comma) and two decimal places to the selected cell range.

- When you see a keyboard instruction like “press **<Ctrl> + **,” you should press and hold the first key (<Ctrl> in this example) while you press the second key (in this example). Then, after you’ve pressed both keys, you can release them.
- There is usually more than one way to do something in Word. The exercise explains the most common method of doing something, while the alternate methods appear in the margin. Use whatever approach feels most comfortable for you.
- Important terms appear in *italics* the first time they’re presented.
- Whenever something is especially difficult or can easily go wrong, you’ll see a:

NOTE:

immediately after the step, warning you of pitfalls that you could encounter if you’re not careful.

- Our exclusive Quick Reference box appears at the end of every lesson. You can use it to review the skills you’ve learned in the lesson and as a handy reference—when you need to know how to do something fast and don’t need to step through the sample exercises.

Formatting a Worksheet **25**

2. **Click cell A4 and type Annual Sales.**
The numbers in this column should be formatted as currency.
3. **Press <Enter> to confirm your entry and overwrite the existing information.**
4. **Select the cell range G5:G17 and click the Currency Style button on the Formatting toolbar.**
A dollar sign and two decimal places are added to the values in the selected cell range.
5. **Select the cell range F5:F17 and click the Percent Style button on the Formatting toolbar.**
Excel applies percentage style number formatting to the information in the Tax column. Notice there isn’t a decimal place—Excel rounds any decimal places to the nearest whole number. That isn’t suitable here—you want to include a decimal place to accurately show the exact tax rate.
6. **With the Tax cell range still selected, click the Increase Decimal button on the Formatting toolbar.**
Excel adds one decimal place to the information in the tax rate column.
 Next, you want to change the date format in the date column. There isn’t a “Format Date” button on the Formatting toolbar, so you will have to format the date column using the Format Cells dialog box.
 The Formatting toolbar is great for quickly applying the most common formatting options to cells, but it doesn’t offer every available formatting option. To see and/or use every possible character formatting option you have to use the Format Cells dialog box. You can open the Format Cells dialog box by either selecting **Format** → **Cells** from the menu or right-clicking and selecting **Format Cells** from the shortcut menu.
7. **With the Date cell range still selected, select **Format** → **Cells** from the menu, select **4-Mar-97** from the Type list box and click **OK**.**

That’s all there is to formatting values—not as difficult as you thought it would be, was it? The following table lists the five buttons on the Formatting toolbar you can use to apply number formatting to the values in your worksheets.

Table 4-2: Number Formatting Buttons on the Formatting Toolbar

Button Name	Example	Formatting
Currency	\$1,000.00	Adds a dollar sign, comma, and two decimal places.
Percent	100%	Displays the value as a percentage with no decimal places.
Comma	1,000	Separates thousands with a comma.
Increase Decimal	1000.00	Increases the number of digits after the decimal point by one
Decrease Decimal	1000.0	Decreases the number of digits after the decimal point by one

Quick Reference

To Apply Number Formatting:

- Select the cell or cell range you want to format and click the appropriate number formatting button(s) on the Formatting toolbar.
- Or...
- Select the cell or cell range you want to format, select **Format** → **Cells** from the menu, click the **Number** tab, and specify the number formatting you want to apply.
- Or...
- Select the cell or cell range you want to format, right-click the cell or cell range and select **Format Cells** from the shortcut menu, click the **Number** tab, and specify the number formatting you want to apply.

Anything you need to type appears *like this*.

Whenever there is more than one way to do something, the most common method is presented in the exercise and the alternate methods are presented in the margin.

Tables provide summaries of the terms, toolbar buttons, or shortcuts covered in the lesson.

CustomGuide’s exclusive Quick Reference is great for when you need to know how to do something fast. It also lets you review what you’ve learned in the lesson.

Chapter One: The Essentials

Chapter Objectives:

- Learn the difference between hardware and software
- Discover the various types of computers and their roles
- See what's on the front, back, and inside of a computer
- Learn about the various ports on a computer
- Understand what determines a computer's performance
- See what you should look for when buying a computer

Prerequisites

- A desire to learn about computers.

Computers are useful: they help us write letters, find information on the Internet, and even create our own music CDs. Some people *love* computers—they speak a different language that includes nonsensical words like *IP address* and *gigabytes*. But most of us are somewhat clueless when it comes to computers. We know how to turn our computer on, how to surf the Internet (maybe), and how to write a quick letter on a word processor. But that's about it—we have to ask our kids or friends for help when something goes wrong, which is all the time.

This guide takes some of the mystery out of computers. In this chapter we'll take a good hard look at a computer from the front, back, and yes, even inside. You'll understand what all those confusing ports on the back of the computer are for and why it's important for your computer to have a fast *CPU*. Best of all, we'll explain all of this in simple terms, so you won't need an engineering degree to understand everything.

Ready to tackle your computer? Great—turn the page and let's get started...

Lesson 1-1: Hardware, Software, and Information Technology (IT)

Figure 1-1

A typical computer setup.

Figure 1-2

Microsoft Word is an example of a software application.

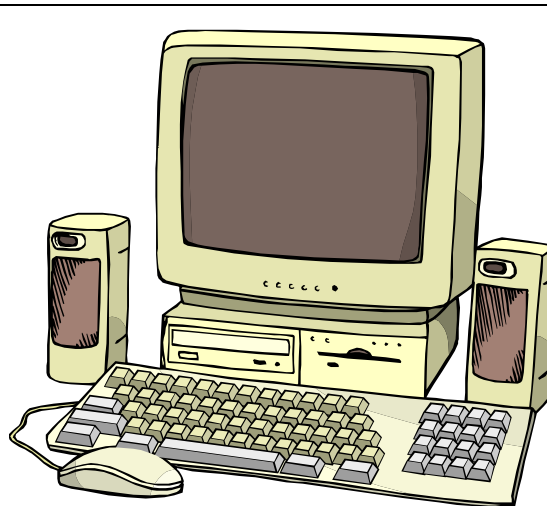

Figure 1-1

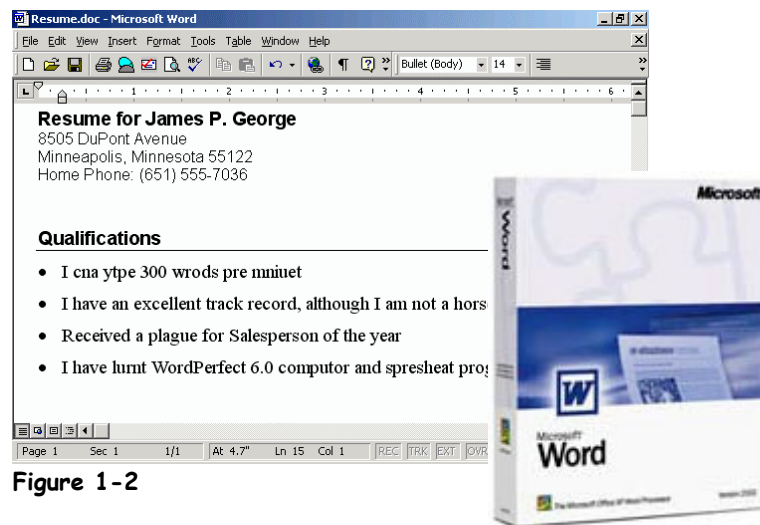

Figure 1-2

Your desk probably contains a jumble of equipment commonly known as a computer. But what is all that stuff? What does a computer do? Unlike many other tools or appliances that have limited purposes, a computer can do any number of things:

- Write letters
- Browse the Internet
- Send e-mail messages to people around the world
- Play games
- Help you balance your budget

...and that's just the beginning of what you can do with a computer!

Two basic components make up a computer: *hardware* and *software*. You simply can't have one without the other. All computer parts that you can physically see or touch are called *hardware*. Hardware includes the computer's monitor, case, keyboard, mouse, and printer. Computer programs that tell hardware how to operate are called *software*. You may have used software such as Microsoft Excel or Corel WordPerfect in the past. So breathe a giant sigh of relief—you don't have to know how to program a computer to use one. A computer programmer has already done the work for you by writing the program (software). All you have to do is tell the software what you're trying to do, and the software then directs the work of the hardware.

Figure 1-1 shows an example of a typical computer setup and its components, but don't worry if your setup is different. More than likely, you have all the parts that you need, and those parts are properly connected. In any case, Table 1-1: *Parts of a Computer*, provides more details about each individual component.

IT, short for *Information Technology*, is the broad subject related to computers and managing and processing information, especially within large organizations. Many large companies have departments full of computer experts called *IT departments*.



Your computer setup may differ from the one shown in Figure 1-1. For example, you might have a computer case that is tall and skinny (tower case) or a flat screen monitor.

Table 1-1: Parts of a Computer

Component	Description
Case or System Unit	The main computer box, technically known as the <i>system unit</i> , is the most important part of a computer. It contains the guts and brains of the computer—something we'll talk about later. The system unit contains a lot of holes or <i>ports</i> where you plug in the rest of the computer system.
Monitor	The monitor resembles a television set, and is where the computer displays information.
Keyboard	The keyboard is the thing you type on to tell your computer what to do.
Mouse	Like the keyboard, the mouse is another <i>input device</i> that you use to communicate with your computer.
Speakers	Most computers can make sounds, just like a stereo system. In fact, you can even listen to audio CD's on most computers or watch DVDs.
Printer	A printer is where a computer writes down information or <i>output</i> , onto paper, or a <i>hardcopy</i> .

Quick Reference

A typical computer includes the following:

- System unit
- Monitor
- Keyboard
- Mouse
- Speakers
- Printer

Hardware:

- A computer item you can physically see or touch.

Software:

- A computer program that tells computer hardware how to operate.

IT:

- Information Technology is the broad subject related to computers and managing and processing information.

Lesson 1-2: Computer Overview

Figure 1-3

How a computer works.

Figure 1-4

Comparing a TV to a PC.

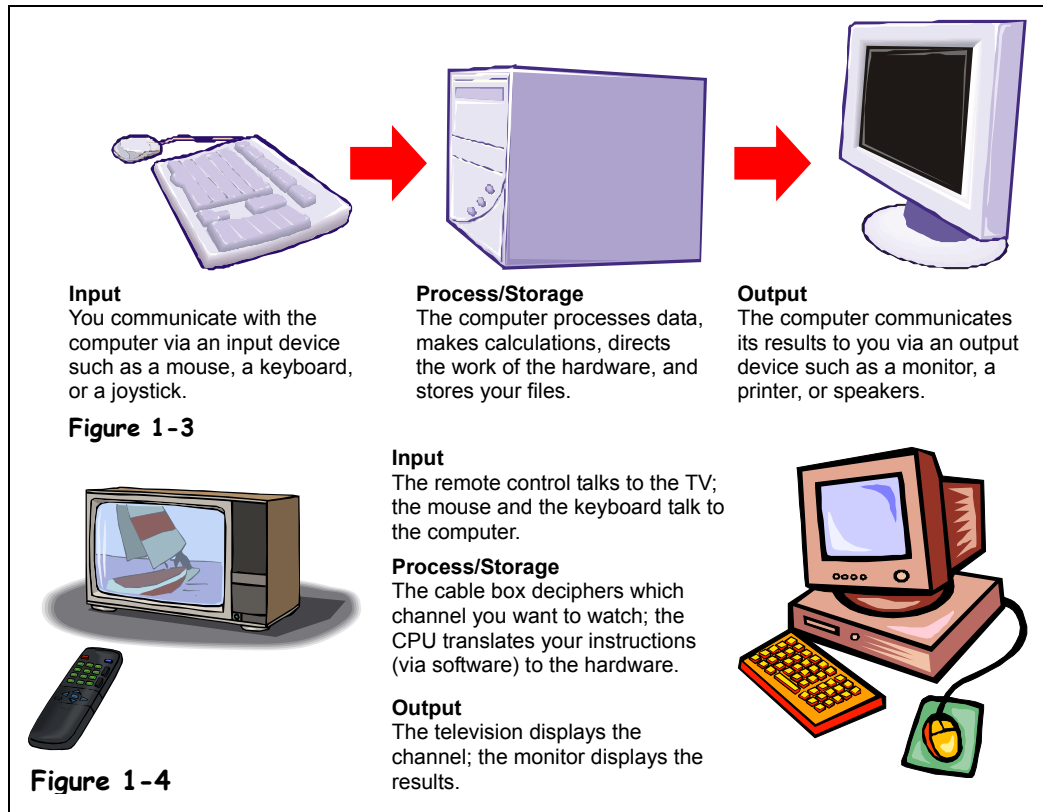

Computers are not really as complicated as they initially seem. You just have to learn the basic functions of the various parts, and then you can separate them into three categories:

- **Input**
Any device that lets you talk to the computer (such as a mouse or keyboard).
- **Process/Storage**
Main functions of a computer, which happen inside the computer case. Not surprisingly, the Central Processing Unit (CPU) does all the processing; the storage function is handled by any number of drives (hard, floppy, Zip, tape-backup, CD/DVD-ROM) or disks (compact discs or floppy diskettes).
- **Output**
Any device that lets the computer talk to you (such as a monitor or speakers).

If you're having trouble understanding this input/output stuff, think of your home television (TV) set. Televisions and computers are similar in several ways:



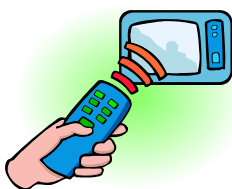



- The remote control is comparable to the mouse (or any other input device such as a mouse or joystick).
- The cable box (while not nearly as powerful as a computer) is similar to a computer in that it can process information (such as deciphering which channel you want to watch) and, if programmable, store information (such as when to show the film using a built-in timer).
- The TV displays the channel much like a monitor displays information.



A remote control communicates with a television much like a mouse communicates with a computer.

There are several different types of computer systems out there. Here's a very brief description of the most common ones...

Table 1-2: Types of Computers

Computer	Description
 <p>Mainframe</p>	<p>A mainframe is a big, powerful, expensive computer that can support many users at the same time. Large businesses and organizations use mainframes.</p> <p>Capacity: Enormous - the capacity of several hundred or even thousands of PCs Speed: Very fast - much, much faster than a PC Cost: Very, very expensive - can usually only be afforded by large organizations Users: Only used by large businesses and organizations</p>
 <p>PC</p>	<p>A PC is a <i>personal computer</i>, originally designed by IBM way back in 1981. Many different companies make PCs, but all of them are IBM-compatible. What this means, according to Bill Gates, is that they will all run Microsoft Windows.</p> <p>Capacity: Average hard disk size is 20 GB to 80 GB Speed: Fast. Average speed is from 1 GHz to 3 GHz Cost: Fairly inexpensive - under \$1,000 - and getting cheaper every day! Users: Just about everyone uses a PC! Homes, offices, schools...</p>
 <p>Mac</p>	<p>Developed by Apple, a Macintosh is a computer, but it is NOT a PC. Macs have a different operating system and use their own software and hardware.</p> <p>Capacity: Average hard disk size is 20 GB to 80 GB Speed: Fast. Average speed is from 500 MHz to 2 GHz Cost: Fairly inexpensive, but usually more than an equivalent PC Users: Just about everyone, especially in the education and design fields</p>
 <p>Networked Computer</p>	<p>A network is a group of computers that are connected so that they can share equipment and information. Most people on a network use <i>workstations</i>, which are simply PCs that are connected to the network. A <i>server</i> is a central computer where users on the network can save their files and information.</p> <p>Capacity: (Workstation) Same as a PC, only needs an inexpensive network card (Server) Greater than a PC, often more than 100 GB Speed: (Workstation) Same as a PC (Server) Generally faster than a PC, may use multiple CPUs Cost: (Workstation) Same as a PC (Server) More expensive than a PC but not as costly as a mainframe Users: (Workstation) People in a networked office or organization (Server) Generally a network administrator or engineer</p>
 <p>Laptop</p>	<p>A laptop, or notebook, is a lighter and more portable version of a PC or Mac that can run on batteries.</p> <p>Capacity: Average hard disk size is 10 GB to 40 GB Speed: Fast, but slightly less than a PC. Average speed is from 700 MHz to 2 GHz Cost: Fairly inexpensive, but more than an equivalent PC Users: People on the move, especially business people and students</p>
 <p>Palmtop/PDA</p>	<p>A PDA (Personal Data Assistant) is a handheld computer that is generally used to keep track of appointments and addresses.</p> <p>Capacity: Much smaller than a PC - 8 MB to 64 MB of storage space Speed: Much slower than a PC - 8 MHz to 266 MHz Cost: Expensive when compared to the capacities of a PC Users: Business people and others who need to be organized</p>

Quick Reference

The Basic Computer Processes Are:

1. Input
2. Processing
3. Output

Different Types of Computers Include:

- Mainframes
- PCs
- Macs
- Servers
- Laptops
- Palmtops or PDAs

Lesson 1-3: The Front of a Computer and Peripheral Devices

Figure 1-5

The front of a computer case.

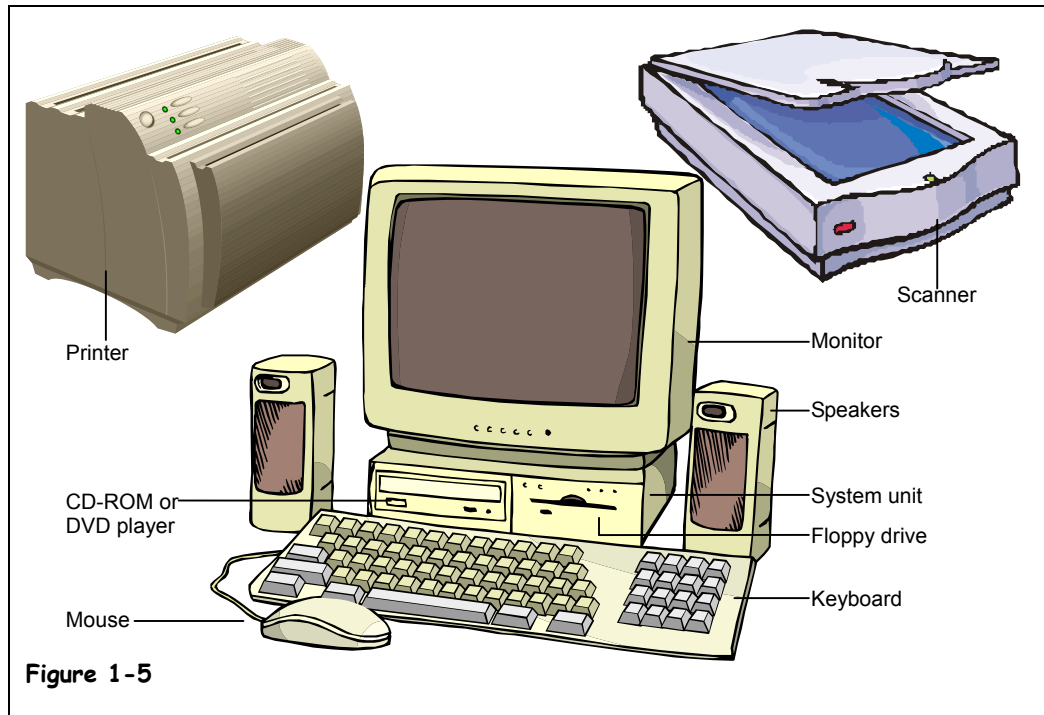

Figure 1-5

The system unit or computer case is that plastic box that sits under your monitor or desk and is covered with slots, buttons, and lights. Computer cases come in several shapes and sizes. Older computers often have the horizontal desktop case, which has gradually been replaced by the vertical tower case. Manufacturers are now phasing out the tallest towers because the compact size of the smallest tower, known as a *mini-tower*, is attractive to consumers.

Everything outside of and connected to the system unit is called *peripherals*. You can add dozens of peripherals and accessories to make it more useful and fun. Common peripherals include printers, scanners, external hard drives, CD-ROM drives, and digital cameras. Many peripherals are considered to be *input devices*, because they allow you to talk to your computer by inputting information. Other peripherals are *output devices*, because they let your computer talk back to you. One more thing: all peripherals are considered to be part of a computer's hardware.

Table 1-3: What's on the Front or Outside of a Computer Case?

Item	Description
System Unit or Computer Case	A plastic or metal case with slots, buttons, and lights in the front and holes in the back. This is the most important part of a computer because it contains the Central Processing Unit (CPU). The system unit directs the computer, performs calculations, and stores information.
Floppy Drive	Reads and writes to 3½-inch floppy disks. A floppy disk can store about 1.5 MB of information—about as much as a novel.

<i>Item</i>	<i>Description</i>	
Hard Drive (Not shown)	The computer's main, long-term storing device. Unlike floppy disks and CD-ROMs, you typically cannot remove a hard disk.	
CD-ROM or DVD Drive	<p>CD-ROMs and DVDs for your computer can store lots of information and look exactly like CDs for your stereo and DVDs for your home DVD player. In fact, you can listen to audio CDs on a CD-ROM drive and even watch DVD movies on a DVD drive.</p> <p>The only real difference between a CD-ROM and a DVD is how much information they can store. A CD-ROM can store approximately 650MB (megabytes) of information, while a DVD can store much more—up to 17 GB (gigabytes) or 17,000MB on a double-sided DVD.</p> <p>Most CD-ROMs and DVD are <i>read-only</i>, meaning you can't write information to them. You can buy special CD-ROM and DVD drives that <i>can</i> write or burn information to special CD-R, CD-RW, DVD-R, and DVD-RW discs.</p>	
Zip Drive (Not shown)	A special type of disk drive that can read and write to Zip disks. A Zip disk is a lot like a floppy disk, although they are faster and can store more information—from 100 to 250MB (megabytes).	
Tape Backup (Not shown)	A device that you can use to store backups, or copies, of the information on a computer's hard drive.	
Input Devices	Keyboard	The keyboard is the thing you type on to tell your computer what to do.
	Mouse	Like the keyboard, the mouse is another <i>input device</i> that you use to communicate with your computer.
	Scanner	Scanners work like photocopiers, except the image is translated into a digital image in your computer rather than copied onto paper.
Output Devices	Monitor	The monitor resembles a television set, and is where the computer displays information.
	Speakers	If visible, your computer speakers are similar to those on a stereo system (or at least a cheap stereo system). They allow your computer to play sounds.
	Printer	A printer is where a computer writes down information or <i>output</i> , onto paper, or a <i>hardcopy</i> .

 **Quick Reference**
Components Visible from the Outside of the System Unit May Include:

- Floppy drive
- CD-ROM or DVD drive
- Zip drive or tape backup
- Keyboard
- Mouse
- Scanner
- Monitor
- Speakers
- Printer

Lesson 1-4: The Inside of a Computer

Figure 1-6

The side view of the guts of a tower case.

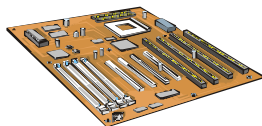
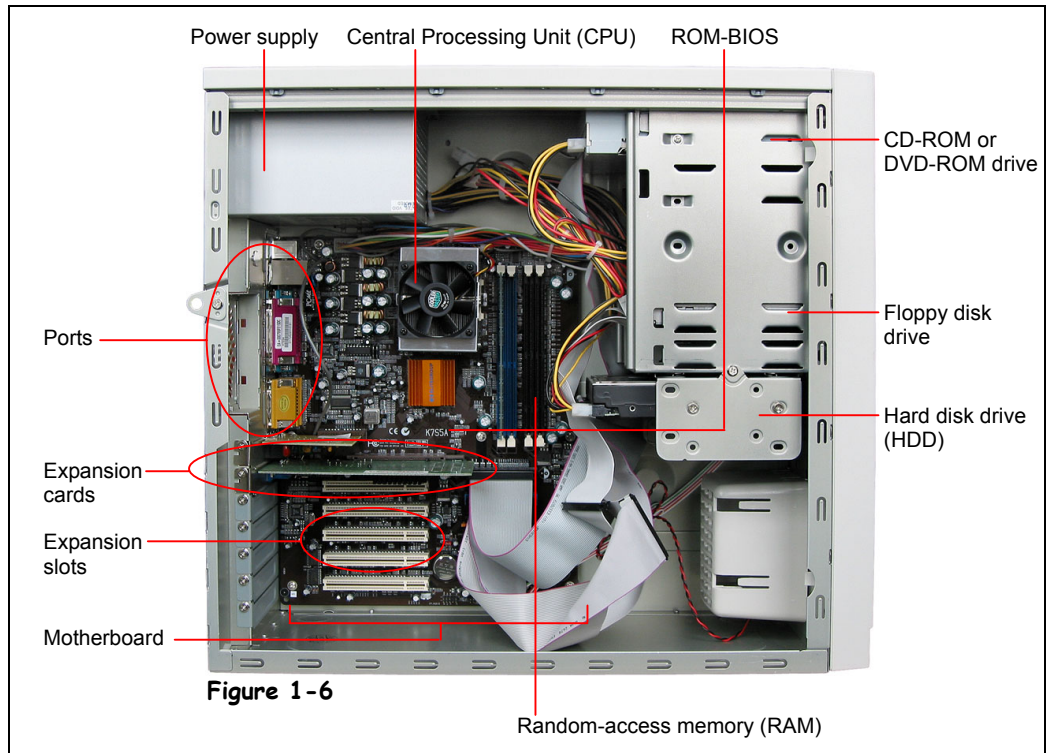

Everything plugs into a computer's motherboard.

Now that you know what's on the outside, let's crank open that mysterious computer case and look inside. But no tools required—we've done all the work for you. Just compare Figure 1-6 with Table 1-4: *What's Inside a Computer Case?* to see what's important.

Table 1-4: What's Inside a Computer Case?

Item	Description
Motherboard	The main piece of circuitry in a computer. Everything connects to or is wired to the motherboard.
Central Processing Unit (CPU)	The computer's brain or heart, the CPU is a computer's main chip. The CPU is really nothing more than an incredibly fast and powerful calculator.
Random Access Memory (RAM)	A computer's temporary storage place, where it gets its work done. For example, when you use a word processor to type a letter, the letter is stored in the computer's memory.
ROM-BIOS	A computer's ROM-BIOS (stands for Read Only Memory – Basic Input/Output System) is a special chip with instructions for the computer to communicate with other hardware parts.
Expansion Slot	An expansion slot lets you add more features and capabilities to a computer by plugging in expansion cards.

<i>Item</i>	<i>Description</i>
Expansion Card	A card that allows you to expand your computer's capabilities, such as a modem card, a network card, a video card, or a sound card.
PCMCIA Cards	Notebook computers are too small to use expansion cards, so they use special credit-card sized PCMCIA cards instead. You plug in a PCMCIA card, or PC Card, into a notebook computer to give it more features and capabilities. Nobody's getting tested on this, but PCMCIA stands for Personal Computer Memory Card International Association.

 **Quick Reference****Components Inside the System Unit May Include:**

- Motherboard
- CPU (Central Processing Unit)
- RAM (Random Access Memory)
- ROM-BIOS
- Expansion slots and cards
- PCMCIA cards (laptops only)

Lesson 1-5: The Back of a Computer (Ports)

Figure 1-7

The back of a computer case.

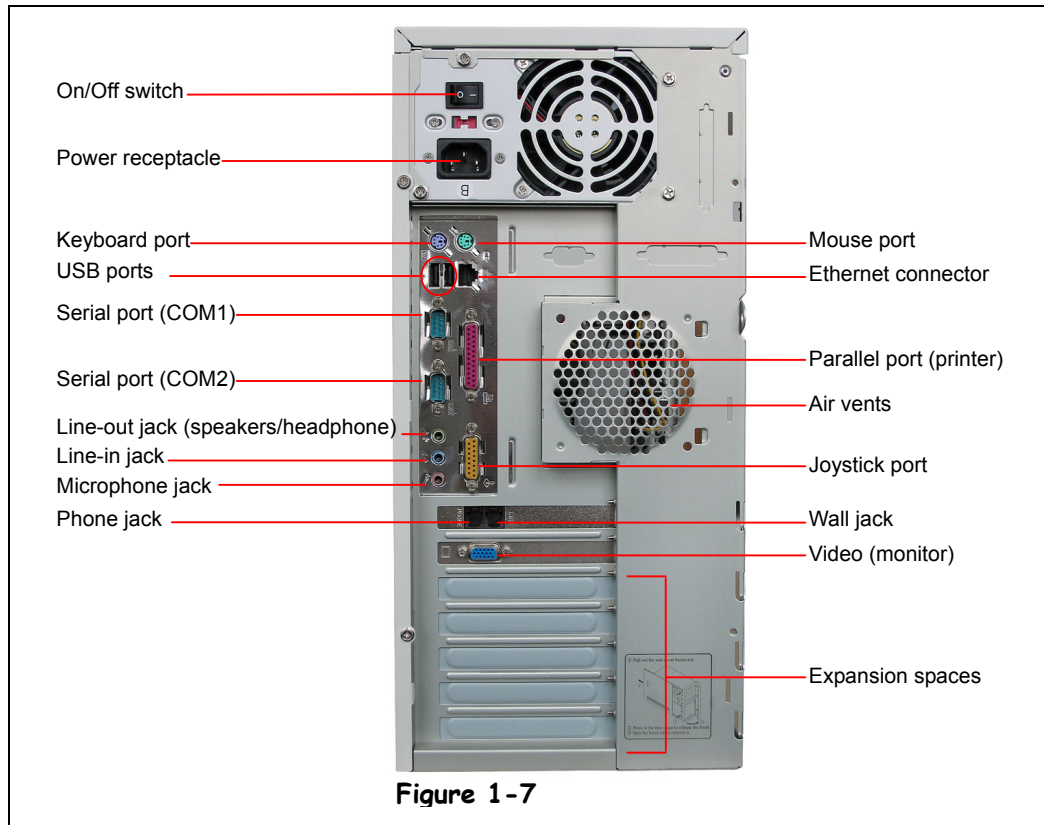
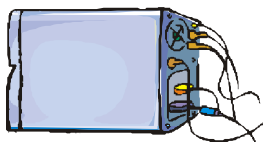

Figure 1-7













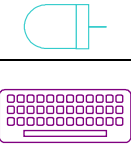









You may feel a bit overwhelmed the first time you look at the back of a computer.

When you look at the back of a computer, you may feel a bit overwhelmed by all the slots and holes. Fortunately, manufacturers have added some fairly standard icons and color coding to help you identify what should be plugged into your computer and where. Before long, you'll recognize those icons and colors, and the configuration won't seem so mysterious. It's rather like hooking up cable and a DVD player to the back of your television—unless you're one of those people who just wait for the cable guy to take care of that heinous task. In any case, this lesson will review each item piece by piece so you won't get completely lost.

Before we begin, let's define a couple of terms. The first thing you'll notice is that the back of your computer has lots of holes. Those holes are called (depending on who you ask) *jacks*, *ports*, or *connectors*. You may notice that some of the connectors have holes, but some have what look like stickpins (which are aptly named *pins*). The ones that have holes are called *female* connectors; the ones that have pins are called *male* connectors. Let's leave it at that.

Now let's begin. Compare Figure 1-7 to Table 1-5: *What's on the Back of a Computer Case?* The back of your computer may be arranged differently but should include the same elements.

Table 1-5: What's on the Back of a Computer Case?

Port	Icon	Description
 Keyboard & Mouse		<p>The keyboard and mouse jacks look identical on most PCs, so look for colors and icons to help you with plugging in these devices.</p> <p>Some mice and keyboards use USB ports. Older mice may use a serial port.</p>
 Serial or COM		<p>Serial (or COM) ports are a very versatile type of port. Some of the things you can plug into a serial port include: a mouse, modem, scanner, or digital camera. Most computers have two serial ports: COM1 and COM2.</p>
 Parallel or Printer		<p>You plug your printer into the parallel, or printer, port. Many newer printers may use a USB port.</p>
 USB		<p>Designed to replace older Serial and Parallel ports, the USB (Universal Serial Bus) can connect computers with a number of devices, such as printers, keyboards, mice, scanners, digital cameras, PDAs, and more. Better yet, the USB port supports <i>plug-and-play</i>, so you can simply plug in a USB device and start using it.</p> <p>USB 1 ports can transfer information at a speed up to 12 Mbps (Megabytes per Second). Newer USB 2 ports can transfer information at a speed up to 480 Mbps. Most computers come with two USB ports.</p>
 Video or Monitor		<p>You plug your monitor into the video port.</p>
 Line Out		<p>Plug in your speakers or headphone into the Line Out jack.</p>
 Line In		<p>The Line In jack allows you to listen to your computer using a stereo system.</p>
 Microphone		<p>You can plug a microphone into this jack to record sounds on your computer.</p>
 Joystick or Game		<p>If you have a joystick, musical (MIDI) keyboard, or other gaming device, this is where you plug it in.</p>
 Phone or Modem		<p>The phone or modem jack is where you plug your computer into a phone line.</p>
 Network or Ethernet		<p>You can connect your computer to a network by plugging in an Ethernet cable in this port.</p>
 SCSI		<p>An SCSI port is one of the fastest ways to connect a hard drive, CD-ROM drive, or other device to a computer.</p>
Firewire		<p>A FireWire (IEEE 1394 or i.LINK) port lets you connect such devices as hard disks and digital camcorders to a computer. A FireWire port can transfer information at a speed up to 400 Mbps (Megabytes per Second).</p>

Quick Reference

Ports on the Back of a Computer Include:

- Keyboard and Mouse
- Serial or COM
- Parallel or Printer
- USB
- Video or monitor
- Line in, line out, microphone
- Joystick or game
- Phone or modem
- Ethernet or network
- SCSI
- Firewire

Lesson 1-6: System Bus and Expansion Cards

Figure 1-8

Expansion cards plug directly into a computer's motherboard.

Figure 1-9

Most computers have around six expansion slots.

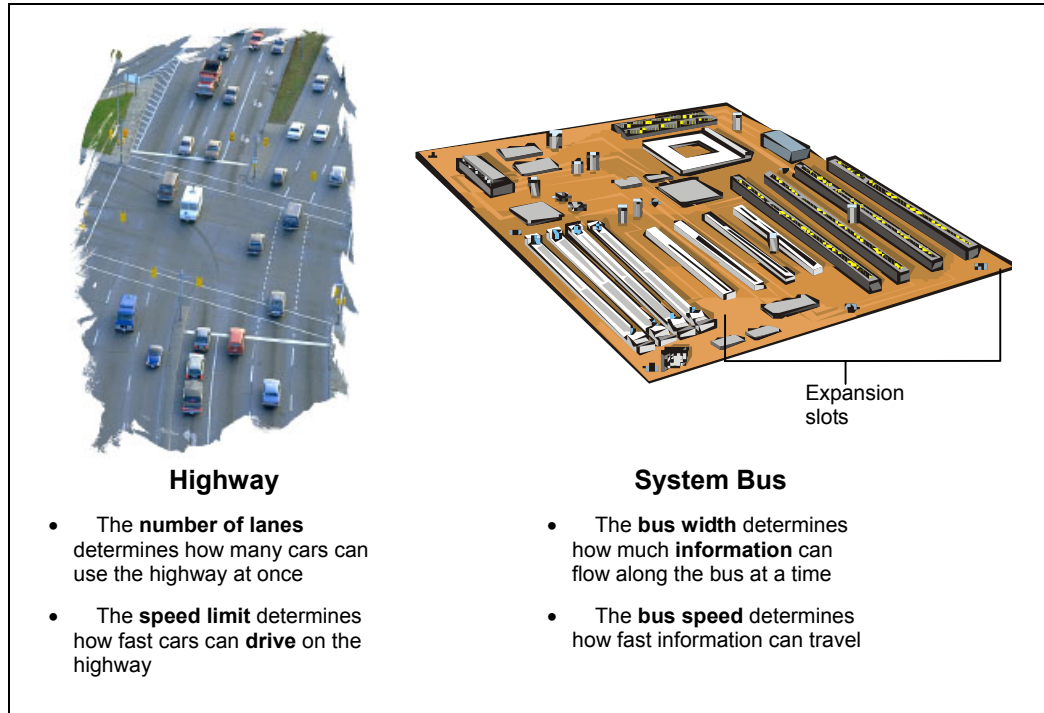

Expansion cards plug directly into the motherboard.

You're furious! You just bought an expensive digital camcorder only to find out that it can't connect to your computer because your computer apparently doesn't have a Firewire port. Don't worry—you can easily add a Firewire port to the computer by buying an *expansion card*.

Expansion cards allow you to add more gizmos and capabilities to a computer. You can also use expansion cards to replace a component of a computer that breaks, like a modem. Expansion cards plug into expansion slots on a computer's motherboard.

A computer talks to its expansion cards—and everything else on the motherboard—through its *bus*. A computer's bus is an electronic pathway that carries information between devices in a computer. Two factors determine how information flows through the bus: the *bus width* and the *bus speed*.



- **Bus Width**
The bus width determines how many "lanes" there are on a computer's electronic highway. Actually, the bus width isn't measured in lanes, but in *bits*. The wider the bus, the more information can travel across it at the same time.
- **Bus Speed**
The bus speed determines how fast information can travel through the bus. The higher the bus speed, the faster information can travel through it. Bus speed is measured in MHz.

As if this weren't confusing enough there are several bus types out there. They include:

- **ISA**
The *Industry Standard Architecture (ISA)* is the original, slowest, and oldest type of bus. The ISA bus has a width of 16 bits and a speed of 8 MHz. The ISA bus is going the way of dinosaurs and is no longer found on new computers.
- **PCI**
The *Peripheral Component Interconnect (PCI)* bus is the main bus found in newer computers. The PCI bus can have a width of 32 or 64 bits. The PCI bus supports *Plug and Play*, which lets you add new devices to a computer without a complicated installation process.
- **AGP**
An *Accelerated Graphics Port (AGP)* is a blazingly fast bus that is currently only used for video cards. The AGP port has a width of 64 bits and supports Plug and Play.

So what kind of expansion cards are out there? Here are some of the more common expansion cards that you may come across...

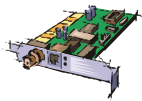
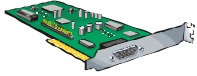
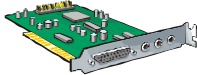
Table 1-6: Common Types of Expansion Cards

Expansion Card	Description
 Modem	A modem allows computers to exchange information through ordinary telephone lines. Almost all computers already come with built-in modems, so you would probably only want to add a modem expansion card if the original modem in a computer breaks.
 Network	A network interface card (NIC) is an expansion card that connects a computer to other computers on a network.
 Video or Graphics	A video card or adapter is what generates the images and text displayed on a monitor. Computers come with a built-in video card, but some people like to upgrade their original video card with faster, more powerful video cards.
 Sound	A sound card lets a computer play and record sounds, just like a home stereo system.
 Additional Port(s)	You can use expansion cards to add additional ports to a computer, such as the newer Firewire or USB 2 ports.

Quick Reference

- An **expansion card** plugs into a computer's motherboard to give it additional capabilities.
- A computer communicates with its expansion cards and devices through the system bus.
- How much information flows through the system bus depends on the bus width and bus speed.

There are several bus types:

1. ISA
2. PCI
3. AGP

Lesson 1-7: Memory Cache

Figure 1-10

An illustration of how a computer searches for information in a memory cache.

Figure 1-11

An illustration of how a police officer looks for a gun in a “weapons cache.”

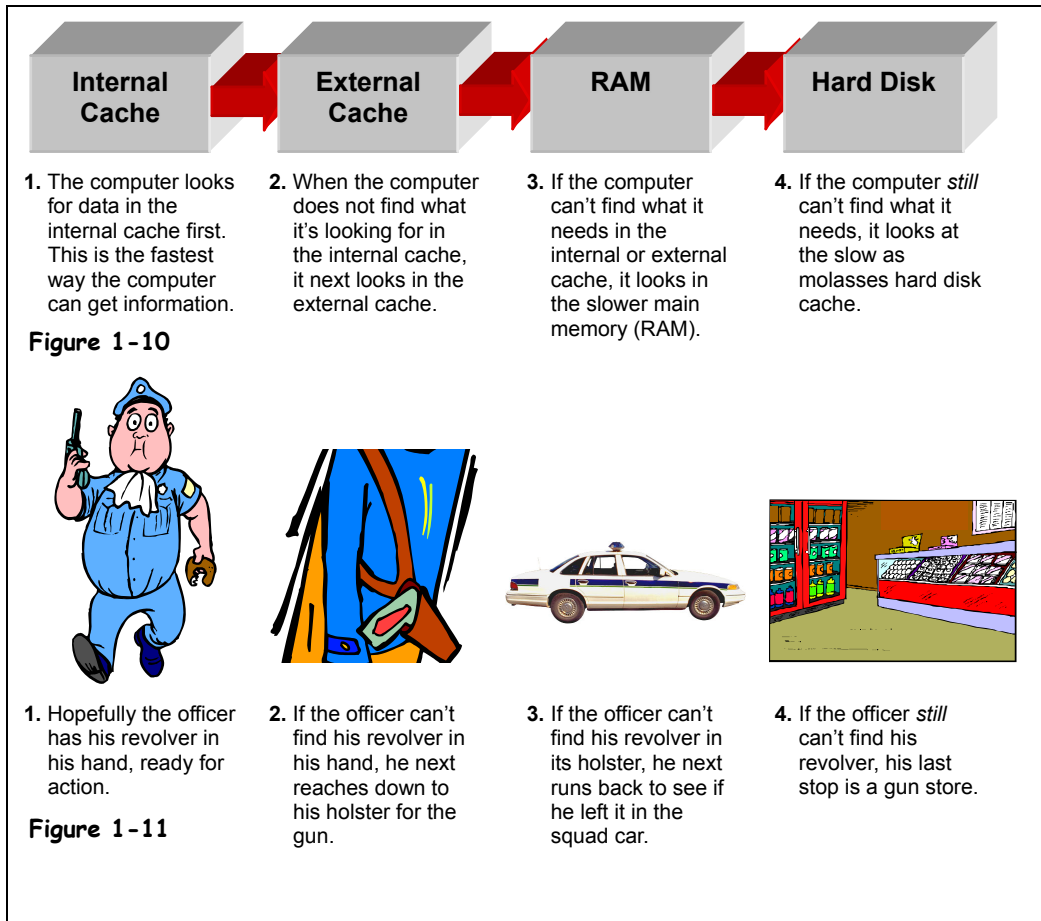

A *memory cache* increases a computer's performance by storing the most recently used data. There are two types of cache:

- **Internal Cache** (also called *primary* or *L1 cache*)

When the computer needs data it first looks in the internal cache. The internal cache is inside the CPU and is the fastest possible way for the computer to get information. The internal cache can normally only contain a very small amount of information.
- **External Cache** (also called *secondary* or *L2 cache*)

If the computer doesn't find the data in the internal cache, it then looks in the external cache. The external cache is slower than the internal cache, but much faster than the normal RAM memory. The external cache normally holds much more information than the internal cache, but still not as much as the main memory (RAM).

 **Quick Reference**

Memory Cache:

- A special type of memory that greatly increases a computer's performance.

Lesson 1-8: Computer Performance

Figure 1-12

There are lots of factors that determine a computer's speed. Most of them are listed in Table 1-7: *Factors that Affect Computer Performance*.

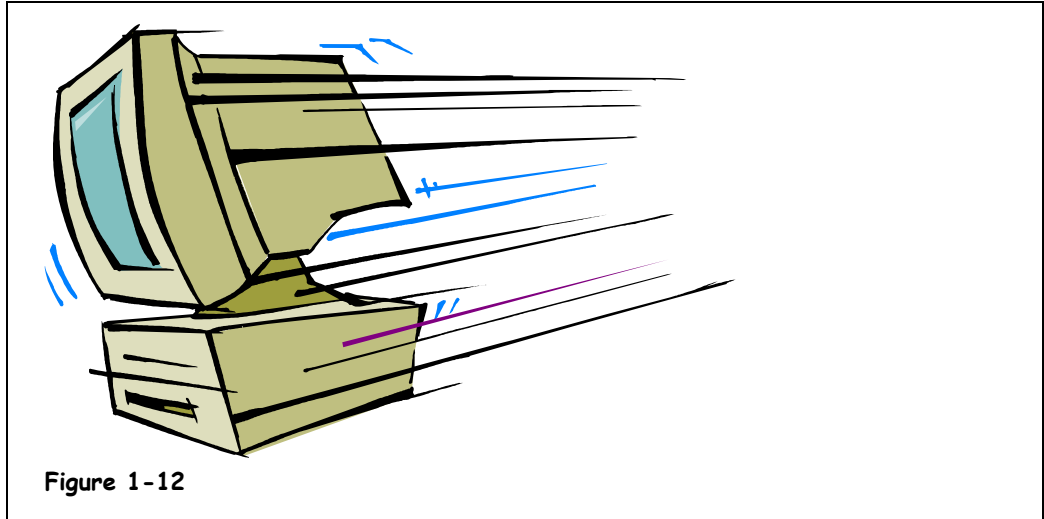

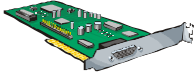





Figure 1-12

Wondering why your neighbor's computer is so much faster than your computer? There are a number of reasons why a computer may run faster or slower. You learn about each of them by reading Table 1-7: *Factors that Affect Computer Performance*.

A much simpler reason that your neighbor's computer is faster than your computer is probably because it's newer.

Table 1-7: Factors that Affect Computer Performance

Factor	Description
 <p>CPU Speed</p>	Arguably the single most important factor that determines a computer's performance is the speed of its CPU. The speed of the CPU is measured in megahertz (MHz) and gigahertz (GHz). The faster the CPU, the faster the computer. The first PC in 1981 ran at 4.77 MHz, while today's computers can run at speeds exceeding 3,000 MHz, or 3 GHz.
 <p>Amount of RAM</p>	The amount of RAM, or memory, is another very important factor in a computer's performance. Generally, the more RAM a computer has the better its performance. However, you usually won't see much of an improvement after 1 GB of RAM.
 <p>Type of Video Card</p>	Video cards have their own processor and memory, just like the computer does. The faster the processor and the more memory a video card has, the faster it can draw images on the monitor. Video card performance is especially important if you're interested in playing newer, 3D computer games.

Factor	Description
 <p data-bbox="204 407 391 438">Hard Drive Speed</p>	<p data-bbox="431 233 1187 352">A hard drive's average access time is how fast it can find information. Average access time is measured in milliseconds (ms), or 1/1000 of a second. The lower the access speed, the faster the hard drive. Most newer computers have an average access time of 8 to 15 ms.</p> <p data-bbox="431 373 1170 493">Another factor that determines hard drive performance is how fast it spins, in revolutions per minute (rpms). Faster IDE hard drives may have speeds as fast as 7,200 rpm, while high-end SCSI hard drives have speeds of 15,000 rpm.</p>
 <p data-bbox="220 627 375 684">Free Hard Disk Space</p>	<p data-bbox="431 510 1170 600">Not only do you need a fast hard drive, you have to make sure that it has plenty of free storage space. Microsoft Windows uses this hard disk space to create a cache on the hard drive where it stores temporary information.</p>
 <p data-bbox="220 840 375 896">Hard Disk Fragmentation</p>	<p data-bbox="431 705 1187 915">Normally a computer stores a file in the same location on a hard drive. Over time, a hard drive can become <i>fragmented</i>, and instead of storing a file in the same location it begins storing parts of it all over. When the computer needs to read a fragmented file, it must read several different parts of the hard drive instead of just one. Defragmenting a hard drive puts the fragmented files back together in one place. You should defragment your computer's hard drive about once a month.</p>
 <p data-bbox="220 1033 375 1089">Multitasking Considerations</p>	<p data-bbox="431 936 1179 1056">Microsoft Windows can <i>multitask</i>, or run more than one program or task at a time—probably no different than your job. And, just like your job, the more programs or tasks you throw at Windows, the longer it takes to complete each one, and hence a drop in computer performance.</p>

Quick Reference

Computer Performance is Determined By:

- CPU speed
- Amount of memory or RAM
- The type and speed of the video card
- A hard disk's speed, free space, and fragmentation
- How many programs are running, or multitasking, at the same time

Lesson 1-9: Buying a Desktop Computer

Figure 1-13

What should you look for when you're buying a new computer? That depends on what you want it to do. Table 1-8: *Desktop Computer Buyer's Guide* lists some of the more important factors and features to be aware of when buying a new computer. Just make sure the information listed isn't too out of date!

DIMENSION 8300 DETAILS



From \$1,679
Now from \$1,429
After \$250 Mail-in Rebate
 Online Only!
[Rebate Details](#)

As low as **\$50/month¹**
 [Apply Now](#) | [Learn More](#)
No Interest until September

Dimension 8300 Special Offers
Limited time offers. Click links below for offer details.



- ▶ **FREE Shipping - Online Only!**
Offer expires 4/29/2003
- ▶ **FREE 512MB Memory Upgrade - Online Only!**
Offer expires 4/29/2003
- ▶ **FREE 120GB Hard Drive Upgrade - Online Only!**
Offer expires 4/29/2003
- ▶ **FREE 2nd Bay CD-Burner!**
Offer expires 4/29/2003

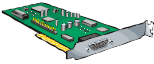

Figure 1-13

Nothing's worse than going to the computer store and listening to a know-it-all salesperson tell you to buy the most expensive computer in the store because the Radon graphics accelerator with 128 megabytes of RAM is something he thinks you're definitely going to need.

Instead of listening to a nerdy computer salesperson, who may be on commission or a sales quota, call one of your computer-geek friends or relatives, tell them how you're going to use your computer, and ask what they would recommend. If a computer-geek friend isn't readily available, Table 1-8: *Desktop Computer Buyer's Guide* will give you a good idea of what you should look for when you buy a new computer. Just remember that computer technology changes about as quickly as the latest fashions (every six months), so this information will probably be out of date shortly after you read it.

Table 1-8: Desktop Computer Buyer's Guide

Factor	Budget	Middle of the Road	High End, Gaming
 CPU	Duron or Celeron at 2GHz	Pentium 4 at 2GHz, Athlon at 1.7 GHz	Pentium 4 at 3GHz, Athlon at 2.1GHz
 RAM	256MB	512MB	1GB
 Monitor	15-inch or 17-inch CRT	17-inch CRT or 15-inch flat panel/LCD	19-inch CRT or 17-inch flat panel/LCD

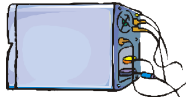
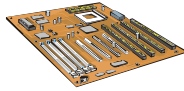
Factor	Budget	Middle of the Road	High End, Gaming
 Video Memory	32MB	64MB to 128MB	128MB or more
 Hard Drive	40GB to 60GB	80GB	120GB or more
 CD or DVD Drive	CD-ROM Drive	CD-RW Drive	DVD+-R/RW & CD-R/RW Drive
 Ports	USB 1.0	USB 2.0	USB 2.0, Firewire
 Included Devices		Ethernet, 56K modem	Ethernet, 56K modem

* This information was updated May 2003.

Lesson 1-10: Buying a Notebook Computer

Figure 1-14

What should you look for when you're buying a new computer? That depends on what you want it to do. Table 1-9: *Notebook Buyer's Guide* lists some of the more important factors and features to be aware of when buying a new computer. Just make sure the information listed isn't too out of date!



PORTÉGÉ®
4010 Series
A Masterpiece of Ultra-Portable Wireless Computing!
With the new low voltage (1.15V) Mobile Intel® Pentium® III Processor - M¹ featuring Enhanced Intel® SpeedStep® technology at 933MHz the Portege 4010 offers more computing power while providing up to 7.6 hrs.² with primary and optional Slim SelectBay battery. Other Slim SelectBay devices include DVD/CD-RW, CD-RW, DVD-ROM, CD-ROM, and 2nd hard drive. All models also include an integrated Secure Digital™ slot and an i-Link (IEEE 1394) port for added functionality and expandability.

4010 Special Offers
Note: May not apply to all units
[6 Months Same As Cash Financing](#) with purchases over \$499 through June...
[Toshiba Trade-in Program](#) in conjunction with notebook, projecto...
[0% Business Lease or 5.9% Financing](#) on \$10,000+ transactions...

Portege 4010 Key Features

- Mobile Intel® Pentium® III Processor - M¹ 933MHz with Enhanced Intel® SpeedStep® technology
- Memory expandable to 1GB!
- Up to 7.6hrs.² battery time using primary and Slim SelectBay batteries
- Integrated 10/100 Ethernet, and V.90/56K modem⁵
- Warranty: 3-year parts and labor, 1-year battery

[Detailed Specs](#) [Awards & Reviews](#)
[Product Tour](#) [Features in Action](#)

Figure 1-14

Deciding on which notebook to buy is even more confusing than buying a desktop computer. That's because there is much more variance in features and prices between various notebooks. Notebook computers can't be upgraded as easily as desktop computers, so your decision is pretty much final.

Table 1-9: *Notebook Buyer's Guide* will give you a good idea of what you should look for when you buy a new notebook computer. Just remember that notebook technology changes incredibly fast, so don't use Table 1-9: *Notebook Buyer's Guide* after December 2003.

Some other important factors to consider when buying a notebook include:

- **Size**
Generally speaking, while convenient and cool looking, smaller notebooks aren't as powerful or fast as larger notebook computers. If you travel frequently and need to lug your notebook around with you, you might want to consider a smaller notebook. If your notebook doesn't move around much you're probably better off with a larger notebook.
- **Battery Life**
A notebook's battery life can range anywhere from 2 to 7 hours. Some notebooks can even accept a second battery for extra long life. Battery life probably isn't much of an issue if you only use your notebook when it's plugged into the wall.
- **Warranty**
Notebook computers are notorious for breaking down. What's worse, they're not very easy to open and they have their own unique notebook parts, so they're much harder and more expensive to repair than their desktop counterparts. Most of us hate the old three-year extended warranty sales pitch, but if you're buying a notebook computer the cost of the extra warranty is probably worth it.

- **Included Devices and Features**

Notebook computers usually have several devices and gizmos built-in—often more than a desktop computer! A modem and Ethernet port are usually a standard part of most notebooks today. Some notebooks also have memory card readers (especially useful if you have a digital camera or PDA), Firewire ports, and even wireless networking, known as *WiFi*. If you're comparing various notebook models, make sure that you know what devices are or aren't included.

Table 1-9: Notebook Buyer's Guide

Factor	Budget	Middle of the Road	High End
 CPU	Duron, Celeron, Pentium 3, or Athlon at 700MHz or better	Duron, Celeron, Pentium 3 or 4, or Athlon at 1GHz or better	Pentium 4 at 2GHz or better
 RAM	256MB	256MB	512MB
 Video Memory	16MB	32MB to 64MB	32MB to 64MB
 Hard Drive	20GB	30GB	60GB
 CD or DVD Drive	CD-ROM Drive	CD-RW Drive	DVD & CD-R/RW Drive
 Ports	USB 1.0	USB 2.0	USB 2.0, Firewire
 Included Devices	56K modem	Ethernet, possibly WiFi (wireless networking) 56K modem	Ethernet, WiFi (wireless networking), 56K modem, Bluetooth (a next-generation wireless port)

* This information was updated May 2003.

Lesson 1-11: Upgrading a Computer

Figure 1-15

Computer upgrades can get expensive! There's a fine line between when it's more cost effective to upgrade an older computer, or to simply buy a new computer altogether.

Figure 1-16

Most computer upgrades require that you, or better yet someone who actually knows about computers, opens up the computer case.

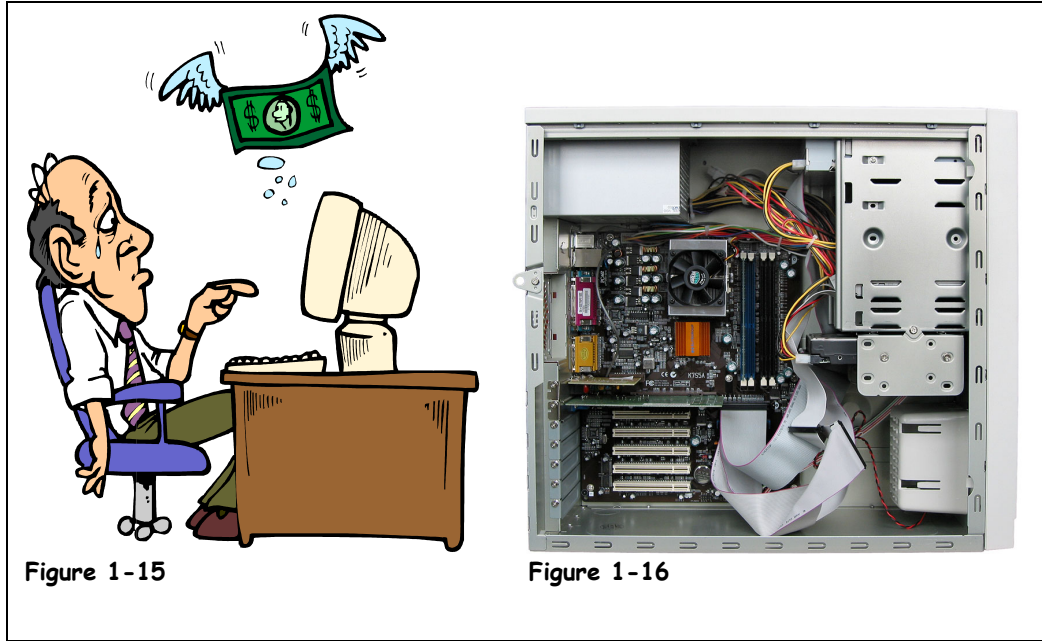

Figure 1-15





Figure 1-16

When you *upgrade* a computer, you usually replace older components with newer components to improve the computer's performance. You can also upgrade a computer by adding additional components, such as more memory or a second hard drive. Upgrading a computer to improve its performance is often cheaper than buying a new computer. For most upgrades you will need someone with a lot of computer experience to do the upgrade for you.

It's often difficult to determine which is better—upgrading an old computer or simply buying a new computer. If you're an average computer user, plan on buying a new computer every four or five years (sorry—someone has to break this news to you). By then, the cost of a new computer will be less expensive than any effective upgrades you do.

So what can you do to upgrade a computer? The following table lists some of the more common upgrades.

Table 1-10: Typical Things to Upgrade on a Computer

Upgrade	Description
 Memory (RAM)	Increasing the amount of memory in a computer is probably the most effective and inexpensive upgrades you can make. More memory can significantly increase the performance of your computer. 512MB to 1GB of memory is all you should ever need—for the next year or so anyway.
 Hard Disk	The hard drives in newer computers have become so huge that you may never need to buy another one. If you do somehow run out of room on your hard drive, you can buy a second one, since most computer can handle two internal hard drives.
 CPU and Motherboard	It's often better to buy a whole new computer than to upgrade the CPU and motherboard. That way you get <i>all</i> new components all once—which is a lot cheaper than buying them all individually.
 Add Devices and Peripherals	There are an endless variety of devices that you can add to a computer. You can add CD-ROM, DVD, and Zip drives, graphics cards, tape backups, and more.

Quick Reference

Make sure any upgrades you make to a computer are worth the cost—sometimes it's simply better to buy a new computer.

Upgrades to Improve Performance Include:

- Adding more memory or RAM
- Adding a bigger hard drive
- Adding a new CPU and motherboard (usually not recommended)
- Adding new devices, such as a DVD drive

Chapter One Review

Lesson Summary

Hardware, Software, and Information Technology (IT)

- A typical computer includes the system unit, monitor, keyboard, mouse, speakers, and printer.
- **Hardware:** A computer item you can physically see or touch.
- **Software:** A computer program that tells computer hardware how to operate.
- **Information Technology (IT):** The broad subject related to computers and managing and processing information.

Computer Overview

- The basic computer processes are input, processing, and output.
- Different types of computers include mainframes, PCs, Macs, servers, laptops, and PDAs.

The Front of a Computer and Peripheral Devices

- Components visible from the outside of the system unit may include the floppy drive, CD-ROM or DVD drive, Zip drive or tape backup, keyboard, mouse, scanner, monitor, speakers, and printer.

The Inside of a Computer

- Components inside the system unit may include the motherboard, CPU (Central Processing Unit), RAM (Random Access Memory), ROM-BIOS, expansion slots and cards, and PCMCIA cards in laptops.

The Back of a Computer (Ports)

- Ports on the back of a computer include: keyboard, mouse, serial or COM, printer or parallel, USB, video or monitor, line in, line out, microphone, joystick or game, phone or modem, Ethernet or network, SCSI, and/or Firewire.

System Bus and Expansion Cards

- An **expansion card** plugs into a computer's motherboard to give it additional capabilities.
- A computer communicates with its expansion cards and devices through the system bus.
- How much information flows through the system bus depends on the bus width and bus speed.
- There are several bus types, including ISA, PCI, and AGP.

Memory Cache

- **Memory Cache:** A special type of memory that greatly increases a computer's performance.

Computer Performance

- Computer performance is determined by CPU speed, amount of memory or RAM, the type and speed of the video card, the hard disk speed, free space, and fragmentation, and the number of programs running at the same time.

Upgrading a Computer

- Make sure any upgrades you make to a computer are worth the cost—sometimes it's simply better to buy a new computer.
- Upgrades to improve performance include adding more memory or RAM, adding a bigger hard drive, adding a new CPU and motherboard (usually not recommended), and adding new devices, such as a DVD drive.

Quiz

1. **Hardware is any software that is installed on a computer's hard disk. (True or False?)**
2. **Laptops are faster than desktop PCs, generally speaking. (True or False?)**
3. **Which of the following moves the pointer to another location on-screen?**
 - A. Pressing the arrow keys on the keyboard.
 - B. Moving the mouse until the pointer points to that spot.
 - C. Moving the mouse until the pointer points to that spot and clicking the left mouse button.
 - D. Moving the mouse until the pointer points to that spot and clicking the right mouse button.
4. **Which of the following is NOT a type of computer port?**
 - A. USB
 - B. Parallel or printer
 - C. Backup
 - D. Network or Ethernet
5. **When you type a document on a computer, every letter you type is saved to the computer's _____ or temporary storage area.**
 - A. Hard drive
 - B. RAM
 - C. ROM
 - D. CPU

6. **What is the 'brain' or main chip of a computer called?**
 - A. The RAM
 - B. The ROM-BIOS
 - C. The motherboard
 - D. The CPU

7. **ROM stands for 'Read-Only Memory' (True or False?)**

8. **Which of the following does NOT affect a computer's performance?**
 - A. The amount of memory or RAM.
 - B. The speed of the CPU.
 - C. The type and speed of the video or graphics card.
 - D. The number of keys on the keyboard.

Quiz Answers

1. False. Hardware is any physical part of the computer you can see and touch.
2. False. Laptops are generally slower than desktop PCs.
3. B. Move the pointer by moving the mouse until the pointer points to that spot.
4. C. There isn't such as thing as a backup port.
5. B. RAM or Random Access Memory.
6. D. The CPU, or Central Processing Unit, is the main chip in a computer.
7. True. ROM stands for Read-Only Memory.
8. D. The number of keys on the keyboard does not affect a computer's performance.

Chapter Two: Understanding Hardware

Chapter Objectives:

- Understand what a CPU does
- Learn how memory is measured
- Learn about input devices: mouse, keyboard, and digital cameras
- Learn about output devices: monitor, graphics, and printers
- Learn about storage devices: hard drives, CD-ROMs, and DVDs

Prerequisites

- A desire to learn about computers.

Hardware is any physical part of a computer that you can see or touch. A computer's monitor, CD-ROM or DVD drive, mouse, keyboard, and printer are all different types of hardware. This chapter takes a closer look at the physical parts that constitute a computer.

This chapter is broken up into several sections, since there are several different categories of hardware devices. First we'll examine *processing devices*, such as computer's CPU and memory. You'll finally understand what those technical sounding words megahertz and gigabyte mean. From there we'll move on to *input devices*, such as the keyboard and mouse and *output devices*, such as the monitor and printer. The last part of this chapter discusses *storage devices*, such as hard drives and CD-ROM drives.

That's a lot of material to cover, so let's get started!

Lesson 2-1: Central Processing Unit (CPU)

Figure 2-1

The Intel Pentium 4 is the fastest and most recent CPU available.

Figure 2-2

The CPU can get hot! Most CPUs have a built-in fan to keep them from burning out.

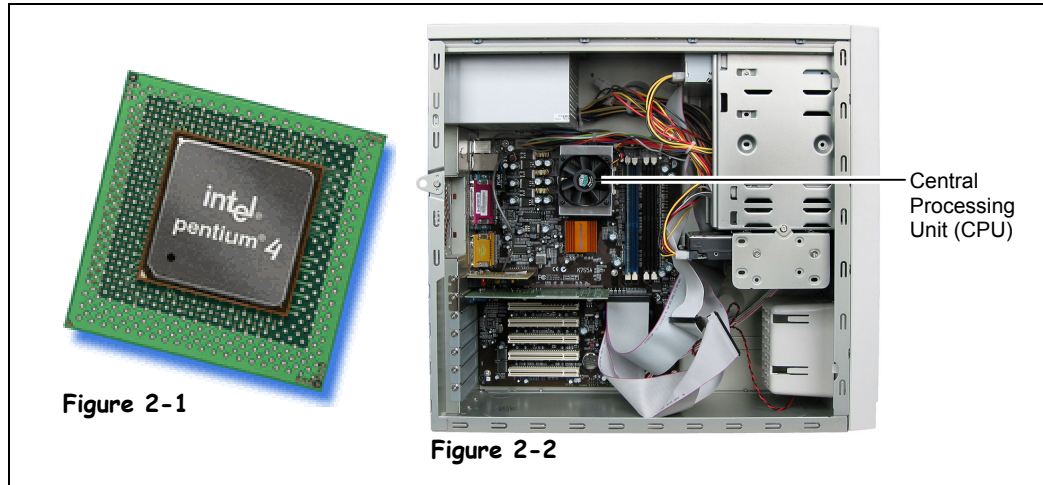

Inside the computer case, hidden amongst all the wiring and gizmos, is a particularly important part of the computer known as the *central processing unit* (or *CPU*, for short). The CPU is also known as the *computer chip* (because that's what it is) or the *microprocessor* (or *processor*, for short).

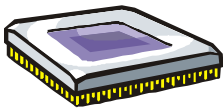

A CPU's speed is measured in megahertz (MHz) or gigahertz (GHz).

Some say the CPU is the brain of the computer while others describe it as the heart. In any case, it's the thing that makes your computer a computer. The CPU does all the work: It calculates, it processes, it keeps things running smoothly. You might think of it as a talented stage manager. When it does its behind-the-scenes job well, you don't notice it; you simply enjoy the performance.







Originally, CPUs were given wildly inventive names like *Chip*. Okay, maybe not. The names were actually based on numbers like *8088*. The next few names in the series—the *286*, the *386*, and the *486*—were actually just shortened names for 80286, 80386, and 80486. Then, what would have been the 586 was dubbed the *Pentium*. After that, the names became rather mysterious: Pentium Pro and Pentium MMX. Finally, the names returned to a semi-ordered numbering system (albeit a mix of Roman and Arabic numerals): Pentium 2, Pentium 3, and Pentium 4. And that's where we are at the moment. Both the Pentium 3 and the Pentium 4 are still quite common.

Intel makes most CPUs. In fact, Intel is the company that came up with the name *Pentium*. However, AMD and VIA Technologies are two other well-known CPU manufacturers. Their CPUs are less expensive and use a different naming system (such as the AMD Athlon and the AMD Duron). Intel actually makes a less expensive version of the Pentium as well, which it calls the *Celeron*. The Celeron does what the Pentium does, but not as quickly.

Speaking of which, speed is what the CPU is all about, and each successive version of the CPU gets progressively faster. A CPU's speed is measured in megahertz (MHz) or, for newer models, in gigahertz (GHz). A megahertz equals millions of cycles per second; a gigahertz equals billions of cycles per second. Higher numbers equate to higher speeds. You might see an Intel Pentium 4 at 3.06 GHz, a Pentium III at 1.40 GHz, and a Celeron at 2.20 GHz.

Another common measure of a CPU is how many bits it can handle at a time. A bit is the tiniest piece of information processed by a computer. Eight bits make up one byte, and one byte equals one character. Computers used to handle 8 or 16 bits; now they're up to 32 and 64 at a time. Don't worry if all of this seems a bit confusing—we'll cover bits and bytes in greater detail in a later lesson.

Table 2-1: Types of CPUs

CPU	Speed	Description																		
	1 GHz to 3 GHz	Intel Pentium 4 Processor The Pentium 4 is Intel's more recent and fastest generation of CPUs, with processing speeds over 3 GHz.																		
	450 MHz to 1 GHz	Intel Pentium III Processor Launched in 1999, Pentium 3 CPUs are still found in some new computers.																		
	1.06 to 2 GHz	Intel Celeron Processor Intel's Celeron CPU is an inexpensive processor designed for people on budget. Celeron processors are very similar to Pentium processors, but they have less built-in memory.																		
	500 MHz to 3 GHz	Intel Xeon Processor Don't expect to see any Xeon-based computers at your local computer store—it's designed for high-end servers.																		
	850 MHz to 1.67 GHz	AMD Athlon Processor The Athlon processor is equivalent to Pentium processors—only it's less expensive.																		
	700 MHz to 800 MHz	AMD Duron Processor The Duron CPU is AMD's is similar to Intel's Celeron processor. It has less built-in memory and is designed for people on a budget.																		
Older Processors		Here's a summary of the other most common—and obsolete—processors out there: <table border="1" data-bbox="544 1339 1128 1558"> <thead> <tr> <th>Processor</th> <th>Release Date</th> <th>Average Speed</th> </tr> </thead> <tbody> <tr> <td>Pentium II</td> <td>1997</td> <td>266 MHz</td> </tr> <tr> <td>Pentium 486</td> <td>1989</td> <td>66 MHz</td> </tr> <tr> <td>Pentium 386</td> <td>1985</td> <td>25 MHz</td> </tr> <tr> <td>Pentium 286</td> <td>1982</td> <td>12.5 MHz</td> </tr> <tr> <td>Pentium 8088</td> <td>1979</td> <td>8 MHz</td> </tr> </tbody> </table>	Processor	Release Date	Average Speed	Pentium II	1997	266 MHz	Pentium 486	1989	66 MHz	Pentium 386	1985	25 MHz	Pentium 286	1982	12.5 MHz	Pentium 8088	1979	8 MHz
Processor	Release Date	Average Speed																		
Pentium II	1997	266 MHz																		
Pentium 486	1989	66 MHz																		
Pentium 386	1985	25 MHz																		
Pentium 286	1982	12.5 MHz																		
Pentium 8088	1979	8 MHz																		

Quick Reference

- The CPU, or Central Processing Unit, is the computer's main chip. It calculates and processes information.

CPU Speed is Measured In:

- Megahertz (MHz).
- Gigahertz (GHz).

Common CPUs Include:

- Intel Pentium III
- Intel Pentium 4
- Intel Celeron
- AMD Athlon
- AMD Duron

Lesson 2-2: Memory

Figure 2-3

A hard drive might have 60GB of memory.

Figure 2-4

A recordable CD (CD-R) can have up to 700MB of memory.

Figure 2-5

A memory chip might have 512MB of memory.

Figure 2-6

A zip disk can have between 100MB and 250MB of memory.

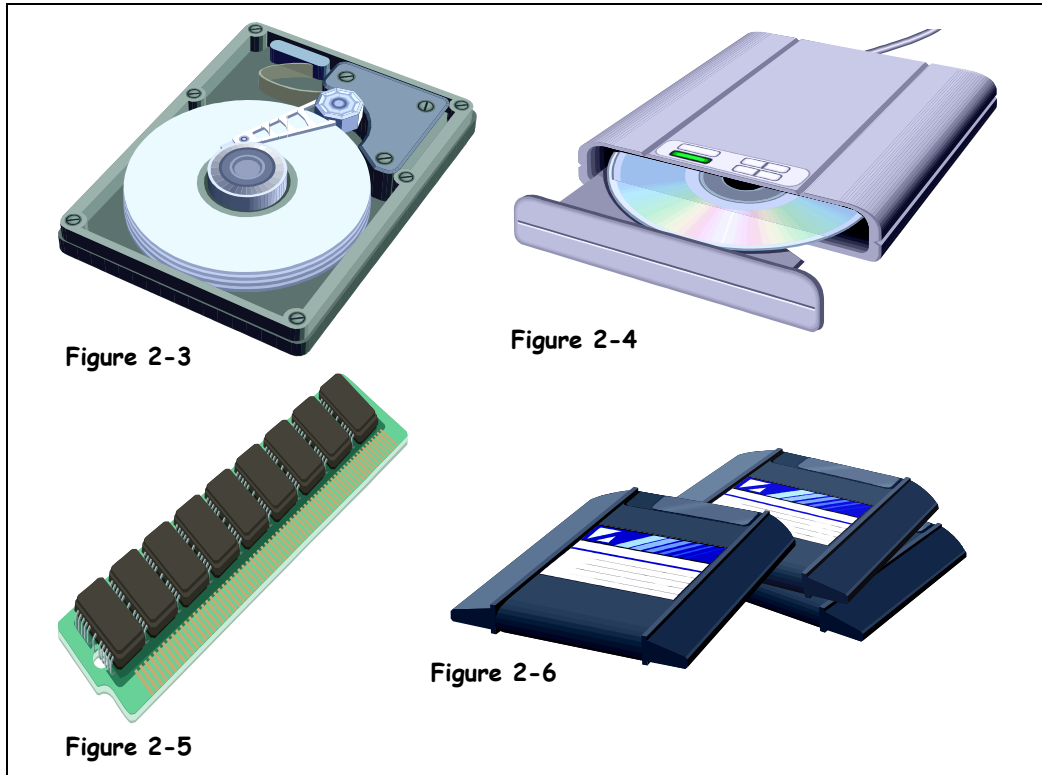

Everything that a computer does is based on a combination of ones and zeros, which is known as the *binary system*.

Most people know that a computer has memory. But what does that really mean? You often hear techies toss around numbers like “60GB hard drive.” Okay, that sounds impressive, but what does it tell you? This lesson breaks memory into measurable units.

The first thing you need to know is that, at its most basic level, a computer only understands the concept of “on and off.” *On* is represented by the number one (1); *off* is represented by the number zero (0). Everything that a computer does is based on this combination of ones and zeros, which is known as the *binary system*. These ones and zeros are digits, known as *bits*, which are the smallest memory unit. The term *bit* is short for *binary digit*.

The second thing you need to know is that a computer saves information in *bytes*, not bits. So what is a byte? The term *byte* is short for *binary digits eight*. So one byte is made up of eight bits. And a byte is the equivalent of a character, which can be a letter, a number, or a symbol. So let’s say that you’re a self-involved poet whose latest creation is simply titled “I.” That one-word title would equal one byte.

Of course, it would be fairly tedious if a computer stored everything in single bytes. The next largest unit is the *kilobyte*. A kilobyte (abbreviated *K* or *KB*) equals 1,024 bytes or characters. Now let’s say you’re a short-story writer. The one-page, double-spaced masterpiece you submit to your editor would be the equivalent of a kilobyte.

After the kilobyte, the next largest unit is the megabyte. A megabyte (abbreviated *M* or *MB*) equals 1,048,576 bytes or characters. If you were a novelist, your latest bestseller would equal a megabyte.

The next unit after the megabyte is the gigabyte. A gigabyte (abbreviated *G* or *GB*) equals 1,073,741,824 bytes or characters. Let's pretend you are a researcher. A whole shelf of books devoted to your favorite subject would be the equivalent of a gigabyte.





Finally, after the gigabyte comes the terabyte. A terabyte (abbreviated *T* or *TB*) equals 1,099,511,627,776 bytes or characters. Let's imagine that you're an egomaniac who owns an entire bookstore filled only with books by authors you like. Such a single-minded store would be the equivalent of a terabyte.

Okay, let's review. The following table summarizes all the units of memory.

MB GB

MB is an abbreviation for *megabyte*. *GB* is an abbreviation for *gigabyte*.

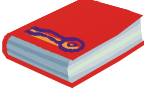
Table 2-2: Bits and Bytes

Unit	Abbreviation	Size	Symbol	Equivalent
Bit	—	—	—	An atom or speck, the smallest unit of memory.
Byte	—	8 bits		A single letter, a number, or a symbol.
Kilobyte	K or KB	1,024 bytes		A one-page, double-spaced letter.
Megabyte	M or MB	1,048,576 bytes		A best-selling novel.
Gigabyte	G or GB	1,073,741,824 bytes		An encyclopedia set.
Terabyte	T or TB	1,099, 511,627,776 bytes		A bookstore.

Quick Reference

Computers function based on the binary system:

- *On* is represented by a one (1).
- *Off* is represented by a zero (0).
- Ones and zeros are digits, known as *bits*.

Bit:

- Short for *binary digit*
- Smallest memory unit
- Eight bits equal one byte

Byte:

- Short for *binary digits eight*.
- One byte equals one character (letter, number, or symbol)

Kilobyte (K or KB):

- 1,024 bytes

Megabyte (M or MB):

- 1,048,576 bytes

Gigabyte (G or GB):

- 1,073,741,824 bytes

Terabyte:

- 1,099, 511,627,776 bytes

Lesson 2-3: RAM and ROM

Figure 2-7

RAM, or Random Access Memory, works like a notepad; you can read from it and write to it.

Figure 2-8

ROM, or Read Only Memory, works like a novel, you can read from it but not write to it.

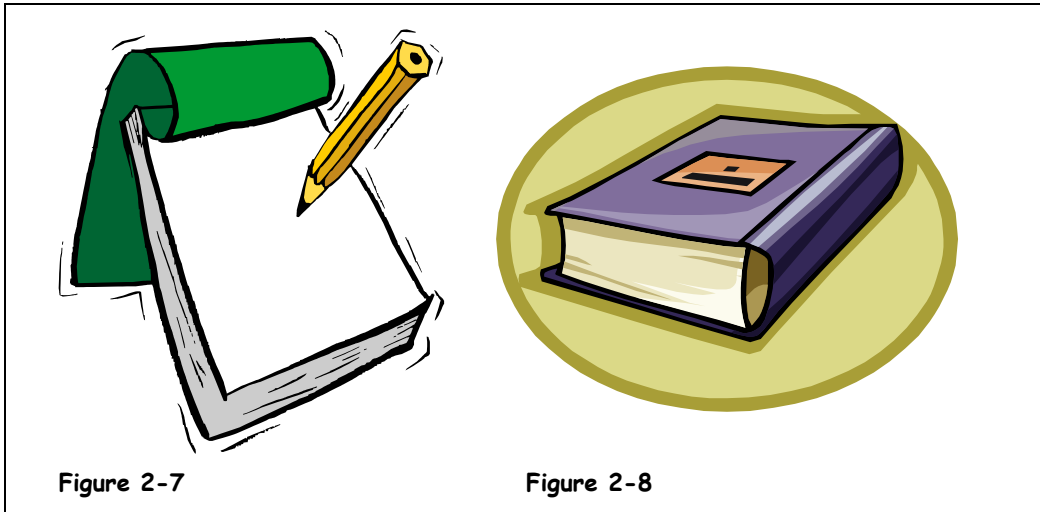

Figure 2-7

Figure 2-8

So now you know that computer memory is measured in various byte-sized units: kilobytes, megabytes, gigabytes, petabytes, and filobytes. Okay, those last two were just made up to see if you were paying attention.

Next you need to know that computers have two major types of memory: *random-access memory* (or *RAM*) and *read-only memory* (or *ROM*). Let's discuss these two types of memory in greater detail.



When you work with a file on your computer, you're using RAM.

- **RAM (random-access memory)**

When someone at a computer superstore tells you how much memory a new computer has, they're really talking about RAM. RAM is the computer's main memory, which it uses to process information. Whenever you work with a file on your computer, you're using RAM. And the data in that file is temporarily stored in RAM. However, RAM is *volatile*, which means that the data is stored only as long as the computer has power. Once you shut off your computer, the data is gone. However, you can and should save your data (read: your file). That's where storage comes in, but more on that later. For now, think of RAM like a notebook: You can read from it and write to it. Technically, it could be called "read and write memory." And, as with a notebook, you can overwrite it many, many times—provided you have an eraser!

- **ROM (read-only memory)**

ROM is the computer's low-level memory, which it uses to perform its most basic functions. This memory is permanent; the data remains even if you shut off the computer. This only makes sense because ROM is required to restart your computer. You never hear people discuss how much ROM you have because the manufacturer usually installs it, and you never touch it. It does all the behind-the-scenes work and then disappears once you're underway, much like a party planner. You can also think of ROM like a novel: You can read from it, but you can't write to it (and thus, its name).

Table 2-3: Comparing RAM and ROM

<i>RAM</i>	<i>ROM</i>
Random-access memory	Read-only memory
Main memory.	Low-level memory.
Necessary to process information (example: work with a file).	Necessary to perform the most basic functions (example: start the computer).
Volatile: If not saved, data disappears when you shut off the computer's power. It's temporary.	Nonvolatile: Data remains even when you shut off the computer's power. It's permanent.
Often discussed when buying a computer.	Seldom mentioned when buying a computer.
You can read from and write to it. Comparable to a notepad.	You can read from it, but you can't write to it. Comparable to a novel.

 **Quick Reference**

Computers have two types of memory:

- Random-access memory (RAM).
- Read-only memory (ROM).

RAM:

- Computer's main memory, which is used to process information (example: work with a file).
- Volatile: Unless saved, data disappears when you shut off the computer.
- You can read from it and write to it. Comparable to a notebook; you can read and write to it.

ROM:

- Computer's low-level memory, which is used to perform its most basic functions (example: start the computer).
- Nonvolatile: Data remains even when you shut off the computer. It's permanent.
- You can read from it, but you can't write to it. Comparable to a novel; you can only read it.

Lesson 2-4: Mouse

Figure 2-9

Clicking with the mouse.

Figure 2-10

Double-clicking with the mouse.

Figure 2-11

Right-clicking with the mouse.

Figure 2-12

Dragging and dropping with the mouse.

Figure 2-13

Using the scroll wheel.

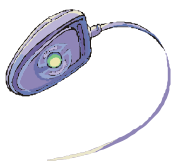
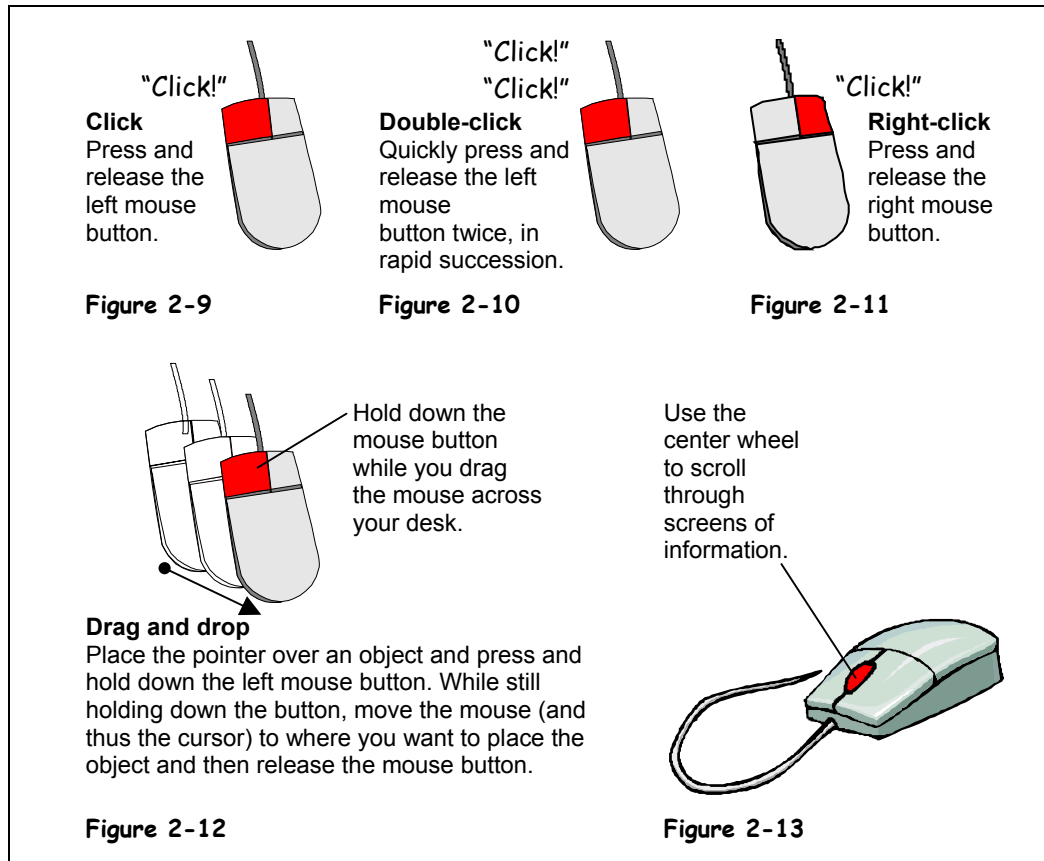

The underside of a roller ball mouse.



Some mouse pads have a wrist rest to help users keep their hands and wrists in better alignment.

A computer would be useless if you had no way to communicate with it. That's why you need an *input device*. Essentially, an input device lets you talk to your computer. Two examples of input devices are the keyboard and the mouse. We'll discuss keyboards later; for now let's concentrate on the mouse.

That funny-looking object that, frankly, looks like a mouse (with its oval body and long tail-like cord connecting it to the computer) *is* the mouse. Originally, computers only came with a keyboard. But in 1968 Doug Engelbart invented the mouse. In 1984, Apple Computers introduced the mouse with its Macintosh computers. Shortly thereafter, the mouse was standard equipment on all computers.

The mouse acts as a handheld pointing device that allows you to control the actions of that blinking item on your screen known as a *cursor*. Depending on the software you are using and the task you are doing, the cursor may resemble such symbols as a slanted arrow (↔), an "I" (I), or a vertical line (|). A cursor is essentially a place-marker that appears on your computer screen. You move the mouse to place the cursor over an object on your screen and click the mouse buttons to *select* that object. Once an object has been selected, you can move it or manipulate it. We'll cover mouse buttons in greater detail in a later lesson.

The standard mouse has two buttons and a *rollerball* on the underside, which moves the cursor on the screen when you move the mouse. A rollerball mouse works best when used

on a mouse pad, especially one that has a rough texture on its surface. Some mouse pads now come with a wrist rest to help users keep their hands and wrists in better alignment.

Like other computer components, mice come in several shapes and sizes. Some mice have three (or more) buttons, which are programmable, and some include a trackball on the top (instead of a rollerball on the underside). Most new mice include a center scroll wheel between the two buttons. Not surprisingly, this scroll wheel lets you scroll through screens of information in a fluid motion. Many new mice are also ergonomically designed to fit the user's hand. And some new mice have Forward and Back buttons off to the side of the mouse, which help you navigate the Internet.

One of the latest innovations is the *optical mouse*, which is becoming quite common. An optical mouse operates by using an infrared sensor, which means it uses neither a rollerball nor a mouse pad. You can identify an optical mouse by the telltale red glow emanating from its underside.

One other hot innovation is the *wireless mouse* (and keyboard). A wireless mouse and keyboard run on batteries and communicate with the computer the same way a remote control communicates with a television.



A wireless mouse works just like a remote control.

Quick Reference

Input devices on a standard computer:

- Keyboard.
- Mouse.

What a mouse does:

- It acts as a handheld pointing device and controls the actions of that blinking item on your computer screen known as a *cursor*.

Lesson 2-5: Keyboard

Figure 2-14

The 101-key enhanced keyboard

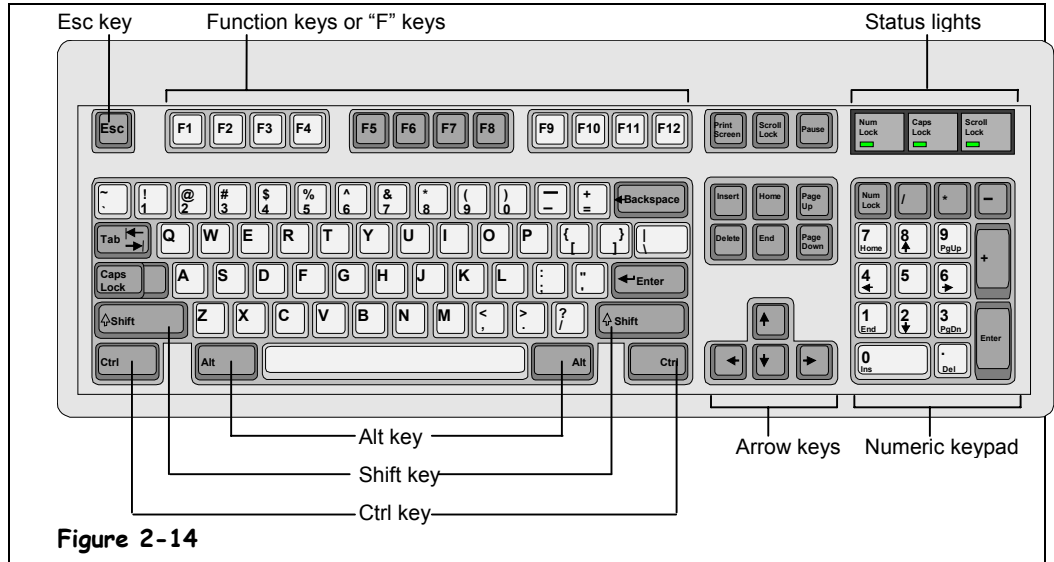

Figure 2-14





An ergonomic keyboard is designed to relieve the stress of typing for long periods of time.







Like the mouse, the keyboard is an input device that allows you to talk to the computer. The keyboard is easily recognizable because it resembles a typewriter keypad. If the typewriter predates you, then look for the component that’s covered with buttons that have letters, numbers, and symbols on them.

If you’ve ever used a typewriter, you probably recognize many of the keys on a keyboard. In any case, the alphanumeric, symbol, and punctuation keys are self-explanatory. And we’ll review the rest of the keys that are unique to a (101-key and 104-key) keyboard. However, we will ignore the three keys found above the numeric keypad (<Print Screen/Sys Req>, <Scroll Lock>, and <Pause/Break>) because they are all fairly useless on most computers today.

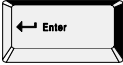
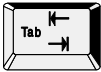
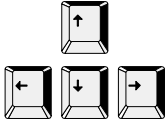
NOTE: If your keyboard includes multimedia and Internet buttons above the keys, consult the manual that comes with your keyboard to learn their functions.

Table 2-4: Special Keys and Their Functions

Key(s)	Description
	The <Alt> key doesn’t do anything by itself—it needs another key to make things happen. For example, pressing the <Tab> key while holding down the <Alt> key switches between any programs that are currently running.
	Just like the <Alt> key, the <Ctrl> key doesn’t do anything by itself—you need to press another key with it to make things happen. For example, pressing the <X> key while holding down the <Ctrl> key cuts whatever is selected.
	The <F1> key is the help key, and pressing it displays helpful information about what you’re doing.

Key(s)	Description
	<p>The <Esc> (Escape) key is the “Wait, I’ve changed my mind” key and is the same as clicking Cancel in a dialog box. For example, if you click something and an unfamiliar dialog box appears, you can close it by pressing the <Esc> key.</p>
	<p>The <Enter> key is the “Carry out my orders” key and is the same as clicking the OK button in a dialog box. For example, after you’ve typed the name of a program you want to run in a dialog box, press <Enter> to run the program. The <Enter> key also adds new lines and starts new paragraphs if you’re entering text.</p>
	<p>When you’re in a dialog box, pressing the <Tab> key moves to the next field. When you’re using a word processor, the <Tab> key works just like you’d think it would and jumps to the nearest tab stop whenever you press it.</p>
	<p>The arrow keys move your computer’s cursor across the screen.</p>
	<p>Nothing surprising here. The <Delete> key deletes or erases whatever you select—files, text, or graphical objects. If you’re working with text, the <Delete> key erases characters to the right of the insertion point.</p>
	<p>Use the <Backspace> key to fix your typing mistakes—it erases characters to the left of the insertion point.</p>
	<p>The <Home> key jumps to the beginning of the current line when you’re working with text.</p>
	<p>The <End> key jumps to the end of the current line when you’re working with text.</p>
	<p>The <Page Up> key moves up one screen.</p>
	<p>The <Page Down> key moves down one screen.</p>

Quick Reference

- A keyboard lets you enter information and commands into a computer.

Lesson 2-6: Digital Cameras and Web Cams

Figure 2-15

A digital camera.

Figure 2-16

A Web cam usually sits on top of a computer's monitor.

Figure 2-17

Cameras with more megapixels can take sharper and more detailed pictures.



Figure 2-15

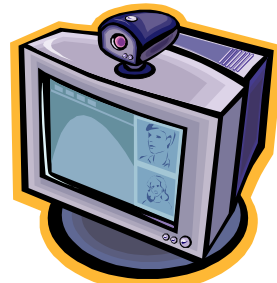

Figure 2-16

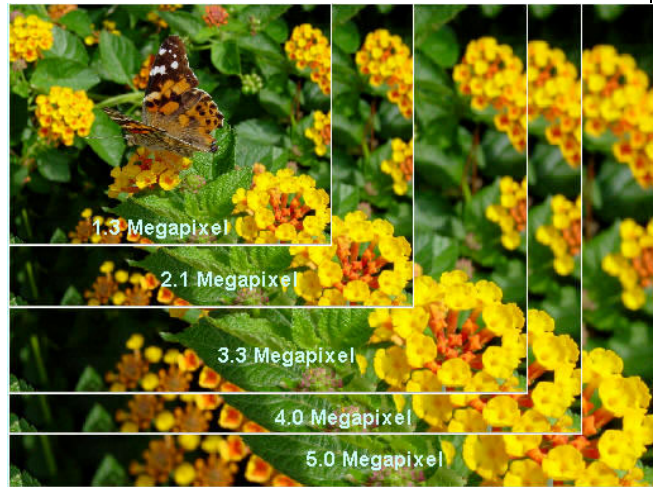



Figure 2-17

A megapixel contains one million pixels.

A digital camera lets you take pictures that you can transfer to a computer. Once you've transferred your pictures you can print them, insert them in word processing document, or send them in an e-mail message. You can also edit digital photos, to remove such undesirable objects as redeye or an ex-boyfriend.

The quality of the pictures a digital camera takes depends on its resolution, which is measured in *megapixels*. One megapixel is equal to one million, or 1000×1000 pixels. The higher the number of megapixels, the clearer and more detailed the picture.

Digital cameras don't use film—they store their pictures on a type of removable memory called *flash cards*. Flash cards can store anywhere from a dozen to several hundred pictures, depending on how much memory they have. There are three different types or formats of flash cards out there:

- 

• **CompactFlash:** Definitely the most common type of “digital film” out there, CompactFlash cards can typically store anywhere from 8MB to over 1GB.
- 

• **SmartMedia:** SmartMedia is another a very popular type of memory card because of its small size. SmartMedia cards are also widely used in many PDAs. SmartMedia cards are available in capacities ranging from 2 MB to 128 MB.

- 
Memory Stick: Sony makes this type of memory card for use in its own products: Sony digital cameras, Sony PDAs, etc. Memory sticks are available in capacities ranging from 4 MB to 128 MB.

Another popular toy you can add to your computer is a *Web cam*. A Web cam is a tiny digital video camera that usually sits on top of a computer's monitor. People use Web cams for videoconferencing and to send live images over the Internet.

Table 2-5: Comparison of Megapixels

Megapixels	Image Size	Description
Under 1	640×480	Entry level and obsolete digital cameras have a measly resolution of 640×480 pixels. These cameras are fine if you want to e-mail someone a picture or send someone a photo on a computer, but the quality of a printed image is terrible when printed as 4x6in photo.
1	1024×768	Supposedly 1024×768 resolution is this is enough to make sharp 4x6 inch prints. The truth is, at this point it depends more on the quality of the digital camera than the resolution. Many printed photos can still look "digital" or blurry at this resolution.
2	1600×1200	Two-megapixel cameras can take fine 4x6 inch prints and even respectable 8x10s, about what you'd expect from a low-end film camera.
3	2048×1536	Once you reach the three-megapixel bracket the quality of print is normally excellent up to 8x11 prints. If you're looking for a really good digital camera with strong features and good image quality, three megapixels is a good range to search in.
4	2272×1740	Four-megapixel cameras are starting to get into the "enthusiast" territory. They take exceptionally sharp photos and can print even larger prints than 8x11.
5	2560×1920	We're definitely in enthusiast professional territory now. Five-megapixel cameras are even used by professional photographers to take really big prints.

Quick Reference

- A **digital camera** lets you take pictures and transfer them to a computer.
- The quality, or resolution of the pictures a digital camera can take are measured in **megapixels**, or millions of pixels (dots). The more pixels, the better the resolution.

Lesson 2-7: Other Input Devices

Figure 2-18



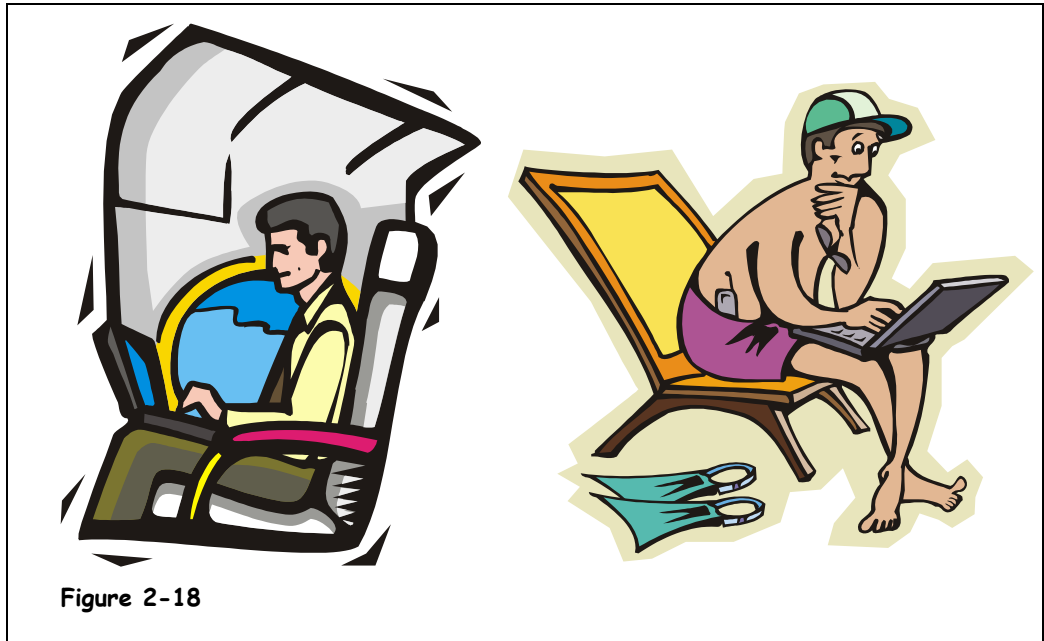



There's usually not enough room to use a mouse on an airplane or on the beach. It's for this reason that most laptops have built-in touch pads and AccuPoint® Pointing Devices.

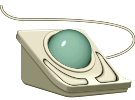

The keyboard and mouse are the two most common input devices for a computer, but there are many more. Most respectable laptops have a built-in touch pad or AccuPoint® Pointing Device or pointing stick that works like a mouse. Other mouse alternatives include track balls and light pens.

Other common computer input devices include scanners for copying images to a computer, joysticks for playing games, and microphones for recording sound. You can learn about these input devices by taking a look at the table on the next page.

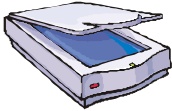
Table 2-6: Other Input Devices

Input Device	Description
 <p>Touch Pad</p>	A touch pad is a small, touch-sensitive pad used as a pointing device on some portable computers. By moving a finger or other object along the pad, you can move the pointer on the display screen.
 <p>AccuPoint® Pointing Device</p>	An Accupoint® Pointing Device, or pointing stick, is another mouse substitute that is found on many laptop computers. An Accupoint® Pointing Device usually sits in the middle of the keyboard and resembles an eraser at the end of a pencil.
 <p>Track Ball</p>	A track ball is essentially a mouse lying on its back. To move the pointer, you rotate the ball with your thumb, your fingers, or the palm of your hand.
 <p>Light Pen</p>	A light pen is input device that utilizes a light-sensitive detector to select objects on a display screen. A light pen is similar to a mouse, except that with a light pen you can move the pointer and select objects on the display screen by directly pointing to the objects with the pen.
 <p>Scanner</p>	A scanner is a lot like a photocopier. Instead of producing copies, a scanner converts images into digital information and stores it in a computer.
 <p>Joystick</p>	Mostly used for computer games, a joystick is a lever that moves in all directions and usually controls some type of movement on the computer.
 <p>Microphone</p>	If your computer has a sound card (and most computer have one) you can plug in a microphone to digitally record sounds to your computer.

 **Quick Reference**
Other Input Devices Include:

- Touch pads
- AccuPoint® Pointing Devices
- Track balls
- Light pens
- Scanners
- Joysticks
- Microphones

Lesson 2-8: Monitor

Figure 2-19

Similar in appearance to a television screen, a monitor displays images and text on its screen.

Figure 2-20

Flat-panel monitors are more expensive than traditional monitors, but they take up less space and use less electricity.

Figure 2-21

Common controls found on the front of a monitor.

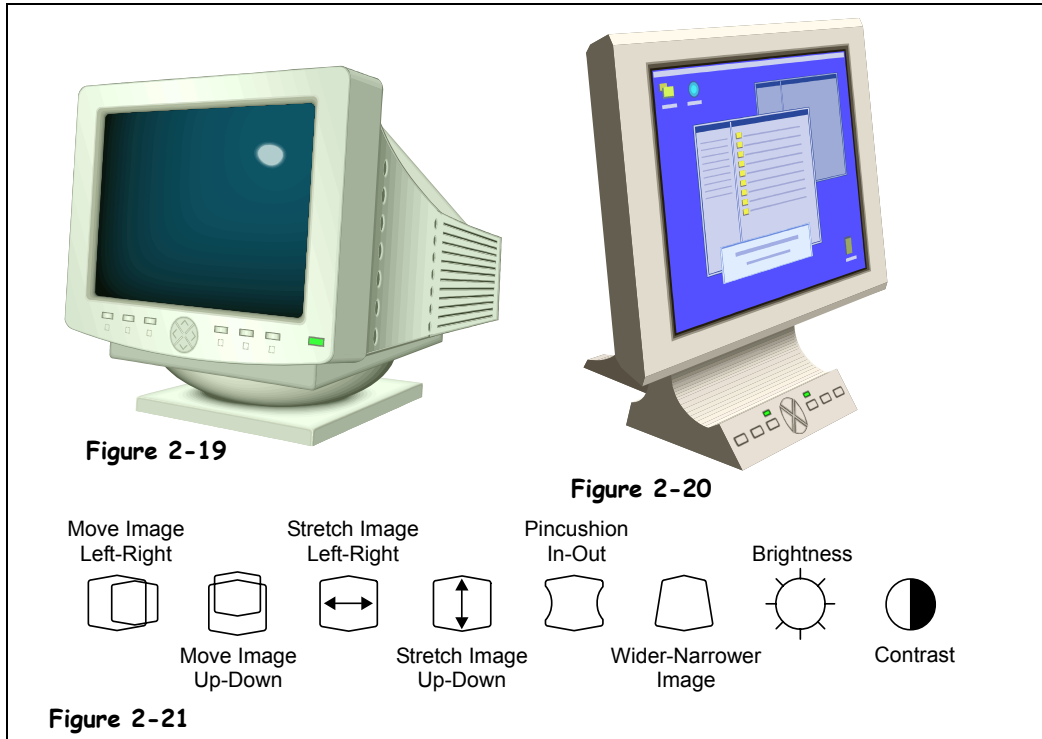
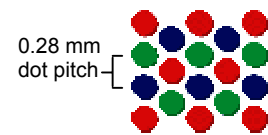

Figure 2-21

A computer's monitor looks and works a lot like a TV screen. The monitor is really only half of what makes text and images appear on the screen. The other half is the graphic card, or video/display adapter. The monitor plugs into the graphics card in the back of the computer.

Flat panel or LCD (Liquid Crystal Display) monitors, like the one in Figure 2-20, will eventually replace older CRT monitors, like the one shown in Figure 2-19. A flat panel monitor is the same type of display that is found in laptop computers. Flat panel monitors are thin, lightweight, and use a lot less electricity than traditional monitors. Flat panel monitors are also considerably more expensive than traditional monitors, although the price is dropping. Flat panel monitors are wider than traditional monitors are; in fact a 15-inch flat panel monitor has almost the same viewing area as a 17-inch traditional monitor!



Dot pitch is the distance between pixels or dots on a screen. Dot pitch is measured in millimeters (mm).

- **Size**
The size of a monitor is measured diagonally across the screen, just like TVs. Common monitor sizes are 15, 17, 19, and 21 inches. The most popular monitor size is currently 17 inches.
- **Dot Pitch**
Dot pitch refers to the distance between each pixel, or dot, on the screen, as measured in millimeters (mm). The smaller the dot pitch, the closer the dots, and the sharper the image is. If you're in the market for a monitor try to find one with a 0.28 mm or less.

- **Refresh Rate**

The refresh rate determines how quickly the monitor redraws, or updates, the image on the screen. Higher refresh rates are better, since they flicker less and are easier on the eyes. The refresh rate is measured in herz (Hz), or the number of times per second the monitor redraws the entire screen. If you're buying a new monitor, make sure to get one with a refresh rate of 72 Hz or better.

- **Screen Savers and Energy Star Compliance**

A screen saver is a moving picture that appears on your computer screen when you don't use your computer for a while. Screen savers originally prevented phosphor burn, which occurred when a static image became etched onto the screen after a long period of time. Today's monitors aren't susceptible to phosphor burn, but some people still use screen savers for fun.

Most monitors are *Energy Star compliant*. This means they automatically turn themselves off after a period of time to save electricity. You turn the monitor back only by simply moving the mouse or pressing a key on the keyboard.



**The Energy Star
Logo**

Quick Reference

CRT Monitors:

- Older type of monitor that looks like a television set.

Flat Panel LCD Monitors:

- Newer type of monitor that is thin, lightweight and somewhat more expensive.

Other Things to Know about Monitors:

- The **size** of a monitor is measured diagonally across the screen. Average monitor sizes range from 15-inches to 21-inches.
- The monitor **refresh rate** determines how quickly the monitor redraws, or updates, the image on the screen. Most monitors have a refresh rate of 72MHz or better.
- A **screen saver** is a moving picture that appears on your computer screen when you don't use your computer for a while.

Lesson 2-9: Graphics Card

Figure 2-22

A computer's monitor plugs into the graphic card, an expansion slot that plugs into a computer's motherboard.

Figure 2-23

Newer computer games have fantastic graphics—but you'll need a 3D graphics accelerator card to see them.

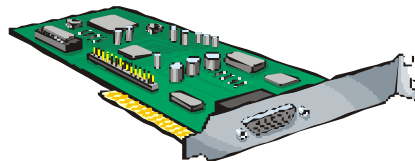

Figure 2-22



Figure 2-23

The second part of a computer's video system is the graphic card or video adapter. A graphics card is an expansion card that plugs into a computer's motherboard and is responsible for all the text and pretty images that appear on your computer's monitor. Many computers don't have a graphics card at all—all the video capabilities are instead built into the computer's motherboard.

Graphics cards come in many models and prices. More expensive graphics cards are faster and can display more complex, 3D graphics—something especially useful if you're into computer games. Here are the basics about graphics cards:

- **Screen Resolution**

Resolution has to do with how much information can fit on the computer screen. Obviously you can't adjust how large or small your computer's monitor is (without buying a new one that is), but you can make all the images on your screen larger or smaller so you can see more information at once. You can adjust the screen resolution to suit your needs and preferences. For more information about screen resolution see Table 2-7: *Common Screen Resolutions*.

- **Color Depth**

Color depth is the number of colors that are displayed on the screen at once. So why would you want to change the number of colors displayed on your screen? Perhaps you want to use higher color depth settings to make videos and photographs more realistic. Or some finicky games also require you to use a specific color depth. For more information about color depth see Table 2-8: *Common Color Depths*.





- **Graphics Card Memory**

Graphics cards have their own memory, or RAM, just like a computer. You'll need more memory to display higher screen resolutions and color depths. Video cards can have anywhere from 1 MB all the way up to 128 MB of memory. If you're buying a new computer, make sure it has at least 64 MB of memory.

- **3D Graphics Accelerator**





A 3D graphics accelerator card has its own CPU that is used to create 3D graphics. If you're even considering playing games on your computer, you should have a 3D graphics accelerator card, as most newer games require one.

Table 2-7: Common Screen Resolutions

Resolution	Description
 640 by 480	No longer supported in most computers, 640 by 480 used to be the lowest resolution setting. Larger and cheaper monitors have made 640 by 480 resolution effectively obsolete.
 800 by 600	This has been the standard resolution setting for most computers, and is the lowest setting on newer monitors. This is a good in-between resolution, allowing you to display quite a bit of information on the screen without having to use a magnifying glass to read it. Use this setting if you have a 15-inch or 17-inch monitor.
 1024 by 768	The new standard, 1024 by 768 puts a lot of information on your screen, but the images can start getting small and difficult to read at this point (unless you have a large monitor). Use this setting if you have a 17-inch or larger monitor or when you want to see a lot of information at the same time, for example if you're working on a large spreadsheet, graphic files, or multiple windows.
 Higher resolutions	Depending on how expensive the graphics card in your computer is, there may be several higher modes of resolution which continue to display more and more information and smaller and smaller images.

Higher Resolutions Require More Speed and Video Memory

Table 2-8: Common Color Depths

Color Depth	Description
 256 Colors	No longer supported on many computers, 256 colors was the standard color depth years ago, but most computers and video cards are fast enough to run with more colors without taking a performance hit, making this color depth almost obsolete.
 16-bit	16-bit color displays roughly 65,000 colors at once. This is the point where pictures become photo-realistic. This is a good color depth setting because it can display photo-realistic images without slowing your computer down. You have to really squint to see much difference between 16-bit color and higher levels of color depth.
 24-bit	24-bit color displays 16.7 million of colors at once. Depending on how expensive the graphics card in your computer is there may be several higher modes of color depth, which continue to display more and more colors on the screen.
 32-bit	32-bit color displays 16.7 million of colors at once. 32-bit color is faster and more efficient than 24-bit color.

More Colors Require More Speed and Video Memory

Quick Reference

Screen Resolution:

- Determines how much information can fit on the computer screen at once. Common screen resolutions include 800 by 600 and 1,024 by 768.

Color Depth:

- Color depth is the number of colors that are displayed on the screen at once. Common color depths include 16-bit and 24-bit color.

Video Cards:

- Have their own memory and processor. Generally speaking, the more memory a video card has, the higher the resolution and color depth it can display.

Lesson 2-10: Printer Basics

Figure 2-24

InkJet printers are the most inexpensive and popular type of printer sold today.

Figure 2-25

A printer's resolution determines the quality of the images it can produce.

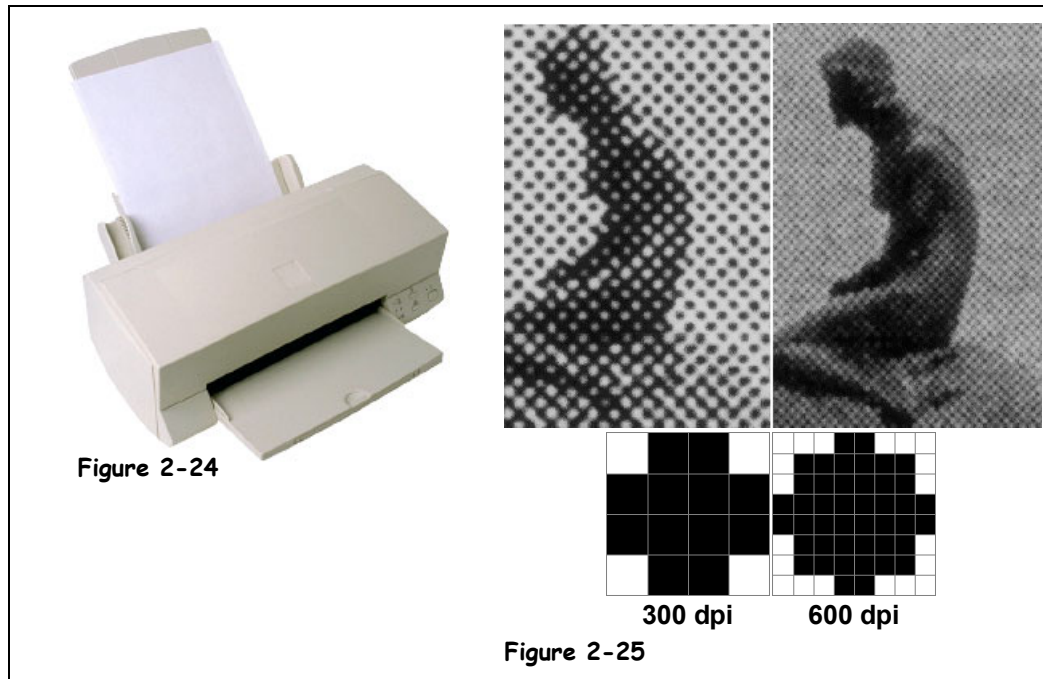

A printer is an output device that puts text and graphics on paper. Using the printer is often the last step in creating something on a computer, whether it's a letter, spreadsheet, or digital photograph.

Unfortunately, there's a lot to know about printers—especially if you're buying one. Here are the main printer concepts you should know:

- **Type of Printer**

There are several different types of printers out there: InkJet and Laser printers are the most common. InkJet printers are the cheapest and most common type of printer and can be found in both homes and businesses. Laser printers are usually faster than InkJet printers, but they normally can only print in black and white. Laser printers are used mainly by businesses.

- **Color vs. Black and White**

Color used to be an expensive option for printers, but not any more. Most InkJet printers can print in color and so can an increasing number of laser printers. Most laser printers still print in black in white—great for text but not for images and graphics.

- **Resolution**

A printer's resolution helps determine the quality of the images it can produce. Higher resolution means higher quality images. Printer resolution is measured in dots per inch (dpi). Generally, 600-dpi resolution works great for text documents, while you will probably want 1200 dpi or better resolution for printing images. See Figure 2-25 for a good illustration of varying resolutions.

- **Speed**

A printer's speed determines how quickly it can print pages. Speed is measured two ways: in characters per second (cps) or in pages per minute (ppm). Either way you want a higher number if you want to have a faster printer. Printers usually slow down quite a bit when printing pages with a lot of complicated graphics, or color images.

- **Ink Cartridges and Toner**

Today many InkJet printers are cheap—about as much as dinner for two at a very fancy restaurant. Sound too good to be true? Here's the catch: the ink for most printers costs a *lot* of money. InkJet printers use ink cartridges that seem to run dry at an alarming speed. Laser printers use toner cartridges filled with the same messy black powder that is found in copy machines. Laser toner cartridges last a lot longer than InkJet cartridges, but they also cost significantly more.

- **Memory**

Laser printers have their own memory, or RAM, just like a computer. This memory is used to store pages before they are printed. Memory is important for printing complex or high-resolution images. Most laser printers have anywhere from 2 MB to 8 MB of memory.

- **Print Buffer and Spooler**

Computers are a lot faster than most printers are, so they can send information faster than the printer can accept it. A printer buffer or spooler fixes this problem. A print buffer works like a dam: it holds back the information and releases it at a rate that the printer can handle.

 **Quick Reference**

- **InkJet and Laser** printers are the most common printer types.
 - **Printer resolution** determines the quality of the images a printer can produce. Printer resolution is measured in dots per inch (dpi).
 - A printer's speed determines how quickly it can print pages.
 - Printers get their ink from expensive cartridges (InkJet printers) and toners (laser printers)
 - Many printers have their own memory, which is required for printing more complex images.
 - A **print spooler** or **buffer** temporarily stores large print jobs and releases them when the printer is able to print them.
-

Lesson 2-11: Types of Printers

Figure 2-26

There are many different types of printers available, with an enormous range of prices and features.

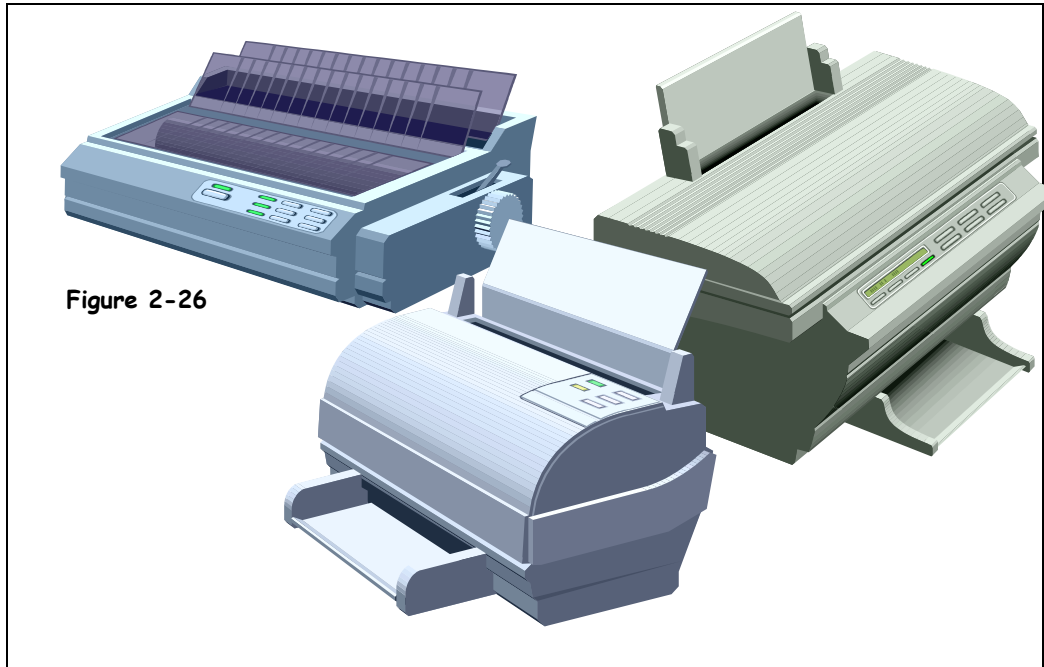







Figure 2-26

Leonardo da Vinci didn't limit himself by using only paint and brushes to create his masterpieces; he also used chalk to make sketches and a chisel and hammer to make sculptures. Maybe Leonardo would have used an airbrush or spray paint if they had been invented yet. Hmm... maybe not. Because there are different types of print jobs there are different types of printers. Are you a home user that prints an occasional letter or two? You'll probably want to buy a cheap *InkJet* printer. Are you a busy office that has lots of people who need to print lots of documents? You're probably looking at getting a *Laser* printer.

The following table describes the main types of printers out there and how or why you would use them, so you'll have no excuse for buying the wrong kind of printer when you get around to buying one.

Table 2-9: Types of Printers

Printer Type	Description
 <p>Ink Jet</p>	<p>Inkjet printers are easily the most popular and inexpensive type of printer out there. If you have a printer for your home computer, chances are it's an InkJet printer. InkJet printers create images by spraying ink onto a page. The inexpensive InkJet printer gets its ink from very expensive InkJet cartridges.</p> <p>Most InkJet printers can print in color, and their speeds vary from 2 to 16 pages per minute (ppm).</p>

Printer Type	Description
 <p data-bbox="256 443 321 468">Laser</p>	<p data-bbox="418 237 1198 384">Laser printers have blazing speed—anywhere from 4 to 20 pages per minute (ppm), great resolution—anywhere from 300 to 1,200 dots per inch (dpi), and recently have become relatively inexpensive. Laser printers are great for businesses and people who need to produce large amounts of text documents or correspondence.</p> <p data-bbox="418 405 1198 552">Laser printers use the same technology as photocopy machines to create black and white images on paper. Laser printers use powdered black ink, called toner, just like photocopy machines do. When the toner cartridge runs out, you have to replace it with a new toner cartridge. Toner cartridges cost a lot more than InkJet cartridges do, but they also last a lot longer.</p>
 <p data-bbox="228 753 354 779">Color Laser</p>	<p data-bbox="418 573 1166 657">A color laser printer works just like an ordinary laser printer, except that it can print in color, of course. Color laser printers are quite expensive and the color toner cartridges for them are even costlier.</p>
 <p data-bbox="224 957 354 982">Multifunction</p>	<p data-bbox="418 804 1190 888">As its name implies, a multifunction printer can perform more than one task. Multifunction printers can usually operate as a fax machine, copier, and scanner in addition to their traditional printing duties.</p>
 <p data-bbox="237 1236 341 1262">Dot Matrix</p>	<p data-bbox="418 1014 1117 1066">Popular in the 1980's, noisy dot-matrix printers have gone the way of the dinosaurs, except in businesses that need to print on carbon copies.</p> <p data-bbox="418 1087 1205 1203">Dot matrix printers usually use a type of paper with holes punched along each side called continuous form paper, and loads it through something called a tractor feed. Dot-matrix printers range in speed from 25 to 450 characters per second (cps), or 1 to 18 pages per minute (ppm).</p> <p data-bbox="418 1224 1205 1350">Resolution is measured differently with dot-matrix printers. Instead of using dot per inch (dpi) dot matrix resolution is measured by how many little pins are on the dot-matrix print head. Dot-matrix printers are available with 9-pin (terrible quality) and 24-pin (higher quality) print heads.</p>
 <p data-bbox="253 1541 321 1566">Plotter</p>	<p data-bbox="418 1371 1170 1423">Don't expect to find a plotter at your local computer store. Plotters are special, very expensive printers that are used to create posters and blueprints.</p>

Quick Reference

Print Types Include:

- InkJet
- Laser and color laser
- Multifunction
- Dot matrix
- Plotter

Lesson 2-12: Sound and Speakers

Figure 2-27

Older computers had a sound card, which plugged into the motherboard of the computer. Newer computers have sound capabilities built into the motherboard.

Figure 2-28

You'll need to connect a pair of speakers or headphones to your computer if you want to hear sound.

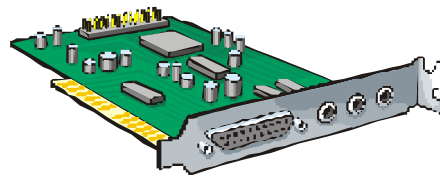

Figure 2-27

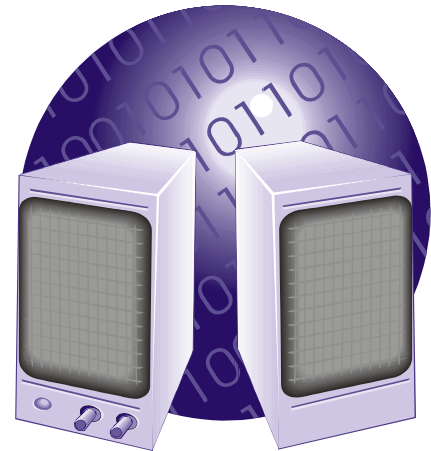

Figure 2-28











The term *sound card* is a little misleading; sound cards used to be expansion cards that plugged into a computer's motherboard. Although such sound cards still exist, today most computers have sound capabilities built into their motherboards. Either way, a sound card basically does two things: it plays and records digital sounds.

The types of sounds your computer can play range from the sounds you hear when you turn on your computer, to explosions in a computer game. A sound card can also play MP3 music files. An MP3 is a highly compressed sound file that lets you play CD-quality music on your computer.

While it's not nearly as important, sound cards also let you record sounds if you plug in a stereo or microphone. For example, you could use a sound card to record your aging cassette tape collection to MP3 files. Newer speech recognition software also requires that you have a microphone plugged into your computer.

Sound cards have the most confusing ports or jacks on the entire computer. Most of them look almost exactly the same—especially if you're crouched in the dark under a desk trying to plug in a pair of speakers to your computer. The table on the following page might make things a little easier by describing each of these ports.

Table 2-10: Sound Card Jacks and Ports

Jack	Picture	Description
 Speaker		This is the main jack where you connect your speakers or headphones to hear the sounds produced by the sound card.
 Microphone		This jack lets you connect a microphone to your computer so that you record sounds and use speech recognition software.
 Line Out		You can listen to your computer through your home stereo system if you plug it into this jack. This is especially useful if you want to play MP3 files on your stereo.
 Line In		You can record a cassette, audio CD, or the radio by plugging a stereo system into this jack.
 Game Port		This port lets you connect a joystick, used for playing games, to your computer.

 **Quick Reference**
Sound Cards:

- Allow computer to play and record digital sounds.

Lesson 2-13: Modem

Figure 2-29

An internal modem plugs into an expansion slot inside a computer.

Figure 2-30

An external modem plugs into a serial port and sits outside a computer.

Figure 2-31

Most laptops have a built-in modem.

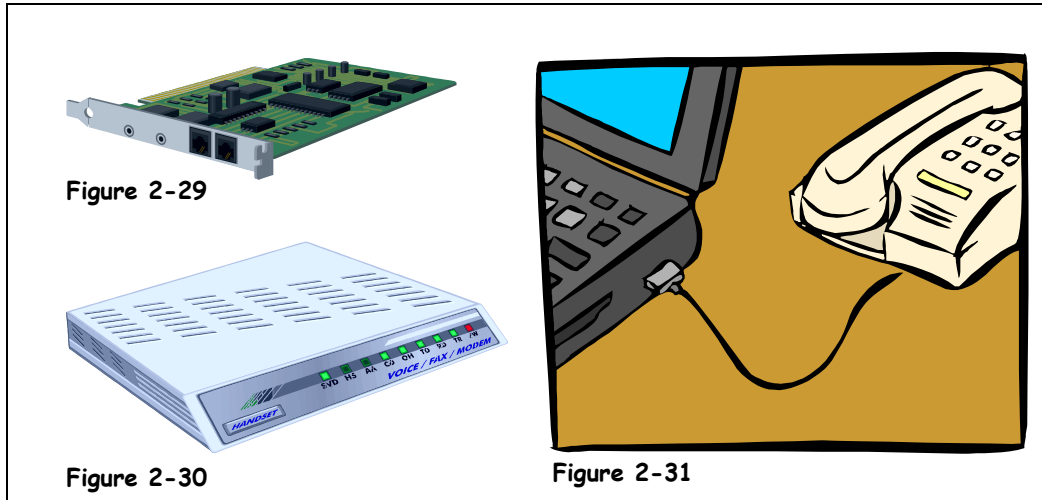

Just about every new computer comes with a built-in *modem*. A modem translates a computer's ones and zeros into audio tones, so that it can transmit information over the phone lines to other modems. The speed of a modem is measured by how fast it can transmit information in bits per second (bps).

- **Internal:** Most computers have an internal modem, like the one shown in Figure 2-29. Internal modems often plug into an expansion slot and are cheaper than external modems.
- **External:** An external modem, like the one shown in Figure 2-30, plugs in to a computer's serial port. Newer, *broadband* modem may plug into the USB or Ethernet port. A broadband modem transmits information directly over a connection, unlike older traditional modems that have to convert the information to tones or sounds first. Because of this, broadband modems are very, very fast—much faster than standard modems. DSL and Cable are the most common types of broadband connections.

Here's a quick overview of the major types of modems that are available:

Table 2-11: Modem Types and Speeds

Type	Speed (in bps)	Description
Standard	56K	Standard modems connect to a standard telephone line and are used for dial-up connections to the Internet.
Digital / Broadband	ISDN	One of the older broadband connections. It's only twice as fast as a traditional modem and pretty much obsolete.
	DSL	DSL modems take advantage of unused frequencies in the phone line, such as a pause in conversation. DSL modems are very fast; the problem is that you have to be close to a phone company in order to get DSL service.
	Cable	A cable modem is the fastest modem you can buy for home use. The problem is your cable company has to offer cable Internet access in order to use it.

Quick Reference

Standard Modems:

- Transmit information over standard phone lines to other computers. Maximum speed is 56K bps.

Broadband and Digital Modems:

- Much faster than standard modems, with speeds up to 4,000K bps. Broadband modems include ISDN, DSL, and Cable.

Lesson 2-14: Input/Output Devices



Figure 2-32



Figure 2-33

Figure 2-32

A touch screen monitor is an example of an input/output device.

Figure 2-33

A multifunction printer is another example of an input (scanner)/output (printer) device.

Some computer devices can be categorized as *both* an input device and an output device. For example, a multifunction printer, like the one shown in Figure 2-33 has a scanner (input) and a printer (output). Touch screen monitors are another example of an input/output device; they display images (output) and also let users interact with the computer by pressing areas of the screen (input).

Quick Reference

- Some computer devices have both input and output functions. Examples include touch screen monitors and multifunction printers.

Lesson 2-15: Hard Drive

Figure 2-34

How information is stored in a file cabinet.

Figure 2-35

How information is stored on a hard disk.

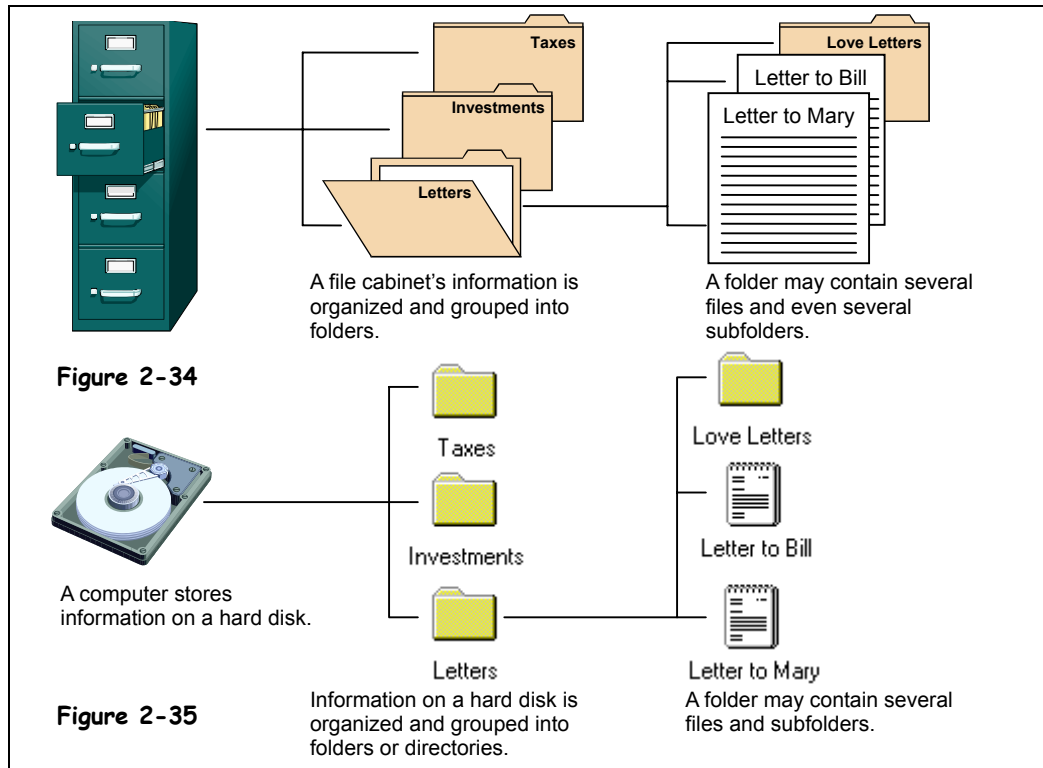

Storage Notes: Internal Hard Disk

Speed: Very fast. Most hard disks have an average access speed of between 8 to 15 milliseconds (ms).

Capacity: Enormous. Many hard disks have more than 200 Gigabytes (GB) of storage.

Cost: Hard disks are becoming more and more inexpensive. Byte for byte they are the most inexpensive way to store data.



Unlike floppy disks and CD-ROMs, most hard disks reside inside of the computer or system unit and cannot be easily removed.

A hard drive or hard disk is a computer's main storage device. Most hard drives are tucked away in the system unit of a computer and hidden from view. Although you normally can't see a computer's *internal* hard drive you can usually hear it whirring inside when you start the computer or a program. An external hard drive sits outside the computer's system unit and plugs into a USB, Firewire, or SCSI port.

The hard drive is like the file-cabinet portion of your desk. And files really are saved in folders on a computer, so this really is the perfect analogy. Most computers have a single hard drive located inside of the computer case labeled C. When a computer has more than one hard drive they are labeled D, then E, and so on. Unlike RAM, a hard drive retains its information even when you turn the computer off.

So what's stored on a hard drive? Let's take a look...

- **Operating System Files**

A computer's operating system, like Windows XP, is stored on the hard drive.

- **Program Files**

Program files are the programs you work with, like your word processor, your Internet software, or your games. Programs usually come on floppy disks or CD-ROM's, to use it first install, or copy, it to your hard drive in order to use the program.

- **Data Files**

Whenever you create a document or data file on your computer, like a word processing document, the computer stores it in its temporary memory (RAM.) You must save your documents to the hard drive or they will be lost when you turn off your computer.

Most hard drives are connected to a computer's motherboard through something called an *IDE* (Integrated Drive Electronics) connection. You can also connect CD-ROM and DVD drives to an IDE connection. A slight problem with IDE is that it only supports a total of four devices or drives. This isn't a big deal for most home users, but it is if you're a business and need a server with lots of hard drives. So there's another way to connect hard drives to a computer: through a SCSI (pronounced—get this—*scuzzy*) port. SCSI connections are often faster than IDE and they can connect up to seven devices instead of four.

OK, so what else do you need to need to know about hard drives?

- **Hard Disk Size (or Capacity)**

How much information (how many programs and data) a hard drive can store is measured in bytes, just like RAM. Hard drive sizes in newer computers range from 20 Megabytes (MB) all the way up to 200 Gigabytes (GB)! How big a hard drive should you get when you buy a computer? Normally try to get at least 40 Gigabytes if you're a home or small business user. More is better in hard drives, because programs keep getting bigger.

- **Average Access Time**

A hard drives average access time is how fast it can find information. Average access time is measured in milliseconds (ms), or 1/1000 of a second. The lower the access speed, the faster the hard drive. Most newer computers have an average access time of 8 to 15 ms.

 **Storage Notes:
External Hard Disk**

Speed: Very fast, though normally slower than internal hard disks.

Capacity: Enormous – same as internal hard disks.

Cost: Slightly more expensive than internal hard disks.

 **Quick Reference****Hard Drive:**

- A computer's main storage device, sometimes called the C drive.
- Modern hard drives can store anywhere from 20GB to 250GB of information.
- **Average access time** is how fast a hard drive can find information.
- Hard drives are connected to a computer through either an **IDE** or **SCSI** interface.

Lesson 2-16: Hard Drive Maintenance

Figure 2-36

Routine hard drive maintenance keeps computers happy and running smoothly.

Figure 2-37

Most hard disk repair tools can be found in Microsoft Windows by right-clicking the hard drive, selecting Properties from the shortcut menu, and clicking the Tools tab.

Figure 2-38

Hard drives need to be defragmented periodically to make them more efficient.

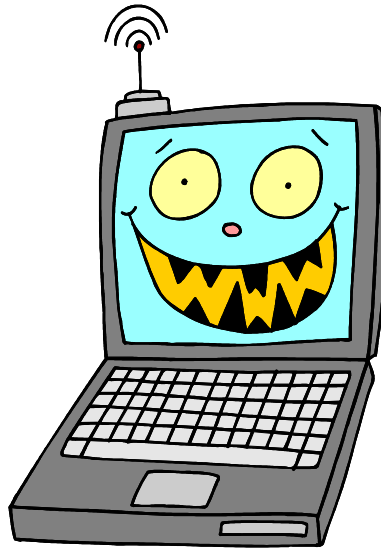

Figure 2-36

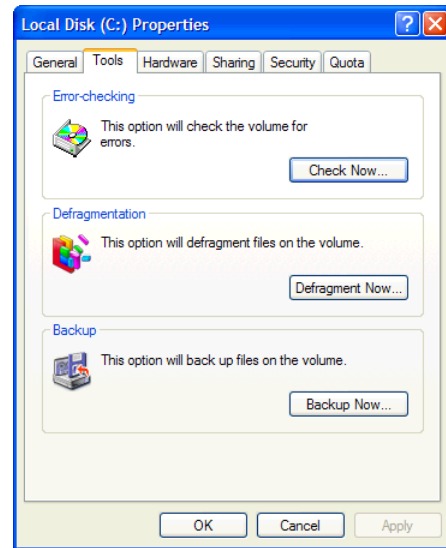

Figure 2-37

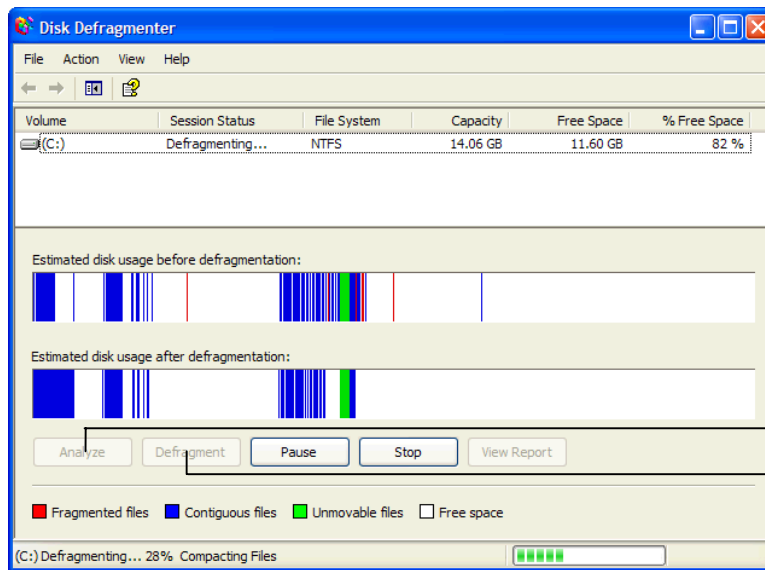

Figure 2-38

Create a fragmentation report on the selected drive
Defragment the selected drive

Cars require maintenance to keep them running at their peak performance. Some car maintenance tasks are simple and routine, such as changing the oil every 3,000 miles. Others are more complicated, such as installing a new radio. Hard drives are no different—they require routine maintenance to prevent and/or correct problems and to keep them running at their best performance.

By now you're probably wondering, "How does one maintain a hard drive?" There are quite a few ways:

- **Repair a Hard Drive**

Over time, hard drives can become damaged, effecting their performance. Fortunately most of the hard drive damage is caused by normal wear and tear and is not serious. You can diagnose and correct most hard drive problems with a hard drive repair program. Microsoft Windows comes with a built-in hard drive repair program.

- **Defragmenting a Hard Drive**

Normally a computer stores a file in the same location on a hard drive. Over time, a hard drive can become *fragmented*, and instead of storing a file in the same location it begins storing parts of it all over. When the computer needs to read a fragmented file, it must read several different parts of the hard drive instead of just one. Defragmenting a hard drive puts the fragmented files back together in one place. You should defragment your computer's hard drive about once a month.

- **Backing up a Hard Drive**

A computer's hard drive stores information even when the computer is turn off, but you should still back up the documents you create to some type of removable storage, like a CD-RW or tape backup. This will give you an extra copy of your files in case your hard drive is damaged.

- **Virus Protection**

A computer virus is actually a small computer program written by a malicious person with the purpose of vandalizing computers by erasing information on their hard drive and causing other problems. Anti-Virus programs that protect computers against viruses, like Norton AntiVirus or McAfee VirusScan, are available at most computer stores. If you're even thinking about connecting to the Internet, you need to have AntiVirus software installed on your computer.

- **Hard Drive Compression**

A computer can increase space on a hard drive by using a special program to compress, or squeeze together, the files stored on a hard drive. Most data compression programs can effectively double the amount of information a hard drive can store. Sounds great, so why don't many people use disk compression? First, data compression slows your hard drive because the computer has to uncompress files before it can read them. Second, data compression often causes more problems in hard drives. Third, several programs won't run on the computer with compressed hard drives. Don't compress your hard drive unless you absolutely have to, and even then it might be better to start looking for a new, larger hard drive than to use data compression.

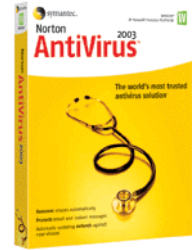

Make sure you install antivirus software on your computer to prevent malicious computer viruses.

Quick Reference

Hard Drive Repair and Fragmentation:

- Over time, small errors and fragmentation can degrade the performance of a hard drive. These problems can be corrected by a hard drive utility program.

Hard Drive Backups:

- Should be performed to give you an extra copy of your files if your hard drive becomes damaged.

Virus Protection:

- Software should be installed on every computer to protect against malicious computer viruses.

Compression:

- Increases the space on a hard drive by compressing, or squeezing together, its files.

Lesson 2-17: CD-ROM Drive

Figure 2-39

A CD-ROM drive.

Figure 2-40

A CD-ROM drive can also play the same, great audio CDs that a stereo system does.

Figure 2-41

Newer CD-ROM drives can transfer data faster than older drives, as this table shows.

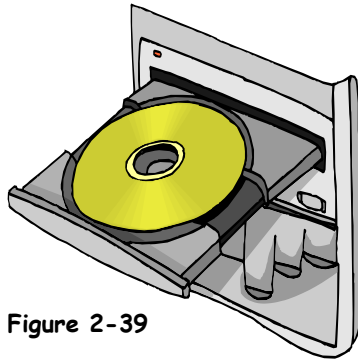

Figure 2-39

CD-ROM Speed	Transfer Rate
8x	1,000 KB/s
10x	1,600 KB/s
12x	1,800 KB/s
16x	2,400 KB/s
24x	3,600 KB/s
32x	4,800 KB/s
40x	6,000 KB/s
48x	7,200 KB/s
60x	9,000 KB/s

Figure 2-41

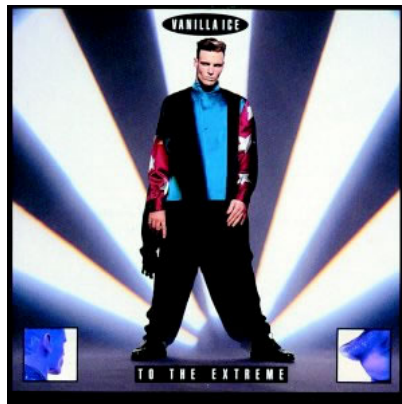

Figure 2-40

Storage Notes: CD-ROM

Speed: Much slower than a hard disk, but still faster than a floppy.

Capacity: About 650 Megabytes (MB).

Cost: Very inexpensive.

Another type of drive almost all computers have is a CD-ROM drive (CD-ROM stands for Compact Disc-Read Only Memory). CD-ROM drives play CD-ROM discs—the same kind of compact discs you can play in your stereo system. CD-ROMs can store lots of information: a single CD-ROM can hold more than 600 Megabytes (MB) of data—more than an encyclopedia set! Unlike a hard drive, most CD-ROMs can only read information—you can't save, or record anything on them (that's what the ROM in CD-ROM stands for: *Read Only Memory!*) On the other hand, CD-RW drives *can* read and write (or burn) to special CD-R and CD-RW discs (the RW in CD-RW stands for *ReWritable*.) The CD-ROM drive is usually labeled D on most computers.

The speed of a CD-ROM drive determines how quickly the computer can read information stored on the CD-ROM. Faster CD-ROM drives produce better sound and video quality. The original CD-ROM drive was no faster than an audio CD player, so the speed of all subsequent CD-ROM drives is measured by how many times faster they are than the original, 1x CD-ROM drive. Today's CD-ROM drives are up to *sixty times (60x)* faster than the original.

Here are some things you can do with CD-ROMs:

- **Install Programs**
More programs are coming on CD-ROMs because of their large storage capacity. Instead of installing and copying 20 floppies to your hard drive, you only have to install a single CD-ROM.
- **Run CD-ROM Programs**
CD-ROM-based programs are usually the coolest programs available for your computer. CD-ROM programs often have rich, exiting multimedia content: high quality sounds, music, videos, and animations. For example, a popular CD-ROM program is a complete, searchable encyclopedia set which contains high quality pictures, sounds, music, and videos.
- **Play Audio CDs**
Most CD-ROM drives are capable of playing audio CDs—the same kind your stereo uses! So your computer can play music while you work.

Table 2-12: Types of CD's

<i>CD Type</i>	<i>Description</i>
CD-ROM	The original, standard CD, CD-ROM stands for Compact Disc, Read-Only Memory. What this means is that you can only read information from a CD-ROM; you can't add new information.
CD-R	If you have a CD-RW drive you can permanently store information on a CD-R (Compact Disc-Recordable) disc. The information you write or <i>burn</i> to a CD-R is permanent and can't be changed or erased. You can also use CD-R discs to create musical CDs that you can listen to in a stereo system.
CD-RW	Unlike CD-R discs, a CD-RW (Compact Disc-ReWritable) disc can be written to many times. You can also modify and erase information on a CD-RW disc—if you have a CD-RW drive, of course.

Quick Reference

CD-ROM:

- Stands for Compact Disc-Read Only Memory. A CD-ROM drive lets you install programs, run CD-ROM based programs, and play audio CDs. A CD-ROM holds about 650MB of information.

CD-R:

- Stands for Compact Disc-Recordable. Lets you permanently write or burn information.

CD-RW:

- Stands for Compact Disc-ReWritable. Can be written to and modified many times.

Lesson 2-18: DVD Drive

Figure 2-42

A DVD disc looks almost identical to a CD-ROM disc.

Figure 2-43

The DVD logo.

Figure 2-44

A single DVD can store as much information as several CD-ROMs.

Figure 2-45

A DVD drive can also play the same, great movies that you can watch on a DVD player.

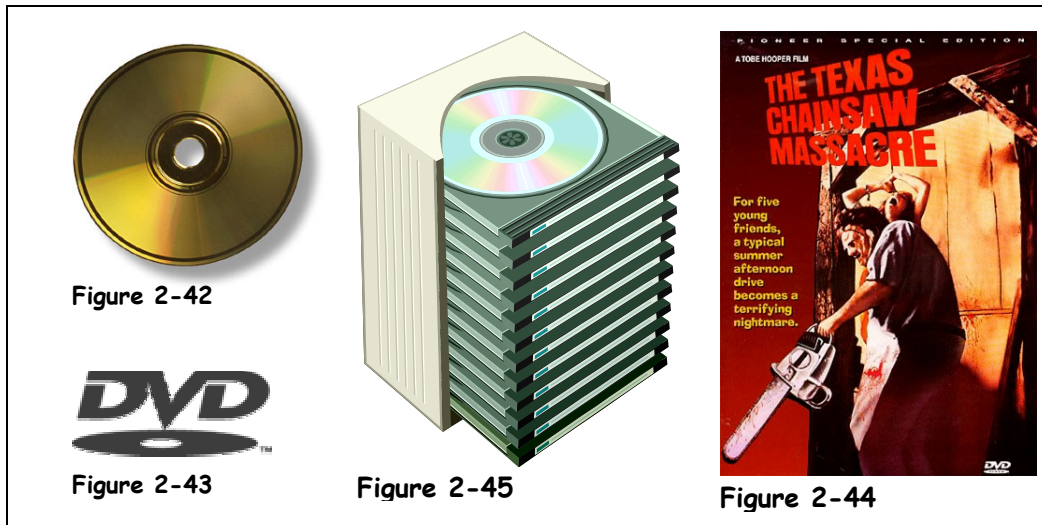

Storage Notes: DVD

Speed: Faster than a CD-ROM drive but not as fast as a hard disk.

Capacity: Usually about 4 Gigabytes (GB), although future DVD discs are rumored to hold up to 17 Gigabytes (GB).

Cost: Slightly more than a CD-ROM but still very inexpensive.

Next generation DVD drives are quickly replacing CD-ROM drives in newer computers. A DVD (stands for Digital Versatile Disc) disc looks just like a CD-ROM, but it can store more than 4 Gigabytes (GB) of information—as much as seven CDs. There are even rumored to be future DVD discs that can hold up to 17 Gigabytes! Unfortunately there still really isn't a lot of software that is available on DVD discs. Most people simply use their DVD drive to watch DVD movies. The CD-ROM drive is usually labeled D or E on most computers.

New rewritable DVD drives, that can record or burn information to special type of DVD discs have recently become available the market. Unfortunately for the consumer, the greedy DVD manufacturers couldn't agree on a universal recordable DVD standard, so there are several different competing formats out there. Hopefully consumers will eventually make the decision for the DVD manufacturers, like they did between Betamax and VHS videotapes. Until then there isn't really any clear answer about which recordable and rewritable DVD format to go with, although both DVD+RW and DVD-RW discs work in most newer DVD drives and players. We can tell you that recordable DVD-RAM format is almost universally *not* compatible with most DVD players. Table 2-13: *DVD Formats* tries to make sense of all the available formats. For more information on recordable DVD standards, visit <http://www.dvdrhelp.com/dvdplayers.php> on the Web.

Table 2-13: DVD Formats

DVD Format	Description
DVD-ROM	The original, standard DVD. ROM stands for Read-Only Memory. This means you can only read information from a DVD; you can't add new information.
DVD-R	If you have a DVD-RW drive you can permanently store information on a DVD-R (DVD-Recordable) disc. The information you write or burn to a DVD-R is permanent and can't be changed or erased. DVD-RW drives can also write to DVD-RW discs

DVD Format	Description
DVD-RW	<p>If you have a DVD-RW drive you can use DVD-RW (ReWritable) discs, which can be re-written up to 1,000 times. You can also modify and erase information on a DVD-RW disc. DVD-RW discs have some compatibility problems with older DVD Players and DVD ROM drives.</p> <p>DVD-RW drives can also write to DVD-R discs.</p>
DVD+R	<p>If you have a DVD+RW drive you can permanently store information on a DVD+R (DVD+Recordable) disc. The information you write or burn to a DVD+R is permanent and can't be changed or erased.</p> <p>DVD+RW drives can also write to DVD+RW discs.</p>
DVD+RW	<p>If you have a DVD+RW drive you can use DVD+RW (ReWritable) discs, which can be re-written to up to 1,000 times. You can also modify and erase information on a DVD+RW disc. DVD+RW discs have some compatibility problems with older DVD Players and DVD ROM drives.</p> <p>DVD+RW drives can also write to DVD+R discs.</p>
DVD-RAM	<p>DVD-RAM is a rewritable DVD format that can be re-written to many times. DVD-RAM discs are beginning to look like an orphan format, since they won't work in most DVD players.</p>

Quick Reference

DVD:

- Stands for Digital Versatile Disc. A DVD disc looks like a CD-ROM, but can store much more information.

Recordable and Rewritable DVDs:

- There are several competing, non-compatible formats out there, including DVD-R /DVD-RW and DVD+R/ DVD+RW.

Lesson 2-19: Floppy Drive

Figure 2-46

A relic of the past, floppy disks don't have the speed or capacity to be very useful in the 21st century.



Storage Notes: Floppy Disk

Speed: Very slow.

Capacity: Very small – 1.44 Megabytes (MB).

Cost: Very cheap.

Quick Reference

Floppy Disks:

- Are slow and can only store 1.44MB. They are all but obsolete.

Most desktop computers still have a floppy drive, although most laptops have dropped the all-but-obsolete floppy drive. Floppy drives read flat, 3½-inch floppy disks. Floppy drives are as slow as a glacier when compared to hard drives and CD-ROM drives. Floppy disks can only store a scant 1.44 Megabytes (MB) – just a little more than your typical novel.

So why are these relics from the 1980's still around? Floppy disks can still be useful for transferring and backing up small documents. Some other uses for floppy disks include:

- A mini cutting board
- An eye patch (for one-eyed software pirates)
- A room divider for hamsters
- An accessory for aging computer nerds

Lesson 2-20: Zip and Jaz Drives

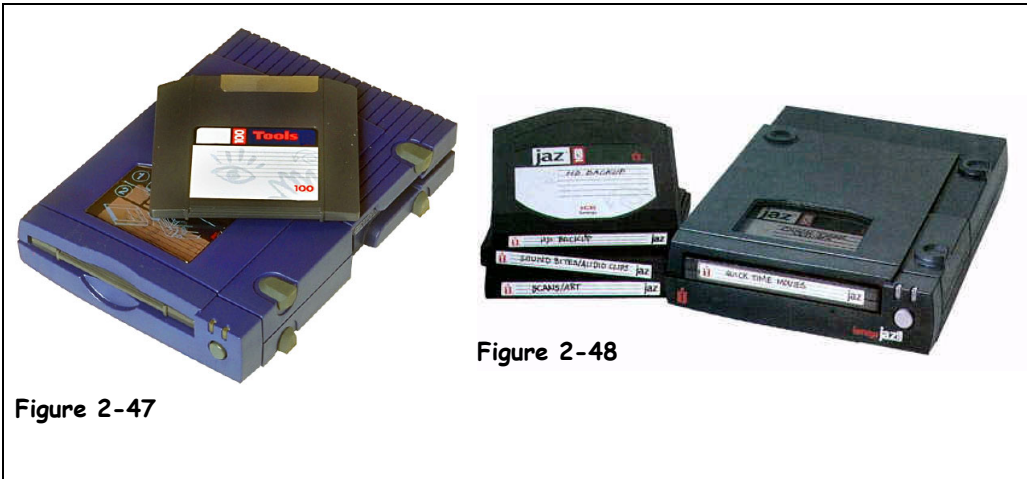

Figure 2-47

Figure 2-48

Removable storage drives have features of both hard drives and floppy drives. Removable storage drives work like a floppy drive because they read and write information on small, removable cassettes that are about the size of a floppy disk. They are like hard drives because each cassette can usually hold more than 100 megabytes (MB) and is much faster than a floppy disk, but still not quite as fast as a hard drive. Two of the most popular removable storage drives are the Zip drive and Jaz drive, both made by Iomega.

Zip disks can store 100 to 250 Megabytes (MB) on a removable disk—about 70 to 170 times as much as an old floppy disk. Zip drives are available in both 100MB and 250MB versions. You'll need a 250MB version to read both 100MB and 250MB Zip disks. Zip disks are a great way to transfer and backup information—but they're not much of a value when compared to newer CD-RW and even newer DVD-RW discs.

Jaz disks can store 1 to 2 Gigabytes (GB) on a single removable disk—as much as an older hard drive! Jaz drives are also fast, though not as fast as a hard disk, so they're great for backing up information. Despite their huge storage capacities, Jaz drives really never caught on.

Figure 2-47

A Zip drive can store 100MB or 250MB on removable Zip disks.

Figure 2-48

A Jaz drive can store 1GB or 2GB on a removable Jaz disk.

Storage Notes: Zip Drive

Speed: Significantly slower than most hard disks.

Capacity: 100 to 250 Megabytes (MB).

Cost: Expensive when compared to costs of equivalent CD-RW discs and other storage devices.

Storage Notes: Jaz Drive

Speed: Slower than most hard disks, but faster than a Zip disk.

Capacity: 2 Gigabytes (GB).

Cost: Fairly expensive when compared to costs of equivalent CD-RW discs and other storage devices.

Quick Reference

- Zip and Jaz drives are removable storage devices that have features of both floppy and hard disks.

Lesson 2-21: Other Storage Devices

Figure 2-49

Flash cards are most commonly used as the 'film' in digital cameras and can also be read by many PDAs and most computers.

Figure 2-50

A tape backup automatically makes a copy, or backup, of all the files on a computer's hard drive.







Figure 2-49

Figure 2-50

We've covered the main storage devices that are out there, but it seems as if one or two new storage devices are invented and released every year; some catch on, some don't. Here's a run-down on some of the less common storage devices that are out there:

Table 2-14: Other Storage Devices

<i>Device</i>	<i>Description</i>
 Tape Drive	A tape drive creates copies, or backups, of the files on a computer's hard drive onto a tape cartridge. The backed up files can be restored in case the original files are lost due to disaster or stupidity.
 LS-120 SuperDrive	The LS-120 drive was meant to be an alternative to Zip disks, because it could store 120 MB of data on a disk, and a replacement for floppy drives, because it could also read and write to traditional 1.44 MB floppy disks. Unfortunately LS-120 never really caught on with the general public.
 Flash Cards	Flash cards are commonly used as the 'film' for digital cameras. Flash cards can store anywhere from a dozen to several hundred pictures, depending on how much memory they have. There are three different types of flash cards: CompactFlash cards, SmartMedia cards, and Memory Sticks. Flash cards can store anywhere from 4 MB all the way up to 1 GB. Wow!
 USB Flash Drive	A USB flash drive is really another type of Flash Card that plugs into a USB port. USB flash drives range in sizes from 16 MB to 512 MB.

 **Quick Reference**

Other Storage Devices Include:

- Tape drives
- LS-120 Super drives
- Flash cards
- USB flash drives

Lesson 2-22: Formatting a Disk

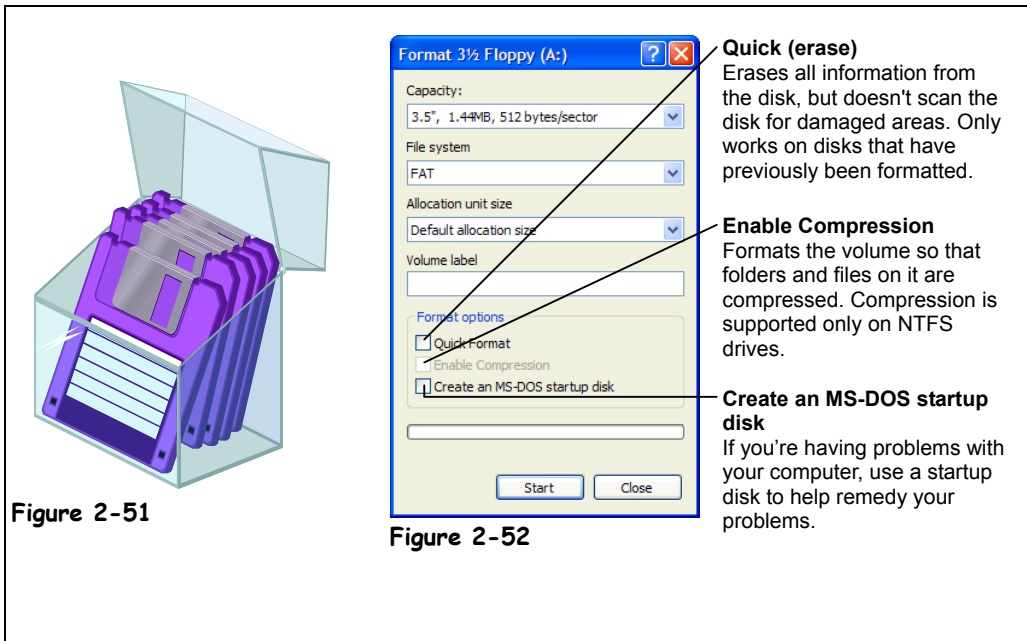

Figure 2-51

Figure 2-52

Figure 2-51

Most floppy disks and hard drives come pre-formatted

Figure 2-52

Formatting a floppy disk in Microsoft Windows XP.

Floppy disks must be formatted before you can use them. Fortunately, today most floppy disks you can buy come pre-formatted, so you don't have to do it yourself. When you *format* a disk, you erase *everything* on it and prepare it so that it can be read and used by the computer's operating system. Actually, you can format most storage devices, such as a hard disks and Zip disks, only you'll want to be extra careful about formatting these devices, as there's a lot more information that will be erased when you format them.

It's easy to format a floppy disk. Here's the procedure for formatting a floppy disk in Windows XP...

1. Click the **Start button and select **My Computer**.**

The My Computer window will display your computer's various storage devices.

2. Right-click the drive containing the floppy disk you want to format (usually A:), and select **Format from the shortcut menu.**

The Format dialog box appears. There are several options you can specify when formatting a floppy disk—see Figure 2-52 to see what they are.

3. Click **Start.**

The floppy drive will whirl as it formats the floppy disk. Formatting a floppy disk usually takes about a minute, formatting a hard disk takes a long time—over an hour if you have a slow computer and large hard disk.

Quick Reference

Formatting a Disk:

- Prepares it for use, so that it can be read and used by the computer's operating system.
- Formatting a disk erases *everything* on it.

Chapter Two Review

Lesson Summary

Central Processing Unit (CPU)

- The CPU, or Central Processing Unit, is the computer's main chip. It calculates and processes information.
- CPU speed is measured in megahertz (MHz) and gigahertz (GHz).
- Common CPUs include: Intel Pentium III, Intel Pentium 4, Intel Celeron, AMD Athlon, AMD Duron.

Memory

- Computers use the binary system, where *on* is represented by a one (1) and *off* is represented by a zero (0).
- A **Bit** is the smallest memory unit. Bit stands for *binary digit*.
- Eight bits make one **Byte**. A byte equals one character (letter, number, or symbol).
- 1,024 bytes make one **Kilobyte** (K or KB) which is equivalent to a one-page, double-spaced letter.
- 1,048,576 bytes make one **Megabyte** (M or MB) which is equivalent to a novel.
- 1,073,741,824 bytes make one **Gigabyte** (G or GB) which is equivalent to an encyclopedia set.
- 1,099, 511,627,776 bytes make one **Terabyte** (T or TB) which is equivalent to a small bookstore.

RAM and ROM

- **RAM:** Stands for Random Access Memory. This is the computer's main memory, which is used to process information. You can read from and write to RAM. RAM is volatile, and any data disappears when you shut off the computer.
- **ROM:** Stands for Read Only Memory. This is the computer's low-level memory, which is used to perform its most basic functions. You can read from ROM but you can't write to it.

Mouse

- A mouse acts as a handheld pointing device and controls the actions of that blinking item on your computer screen known as a *cursor*.

Keyboard

- A keyboard lets you enter information and commands into a computer.

Digital Cameras and Web Cams

- A **digital camera** lets you take pictures and transfer them to a computer.
- The quality, or resolution of the pictures a digital camera can take is measured in **megapixels**, or millions of pixels (dots). The more pixels, the crisper the image will appear when it is printed.

Other Input Devices

- Other input devices include touch pads, AccuPoint® pointing devices, track balls, light pens, scanners, joysticks, and microphones.

Monitors

- A **CRT Monitor** is an older type of monitor that looks like a television screen.
- A **Flat Panel LCD Monitor** is a newer type of monitor that is thin, lightweight and somewhat expensive.
- The **size** of a monitor is measured diagonally across the screen. Average monitor sizes range from 15-inches to 21-inches.
- The monitor **refresh rate** determines how quickly the monitor redraws, or updates, the image on the screen. Most monitors have a refresh rate of 72MHz or better.
- A **screen saver** is a moving picture that appears on your computer screen when you don't use your computer for a while.

Graphics Cards

- **Screen Resolution** determines how much information can fit on the computer screen at once. Common screen resolutions include 800 by 600 and 1,024 by 768.
- **Color Depth** is the number of colors that are displayed on the screen at once. Common color depths include 16-bit and 24-bit color.
- **Video Cards** have their own memory and processor. Generally speaking, the more memory a video card has the higher the resolution and color depth it can display.

Printer Basics

- **InkJet** and **Laser** printers are the most common printer types.
- **Printer resolution** determines the quality of the images a printer can produce. Printer resolution is measured in dots per inch (dpi).
- A printer's speed determines how quickly it can print pages.
- Printers get their ink from expensive cartridges (InkJet printers) and toners (laser printers).
- Many printers have their own memory, which is required for printing more complex images.
- A **print spooler** or **buffer** temporarily stores large print jobs and releases them when the printer is able to actually print them.

Types of Printers

- Print types include InkJet, laser and color laser, multifunction, dot matrix, and plotters.

Sound and Speakers

- A **sound card** lets a computer digitally play and record sounds.

Modems

- A **standard modem** transmits information over standard phone lines to other computers and has a maximum speed of 56K bps.
- A **broadband or digital modem** is much faster than a standard modem, with speeds up to 6,000 Kbps. Broadband modems include ISDN, DSL, and Cable.

Input/Output Devices

- Some computer devices have both input and output functions. Examples include touch screen monitors and multifunction printers.

Hard Drive

- A hard drive is a computer's main storage device, usually labeled C.
- Modern hard drives can store anywhere from 20GB to 250GB of information.
- **Average access time** is how fast a hard drive can find information.
- Hard drives are connected to a computer through either an **IDE** or **SCSI** interface.

Hard Drive Maintenance

- **Hard Drive Repair and Fragmentation:** Over time, small errors and fragmentation can degrade the performance of a hard drive. These problems can be corrected by a hard drive utility program.
- **Hard Drive Backups:** Should be performed to give you an extra copy of your files if your hard drive becomes damaged.
- **Virus Protection:** Software should be installed on every computer to protect against malicious computer viruses.
- **Compression:** Increases the space on a hard drive by compressing, or squeezing together, its files.

CD-ROM Drive

- **CD-ROM:** Stands for Compact Disc-Read Only Memory. A CD-ROM drive lets you install programs, run CD-ROM based programs, and play audio CDs. A CD-ROM holds about 650MB of information.
- **CD-R:** Stands for Compact Disc-Recordable. Lets you permanently write or burn information.
- **CD-RW:** Stands for Compact Disc-ReWritable. Can be written to and modified many times.

DVD Drive

- **DVD:** Stands for Digital Versatile Disc. A DVD disc looks like a CD-ROM, but can store much more information.
- **Recordable and ReWritable DVDs:** There are several competing, non-compatible formats out there, including DVD-R /DVD-RW and DVD+R/ DVD+RW.

Floppy Drive

- **Floppy disks** are slow and can only store 1.44MB. They are all but obsolete.

Zip and Jaz Drives

- **Zip** and **Jaz** drives are removable storage devices that have features of both floppy and hard disks.

Other Storage Devices

- Other storage devices include tape drives, LS-120 Super drives, flash cards, and USB flash drives.

Formatting a Disk

- Formatting a disk prepares it for use, so that it can be read by the computer's operating system. Formatting a disk erases *everything* on it.

Quiz

1. The speed of a CPU is measured in what?

- A. Megahertz (MHz) and gigahertz (GHz)
- B. Horsepower
- C. Bits per second (Bps)
- D. Lux

2. How much information can be stored in a kilobyte?

- A. As much as a one page letter.
- B. As much as a novel.
- C. As much as an encyclopedia set.
- D. As much as a bookstore.

3. Generally speaking, which of the following storage devices can hold the most information?

- A. A hard disk
- B. A Zip disk
- C. A CD-ROM
- D. A DVD

4. What is another name for a computer's main volatile memory?

- A. RAM
- B. ROM
- C. RUM
- D. Flash

5. You can read and write to a computer's ROM. (True or False?)

6. Which of the following modems is the slowest?
 - A. ISDN
 - B. DSL
 - C. Cable
 - D. Standard

7. Which of the following can you read and write to many times?
 - A. CD-ROM
 - B. CD-R
 - C. CD-RW
 - D. DVD-ROM

Quiz Answers

1. A. The speed of the CPU, or Central Processing Unit, is measured in megahertz (MHz) and gigahertz (GHz).
2. A. A kilobyte holds 1,024 characters; about as much information as a single page letter.
3. A. A hard disk will generally have more storage capacity than a Zip disk, CD-ROM, or even DVD.
4. A. RAM or Random Access Memory.
5. False. A computer can read from ROM but not write to it.
6. D. A standard modem is much slower than the other digital modems.
7. C. You can read and write to a CD-RW, or CD ReWritable disc many times.

Chapter Three: Understanding Software

Chapter Objectives:

- Learn about operating systems
- Learn about application software
- Learn about word processors, spreadsheets, databases, and more
- Learn about programming

Prerequisites

- A desire to learn about computers.

This chapter is all about software. *Software* is a computer program that tells computer hardware how to operate. Software is even more diverse than hardware—there are thousands and thousands of software programs out there. Software ranges from the Windows XP operating system that manages your computer, to the word processor you use to print letters, to the Web browser you use to peruse the Internet.

This chapter will give you an incredibly broad overview of the various types of software out there. We'll explain what an operating system does and provide a quick history of various operating systems. Next we'll take a quick tour of the most popular types of programs out there, from word processors to databases. Finally we'll take a glance at some of the more common *programming languages* that are used to write software.

Lesson 3-1: Understanding Graphical User Interfaces

Figure 3-53

The procedure for deleting a file in a text-based operating system.

Figure 3-54

The procedure for deleting a file in a GUI-based operating system. Which is easier?

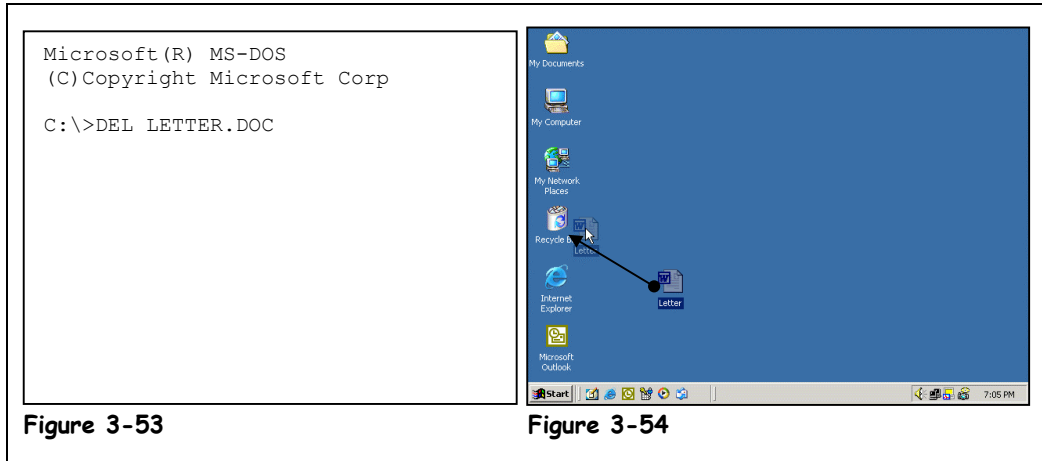

Figure 3-53

Figure 3-54



Graphical user interfaces (GUIs) allow computer users to point and click.

Originally, the information on a computer screen was strictly text, and that text was manipulated using a keyboard. Then computers started using graphical images on the screen to represent a program or file. Those images are called *icons*. Along with the introduction of icons came the development of *graphical user interfaces (GUIs)*. GUIs allow computer users to point at pictures and icons and then click the icon to manipulate that program or file, thus the phrase *point and click*. Obviously, the mouse is a manifestation of this point-and-click mentality because the mouse controls the onscreen cursor.

Figure 3-53 and Figure 3-54 make a good illustration of how much easier a GUI makes it to do things, like delete a file. The following table describes some of the most common icons you'll see in the Windows XP GUI.

Table 3-1: Things You'll See in the Windows XP GUI

Object	Object
You use the arrow or pointer to point and click at things.	The Recycle Bin stores your deleted files.
Click the Start button to access the programs on a computer.	Click the Close button to close the current window or program.
Double-click My Computer to access the drives and files on a computer.	Click the Minimize button to temporarily hide a window or program.
Double-click the Hard Drive to access the hard drive's folders and files.	Click the Maximize button to expand a window or program to fill the entire screen.
Double-click the CD-ROM Drive to play or run the contents of the CD-ROM.	A thumbnail displays a tiny preview of a digital picture or photograph.
Folders hold files and subfolders, just like a filing cabinet.	

Quick Reference

- A **Graphical User Interface**, or **GUI**, makes computers easier to operate by using pictures and icons to represent files and programs.

Lesson 3-2: Types of Software

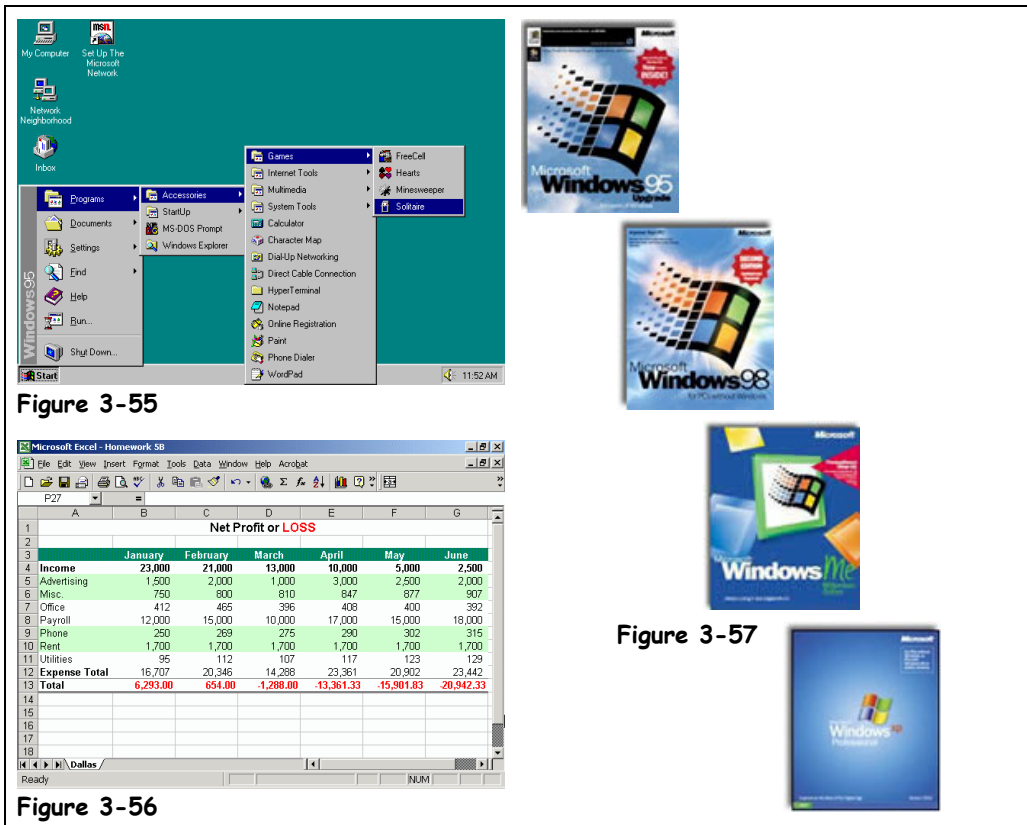

Figure 3-55

Microsoft Windows is an operating system.

Figure 3-56

Microsoft Excel is an application program.

Figure 3-57

Not again! Software manufacturers release new versions of their software regularly to add features, fix bugs, and line their pockets.

Before we delve into the world of software we need to ask and address a few basic questions:

- **What is an operating system?**

An operating system is a software program that loads automatically and controls just about everything on your computer. There are a number of operating systems out there, including MS-DOS and Microsoft Windows XP.

- **What is an application program?**

An application program helps you accomplish a certain task, such as writing a letter, browsing the Internet, or playing a game. Examples include word-processing programs, spreadsheets, databases, and games.

- **Why are new versions of software released year after year?**

Software manufacturers will tell you need a new version of their program because it has new features and fewer bugs. Other people will tell you it's so the software manufacturers can continue to make money year after year. Each software release is given a new name or number, such as Windows 95, Windows 98, to help distinguish the software from older versions.

Got it? Great! Let's continue our tour into the world of computer software.

Quick Reference

An Operating System:

- Loads automatically and controls just about everything on your computer.

An Application Program:

- Helps you accomplish a certain task, such as writing a letter, browsing the Internet, or playing a game.

New Software Versions and Releases:

- Come out periodically that add new features to a program...and make its manufacturers more money.

Lesson 3-3: Operating Systems

Figure 3-58

MS-DOS is a text-based operating system from the Stone Age.

Figure 3-59

Introducing... the Start menu! Microsoft Windows 95 was a very popular operating system that features long file names, better performance, and a easy-to-use interface.

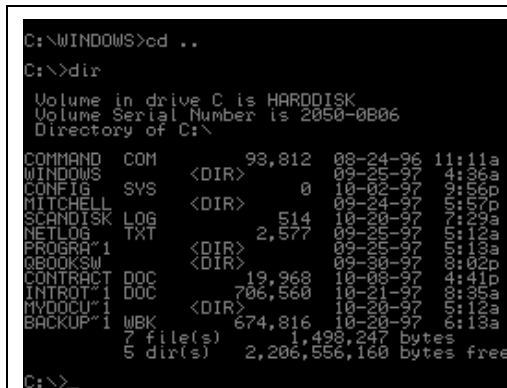

Figure 3-58

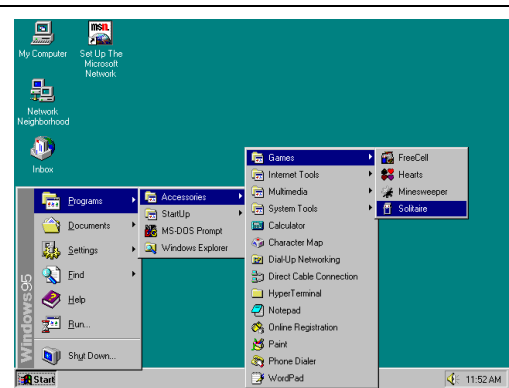

Figure 3-59

An operating system is a software program that loads automatically and controls just about everything on your computer. Here's what an operating system does:

- Controls Your Computer's Hardware**
 Windows controls the different devices of your computer system. It's what makes your printer print, what makes graphics and text appear on your monitor, and what makes your mouse point and click.
- Runs Your Computer's Programs**
 An operating system is what runs all your programs. Without an operating system, your word processor, Web browser (Internet), and games wouldn't work. An operating system lets your programs talk to your hardware, so, for example, your word processor can print things to the printer.
- Organizes Files**
 An operating system stores information in files and folders on your computer's local disk, just like you store files and folders in a filing cabinet.

An operating system is like an orchestra conductor who makes sure all the parts of your computer—your hardware and programs—work together. Operating systems have been around for a long time—here's a brief history of the various operating systems out there:

Table 3-2: Types of Operating Systems

Operating System	Released	Description
MS-DOS	1980	MS-DOS stands for Microsoft Disk Operating System. MS-DOS was one of the earliest PC operating systems that displayed boring lines of text on the screen instead of icons and pictures. You performed tasks in MS-DOS by typing text commands. MS-DOS file names could only be eight characters long.
Windows 3.1	1992	Windows 3.1 was the first <i>successful</i> operating system for the PC that featured a GUI (Graphical User Interface) that used easy to use pictures instead of hard-to-remember MS-DOS commands. Technically speaking, Windows 3.1 was not a true operating system, since it still required MS-DOS to operate.

C:\>

A command prompt is where you type commands in MS-DOS.

Operating System	Released	Description
Windows 95	1995	The incredibly successful successor to Windows 3.1, Windows 95 was a true operating system (no more MS-DOS). It featured long file names, better performance, and a greatly improved interface.
Windows 98	1998	Very similar with Windows 95, Windows 98 included several new and improved features. More importantly, Windows 98 came with support for many of the new hardware devices out there.
Windows ME	2000	Windows ME was the successor to Windows 98. ME stands for <i>Millennium Edition</i> or <i>Mistake Eternal</i> , depending on who you talk to. Windows ME was very similar to Windows 95 and 98 but it included new multimedia features, new utilities and lots of new bugs.
Windows NT	1993	Windows NT (stands for <i>New Technology</i>) was a powerful 32-bit operating system that was faster, more secure, and much more stable than Windows 95 or 98. Windows NT was designed for use in large companies where stability and security were especially important.
Windows 2000	2000	Windows 2000 was the successor to Windows NT. Windows 2000 includes the best features of Windows 98 (easy Plug and Play hardware installation) and Windows NT (security and stability). Windows 2000 is still widely used in many businesses.
Windows XP Home	2001	Windows XP (stands for eXPerience—huh?) Home is designed for home and consumer computing and is the successor to Windows ME. Windows XP has the same technology found in Windows NT and 2000, so it's much more stable than earlier versions of Windows.
Windows XP Professional	2001	Windows XP Professional is the business edition of Windows and is the successor to Windows NT and Windows 2000.
Windows CE / Pocket PC	Varies	Windows CE (stands for Consumer Electronics) is the operating system made by Microsoft used to power handheld computers or PDAs (Personal Data Assistants).
Palm OS®	Varies	The Palm OS is another operating system that can be found on handheld computers or PDAs.
UNIX	Varies	UNIX is an older, very powerful operating system that can run on a computer, mainframe, or network. UNIX features great performance, security, and reliability.
Linux	Varies	Linux is a newer UNIX-base operating system that is available for FREE on the Internet. Linux is becoming a popular alternative to Microsoft Windows.
Mac OS X	2001	Mac OS X is the latest operating system for Macintosh computers.

 **Quick Reference**
An Operating System...

- Loads automatically and controls just about everything on your computer.

Lesson 3-4: Word Processing

Figure 3-60

A word processor lets you write letters, resumes, and much, much more.

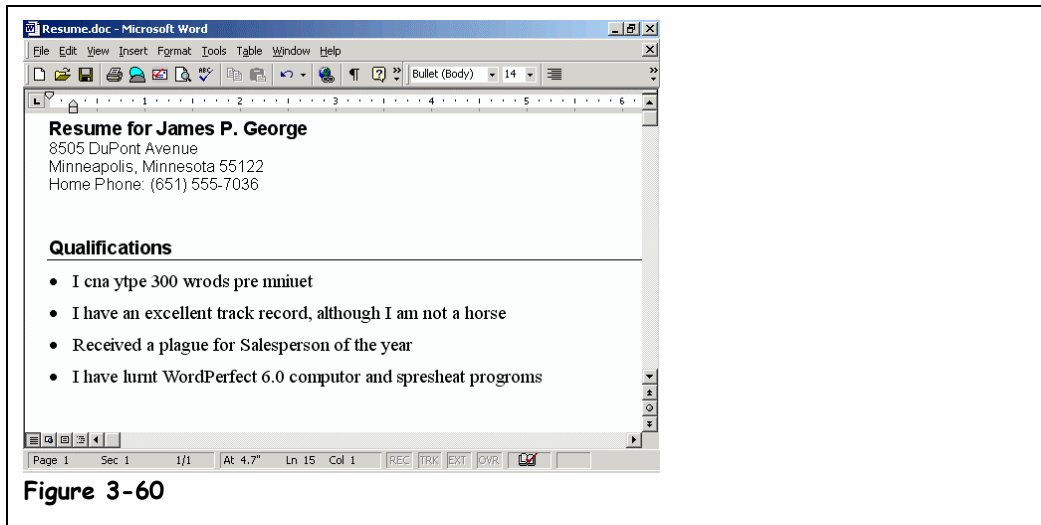

Figure 3-60



Microsoft Word is the world's most popular word processing software program.

Quick Reference

- A **word processor** is a program that lets you create letters and documents.

Perhaps the most widely used and recognized computer application, word processing software lets you create letters, reports, and many other documents on a computer.

- **Create Letters and Documents**

Whether it's a 500 page steamy romance novel or a quick thank-you note to your neighbor, a word processor makes writing things easier. Best of all, a word processor lets you change, or *edit*, the text in a document before it appears on paper. You can easily add, delete, or rearrange the text in a word processing document. Most word processors also allow you to check your documents for spelling and grammar errors.

- **Format Text**

Most word processors can make the text in your documents look pretty—even if you're a terrible writer. For example, you can use various fonts, or typefaces, create bulleted or numbered lists, and change the alignment of text on the page.

- **Create Tables**

Tables are great: they are ranked right up there with the spell checker as one of the neatest word processing features. A table neatly arranges text and data in a grid, organized by columns and rows.

- **Add Images**

Most word processors let you insert pictures and images to create all kinds of neat documents: newsletters, greeting cards, pamphlets, and more.

- **Perform Mail Merges**

Mail merge letters are used to send the same or similar documents to many different people at once. Since they contain the recipient's name, address, and other information, mail merge letters feel more personal—just like a typical sweepstake letter: *If you have the winning number, **Bob Boyarksi**, You are the winner of \$10 Million Dollars!*

Lesson 3-5: Spreadsheets

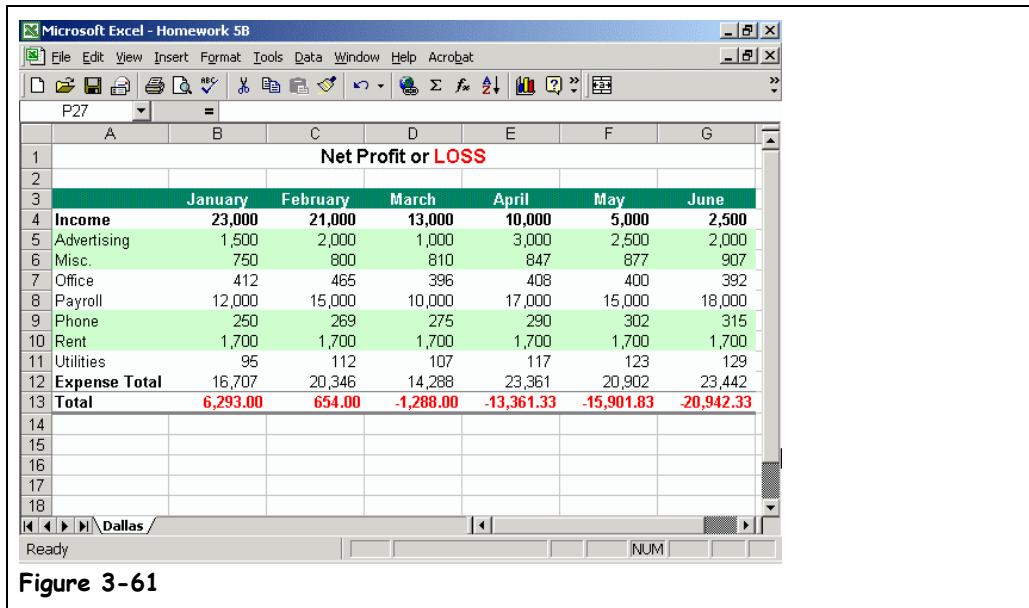

Figure 3-61

A spreadsheet program is useful for calculating and presenting information—even if it's not what you want to see...

Spreadsheet programs are super-powered calculators. Have you ever found yourself using a calculator to add together more than 5 or 6 numbers? If so, you probably could be using a spreadsheet program to make working with numbers faster, easier, and more accurate. You can also analyze data and make it into charts with a spreadsheet.

- **Perform Calculations**

A spreadsheet can add various cells, perform powerful formulas, and calculate and analyze information. The entire spreadsheet is updated and recalculated every time you change a value. That way you can change one number to see how it affects everything else.

- **Manage and Organize Information**

Spreadsheets neatly arrange values in a grid, organized by columns and rows. You can use a spreadsheet to present information in a professional and easy-to-read format. You can also use a spreadsheet to store large collections of data, such as mailing and product lists.

- **Format and Present Information**

You can enhance the appearance of all those numbers by using various fonts, or typefaces, borders, shading, and more.

- **Create Charts**

Like the saying “a picture is worth a thousand words,” charts are often better at presenting information than hard-to-read numbers in a spreadsheet. A chart illustrates data, relationships, or trends graphically.



Microsoft Excel is the world's most popular spreadsheet software program.

Quick Reference

- A **spreadsheet** is a program that organizes, calculates, and presents numbers.

Lesson 3-6: Databases

Figure 3-62

A database stores and manages information related to a particular subject or purpose.

Employee ID	Last Name	First Name	Title	Birth Date	Hire Date
1	Davolio	Nancy	Sales Representative	08-Dec-1968	01-May-1992 507
2	Fuller	Andrew	Vice President, Sales	19-Feb-1952	14-Aug-1992 908
3	Leverling	Janet	Sales Representative	30-Aug-1963	01-Apr-1992 722
4	Peacock	Margaret	Sales Representative	19-Sep-1958	03-May-1993 4110
5	Buchanan	Steven	Sales Manager	04-Mar-1955	17-Oct-1993 14 G
6	Suyama	Michael	Sales Representative	02-Jul-1963	17-Oct-1993 Cove
7	King	Robert	Sales Representative	29-May-1960	02-Jan-1994 Edgr
8	Callahan	Laura	Inside Sales Coordinator	09-Jan-1958	05-Mar-1994 472E
9	Dodsworth	Anne	Sales Representative	02-Jul-1969	15-Nov-1994 7 Hc

Field Names

A name that identifies the information in a field.

Field

A specific type of information, such as the last names of your employees.

Record

A collection of information about one person or thing, such as the name and address of one employee.

Figure 3-61



Microsoft Access is the world's most popular database software program.

In its simplest form, a *database* is a collection of information that is organized into a list. Whenever you make a list of information, such as names, addresses, products, or invoices, you are, in fact, creating a database. Technically speaking, you don't even have to use a database program to create a database.

A database program, however, is much more powerful than a simple list you keep on paper. A database program lets you:

- **Store Information**

A database stores lists of information that are related to a particular subject or purpose. A database stores personal information, such as a list of aunt Mildred's home recipes, or business information, such as a list of hundreds of thousands of customers. A database also makes it easy to add, update, organize, and delete information.

- **Find Information**

You can easily and instantly locate information stored in a database. For example, you can find all the customers with the last name "Johnson" or all the customers who live in the 55417 Zip code and are older than 65.

- **Analyze and Print Information**

You can perform calculations on information in a database. For example, you could calculate what percentage of your total sales comes from the state of Texas. You can also present information in a professional-looking printed report.

- **Manage Information**





Databases make it easy to work with and manage huge amounts of information. For example, with a few keystrokes you can change the area code for hundreds of customers in the (612) area code to a new (817) area code.

- **Share Information**

Most database programs allow more than one user to view and work with the same information at once. Such databases are called *multi-user databases*.

Databases usually consist of several parts. The table on this page identifies the main components of a database.

Table 3-3: Database Objects

<i>Object</i>	<i>Description</i>
 Tables	Tables store a database's data in rows (records) and columns (fields). For example, one table could store a list of customers and their addresses while another table could store the customers' orders. A database must always contain at least one table where it can store information—all the other database objects are optional.
 Queries	Queries ask a question about data stored in a table. For example, a query might ask Access to display only customers who are from Texas.
 Forms	Forms are custom screens that provide an easy way to enter and view data in a table or query.
 Reports	Reports present data from a table or query in a printed format.
 Codes	Programming codes help you perform routine tasks by automating them into a single command.

 **Quick Reference**

- A **database** program stores, manages, and organizes lists of information.

Lesson 3-7: Presentation Software

Figure 3-63

Even if your presentation stinks, a presentation program can at least make it look pretty.



Microsoft PowerPoint is the world's most popular presentation software program.

Quick Reference

- A **presentation software program** is used to create professional, convincing presentations, or slide shows.



Figure 3-63

A presentation program turns your ideas into professional, convincing presentations, or slide shows. If you've ever used an overhead projector, flip chart, or even a black board, you'll love presentation software. A presentation program lets you create slides that include text, graphics, charts, and even digital movies. Once you have created a presentation, you can display it as an electronic slide show on any computer.

- **Create Professional Presentations**

There really wasn't much to the movie *Star Wars I: Attack of the Clones*, but it sure looked impressive. Presentation software can do the same thing for presentations, making even the duller speech look more professional.

- **Add Drawings, Charts, and Illustrations**

Presentations with pictures, graphics, and visuals are much more compelling and effective at conveying messages than ones that contain only boring text. A presentation software application like Microsoft PowerPoint makes it easy to add pictures and drawings to your slides, making them look as though you hired a professional graphic design company to create them.

- **Outline What You Want to Say**

If you think way back to your high school speech class, you might remember that you learned to organize a presentation by writing down its major points in an outline (if only some public speakers could remember this). Most presentation software has built-in outlining tools to help you organize your presentation. Just remember to stick to that outline during your presentation!

Lesson 3-8: Accounting

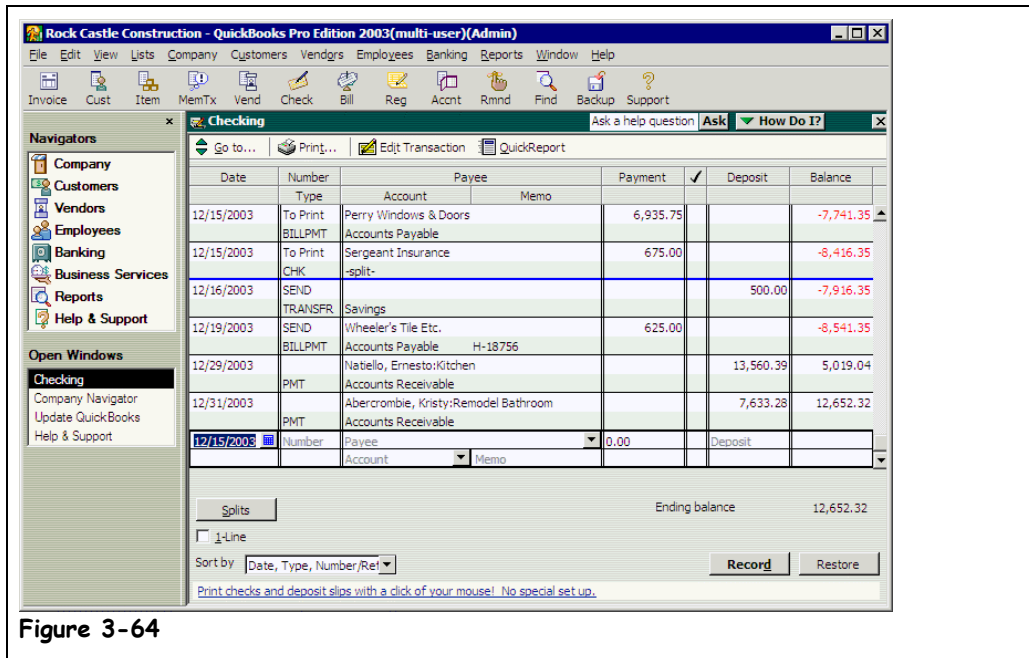
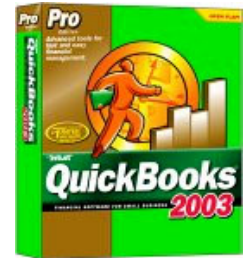

Figure 3-64

Figure 3-64

Accounting software, like Intuit's Quicken or QuickBooks (shown below) can help you pay bills, balance your bank account, and even perform payroll.



QuickBooks is a very popular accounting software program for small businesses.

Personal finance and accounting software keep track of your personal or business finances. A personal finance program can show you what your current checking, savings, or credit card balances are, where you're spending your money, and will even help you reconcile your account when you get a bank statement. Business accounting programs go a step further—they will create invoices, keep track of your receivables and payables, and even do payroll. Once you use a personal financing program for your home finances or an accounting program for your business, you'll never know how you ever got along without one.

- Balance Your Checkbook and Manage Finances**
 Accounting software automatically keeps a running balance of your bank accounts—if you remember to enter your checks and deposits. If you don't, many account programs can download your banking statements.
- Write Checks and Pay Bills**
 You can purchase special checks that you print out on your computer's printer to save time and present a more professional image.
- Create Invoices**
 If you run a business, an account program can print invoices and keep track of who owes you money.
- Perform Payroll**
 Many accounting programs have a payroll module, which deducts, and tracks Social Security, Medicare, and state and federal employee taxes.
- Bank Online**
 Online banking lets you view your current checking and savings balances, pay bills, and even accept online credit card payments.

Quick Reference

- Accounting software helps manage personal and/or business finances and balance accounts.

Lesson 3-9: Web Browsing

Figure 3-65

A Web browser lets you view Web pages on the Internet.



Figure 3-65

Web addresses and pages are everywhere—on television advertisements, in magazine and newspaper articles, and even on business cards. Together, these Web pages make up what is known as the *World Wide Web* (WWW) or *Web* for short. To view a Web page you'll need a piece of software called a *Web browser*. Luckily you won't need to buy a Web browser, since it comes standard on most computers. In fact, Microsoft has spent a considerable amount of money and time in court determining that Windows is actually a Web browser.

- **Browse and View Web Pages**

Web pages are written in a simple language called HTML, which stands for *Hypertext Markup Language*. A Web browser converts the HTML in a Web page into a readable format and displays that information on your computer screen.

- **Find Information**

You can use a *search engine* to find just about anything on the World Wide Web. A search engine catalogs the billions of Web pages on the Internet so that you can find information on the topics that interest you. Google and Yahoo are two of the most popular search engines out there.

- **Download Files**

The Internet is filled with files and programs that you can *download*, or save to your computer. You can download images and pictures, programs, even MP3 files that you can listen to.

- **Shop**

You can spend lots of money on the World Wide Web. Anything that you can buy in a store you can probably buy on the Internet. People use the Internet to shop for books, computers, clothes, and even cars.

Quick Reference

- A **Web browser** allows users to view Web pages on the Internet.

Lesson 3-10: Web Authoring

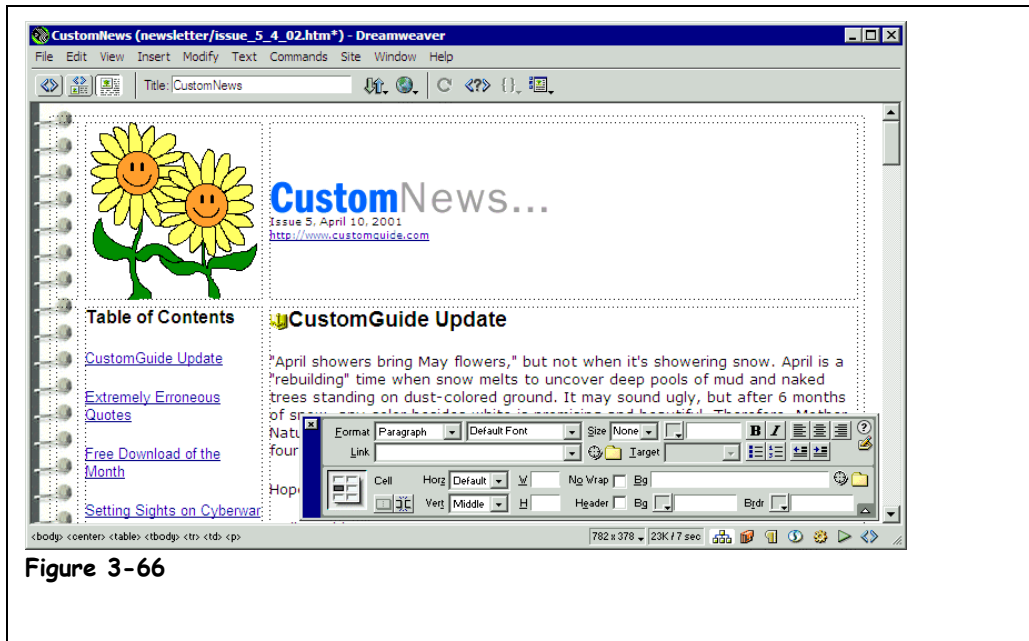

Figure 3-66

Figure 3-66

Web Authoring software can help you create spectacular Web pages, like the newsletter shown here.

A few years ago, only the brainy computer types knew how to write their own Web pages. Today *Web authoring programs* make it easy for even a novice to get their own Web site up on the Internet for the whole world to see.

- **Create Web Pages**

All those pretty Web pages you visit on the Internet are written in a simple language called HTML (stands for HyperText Markup Language). It's actually *possible* to create a Web page by writing it directly in HTML using a simple text editor or word processor, but most people use Web Authoring software because it's so powerful and easy to use.

- **Insert Images**

Web Authoring software makes it easy to add pictures and graphics to a Web page, whether it's a professional logo for a corporate Web site or a fake photograph for an online dating service.

- **Add Hyperlinks**

You can easily add *hyperlinks* to a Web page that point to other sites of interest on the Internet.

- **Publish Your Web Pages to the Internet**

A Web site isn't any good if people can't see it. Most Web Authoring programs have tools to help you *upload*, or save your Web pages on to the Internet.



Macromedia Dreamweaver is a very popular Web authoring software program.

Quick Reference

- A **Web Authoring program** lets users create Web pages in HTML that they can then publish to the Internet.

Lesson 3-11: Programming Languages

Figure 3-67

Microsoft Visual Basic lets users create programs using a graphical programming environment and painting metaphor.

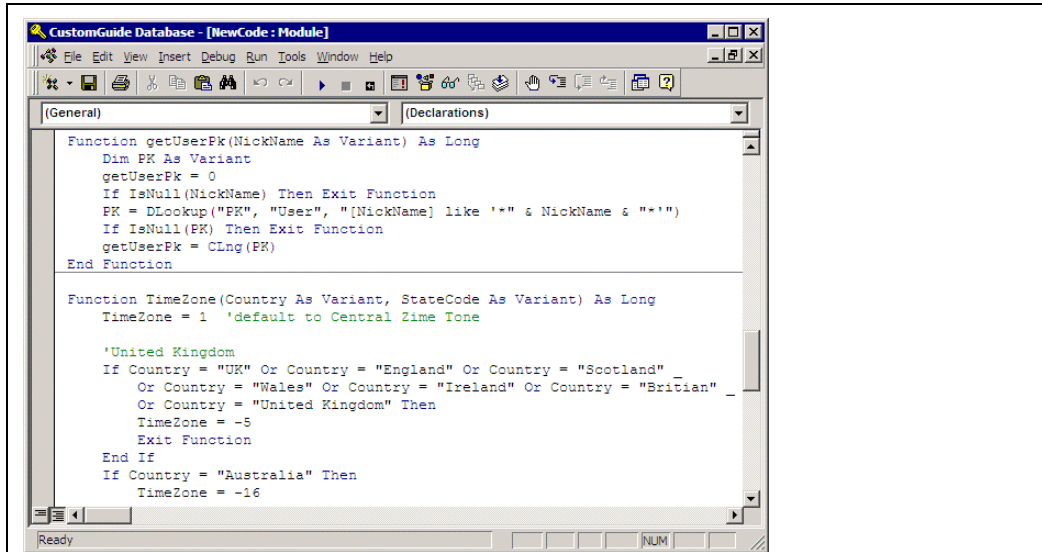

Figure 3-67

All software programs, from Microsoft Windows XP to Word 2000 are written in a *programming language*. A programming language is a vocabulary and set of grammatical rules for instructing a computer to perform specific tasks.

Computers can only understand special machine languages, which consist almost entirely of numbers. Humans, however, can't understand these huge series of numbers, so they use high-level programming languages, such as C++ and Java to write software programs and then translate or *compile* them into machine language.

Every language has its strengths and weaknesses. For example, FORTRAN is a good language for processing numbers, but it's not well suited to for large programs. C++ has powerful object-oriented features, but it is complex and difficult to learn. There are literally hundreds, if not thousands, of programming languages out there. The following table briefly describes some of the more common programming languages you might overhear computer nerds discussing.

Table 3-4: Common Programming Languages

Language	Description
Machine Language	The lowest-level programming language, machine languages can be read by computers, but are almost impossible for humans to use because they consist entirely of numbers.
Assembly Language	Assembly languages have the same structure and set of commands as machine languages, but they enable a programmer to use names instead of numbers when writing code.

Language		Description	
SQL		SQL, or Structured Query Language, is a standardized language for requesting information from a database.	
High-Level	BASIC	Acronym for Beginner's All-purpose Symbolic Instruction Code, BASIC is one of the earliest and simplest high-level programming languages and was taught by educators to students during the 1970s and 80s.	
	C, C++	A high-level programming language developed in the mid-1970s, it is still one of the most popular programming languages in use today. C is similar assembly language and allows programmers to write very efficient code. C++ adds many object-oriented features to its predecessor, C.	
	COBOL	COBOL, or Common Business Oriented Language, was developed back in the late 1950s, and despite its age is still used on many mainframe computers.	
	FORTRAN	Acronym for formula translator, FORTRAN is the oldest high-level programming language. Despite its age, FORTRAN is still popular for scientific applications that require extensive mathematical computations.	
	Object-Oriented	Java	An object-oriented language developed by Sun Microsystems, similar to C++, but simplified to eliminate language features that cause common programming errors. Compiled Java code can run on most computers, including UNIX, Macintosh, and Windows. Small Java applications called <i>applets</i> can be downloaded from the Internet and run on your computer.
		Visual Basic	Based on BASIC, Microsoft Visual Basic allows users to create programs with a graphical programming environment and painting metaphor. Visual Basic, or VB, is sometimes called an event-driven language because each object can react to different events such as a mouse click.
Web Development	ASP, JSP	Active Server Pages and Java Server Pages are programming languages that generate dynamic HTML code and send it back to the browser.	
	HTML	HTML, or HyperText Markup Language, is the authoring language used to create documents, or Web pages on the World Wide Web. HTML defines the structure and layout of a Web document by using tags and attributes.	
	JavaScript	A scripting language that enables Web authors to design interactive sites. Javascript can interact with HTML source code, enabling Web authors to spice up their sites with dynamic content.	
	Perl	Short for Practical Extraction and Report Language, Perl is a programming language designed for processing text.	
	PHP	An open source, server-side, HTML embedded scripting language used to create dynamic Web pages.	
	XML	Short for Extensible Markup Language, XML allows designers to create their own customized tags, enabling the definition, transmission, validation, and interpretation of data between applications and between organizations.	

 **Quick Reference**

- A **programming language** is a vocabulary and set of grammatical rules for instructing a computer to perform specific tasks.

Lesson 3-12: Systems Development

Figure 3-68

Possible steps in developing a computer system.

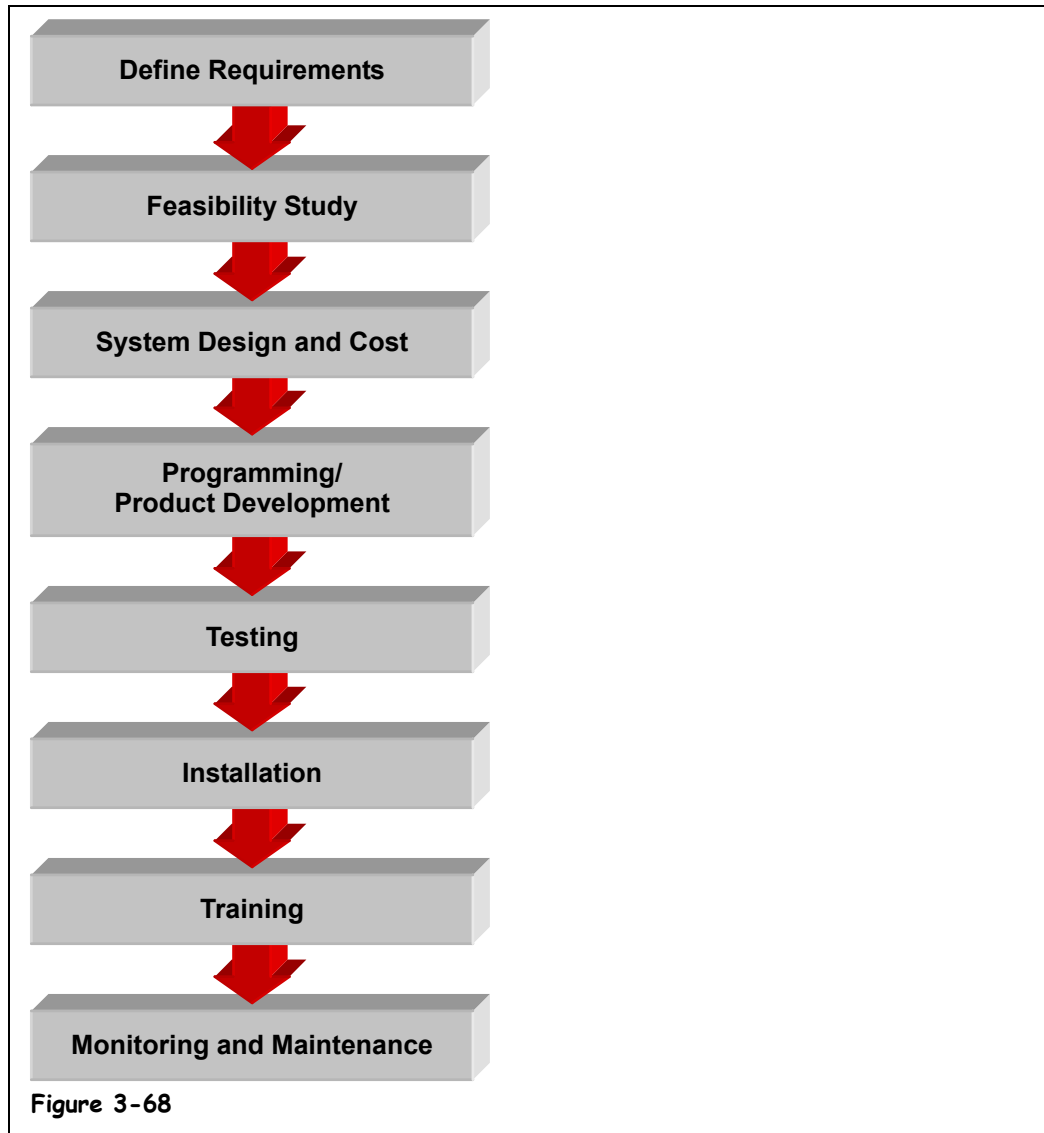

Computer programs and systems don't appear out of thin air; there are a series of procedures that are normally followed. The steps and procedures for system development are very similar, whether it's a small company replacing its employee time clock with a computerized attendance system or a huge software company releasing a new software program.

Table 3-5: Common Stages in System Development

Stage	Description
Define Requirements	Determine the purpose of the system, all inputs, outputs, and control mechanisms.
Feasibility Study	Determine if the system is economically and technically practical.
System Design and Cost	Create an action plan or blueprint for creating the system, and determine how much the system will cost.
Programming/ Product Development	Write the programs necessary for the system using a high-level programming language. Purchase any hardware required by the system.
Testing	Test the completed system using real data to identify and correct any bugs.
Implementation	Install the completed system and put it to use.
Training	Train users on how to use or operate the new system.
Monitoring and Maintenance	Problems usually arise soon after implementation that must be corrected. Computer systems often require upgrades and routine maintenance.

 **Quick Reference**
Common Steps in Systems Development:

1. Define Requirements
2. Feasibility Study
3. System Design and Cost
4. Programming/Product Development
5. Testing
6. Implementation
7. Training
8. Monitoring and Maintenance

Chapter Three Review

Lesson Summary

Understanding Graphical User Interfaces

- A **Graphical User Interface**, or **GUI**, makes computers easier to operate by using pictures and icons to represent files and programs.

Types of Software

- An **operating system** loads automatically and controls just about everything on your computer.
- An **application program** helps you accomplish a certain task, such as writing a letter, browsing the Internet, or playing a game.
- **New software versions and releases** come out periodically that add new features to a program ... and make the software manufacturers rich!

Operating Systems

- An **operating system** loads automatically and controls just about everything on your computer.

Word Processing

- A **word processor** is a program that lets you create letters and documents.

Spreadsheets

- A **spreadsheet** is a program that organizes, calculates, and presents numbers.

Databases

- A **database** program stores, manages, and organizes lists of information.

Presentation Software

- A **presentation software program** is used to create professional, convincing presentations, or slide shows.

Accounting

- **Accounting software** helps manage personal and/or business finances and balance accounts.

Web Browsing

- A **Web browser** allows users to view Web pages on the Internet.

Web Authoring

- A **Web Authoring program** lets users create Web pages in HTML that they can then publish to the Internet.

Programming Languages

- A **programming language** is a vocabulary and set of grammatical rules for instructing a computer to perform specific tasks.

Systems Development

- **Common Steps in Systems Development**
 1. Define Requirements
 2. Feasibility Study
 3. System Design and Cost
 4. Programming/Product Development
 5. Testing
 6. Implementation
 7. Training
 8. Monitoring and Maintenance

Quiz

1. **An operating system is built-in to a computer's ROM-BIOS. (True or False?)**
2. **Which of the following is a text-based operating system?**
 - A. Windows 95
 - B. Windows 2000
 - C. Windows CE
 - D. MS-DOS
3. **Which of the following programs would be best suited for helping you calculate a monthly budget?**
 - A. A word processor
 - B. A spreadsheet
 - C. A database
 - D. COBOL
4. **Which of the following programs would be best suited for storing a list of customers and their orders?**
 - A. A word processor
 - B. A spreadsheet
 - C. A database
 - D. COBOL

Quiz Answers

1. False. An operating system is software that the computer loads when it first starts up.
2. D. MS-DOS is a text-based operating system.
3. B. A spreadsheet would be the program best suited to help you balance your budget.
4. C. A database would be best suited for storing a list of customers and their orders.

Chapter Four: Information Networks

Chapter Objectives:

- Learn about networks
- Learn the difference between a LAN and WAN
- Learn the basics about the Internet
- Learn what Intranets and Extranets are
- Understand telephone networks used to connect to the Internet

This chapter will give you an incredibly brief look into the world of *networking*. A network is several computers, printers, and other devices that are connected together. When you think of a network, you probably think of how your computers are connected at work—and that's definitely one type of network. But did you know that the Internet itself is one vast network? We'll cover these topics and more in this chapter.

Prerequisites

- A desire to learn about computers.
-

Lesson 4-1: Introduction to Networks

Figure 4-1

The parts of a network (see Table 4-1: *Network Components* for a description of everything)

Figure 4-2

In a peer-to-peer network, everyone stores their files on their own computer. Anyone on the network can access files stored on any other computer.

Figure 4-3

In a client/server network, everyone stores his or her files on a central computer called a server. Everyone on the network can access the files stored on the server.

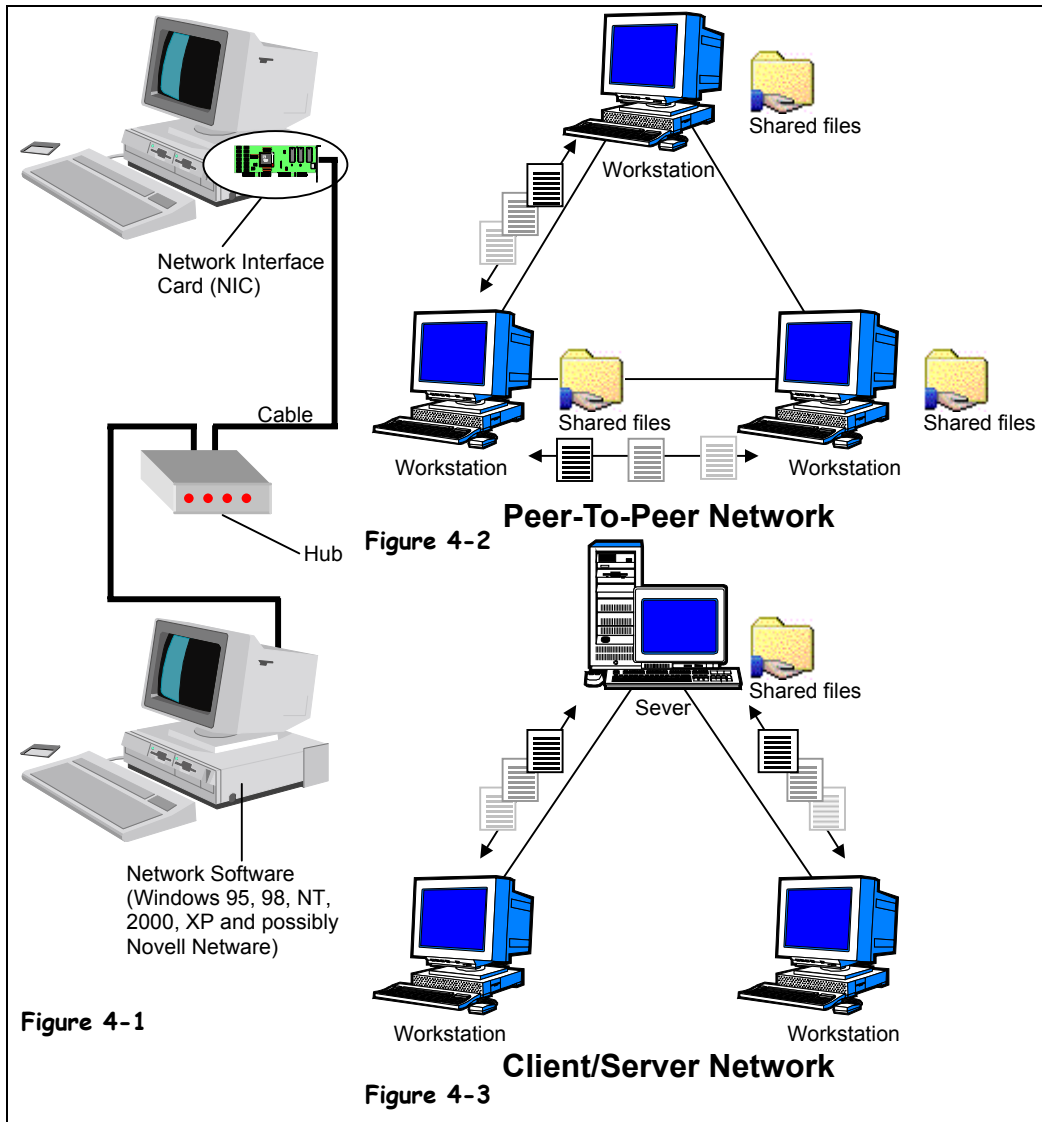

A network is several computers, printers, and other devices that are connected together with cables. This allows the computers to talk with each other and share information and resources (usually files and printers). Networks vary in size; they can be as small as two computers connected to each other by cable, or they can span the entire globe—the Internet is actually the world’s largest network.

So what are the benefits of networking? Plenty:

- **Share Information:** Networks allow you to share files and programs. Before networks, people had to save their files on floppy disks to exchange information. This wasted a lot of time—especially if the computers were located in opposite ends of the building!

- **Share Equipment:** Computers connected to a network can share equipment to reduce costs. For example, rather than buying a printer for each computer, everyone can share one central network printer.
- **Use Network Software:** Software designed for networks lets people send and receive electronic mail (e-mail) with other users on the network, schedule meetings with other users on the network, and share databases. When you're browsing the Web, you're actually using software designed for a network!

There are two basic types of networks:

- **Local Area Networks (LAN):** A network that connects computers in the same geographic area or building, using cables. Local Area Networks are what most people think of when they think of a network—and that's what we'll be discussing throughout the chapter.
- **Wide Area Networks (WAN):** A network that connects computers across a large geographic area. The Internet is actually a huge Wide Area Network.

Local Area Networks (LANs) are subdivided into two types of network subcategories: peer-to-peer and client/server, as shown in Figure 4-2 and Figure 4-3:

- **Peer-to-Peer Network or Workgroup:** In a peer-to-peer network, everyone stores their files on their own computer, and anyone on the network can access files stored on any other computer. Because you don't need any additional software, peer-to-peer networking is an inexpensive way to connect computers in a small office or home. The disadvantages of a peer-to-peer network are that it doesn't offer as much security as client/server networks, and it can be difficult to find files that are stored on many different computers. Both versions of Windows XP—Home and Professional—support peer-to-peer networking.
- **Client/Server Network:** In a client/server network, everyone stores their files on a central computer called a server. Everyone on the network can access the files stored on the server. Client/server networks are more secure, easier to administer, and much more powerful than peer-to-peer networks. That's why they are used to connect computers in most businesses. The disadvantages of client/server networks are that they require special, expensive software, such as Windows XP Server or NetWare, and they are more complicated to install and configure than peer-to-peer networks. Only Windows XP Professional supports client/server networking.

Figure 4-1 shows the basic parts in a network. The following table explains what they are:

Table 4-1: Network Components

Component	Description
Network Interface Card (NIC)	A network interface card is a device that plugs into your computer and physically connects each computer to the network and allows your computer to talk to other computers and devices on the network.
Cables	Cables are the wires that physically connect the computers, printers, and other equipment on a network.
Hub	A hub is a device where all the cables on a network connect, similar to a power strip.
Network Operating Software	Your operating system must provide networking capabilities. Windows XP and Windows XP Professional have peer-to-peer networking capabilities. Windows XP Professional and NetWare have client/server capabilities.

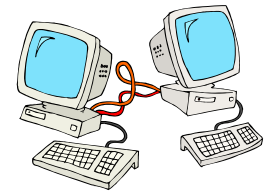

A Local Area Network (LAN) connects computers in the same building or facility.

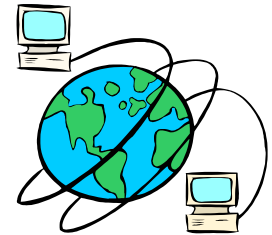

A Wide Area Network (WAN) connects computers over wide geographic areas. The Internet is an example of a WAN.

Quick Reference

LAN:

- Stands for Local Area Network and connects computers in the same geographic area or building, using cables.

WAN:

- Stands for Wide Area Network and connects computers across a large geographic area.

Peer-to-Peer/Workgroup:

- Files and resources are shared on every computer. Easier to setup but very insecure.

Client/Server Network:

- Files are stored on a single central computer, or server. More secure and

Lesson 4-2: The Internet

Figure 4-4

The Internet is the largest network in the world, consisting of millions of computers, all over the world, all connected together.

Figure 4-5

Web pages are stored on Web servers—computers that are permanently connected to the Internet.



Figure 4-4

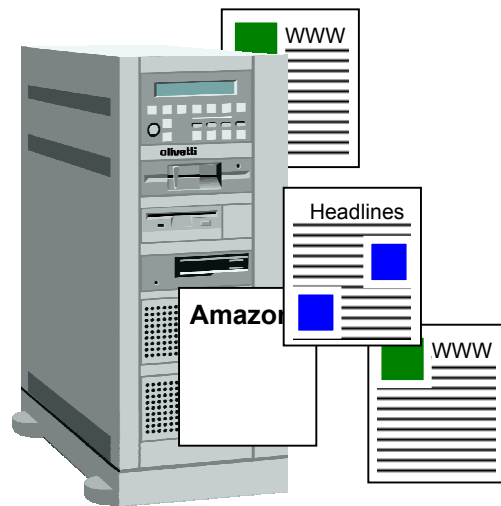

Figure 4-5

The Internet is the largest computer network in the world. It consists of millions of computers all over the planet, all connected to each other.

The Internet was born in the 1960s when the United States military worried that a nuclear bomb could destroy its computer systems (there weren't many of them back then). So it placed several computers far apart from each other and connected them with some super-fast telephone lines so that the computers could talk to each other. If a nuclear bomb blew up one computer, another computer could instantly take over; thus, the computer network wouldn't go down. Years passed and other organizations, such as colleges and universities, started connecting their computers to this growing network to share information.

Although the Internet has been around a long time, it wasn't until the 1990's that someone thought of a wonderful idea called the *World Wide Web*. Many people use the terms Internet and World Wide Web or Web interchangeably, but in fact the terms are two separate but related things. The Internet is a massive network of networks that connects millions of computers to one another. A good analogy would be the cables that provide cable television. The World Wide Web is simply one way to communicate and share information over the Internet. Using our cable television analogy, the World Wide Web would simply be single channel that is broadcast over the cable system.

The World Wide Web consists of millions of documents that are stored on hundreds of thousands of computers that are always connected to the Internet. These documents are called *Web pages*, and you can find Web pages on every subject imaginable—from your local newspaper to online catalogs to airline schedules, and much, much more.

Web pages are stored on *Web servers*. A Web server is a computer, not unlike your own computer, only bigger and faster. There are hundreds of thousands of Web servers located all over the world. Web servers are always connected to the Internet so that people can view their Web pages 24 hours a day.

So what can you do once you're connected to the Internet? Plenty. Table 4-2: *What Can I do on the Internet?* shows just a few of the many things there are to do on the Internet.

Table 4-2: What Can I do on the Internet?

Task	Description
Send and Receive E-mail	Exchanging electronic mail (or e-mail) is the most used and most popular feature on the Internet. Just like regular paper mail, you can send and receive e-mail with people around the world, as long as they have access to a computer and the Internet. Unlike regular paper mail, e-mail is usually delivered to its destination almost instantly.
Browse the World Wide Web	The World Wide Web is what most people think of when they think of the Internet—although it's really only a part of the Internet. The World Wide Web is an enormous collection of interconnected documents stored on Web servers all over the world. The World Wide Web has information on every subject imaginable.
Join online discussions with newsgroups	Newsgroups are discussion groups on the Internet that you can join to read and post messages to and from people with similar interests. There are thousands of newsgroups on topics such as computers, education, romance, hobbies, politics, religion, and more.
Chat with other online users	Chatting lets you communicate with people on the Internet instantly—no matter how far away they are! Most chats are text-based, meaning you have to type when you converse with people on the Internet. A growing number of chats have voice and even video capabilities—all without having to pay long distance charges.
Download software	You can download pictures, demo programs, patches and drivers for your computer, and many other types of files and save them to your computer.
Listen to music and watch videos	You can listen to sound on the Web, such as radio stations, or music by your favorite artists.

 **Quick Reference**
Internet:

- The Internet is the largest computer network in the world, connecting millions of computers.

World Wide Web:

- A way of accessing information over the Internet.

Lesson 4-3: Intranets and Extranets

Figure 4-6

An Intranet is a miniature version of the Internet that works within a company or organization.

Figure 4-7

An Extranet is also like a miniature version of the Internet, but Extranets are accessible to authorized users outside of a company or organization.

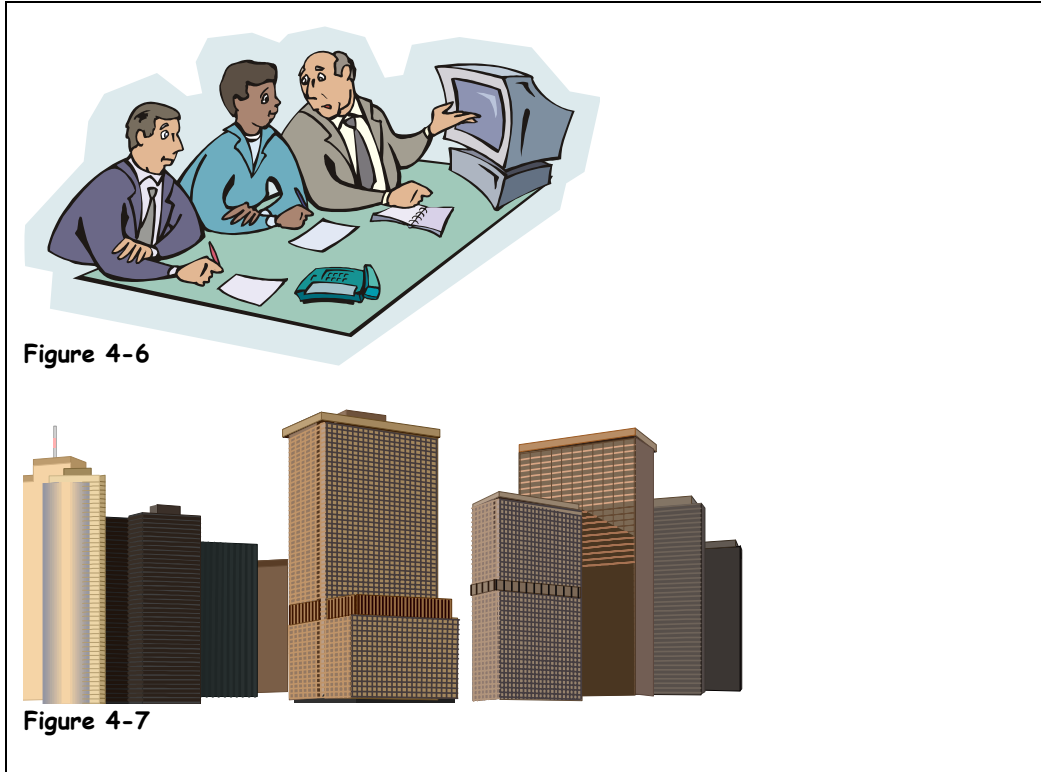

An *Intranet* is a miniature version of the Internet that works within a company or organization. Web sites on an Intranet look and act just like any other Web sites, but can only be viewed by users within the company or organization. A *firewall* surrounds the Intranet and fends off unauthorized access.

An *Extranet* is similar to an Intranet, but while an Intranet is generally only accessible to users within same company or organization, an Extranet is accessible by authorized outside users. Business partners use Extranets to share information.

Like the Internet itself, Intranets and Extranets are used to share information. Secure Intranets are now the fastest-growing segment of the Internet because they are much less expensive to build and manage than private networks based on proprietary protocols.

So what are the advantages of Intranets and Extranets? Both Intranets and Extranets can:

- **Share Information:** Intranets and Extranets offer a very simple and inexpensive way to make internal company documents, such as a phone directory, available to employees.
- **Connect Documents:** Documents on an Intranet or Extranet can be connected by hyperlinks, so users can easily jump from one related document to another.
- **Use Special Software:** Some software can only be used on an Intranet or Extranet, such as Web based e-mail programs.

Quick Reference

Intranet:

- A miniature version of the Internet that works on a network within a company or organization.

Extranet:

- A miniature version of the Internet that allows access to authorized outside users, such as business partners.
-

Lesson 4-4: Telephones and Networks

Figure 4-8

An internal modem plugs into an expansion slot inside a computer.

Figure 4-9

An external modem plugs into a serial port and sits outside a computer.

Figure 4-10

Most laptops have a built-in modem.

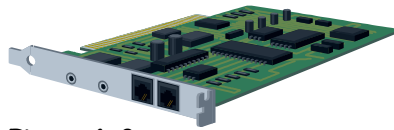

Figure 4-8

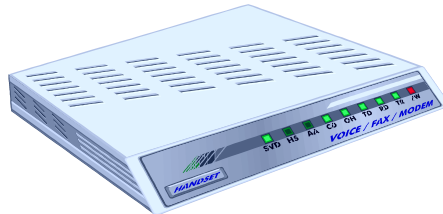

Figure 4-9

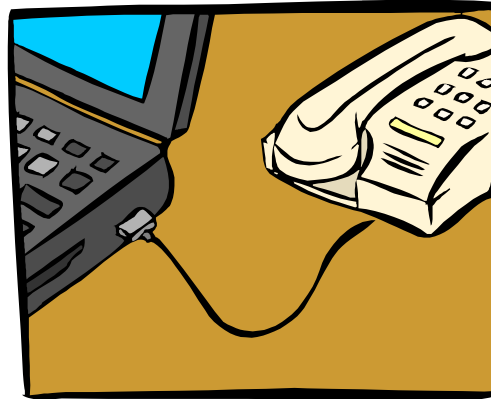

Figure 4-10

A *modem* is a device that translates a computer's ones and zeros into audio tones, so that it can transmit information over the phone lines to other modems. The speed in which a modem can transmit and receive data is measured in bits per second (bps), or baud. For example, a 300-baud modem can transmit 300 bits per second. The most common way people use modems is to connect to the Internet. By the way, modem stands for *modulator-demodulator*.

Modems come in two basic flavors:

- **Analog Modems:** Computers store information digitally, while telephone lines transmit conversations and sounds. An analog modem converts a computer's ones and zeros to tones that can then be transmitted over standard phone lines. Analog modems are limited to speeds of 56Kbps.
- **Digital Modems:** Use binary ones and zeros to transmit data like a computer. Digital modems can transmit information much faster than analog modems. Digital modems are often referred to as *broadband* modems.

Table 4-3: *Modem Types and Speeds* describes the most common analog and digital modems out there.

Table 4-3: Modem Types and Speeds

	Type	Speed (in bps)	Description
Analog	PSTN, PSDN	56K	PSTN stands for Public Switched Telephone Network, and is nothing more than your everyday, ordinary telephone system based on copper wires. PSTN is often referred to as POTS, or plain old telephone service. PSDN stands for Public Switched Data Network and is just another technical term for the telephone system in use today.
Digital, Broadband	ISDN	56K to 128K	One of the older broadband connections. It's only twice as fast as a traditional modem and pretty much obsolete.
	ADSL, DSL	256K to 8,000K	ADSL modems take advantage of unused frequencies in the phone line, such as a pause in conversation. DSL modems are very fast; the problem is that you have to be close to a phone company in order to get DSL service.
	Cable	640K to 4,000K	A cable modem is the fastest modem you can buy for home use. The problem is your cable company has to offer cable Internet access in order to use it.

 **Quick Reference**
Analog Modem:

- Converts a computer's ones and zeros to tones that can then be transmitted over standard phone lines. Analog modems are limited to speeds of 56Kbps.

Digital Modem:

- Uses binary ones and zeros to transmit data like a computer. Digital modems can transmit information much faster than analog modems.

PSTN, PSDN:

- Ordinary, everyday telephone network, limited to 56Kbps.

ISDN:

- An older broadband connection, twice as fast as a traditional modem at 128Kbps.

ADSL, DSL:

- Fast digital connection with speeds up to 8,000Kbps.

Cable:

- Fast digital connection with speeds up to 4,000Kbps.

Chapter Four Review

Lesson Summary

Introduction to Networks

- **LAN:** Stands for Local Area Network and connects computers in the same geographic area or building, using cables.
- **WAN:** Stands for Wide Area Network and connects computers across a large geographic area.
- **Peer-to-Peer/Workgroup:** Files and resources are shared on every computer. Easier to setup but very insecure.
- **Client/Server Network:** Files are stored on a single central computer, or server. More secure and expensive.

The Internet

- **Internet:** The Internet is the largest computer network in the world and connects millions of computers.
- **World Wide Web:** A way of accessing information over the Internet.

Intranets and Extranets

- **Intranet:** A miniature version of the Internet that works on a network within a company or organization.
- **Extranet:** A miniature version of the Internet that allows access to authorized outside users, such as business partners.

Telephones and Networks

- **An analog modem** converts a computer's ones and zeros to tones that can then be transmitted over standard phone lines. Analog modems are limited to speeds of 56Kbps.
- **A digital modem** uses binary ones and zeros to transmit data like a computer. Digital modems can transmit information much faster than analog modems.
- **PSTN, PSDN:** Ordinary, everyday telephone network, limited to 56Kbps.
- **ISDN:** An older broadband connection, twice as fast as a traditional modem at 128Kbps.
- **ASDL, DSL:** Fast digital connection with speeds up to 8,000Kbps.
- **Cable:** Fast digital connection with speeds up to 4,000Kbps.

1. A LAN connects computers in the same building or facility. (True or False?)
2. What does LAN stand for?
 - A. Linked Area Network
 - B. Lots of Anarchy and Nonsense
 - C. Local Area Network
 - D. Linked Applications Node
3. An *Intranet* is a miniature version of the Internet that allows access to authorized outside users, such as business partners. (True or False?)
4. Which of the following modems is the slowest?
 - A. ISDN
 - B. DSL
 - C. Cable
 - D. Standard

Quiz Answers

1. True. A LAN connects computers in the same building or facility.
2. C. LAN stands for Local Area Network.
3. False. An *Extranet* is a miniature version of the Internet that allows access to authorized outside users, such as business partners
4. D. A standard modem is much slower than the other digital modems.

Chapter Five: Introduction to Windows XP

Chapter Objectives:

- **Start and log on to Windows**
- **Understand the Windows XP screen**
- **Use the mouse to: point, click, double-click, right-click, drag, and drop**
- **Use the keyboard**
- **Exit Windows and turn off the computer**

Prerequisites

- An IBM-compatible computer
 - Windows XP installed on the computer
-

Welcome to Windows XP! If you're new to Windows you're starting at the right chapter. This chapter covers the "bare bones" basics about learning how to start your computer and load Windows. You'll learn how to operate the mouse by clicking, double-clicking, dragging and dropping, and right-clicking. You'll also learn about your computer's keyboard and what those cryptic-looking keys on it are used for. Finally, you'll learn how to exit Windows and shut your computer down.

Before we start, take a deep breath and relax. You may find this difficult to believe, but Windows isn't nearly as difficult and complicated as you probably think they are. No matter what your previous experience with computers has been, this chapter assumes you're the most computer-illiterate person in the world and keeps everything as simple as possible. Actually, you're probably going to find that some of the lessons in this chapter are a little *too* easy. When you come across something you already know how to do, go ahead and skip the lesson (unless you're in a classroom of course—then go ahead and show everyone what a computer whiz you are!).

Ready? Did you take that deep breath? Then turn the page and let's get started!

Lesson 5-1: Starting and Logging On to Windows

Figure 5-1

The Welcome to Windows dialog box.

Figure 5-2

The Windows XP Desktop

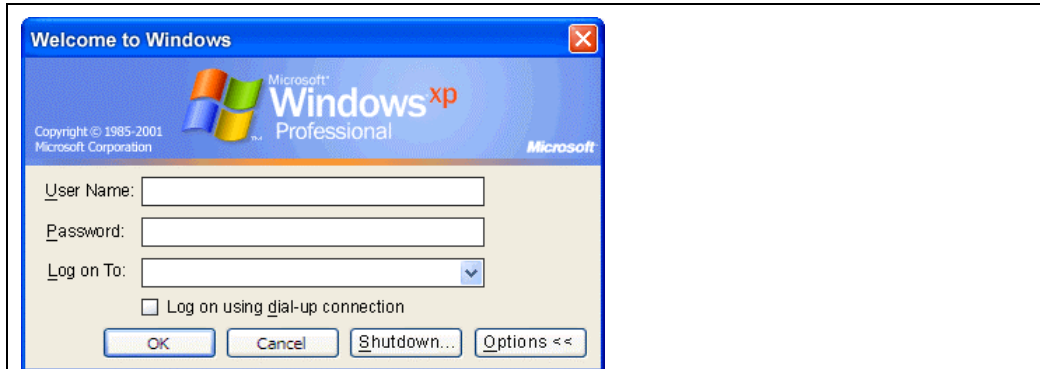

Figure 5-



Figure 5-2

When you get to work, after taking off your jacket and grabbing a cup of coffee, you probably begin your day by turning on your computer and starting Windows. This lesson explains how to do the absolute most basic thing there is to do with your computer—turn it on. Windows should automatically start after you turn on your computer. If it doesn't, or if a confusing-looking screen greets you, this lesson also explains what you need to do to load Windows.

1. Turn on your computer's monitor.

The On/Off switch for most monitors is located just below the monitor's screen. Most monitors won't display anything until the computer is turned on.

2. Turn on your computer.

Finding your computer's On/Off switch for the first time can be a little tricky. Refer to your computer's reference manual if you can't find the On/Off switch for your computer. Your computer should make a whirring sound and several clicks and/or beeps after you turn it on and as it powers up.

NOTE: If nothing happens when you turn your computer on, first check the computer's power cord—is it plugged into the wall or power strip? Check the other end of the power cord—is it securely plugged into the back of the computer? If your computer is plugged into a power strip or surge protector (it really should be) check and make sure that the power strip is turned on.

Eventually you should see the Welcome to Windows dialog box. If you're connected to a Novell Network the dialog you see may be slightly different, but the message will usually be the same—press Ctrl + Alt + Delete to log on.

3. If necessary, press <Ctrl> + <Alt> + <Delete> to start the log on procedure.

The Windows Log On dialog box appears, as shown in Figure 5-.

4. Enter your user name and password and press <Enter>.

Depending on how your computer is setup, the Getting Started with Windows XP dialog box may appear. Here's how to close it:

5. If the Getting Started with Windows XP dialog box appears click the Exit button to close it.

If you didn't already know how to turn your computer on, congratulations! You've just taken your first step in learning how to operate a computer and Microsoft Windows XP.

Quick Reference

To Start Windows

1. Turn on your computer.
2. If necessary, press <Ctrl> + <Alt> + <Delete> to start the log on procedure.
3. Enter your user name and password and press <Enter>.

Lesson 5-2: Understanding the Windows XP Screen

Figure 5-3

Those are the major parts of the Windows XP screen. More items will probably appear on your computer, depending on how it is set up.

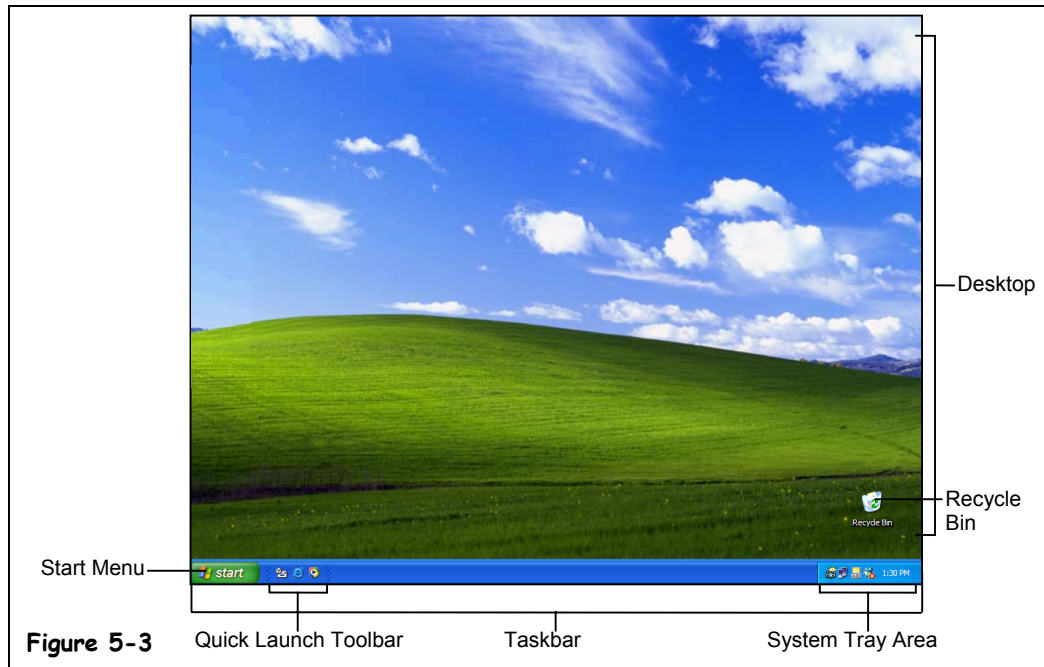

You might find the Windows screen a bit confusing and overwhelming the first time you see it. Nothing on the screen appears familiar to you—where do you even start? This lesson will help you become familiar with the main Windows screen, known as the *desktop*. There isn't a step-by-step exercise anywhere in this lesson—all you have to do is look at Figure 5-3 and then refer to Table 5-1: *Major Parts of the Windows XP Screen*, to see what everything you're looking at means. And, most of all, relax! This lesson is only meant to help you get acquainted with Windows—you don't have to memorize anything.

Table 5-1: Major Parts of the Windows XP Screen

<i>Item</i>	<i>Description</i>
Desktop	This is the large, background area of the Windows screen. You can customize the desktop by adding shortcuts to your favorite programs, documents, and printers. You can also change the look of the desktop to fit your mood and personality.
My Documents	My Documents is a special folder that provides a convenient place to store files and documents you create on your computer.
My Computer	My Computer lets you see everything on your computer. Double-click the My Computer icon on the desktop to browse through your files and folders.
My Network Places	If you're on a network, the My Network Places icon will appear on your desktop. You can double-click the My Network Places icon to browse through the computers in your workgroup and the computers on the network. If you're connected to the Internet, the My Network Places icon will on your desktop, since the Internet is actually a network too.
Recycle Bin	The Recycle Bin stores all the files you delete from your computer. You can use the Recycle Bin to retrieve files you've accidentally deleted and to create more disk space by emptying the Recycle Bin.
Taskbar	The Taskbar usually appears at the bottom of your screen, and contains the famous Start button, which you use to start your programs. Whenever you open a program, document, or window, an icon for that program appears on the taskbar. This lets you see which programs are currently running and allows you to easily switch between them.
Start Button	The Start button lets you quickly open your programs and documents. You can also use the Start button to find files and change the settings for Windows.
Quick Launch Toolbar	The Quick Launch Toolbar gives you quick access to your most frequently used applications. Internet Explorer, Outlook Express, the Windows desktop, and several Web sites, called channels, are already included on the Quick Launch Toolbar by default.

Don't worry if you find some of these things confusing at first—they will make more sense after you've actually had a chance to use them in the upcoming lessons.

Lesson 5-3: Using the Mouse: Pointing, Clicking, and Double-clicking

Figure 5-4

Clicking and double-clicking with the mouse

Figure 5-5

Click the Start button to open the Windows XP Start menu.

Figure 5-6

Double-click the My Computer icon to open it and display its contents.

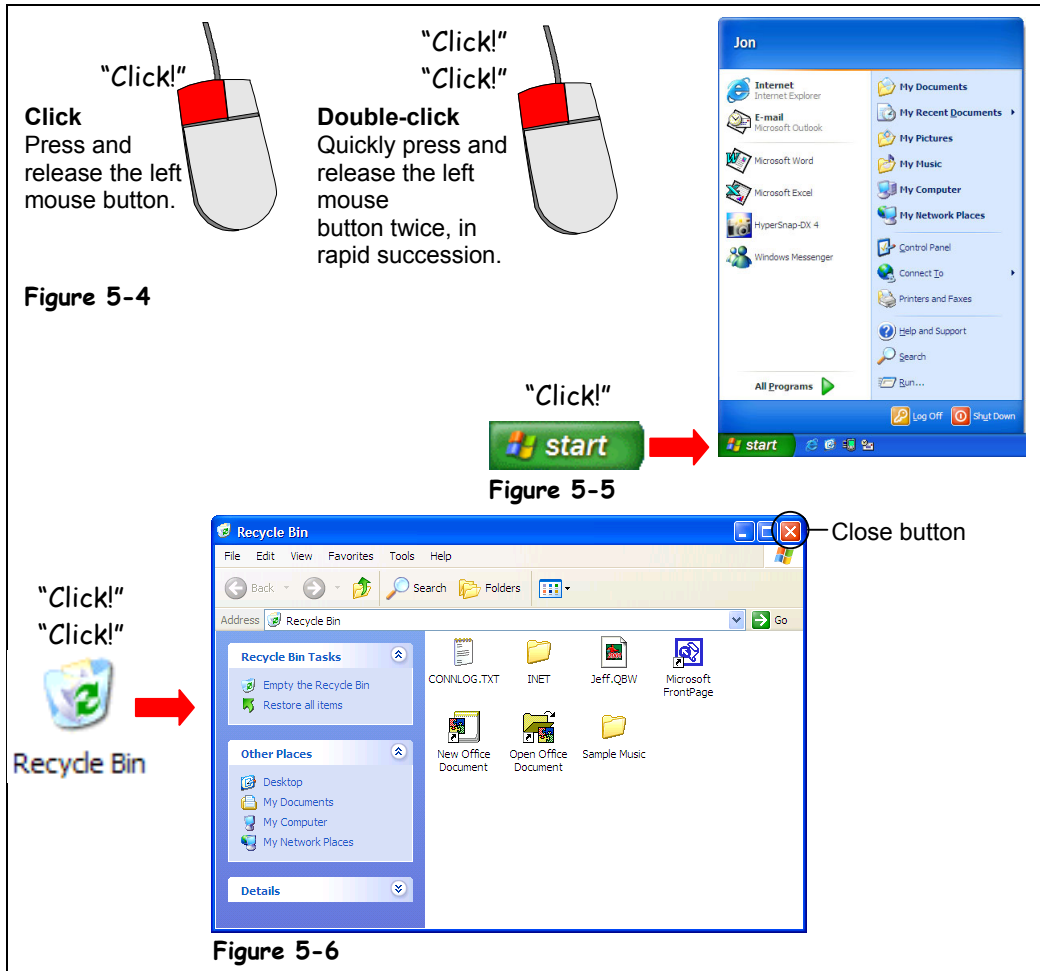

Just like you control your television set using a remote control, you control Windows by using the mouse and keyboard. A mouse is a palm-sized device that lets you point at, select, and move objects on your computer screen. The mouse is linked to the pointer on your computer screen—when you move the mouse on your desk, the pointer moves on the computer screen. Think of the mouse as an electronic extension of your hand. This lesson will show you how to perform the two most basic mouse actions: clicking, and double-clicking.



- 1. Rest your hand on the top of the mouse, then move the mouse and watch as the arrow moves across the screen.**

The arrow (also called the cursor or pointer) follows the mouse as you move it across the desk or mouse pad.

Pointing is the most basic action you can do with the mouse. To point to something, simply place the mouse pointer over it by moving the mouse. You must point to objects in order to click or double-click them.

2. Move the mouse pointer until the tip of the pointer is over the Start button. Leave the pointer there for a few seconds.

A message “Click here to begin” appears by the pointer after several seconds.

Clicking means pressing and releasing the left mouse button one time. The mouse makes a clicking noise whenever you press and release one of its buttons, hence the name clicking. The next steps will show you how to open the Start menu by clicking it.

3. Move the pointer over the Start button and then click the left mouse button.

When you click the Start button, the Windows XP menu pops-up, as shown in Figure 5-6. Congratulations! You’ve just made your first click!

NOTE: Most mice have two mouse buttons. Normally, you use the left mouse button (unless someone has changed the mouse options and reversed the buttons!) You can assume you will use the left mouse button whenever you see the words click or double-click. The right mouse button has its own purpose—and we’ll discuss it in an upcoming lesson.

You can close the Windows XP menu without selecting anything by clicking anywhere outside the Start menu.

4. Move the pointer anywhere outside the Windows XP Start menu and click the left mouse button.

Now that you’re feeling comfortable with pointing and clicking, we’ll move on to something a little more tricky: *double-clicking*. Just as it sounds, double-clicking means pressing and releasing the mouse button twice in rapid succession. You will usually open an object, such as a file, folder, or program by double-clicking it.

5. Position your pointer over the Recycle Bin icon and double-click it with your left mouse button.

Recycle Bin opens to reveal its contents, as shown in Figure 5-6.

NOTE: A lot of people have problems the first time they try double-clicking. If your double-click doesn’t seem to work, it’s probably because you’re either not holding the mouse steady while you’re double-clicking, or else you’re not double-clicking fast enough. If you click the mouse button too hard, you may inadvertently slide the mouse before you’ve finished double-clicking—and your double-click won’t register. If you’re certain that you’re holding the mouse steady while you double-click, you can adjust the double-click speed in the Windows Control Panel.

6. Close the Recycle Bin window by clicking its Close button, as shown in Figure 5-6.



Start button



Recycle Bin icon



Close button

Quick Reference

To Point to Something:

- Move the mouse so that the pointer (☞) is over the object.

To Click:

- Point to the object and press and release the mouse button.

To Double-click:

- Point to the object and rapidly click the mouse button two times.

Table 5-2: Things you can click and double-click

<i>Click when you want to:</i>	<i>Double-click when you want to:</i>
Select something.	Open a file.
Open a menu.	Open a folder.
Press a button on a toolbar or in a dialog box.	Display the properties or settings for an object (in certain programs)
Move to the area or field you want in a program or dialog box.	

Lesson 5-4: Using the Mouse: Dragging and Dropping

Figure 5-7

Dragging and Dropping with the mouse

Figure 5-8

You can start a game of Solitaire by looking under Programs → Games → Solitaire.

Figure 5-9

The Solitaire game, which comes with Windows

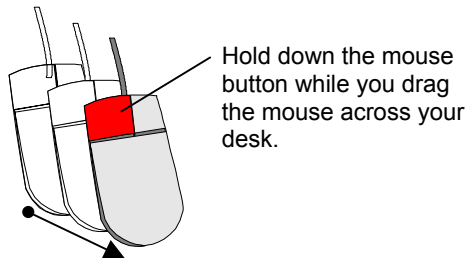

Drag

Place the pointer over an object and press and hold down the left mouse button. While you are still holding the button, move the mouse to the where you want to place the object and then release the mouse button.

Figure 5-7

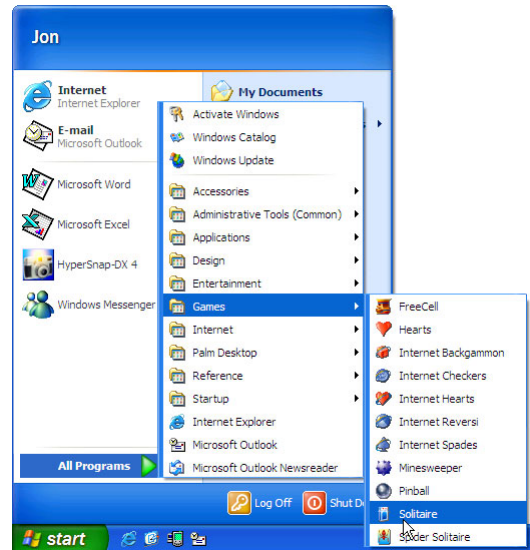

Figure 5-8

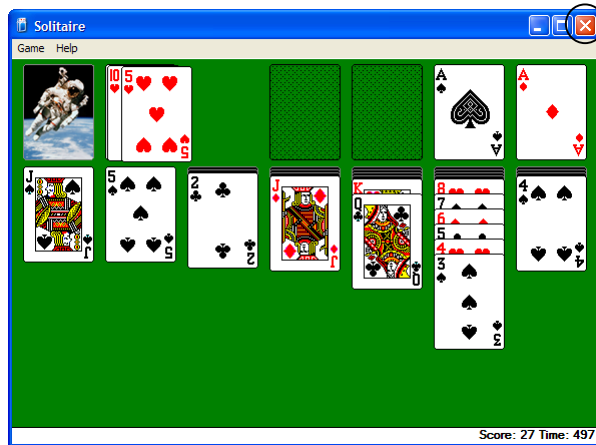

Figure 5-9

Close button



Start button

You can move items around your computer screen by *dragging and dropping* them with the mouse. To drag and drop something, you: (1) Move the mouse pointer over the object you want to move, then click and *hold down* the mouse button. (2) While you are still holding down the mouse button, move the mouse until the pointer is over the place you want to put the object, then (3) Release the mouse button.

This will probably be the most entertaining lesson in the book, because your assignment is to master dragging and dropping by playing a game of Solitaire! Microsoft included Solitaire with Windows to help people improve their mouse skills. You've probably noticed that a lot of people never stop practicing these skills with Solitaire. Here's how to open Solitaire:

1. Click the **Start button.**

Remember the Start button is located in the bottom-left corner of your screen. The Windows XP Start menu appears.

2. Point to the word **All Programs.**

The All Programs menu pops out to the right.

3. Point to the word **Games.**

Another menu, the Games menu, pops out, as shown in Figure 5-8.

4. Click the word **Solitaire.**

You're finally there! The Solitaire program opens, as shown in Figure 5-9.

5. Play a game of Solitaire and practice dragging and dropping the cards.

If you don't know how to play Solitaire, you can still practice your dragging and dropping. Just point to a card, click and hold down the mouse button and move the card around the screen. Release the mouse button to drop the card. If you try dropping a card in an invalid location, the card will be whisked back to its original pile.

6. Click the **Close button located in the top right corner of the Solitaire program to exit the program when you've finished playing.**

The Solitaire program closes.

Okay, there have to be more things to drag and drop besides cards! Although we'll be covering this stuff later on, Table 5-3: *Things you can drag and drop* gives some examples of when you can use drag and drop.

You may have trouble mastering drag and drop right away. Don't get discouraged; this is a tricky task for beginners. Just keep practicing and you'll improve.



Close button

Table 5-3: Things you can drag and drop

You can do this:	By dragging this:
Move a window to a new location on the screen	Drag the window by its title bar and drop it in a new location on the screen.
Move a file to a new folder	Drag the file and drop it in the desired folder.
Change the size of a window	Drag the borders or corners of the window.
Scroll a window to see something located off-screen	Drag the scroll box (the little elevator) up or down the scroll bar and drop it in a new location.
Move just about anything on your computer's screen	Point to the object, click, and hold down the mouse button, drag the object to a new place, and then release the mouse button.

Quick Reference

To Drag-and-Drop:

1. Point to the object you want to drag and drop and click and hold down the mouse button.
2. While you're still holding down the mouse button, drag the object to the desired location on the screen.
3. Release the mouse button.

Lesson 5-5: Using the Mouse: Right-clicking

Figure 5-10

Right-Clicking

Figure 5-11

The right mouse button shortcut menu for the Recycle bin

Figure 5-12

The right mouse button shortcut menu for the clock

Figure 5-13

The Local disk (C:) Properties dialog box

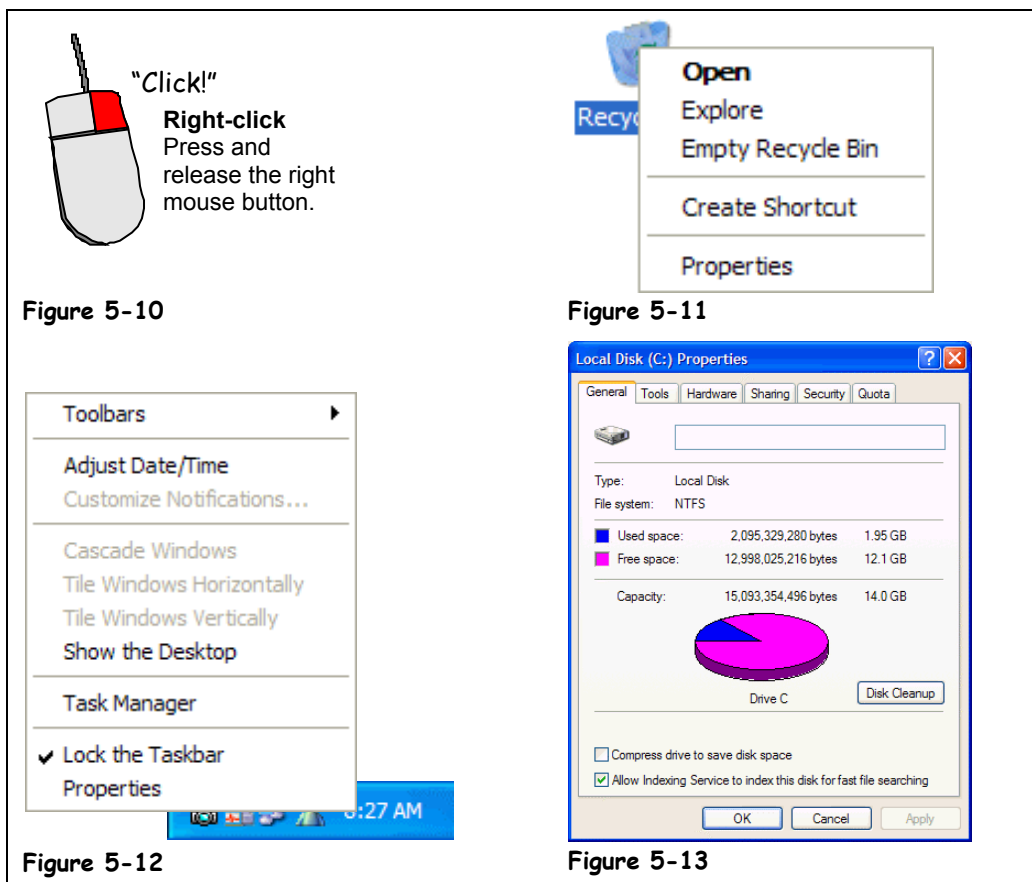

Figure 5-10

Figure 5-11

Figure 5-12

Figure 5-13

You already know that the left mouse button is the primary mouse button, used for clicking and double-clicking, and it's the mouse button you will use over 95 percent of the time when you work with Windows. So what's the right mouse button used for? Whenever you *right-click* something, it brings up a shortcut menu that lists everything you can do to the object. Whenever you're unsure or curious about what you can do with an object, point to it and click it with the right mouse button. A shortcut menu will appear with a list of commands related to the object or area you right-clicked.

Right mouse button shortcut menus are a great way to give commands to Windows because you don't have to wade through several levels of unfamiliar menus when you want to do something.



Recycle Bin

1. Move the pointer over the **Recycle Bin** icon on your desktop and click the **right mouse** button.

A shortcut menu appears with a list of commands related to the Recycle Bin, as shown in Figure 5-11.

2. Point to and click the **Empty Recycle Bin** option on the shortcut menu with the **left mouse button**.

You still use the left mouse button to select menu items, even if they are found in a right-mouse button shortcut menu. A dialog box appears, asking you if you are sure you want to delete the contents of the Recycle Bin. Better play it safe and...

3. Click **No** with the left mouse button.

Next, you realize the clock displayed on the far right side of the taskbar is ten minutes fast. You can display the clock's properties by right-clicking the clock.

4. Move the pointer over the **Clock**, located on the far right side of the Windows Taskbar, and click the **right mouse button**.

Another shortcut menu appears, with commands related to the Windows clock, as shown in Figure 5-12. Notice one of the commands listed on the shortcut menu is Adjust Date/Time. You would select this menu item if you really wanted to adjust the date and/or time. You don't want to adjust the date or time, however, so you can move on to the next step and close the shortcut menu without selecting anything.

5. Click anywhere outside the **Clock** shortcut menu with the left mouse button to close the menu without selecting anything.

The final object we'll right-click in this lesson is the computer's local disk. To get to the local disk you have to open My Computer. Do you remember how to do it?

6. **Double-click** the **My Computer** icon.

The My Computer window opens, displaying the contents of your computer. You want to see how much space is left on your computer's local disk. Right-click the Local disk (C:) icon to get this information.

7. **Right-click** the **Local disk (C:)** icon.

A shortcut menu appears, with a list of commands related to the local disk.

8. Click the **Properties** option on the shortcut menu with the **Left mouse button**.

A dialog box appears, showing a graph with how much space is left on your hard drive, as shown in Figure 5-13.

9. Click **Cancel** to close the Local Disk (C:) Properties dialog box.

You're done! You've learned all the actions you can perform with the mouse. Quick! What are they again? Pointing, Clicking, Double-clicking, Dragging and Dropping, and Right-clicking. What an accomplishment!

Right-click an object to open a shortcut menu that lists everything you can do to the object.

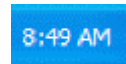

Windows clock



My Computer



Local Disk (C:) icon

Quick Reference

To Display a Shortcut Menu for Something:

- Point to the object and click the right mouse button. Select items from the shortcut menu with the left mouse button.

To Close a Shortcut Menu without Selecting Anything:

- Click anywhere outside the shortcut menu with the left mouse button, or press the **<Esc>** key.

Lesson 5-6: Using the Keyboard

Figure 5-14

A standard keyboard (Your computer may have a slightly different layout than the one pictured here.)

Figure 5-15

The Shut Down Windows dialog box

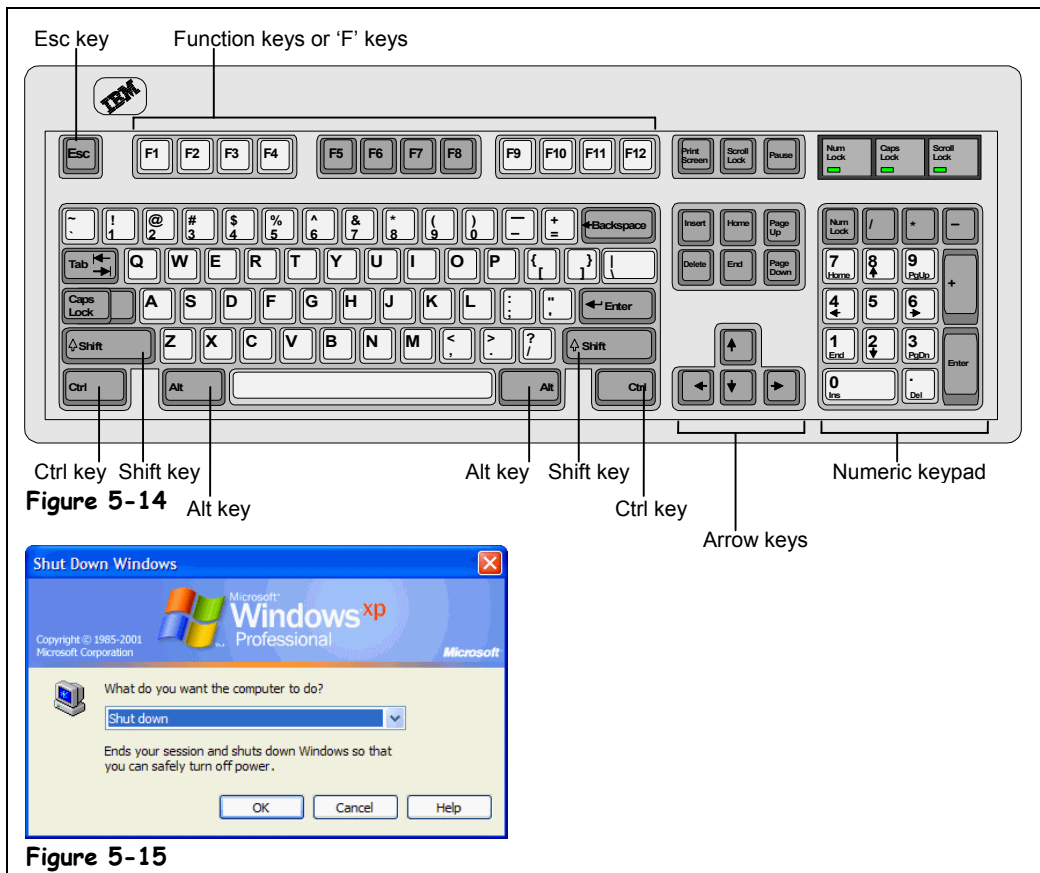

Now that you've mastered the mouse, it's time to move on to the other device that you use to control your computer: the keyboard. The keyboard may seem more familiar and easy to use than the mouse at first, but don't be fooled! Computer keyboards sneak in some extra keys that you need to know about. This lesson explains what these extra keys on the keyboard are and when to use them.

1. Press and hold down the <Alt> key, press the <F4> key, and release both buttons.

Pressing <Alt> + <F4> closes the currently running program. Since you're using the Windows Desktop, the Shut Down Windows dialog box appears, as shown in Figure 5-15.













We're not ready to shut Windows down just yet (we'll cover that in a future lesson). Follow the next step to back out of the Shut Down Windows dialog box without selecting anything.

2. Press the <Esc> key.

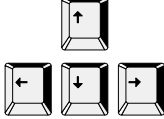
Pressing <Esc> does the same thing as clicking the Cancel button. The Shut Down Windows dialog box disappears and you're back at the Windows desktop.

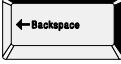
Table 5-4: *Special Keys and Their Functions* describes the <Alt> and <Esc> keys you just used, as well some of the other confusing keys on the keyboard.

Table 5-4: Special Keys and Their Functions

Key(s)	Description
	The <Alt> key doesn't do anything by itself—it needs another key to make things happen. For example, pressing the <Tab> key while holding down the <Alt> key switches between any programs that are currently running.
	Just like the <Alt> key, the <Ctrl> doesn't do anything by itself—you need to press another key with it to make things happen. For example, pressing the <X> key while holding down the <Ctrl> key cuts whatever is selected.
	The <F1> key is the help key, and pressing it displays helpful information about what you're doing.
	The <Esc> (Escape) key is the “Wait, I've changed my mind” key and is the same as clicking Cancel in a dialog box. For example, if you click something and an unfamiliar dialog box appears, you can close it by pressing the <Esc> key.
	The <Enter> key is the “Carry out my orders” key and is the same as clicking the OK button in a dialog box. For example, after you've typed the name of a program you want to run in a dialog box, press <Enter> to run the program. The <Enter> key also adds new lines and starts new paragraphs if you're entering text.
	When you're in a dialog box, pressing the <Tab> key moves to the next field. When you're using a word processor, the <Tab> key works just like you'd think it would and jumps to the nearest tab stop whenever you press it.
	The arrow keys move your computer's cursor across the screen.
	Nothing surprising here. The <Delete> key deletes or erases whatever you select—files, text, or graphical objects. If you're working with text, the <Delete> key erases characters to the right of the insertion point.
	Use the <Backspace> key to fix your typing mistakes—it erases characters to the left of the insertion point.
	The <Home> key jumps to the beginning of the current line when you're working with text.
	The <End> key jumps to the end of the current line when you're working with text.
	The <Page Up> key moves up one screen.
	The <Page Down> key moves down one screen.

Quick Reference

To Use a Keystroke Combination:

- Press and hold down the first key, press the second key, then release both keys. For example, press the <Tab> key while you're holding down the <Alt> key.

To Use the Special Keys on the Keyboard:

- Refer to Table 5-4: *Special Keys and Their Functions*.

Lesson 5-7: Exiting Windows and Turning off Your Computer

Figure 5-16

The Shut Down Windows dialog box

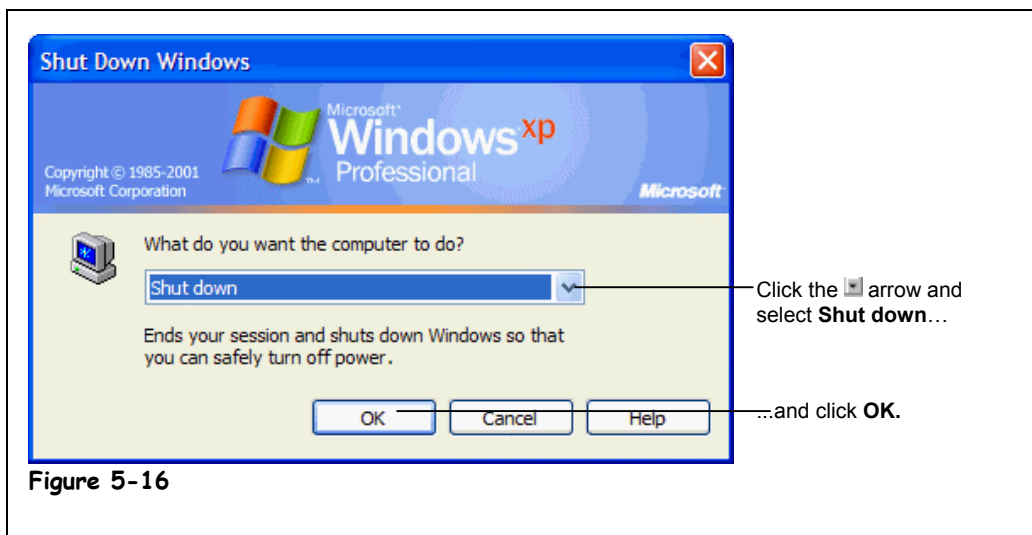

Figure 5-16

At the end of the day, when you've finished using your computer, you need to shut down Windows before you turn your computer off. Shutting down gives Windows a chance to tidy up after itself, saving information in the computer's memory to the local disk, cleaning up temporary files, and verifying that you've saved any changes you made to any files you worked on.

Should I turn my computer off at all? One of the great computer debates is whether you should turn your computer off at all. Some people turn off their computer whenever they've finished working on it, just like a television set. Others don't turn their computers off—*ever*. People who turn their computers off at night say that keeping the computer on 24 hours a day, 7 days a week wears out the computer's mechanical components and wastes electricity. Other people say that leaving your computer on keeps temperature fluctuations down, which is better for the computer's delicate internal components. Plus, most new computers enter a standby or hibernate mode after a period of time, so they don't really consume that much power. Which method is best? That's a decision you'll have to make on your own. Some people turn their *home* computer off when they finish using it and leave their *office* computer on 24 hours a day.

Whether or not you turn your computer off, you should *always* follow the next few steps at the end of the day, when you've finished using your computer.

1. Save all your work and exit all your programs.

Saving any files you've been working on is the most important step of all when you shut down your computer. You should also consider backing up any vital information if you have a tape backup, Zip drive, or other backup device. You can also save any important files to a floppy.

2. Click the **Start** button.

The Start menu appears.

3. Click the **Shut Down** option from the Start menu.

The Shut Down Windows dialog box appears, as shown in Figure 5-16.



Start button

4. Make sure the **Shut down option is selected and click the **OK** button.**

The computer's hard drive hums as Windows cleans up and shuts itself down.

NOTE: Leaving nothing to chance, Windows checks to make sure you've saved everything you've been working on, such as letters you created in your word processing program. If Windows notices you haven't saved a file, it asks if you want to save the changes you made to the file before it completes the shut down procedure.

After a minute or two, Windows finishes shutting down and tells you it's safe to turn off your computer.

5. Turn your computer and monitor off.

This final step is optional.

Congratulations! You've completed the chapter and are well on your way to mastering Windows XP! You're probably wondering "What were those other Shut Down options for?" Table 5-5: *Shut Down Windows Options* explains them:

Table 5-5: Shut Down Windows Options

<i>Shut Down Option</i>	<i>What it Does</i>
Stand by	Use Stand by if you have a laptop and are going to leave your computer briefly but want to conserve as much energy as possible while you are away. After you return your computer to its original running state, you will be able to pick up exactly where you left off. (Make sure you save everything you were working on first!)
Shut down	Use this option if you want to turn your computer off. It saves your Windows settings and saves any information stored in memory to the local disk.
Restart	Saves any Windows settings, writes any information stored in your computer's memory to the local disk, and restarts your computer. Use this option if Windows or your Windows-based programs start acting flaky. You often have to restart your computer after installing new software.
Log Off As...	This option appears only if your computer is connected to a network. This option closes all your programs and disconnects your computer from the network, preparing your computer to be used by someone else.

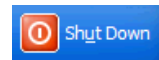
**Shut Down button****Other Ways to Shut Down:**

- Press **<Ctrl> + <Alt> + <Delete>**. A dialog box will appear, and you can choose to shut down.

Quick Reference
To Shut Down Windows:

1. Save any files you've been working on and exit all your programs.
2. Click the **Start** button and select **Shut Down**.
3. Select the **Shut Down** option and click **OK**.

Chapter Five Review

Lesson Summary

Starting and Logging On to Windows

- **To Start Windows XP:** Turn on your computer. Enter your user name and password, and then click **OK**.

Understanding the Windows XP Screen

- Be able to identify the main components of the Windows screen.

Using the Mouse: Pointing, Clicking, and Double-clicking

- **Point:** Move the mouse so that the pointer () is over the object.
- **Click:** Point to the object and press and release the left mouse button.
- **Double-click:** Point to the object and click the left mouse button twice in rapid succession.

Using the Mouse: Dragging and Dropping

- **To Drag-and-Drop:** Point to the object you want to drag and drop, and click and hold down the mouse button. While you're still holding down the mouse button, drag the object to the desired location on the screen, and then release the mouse button.

Using the Mouse: Right-clicking

- **To Display an Object's Shortcut Menu:** Point to the object and click the right mouse button. Select items from the shortcut menu with the left mouse button.
- **To Close a Menu without Selecting Anything:** Click anywhere outside the shortcut menu with the left mouse button, or press the **<Esc>** key.

Using the Keyboard

- **To Use a Keystroke Combination:** Press one key while holding down the other key. For example, press the **<Tab>** key while you're holding down the **<Alt>** key.

Exiting Windows and Turning off Your Computer

- **To Shut Down Windows:** Save any files you've been working on, exit all your programs, click the **Start** button, select **Shut Down**, select the **Shut Down** option, and click **OK**.

Quiz

- 1. Microsoft Windows is a (an):**
 - A. Word processing program.
 - B. Database program.
 - C. Operating System.
 - D. Graphics program.
- 2. Windows uses only the left mouse button. (True or False?)**
- 3. Which of the following moves the pointer to another location on-screen?**
 - A. Pressing the arrow keys on the keyboard.
 - B. Moving the mouse until the pointer points to that spot.
 - C. Moving the mouse until the pointer points to that spot and click the left mouse button.
 - D. Moving the mouse until the pointer points to that spot and click the right mouse button.
- 4. A keystroke combination is:**
 - A. Pressing two or more keys at the same time, like pressing the <Shift> and <Tab> keys at the same time.
 - B. A way to lock your computer to prevent unauthorized access. To unlock the computer, simply retype your keystroke combination.
 - C. Using the keyboard in conjunction with the mouse.
 - D. A type of mixed drink.
- 5. To display a shortcut menu for an object, do the following:**
 - A. Point to the object and press <Ctrl> + <P>.
 - B. Touch the object on-screen with your finger.
 - C. Click the object.
 - D. Right-click the object.
- 6. The <F1> key displays help on whatever you're working on. (True or False?)**

Homework

1. Turn on your computer and start Windows XP.
 2. Find, point to, and click the Start button, then close the Start menu without selecting anything.
 3. Find and double-click My Computer.
 4. Shut down Windows by selecting Shut down from the Start menu, verifying the Shut down option is selected, and clicking the OK button.
-

Quiz Answers

1. C. Microsoft Windows is an Operating System.
2. False. Windows uses both the left and right mouse buttons.
3. B. Move the pointer by moving the mouse until the pointer points to that spot.
4. A. A keystroke combination is when you press two or more keys at the same time, for example <Shift> + <Tab>.
5. D. Right-click the object.
6. True. Pressing the <F1> key displays help on whatever you're working on.

Chapter Six: Working with a Window

Chapter Objectives:

- **Starting a program**
- **Understanding the parts of a window**
- **Minimizing, maximizing, and restoring a window**
- **Moving and closing a window**
- **Changing the size of a window**
- **Switching between several programs**
- **Tiling and cascading windows**

Prerequisites

- How to start and shut down Windows
 - How to use the mouse to click, double-click, drag and drop, and right-click
-

No doubt about it: computers are sophisticated, complex machines. To make computers easier to use, Microsoft designed Windows to operate how you work at the desk in your office. When you work at your desk, you spread everything out, grab a piece of paper, work on it for a while, and then shuffle another piece of paper on top of it. That's how Windows works, except instead of working with papers, you work with *windows*—boxes that contain programs and information.

You can shuffle these windows around the screen just like you shuffle papers on your desk—which is why the main Windows screen is called the *desktop*. Just like your desk, if you're working with a lot of things at the same time, the Windows desktop can become messy and difficult to find things on.

This chapter explains how to manage the windows and programs on your screen. First, you'll learn how to open a window. Next, you'll discover the parts that constitute a window (which are A LOT different than the ones on your house). Then you'll learn how to change the size of a window—*minimizing* it to a tiny little icon that appears only on the Taskbar and *maximizing* it so that it fills the entire screen. You'll also learn how to “shuffle” windows around, sending some to the background and bringing others up to the forefront. Let's get started!

Lesson 6-1: Starting a Program

Figure 6-1

Click on the Start button to open the menu, and then point to All Programs to open the menu.

Figure 6-2

Click on Accessories to open the menu, and then click on WordPad to open the program.

Figure 6-3

The WordPad program

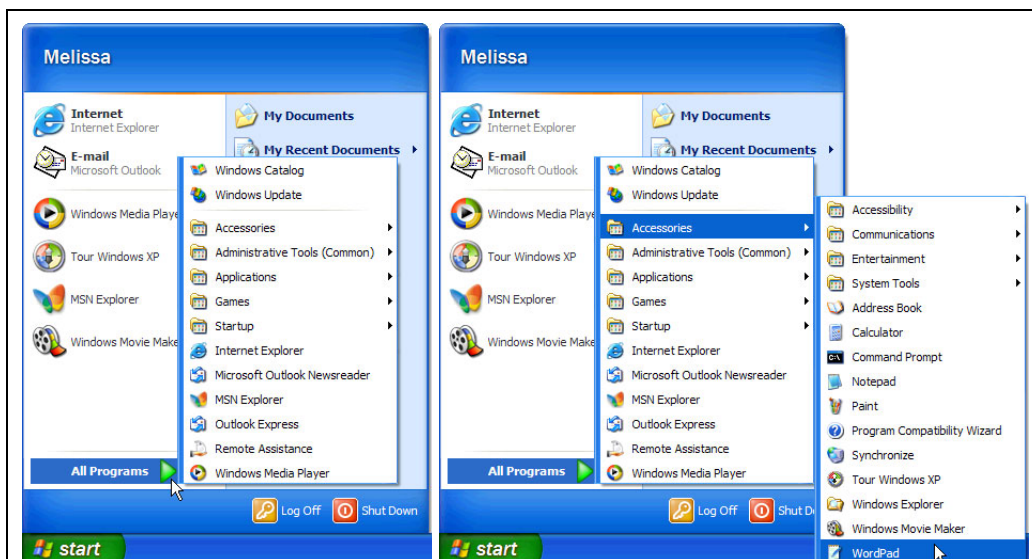

Figure 6-1

Figure 6-2

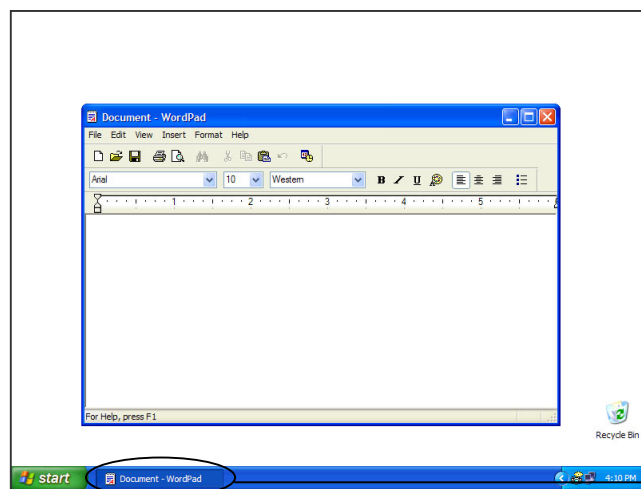

Figure 6-3

Any programs that are currently running appear as icons on the taskbar



To do just about anything with your computer, you need to run a program. A *program* is a complex set of instructions that tells your computer how to do something. Your word processor is a program, and so is the Solitaire game that comes with Windows. The easiest way to start a program is by clicking the Windows Start button and then selecting the program from the All Programs menu. This lesson explains one of the most basic operations you can do with Windows: starting a program.

1. Click the **Start** button.

Remember that the Start button resides in the bottom-left corner of the computer screen. The Start menu pops up.

2. Point to **All Programs.**

A menu listing the different program categories pops out above the Start menu, as shown in Figure 6-1.

3. Point to the word **Accessories.**

Another menu, the Accessories menu, shoots out to the side of the All Programs menu, as shown in Figure 6-2. The program you want to load, WordPad, is in the Accessories menu. Can you find it?

4. Click the word **WordPad.**

The WordPad program appears on the screen in its own window, as shown in Figure 6-3. WordPad is a simple word processing program that is included with Microsoft Windows.

NOTE: The All Programs menu is merely a list of the programs that should be available on your computer. When installed, programs should automatically add themselves to the Start menu. Occasionally, old MS-DOS programs or programs that are poorly written may not put themselves on the Start menu when you install them, and you will have to find and add the program to the All Programs menu yourself. You'll learn how to manually add programs to the Start menu in an upcoming lesson.

Great! You've just started your first program. Turn the page and we'll examine the parts of the WordPad window.

All Programs 

All Programs

 Accessories

Accessories

 WordPad

WordPad program

Most programs run in their own separate window on the screen.

Quick Reference

To Start a Program:

1. Click the **Start** button.
2. If the program appears on the Start menu click it, otherwise point to the **All Programs** option.
3. Click the menu and any submenus where the program you want to run is located.
4. Click the name of the program you want to run.

Lesson 6-2: Understanding the Parts of a Window

Figure 6-4

The parts of a typical window

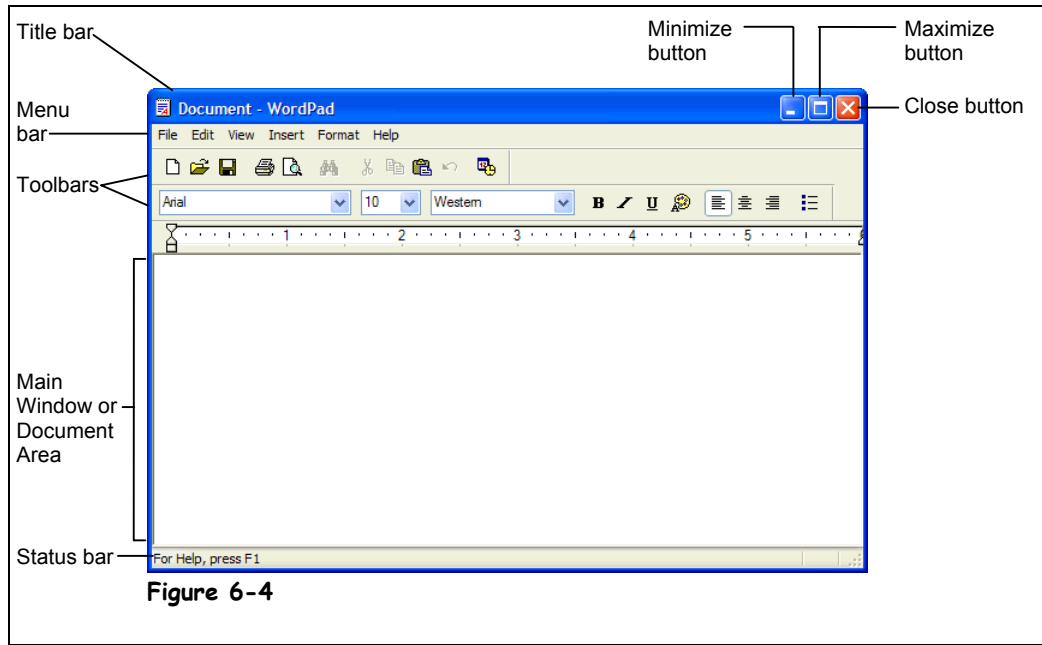

Located in every window are several little buttons, menus, and controls that you use to control the program and window. Because they appear in every Windows program, you're going to have to learn what these little buttons, menus, and controls are and learn how to use them. Here's the good news: once you can find your way around a window for one program, you'll be familiar with the windows for most programs since this window/menu/button concept appears in just about every Windows program.

There are no exercises or homework for you in this lesson—it's just here to help you become familiar with the parts of a window. All you have to do is look at Figure 6-4 and then refer to Table 6-1: *Parts of a Window* to identify what you're looking at.

And don't worry; you'll get a chance to play with some of these buttons and menus later on.

Table 6-1: Parts of a Window

Part	Description
Title bar	Displays the name of the program or window
Minimize button	Minimizes a window, hiding it from your screen but keeping it running in your computer's memory, ready for quick use. You can minimize a program you're not using so that it is still running, but is out of sight.
Maximize/Restore button	Depending on the size of the window, this button toggles between maximize and restore. Here's what each one does: Maximize: Enlarges the window so that it fills the entire screen. This lets you see more of the window's contents. The Maximize button only appears when the window isn't maximized (doesn't fill the entire screen). Restore: When a window is maximized (fills the entire screen), clicking the Restore button returns the window to its previous size.
Close button	Closes the window or program when you're finished working with it, removing it from the screen and the computer's memory.
Menu bar	Controls what the program does. The items listed on the menu bar change from program to program, but the menu bar's location doesn't—it's always perched near the top of a window, right below the Title bar.
Toolbar	Some (but not all) windows and programs have one or more toolbars, which contain buttons you point and/or click to access frequently used commands.
Main Window or Document Area	This is where all the action takes place—where you work on whatever you're working on. If you were using a word processor, this is where your letter would appear. If you were browsing the Internet, this is where the Web pages would appear.
Status bar	Displays information such as instructions, messages about the state of the computer, or your location in the window.

Got everything down? Don't worry if you don't; this lesson is just a quick-guided tour of a typical window. The rest of the lessons in this chapter focus on how to use a window's controls, buttons, and menus.

Lesson 6-3: Minimizing, Maximizing, and Restoring a Window

Figure 6-5

The Minimize, Maximize, and Restore buttons appear in the upper right corner of most programs.

Figure 6-6

A window in a restored state only fills up part of the screen.

Figure 6-7

A window in a maximized state fills up the entire screen.

Figure 6-8

A window in a minimized state appears only as an icon on the taskbar.

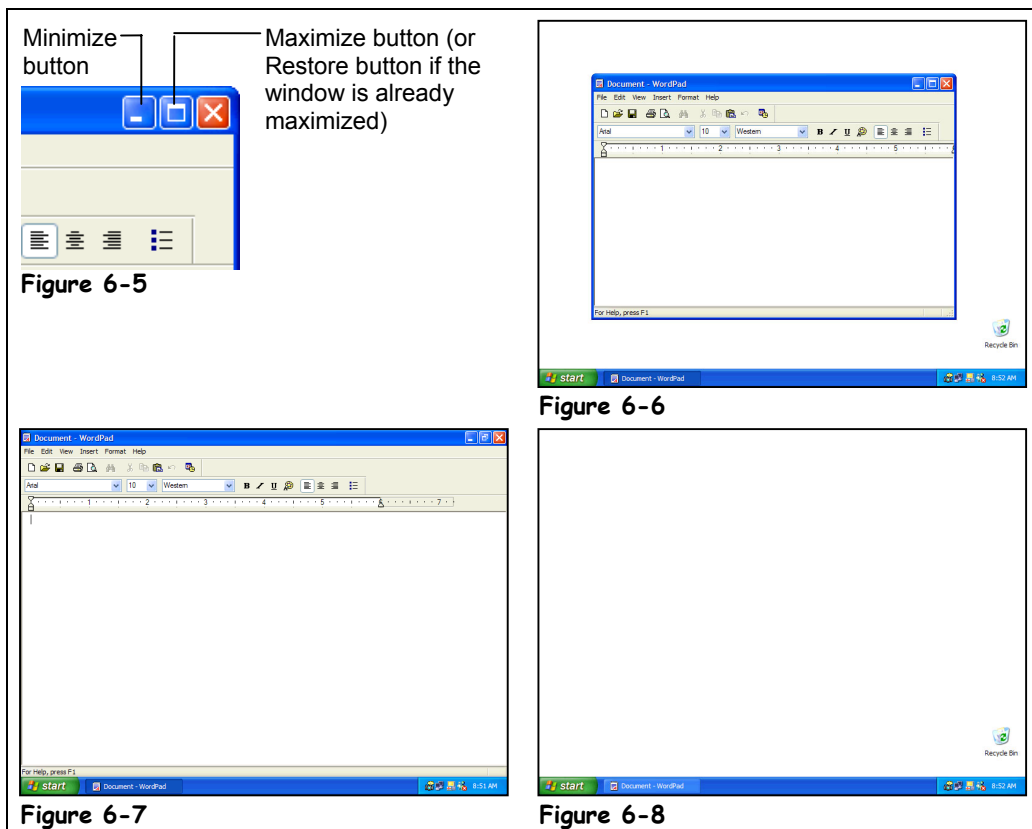

One of the benefits of Windows XP is that it enables you to open and work with several programs at the same time. To make working with several programs at once easier, you can change the size of the windows. You can *maximize*, or enlarge, a window so it takes up the entire screen; *minimize*, or reduce, a window so that it only appears as a button in the Windows taskbar; or size a window somewhere in between. This lesson explains how to change the size of a window by *maximizing*, *minimizing*, and *restoring*.

First, let's look at how to *maximize* a window. Some programs, such as word processors and Web browsers, are easier to work with and fill the entire screen. To enlarge a window to fill your computer screen, click the Maximize button.

1. Click the WordPad window's **Maximize** button—the middle button in WordPad's titlebar.

The WordPad program maximizes, filling the entire screen. You can change a maximized window back to its original size by clicking the Restore button. The Restore button appears in place of the Maximize button whenever a window is already in a maximized state.



Maximize button



Restore button

2. Click the WordPad window's **Restore button to restore the WordPad window back to its previous size.**

The window returns to its previous size.

Just like you can keep several papers on top of your desk, Windows can run more than one program at a time. For example, you can work on a letter with your word processing program while your Web browser is open and downloading a file from the Internet. There is a potential pitfall with running several programs simultaneously though—there isn't enough room for all of them to fit on your computer screen!

Luckily, you can tuck programs away, keeping them running and ready for use, yet away from view, by *minimizing* them.

3. Click the WordPad window's **Minimize button to minimize the WordPad program.**

The WordPad program shrinks to an icon located in the Windows taskbar. WordPad is still open and running—it's just hidden from view, tucked away and ready for future use. It's important to note that minimized programs can still run in the background. If a program is doing something, such as downloading a file from the Internet, it will keep going, even when the program is minimized.

It's easy to redisplay a minimized program or window when you're ready to use it again.

4. Find and click the **WordPad icon in the Windows taskbar.**

The WordPad program springs back to life and appears on the screen.

It's important that you get all this maximize/minimize/restore stuff down, because it will help you be more productive with your computer.

Other Ways to Maximize and Restore a Window:

- Double-click the title bar of the window to toggle between maximized and restored states.



Minimize button

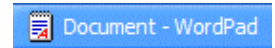

WordPad icon

 **Quick Reference**

To Maximize a Window:

- Click the window's **Maximize** button.

Or...

- Double-click the window's title bar.

To Restore a Maximized Window:

- Click the window's **Restore** button.

Or...

- Double-click the window's title bar.

To Minimize a Window:

- Click the window's **Minimize** button.

To Restore a Minimized Window:

- Click the window's **icon** on the taskbar.

Lesson 6-4: Closing a Window

Figure 6-9

Click the Close button on the window you want to close.

Figure 6-10

The window disappears from your screen.



Close button

Other Ways to Close a Window:

- Select **File** → **Exit** from the menu.
- Right-click the program's icon on the task bar and select **Close** from the shortcut menu.
- Press **<Alt> + <F4>**.

Quick Reference

To Close a Window:

- Click the window's **Close** button.

Or...

- Right-click the program's icon on the task bar and select **Close** from the shortcut menu.

Or...

- Press **<Alt> + <F4>**.

To Close All Open Windows:

- Hold down the **<Shift>** key while you click the **Close** button of any window.

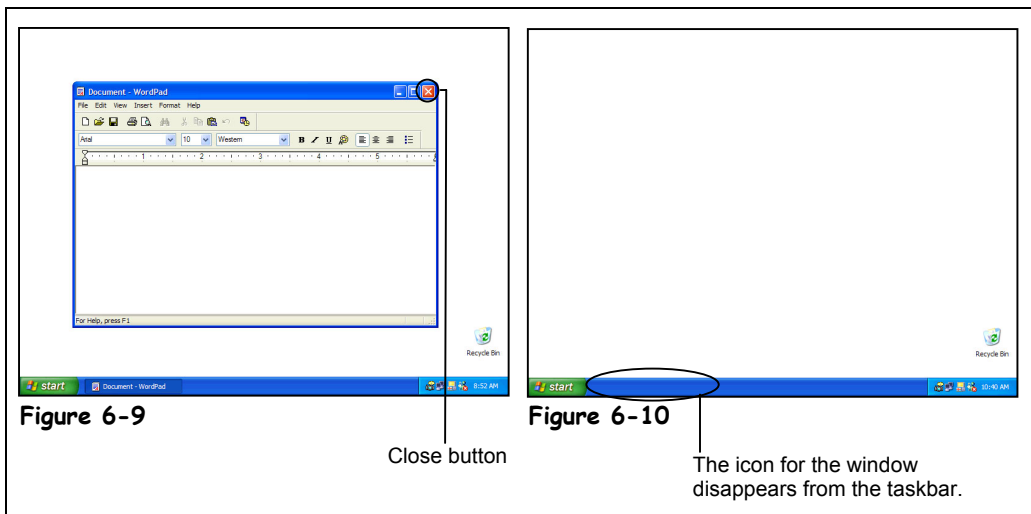

When you're finished working with a window or program, you can close it to remove it from the screen and computer's memory. You can close any window or program by clicking its Close button, which appears in the upper-right corner of the window.

1. Click the WordPad window's **Close** button.

The WordPad program closes. Notice the WordPad icon no longer appears in the Windows taskbar at the bottom of the screen. That's all there is to closing a window or program.

NOTE: If a program has more than one window open, you can close all of its open windows by holding down the **<Shift>** key when you click the Close button for any window.

Since you're going to be working with the WordPad program in the next few lessons, you will need to open it again.

2. Click the **Start** button.

The Windows XP Start menu appears.

3. Select **All Programs** → **Accessories** → **WordPad** from the Start menu.

The WordPad program reappears.

If a program happens to be minimized, you need to restore it by clicking its icon on the taskbar before you can see and click the window's close button.

Lesson 6-5: Moving a Window

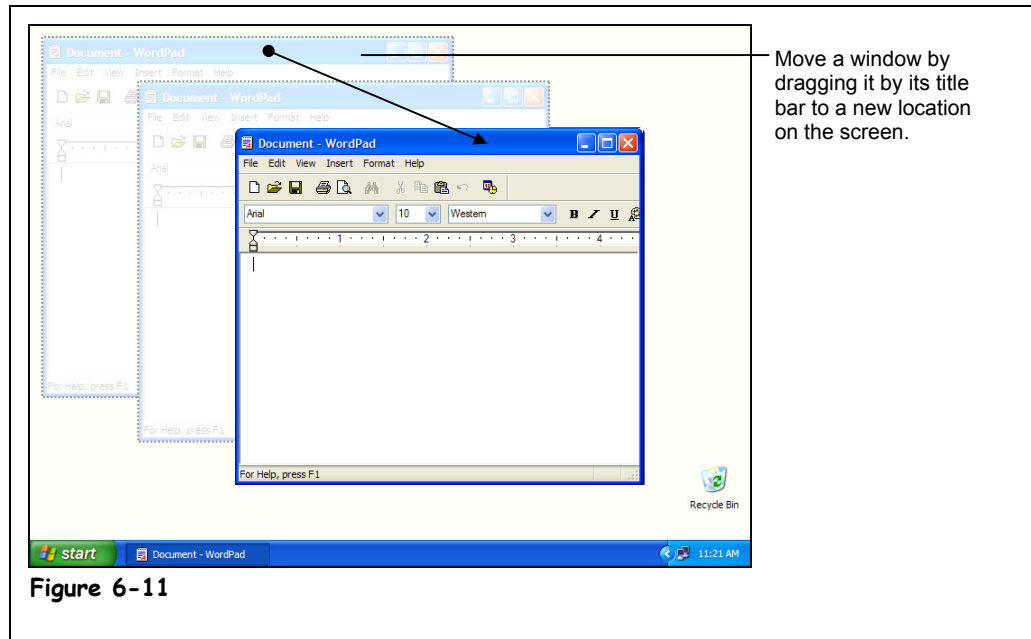

Figure 6-11

Moving a window to a new location on the screen

When you have several programs or windows open, you may find that one window covers the other windows or other items on your screen. When this happens, you can simply move a window to a new location on the screen—just like you would move a report or folder to a different location on your desk. Here’s how to move a window:

- 1. Position the mouse pointer over the **title** bar of the WordPad program.**
Remember that the title bar is the colored bar at the very top of a window or program. It displays the name of the program or window.
- 2. Click the **title** bar and move the mouse while still holding down the mouse button.**
Yep, it’s that drag and drop stuff you learned earlier. An outline of the window follows your mouse as you drag the window, as shown in Figure 6-11, showing you where you are moving it.
- 3. Release the mouse button to drop the window to a new location.**

Quick Reference

To Move a Window:

- Click and drag the window by its **title** bar. Release the mouse button to drop the window in the desired location on the screen.

Lesson 6-6: Sizing a Window

Figure 6-12

Dragging a window's edge or corner changes the size of the window.

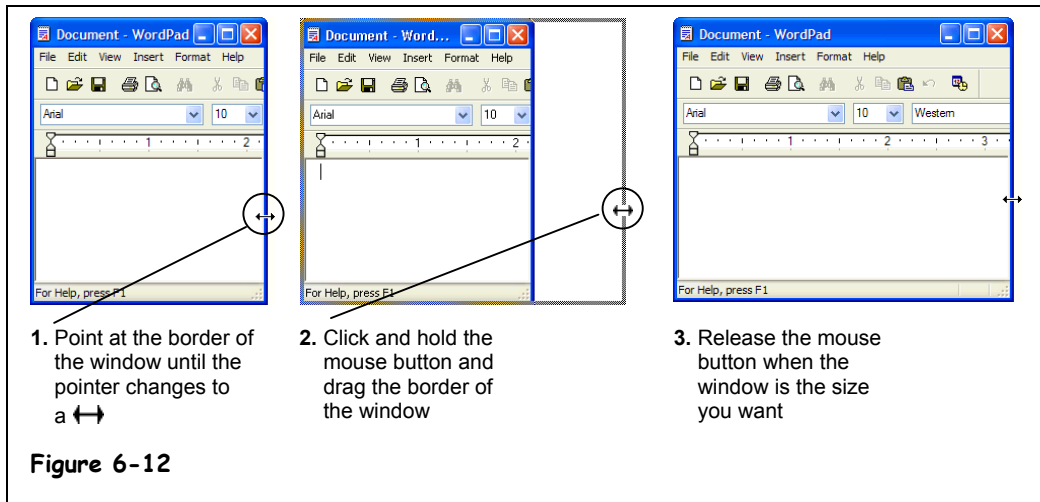

If you've been following the lessons in this chapter, you should already know how to change the size of a window or program by minimizing, maximizing, and restoring it. This lesson explains how you can fine-tune the size of a window to meet your own specific needs.



The mouse pointer changes shapes over the border of a window.

- 1. Make sure the WordPad program appears as a window and doesn't fill the entire screen.**
A window doesn't have to be maximized (fill up the entire screen) or minimized (appear only as a button on the Taskbar) if you want to manually size it.
- 2. Position the mouse pointer over the right border of the WordPad window until it changes to a \leftrightarrow .**

The two arrows point in the directions that you can drag the window's border, in this case, left or right. Had you positioned the pointer over the top or bottom of the window, the pointer would have changed to a \updownarrow , indicating that you could drag the top or bottom of the window up or down.

NOTE: Windows is very picky where you place the pointer, and sometimes it can be tricky finding the exact spot where the pointer changes. It's there—just move the pointer slowly over the border until you find it.

- 3. Click and hold down the left mouse button and drag the mouse to the right 1 inch to move the window border.**
Notice that the window stretches as you drag the mouse. When the window is the size you want, you can release the mouse button.
- 4. Release the mouse button.**
The window is displayed in its new size.

This lesson explained how to resize a window by adjusting the right border of a window, but you can change a window's size by dragging its left, top, and bottom borders. You can also resize a window by dragging its corners just like you drag its borders.

 Quick Reference**To Change a Window's Size:**

1. Point at the window's borders or corners until the pointer changes to a double-arrow (like )
2. Click and hold down the mouse button and drag the border or corner to a new location, until the window is the size you want.

Lesson 6-7: Switching Between Windows

Figure 6-13

You can only work in one window at a time. Notice that WordPad appears in front of all other windows and has a blue title bar.

Figure 6-14

Click any part of the Calculator window or its button on the taskbar so that it appears in front of all the other windows.

Figure 6-15

Pressing <Alt> + <Tab> lists all the programs that are currently running.

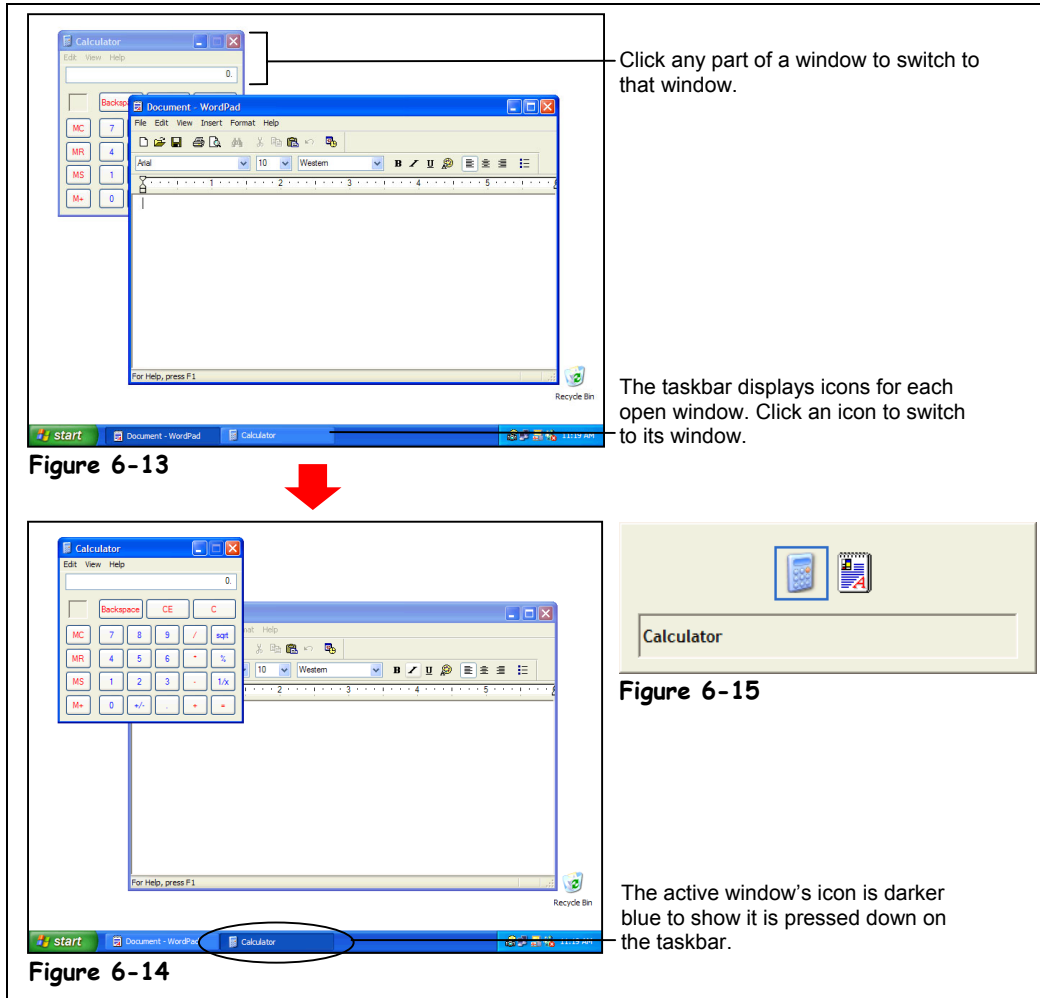

Click any part of a window to switch to that window.

The taskbar displays icons for each open window. Click an icon to switch to its window.

Figure 6-15

The active window's icon is darker blue to show it is pressed down on the taskbar.

You can have several programs or windows open and running simultaneously, but you can only *work* in one window at a time. The window you're working with is called the *active window* and always appears on top of any other windows that you have open. If you think about it, you do the same thing when you work at your desk. When you want to work on a piece of paper, you place it on top of everything else on your desk.

This lesson explains how to switch between the programs you're running. There are actually several ways to switch between windows, and we'll cover all of them in this lesson. First, you need to make sure you have several programs running...

1. Make sure the WordPad program is still open.

If it isn't open, click the Start button and select All Programs → Accessories → WordPad. Notice an icon for the WordPad program appears on the taskbar. Next, you need to open another program that comes with Windows XP—the calculator.

2. Start the calculator by clicking the **Start button and selecting **All Programs** → **Accessories** → **Calculator**.**

The calculator program appears in front of the WordPad program. An icon for the Calculator program also appears in the taskbar, next to the WordPad icon. Notice the Calculator program appears in front, and its icon is depressed on the taskbar, which indicates it is the active window. You can make WordPad the active window by clicking its icon on the taskbar.

3. Click the **WordPad button on the taskbar.**

The WordPad program appears in front, and its icon on the taskbar is depressed, which indicates it is the active window. You can make another open window the active window by clicking on any visible part of the window.

4. Click any portion of the **Calculator window.**

If you can't see the Calculator window at all, it's because the Calculator window is completely covered by the WordPad window. In this case, you will have to click the Calculator icon on the taskbar.

Yet another method of switching between windows is the most famous keystroke combination in Windows: <Alt> + <Tab>.

5. Press and hold down the **<Alt> key, press and release the **<Tab>** key, but don't release the **<Alt>** key.**

The task window appears, as shown in Figure 6-15. The task window lists all the windows and programs that are currently running. Move on to the next step to see how you can retrieve a program or window from the task list.

6. While still holding down the **<Alt> key, press and release the **<Tab>** key until the **WordPad** program is selected, then release the **<Alt>** key.**

When you release the <Alt> key, the selected window or program is activated and displayed in front of any other windows.

NOTE: <Alt> + <Tab> is especially useful when you use programs that fill the entire computer screen, such as MS-DOS programs and some games. When you can't see the taskbar or any part of another window, <Alt> + <Tab> is the only way you can switch between programs.

NOTE: When you're working with multiple programs, be careful not to accidentally run a second copy of the same program. This wastes memory and makes things confusing. For example, if you've been using the Calculator program and want to bring it back up, make sure you check the taskbar to see if it's already running (a Calculator icon appears on the taskbar). If it is, use any of the methods you've learned in this lesson to switch to it. If a program is already running and you load it again from the Start menu, a second copy of the program opens and two icons for the program will appear on the taskbar.

Think you have a handle on switching between programs and windows? Good, because when you work with Windows, you'll find yourself switching between programs and windows throughout the day.

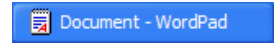

WordPad button on the taskbar

 **Quick Reference**

To Switch between Open Programs:

- Click the program's icon on the taskbar.

Or...

- Click on any part of the window you want to appear in front.

Or...

- Press and hold down the **<Alt>** key and press the **<Tab>** key to display the task list. Press the **<Tab>** key until the program you want is selected, then release the **<Alt>** key.

Chapter Six Review

Lesson Summary

Starting a Program

- Start a program by clicking the **Start** button, clicking the **All Programs** menu, clicking the menu and any submenus where the program you want to run is located, and clicking the name of the program you want to run.

Understanding the Parts of a Window

- Be able to identify a window's title bar, menu, minimize, maximize, and close buttons.

Minimizing, Maximizing, and Restoring a Window

- Maximize a window so that it fills the entire screen by clicking its **Maximize** button, or by double-clicking its title bar.
- Restore a window to its previous size by clicking its **Restore** button, or by double-clicking its title bar.
- Minimize a window so that it only appears as an icon on the taskbar by clicking the window's **Minimize** button.
- Restore a minimized window by clicking its icon on the taskbar.

Closing a Window

- Close a window by clicking its **Close** button, or by pressing **<Alt> + <F4>**.
- Close all open windows by holding down the **<Shift>** key while you click the **Close** button of any window.

Moving a Window

- **To Move a Window:** Click and drag the window by its title bar. Release the mouse button to drop the window in the desired location on the screen.

Sizing a Window

- **To Change a Window's Size:** Point at the window's borders or corners until the pointer changes to a double-arrow (like **↔**). Click and hold down the mouse button and drag the border or corner to a new location until the window is the size you want.

Switching between Windows

- You can only work on one window at a time. The window you're working on is the active window and appears in front of all the inactive windows.

- **To Switch between Open Programs:** There are three ways to switch between open programs:
 1. Click on the program's icon on the taskbar.
 2. Click on any visible part of the window that you want to appear in front.
 3. Press and hold down the <Alt> key and press the <Tab> key to display the task list. Press the <Tab> key until the program you want is selected, then release the <Alt> key.

Quiz

- 1. To start a program in Windows XP, do the following:**
 - A. Make sure the Program Manager is open, double-click the Program Group where the program you want to run is located, and double-click the Program.
 - B. Click the Start button, point to the All Programs menu, click the menu and any submenus where the program you want to run is located, and click the name of the program you want to run.
 - C. Click the Start button, point to the Run menu, click the menu and any submenus where the program you want to run is located, and then click the name of the program you want to run.
 - D. None of the above.
- 2. The little bar that lists a program's name and is found at the top of a window is called the:**
 - A. Windows bar.
 - B. Program bar.
 - C. Title bar.
 - D. Very top of the window bar.
- 3. You start your favorite word processing program to type a letter, but the program appears in a window that's too small to use. How can you maximize the window so it fills the entire screen? (Select all that apply.)**
 - A. Select Window → Full Screen from the menu.
 - B. Double-click the window's Title bar.
 - C. Click the program's icon on the taskbar.
 - D. Click the Maximize button located in the right side of the window's Title bar.
- 4. You can open or restore a minimized window by clicking its icon on the taskbar. (True or False?)**
- 5. You can move a window to a different position on your computer screen by dragging it by its:**
 - A. Title bar.
 - B. Status bar.
 - C. Move handle.
 - D. Tail.

- 6. You have several programs open at the same time—how can you switch between these programs? (Select all that apply.)**
- A. Restart the program—Click the Start button, point to the All Programs menu, click the menu and any submenus where the program you want to switch to is located, and click the name of the program you want to view.
 - B. Click the program's icon on the taskbar.
 - C. Click on any visible part of the window you want to appear in front.
 - D. Press and hold down the <Alt> key and press the <Tab> key to display the task list. Press the <Tab> key until the program you want is selected, then release the <Alt> key.

Homework

- 1. Click the Start button, select All Programs, and click the Accessories menu.
- 2. Start the NotePad program (located under All Programs → Accessories).
- 3. Make the NotePad window a few inches bigger.
- 4. Maximize the NotePad window.
- 5. Restore the NotePad window to its previous size.
- 6. Move the NotePad window to a different location on the screen.
- 7. Open the Calculator program.
- 8. Tile both windows on the screen by right-clicking a blank area of the taskbar.
- 9. Close both windows.

Quiz Answers

- 1. B.
- 2. C. The little bar along the window's top that lists the program name is the Title bar.
- 3. B and D. Double-clicking the window's Title bar or clicking the window's Maximize button will maximize the window so it fills the entire screen.
- 4. True. Clicking the icon of a minimized program on the taskbar restores the window.
- 5. A. Move a window by dragging its Title bar.
- 6. B, C, and D. You can use any of these methods to switch between open programs. Don't use A, which starts another copy of the program instead of switching to the already open program.

Chapter Seven: Working with Programs

Chapter Objectives:

- Use menus and toolbars
- Fill out a dialog box
- Enter and edit text
- Save and open a file
- Select, replace, and delete text
- Use the undo function
- Print a file
- Cut, copy, and paste text
- Format fonts and paragraphs
- Get help
- Save and Open Files in Different Locations

Prerequisites

- How to start and shut down Windows
 - How to use the mouse to click, double-click, drag and drop, and right-click
 - How to use the keyboard
-

Up until now, we've only been focusing on how to use the Windows XP operating system. In this chapter, you'll be working with a program. This chapter explains how to control programs using menus and toolbars. You'll learn what a *dialog box* is (you'll see a lot of them in Windows), and how to fill one out.

Next, we'll get more specific. Every program is different, but the procedure for doing things in all programs is the same. This chapter explains these basic generic chores using the WordPad program. You'll learn how to enter, edit, and delete text; how to open, save, and print a file; and how to get help when you need it. Once you've learned these basic skills in WordPad, you can apply them to just about every other Windows program. This is one of the longest chapters about Windows XP, so we have a lot of ground to cover. Let's get started...

Lesson 7-1: How to Use Menus

Figure 7-1

Starting the WordPad program.

Figure 7-2

The Insert menu

Figure 7-3

The Insert Date and Time dialog box

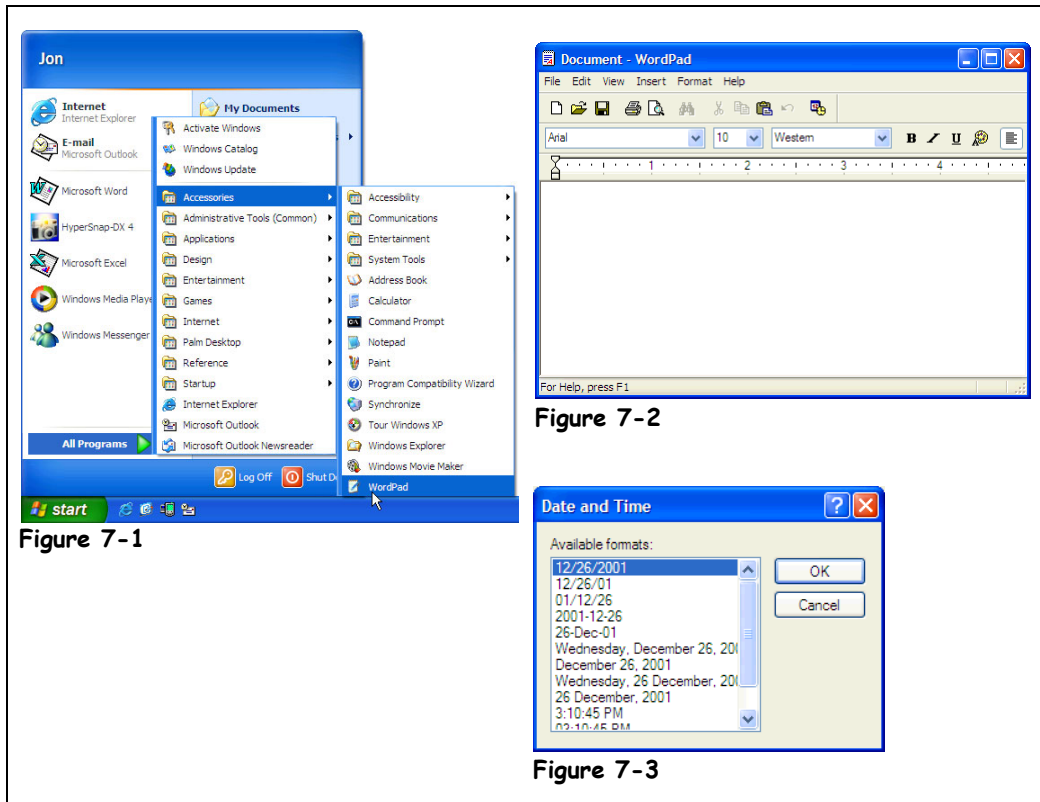

To make a program do your bidding, you give it commands. You can give commands to your Windows program in several different ways: by using menus, toolbars, right-mouse button shortcut menus, and keystroke shortcuts. This lesson explains the most common method of issuing commands to Windows programs—through *menus*. You can find a program's menu near the top of a window, just beneath the title bar. In Figure 7-2, notice the words File, Edit, View, Insert, Format, and Help that appear near the top of the WordPad program. Those words are menus, and the next few steps will show you why're there.



Start button

1. **Click the **Start** button.**
The Start menu appears.
2. **Select **All Programs** → **Accessories** → **WordPad** from the Start menu.**
That means you should click “All Programs”, then click the word “Accessories” from the All Programs menu, and then click the word “WordPad” from the Accessories menu, as shown in Figure 7-1. The WordPad program appears.
3. **Move the pointer to and click the word **Insert** on the menu bar, as shown in Figure 7-2.**

A menu drops down under the word Insert, as shown in Figure 7-2. The Insert menu contains a list of commands to insert things, such as the “Date and Time”, which inserts the current date and/or time, and “Object”, which inserts a file created in another program.

4. Under the Insert menu, point to and click the **Date and Time option.**

The Date and Time dialog box appears, as shown in Figure 7-3, presenting you with several different date and time formats you can insert. You'll learn more about dialog boxes in an upcoming lesson.

5. Click the **OK button.**

The Date and Time dialog box disappears and the current date is inserted into the WordPad document. Take a close look at the WordPad menu—notice how every word in the menu has an underlined letter somewhere in it? For example, the F in the File menu is underlined. Pressing the <Alt> key and then pressing the underlined letter in a menu does the same thing as clicking the menu with the mouse.

6. Press the <Alt> key then press the <F> key.

The File menu appears. Once a menu is open, you can use the arrow keys on your computer's keyboard to navigate through the menus, or press any other underlined letters in the menu.

7. Press the Right Arrow Key <→>.

The next menu to the right, the Edit menu, opens. If you opened a menu and change your mind, it's easy to close it without selecting any commands. Just click anywhere *outside* the menu or else press the <Esc> key.

8. Click anywhere outside the menu to close the menu without selecting any commands.

NOTE: The procedure for using menus and the general order/layout of the menu is usually similar in most Windows programs. So if you master the menus in one Windows program, you will be somewhat familiar with the layout and function of the menus in other Windows programs.

Table 7-2: *Common Windows Program Menus* Table gives you a preview of some of the different menu items you will come across.

Table 7-2: Common Windows Program Menus

File	Description
File	Commands to open, save, close, print, and create new files
Edit	Commands to copy, cut, paste, find, and replace text in a document
View	Commands to change how the document is displayed on the screen
Insert	Lists items that you can insert into a document, such as graphics, page numbers, and the current date
Format	Commands to format text, paragraphs, tab stops, etc. Strangely, the command to format the page (i.e. margins, etc.) is located in the <u>F</u> ile menu under Page <u>S</u> etup.
Window	Commands to display and arrange multiple windows (if you have more than one document open). WordPad doesn't have this option since it can only have one file open at a time.
Help	Get help on the Windows program you are using

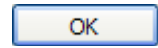
**OK button**

You can open menus by clicking the menu name with the mouse or by pressing the <Alt> key and the underlined letter in the menu name.

You can close a menu without selecting any commands by clicking anywhere outside the menu or by pressing the <Esc> key.

Quick Reference**To Open a Menu:**

- Click the menu name with the mouse.

Or...

- Press <Alt> and then the underlined letter in menu.

Lesson 7-2: How to Use Toolbars

Figure 7-4

Move the pointer over a button and wait a few seconds for the button's description.

Figure 7-5

The Date and Time dialog box

Figure 7-6

The updated WordPad document

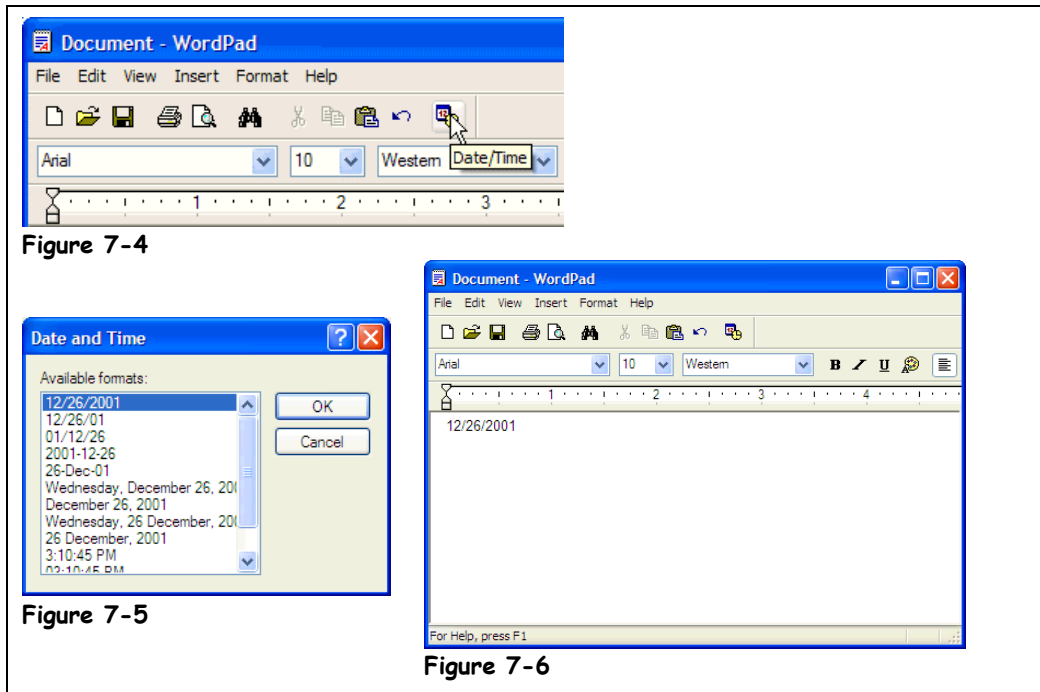

Toolbars are another common way to boss your programs around. While menus contain every conceivable command for a program, toolbars contain buttons only for the commands you use most frequently. Instead of having to wade through several menus to do something, you can click a single button. Two toolbars appear in the WordPad program—the *Standard toolbar* and *Formatting toolbar*. The *Standard toolbar* appears on top and contains buttons for the most frequently used commands in WordPad, such as saving and printing a document. The *Formatting toolbar* is located right underneath the *Standard toolbar* and has buttons for quickly formatting fonts and paragraphs.

Toolbar buttons have small icons to indicate what they do. For example, a small picture of a printer appears on the Print button. If you still don't know what a button is used for, move the pointer over the button and wait a few seconds. Usually, a little window will appear with a brief description of the button.

1. Click after the date you entered in the last lesson and press the **<Enter>** key to add a blank line.
2. Position the mouse pointer over the **Date/Time** button on WordPad's **Standard toolbar**, as shown in Figure 7-4.

A small window appears over the button, briefly identifying what the button is—in this case "Date/Time" as shown in Figure 7-4.

3. Click the **Date/Time** button.

The Date and Time dialog box appears, as shown in Figure 7-5, presenting you with several different date and time formats to insert.



Date/Time button

4. Click the OK button.

WordPad inserts the current date and time in the WordPad document.

5. Backspace over the date you just entered to delete it.

Only one date remains on your screen. You will learn more about deleting text in a later lesson.

Compare your screen with the one in Figure 7-6.

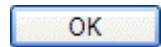

OK button

 **Quick Reference****To Use a Toolbar Button:**

- Click the toolbar button.

To See What a Toolbar Button Does:

- Position the pointer over the toolbar button and wait a second. A ScreenTip will appear above the button.

Lesson 7-3: Filling Out a Dialog Box

Figure 7-7

The Font dialog box

Figure 7-8

A Scroll Bar

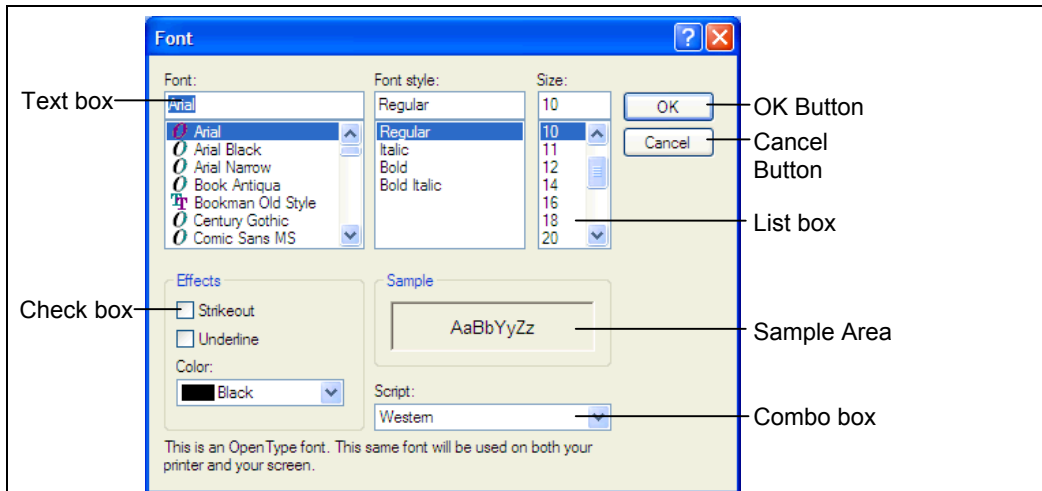

Figure 7-7

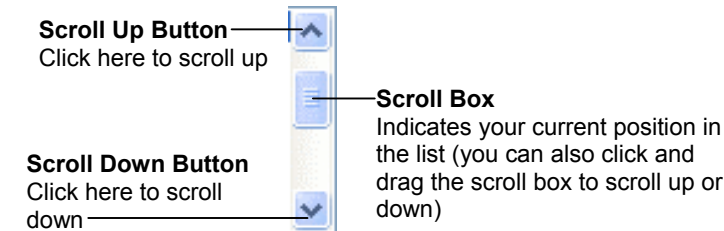
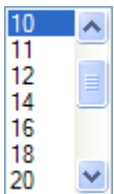

Figure 7-8

You can select a control in a dialog box by clicking the control with the mouse or by pressing the <Tab> key until the control is selected.

Type Text Here

Text Box



List Box

Some commands are more complicated than others are. For example, saving a file is a simple process—all you have to do is select File → Save from the menu or click the Save button on the Standard toolbar. Other commands are more complex. Whenever you want to do something relatively complicated in Windows, you need to fill out a *dialog box*. Filling out a dialog box is not much different than filling out a paper form. Dialog boxes usually contain several types of controls, including:

- Text boxes
- List boxes
- Check boxes
- Combo boxes (also called drop down lists)
- Buttons

This lesson will give you a quick tour of a more complicated dialog box and show you how to use the various dialog box components you will come across.

1. Select **Format** from the menu.

The Format menu appears. Look at the items listed in the Format menu—Font, Paragraph, and Tabs are followed by ellipses (...). Whenever you see a menu item followed by ellipses, it means that there is a dialog box lurking just behind the menu.

2. Select **Font** from the Format menu.

The Font dialog box appears, as shown in Figure 7-7. The Font dialog box is one of the most complex dialog boxes in the WordPad program and contains several types of components you can fill out. You have to go to, or select, a control before you can use it. You can do this by clicking the control with the mouse or by pressing the <Tab> key to move to the next control, or <Shift> + <Tab> to move to the previous control, until the blinking cursor appears in it or it becomes highlighted.

First, let's look at text boxes. Look at the Font text box, as shown in Figure 7-7. Text boxes are the most common component of a dialog box and are nothing more than the fill-in-the-blank box you've undoubtedly already used in many types of paper forms. Text boxes are incredibly easy to use—just select and type in the text you want.

3. Make sure the Font text box is selected and type **Arial**.

You've just filled out the text box—nothing to it. The next stop in our dialog box tour is the *List Box*. You can find a list box directly beneath the Font text box. A list box puts several options together into a small box. Sometimes list boxes contain so many options that they can't all be displayed at once, and you must click the list box's *scroll bar* to move up or down the list. See Figure 7-8 for an illustration of a scroll box.

4. Click and hold the **Font list box's Scroll Down** button until **Times New Roman** appears in the list.

5. Click the **Times New Roman** option in the list.

Our next destination is the *Combo Box*. The combo box is the cousin of the list box—it, too displays a list of options. The only difference is that you must click the combo box's downward pointing arrow in order to display its options.

6. Click the **Color combo box's down arrow**.

A list of color options appears below the Color combo box.

7. Select the **Blue color** from the combo box.

Sometimes you need to select more than one item in a dialog box. For example, what if you want to add Strikeout formatting *and* Underline formatting to the selected font? You use the *check box* control when you're presented with multiple choices.

8. In the Effects section, click the **Strikeout** check box and click the **Underline** check box.

The last destination on our dialog box tour is the *Button*. Buttons are used to execute or cancel commands. Two buttons can be found in every dialog box. They are:

- **OK:** Applies and saves any changes you have made and then closes the dialog box. Pressing the <Enter> key usually does the same thing as clicking the OK button.
- **Cancel:** Closes the dialog box without applying and saving any changes. Pressing the <Esc> key usually does the same thing as clicking the cancel button.

9. Click the **Cancel** button to cancel the changes you made and close the Font dialog box.

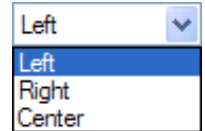

**Combo Box
or Drop-Down List**



Check Box

Quick Reference

To Select a Dialog Box Control:

- Click the control with the mouse.

Or...

- Press <Tab> to move to the next control in the dialog box or <Shift> + <Tab> to move to the previous control until you arrive at the desired control.

To Use a Text Box:

- Simply type the information directly into the text box.

To Use a List Box:

- Click the option you want from list box. Use the scroll bar to move up and down through its options.

To Use a Combo Box (or Drop-Down List):

- Click the Down Arrow to list the combo box's options. Click an option from the list to select it.

To Save Changes and Close a Dialog Box:

- Click the **OK** button or press <Enter>.

To Close a Dialog Box without Saving Changes:

- Click the **Cancel** button or press <Esc>.

Lesson 7-4: Entering Text in the WordPad Program

Figure 7-9

A simple letter created in the WordPad program

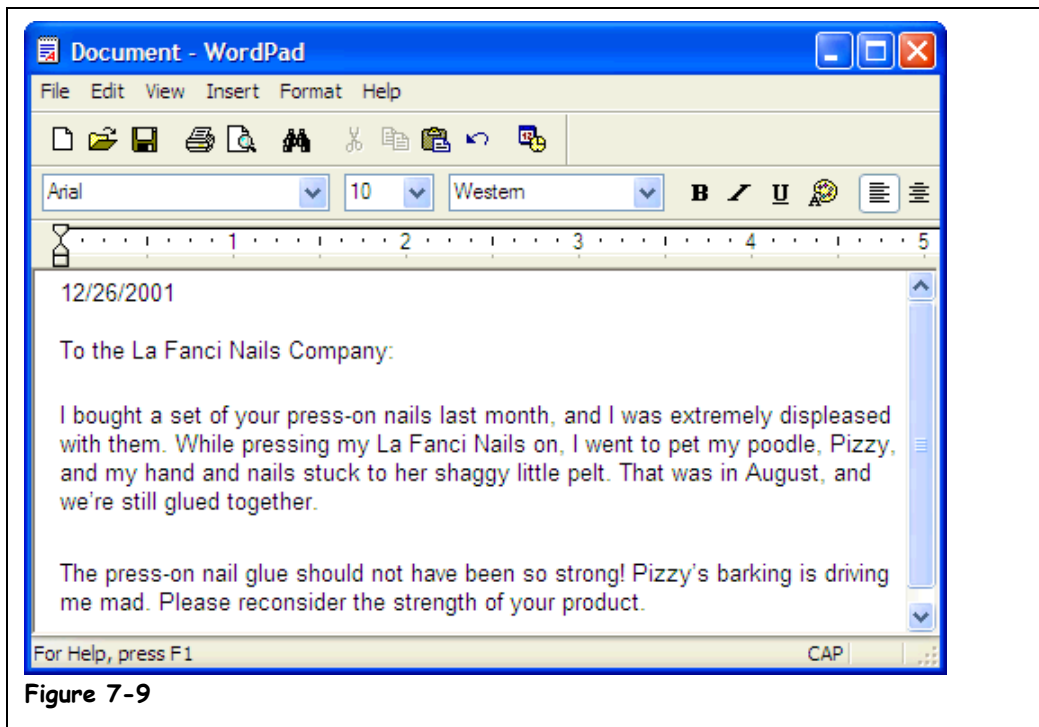

Figure 7-9

This lesson explains how to create a document using the WordPad program. Actually, there isn't much to explain—all you have to do is type!



Start button

1. **Open WordPad by clicking the **Start** button, then **All Programs**, **Accessories**, and then **WordPad**.**
The WordPad Program screen pops up. Let's enter some text.
2. **Click inside the WordPad screen, and type the following text: 9/29/01**
Good. Now we're going to write a letter.
3. **Press the **<Enter>** key twice.**
WordPad inserts a new paragraph, or new line, each time you press the **<Enter>** key.
4. **Type the following text: To the La Fanci Nails Company:**
As you type, notice that the insertion point (the small, blinking vertical bar) moves to indicate where you are typing.
5. **Press the **<Enter>** key twice, and type the follow text: I bought a set of your press-on nails last month, and I was extremely displeased with them. While pressing my La Fanci Nails on, I went to pet my poodle, Pizzy, and my hand and nails stuck to her shaggy little pelt. That was in August, and we're still glued together.**

The press-on nail glue should not have been so strong!
Pizzy's barking is driving me mad. Please reconsider the
strength of your product.

Make sure you press the <Enter> key twice to add a blank line between the two paragraphs. Don't press <Enter> when you reach the end of a line—WordPad will automatically move the text to the next line for you. This feature is called *word-wrap*.

When you're finished typing, compare your letter with the one in Figure 7-9.

While you type, word-wrap continues text from one line to the next without making you press Enter.

 **Quick Reference**

To Open WordPad:

- Click on the **Start** button, then **All Programs**, **Accessories**, then **WordPad**.

To Enter Text in WordPad:

1. Place the insertion point in WordPad by clicking in the WordPad screen.
2. Type your text.

Lesson 7-5: Editing Text

Figure 7-10

Use the keyboard or the mouse to move the insertion point in a document.

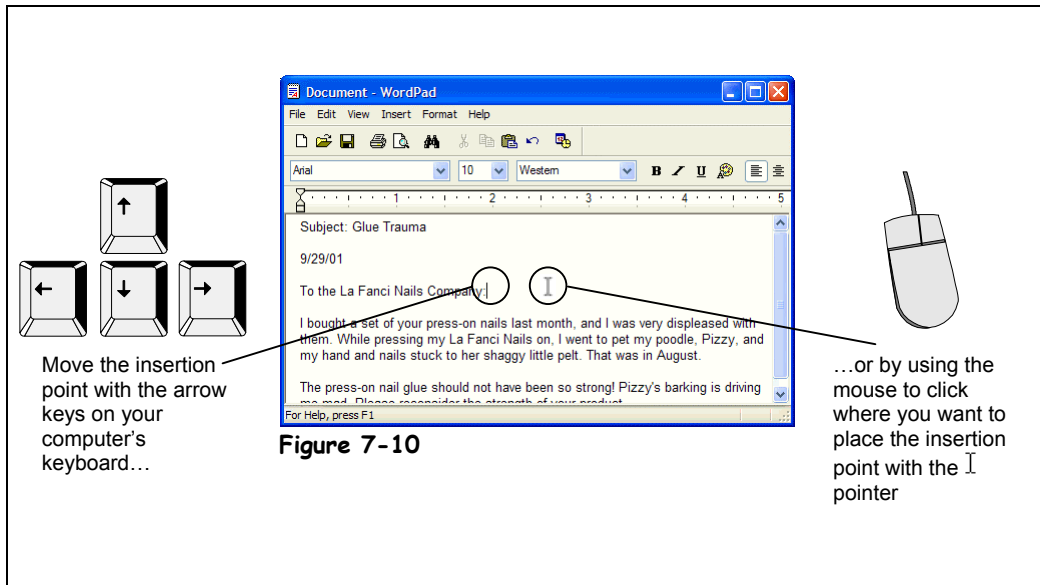

After typing a document, you will often discover that you need to make some changes to your text—perhaps you want to rephrase or even delete a sentence. Editing a document by inserting and deleting text is very simple. To insert text, you move the insertion point (the blinking bar) to where you want to insert the text. You move the insertion point using the arrow keys on the keyboard or by using the mouse to click where you want to move it, as shown in Figure 7-10. Once the insertion point is where you want, just start typing.

There are a couple ways to delete text. One way to delete text is to place the insertion point to the *left* of the text you want to delete and press the <Backspace> key. Another way to delete text is to place the insertion point to the right of the text you want to delete and press the <Delete> key.

In this lesson, you'll get practice inserting and deleting text and revising the letter you created in WordPad.

1. **Press the Up Arrow Key <↑> button.**
The insertion point moves up one line.
2. **Press and hold the Up Arrow Key <↑> to move the insertion point to the very top line in the document.**
Now you need to move the insertion point to the beginning of the current line.
3. **Press and hold the Left Arrow Key <←> button to move the insertion point to the very beginning of the line.**
4. **Type `Subject: Glue Trauma` and press <Enter> twice.**
The text and blank line is inserted at the insertion point, before the rest of the document. You've just learned how to insert text in a document—pretty easy huh?
5. **Move the insertion point immediately *after* the word **extremely** in the first body paragraph.**
Here, you need to delete some text; delete the word “extremely.”

Thank you for your interest available until July 31.

Placing the insertion point

6. Press the **<Backspace>** key several times, until the word “extremely” is deleted.

The Backspace key deletes one space to the left (backwards) of the insertion point.

7. Type *very*.

You’ve just deleted the word “extremely” and inserted the word “very” to take its place.

You can also use the mouse to move the insertion point instead of the arrow keys.

Simply move the  pointer where you want to place the insertion point with the mouse and click.

8. Click immediately after the word **August** in the sentence “That was in August, and we’re still stuck together” with the  pointer.

The insertion point appears immediately after the word “August”—right where you clicked the mouse button.

You can also use the Delete key to delete text. Like the Backspace key, the Delete key also deletes text, but in a slightly different way. The Backspace key deletes text before, or to the *left* of the insertion point, while the Delete key deletes text after, or to the *right* of the insertion point.

9. Press the **<Delete>** key.

The Delete key deletes text after, or to the right of, the insertion point.

10. Press and hold the **<Delete>** key until you have deleted the rest of the sentence “, and we’re still stuck together”.

Great! You’ve learned how to delete text using the Delete key.

Compare your revised document with the one shown in Figure 7-10.



The **<Backspace>** key deletes one space to the left, or behind, the insertion point.



The **<Delete>** key deletes once space to the right, or after, the insertion point.

Quick Reference

To Move the Insertion Point:

- Use the arrow keys.

Or...

- Click where you want to place the insertion point with the  pointer.

To Insert Text:

- Move the insertion point where you want to insert the text and then type the text you want to insert.

To Delete Text:

- The **<Backspace>** key deletes text before, or to the left of the insertion point.
- The **<Delete>** key deletes text after, or to the right of the insertion point.

Lesson 7-6: Saving and Opening a File

Figure 7-11

The Save As dialog box

Figure 7-12

The Open dialog box

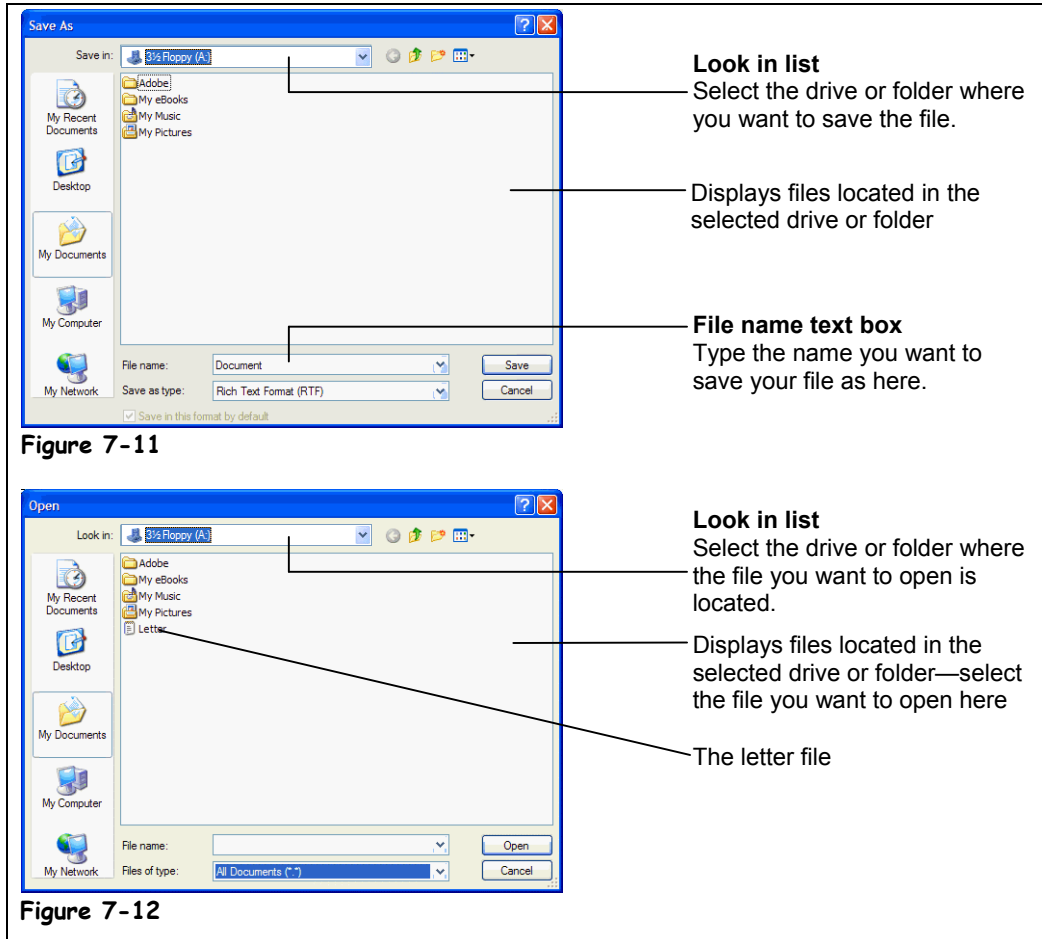

Figure 7-11

Figure 7-12



Save button

Other Ways to Save:

- Select **File** → **Save** from the menu.

Once you have created something in a program, you must *save* the file if you ever want to use it again in the future. When you save a file, you're transferring it from your computer's memory (which is erased when you close the program) to the computer's local disk (which is permanent and not erased when you close the program). In this lesson, you will learn how to save a file and then open, or retrieve it from the local disk.



1. Click the Save button on the Standard toolbar.

The Save As dialog box appears, as shown in Figure 7-11. You must give your file a name and specify where you want to save it. First, tell the computer you want to save the file in your Practice folder.

2. Navigate to and open your practice folder or floppy disk.

Your computer stores information in files and folders, just like you store information in a filing cabinet. To open a file, you must first find and open the folder where it's saved.

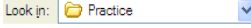
The Save dialog box has its own toolbar that make it easy to browse through your computer's drives and folders. Two controls on this toolbar are particularly helpful:

-  **Look In List:** Click to list the drives on your computer and the current folder, then select the drive and/or folder whose contents you want to display.
-  **Up One Level button:** Click to move up one folder.

If necessary, follow your instructor's directions to select the appropriate drive and folder where your practice files are located.

Next, you need to give your file a name.

3. Click the **File name** text box.

The File name box is where you give your file a name.

NOTE: Filenames can be up to 255 characters long and contain letters, numbers, and some symbols. You can't use the symbols " \ / : * | < > in a file name.

4. Type **Letter** in the File name text box.

This will save the document you created in a file named "Letter" in the floppy disk.

5. Click **Save** to save your document to the floppy disk.

The floppy disk hums as your computer saves the Letter file to it.

NOTE: You can also save any files you've created to your computer's local disk—which is normally where most people save their files, instead of a floppy disk.

Now that you've saved the file to a disk, you can safely close WordPad or even turn off the computer, knowing that your WordPad "Letter" file is stored and can be retrieved whenever you want to work on it again.

6. Close the WordPad program by clicking its **Close** button.

The WordPad program closes. Now, make sure the Letter document you created and saved in WordPad is still there.

7. Start the WordPad program again.

Once you have started WordPad, you will need to open the Letter document you saved.

8. Click the **Open** button on the Standard toolbar.

The Open dialog box appears, as shown in Figure 7-12. The Open dialog box is very similar to the Save dialog box—except you specify the name and location of the file you want to open.

9. If necessary, navigate to your practice folder or floppy disk.

The Open dialog box will display any WordPad files that have been saved in the practice folder or floppy disk. Here's how to select a file you want to open.

10. Click the **Letter** file.

Shading appears over the Letter file, indicating it is selected.

11. Click the **Open** button to open the selected file.

The Letter document appears in the WordPad window.

When you open a file, instead of selecting a file and clicking the Open button, you can save a half-second or so by simply double-clicking the file you want to open.



Close button



Open button

Other Ways to Open a File:

- Select **File** → **Open** from the menu.

Quick Reference

To Save a File:

- Click the  **Save** button on the Standard toolbar.

Or...

- Select **File** → **Save** from the menu.

To Open a File:

- Click the  **Open** button on the Standard toolbar.

Or...

- Select **File** → **Open** from the menu.

Lesson 7-7: Selecting, Replacing, and Deleting Text

Figure 7-13

You can select and replace text.

Figure 7-14

The updated letter

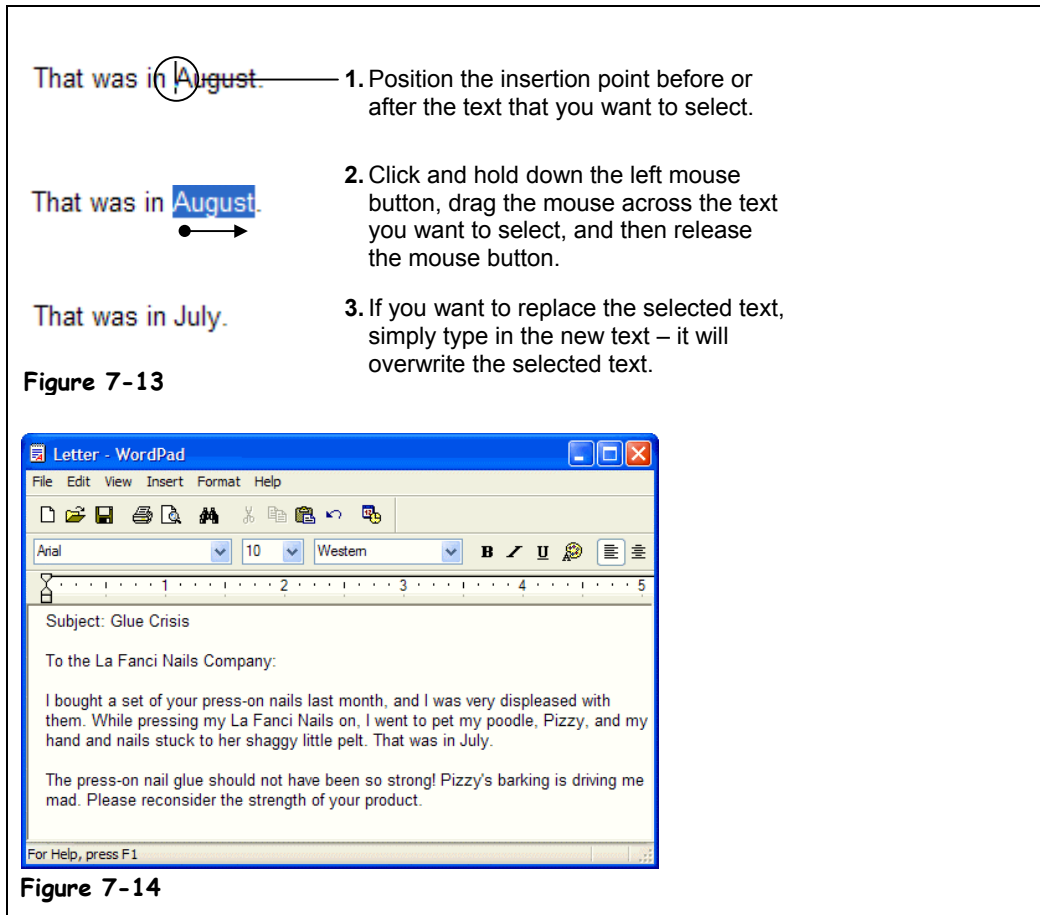

Figure 7-14

This lesson explains how to select text. Whenever you want to edit more than one character at a time, you must *select* it first. A lot of editing and formatting techniques—such as formatting, cutting, copying, and pasting text—also require that you select the text you want to modify. There are probably hundreds of reasons to select text in many Windows-based programs, so it pays if you're an expert at doing it.

To replace text, select the text you want to replace and type the new text you want to replace it with.

1. **Place the insertion point immediately in front of the word **August** in the first body sentence of the paragraph.**
You learned how to move the insertion around using the mouse earlier in this chapter. Actually, you can place the insertion point before or after the text you want to select.
2. **Click and hold down the mouse button and drag the mouse across the word **August** (the words should be highlighted). Release the mouse button when you're finished.**

The word August should be highlighted in blue, as shown in Figure 7-13. Selecting text with the mouse can be a little tricky at first, especially if you're still a novice at using the mouse. When you select text, anything you type will replace the selected text.

3. Type July.

The word “July” replaces the selected text, “August.” A quick way to select a single word is to double-click the word you want to select.

4. Double-click the word Trauma in the Subject line.**5. Type Crisis.**

The word Crisis replaces the word Trauma. You can also use the keyboard to select text if you don’t like using the mouse. To select text using the keyboard, move the insertion point before or after the text you want to select, press and hold down the <Shift> key while you use the arrow keys to select the text.

6. Move the insertion point to the very end of the Subject: Glue Crisis line.

Try selecting text with the keyboard in the next step.

7. Press and hold down the <Shift> key and press and hold down the left arrow key <←> until the Subject line is selected.

If you change your mind after selecting text, it’s easy to deselect it. Just click anywhere else on the screen.

8. Click anywhere in the document to deselect the text.

The Subject line is no longer selected.

Another trick you should know is that you can delete any selected text by pressing the <Delete> key.

9. Select the date and press the <Delete> key.

The date is deleted.

And that’s all there is to selecting text in Windows. Again, it’s very important that you know how to select text. Knowing how to select text will make you much more proficient at using many Window programs.

Double-click a word to select it.

Other Ways to Select Text:

- Move to the beginning or end of the text that you want to select, press and hold down the <Shift> key while using the arrow keys to select the text.

Quick Reference**To Select a String of Text:**

1. Move the insertion point to the beginning or end of the text you want to select.
2. Click and hold the left mouse button and drag the insertion point across the text, then release the mouse button once the text is selected.

Or...

Press and hold down the <Shift> key while using the arrow keys to select the text you want.

To Select a Single Word:

- Double-click the word you want to select.

To Replace Text:

- Replace text by first selecting it, then typing the new text you want.

To Deselect Text:

- Click anywhere on the computer screen.

To Delete Selected Text:

1. Select the text.
2. Press the <Delete> key.

Table 7-3: Shortcuts for Selecting Text

<i>To Select This</i>	<i>Do This</i>
A word	Double-click the word.
A line	Click next to the line in the left margin.
A sentence	Press and hold <Ctrl> and double-click the sentence.
The entire document	Press and hold <Ctrl> and double-click in the left margin.

Lesson 7-8: Using Undo

Figure 7-15

You can cancel a text deletion with the Undo feature.

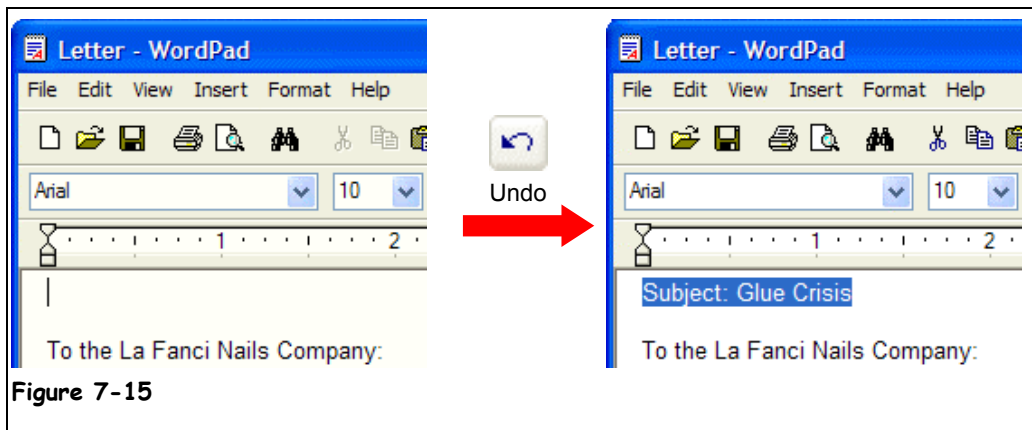

Figure 7-15



Undo button

Other Ways to Undo:

- Select **Edit** → **Undo** from the menu.
- Press **<Ctrl> + <Z>**.

You may not want to admit this, but you're going to make mistakes when you use Windows. You might accidentally delete a sentence in your word processing program you didn't mean to delete, or paste something in you didn't mean to paste. Fortunately, Windows and most Windows programs come with a wonderful feature called *undo* that does just that—it undoes your last action, making it as though it never happened.

Many people that are new to Windows or computers in general are often terrified of using computers because they are afraid they will make a mistake and seriously mess things up. First of all, it's more difficult to "mess up" your computer than you think it is. Secondly, you will learn how to use Undo, so even if you do make a mistake, you can easily cancel it.

1. Select the **Subject: Glue Crisis** line and delete it by pressing the **<Delete>** key.

Whoops! You didn't really want to delete that! Watch how you can undo your "mistake."

2. Click the **Undo** button on the Standard toolbar to cancel your last change.

Poof! WordPad cancels your last action and the deleted text "Subject: Glue Crisis" reappears.

In most programs, Undo will only cancel your last action or change; if you don't catch your mistake right after you make it, Undo may not be able to help.

Quick Reference

To Undo Your Previous Action:

- Click the  **Undo** button on the toolbar.
- Or...
- Select **Edit** → **Undo** from the menu.
- Or...
- Press **<Ctrl> + <Z>**.

Lesson 7-9: Printing a File

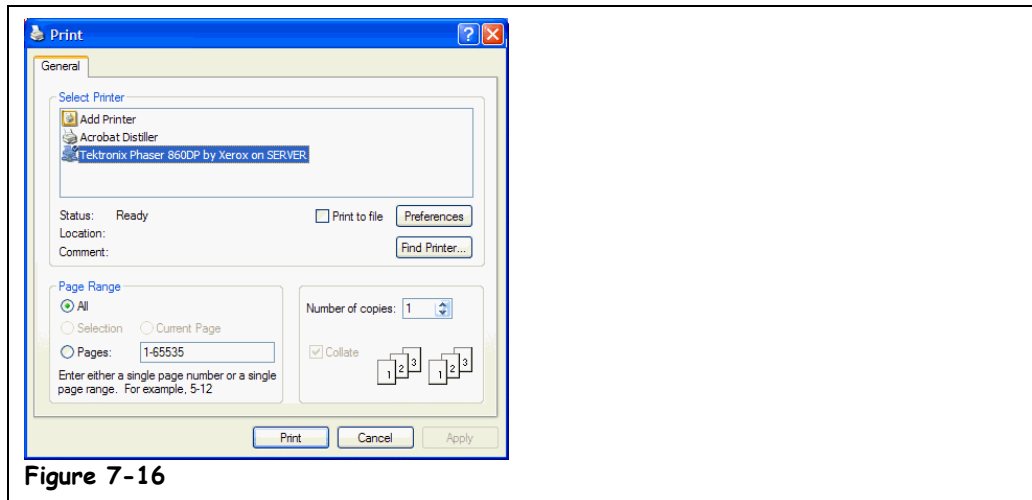

Figure 7-16

Figure 7-16

The Print dialog box

This lesson will show you how to send whatever you're working on to the printer. Printing is one of the easiest things to do in Windows.

1. Select **File** → **Print** from the menu.

The Print dialog box appears, as shown in Figure 7-16. The Print dialog box may differ depending on the program you're using, but it should usually contain the options listed in Table 7-4: *Print Dialog Box Options*.

2. Click **OK**.

Windows sends the document to the printer.

Other Ways to Print:



- Click the  **Print** button if it appears on the toolbar.
- Press **<Ctrl> + <P>**.

Table 7-4: Print Dialog Box Options

Print option	Description
Name	Used to select what printer to send your file to when it prints (if you are connected to more than one printer). The currently selected printer is displayed.
Properties	Displays a dialog box with options available to your specific printer such as the paper size you want to use, if your document should be printed in color or black and white, etc.
Page range	Allows you to specify what pages you want printed. There are several options: All: Prints the entire document. Selection: Prints only the text you have selected (before selecting the print command). Pages: Prints only the pages of the file you specify. Select a range of pages with a hyphen (like 5-8) and separate single pages with a comma (like 3,7).
Number of copies	Specifies the number of copies you want to print.

Quick Reference

To Print a File:

- Click the  **Print** button on the Standard toolbar.
- Or...
- Select **File** → **Print** from the menu.
- Or...
- Press **<Ctrl> + <P>**.

Lesson 7-10: Cutting, Copying, and Pasting Text

Figure 7-17

The steps involved in cutting and pasting text

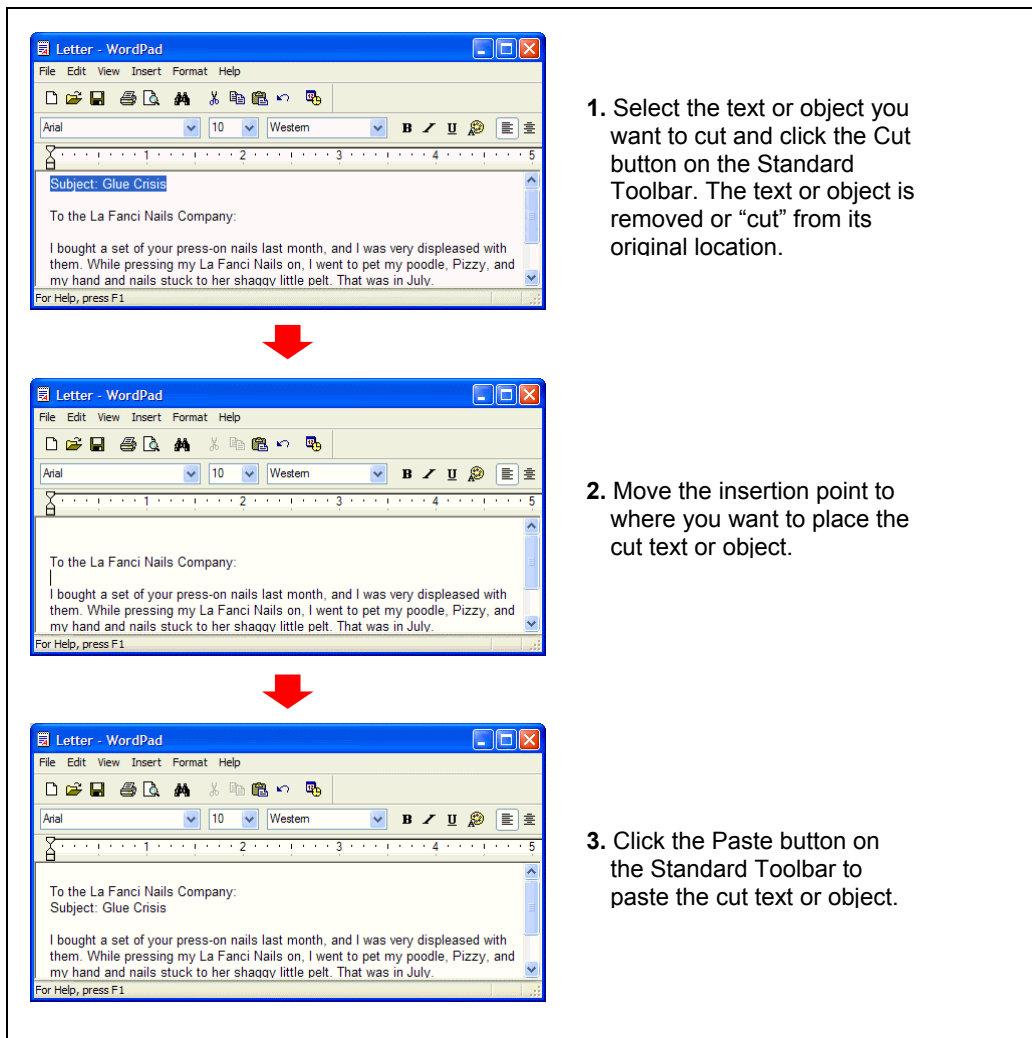

1. Select the text or object you want to cut and click the Cut button on the Standard Toolbar. The text or object is removed or “cut” from its original location.

2. Move the insertion point to where you want to place the cut text or object.

3. Click the Paste button on the Standard Toolbar to paste the cut text or object.



Cut button

Other Ways to Cut:

- Select **Edit** → **Cut** from the menu.
- Press **<Ctrl> + <X>**.



Paste button

Other Ways to Paste:

- Select **Edit** → **Paste** from the menu.
- Press **<Ctrl> + <V>**.

By now, you should already know how to select text in a document. Once text is selected, you can move it to another place in the document by cutting it and then pasting elsewhere. Cutting and pasting text is one of the more common tasks you will use in your programs. Anything you cut is placed in a temporary storage area called the Windows *Clipboard*. The Clipboard is available to any Windows program, so you can cut and paste text between different programs.

1. Select the entire subject line.

Remember how to select text? Point to the beginning or end of the text you want to select, hold down the left mouse button, drag the cursor across the text, and release the mouse button.

Now you can cut the selected text to the Windows clipboard.

2. Click the **Cut button on the Standard toolbar.**

The selected text, the current date, disappears from WordPad and is placed in the Windows *Clipboard*, ready to be moved to a new location.

NOTE: The Windows Clipboard can only hold one piece of information at a time. Every time you cut or copy something to the Clipboard, it replaces the previous information.

3. Move the insertion point to the blank line immediately below **To the La Fanci Nails Company:**

This is where you want to paste the line you cut.

4. Click the **Paste button on the Standard toolbar.**

Poof! The cut text, the subject line, appears at the insertion point.

Copying information is very similar to cutting information. Both commands put your selected information in the Clipboard where you can then paste it to a new location. The only difference between the two commands is that Cut command deletes selected information when it copies it to the clipboard, while the Copy command copies the selected information to the clipboard without deleting it.

5. Select the entire document by holding down the **<Ctrl> key and clicking the pointer in the left margin.**

Now you can copy the selected text to the clipboard.

6. Click the **Copy button on the Standard toolbar.**

Nothing appears to happen, but the selected text has been copied to the clipboard.

One of the great things about Windows is that it allows you to share information between programs. For example, the information that you just copied to the Windows clipboard from WordPad can be pasted into another Windows program. To see how this works, you will need to open another Windows program—the Notepad.

7. Click the **Start button and select **All Programs** → **Accessories** → **Notepad**.**

The Notepad program appears. Notepad is a bare-bones simple program and doesn't have a toolbar like WordPad does, so you will have to access the Paste command through the menu.

8. Select **Edit → **Paste** from the Notepad menu.**

The document you copied from the WordPad program is pasted into the Notepad program. You won't be using the Notepad program anymore in this chapter, so you can close it.

9. Click the Notepad program's **Close button.**

A dialog box appears, asking if you want to save the changes you made to the Notepad file. You don't need to save any changes, so you can safely click No.

10. Click **No.**

You should save the changes you've made to your WordPad document.

11. Click the **Save button on WordPad's Standard toolbar to save the changes you've made to the document.**

WordPad saves your recent changes to the local disk.

**Copy button****Other Ways to Copy:**

- Select **Edit** → **Copy** from the menu.
- Press **<Ctrl> + <C>**.

Quick Reference**To Cut Something:**

1. Select the text or object you want to cut.
2. Click the **Cut** button on the Standard toolbar.
Or...
Select **Edit** → **Cut** from the menu.
Or...
Press **<Ctrl> + <X>**.

To Copy Something:

1. Select the text or object you want to copy.
2. Click the **Copy** button on the Standard toolbar.
Or...
Select **Edit** → **Copy** from the menu.
Or...
Press **<Ctrl> + <C>**.

To Paste a Cut or Copied Object:

1. Place the insertion point where you want to paste the text or object.
2. Click the **Paste** button on the Standard toolbar.
Or...
Select **Edit** → **Paste** from the menu.
Or...
Press **<Ctrl> + <V>**.

Lesson 7-11: Changing the Font Type and Size

Figure 7-18

Select a font from the font list.

Figure 7-19

The Font dialog box

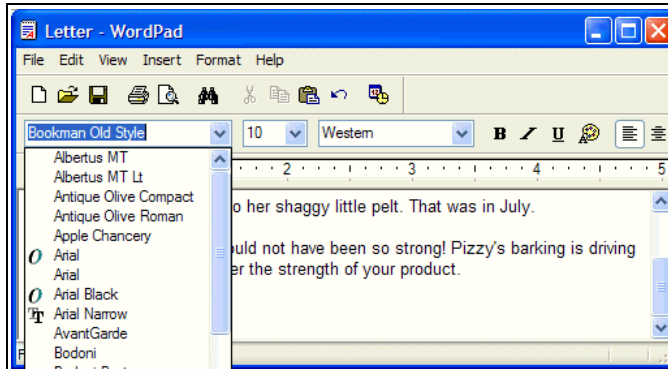

Figure 7-18

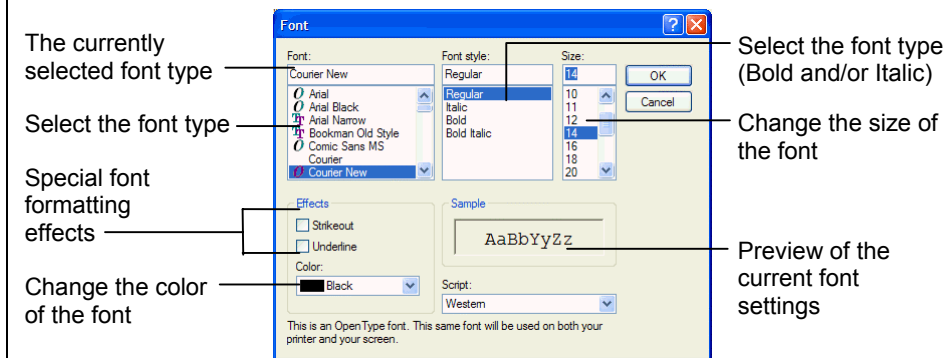

Figure 7-19

In this lesson, you'll learn how to change the font or text size and style. Although you'll be working with the WordPad program, the basic procedure for changing the size and type of a font is the same in all Windows programs.



Font list

Other Ways to Change Fonts:

- Select **Format** → **Font** from the menu, select the font options you want from the font dialog box, then click **OK**.

1. Move the insertion point the very end of the document and press **<Enter>** twice to add a blank line.

You are going to add your name to the document here, but first you want to use a different font to make it stand out.

2. Click the **Font** list arrow on the **Formatting toolbar**.

A list appears with all the fonts that are available on your computer, listed in alphabetical order. Since there isn't enough room to display all the font types at once, you may have to scroll up or down the list until you find the font type you want.

3. Scroll up the **Font** list until you see the **Bookman Old Style** font, then click the **Bookman Old Style** font.

Anything you type at this point will appear in the selected Bookman Old Style font.

4. Type *Jane Plain*.

The name Jane Plain appears in the Bookman Old Style font. You can also select text and change it to a new font.

5. Select the line **To the La Fanci Nails Company:**

In the next step, we'll change the selected text to Courier New font type.

6. Click the **Font** list arrow and select **Courier New** from the Font list.

The selected text changes to the Courier New font.

You can also change the size of a font and make it larger or smaller. Font size is measured in *points*: the bigger the point number, the larger the size of the font. 10 point and 12 point are the most commonly used font sizes. Changing the font size is similar to changing font types.

7. Make sure the **To the La Fanci Nails Company:** line is still selected, and click the **Font Size** list arrow.

A list of font sizes appears.

8. Select **14** from the Font Size list.

The font for the selected line is enlarged to 14 point.

So far, you've been using the Formatting toolbar to change the type and size of fonts. Another method of adjusting the type and size of fonts is to use the Font dialog box, which you can open using the menu. Since not all Windows programs have a Formatting toolbar, you should know how to format fonts with this method.

9. Select **Format** → **Font** from the menu.

The Font dialog box appears, as shown in Figure 7-19. Notice there are options for changing the font type and size, as well as other formatting options. After you've surveyed the Font dialog box, you can close it without making any changes by clicking the Cancel button.

10. Click **Cancel** to close the Font dialog box without making any changes.

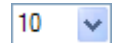

Font Size list
Other Ways to Change the Font Size:

- Select **Format** → **Font** from the menu, select the font options you want from the font dialog box, and click **OK**.

Table 7-1: Examples of Font Types and Sizes

Common Font Types	Common Font Sizes
Arial	Arial 8 point
Comic Sans MS	Arial 10 point
Courier New	Arial 12 point
Times New Roman	Arial 14 point

Quick Reference

To Change Font Size:

- Select the point size from the **Font Size** list on the Formatting toolbar.

Or...

- Select **Format** → **Font** from the menu and select the font size in the Font dialog box.

To Change Font Type:

- Select the font from the **Font Style** list on the Formatting toolbar.

Or...

- Select **Format** → **Font** from the menu and select the font type in the Font dialog box.

Lesson 7-12: Using Bold, Italics, and Underline

Figure 7-20

WordPad's Formatting toolbar

Figure 7-21

The document with bold and italics formatting



Italics button

Other Ways to Italics:

- Select **Format** → **Font** from the menu, select **Italic** from the Font Style box, and then click **OK**.
- Press **<Ctrl> + <I>**.



Bold button

Quick Reference

To Format Text with Bold, Italics, or Underlining:

- Click the **Bold**, **Italics**, or **Underline** button on the Formatting toolbar.
- Or...
- Select **Format** → **Font** from the menu and select the formatting from the **Font Style** list.
- Or...
- Press the **<Ctrl>** key and:
 - ** for Bold
 - <I>** for Italics
 - <U>** for Underlining

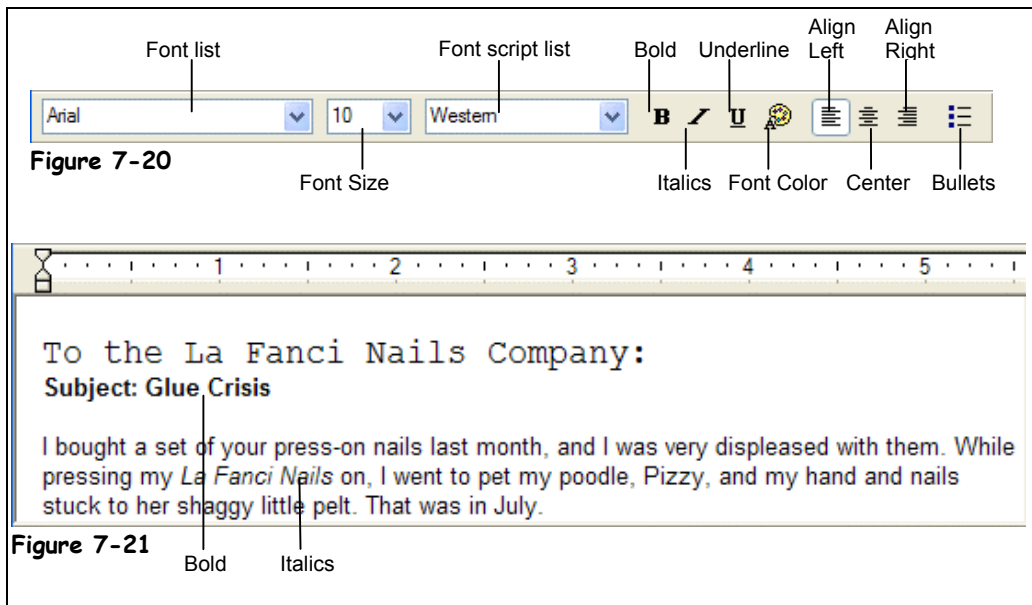

In the previous lesson, you learned how to format characters in a document by changing their font type and font size. This lesson will show you how to emphasize text in a document by making the text darker and heavier (**bold**), slanted (*italics*), or by adding underlining.

1. Select the text **La Fanci Nails**, located in the first body paragraph in your document.

You can make the selected text stand out by formatting with Italics.

2. Click the **Italics** button on the Formatting toolbar.

The selected text, *La Fanci Nails*, appears in italics. Notice that the Italics button is pushed down on the Formatting toolbar, indicating the text is formatted with Italics.

It's just as easy to format characters with bold or underline formatting.

3. Select the line **Subject: Glue Crisis**.

Now format the selected text with bold formatting.

4. Click the **Bold** button on the Formatting toolbar.

The selected text appears in bold. To remove the bold style, repeat step 4.

5. Make sure the **Subject: Glue Crisis** is still selected, then click the **Bold** button on the Formatting toolbar.

The bold style is removed from the selected text. You can apply italic and underline formatting from text by using the same method, except you would click the Italics or Underline button.

Lesson 7-13: Changing Paragraph Alignment

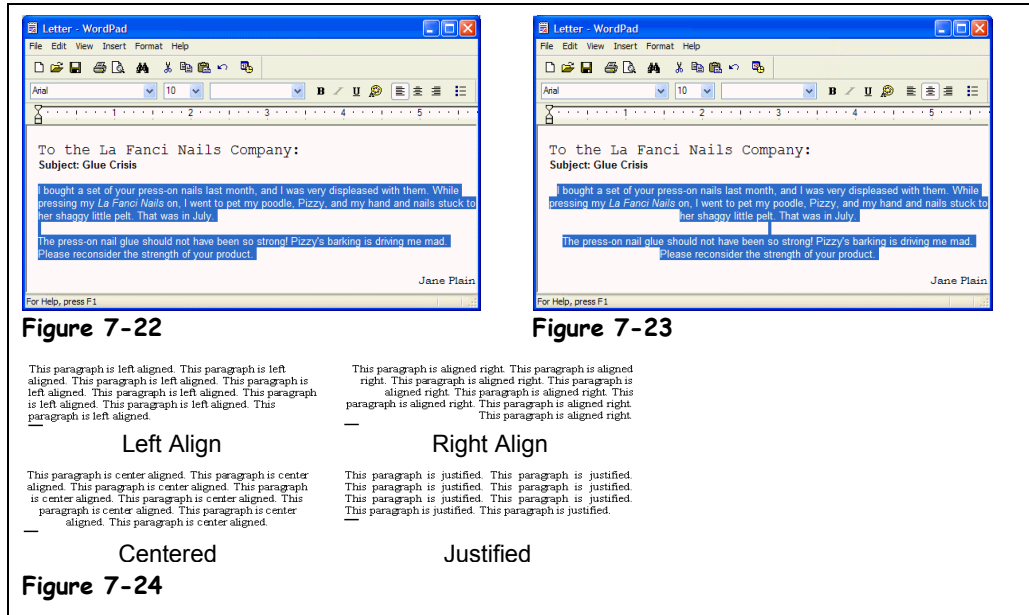

This lesson moves on to paragraph formatting and explains how to justify paragraphs or align them to the left, right, or center of a page. These are common formatting tasks for all word processing programs.

1. Place the insertion point anywhere in the last line, **Jane Plain**, and then click the **Align Right** button on the Formatting toolbar.
The last line is aligned to the right with a ragged left edge.
2. Drag the mouse pointer  to select the two body paragraphs, as shown in Figure 7-22, then click the **Center** button on the Formatting toolbar.
The selected paragraphs are centered on the page.
3. Press the **<End>** key to move to the end of the current line, then press **<Enter>**.
Notice the new paragraph will be centered like the one above it. That's because when you press **<Enter>**, the new paragraph “inherits” the formatting from the paragraph above it.
4. Select the two paragraphs again, and click the **Align Left** button on the Formatting toolbar.
The selected paragraphs are again aligned to the left.
5. Click the **Save** button on the Standard toolbar to save your work.

Figure 7-22

Place the insertion point  in the paragraph you want to align, or select the paragraph(s).

Figure 7-23

Clicking the Center button on the Formatting toolbar centers the selected paragraphs.

Figure 7-24

Left, right, centered, and justified paragraphs



Align Right button



Center button



Align Left button

Quick Reference

To Change a Paragraph's Alignment:

- Place the insertion point in the paragraph and click the **Align Left**, **Center**, or **Align Right** button.

Or...

- Place the insertion point in the paragraph, select **Format** → **Paragraph** from the menu and select the alignment, from the **Alignment** list.

Lesson 7-14: Getting Help by Contents

Figure 7-25

The Contents tab of the Help window

Figure 7-26

You can expand a Help Topic.

Figure 7-27

The displayed help topic

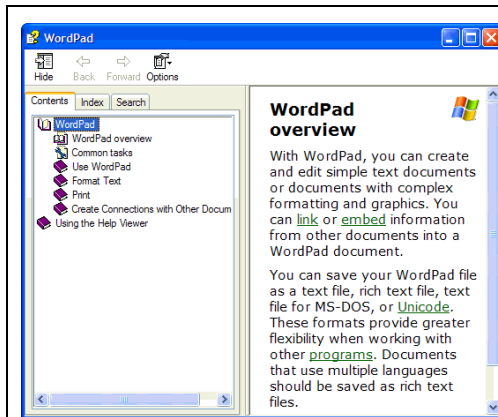

Figure 7-25



Figure 7-26

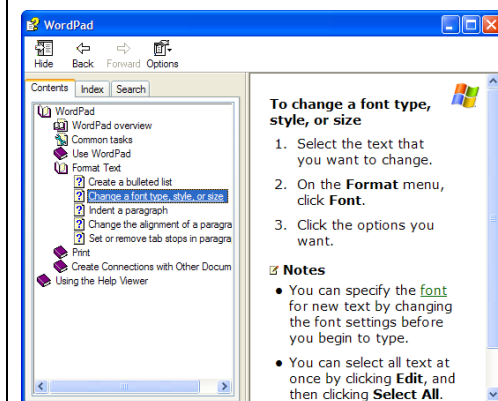

Figure 7-27

When you don't know how to do something in Windows or a Windows based program, don't despair—most programs come with a built-in help feature. Help is one of the greatest—and sadly, the least used—feature of most Windows programs. There is often more information about how to use a program under the *Help* feature than there is in the program manual! Many people actually learn how to use entire programs by simply using the Help feature of the program when they don't know how to do something.

Help allows you to try new, exciting things in programs all by yourself. It simply cannot be stressed how important and useful the Help feature is. There are several ways you can get help in Windows—we'll look at them in the next couple of lessons.

For this lesson, imagine that you've seen several of your co-workers use different sized fonts in their WordPad documents. You decide it's time you learned how to change the size of fonts in WordPad, so you decide to use the help feature.

Most Windows applications have a Help menu listed at the far right of the menu bar. You can also open Help pressing the <F1> key.

1. Make sure the WordPad program is opening/loading the active window and press the **<F1>** key.

The Help window appears with the Contents tab in front, as shown in Figure 7-25. One way to get help is by going to Contents. Using Help's Contents is similar to using a book's table of contents. Help's Contents is a good way to get general information on a topic, especially if it's a subject you're not familiar with. The Help's Contents are organized in outline form. The book icons (📖) that appear to the left of a topic tells you there are sub-topics and information under this topic. To view this information, you have to open or expand the topic by double-clicking it.

2. Click the **WordPad** icon and then click the **Format Text** topic to expand it.

The topic opens and a list of sub-topics appear under it, as shown in Figure 7-26.

3. Click the **Change a font type, style, or size topic** (it has a question mark  icon that appears to the left of it).

Information on text formatting appears in the right pane of the Help window, as shown in Figure 7-27. You can easily print any Help topic.

4. Click the **Options** button at the top of the dialog box and select the **Print...** item.

The Print Topics box appears. We just want to print one topic.

5. Select **Print Selected Topic** and click **OK**.

The Print dialog box appears, ready to carry out your print command. Since you already know how to print in Windows, save the paper and cancel the print job.

6. Click the **Cancel** button to close the Print dialog box without sending the Help topic to the printer.

The <F1> key displays help on what you're doing.



Options button

Quick Reference

To Get Help by Contents:

1. Press **<F1>** or select **Help** from the menu, and click the **Contents** tab if necessary.
2. Scroll down the screen and double-click the help topic you're looking for.
3. Double-click any Help subtopic(s).

To Move a Previous Help Screen or Topic:

- Click the **Back** button.

To Print a Help Topic:

- Click the **Options** button and select **Print Topic**.

Lesson 7-15: Getting Help with the Help Index and Search

Figure 7-28

The Index tab of the Help dialog box

Figure 7-29

The Topics Found dialog box

Figure 7-30

Click the  to display help on what a dialog box control does.

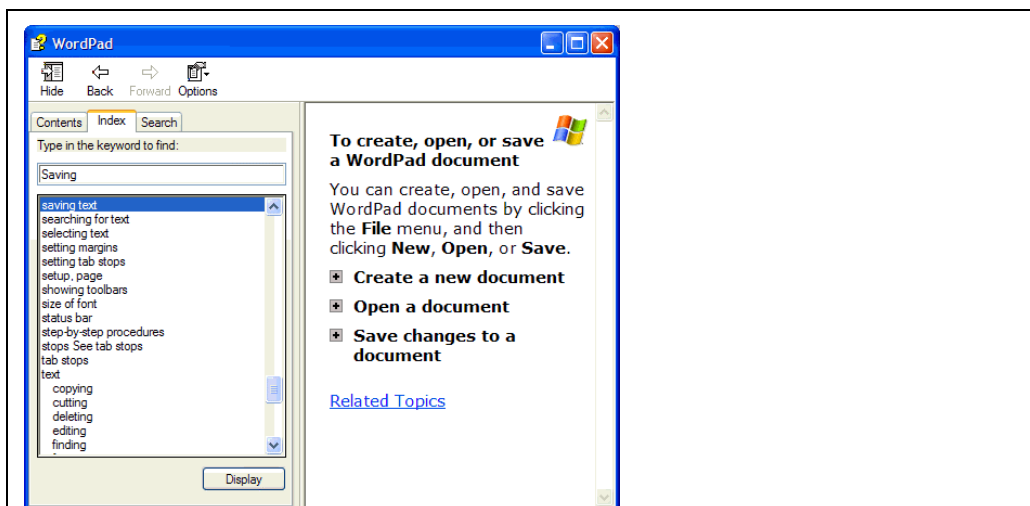

Figure 7-28

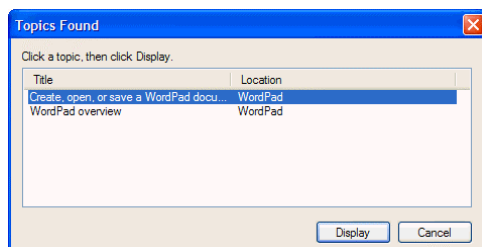

Figure 7-29

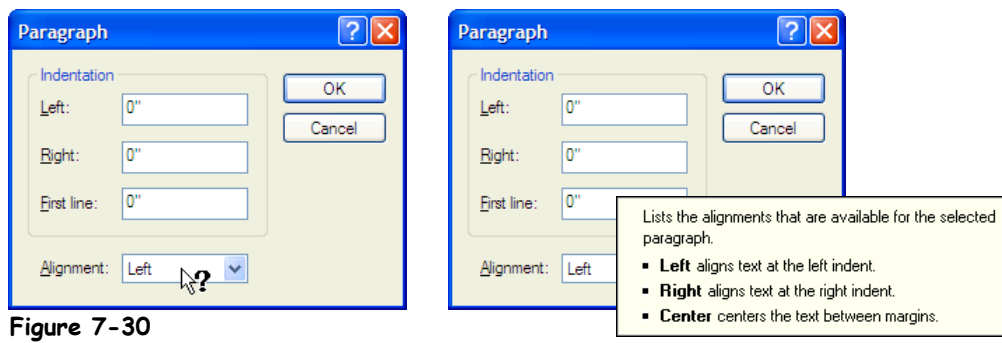

Figure 7-30

Two more methods of getting help are with the Help Index and Search. You use the Help Index just like you would use the index in the back of a book.

1. If the Help window isn't already open, press **<F1>** to open it.
2. Click the **Index** tab to bring it to the front.

The Index tab appears in front of the Help Window. This time, let's get some help on how to save files in WordPad.

3. In the **Type in the keyword to find box, type the word **Saving**.**

The Index topics list box displays all index entries that begin with the words “Saving”, as shown in Figure 7-28. A help topic called Saving Documents is listed—see what this topic is about.

4. Double-click the **Saving Text subtopic to open it.**

The Topics Found dialog box appears. We need to choose a topic.

5. Double-click the **Create Open or Save a WordPad Document topic.**

Information on saving changes to a document appears in the right pane of the Help window.



The Search function is another way that you can search for Help topics. Search is much more specific and powerful than either Help’s Contents or the Help Index. Search allows you to search for specific information.

6. Click the **Search tab.**

Next, you must specify what help you want to look for.

7. In the **Type the word(s) you want to find box, type the word **Save** and click the **List Topics** button.**

Both the words and topics lists are updated to show all help topics that contain the word “Save.” You can refine a help search by typing in more than one word.

8. In the **Type the word(s) you want to find box, type a **<Space>** then the words **File** after the word table so that the text box reads **Save File**. Then click **Display**.**

Both the words and topics lists are updated and display only those help topics that contain both the words “Save” and “File” in them.

9. Double-click the **WordPad Overview topic.**

Windows displays the WordPad Overview help topic.

10. Click the **Close button to close the Help dialog box.**

During your journey with Windows you will probably come across dialog boxes with a number of confusing controls and options. To help you find out what the various controls and options in a dialog box do, many dialog boxes contain a “What’s This” button, located right next to the close button.

11. Select **Format → **Paragraph** from the menu.**

The Paragraph dialog box appears. Notice the Help button located in the dialog box’s title bar just to the left of the dialog box’s close button.

12. Click the **“What’s This” button.**

The mouse pointer changes to a , indicating you can point to anything on the dialog box to find out what it does, as shown in Figure 7-30.

13. Click the **Alignment combo box.**

A window appears with a brief description of what the Alignment combo box does.

14. Click **Cancel to close the Paragraph dialog box.**

That’s it—you’re done learning the various ways to get help in Windows. If you know how to use a program’s Help feature, you may never need to attend another computer class—everything you need to know is there, buried somewhere in Help. Make yourself a promise that the next time you have a question about how to do something in a program, you will try using the program’s built-in Help feature before you reach for the manual or ask one of your computer-savvy friends.

What’s This button

Quick Reference

To Use the Help Index:

1. Press **<F1>** or select **Help** from the menu and click the **Index** tab.
2. Type the keyword(s) that describe the help topic you are looking for.
3. Double-click the help topic you’re looking for.

To Find a Help Topic:

1. Press **<F1>** or select **Help** from the menu and click the **Search** or **Find** tab.
2. Type the keyword(s) topic you are looking for.
3. Double-click the Help topic you’re looking for.

To See what a Control in a Dialog Box Does:

1. Click the Dialog box **“What’s This”** button (located right next to the close button).
2. Click the control you want more information on with the  pointer.

Lesson 7-16: Saving and Opening Files in Different Locations

Figure 7-31

The Open/Save toolbar

Figure 7-32

The Open dialog box for the WordPad program

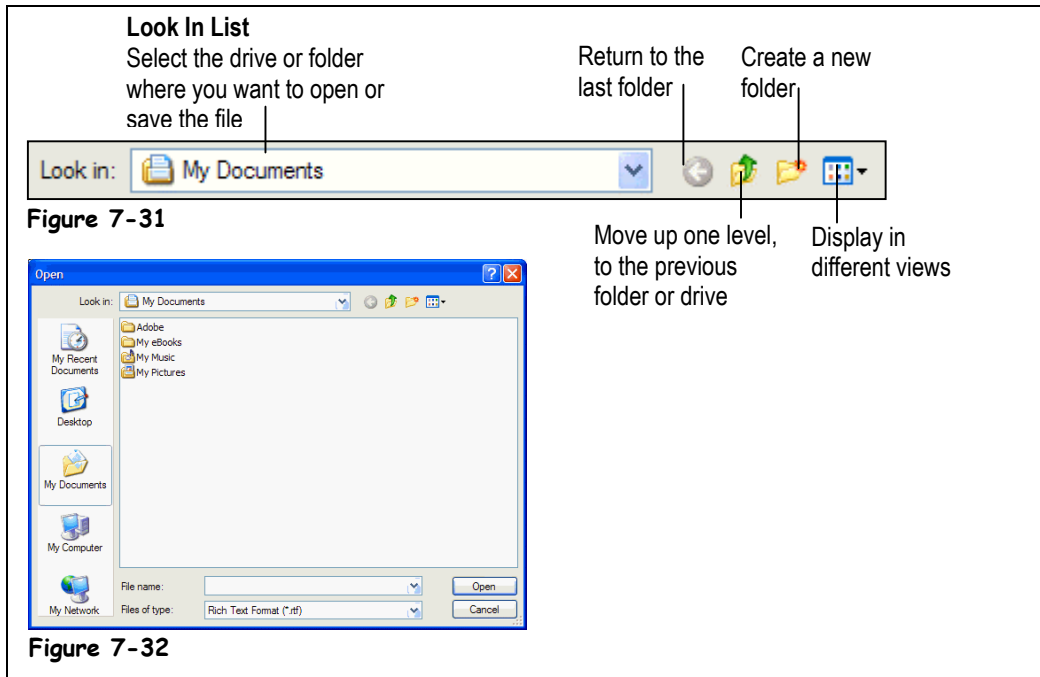

Figure 7-31

Figure 7-32



Open button

Other Ways to Open a File:

- Select **File** → **Open** from the menu.

By saving your files in related folders right away, you make them easier to find and don't have to do as much file management later. This lesson will show you how to save your files in different locations. You'll also learn how to save files in different file formats.

1. **Open the WordPad program by clicking the **Start** button and selecting **File** → **All Programs** → **Accessories** → **WordPad** from the program menu.**

The WordPad program appears.

2. **Click the **Open** button on the Standard toolbar.**

The Open Dialog box for the WordPad program appears, as shown in Figure 7-32. Before we open a file, first let's take a closer look at the Open dialog box. Notice the toolbar that appears near the top of the dialog box, as shown in Figure 7-31. If several of the buttons on the toolbar look somewhat familiar, they should—because they're the same toolbar buttons that you'll find in My Computer and Windows Explorer. When you're opening or saving a file you can navigate through the drives, folders, and files on your computer just like you do in My Computer and Windows Explorer.

3. **Navigate to and open your practice folder or floppy disk.**

Your computer stores information in files and folders, just like you store information in a filing cabinet. To open a file, you must first find and open the folder where it's saved.

The Save dialog box has its own toolbar that make it easy to browse through your computer's drives and folders. Two controls on this toolbar are particularly helpful:

- **Look in:** Practice **Look In List:** Click to list the drives on your computer and the current folder, then select the drive and/or folder whose contents you want to display.

-  **Up One Level button:** Click to move up one folder.

If necessary, follow your instructor's directions to select the appropriate drive and folder where your practice files are located.

The Open dialog box reads the contents of the practice folder or disk and displays any Word for Windows (*.doc) files. Here's how you can view *all* the file types in the root directory on the drive—not just Word for Windows files.

4. Click the **File of type list and select **All Documents (*.*)**.**

The Open dialog box is updated to display all the files in the root directory of the floppy disk.

5. Double-click the **Canada Meeting Memo file to open it.**

WordPad opens the Canada Meeting Memo file. Normally, when you save an existing file, it's saved with its original file name in its original location or folder. There are times, however, when you will need to save a copy of a file in a new location, with a different file name, or in a different file format.

6. Select **File → **Save As** from the menu.**

The Save As dialog box appears.

Whenever you save or store files on a computer, try to save them in a related folder. For example, you might create a "Personal Letters" folder to store all your personal correspondence files and a "Business" folder for your business-related files. Selecting a folder to save a file in is easy—simply double-click the Create New folder icon on the toolbar.

NOTE: If you don't specify a drive or folder when you're saving a file, the program will save the file in the current folder—the drive and folder that happens to be open at that time. This can often make the file more difficult to find in the future.

7. Double-click the **Trade Show folder.**

The Trade Show folder opens—this is where you want to save the file.

Earlier in this chapter, you learned that computer programs save and open files in their own different types or formats, just like people from different countries speak different languages. But, just as some people can speak more than one language, many computer programs can open and save files using other file types or formats. WordPad normally saves files in Word for Windows (*.doc) format, but it's easy to save files in different formats.

8. Click the **Save as type list arrow.**

A list of different types of file formats appears.

9. Select **Text Documents (*.txt) from the **Save as type** list.**

One more thing before we save the file—we want to save it with a different name. If you clicked the Save button at this point, WordPad would save the file in the Trade Show folder with the original file name, "Canada Meeting Memo." To save the file with a different name, simply type the new file name in the File Name box.

10. Click in the **File Name box and type **Canada Letter**.**

11. Click **Save and click **Yes** to confirm the loss in formatting.**

WordPad saves the Canada Letter as a text file under the Trade Show folder.

12. Close the WordPad program.

You can perform basic file management, such as renaming, deleting, moving, and copying files and folders from inside any Open or Save dialog box, just as if you were in My Computer.

Quick Reference

To Save a File in a New Location:

- Select **File** → **Save As** from the menu, open the drive and/or folder where you want to save the file, and click **Save**.

To Save a File in a Different File Format:

- Select **File** → **Save As** from the menu, select the file format from the **Save as type** list, and click **Save**.

Chapter Seven Review

Lesson Summary

How to Use Menus

- Open a menu by clicking the menu name with the mouse or by pressing **<Alt>** and then the underlined letter in menu.

How to Use Toolbars

- Click the toolbar button you want to use.
- **To See What a Toolbar Button Does:** Position the pointer over the toolbar button and wait a second. A ScreenTip will appear above the button.

Filling Out a Dialog Box

- Be able to identify and use text boxes, list boxes, check boxes, combo boxes, and buttons.
- Use a scroll bar to move up or down when a list or screen can't display all its information at once.
- **To Select a Dialog Box Control:** Click the control with the mouse or press **<Tab>** to move to the next control in the dialog box or **<Shift> + <Tab>** to move to the previous control until you arrive at the desired control.

Entering Text in the WordPad Program

- Place the insertion point in WordPad by clicking in the WordPad screen, and type your text.

Editing Text

- Move the insertion point by pressing the arrow keys on the keyboard or by clicking where you want to place the insertion point.
- **To Insert Text:** Move the insertion point where you want to insert the text and then type the text you want to insert.
- **To Delete Text:** The **<Delete>** key deletes text before, or to the right of, the insertion point. The **<Backspace>** key deletes text after, or to the left of, the insertion point.

Saving and Opening a File

- **To Save a File:** Click the **Save** button on the Standard toolbar or select **File** → **Save** from the menu, select the drive and/or folder where you want to save the file, give the file a name, and click **Save**.
- **To Open a File:** Click the **Open** button on the Standard toolbar or select **File** → **Open** from the menu, select the drive and/or folder where the file you want to open is located, select the file and click **Open**.

Selecting, Replacing, and Deleting Text

- **Selecting Text with the Mouse:** Move the insertion point to the beginning or end of the text you want to select. Click and hold the left mouse button and drag the insertion point across the text, releasing the mouse button once the text is selected.
- **Selecting Text with the Keyboard:** Move the insertion point to the beginning or end of the text you want to select, and press and hold the **<Shift>** key while you use the arrow keys to select the text.
- Double-click the word to select it.
- Typing replaces any selected text; pressing the **<Delete>** or **<Backspace>** key deletes any selected text.
- Deselect text by clicking anywhere on the screen.

Using Undo

- **To Undo Your Last Action:** Click the **Undo** button on the Standard toolbar, or select **Edit** → **Undo** from the menu, or press **<Ctrl> + <Z>**.

Printing a File

- Print a file by clicking the **Print** button on the Standard toolbar, or by selecting **File** → **Print** from the menu, or by pressing **<Ctrl> + <P>**.
- Select **File** → **Print** from the menu to display the Print dialog box, which allows you to specify printing options—such as printing specific pages or multiple copies.

Cutting, Copying, and Pasting Text

- **To Cut Something:** Select the text or object you want to cut. Cut the selection by clicking the **Cut** button on the Standard toolbar, or by selecting **Edit** → **Cut** from the menu, or by pressing **<Ctrl> + <X>**.
- **To Copy Something:** Select the text or object you want to copy. Copy the selection by clicking the **Copy** button on the Standard toolbar, or by selecting **Edit** → **Copy** from the menu, or by pressing **<Ctrl> + <C>**.
- **To Paste a Cut or Copied Object:** Place the insertion point where you want to paste the text or object. Click the **Paste** button on the Standard toolbar, or select **Edit** → **Paste** from the menu, or press **<Ctrl> + <V>**.

Changing the Font Type and Size

- **To Change Font Size:** Select the pt. size from the **Font Size** list on the Formatting toolbar or select **Format** → **Font** from the menu and select the font size in the dialog box.
- **To Change Font Type:** Select the font from the **Font Style** list on the Formatting toolbar or select **Format** → **Font** from the menu and select the font type in the Font dialog box.

Using Bold, Italics, and Underline

- Format text with bold, italics, or underlining by clicking the corresponding button (**Bold**, **Italics**, or **Underline**) on the Formatting toolbar or by selecting **Format** → **Font** from the menu and selecting the formatting from the **Font Style** list. You can also press the **<Ctrl>** key and:
 - ** for Bold
 - <I>** for Italics
 - <U>** for Underlining.

Changing Paragraph Alignment

- Change a paragraph's alignment by placing the insertion point in the paragraph and then either clicking the **Align Left**, **Center**, or **Align Right** button on the Formatting toolbar, or by selecting **Format** → **Paragraph** from the menu and selecting the paragraph alignment from the **Alignment** list.

Getting Help by Contents

- Pressing the **<F1>** key displays information on what you're currently doing.
- **To Get help by Contents:** Press **<F1>** or select **Help** from the menu, and click the **Contents** tab if necessary. Scroll down the screen and click the topic you're looking for. Double-click any subtopics if necessary.
- Click the **Back** button to move to the previous help screen or topic.
- **To Print a Help Topic:** Click the **Options** button and select **Print Topic**.

Getting Help with the Help Index and Search

- **To Use the Help Index:** Press **<F1>** or select **Help** from the menu and click the **Index** tab and type the keyword(s) that describe the Help topic you are looking for. Double-click the Help topic you're looking for.
- **To Search for a Help Topic:** Press **<F1>** or select **Help** from the menu and click the **Search** tab and type the keyword(s) that describe the help topic you are looking for. Double-click the Help topic you're looking for.
- Clicking the Dialog box's **Help** button and then clicking a control with the pointer explains what the control does.

Saving and Opening Files in Different Locations

- **To Save a File in a New Location:** Select **File** → **Save As** from the menu, open the drive and/or folder where you want to save the file, and click **Save**.
- **To Save a File in a Different File Format:** Select **File** → **Save As** from the menu, select the file format from the **Save as type** list, and click **Save**.

Quiz

- 1. You can open a program's menu by: (Select all that apply.)**
 - A. Clicking the menu name with the mouse.
 - B. Pressing <Esc> and then the underlined letter in menu.
 - C. Pressing <Alt> and then the underlined letter in menu.
 - D. Saying "Computer, open the (state the name of the menu here) menu".
- 2. How can you move the insertion point in WordPad? (Select all that apply.)**
 - A. By pressing the arrows keys on your computer's keyboard.
 - B. By using the mouse and clicking where you want to place the insertion point with the I pointer.
 - C. By selecting the Window → Move Insertion Point command.
 - D. The insertion point is an immovable object and can't be moved.
- 3. Which key deletes text before, or to the left, of the insertion point?**
 - A. <Page Up>
 - B. <Page Down>
 - C. <Delete>
 - D. <Backspace>
- 4. Typing overwrites, or replaces, any text that is selected (True or False?)**
- 5. Which of the following statements is NOT true?**
 - A. You can undo the last action or mistake you made by clicking the Undo button on the toolbar or by selecting Edit → Undo from the menu.
 - B. You can print the file you're working on by clicking the Print button on the toolbar or by selecting File → Print from the menu.
 - C. You should save your work or file whenever you think about it.
 - D. Files names can contain up to 8 characters.
- 6. The following will cut selected text or information and place it on the clipboard (Select all that apply.)**
 - A. Pressing <Ctrl> + <X>.
 - B. Pressing <Ctrl> + <Delete>.
 - C. Clicking the Cut button on the toolbar.
 - D. Selecting Edit → Cut from the menu.
- 7. Unlike cutting, when you copy something, you can't see it on-screen (True or False?)**
- 8. Pressing <F5> displays Help on what you're doing (True or False?)**

Homework

1. Either insert your Practice Files CD, or navigate to where your practice files are located. If you don't know where they are, ask your instructor.
 2. Start WordPad. Open the Homework 3 file from your practice files.
-

3. Select File → Save As from the menu. Save the “Homework 3” as “Memo” on the Practice CD in the D: drive, or in your practice files.

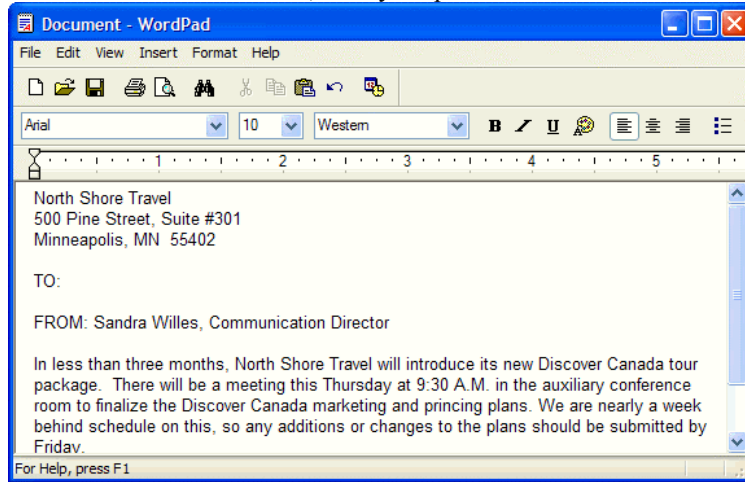

4. Move the insertion point to the end of the TO: line, press the <Spacebar> and type “All Staff.”
5. Select the top three address lines.
6. With the top address lines still selected, click the Center button on the Formatting toolbar to center align them.
7. Select the top “North Shore Travel” line and change the font type to Times New Roman, the font size to 14 pt., and apply bold formatting.
8. With the top “North Shore Travel” line still selected, press the <Delete> key to erase the line. Click the Undo button on the Standard toolbar to undo the deletion.
9. Select the text “Sandra Willes, Communication Director” and copy it by clicking the Copy button on the Standard toolbar
10. Move to the very end of the document, press the <Enter> key to add a blank line, type “Sincerely,” and press <Enter> four times to add several blank lines.
11. Click the Paste button on the Standard toolbar to paste the text you copied in Step 9.
12. Save your work and exit WordPad.

Quiz Answers

1. A and C. Clicking the menu name or pressing the <Alt> key and the underlined letter in the menu will both open a menu.
2. A and B. Either method will move the insertion point.
3. D. The <Delete> key deletes text before, or to the left, of the insertion point. <Backspace> deletes text after, or to the right, of the insertion point
4. True. Typing replaces any selected text.
5. D. MS-DOS files had an 8 character limit, but in Windows XP file names can contain up to 255 characters.
6. B. All the other methods will cut selected text or information and place it on the clipboard.

7. True. You can't see anything happen when you copy something, although it has been placed in the invisible Windows clipboard behind the scenes.
8. False. <F1> is the Windows help key.

Chapter Eight: Working with Files and Folders

Chapter Objectives:

- Understanding storage devices, folders, and files
- Using My Computer to navigate through folders and files
- Opening, creating, and renaming files and folders
- Copying, moving, and deleting files and folders
- Restoring a deleted file, and emptying the Recycle Bin
- Changing how information is displayed
- Selecting multiple files and folders
- Finding a file using the Search Companion
- Using Windows Explorer

Prerequisites

- How to use the mouse to click, double-click, drag and drop, and right-click
 - How to use menus, toolbars, and dialog boxes
-

When you work at a desk, unless you make an effort to stay organized, all your papers and files begin to pile up and become messy. It takes a little more time, but the same phenomenon occurs when working with Windows—the files you create using your computer start to become disorganized, and are harder and harder to find.

In this chapter, you'll take your first step beyond the Windows basics and enter the world of *file management*. You'll learn how Windows stores information in files and folders, just like a file cabinet does. You'll find you will need to clean and organize your files and folders from time to time, just like you would the contents of a file cabinet. This chapter explains how to organize your computer by creating folders to store related information, how to move and copy files between folders, how to delete and rename files and folders, and how to retrieve a deleted file if you change your mind. You can perform file management using several different programs—My Computer, Windows Explorer, Files and Settings Transfer Wizard, and the Open and Save dialog boxes found in most programs.

Lesson 8-1: Understanding Storage Devices, Folders, and Files

Figure 8-1

How information is stored in a file cabinet

Figure 8-2

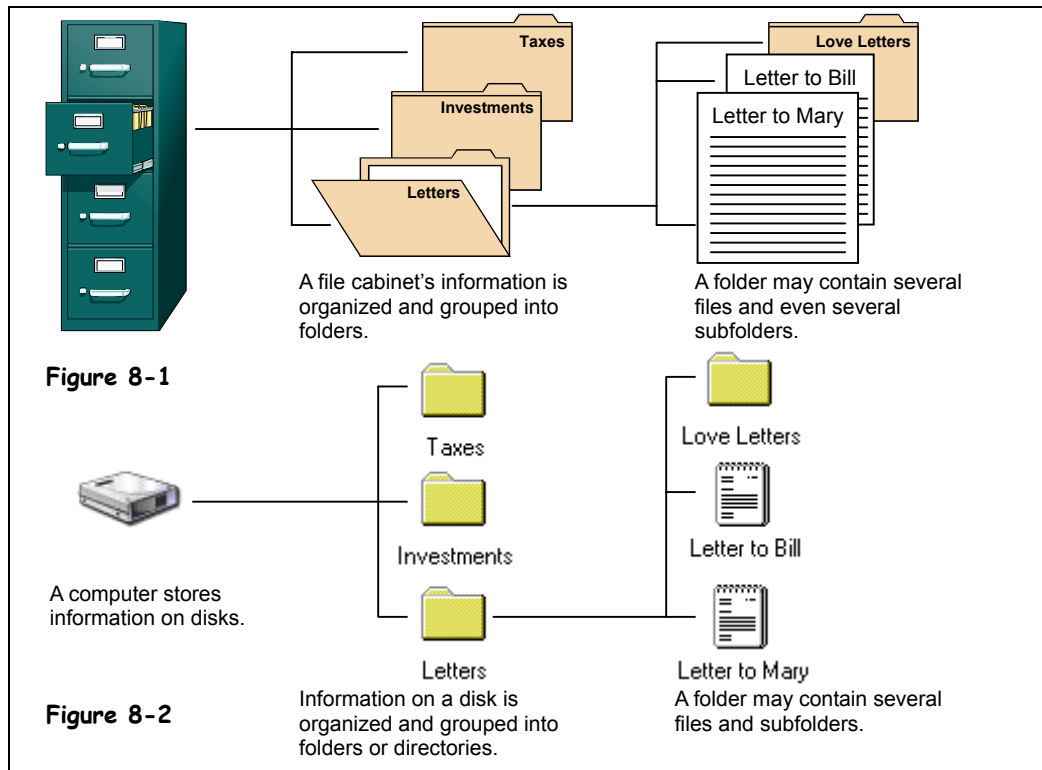

How information is stored on a disk



In order to understand *file management*, you need to understand how your computer stores information. Filing cabinets store information in files, which are organized and grouped in folders and kept in big drawers. Computers also store information in files, which are also organized and grouped in folders, and stored not in big drawers but on *disks*. A *disk drive* is the part of the computer that reads and writes information onto disks, just like a tape recorder records and plays music on a cassette. There are four main types of disks/drives computers use to store their information, as shown in the following table:

Table 8-1: Common Computer Disks/Drives

Type	Drive Letter	Size	Description
 Floppy Disk	A or B	1.44 MB	Floppy disks are the square plastic things that look like coffee coasters. Floppy drives can't hold a lot of information, but they're ideal for moving small files, such as word processing documents, between computers.

Type	Drive Letter	Size	Description
 Hard Disk	C and above	Over 4 GB	Hard disks hide permanently inside your computer. Your computer's hard disk is its main filing cabinet—where it stores almost all of its programs and files.
 CD-ROM	D or above	600 MB	Compact discs, or CD-ROMs, look like the audio discs you play in your stereo. CD-ROMs are cheap and they can store a lot of information, which is why they're used to install software for games and programs with a lot of multimedia. Unlike floppy or hard disks, most CD-ROMs can only read information—you can't save anything on them.
 Removable Drive	D or above	Over 100 MB	Removable storage drives have features of both hard disks and floppy disks. Removable drives are like a floppy drive because they read and write information on small, removable cassettes that are about the size of a floppy disk. They are like hard drives because each cassette can usually hold more than 100 MB and is almost as fast as a hard drive.

Most computers come with a floppy drive, a hard drive, and a CD-ROM drive. Your computer labels these drives with letters, as shown in Table 8-1: *Common Computer Disks/Drives*.

Just as liquids are measured in quarts and gallons, computers save their information in units called *bytes*. Unlike gallons, computers use the metric system, so 1,000 bytes make up a *kilobyte* and 1,000,000 (one million) bytes make up a *megabyte*, as shown in Table 8-2: *How Memory is Measured*.

Table 8-2: How Memory is Measured

Term	Description	Size
Byte	A byte can store a single character, such as the letter j or numeral 8.	A single character.
Kilobyte (K or KB)	A kilobyte (K) is about 1,000 bytes (1,024 to be exact). A kilobyte is equivalent to a page of double-spaced typing.	1,024 bytes
Megabyte (MB or MEG)	A megabyte (MB) is about one million bytes—about as much text as an average-length novel.	1,048,576 bytes

Lesson 8-2: Using My Computer to See What's in Your Computer

Figure 8-3

My Computer displays the drives, folders (directories), and files that are in your computer.

Figure 8-4

The Properties dialog box for a Local Disk (C:) drive.

Figure 8-5

The My Computer toolbar.

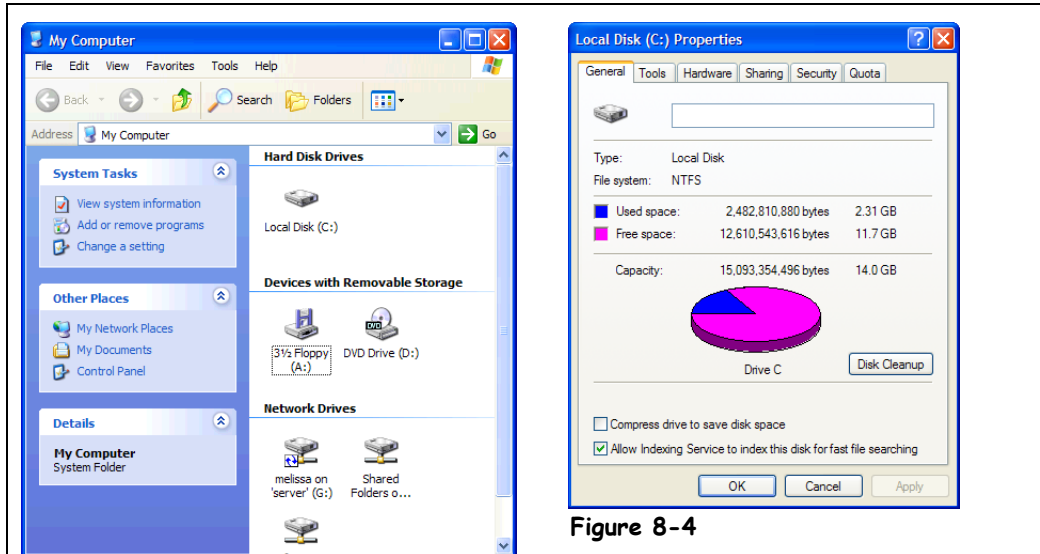

Figure 8-4

Figure 8-3

Moves back or up to the previous folder or level

Moves back or up to the previous folder or level

Changes how the contents of the folder are displayed

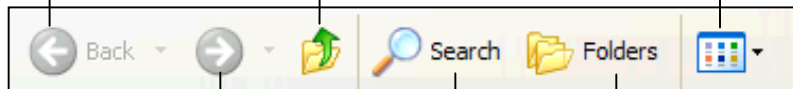

Figure 8-5

Moves forward to the last subfolder or level

Search for files and folders on your computer or on the network

Displays a history of files you have opened recently

When you want to see what's in a file cabinet, you simply pull open one of its drawers. You can view the information stored on your computer's drives in much the same way—by opening the drive you want to access. This lesson will show you how to look at the drives, folders, and files in your computer.



Start button



My Computer

1. Click the **Start button and select the **My Computer** icon.**

The My Computer window appears, as shown in Figure 8-3. The main window lists all the drives on the computer. Since your computer may have different drives, the contents of your computer may differ from those shown in Figure 8-3. Want to see what's inside something? All you have to do is double-click the drive, folder, or file you want to open.

Notice that My Computer appears in its own window, with its own little buttons, scroll bars, and menus. The My Computer window works just like the other windows you've been working with. You can move it, resize it, and minimize it.

2. Double-click the (C:) Local Disk icon.

The contents of the (C:) drive appear in the window. What do all those symbols in the window mean? Each item you see has an icon, or symbol, to help you identify what type of item it is. We'll take a look at what each of these symbols mean in an upcoming lesson.

To move back to the previous folder or level, click the Up button on the toolbar.

3. Click the Up button on the toolbar to move back to the My Computer level.

You've moved from the (C:) drive back to My Computer. Now that you know the procedure for displaying the contents of a drive, move on to the next step to display the properties of the Local Disk (C:) drive.

4. Right-click the (C:) Local Disk icon and select Properties from the shortcut menu.

The floppy drive hums as Windows examines it. After a moment, the Properties window appears, as shown in Figure 8-4. The Properties window displays the amount of used and free space on the disk in megabytes (MB) and gigabytes (GB). Refer to the previous lesson if you're unfamiliar with these terms.

5. Close the Properties dialog box by clicking its Close button.

The Properties dialog box closes. Go ahead and close the My Computer window to complete the lesson.

6. Close the My Computer window.

Getting the hang of opening and exploring your computer? Good, because we'll be doing a lot more snooping inside the contents of your computer throughout the rest of this chapter.

**Local Disk (C:)****Up button****Quick Reference****To View the Contents of Your Computer:**

- Click the Start button and click the **My Computer** icon.

To View the Contents of a Disk Drive:

- Follow the above step to open My Computer and then double-click the drive you want to open.

To View the Properties of Something:

- Right-click the drive, folder, or file and select **Properties** from the shortcut menu.

Lesson 8-3: Opening a Folder

Figure 8-6

Double-click a folder to open it and view its contents.

Figure 8-7

The files and folders appear in the window.

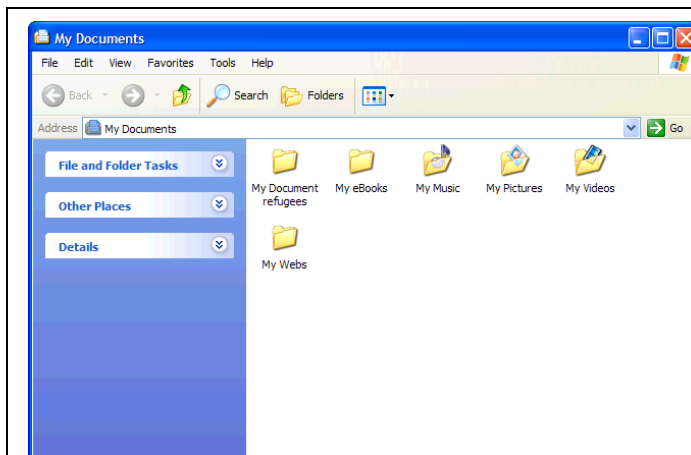

Figure 8-6

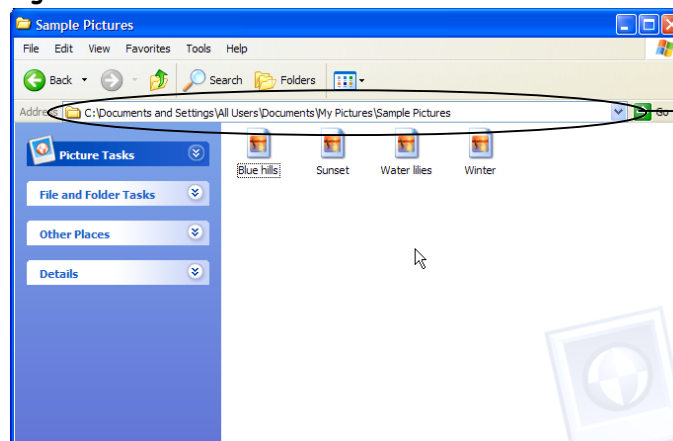

Figure 8-7

Your computer stores related files together in folders, just like you do with your file cabinet. In the previous lesson, you learned how to use My Computer to view the contents of your computer and open a disk drive and display its contents. In this lesson, we'll go a little bit further and show you how to open a folder.

Windows XP gives you your very own a special folder named “My Documents” as a convenient location to store all your files. Here’s how to open the My Documents folder (and any other folder).



My Documents

- 1. Click the **Start button** and select **My Documents**.**

The contents of the My Documents—several files and subfolders—appear in the window. The My Documents folder contains several folders, or *subfolders*. If you think about it, you probably do the same thing—keep several subfolders inside a larger folder—in your own file cabinet.

2. Double-click the **My Pictures** folder.

The contents of the My Pictures folder appear in the Window. Notice the Address bar displays the current folder you are in: My Pictures.

Instead of clicking the Up button several times to jump back through several levels of folders, you can click the Address bar to quickly jump to the root directory of any of drive on your computer.

NOTE: This is where the comparison we've been using between a file cabinet and a computer begins to break down a bit. When you file things in your file cabinet, you probably never have more than two, possibly three nested folders (i.e. a folder inside another folder). Your computer's folders, on the other hand, can contain as many subfolders as you want, nested as deep as you want, so you can have a folder inside a folder inside a folder—ad infinitum.



My Pictures

3. Click the **Address Bar** arrow .

A list of your computer's drives and the folder you are currently in appears. You can click any folder or drive to go to that folder or drive.

4. Select the **Local Disk (C:)** drive from the list.

You return to the root directory of the (C:) drive. The Address bar is a fast way of selecting a drive, especially if you are in a folder that is nested several levels deep.

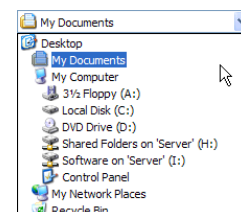

Address Bar

You can think of the Address Bar as your compass because even when you're exploring unfamiliar folders nested deep in the far recesses of your computer, it always tells you where you are. If you get really lost, you can always click the Address Bar and jump back to the familiar (C:) drive.

All this moving around your computer, opening disk drives and folders is a little boring, but it's something you have to get used to if you want to have any degree of proficiency with Windows. Going back to our trusty file cabinet metaphor, imagine what would happen if you didn't know how to open the drawers and folders in your file cabinet. How would you find your tax returns if you were audited, or your insurance policy if you were in an accident? Opening disk drives and folders, and being able to navigate through the contents of your computer are among of the most important Windows skills you can learn.

Quick Reference

To Open a Folder:

- Double-click the folder.

To Move Back or Up to the Previous Level or Folder:

- Click the  **Up button** on the toolbar.

Or...

- Click the  **Back button** on the toolbar.

Or...

- Click the  **Address Bar** on the toolbar and select the appropriate drive or folder.

Lesson 8-4: Creating and Renaming a Folder

Figure 8-8

The expanded File and Folder Tasks menu

Figure 8-9

A newly created folder

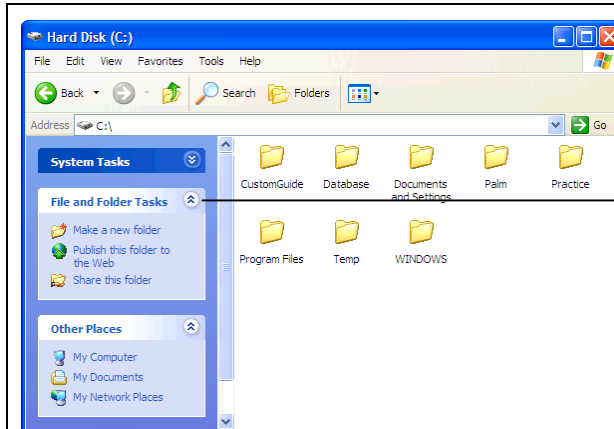

Every Windows XP folder provides easy access to common file and folder management tasks. You can select a file or folder and then click one of the tasks described in Table 8-3: File and Folder Tasks.

Figure 8-8

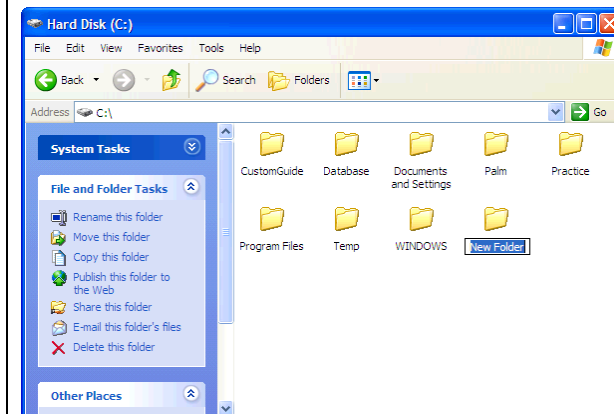
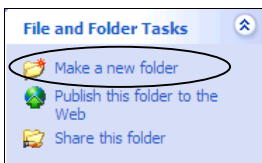

Figure 8-9



File and Folder Tasks panel

Other Ways to Create a Folder:

- Right-click on an empty area of the (C:) drive window and select **New** → **Folder** from the shortcut menu.

Windows XP comes with the My Documents folder which you can use to save your files in, but sooner or later you'll want to expand your horizons and create your own folders inside the My Documents folder or on the network to help you better organize your files. This lesson will show you how to create a new folder to hold and organize your files. You'll also learn how to rename an existing folder.

1. Click the **Start button** and select the **My Computer** icon.

The My Computer window appears after you click the My Computer icon.

2. Click the **Local Disk (C:)** icon.

The contents of the (C:) drive appear.

New to Windows XP is the *folder task pane* which makes working with files and folders even easier. If the My Computer window is small the contents of the folder task pane may be hidden from view at first.

3. If necessary, click the  **File and Folder Tasks** arrow in the folder task panel.

The contents of the File and Folder Tasks panel appear.

4. Select  **Make a new folder** task from the File and Folder Tasks panel.

A new folder appears with a temporary name “New Folder” as shown in Figure 8-9. Now all you have to do is move on to the next step and give the new folder a name.

5. Type **Practice Folder** as the name for the new folder, and then press **<Enter>**.

Your new Practice Folder is located in the root directory, or first folder, of the (C:) drive. You can create a folder inside any existing folder the same way—by opening the folder and then repeating Steps 3-5. You can create as many folders as you like to develop your own filing system to help organize your files and folders. Open the Practice Folder to display its contents.

NOTE: A file name can contain up to 255 characters, including spaces. File names cannot contain the following characters: \ / : * ? " < > |

6. Double-click the **Practice Folder** to open it.

The contents of the Practice Folder appear in the window. That’s right, there’s nothing there. The Practice Folder is an empty folder, since you just created it.

7. Click the  **Up button** to move back to the root directory.

You can easily change the name of a folder. Here’s how:

8. Click the **Practice Folder** icon.

Now let’s rename the folder. Here’s how:

9. Select  **Rename this folder** from the Files and Folders Tasks panel, type **Temp Folder** and press **<Enter>**.

The “Practice Folder” is renamed “Temp Folder.”

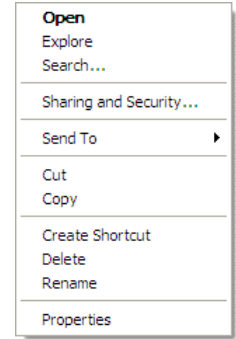

Other Ways to Rename a Folder:

- Right-click the folder and select **Rename** from the shortcut menu.

 **Quick Reference**

To Create a New Folder:

1. Open the disk or folder where you want to place the new folder.
2. Select  **Make a new folder** task from the File and Folder Tasks panel.
Or...
Select **File and Folder Tasks** → **Make a new folder** from the menu.
Or...
Right-click any empty area in the window and select **New** → **Folder** from the shortcut menu.
3. Type a name for the folder and press **<Enter>**.

To Rename a Folder:









- Click the folder to select it, select  **Rename this folder** from the Files and Folders Tasks panel, type a name for the folder and press **<Enter>**.
- Or...
- Right-click the folder, select **Rename** from the shortcut menu, type a name for the folder and press **<Enter>**.

Table 8-3: File and Folder Tasks

<i>Task</i>	<i>Description</i>
 Make a new folder	Creates a new folder.
 Rename this folder	Gives the selected file or folder a new name.
 Move this folder	Moves the selected items to the destination you choose.
 Copy this folder	Copies the selected items to the destination you choose.
 Publish this folder to the Web	Transfers a copy of the selected items to a public Web page so that you can share them with other people.
 Share this folder	Makes the selected folder available to computers on a network so that other people can access it.
 E-mail this folder’s files	Sends an e-mail message with copies of the selected items attached.
 Delete this folder	Deletes the selected items and sends them to the Recycle Bin.

Lesson 8-5: Copying, Moving, and Deleting a Folder

Figure 8-10

To move a folder, drag it to a new location on your computer, in this case to the Temp Folder.

Figure 8-11

The Move Items dialog box lets you specify where you want to move or copy a file or folder.

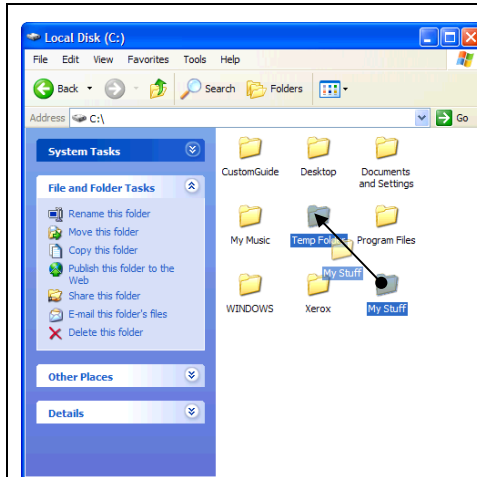

Figure 8-10

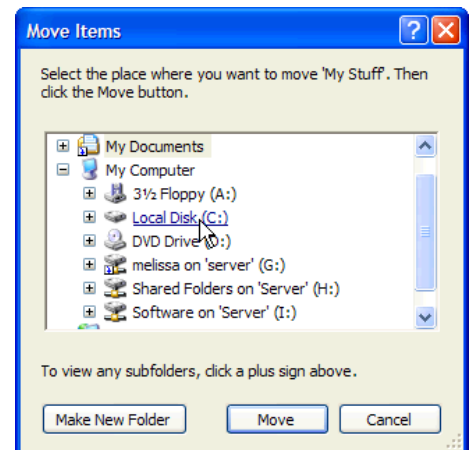

Figure 8-11

You probably don't reorganize the folders in your file cabinet very often—and you probably won't need to move or copy the folders on your computer very often either. When you find you *do* need to move or copy a folder however, you can do so by using one of two simple methods:

- Drag-and-dropping
- Using the File and Folder Tasks panel

To copy a folder, hold down the <Ctrl> key as you drag the folder to the new location.

Other Ways to Move a File or Folder:

- "Cut" the file or folder by selecting **Edit** → **Cut** from the menu or pressing <Ctrl> + <X>, moving to the desired location and then "paste" the file or folder by selecting **Edit** → **Cut** from the menu, or pressing <Ctrl> + <X>.

You'll learn how to use both methods in this lesson and how to delete a folder when you no longer need it.

- 1. Create a new folder called *My Stuff* in your (C:) drive.**
You learned how to create a folder in the previous lesson.
- 2. Drag the *My Stuff* folder to the *Temp Folder*, as shown in Figure 8-10.**

Already forgot how to drag and drop? If so, here it is one more time: position the mouse over the *My Stuff* folder, click and hold down the mouse button as you move the pointer to the *Temp Folder*, then release the mouse button. The *My Stuff* folder is moved inside the *Temp Folder*. Let's make sure we really moved the *My Stuff* folder.

- 3. Double-click the *Temp Folder* to open it.**



Yep, there's the *My Stuff* folder. Here's another method for moving folders you might want to know—using Window XP's blue side panel.

- 4. Click the *My Stuff* folder to select it.**

Once you have selected the folder you want to move, go to the File and Folder Tasks menu in the blue side panel.

5. Select  Move this folder from the File and Folder Tasks menu.

The Move Items dialog box appears, as shown in Figure 8-11. This is where you tell Windows where you want to move the selected folder. The Move Items dialog box displays the drives and folders on your computer in a *hierarchical* view. A plus symbol (⊕) or a minus symbol (⊖) beside a folder means a folder contains several subfolders. Normally these subfolders are hidden. You can display the hidden folders within a folder by clicking the plus sign (⊕) beside the folder.

6. Click the  Plus Symbol to the left of the  My Computer icon.

My Computer expands and displays its contents. The Local Disk (C:) is where you want to move the My Stuff folder.

7. Click the  Local Disk (C:) icon and click OK.

The My Stuff folder is moved from the Temp Folder back to the root directory of the (C:) drive.

8. Click the **Up button on the toolbar to move back to the root directory.**

If you can move a folder you can copy a folder—because all you need to do to copy a folder is hold down the <Ctrl> key while you drag the folder to where you want it copied.

9. Hold down the <Ctrl> key while you drag the **My Stuff folder to the **Temp Folder**.**

Although you can't see it, the My Stuff folder has been copied to the Temp Folder. Let's make sure.

10. Double-click the **Temp Folder to open it.**

The contents of the Temp Folder appear in the window. Sure enough, the My Stuff folder has been copied.

11. Click the **Up button to move back to the root directory.**

Next we'll delete a folder.

12. Click the **Temp Folder to select it and then press the <Delete> key.**

A dialog box may appear, asking you to confirm the action.

13. Click **Yes to delete the folder.**

The Temp Folder and all its contents are deleted and disappear from the window. Windows places any deleted files or folders in the Recycle Bin in case you change your mind later on and decide you want to restore the file or folder. We'll discuss the Recycle Bin in an upcoming lesson.

NOTE: Deleting a folder can be dangerous. Before you delete a folder, make sure it doesn't contain any important files. If you don't know what the contents of a folder are, you shouldn't delete it.

14. Delete the **My Stuff folder by repeating the procedure in Steps 12 and 13 and then close the My Computer window.**

We've worked on copying and moving folders to locations on the same drive, but you can also copy a folder to a different drive by dragging it to the drive icon where you want it copied. If you can't see the drive or folder where you want to move or copy something, you can open a second My Computer window and drag the folder from one window to the other.

Quick Reference

To Move a Folder:

- Drag the folder to the desired location (you might have to open another My Computer window).

Or...

1. Select the folder and click  **Move this folder** from the File and Folder Tasks menu in the side panel.
2. Select the folder or disk where you want to move the folder and click **OK**.

To Copy a Folder:

- Hold down the <Ctrl> key while you drag the folder to the desired location (you might have to open another My Computer window).

Or...

1. Select the folder and click  **Copy this folder** from the File and Folder Tasks menu in the side panel.
2. Select the folder or disk where you want to move the folder and click **OK**.

To Delete a Folder:

- Select the folder and press the <Delete> key. Click **Yes** to confirm the folder deletion.

Or...

- Select the folder and click **Delete this folder** from the File and Folder Tasks menu in the side panel. Click **Yes** to confirm the folder deletion.

Lesson 8-6: Opening, Renaming, and Deleting a File

Figure 8-12

Double-clicking the Open Me file opens it in the Notepad program.

Figure 8-13

Select a file to show all File and Folder Tasks, or right-click a file to display a list of things you can do to it.

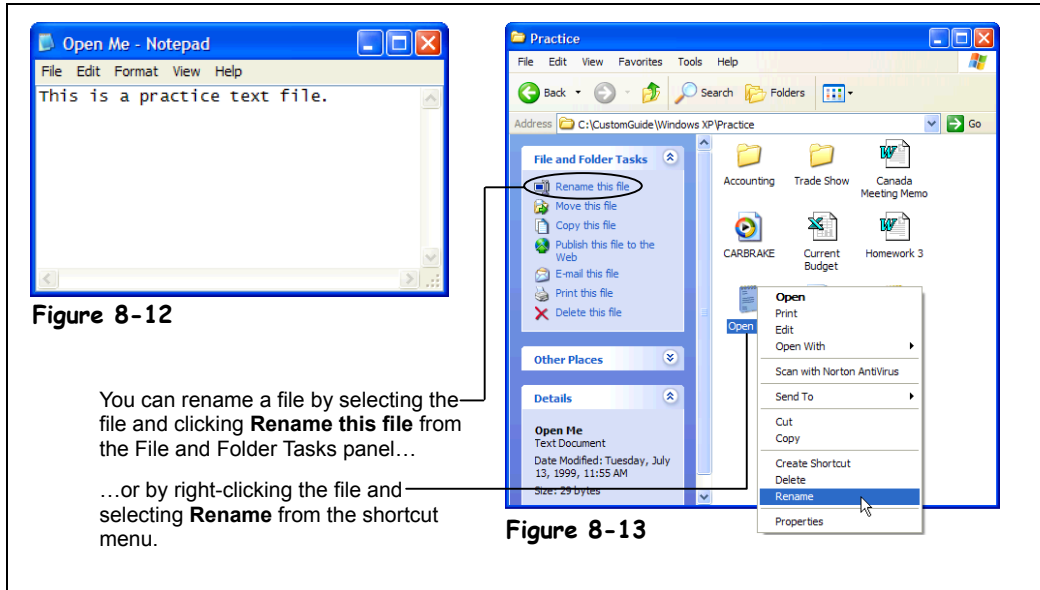

Figure 8-12

You can rename a file by selecting the file and clicking **Rename this file** from the File and Folder Tasks panel...

...or by right-clicking the file and selecting **Rename** from the shortcut menu.

Figure 8-13

In the past few lessons, you've learned all about folders—how to open, rename, move, copy, and delete them. In the next couple of lessons, we'll be working with the files that are stored in those folders. Working with files is very, very similar to working with folders. So similar, in fact, that the procedures for opening, renaming, moving, copying, and deleting a file are exactly the same as opening, renaming, moving, copying, and deleting a folder!



Start button



My Computer



Open Me

1. Click the **Start button** and select **My Computer**.

The My Computer window appears.

2. **Navigate to and open your Practice folder or floppy disk.**

Every folder window has its own toolbar that make it easy to browse through your computer's drives and folders. Two controls on this toolbar are particularly helpful:

- **Look in:** Practice **Address List:** Click to list the drives on your computer and the current folder, then select the drive and/or folder whose contents you want to display.
- **Up One Level button:** Click to move up one folder.

If necessary, follow your instructor's directions to select the appropriate drive and folder where your practice files are located.

3. **Find and double-click the Open Me file.**

The Open Me file opens in the Notepad program—the program it was created in, as shown in Figure 8-12. You could review, make changes to, and then save the Open Me file if you wanted at this point.

4. Click the Notepad program's **close button** to close the program and the Open Me file.

The Notepad program closes.

You've already learned how to rename and delete a folder, so the next few steps should be really easy for you because you rename and delete a file in exactly the same way.

5. Select the **Open Me file.**

Now we can rename the Open Me file using the File and Folder Tasks panel.

6. Select  **Rename this file from the File and Folder Tasks panel, type **Text File** as the new name for the folder, then press **<Enter>**.**

The "Open Me" file is renamed "Text File".

7. Click the **Text File to select it, and then press the **<Delete>** key.**

A dialog box may appear, asking you to confirm the file deletion.

8. Click **Yes to delete the selected file.**

The Text File is deleted and disappears from the window. Deleting a file isn't quite as dangerous as deleting a folder is, but you should always consider if you might need the file again. Don't delete a file unless you're absolutely sure you will never need it again. And NEVER delete a file if you don't know what it is.

9. Close the My Computer window.

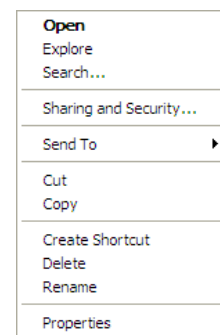

Other Ways to Rename a File:

- Right-click on the file and select **Rename** from the shortcut menu.

Other Ways to Delete a File:

- Right-click on the file and select **Delete** from the shortcut menu.

 **Quick Reference**

To Open a File:

- Double-click the file.

To Rename a File:

- Click the file to select it, select **Rename this file** from the File and Folder Tasks menu, type a name for the folder and press **<Enter>**.

Or...

- Right-click the file, select **Rename** from the shortcut menu, type a name for the folder and press **<Enter>**.

To Delete a File:

- Click the file to select it and select **Delete this file** from the File and Folder Tasks menu. Click **Yes** to confirm the folder deletion.
- Select the file and press the **<Delete>** key. Click **Yes** to confirm the folder deletion.

Lesson 8-7: Copying and Moving a File

Figure 8-14

To move a file, drag the file to the desired location.

Figure 8-15

The Copy Items dialog box.

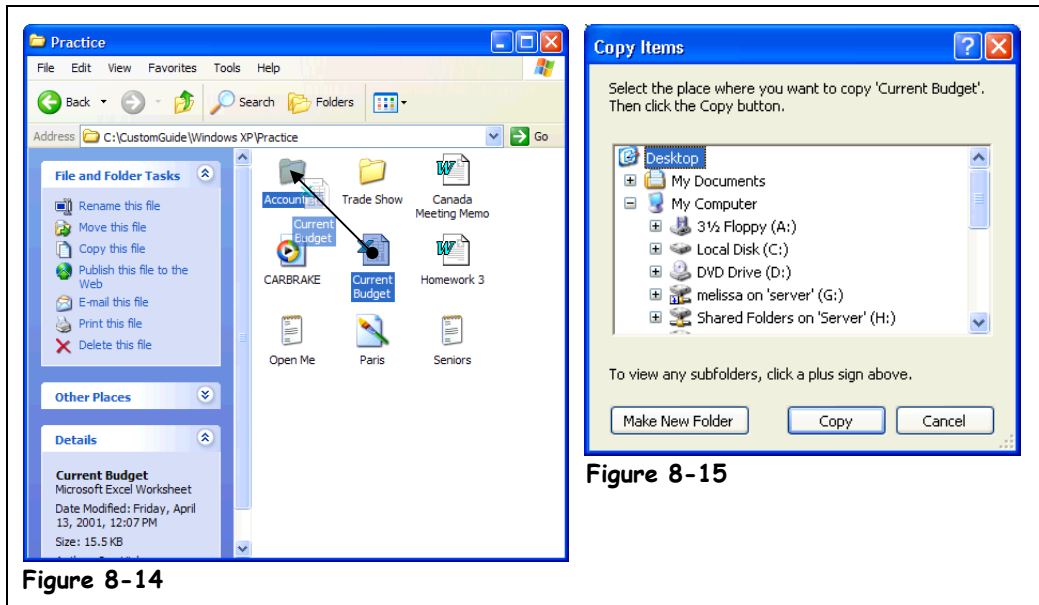

Figure 8-14

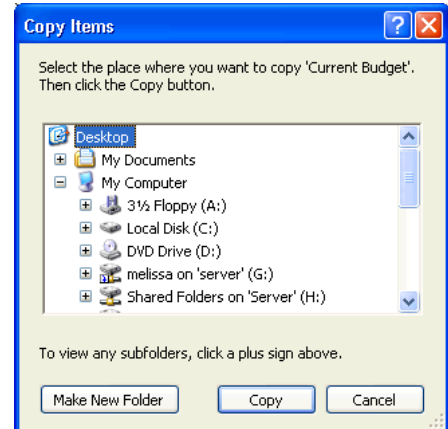

Figure 8-15



Start button



My Computer

Other Ways to Move or Copy a file:

- Click the file to select it, click Edit, and select Move to or Copy to from the menu.

Or...

- Right-click the file and select where you want to copy the file from the shortcut menu.

The procedure for moving and copying files is no different than moving or copying folders. This lesson about moving and copying files should be a refresher for you.

1. Click the **Start button** and select **My Computer**.
The My Computer window appears.
2. **Navigate to and open your Practice folder or floppy disk.**

Again, you can use the following toolbar buttons to find your way around your computer:

- **Look in:** Practice **Address List:** Click to list the drives on your computer and the current folder, then select the drive and/or folder whose contents you want to display.
- **Up One Level button:** Click to move up one folder.

If necessary, follow your instructor's directions to select the appropriate drive and folder where your practice files are located.

When copying or moving files or folders, you may find it easier if you have two windows open at the same time: one window with the source file(s) and another window for the destination where you want to move or copy the file(s).

3. **Drag the Current Budget file to the Accounting folder.**

The Current Budget file is moved to, or inside, the Accounting folder. Open the Accounting folder to make sure the file was moved.

4. **Double-click the Accounting folder to open it.**

Sure enough, the Current Budget file has been moved to the Accounting folder.

To copy a file using the drag and drop method, press the <Ctrl> key as you drag the file to a new folder.

You can also copy files.

5. Click the **Current Budget file to select it.**

Now that the file is selected, you can move it to a different location.

6. Click **Copy this file in the File and Folder Tasks panel.**

The Copy Items dialog box appears, as shown in Figure 8-15. Now you can tell Windows where you want to move the selected file.

The Copy Items dialog box displays the drives and folders on your computer in a *hierarchical* view. A plus symbol (+) or a minus symbol (−) beside a folder means a folder contains several subfolders. Normally these subfolders are hidden. You can display the hidden folders within a folder by clicking the plus sign (+) beside the folder.

Now copy the file to the Desktop of your computer.

7. Select  **Desktop in the Copy Items dialog box and click **Copy**.**

The Current Budget file is copied to your computer's Desktop.

NOTE: Some people actually do save their most important files to the Desktop so that they won't lose them. Just make sure that you don't save too many files there—nobody likes a messy desktop!

We don't want to clutter your computer's desktop with practice files, so let's delete the Current Budget files from the Desktop.

8. Close the file windows.

The windows close, allowing you to view the Desktop and the copied Current Budget file.

9. Select the **Current Budget file and press <Delete>.**

A dialog box appears, asking if you really want to delete the file.

10. Click **Yes.**

The dialog box closes and the Windows deletes the file.

 **Quick Reference**

To Move a File:

- Drag the file to the desired location (you may have to open another window).

Or...

1. Click the file to select it, and click **Move this file** from the File and Folder Tasks menu.

2. Select the folder where you want to move the file and click **OK**.

Or...

1. Select the file, click **Edit** from the menu bar, and select **Move to**.
2. Select the folder you want to move the file to and click **OK**.

To Copy a File:

1. Hold down the <Ctrl> key while you drag the file to the desired location (you might have to open another My Computer window).

Or...

1. Click the file to select it and select **Copy this file** from the File and Folder Tasks menu.

2. Select the folder where you want to copy the file and click **OK**.

Or...

1. Select the file, click **Edit** from the menu bar, and select **Copy to** from the menu.

2. Select the folder where you want to copy the file and click **OK**.

Lesson 8-8: Restoring a Deleted File and Emptying the Recycle Bin

Figure 8-16

Restoring files and emptying the Recycle Bin

Figure 8-17

The Recycle Bin shortcut menu

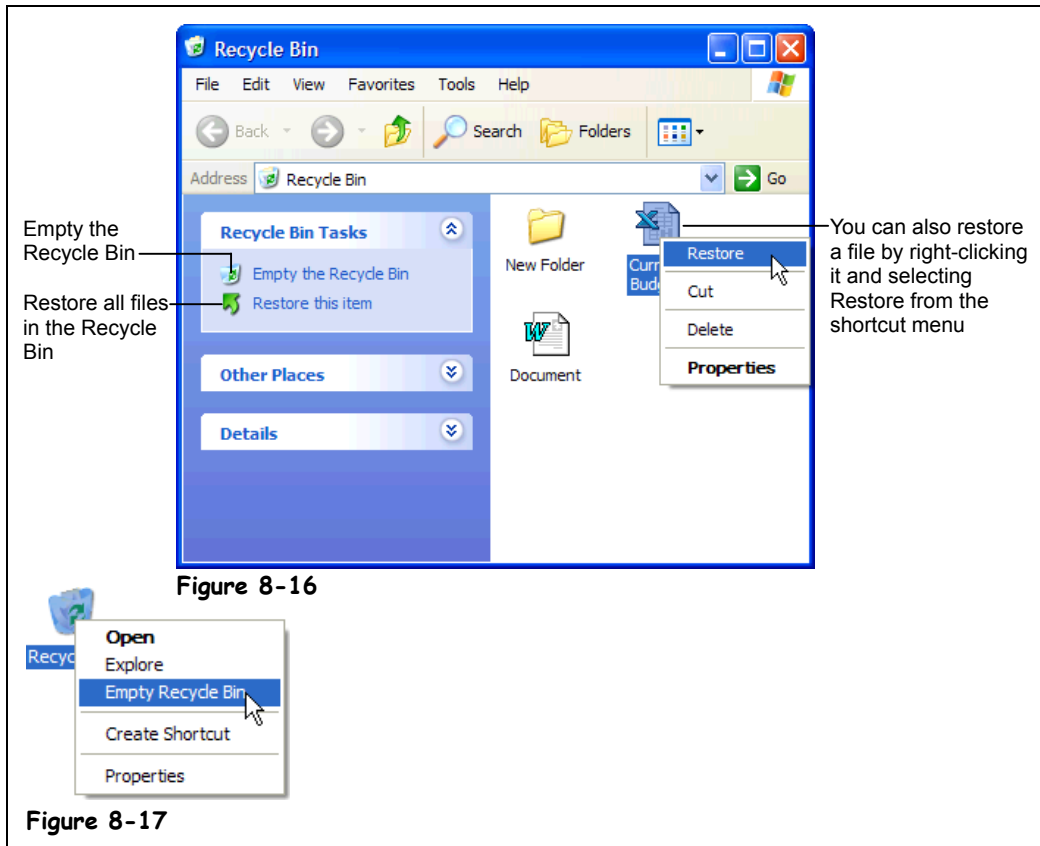

Figure 8-16

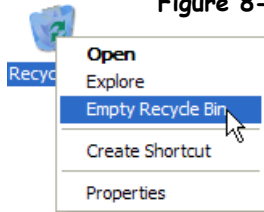

Figure 8-17



Recycle Bin contains deleted files



Recycle Bin does not contain deleted files

Just like a wastebasket, the *Recycle Bin* stores all of the files and folders you have deleted. If you change your mind and decide you need a deleted file, it's easy to find and retrieve it. This lesson will show you how to open the Recycle Bin and see what's inside, restore a previously deleted file, and empty the Recycle Bin to free up some space on your hard disk.

1. Double-click the **Recycle Bin to open it.**

The Recycle Bin opens and displays all the files you have recently deleted. If you accidentally delete a file or folder, you can retrieve it from the Recycle Bin.

2. Find and select the **Current Budget file.**

You can restore a selected file by selecting **Restore this item** from the Recycle Bin Tasks panel. Let's try it!

3. Select **Restore this item from the Recycle Bin Tasks panel.**

Restoring a file pulls it out of the Recycle Bin and puts it back in its original location.

4. Close the Recycle Bin window.

Now, make sure the Current Budget file is in its original location.

5. Verify that the **Current Budget file has been retrieved to the Desktop.**

Okay, you can delete the Current Budget file from the Desktop again, and this time we won't restore it.

6. Delete the **Current Budget** file from the Desktop.

There is theoretically a limit to how many deleted files and folders the Recycle bin can hold. The maximum size of the Recycle bin is normally set 10 percent of the hard drive. So for example, if you have a 10GB hard drive, the maximum amount of files the recycle bin could hold would be 1GB. When the Recycle Bin reaches its limit, Windows automatically starts deleting files from the Recycle bin, starting with the oldest file.

You can adjust the properties for the Recycle Bin, so you could adjust its maximum size from 10 percent of the hard drive to 5 percent, by right-clicking the Recycle Bin and selecting Properties from the shortcut menu.

Usually it's best to let Windows automatically handle the Recycle Bin, but you can also manually empty the Recycle Bin if you need more free space on your computer.

7. Double-click the **Recycle Bin** to open it.

The contents of the Recycle Bin appear.

8. Click **Empty the Recycle Bin** from the Recycle Bin Tasks panel.

A dialog box may appear and ask you to confirm your deletion.

9. Click **Yes** if asked to confirm the deletion(s).

All the files and folders are permanently deleted from your computer. Notice the Recycle Bin icon no longer displays any trash, indicating that it is empty.

NOTE: Be careful when emptying the Recycle Bin. Since Windows automatically erases the oldest files from the Recycle Bin, you shouldn't have to manually empty the Recycle Bin much at all. A lot of users empty the Recycle Bin just about every time they delete something—and then later kick themselves because they realize they needed the file they just permanently erased.

One final word about the Recycle Bin—any files you delete from a floppy disk are *not* placed in the Recycle Bin. So be extra careful when you're deleting files from a floppy disk, because the Recycle Bin won't be able to restore them.

Other Ways to Empty the Recycle Bin:

- Right-click the **Recycle Bin** and select **Empty Recycle Bin** from the menu, as shown in Figure 8-17.

Quick Reference

To Restore a Deleted File:

1. Double-click the Recycle Bin to open it.
2. Find and right-click the deleted file and select  **Restore this item** from the Recycle Bin Tasks menu.

Or...

2. Find and right-click the deleted file and select **Restore** from the shortcut menu.

To Empty the Recycle Bin:

- Right-click the Recycle Bin and select **Empty Recycle Bin** from the shortcut menu.

Lesson 8-9: A Closer Look at Files and Folders

Figure 8-18

Files display different types of icons to help you identify what type of file they are.

Figure 8-19

Every file has a three-letter extension, which is normally hidden from view, so Windows knows what type of file it is.

Figure 8-20

Files with their three-letter file extensions displayed.

Figure 8-21

A file's path name is determined first by the drive, then by the folder(s), then by the file name.

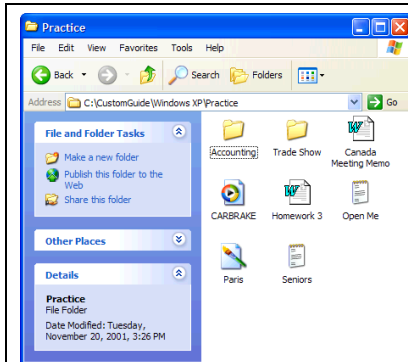

Figure 8-18

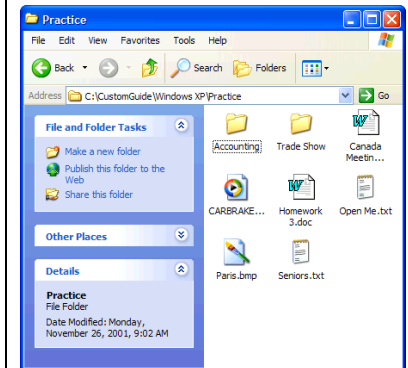

Figure 8-20

Letter to Sue.TXT

File Name

Can be up to 255 characters (although older MS-DOS programs will only see the first 8 characters, such as Letter~1.txt).

File Extension

Usually hidden from view, these three characters tell Windows what type of file it is and what type of icon to assign to it.

Figure 8-19

The **WordPad.EXE** file is located in:

In the **C:** drive...

In the **Windows** folder...

In the **Accessories** folder...

The **WordPad.EXE** file

So its path name would be:
C:\Program Files\Accessories\WordPad.EXE

Figure 8-21











A **root folder**, or **directory**, is the first folder from which all the other folders branch. When you double-click the **C:** Hard Drive icon, the window shows the contents of the root folder of the **C** drive.

In this lesson, we'll take a break from all that pointing, clicking, dropping, and dragging and take a closer look at files. When you're viewing the contents of your computer, you've probably already noticed that everything has its own picture or icon to represent what it is. Except for a few exceptions, folder icons always look like little manila folders (📁). Files, on the other hand, come in a variety of types and icons.

There are two parts to every file: the file name, which you've already seen and are familiar with; and the file extension, a three letter extension that tells Windows what type of file it is (see Figure 8-19). Since Windows assigns pictures or icons to the types of files it recognizes, it normally hides these file extensions from view. Whenever you open a file by double-clicking it, Windows automatically opens the file in the program it knows created the file. For example, Microsoft Word always adds the file extension DOC to its files, so when you double-click a DOC file, Windows knows it has to open the file in Microsoft Word.

Another file and folder related term you might hear is *path*. A path is the drive and folder(s) where a file or folder is located—think of it as a street address. A path contains the drive letter, followed by a colon, followed by any folders (which must be separated by backslashes \), and last comes the name of the file. For example C:\Program Files\Accessories\WordPad.EXE (see Figure 8-21 for an illustration).

Table 8-4: Common Files Types

<i>File</i>	<i>Description</i>
 <p>MS-DOS Program</p>	MS-DOS programs are written for an earlier, more primitive operating system than Windows. MS-DOS programs don't have the fancy graphics, icons, and features of more-advanced Windows programs. All Windows or DOS programs have .EXE, or sometimes .COM, extensions. EXE stands for <i>executable</i> , meaning the file is a program that will run or execute when you open it.
 <p>Unknown File Type</p>	Windows doesn't know what type of file this is, so you can't readily open it by double-clicking it. That doesn't mean the file isn't important – it's probably a very important file for Windows or a program. Leave these files alone unless you absolutely know what they are for.
 <p>Word Document</p>	This is a document created in the word processing program, Microsoft Word. Word documents normally have a .DOC extension.
 <p>Excel Workbook</p>	This is a spreadsheet created with the program Microsoft Excel. Excel spreadsheets normally have a .XLS extension.
 <p>Paint File (BMP)</p>	This is a graphic file or picture, which was created in Paint or another graphics program. These files are also sometimes referred to as bitmaps. The extension for this particular type of graphic file is BMP or bitmap. There are also other types of graphic files that use different extensions and icons.
 <p>JPEG File</p>	Another very popular graphic file, most of the photographs you see on the Internet are JPEGs.
 <p>Text File</p>	Text or ASCII files are simple files that only contain text – no formatting, graphics, or any fancy stuff. Text files usually have a .TXT extension.
 <p>Shortcut File</p>	Shortcut files point to files and folders elsewhere on your computer so that you can quickly open that file, folder, or program without having to go to its actual location. All of the Programs in the Start Menu and some of the items on your desktop are actually shortcuts that point to the program files, located elsewhere on your computer. Shortcuts only point to files or folders, so moving, renaming, or deleting a shortcut does not affect the original program or file in any way. You can tell the difference between a shortcut and original file because the shortcut has an arrow (📌) in the lower left corner.
 <p>Setup Program File</p>	Setup files are special executable (EXE) program files, except instead of running a program when opened, they install software programs onto your computer.

Since Windows assigns pictures to help you distinguish between the different types of files, normally the three letter file extensions are hidden from view, but you can tell Windows to display the extension—we'll cover that when learn how to customize Windows.

Lesson 8-10: Changing How Information is Displayed

Figure 8-22

A bullet (●) appears next to the current view. Here the window is displayed in Icons view.

Figure 8-23

The window displayed in Details view

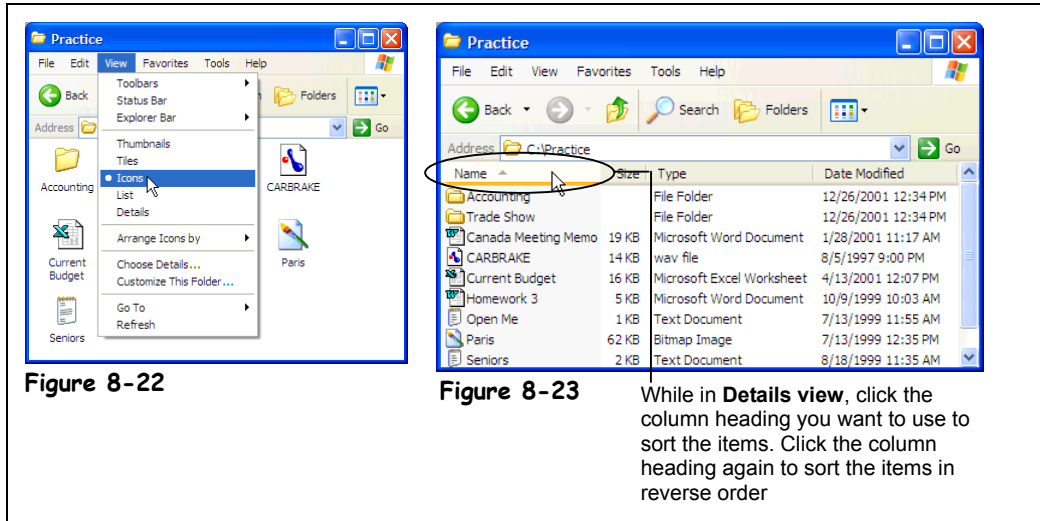

Figure 8-22

Figure 8-23

While in **Details** view, click the column heading you want to use to sort the items. Click the column heading again to sort the items in reverse order

When you work with files and folders on your computer, you may find that you need to change how you view information on the screen. This lesson will show you how to change the appearance of items using one of four view modes: Thumbnails, Icons, Tiles, List, or Details. Experiment to find the view that works best for you. You'll also learn how to change the order in which files and folders are sorted. You can sort the contents files and folders by name, date (when they were created), size, and type (what type of file they are).



Start button



My Computer

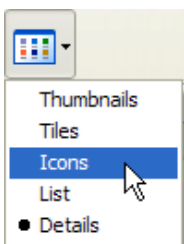

Other Ways to Change Views:

- Select a view from the **View button list arrow** on the toolbar.

1. Click the **Start button** and select **My Computer**.
The My Computer window appears.
2. **Navigate to and open your Practice folder or floppy disk.**
Windows normally displays items as icons by default.
3. **Verify that you are viewing your computer's contents as icons by selecting View → Icons from the menu.**
You can display more items in a window at a time by using List view. Try switching to List view now.
4. **Select View → List from the menu.**
The items are displayed as small icons in a list. Details view displays information about each item, including the name, size, type of item, and when it was created or last modified.
5. **Select View → Details from the menu.**
You can sort items in a variety of ways: alphabetically by name, by size, or even by the date they were last modified or saved. If you're in Details view, all you have to do to sort the items is click the heading for the column you want to use.
6. **Click the Name heading to sort the items by name.**
The list is sorted alphabetically by name. Clicking the heading again sorts the items in reverse order (Z-A).

7. Select **View** → **Icons** from the menu.

You can have Windows arrange and organize items so they appear in neat columns and rows, instead of a cluttered mess.

8. Select **View** → **Arrange Icons by** → **Auto Arrange** from the menu.

A check mark (✓) appears by Auto Arrange when this feature is on. (You can skip step 8 if Auto Arrange already has a check mark). Now, whenever you change the size of a window, or add, move, or delete a file, Windows will automatically rearrange the items.

9. Select **View** → **Arrange Icons by** → **Name** from the menu.

The list is sorted alphabetically by name.

Table 8-5: Different Methods of Viewing Items

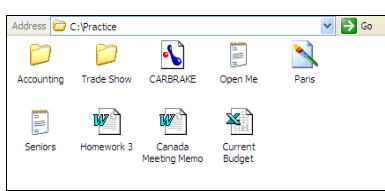
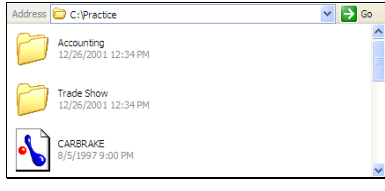
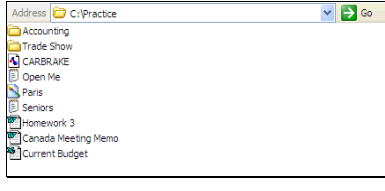
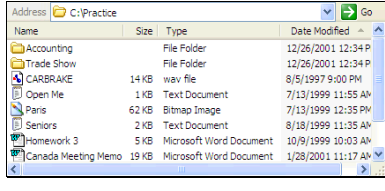
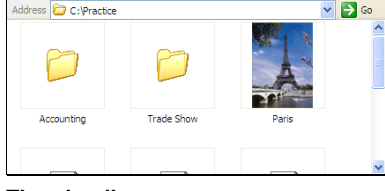
View	Description
 <p>Icons</p>	Files and folders are displayed as icons. This is a good view for when you're learning how to use Windows or have trouble clicking a file with the mouse.
 <p>Tiles</p>	Files and folders are displayed as icons, but with more information. The type and size of a file is displayed to the right of the icon.
 <p>List</p>	Files and folders are displayed as small icons in a list. This is a great default view, because it allows you to see as many files as possible.
 <p>Details</p>	Displays information about every file and folder, such as its name, size, type, and when it was last modified is displayed. You can change the order the list is sorted by clicking the column headings.
 <p>Thumbnails</p>	Thumbnails view is useful if you are working with pictures and graphics because it previews every graphic file instead of only displaying an unhelpful file name.

 **Quick Reference**

To Change How Items are Displayed:

- Select **View** from the menu bar and select from one of the five view modes (Thumbnails, Tiles, Icons, List, or Details).

Or...

- Select a view from the **View button list arrow** on the toolbar.

To Change How Items are Sorted:

1. Follow the above step to display the window in **Details View**.
2. Click the **column heading** you want to use to sort the window. Click the column heading again to sort in reverse order.

To Automatically Arrange Icons:

- Select **View** → **Arrange Icons by** → **Auto Arrange** from the menu.

Lesson 8-11: Selecting Multiple Files and Folders

Figure 8-24

To select several files that are next to each other, hold down the mouse button and drag a rectangle around the files you want to select.

Figure 8-25

When you want to select a group of consecutive files, select the first file you want to select, hold down the <Shift> key and click the last file.

Figure 8-26

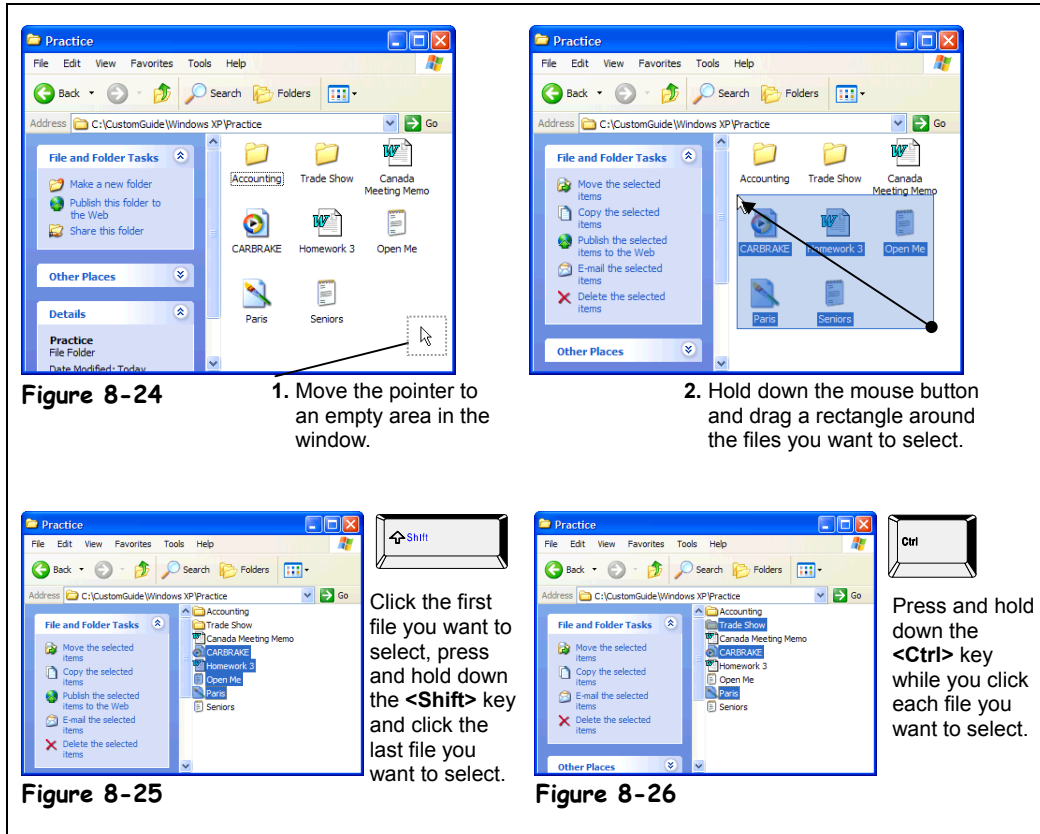

Use the <Ctrl> key when you want to select several random files.



By now, you know that you must select a file or folder before you can do something to it, such as move or delete it. In this lesson, you will learn how to select more than one file and/or folder at a time, so you can move, copy, or delete a group of files at the same time.

1. Navigate to and open your Practice folder or floppy disk.

Again, you can use the following toolbar buttons to find your way around your computer:

-  **Address List:** Click to list the drives on your computer and the current folder, then select the drive and/or folder whose contents you want to display.
-  **Up One Level button:** Click to move up one folder.

If necessary, follow your instructor's directions to select the appropriate drive and folder where your practice files are located.

First, let's review how to select a single file.

2. Click the **Paris** file to select it.

The Paris file is highlighted, indicating that it is selected. Now you could delete, move, or copy the Paris file. To deselect a file, just click in any empty area on the window.

3. Click any empty area of the window to deselect the Paris file.

The Paris file is no longer selected.

You can select more than one file or folder at a time, so you can delete, move, or copy a whole bunch of files at once. Like so many Windows functions, there are several methods to select multiple files. If the files you want to select are next to each other, you can move mouse pointer to empty area on the screen, hold down the mouse button and drag a rectangle around the files you want to select, as shown in Figure 8-24.

4. Move the pointer to any empty area in the folder window, click and hold down the mouse button, and drag a rectangle around several files, as shown in Figure 8-24.

The only problem with this method is that it only works when you want to select files that are next to each other.

5. Click any empty area of the screen to deselect the files.

Another method of selecting adjacent files and folders is to click the first file you want to select, hold down the <Shift> key as you click the last file of the group of files you want to select.

6. Click the Carbrake file to select it, press and hold the <Shift> key as you click the Paris file.

You've selected the Carbrake file, the Paris file, and all the files that are in between the two.

7. Click any empty area of the screen to deselect the files.

To select random, or non-adjacent files and folders, hold down the <Ctrl> key, and then click each item you want to select.

8. Click the Carbrake file to select it, press and hold down the <Ctrl> key, click Paris file, and the Trade Show folder, then release the <Ctrl> key.

Remember, you can move, copy, or delete any selected files all at once. Holding down the <Ctrl> key also lets you click and deselect any selected files.

9. With the files still selected, click and drag one of the selected files (the Carbrake, or Paris files, or the Trade Show folder) from the folder window to the desktop.

The selected files are copied to the desktop.

10. With the newly copied files still selected on the desktop, press the <Delete> key.

The selected files are all deleted from the desktop.

To select all the files and folders in the window, select Edit → Select All from the menu.

11. Select Edit → Select All from the menu.

All the files in the window are selected.

12. Close the window to end this lesson.**Other Ways to move or copy a file:**

- Click the file to select it, click Edit, and select Move to or Copy to from the menu.

Or...

- Right-click the file and select where you want to copy the file from the shortcut menu.

Quick Reference**To Select Multiple Files:**

- If the files are next to each other you can click and drag a rectangle around the files you want to select.

Or...

- If the files are next to each other you can click the first file you want to select, press and hold down the <Shift> key and click the last file you want to select.
- If the files aren't next to each other you can select random files by holding the <Ctrl> key and clicking the files you want to select.

Lesson 8-12: Finding a File Using the Search Companion

Figure 8-27

The Search Companion guides your search by asking questions about your search.

Figure 8-28

Beginning a music file search

Figure 8-29

The search results window

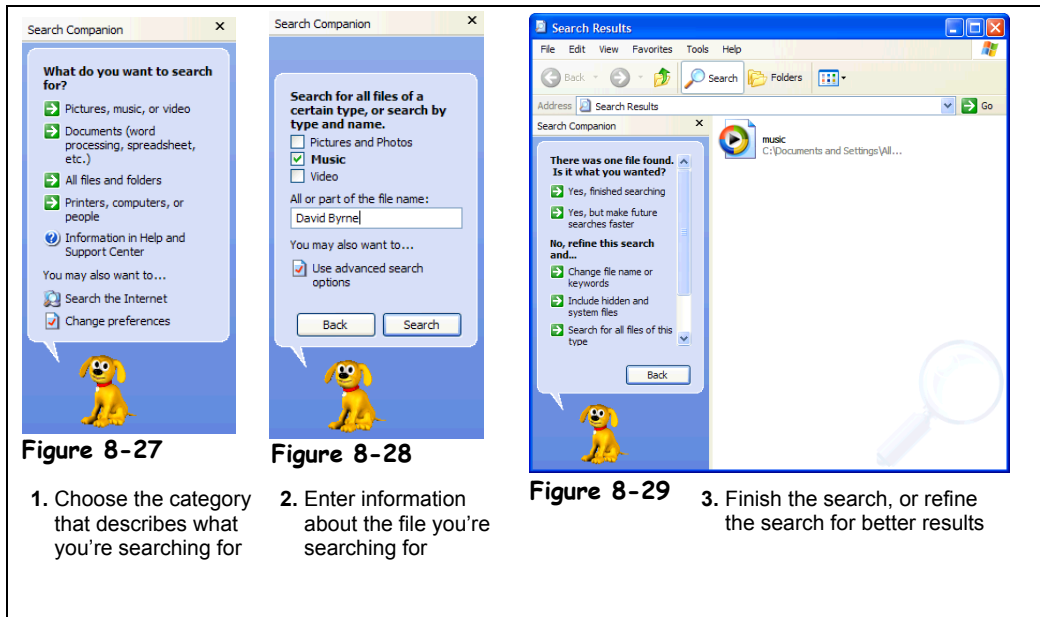

1. Choose the category that describes what you're searching for

2. Enter information about the file you're searching for

Figure 8-29

3. Finish the search, or refine the search for better results

It's just as easy to misplace and lose a file in your computer as it is to misplace your car keys—maybe easier! Luckily, Microsoft has simplified the search process by introducing the Search Companion to Windows XP. A cousin of the Office Assistant, the Search Companion helps you organize your search by asking certain questions, such as what you want to search for (i.e. picture or file), which drive to search in, and the file name.

The Search Companion can search for files even when you can't remember the exact file name or location.

You can search for a file by:

- The file name or any part of the file name
- The date the file was created or modified
- The type of file, such as a Microsoft Word document or graphic file
- The text within the file
- The size of the file

You can set one or several of these criteria to search for a file.

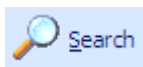

The Search Command

1. Click the **Start** menu and select **Search**.

The Search window appears with the Search Companion in the blue side panel, as shown in Figure 8-27.

The Search Companion will ask you different questions to help you with your search. For now, let's search for a music file.

2. Click **Pictures, music, or video**.

The "Search for all files of a certain type, or search by type and name" dialog box appears.

3. Check the **Music** box, type **David Byrne** in the text field as shown in Figure 8-28, and click **Search**.

The Search Companion begins searching for the file, and displays the names and locations of all the files it finds that have the words David Byrne in their names. You can open any of these files by double-clicking them.

4. Double-click the **music** file.

The music file begins playing in the Windows Media program.

5. Close the **Windows Media** program.

If you don't quite remember the file name, you can always search by when you last modified the file, or by the size of the file. We won't do a search using these criterion right now, but we can at least go ahead and get to know where they are a little better.

6. To start a new search, click the **Search button** on the toolbar.

The first Search Companion dialog box reappears.

7. Click the **All Files and Folders** option.

A dialog box appears, giving options to search by file name, text within the file, location of the file, when it was last modified, size of the file, and other advanced search options to choose from.

8. Type **Practice folder** in the search options dialog box, and click **Search**.

The Search Companion searches for folder, and displays all finds in the results window.

9. Close the **Search Results** window.



Search button

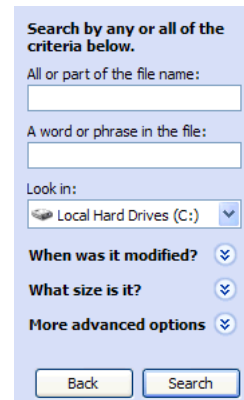

Search Options

Table 8-6: Search Options

Search For	Description
Pictures, music, or video	Search for pictures and digital photos (.jpg, .gif, and .bmp) files, music (.mp3) files, and digital video (.avi and mpeg) files.
Documents (word processing, spreadsheet, etc.)	Search for files created with a program, such as Microsoft Access (.mdb), Microsoft Excel (.xls), Microsoft PowerPoint (.ppt), Microsoft Word (.doc), or Notepad (.txt)
All files and folders	Search for all types of files and folders.
Computer or people	Search for computers on your network or the name of a person in your address book.
Information in Help and Support Center	Search for information in Microsoft Windows XP's built-in Help system.
Search the Internet	Search the Internet for information on a key word or phrase.
Change Preferences	Change your search preferences, such as if you want to display an animated character or if you want to use advanced search options.

Quick Reference

Use the Search Companion to Find a File:

1. Select **Search** from the Start menu.
2. Click the **type of file you want to search for**.
3. Enter part of the file name or text within the file. You can also search for files using the drop-down lists at the bottom of the dialog box.
4. Click **Search** to start searching for the file(s).

Lesson 8-13: Using the Folders Pane (Windows Explorer)

Figure 8-30

The Windows Explorer window

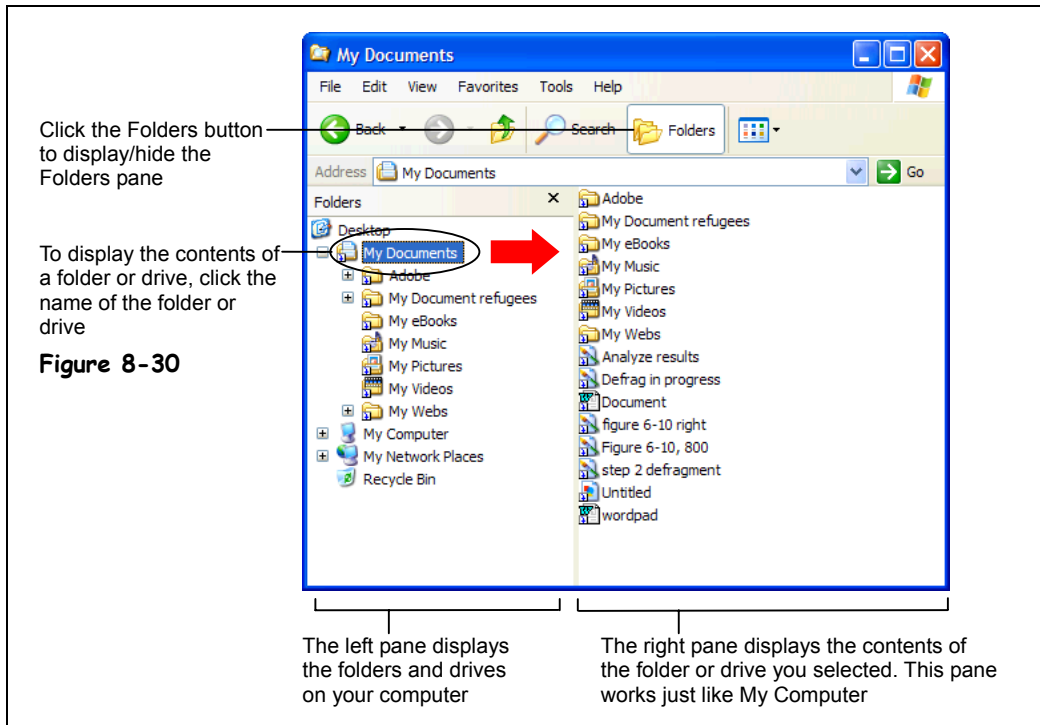

A plus symbol (+) next to a folder indicates that all the subfolders it contains are hidden. Click the plus symbol to display the hidden subfolders.

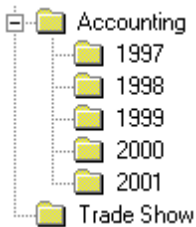

A minus symbol (-) next to a folder indicates that all the subfolders it contains are displayed. Click the minus symbol to collapse or hide the subfolders.

If you have been following the lessons in this chapter and haven't been skipping ahead, by now you should know just about everything there is to know about file management. You learned that you can use the My Computer program to view the contents of your drives, and how to create, open, rename, copy, move, and delete files and folders.

This lesson introduces the *folders pane* (Windows Explorer), which you can use to view and work with the contents of your computer. The folders pane lets you see the organization of all the folders on your computer, as shown in Figure 8-30. The folder pane is especially useful for when you want to copy and move files—you can drag the files from the left pane to the appropriate folder in the right pane. To view the folders pane, simply click the Folders button from anywhere in My Computer.

If you're a Windows 95, 98, or NT user, the folder pane replaces Windows Explorer; click the Folders button anytime you want to view or work with the folders on your computer.

1. Click **My Computer** from the Start menu.

The familiar My Computer window appears. In Windows XP you can view the My Computer folders pane at any time—all you have to do is click the *Folders button* on the toolbar.

2. Click the **Folders** button on the toolbar

The Windows Explorer folder pane appears. The drives and folders in the right pane of the window are the contents of your computer. You can see what's in a drive or folder by clicking it in the left Folders pane.

3. Click **My Documents in the left pane of the Explorer window.**

Explorer displays the contents of My Documents in the right pane of the window, as shown in Figure 8-30. Move on to the next step and we'll look at the contents of the hard drive.

4. Click the **Local Disk (C:) in the left pane of the Explorer window.**

Explorer displays the contents of the hard drive in the right pane of the window. The left pane of Windows Explorer displays the drives and folders in a *hierarchical* view. A plus symbol or a minus symbol beside a folder means a folder contains several subfolders. Normally these subfolders are hidden. You can display the hidden folders within a folder by clicking the plus sign beside the folder.

5. Click the **plus symbol beside the **Windows** folder.**

The Windows folder expands and displays all the folders within it. The plus symbol changes to a minus symbol, indicating the folder is expanded and is displaying all the folders within it. Notice some of the Windows subfolders also have pluses by them, indicating that they contain several subfolders.

6. Click the **Windows folder in the left pane of the Explorer window to select it.**

The contents of the Windows folder appear in the right pane of the Explorer window. Notice the subfolders in the Windows folder are displayed in both the left and right panes.

You can collapse or hide folders to reduce the amount of information that is on the screen. To collapse a folder, click the minus sign beside the folder.

7. Click the **minus symbol beside the **Windows** folder.**

The Windows folder collapses all its subfolders are hidden from view. The minus symbol changes to a plus symbol, indicating that all the subfolders in the Windows folder are hidden from view.

You can adjust the size of either pane of the window.

8. Position the mouse over the bar separating the two sides of the window until the mouse pointer changes to a , then drag the bar to the right or left about a half-inch.

Just like in My Computer, you can change how information is displayed by using the View menu.

9. Select **View → **Icons** from the menu.**

The contents in the right pane of Explorer are displayed in Icon View.

10. Select **View → **List** from the menu.**

The contents in the right pane of Explorer are displayed in List View.

It's important to remember that the right pane is still My Computer, so the procedures for creating, opening, renaming, moving, copying, and deleting files and folders are exactly the same.



If there isn't a symbol next to a folder, the folder does not contain any subfolders, although it may still contain files.



The mouse pointer changes shapes over a border.

Quick Reference

To Display the Folders Pane (Windows Explorer):

- Open **My Computer** and click the **Folders** button on the toolbar.

To View the Contents of a Drive or Folder:

- Click the drive or folder in the left folder pane—the contents of that drive or folder will appear in the right pane.

To Display or Hide a Drive or Folder's Subfolders:

- Click plus symbol (⊕) to display any hidden subfolders, click the minus symbol (⊖) to hide any subfolders.

To Adjust the Size of Windows Explorer's Panes:

- Drag the bar separating the two panes to the right or left.

Lesson 8-14: File Management Using the Folders Pane

Figure 8-31

You can move and copy files using drag and drop in Windows Explorer.

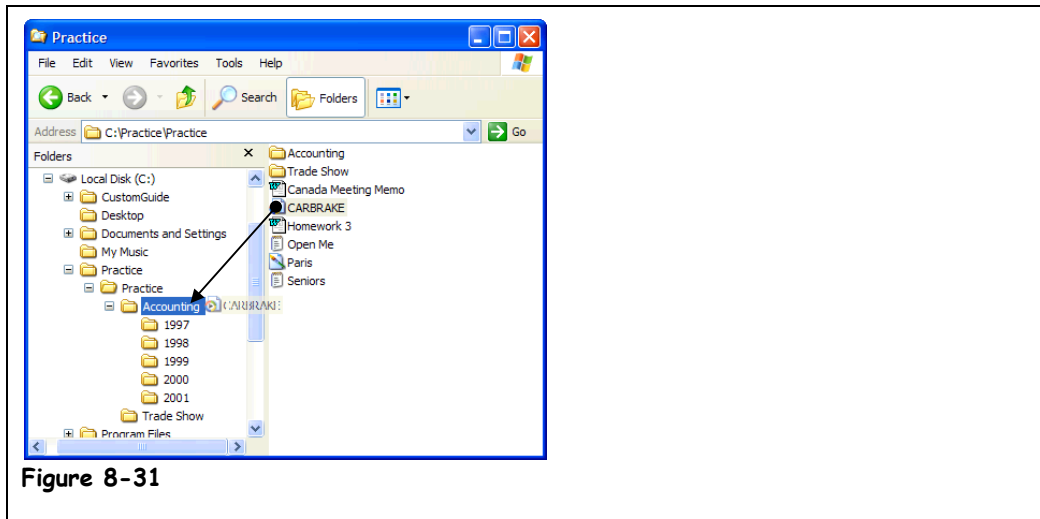

Figure 8-31

In this lesson, you'll learn how to perform basic file management in the folders pane. Specifically, you'll move a file and create a new folder. Again, although the folders pane looks a little different than the rest of the My Computer screen, all the file management procedures you've learned work exactly the same. If you've followed the other lessons, this should be one of the easiest lessons in the chapter.

1. **Make sure My Computer is open with the Folders pane displayed.**
Remember that all you have to do to view the Folders pane is click the Folders button on the toolbar.
2. **Click the **Local Disk (C:)** drive icon in the left Folders pane.**
The contents of the (C:) drive appear in the right pane of My Computer, and it expands in the left pane to show its subfolders.
3. **Click the **plus symbol** beside the **Practice** folder to display its contents.**
The folder expands and displays all the files inside it, and the plus symbol (⊕) changes to a minus symbol. Since you can see all the files in the right pane, it's much easier to move and copy files and folders.
4. **Hold down the **<Ctrl>** key while you click and drag the **Open Me** file to the **Accounting** folder, as shown in Figure 8-31.**
It doesn't matter if you drag and drop the Open Me file to the Accounting folder in the left pane or the right pane—they're both the same folder. The Open Me file is copied to the Accounting folder. Move on to the next step and let's see if you can create a new folder while the Folders pane is displayed.
5. **Create a new folder named **2002** in the root directory of the (C:) drive.**
Need a refresher on how to create a folder? First you need to click the (C:) drive in the left folder pane to select it and display its contents in the right pane. Next, click Make a new folder from the File and Folder Tasks menu in the blue side bar, type 2002, and press <Enter>.

6. Move the **2002** folder in the root directory of the (C:) drive to the **Accounting folder** by dragging the **2002** folder from the right pane to the **Accounting folder** in the left pane.

Verify that the 2002 folder was moved inside the Accounting folder.

7. Click the **plus symbol** beside the **Accounting** folder to display the files in the Accounting folder.

The Accounting folder expands and displays all the folders inside it. Try deleting a folder using Windows Explorer—you already know the technique.

8. Click the **2001** folder to select it, press the **<Delete>** key, and then confirm the deletion.

It doesn't matter if you use the left or right pane to select a folder—they're the same folder, and you can rename, copy, move, and delete folders in either pane of the window.

9. Close the **My Computer** window to end this lesson.

Congratulations! You've just about completed what is probably the most difficult chapter in the book. Move on to the review sections and see how much you've learned.

Quick Reference

To Open a File or Folder:

- Double-click the file or folder.

To Move a File or Folder:

- Drag the file or folder to the desired location in either pane of the window.

To Copy a File or Folder:

- Hold down the **<Ctrl>** key while you drag the file or folder to the desired location in either pane of the window.

To Create a New Folder:

1. Click the disk or folder where you want to put the new folder.
2. Click **Make a new folder** in the File and Folder Tasks menu.
3. Type a name for the folder and press **<Enter>**.

To Delete a File or Folder:

- Select the file or folder and press the **<Delete>** key. Click **Yes** to confirm the deletion.

To Rename a File or Folder:

- Right-click the file or folder, select **Rename** from the shortcut menu, type the new name and press **<Enter>**.

Chapter Eight Review

Lesson Summary

Understanding Storage Devices, Folders, and Files

- Computers store information using files and folders, on disks drives, just like you store information in a file cabinet.
- Know the following memory terminology:

Term	Size
Byte	A single character such as the letter j or number 8.
Kilobyte (K or KB)	1,024 bytes – a typed page.
Megabyte (MB or MEG)	1,048,578 bytes – a novel.
Gigabyte (GB or GIG)	Several encyclopedia sets.



Using My Computer to See What's in Your Computer

- Double-click the **My Computer** icon on the Windows Desktop displays the contents of your computer.
- Double-click a disk drive in the My Computer window to display the disk drive's contents.
- To View the Properties of Something:** Right-click the object and select **Properties** from the shortcut menu. For example, right-clicking a hard drive and selecting **Properties** from the shortcut menu would display how much space is left on the hard disk.



Opening a Folder

- Double-click a folder to open it and display its contents.
- To Move Back or Up to the Previous Level or Folder:** Click the **Up** button on the toolbar, click the **Back** button on the toolbar, or click the **Address Bar** on the toolbar and select the appropriate drive or folder.

Creating and Renaming a Folder

- To Create a New Folder:** Open the disk or folder where you want to put the new folder. Select  **Make a new folder task** from the File and Folder Tasks panel, or, right-click any empty area in the window and select **New** → **Folder** from the shortcut menu, or select **File** → **New** → **Folder** from the menu. Type a name for the folder and press **<Enter>**.
- To Rename a Folder:** Click the folder to select it, select  **Rename this folder** from the Files and Folders Tasks panel, type a name for the folder and press **<Enter>**. You can also rename a folder by clicking the folder to select it, selecting **File** → **Rename** from the menu, typing a name for the folder and pressing **<Enter>**.



Copying, Moving, and Deleting a Folder

- **Move a Folder (Drag and Drop Method):** Move a folder by dragging it to the desired location, such as another folder or on the desktop (you might have to open another My Computer window if you want to copy it to another folder).
- **Move a Folder:** Click the folder to select it and click  **Move this folder** from the File and Folder Tasks menu, select the folder or disk where you want to move the folder and click **OK**.
- **Copy a Folder (Drag and Drop Method):** Hold down the **<Ctrl>** key while you drag the folder to the desired location (you might have to open another My Computer window if you want to copy it to another folder).
- **Copy a Folder:** Click the folder to select it, click  **Copy this folder** from the File and Folder Tasks menu, select the folder or disk where you want to move the folder and click **OK**.
- **To Delete a Folder:** Select the folder and press the **<Delete>** key. Click **Yes** to confirm the folder deletion.

Opening, Renaming, and Deleting a File

- Double-click a file to open the file in the program that created it.
- **To Rename a File:** Click the file to select it, select  **Rename this file** from the Files and Folders Tasks panel, enter the file's new name and press **<Enter>**. Or, right-click the file, select **Rename** from the shortcut menu, type a name for the folder and press **<Enter>**. You can also rename a file by clicking the file to select it, selecting **File** → **Rename** from the menu, typing a name for the folder and pressing **<Enter>**.

Copying and Moving a File

- You can copy and move files the same as you copy and move folders.
- **Move a File:** Click the file to select it and click  **Move this file** from the File and Folder Tasks menu, select the folder or disk where you want to move the file and click **OK**.
- **Copy a File (Drag and Drop Method):** Hold down the **<Ctrl>** key while you drag the file to the desired location (you might have to open another My Computer window if you want to copy it to another folder).
- **Copy a File:** Click the file to select it, click  **Copy this file** from the File and Folder Tasks menu, select the folder or disk where you want to move the file and click **OK**.
- **To Copy a File or Folder to a Floppy Disk:** Right-click the file or folder and select **Send To** → **3½ Floppy (A:)** from the shortcut menu.

Restoring a Deleted File and Emptying the Recycle Bin

- **To Restore a Deleted File:** Double-click the Recycle Bin to open it. Click the file to select it and click  **Restore this file** from the Recycle Bin Tasks menu. Or, right-click the deleted file and select **Restore** from the shortcut menu.
- **To Empty the Recycle Bin:** Right-click the Recycle Bin and select **Empty Recycle Bin** from the shortcut menu.

A Closer Look at Files and Folders

- There are two parts to a file: the file name, which can be up to 255 characters and the file extension, which is three characters long and tells Windows what type of file it is.

Changing how Information is Displayed

- **To Change How Items are Displayed:** Select **View** from the menu and select one of the five view modes or select a view from the **View button list arrow** on the toolbar.
- The five view modes are Thumbnails, Tiles, Icons, List, and Details.

Selecting Multiple Files and Folders

- By selecting multiple files and folders you can move, copy, or delete a group of files and folders all at once.
- If the files are next to each other you can click and drag a rectangle around the files you want to select.
- If the files are next to each other you can click the first file you want to select, press and hold down the **<Shift>** key, and click the last file you want to select.
- If the files aren't next to each other you can select random files by holding the **<Ctrl>** key and clicking the files you want to select.

Finding a File Using the Search Companion

- **To Find a File:** Click the **Start** button and select **Search** from the Start menu. Use the Search Companion to enter information (file name, size, type, text within the file, date it was last modified, etc.) about the file you're searching for.

Using the Folders Pane (Windows Explorer)

- The folders pane lets you view and manage the contents of your computer. This was a separate program called *Explorer* in previous versions of Windows.
- **To Display the Folders Pane:** Open **My Computer** and click the **Folders** button on the toolbar.
- A plus symbol (+) next to a folder indicates that all the subfolders it contains are hidden. Click the plus symbol to display the hidden subfolders.
- A minus symbol (-) next to a folder indicates that all the subfolders it contains are displayed. Click the minus symbol to collapse or hide the subfolders.
- No symbol next to a folder indicates that the folder does not contain any subfolders, although it may still contain files.
- **To View the Contents of a Drive or Folder:** Click the drive or folder in the left folder pane—the contents of that drive or folder will appear in the right pane.
- **To Adjust the Size of Windows Explorer's Panes:** Drag the bar separating the two panes to the right or left.

File Management Using the Folders Pane

- **To Open a File or Folder:** Double-click the file or folder.
- **To Move a File or Folder:** Drag the file or folder to the desired location in either pane of the window.
- **To Copy a File or Folder:** Hold down the **<Ctrl>** key while you drag the file or folder to the desired location in either pane of the window.

- **To Create a New Folder:** Click the disk or folder where you want to put the new folder, right-click any empty area in the window and select **New** → **Folder** from the shortcut menu. Type a name for the folder and press **<Enter>**.
- **To Delete a File or Folder:** Right-click the file or folder, select **Delete** from the shortcut menu, type the new name and press **Yes**.

Quiz

- 1. Computers store information on which types of disks? (Select all that apply.)**
 - A. Floppy disks.
 - B. Hard disks.
 - C. Compact discs (CD-ROMs).
 - D. Removable disks.
- 2. Drives are named with one letter. Most computers have a floppy disk called (A:) and a hard disk called (C:). (True or False?)**
- 3. The purpose of your computer's folders is to: (Select all that apply).**
 - A. Lose your important files.
 - B. Store related files and programs in the same place.
 - C. Make it difficult to delete things unless you really know what you're doing.
 - D. Organize related files and information on your computer.
- 4. .TXT, .DOC, and .BMP — these are all examples of:**
 - A. Three meaningless letters with a period in front of them.
 - B. File extensions.
 - C. Types of advanced degrees in computers.
 - D. How confusing computers are.
- 5. Which program(s) can you use to view and manage the contents of your computer? (Select all that apply.)**
 - A. Netscape Navigator.
 - B. My Computer.
 - C. System Sleuth.
 - D. Windows Explorer.
- 6. You open a file or folder by double-clicking it. (True or False?)**
- 7. Do this to display the contents of a certain drive or folder:**
 - A. Right-click the drive or folder.
 - B. Click the drive or folder while holding down the <Alt> key.
 - C. Double-click the drive or folder.
 - D. Triple-click the drive or folder.

8. To view an object's properties, right-click the object and select Properties from the shortcut menu. (True or False?)
9. When you're browsing the contents of your computer, do this to move back or up to the previous level or folder. (Select all that apply.)
 - A. Click the Up button on the toolbar.
 - B. Click the Back button on the toolbar.
 - C. Press <Ctrl> + <Z>.
 - D. Click the Address Bar on the toolbar and select the appropriate drive or folder.
10. Which of the following statements is NOT true?
 - A. You can move a file or folder to a new location by dragging and dropping it.
 - B. You can rename a file or folder by right-clicking it, selecting Rename from the shortcut menu, typing the new name and pressing <Enter>.
 - C. A plus symbol (⊕) next to a folder in Windows Explorer indicates the folder is locked and cannot be modified or deleted.
 - D. Holding down the <Ctrl> key while you're dragging and dropping something copies it instead of moving it.
11. Delete a file or folder by clicking it, pressing the <Delete> key, and confirming the deletion. (True or False?)
12. Do this to select multiple files and folders: (Select all that apply.)
 - A. Click and drag a rectangle around any adjacent files you want to select.
 - B. Select File → Select Multiple Files from the menu, and then click the files you want to select.
 - C. Click the first file you want to select, press and hold down the <Shift> key and click the last file you want to select.
 - D. Hold down the <Ctrl> key and click the files you want to select.
13. Which of the following statements is NOT true? (Select all that apply.)
 - A. You can find a file on your computer by clicking the Start button, selecting Search, enter what you want to search for using the Search Companion and click Search.
 - B. Open Windows Explorer by clicking the Start button and selecting All Programs → Windows Explorer.
 - C. To save a file in a location other than the program's default folder you have to save the file, then use My Computer or Windows Explorer to move the file to the desired location.
 - D. You can display the contents of a drive or folder using Thumbnails, Tiles, Icons, List, or Details View.
14. The three-letter extension of a file is normally displayed in Windows XP. (True or False?)

Homework

1. Open My Computer.
2. View the contents of your Local Disk (C:).
3. Create a new folder in the root directory of your Local Disk (C:).

4. Name the new folder "Project Files."
5. Insert a floppy disk in the (A:) drive and copy the Project Files folder there.
6. Delete the Project Files folder from the (C:) drive.
7. Open the Recycle Bin and find the deleted Project Files folder. Do you know how to retrieve it?
8. Open Windows Explorer and view the contents of the (A:) drive.
9. Use the Windows Explorer View menu to display the contents of the (A:) drive in List view.
10. While you're still in List view, sort the files in alphabetical order.
11. Use the Start menu's Search feature to find all the files named "readme.txt" on your (C:) drive. Open one of these files by double-clicking it.

Quiz Answers

1. A, B, C, and D. Computers can store their information on any of these disk types.
2. True.
3. B and D.
4. B. File extensions, which are used to identify the file type.
5. B and D. My Computer and Windows Explorer both display the contents of your computer and allow you to manage your computer's files and folders.
6. True. Double-clicking a file or folder opens it.
7. C. Double-click a folder to open it and display its contents.
8. True. Right-clicking an object and selecting Properties from the shortcut menu displays the properties of the object.
9. A, B, and D. Any of these will bring you back to the previous level or folder.
10. C. A plus symbol (+) next to a folder in Windows Explorer means the folder contains subfolders.
11. True.
12. A, C, and D. You can use any of these methods to select multiple files and folders.
13. C. You can easily save a file in a different location by opening the drive and/or folder where you want to save the file and clicking Save.
14. False. File extensions are normally hidden in Windows XP.

Chapter Nine: Exploring the Internet

Chapter Objectives:

- Understand and connect to the Internet
- Find a specific Web page
- Browse and search the Web
- Add Web pages to Favorites
- Change your Home page
- Display a history of visited Web pages
- Download pictures and software
- Use e-mail

Prerequisites

- How to use the mouse to click, double-click, drop-and-drag, and right-click
 - How to start programs in the Start Menu
 - How to use menus, toolbars, and dialog boxes
-

Unless you've been living on a deserted island for the past five years, you already know that the Internet is the biggest thing to happen to computers since... well, computers! You can't ignore it—the Internet is not going away and it's already changing the world we live in. Fortunately, for the most part, the Internet is incredibly easy to use. Even the most computer-phobic users seem to feel right at home on the Internet.

This chapter explains the ins and outs of the Internet. If you've ever spent a sleepless night wondering exactly what the Internet is and how it got started, you'll finally learn it all. Then you'll learn how to get your computer connected to the Internet and how to surf the Web using the Windows XP Internet Explorer. You'll also learn some useful tips like how to search for information, how to save your favorite Web pages so that you can easily come back to them later, and how to change the Web page that first appears when you connect to the Internet. Finally, you'll learn how to download software, and send and receive e-mail.

Lesson 9-1: Introduction to the Internet

Figure 9-1

The Internet is the largest network in the world, consisting of millions of computers, all over the world, all connected together.

Figure 9-2

Web pages are stored on Web servers—computers that are permanently connected to the Internet.



Figure 9-1

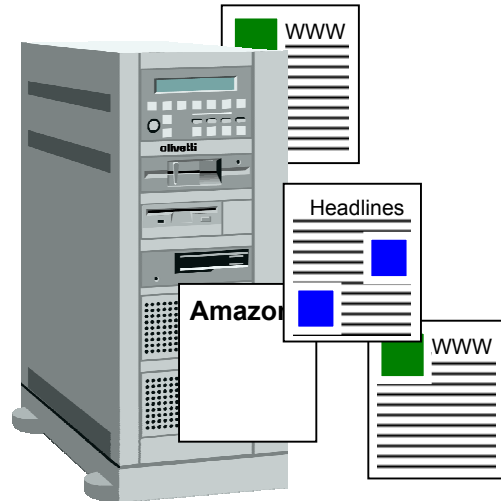

Figure 9-2

The Internet is the largest computer network in the world. It consists of millions of computers all over the planet, all connected to each another.

The Internet was born in the 1960's when the United States military worried that a nuclear bomb could destroy its computer systems (there weren't many of them back then). So it placed several computers far apart from each other and connected them with some super-fast telephone lines so that the computers could talk to each other. If a nuclear bomb blew up one computer, another computer could instantly take over; thus, the computer network wouldn't go down. Years passed and other organizations, such as colleges and universities, started connecting their computers to this growing network to share information.

Although the Internet has been around a long time, it wasn't until the 1990's that someone thought of a wonderful idea called the *World Wide Web*. The World Wide Web is what you probably think of when you think of the Internet, although it's really just a part of the Internet. The Web consists of millions of documents that are stored on hundreds of thousands of computers that are always connected to the Internet. These documents are called *Web pages*, and you can find Web pages on every subject imaginable—from your local newspaper to online catalogs to airline schedules, and much, much more.

Web pages are stored on *Web servers*. A Web server is a computer, not unlike your own computer, only bigger and faster. There are hundreds of thousands of Web servers located all over the world. Web servers are always connected to the Internet so that people can view their Web pages 24 hours a day.

So what can you do once you're connected to the Internet? Plenty. Table 9-1: *What Can I do on the Internet?* shows just a few of the many things there are to do on the Internet.

Table 9-1: What Can I do on the Internet?

Task	Description
Send and Receive E-mail	Exchanging electronic mail (or e-mail) is the most used and most popular feature on the Internet. Just like regular paper mail, you can send and receive e-mail with people around the world, as long as they have access to a computer and the Internet. Unlike regular paper mail, e-mail is usually delivered to its destination almost instantly.
Browse the World Wide Web	The World Wide Web is what most people think of when they think of the Internet—although it's really only a part of the Internet. The World Wide Web is an enormous collection of interconnected documents stored on Web servers all over the world. The World Wide Web has information on every subject imaginable.
Join online discussions with newsgroups	Newsgroups are discussion groups on the Internet that you can join to read and post messages to and from people with similar interests. There are thousands of newsgroups on topics such as computers, education, romance, hobbies, politics, religion, and more.
Chat with other online users	Chatting lets you communicate with people on the Internet instantly—no matter how far away they are! Most chats are text-based, meaning you have to type when you converse with people on the Internet. A growing number of chats have voice and even video capabilities—all without having to pay long distance charges.
Download software	You can download pictures, demo programs, patches and drivers for your computer, and many other types of files and save them to your computer.
Listen to music and watch videos	You can listen to sound on the Web, such as radio stations, or music by your favorite artists.

Lesson 9-2: Connecting to the Internet

Figure 9-3

Microsoft's Internet Connection Wizard will set you up with an Internet Service Provider.

Figure 9-4

The Dial-up Connection dialog box

Figure 9-5

The Internet Start Web page

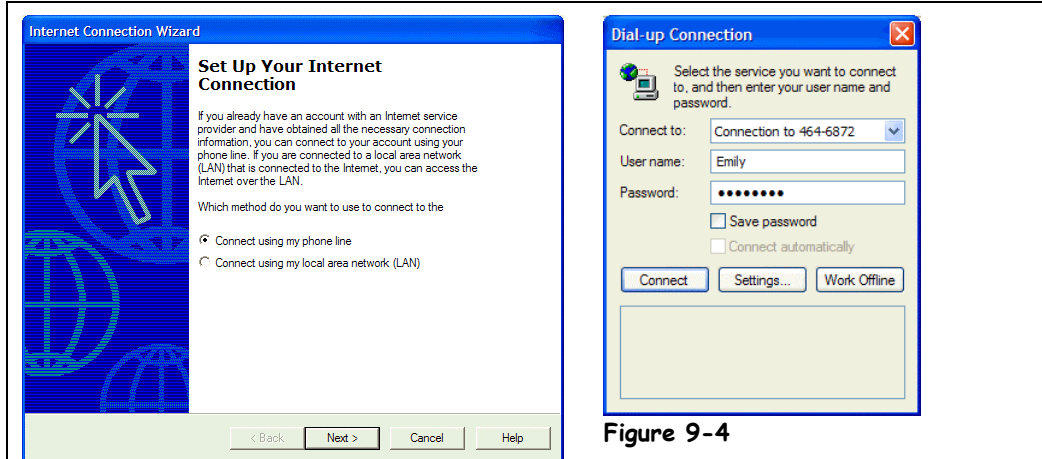

Figure 9-3

Figure 9-4

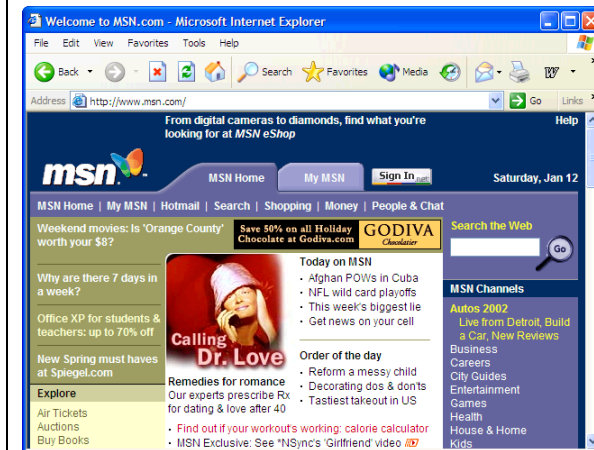



Figure 9-5



Internet Explorer Other Ways to Open Internet Explorer:

- Click the  icon on the Windows Quick Launch toolbar.

There are three things you'll need to connect to the Internet:

- **An Internet Service Provider (ISP):** An Internet Service Provider is a lot like a phone company, except instead of letting you make telephone calls to other people, an Internet Service Provider lets your computer connect to the Internet. Just like your telephone company, Internet Service Providers charge for their services— currently the average rate seems to be about \$20 a month for unlimited usage. You've probably already heard of the most famous Internet Service Provider—America Online, or AOL.
- **A Web Browser:** A Web browser is a program that lets your computer view and navigate the World Wide Web. One of the biggest improvements in Windows XP is that it comes with a built-in Web browser—Internet Explorer. Another Web browsing program that is very popular is Netscape Navigator.

- **A Phone Line and Modem or Other Connection:** A modem is your computer's very own telephone that lets it talk to other computers over the telephone line. Your existing phone line will work just fine with your modem, although it will be tied up whenever you're connected to the Internet. If you or someone in your home is a heavy Internet user, you might consider getting a second phone line for your computer. If you have the Internet at work, you might have a network connection to the Internet, which is much, much faster than a modem and is connected to the Internet 24 hours a day.

1. Double-click the **Start menu and then click **Internet Explorer** to start Internet Explorer.**

If you have America Online, you would double-click the America Online icon, instead. If you're already set up with an Internet provider, the Dial-up Connection dialog box appears, as shown in Figure 9-4.

If this is the first time you've ever tried connecting to the Internet, you may be greeted by the Internet Connection Wizard, as shown in Figure 9-3. Microsoft included the Internet Connection Wizard to help you get connected to the Internet and find an Internet Service Provider. If you want, you can follow the step-by-step instructions and let the Internet Connection Wizard help find you a Internet Service Provider—or you can find your own. Ask a computer-savvy friend or an employee at a local computer store for the name and number of a local Internet Service Provider. Once you are set up with an Internet Service Provider, come back finish the rest of this lesson.

2. Enter your User name and Password, if necessary, and click **Connect.**

If you have previously entered your user name and password and checked the Save password option, the user name and password characters will already appear in their respective text boxes. (Your password will appear masked by asterisks.)

If you listen to your computer, you should hear a dial tone, then your modem dial the phone, and finally a screeching sound as your ISP answers the phone.

NOTE: If you're connected to the Internet through a network at work, an ISDN or DSL line, or a cable modem, you won't hear anything at all, since these are all digital connections. Actually, it would probably pay off if you checked if the Internet *is* available in your area by cable or DSL connections. If it is, it's probably worth the extra ten or twenty dollars a month to get a connection to the Internet that is at least ten times faster than a standard phone connection. Plus, you don't have to worry about people getting busy signals when you're using the Internet.

After a connection to the Internet has been established, Internet Explorer appears on screen and displays your home page.

A *home page* is the page your Web browser displays when it connects to the Internet. The default start page for Microsoft Internet Explorer is Microsoft's start page (what else did you think it would be?), but you can easily change your default start page—more about that in another lesson.



This icon appears on the taskbar whenever your computer is connected to the Internet via modem.

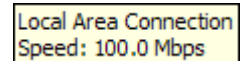

Point to the icon and wait a few seconds to see what your connection speed to the Internet is.

Quick Reference

To Connect to the Internet:

1. Double-click the **Internet Explorer** icon on the desktop.

Or...

Click the **Internet Explorer** icon on the Quick Launch toolbar.

2. If necessary, enter your user name and password and click **Connect**.

Lesson 9-3: Displaying a Specific Web Page

Figure 9-6

The Microsoft Web site.

Figure 9-7

When a Web page is currently unavailable, this screen is displayed in Internet Explorer.

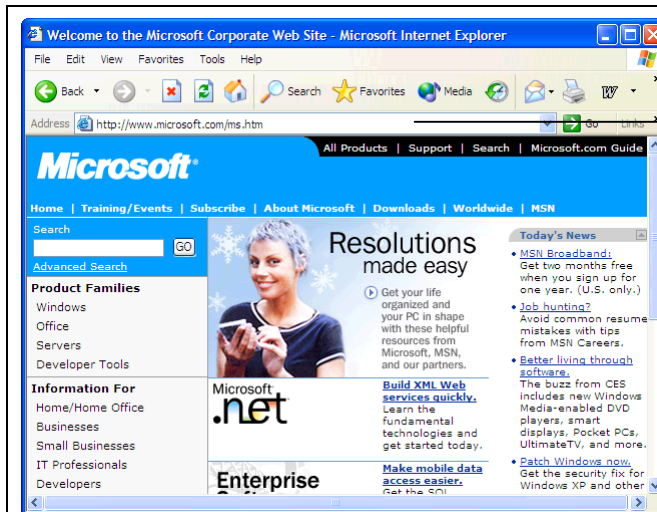

Address bar

Type the address of the Web page you want to view here and press <Enter>.

Figure 9-6

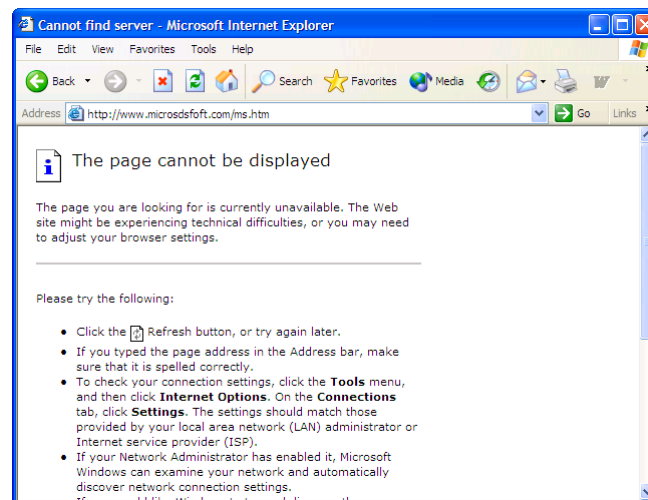

Figure 9-7

Other Ways to Enter an Internet Address:

- Press <Ctrl> → <L>.

Web addresses are everywhere—on television advertisements, in magazine and newspaper articles, and even on business cards. These `www.something.com`'s you've seen and heard so much about are *URLs* (if you really want to know, URL stands for Uniform Resource Locator). Just like there is a house, office, or building behind a postal address, there is a Web page behind every Web address. Unlike postal addresses, through the magic of technology, you can arrive instantly at a Web page by typing its Web address, or URL, into your Web browser. Well, hopefully instantly... if you've already been on the Internet for any amount of time, you probably know that sometimes the Internet gets busy and *net congestion* can cause a Web page to come up slowly—if at all! This lesson will show you how to visit the Web sites behind all the Web addresses you've seen.

1. Connect to the Internet.

It doesn't matter where you are on the Internet—you can always enter a Web address.

2. Click the words in the **Address bar.**

The text in the Address bar becomes highlighted.

3. Type the address of the Web page you want to view; in our example we'll use www.microsoft.com and press **<Enter>.**

Web addresses are preceded by *http://*. For example, the address we want is *http://www.startribune.com*. Technically, you don't need to add the *http://* before typing the Web address—save yourself some time and leave it out.

NOTE: If you forget the *www* in front of a Web address or a *.com* an Internet Explorer called *IntelliSense*® attempts to correct the Web address by adding the *www* or *.com* for you. Sometimes it works, sometimes it doesn't.

After a moment, you're connected to the Minneapolis Star Tribune Web site, as shown in Figure 9-7 (though hopefully your headlines won't be as out-of-date!). Let's try going to another Web site.

4. Type www.yahoo.com in the **Address bar and press **<Enter>**.**

Possibly the most famous Web site on the Internet, the Yahoo home page, appears.

Sometimes when you're browsing the Web, you'll see a screen like one in Figure 9-6. This means the Web site is unavailable. Several things can cause a Web page not to load:

- The computer where the Web page is stored is down.
- Too many users are trying to view the same Web page at the same time.
- You've lost your connection to the Internet.
- The Web page no longer exists, or maybe it never existed in the first place (did you type in the correct Web address?).

For all these cases, try going to the Web site again later. Whatever was causing the problem might be fixed a few minutes or hours later.



Address Bar

You can leave off the *http://* when you type a Web page address. For example, type *www.nbc.com* instead of *http://www.nbc.com*.

Quick Reference

To Display a Specific Web Page:

- Type the Web address in the  *http://www.g* **Address bar** and press **<Enter>**.

Or...

- Press **Ctrl** → **<L>**, type the Web address, and press **OK**.

Lesson 9-4: Browse the Web

Figure 9-8

The Internet Explorer toolbar

Figure 9-9

The Yahoo home page

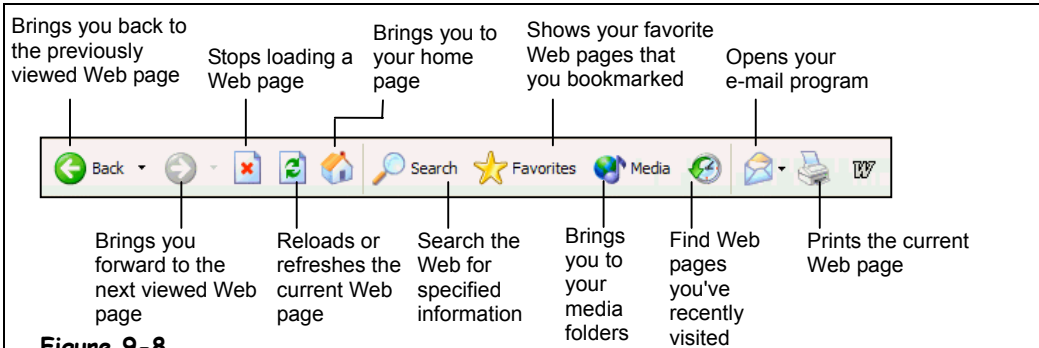
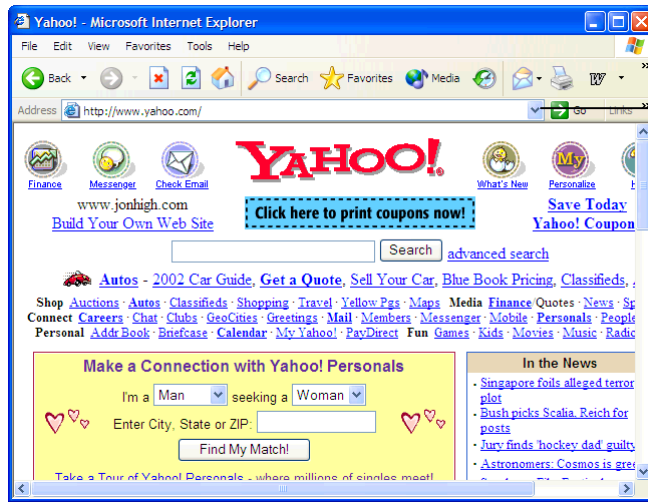

Figure 9-8



Click the to display a list of Web sites that you have typed in.

Figure 9-9



Back button



Tip: Instead of repeatedly clicking the Back and Forward buttons, you can click their down arrows to display a list of previous Web pages.

Luckily, the World Wide Web is remarkably easy to navigate. It's so easy, in fact, that most users seem to have an uncanny ability to browse through Web pages without any previous training—even if they have difficulty with other computer programs. This chapter explains how to find your way through the millions of Web pages that are on the Internet. Even if you already think you have browsing down, you should read this chapter—you might learn a trick or two you didn't know.

1. Make sure your Web browser is open so that you're connected to the Internet.

Hopefully you know how to do this by now!

2. Go to the Yahoo home page by clicking the **Address bar, typing www.yahoo.com, and pressing **<Enter>**.**

The Yahoo home page fills the screen. Many of the underlined words and pictures you see on the Yahoo page are actually *hyperlinks*. When you position the pointer over a hyperlink, it changes to a . Clicking a hyperlink will automatically:

- Take you to a different page within the same Web site.
- Take you to a different page in a different Web site.
- Take you to a different part of the same Web site.

- Allow you to download a file.
- Send an e-mail to a specified e-mail address.
- Play a video or sound.

3. Position the pointer over the **What's New icon near the top of the Yahoo page.**

The pointer changes into a  anytime it is over a link. Remember, links can be either text or pictures.

4. Click the **What's New icon or text.**

The What's New Web page connected to the link appears. Notice the address bar displays the address of the new Web page, <http://www.yahoo.com/new/>. You can easily move back to the previous Web page.

5. Click the **Back button on the toolbar.**

You're back at the Yahoo home page. The Forward button moves forward through the Web pages you have viewed.

6. Click the **Forward button on the toolbar.**

You return to the What's New Web page.

Just like a metro highway system at rush hour, the Internet often becomes congested when too many users try to view the same Web site at the same time. When this happens, it may take a long time for the Web page to appear on screen, or you may even get a screen like the one shown in Figure 9-7. Here are a few strategies to try if you are having problems displaying Web pages.

If a Web page is taking too long to display on your computer screen, you can stop loading the page and try again later. Here's how to stop transmitting a page:

7. Click the **Address bar, type www.microsoft.com, and press **<Enter>**. After a second or two—before the Microsoft home page completely loads—click the **Stop** button on the toolbar.**

You can also try *refreshing* a sluggish or difficult Web page. There are basically two reasons to refresh a Web page:

- To attempt to view a Web page that is not loading.
- To update a Web page that contains information that is constantly changing, such as headline news stories or financial information.

8. Click the **Refresh button on the toolbar.**

Another way you can return to previously visited Web sites is to use the Address bar, which remembers every Web address that you've manually typed into it.

9. Click the **Address bar list arrow.**

A list of the Web addresses you've previously entered appears below the address bar.

10. Select the <http://www.yahoo.com> site from the list.

You return to the Yahoo Web site.



Forward button



Stop button



Refresh button

 **Quick Reference**

To Use a Hyperlink:

- Click the hyperlink with the  pointer.

To Go Back to the Previous Page:

- Click the **Back** button on the toolbar.

To Stop the Transfer of Information:

- Click the **Stop** button on the toolbar.

To Refresh a Web Page:

- Click the **Refresh** button on the toolbar.

To Return to a Web Address you Typed in the Address Bar:

- Click Address bar's  arrow and select the Web address.

Lesson 9-5: Search the Web

Figure 9-10

You can search the Web with Internet Explorer's integrated search function.

Figure 9-11

You can search the Web with Yahoo.

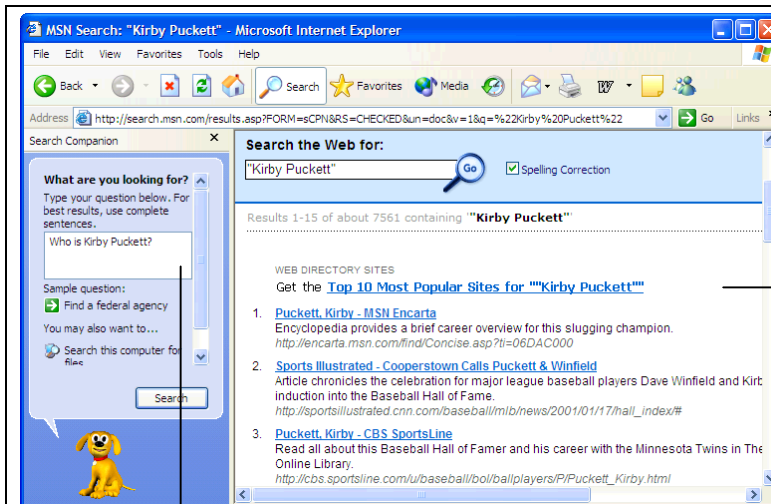

Your search results appear here.

Figure 9-10 Enter a word or phrase you want to search for here and click Search.

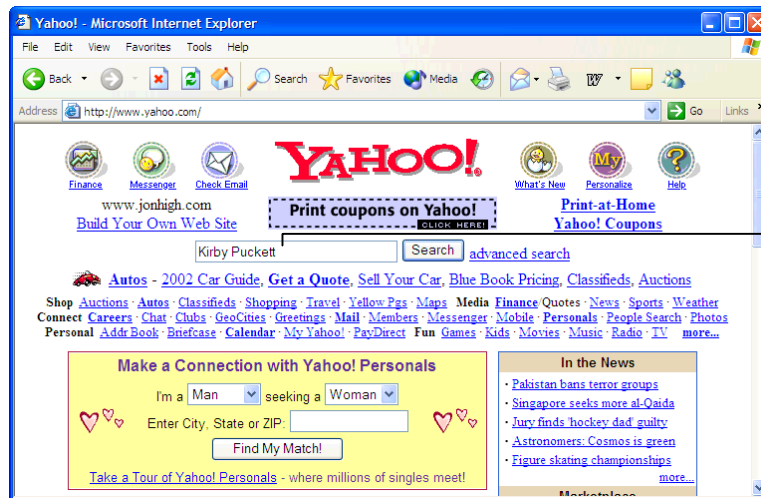

Enter a word or phrase you want to search for here and click search.

Figure 9-11

The Internet's greatest strength is also its greatest weakness: with so much information—literally millions of Web pages—it can be extremely difficult to find what you're looking for. Fortunately, there are many search engines that catalog the millions of Web pages on the Internet so that you can find Web pages on topics that interest you. There are many search engines available on the Internet—you've probably heard of some of the more popular ones, like Yahoo, Excite, and HotBot. In this lesson, you'll learn how you can search the Web to find information on the topics you specify.

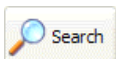

Search button

1. Make sure your Web browser is open so you are connected to the Internet.
2. Click the **Search** button on the toolbar.

A Search pane appears on the left side of Internet Explorer, as shown in Figure 9-10. This is where you specify what you want to search for.

3. Click the **Search box and type in the word or phrase you want to search for.**

For better search results, use complete sentences or several keywords that describe what you're looking for. For example, typing "Where can I find a good oyster restaurant in Chicago?" would yield better results than simply "oysters".

4. Click **Search.**

The Security Alert dialog box may appear (it appears any time you send information over the Internet, unless you check the "In the future do not show the warning" check box). If it does, you can safely click OK.

Microsoft Internet Explorer returns a list of Web pages, ranked by relevance, that contain the word or phrase you specified. You may have to scroll down to view the entire list.

5. Click the Web page you want to view.

Are you finding mostly irrelevant information in your search results? Then you may have to refine your search. For example, a search on the word "Windows" may result in links to "Anderson® Windows," "Stained Glass Windows," and "Microsoft Windows", while a search on the phrase "Microsoft Windows" will result in links to "Microsoft Windows." Some search engines will let you search within your results. For example, you could do a search for "Microsoft Windows" and then further refine your search by searching the results for the word "Networking."

6. Click the **Search button to close the search panel.**

You don't have to click Microsoft Internet Explorer's search button to look for information on the Web—you can also go directly to a search engine's Web site and specify what you want to look for there. Table 9-2: *Popular Search Engines on the Web* is by no means a definitive inventory of the dozens of search engines that are currently available on the Web, but it lists the best and most popular Web search engines and their Web addresses.

What are you looking for?

Type your question below. For best results, use complete sentences.

Please type your query here, then press <Enter>.

Search Box

Table 9-2: Popular Search Engines on the Web

Site	Web Address	Description
AltaVista	www.altavista.com	Operated by Digital, AltaVista claims to catalog and index more Web pages than any other search engine.
Excite	www.excite.com	Excite has a powerful, highly rated search engine, and it also has one of the best customizable home pages on the Internet.
Google	www.google.com	Google is consistently ranked as the best and most relevant search engine. However, it doesn't contain many other features other than search.
Hotbot	www.hotbot.com	Though not as popular as some of the others, HotBot consistently ranks as one of the best, most relevant search engines.
Lycos	www.lycos.com	Lycos is another powerful search engine, especially if you're looking for information in formats other than Web pages, such as MP3 sound files.
Yahoo	www.yahoo.com	The mother of all Web pages, Yahoo is actually more of a directory service than a search engine, but it makes it very easy to find topics, especially if you're new to the Internet.

 **Quick Reference**

To Search the Web for Information Using Internet Explorer:

1. Click the  **Search** button on the toolbar.
2. Type the word or phrase you want to search for in the **Search the Web for** box and click **Search**.
3. Click the link for the Web page you want to look at.
4. Click the  **Search** button on the toolbar to close the search panel.

To Search the Web for Information Using a Search Engine:

- Type the Web address for the search engine in the **Address bar** and press **<Enter>**. Type the word or phrase you want to search for in the Web page's **search** box and press **<Enter>**.

Lesson 9-6: Adding a Web Page to Favorites and Changing your Home Page

Figure 9-12

The Add Favorites dialog box

Figure 9-13

Click the Favorites button to display a list of your favorite Web pages.

Figure 9-14

The General tab of the Internet Options dialog box. You can change your home page here.

Figure 9-15

The Organize Favorites dialog box

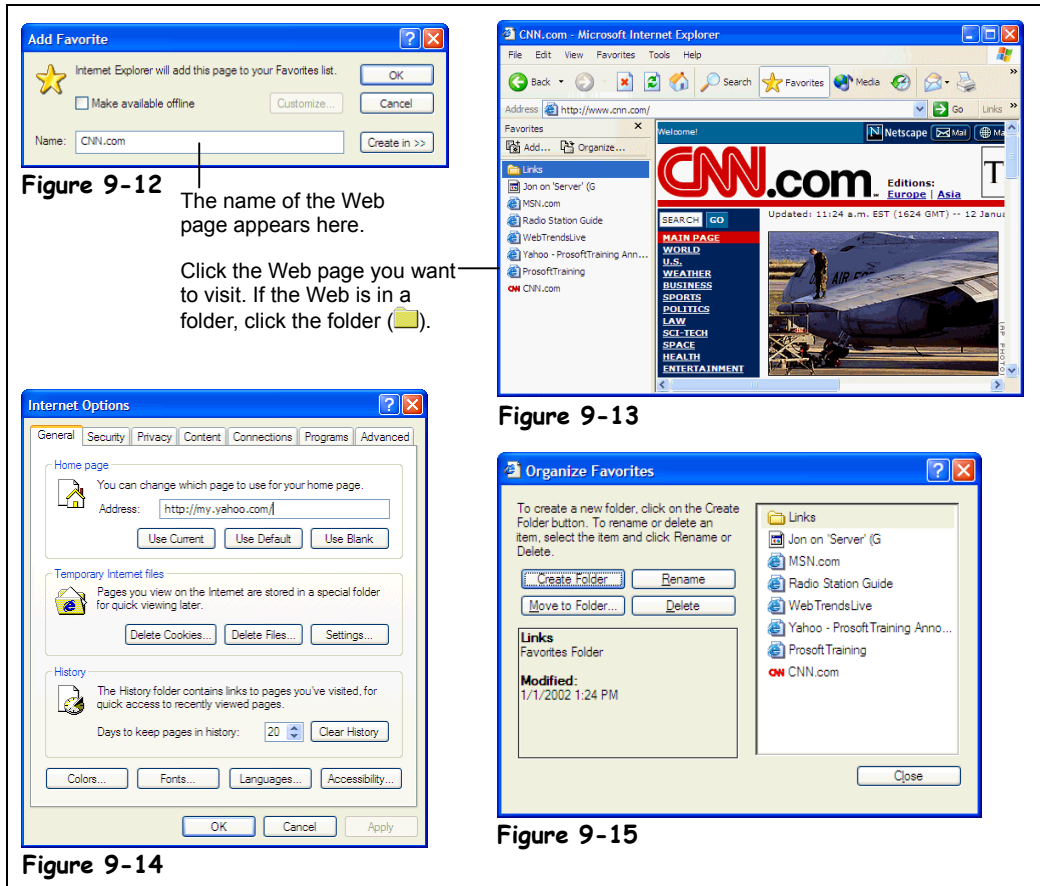

Figure 9-14

Figure 9-13

Figure 9-15

Other Ways to Add a Web Page to Favorites:

- Right-click anywhere on the Web page and select **Add to Favorites** from the shortcut menu.

You have finally found a Web page about hippopotamus food, and you want to return back to it later. What should you do? Well, you don't have to write down the Web address on a Post-It note and stick on your monitor—you can add the Web page to Internet Explorer's Favorites feature so you can always quickly return back to any Web page in the list! In this lesson, you'll learn how to add your favorite Web sites to Internet Explorer. You'll also learn how to change your home page (also called a start page)—the Web page that appears each time you start Internet Explorer.

1. **Make sure your Web browser is open so that you're connected to the Internet.**
2. **Go to a Web page that you visit frequently and want to add to your Favorites list.**

It doesn't matter how you get to the Web site—type the page's Web address in the Address bar (if you know it) or navigate there by clicking a hyperlink from another Web site. When the desired Web page appears on your screen, you can add it to your Favorites so you can always easily return to it later.

3. Select **Favorites → **Add to Favorites** from the menu.**

The Add Favorites dialog box appears, as shown in Figure 9-12. The name of the Web page appears in the name box—if you want, you can replace the Web page’s default name with one that is more meaningful to you. Clicking the Create In button lets you add shortcuts to a folder.

4. Click **OK to add the Web page.**

A shortcut to the Web page is added to your list of favorites.

Here’s how to display your favorite Web sites:

5. Click the **Favorites button on the toolbar.**

A list of your favorite Web pages appears in a panel on the left side of Internet Explorer, as shown in Figure 9-13.

6. Click the favorite Web page you want to view.

If your favorite Web page is in a folder, just click the folder (📁) and then the favorite Web site. The Web page you clicked appears in the right panel of Internet Explorer.

Is there a Web page that you *really* like and use almost every time you’re on the Internet? You might consider making that Web page your *Home page*—the Web page that appears each time you start Internet Explorer. Some of the search engines we discussed in the previous lesson make excellent home pages. Here’s how to make a Web page your home page:

7. Go to a Web page that you want to set as your home page and select **Tools → **Internet Options** from the menu. Click the **General** tab, if necessary.**

The Internet Options dialog box appears, as shown in Figure 9-14. The address of your current home page appears in the box in the Home page section.

8. Click **Use Current button to set the Web page that is displayed on your screen as your new home page.****9. Click **OK**.**

The Internet Options dialog box closes. The next time you start Internet Explorer, the Web page you selected will appear as your start page.

If you’ve added a lot of Web pages to your list of favorites, it can be difficult to find a specific Web page out of all those entries. You can organize your favorites list by creating subfolders to keep related Web pages together—for example, you might create a folder called “Travel” to keep all your travel related Web pages together, and another folder called “Financial” to hold your financial and investment related Web pages. Here’s how to organize your list of favorites:

10. Select **Favorites → **Organize Favorites** from the menu.**

The Organize Favorites dialog box appears, as shown in Figure 9-15. We don’t need to go in detail here—you can organize your favorites using the same Windows file management techniques you already know (if you don’t, review the file management chapter). The Organize Favorite dialog box even provides you with several handy buttons to move, rename, and delete files and shortcuts.

11. Close the Organize Favorites dialog box.**Favorites button****Other Ways to View Your Favorite Web Pages:**

- Select **Favorites** from the menu and select the Web page.

Quick Reference**To Add a Web Page to Your List of Favorites:**

- Go to the Web page, select **Favorites** → **Add to Favorites** from the menu and click **OK**.

Or...

- Go to the Web page, right-click anywhere on the Web page and select **Add to Favorites** from the shortcut menu.

To Go To a Favorite Web Page:

- Click the **Favorites** button on the toolbar and select the Web page from the left side of Internet Explorer. Click the **Favorites** button when you’re finished.

Or...

- Select **Favorites** from the menu and select the Web page.

To Change Your Start Page:

- Go to the Web page, select **Tools** → **Internet Options** from the menu and click the **Use Current** button.

To Organize Favorites:

- Select **Favorites** → **Organize Favorites** from the menu.

Lesson 9-7: Displaying a History of Visited Web Pages

Figure 9-16

Internet Explorer displays a history of previously visited Web sites.

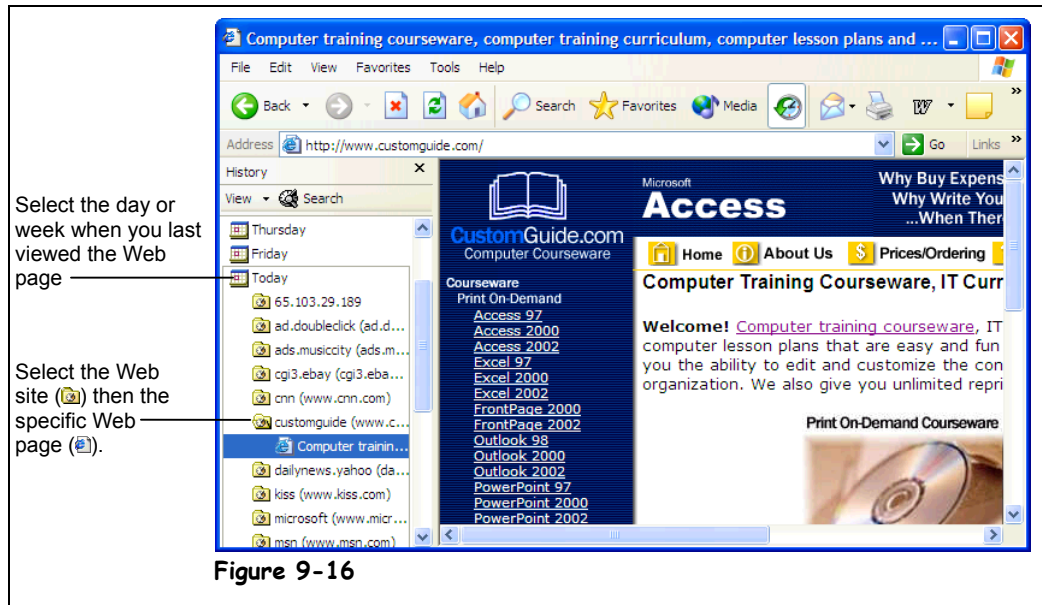

Can't find your way back to that that really neat "101 Lutefisk Recipes" Web site you were looking at yesterday? Don't worry—Internet Explorer keeps track of the Web pages you've visited during the past 20 days. You can use Internet Explorer's *history* feature to easily return to any of these sites, and that's the topic of this lesson.



History button

- 1. Make sure your Web browser is open so you're connected to the Internet.**
- 2. Click the **History** button on the toolbar to display a list of the Web pages you have recently visited.**

A history of all the Web pages you've visited recently appears in the left side of Internet Explorer. The history is grouped chronologically—all you have to do is click the day or week you viewed the Web page that you want to view again.

- 3. Click the day or week you viewed the Web page that you want to view again.**

If you can't remember the day or week off hand, don't worry. Finding the Web page you want to view in the history may take a bit of trial and error, because who really remembers the exact day when they visited a specific Web page?

When you click a day or week, the Web sites you viewed during that day or week appear. A 🌐 (Web site) symbol appears by each Web site.

- 4. Click the Web site you want to revisit.**

The Web site's individual Web pages appear, each with a 📄 (Web page) symbol beside them.

- 5. Click the Web page you want to view.**

The Web page appears.

6. Click the **History** button on the toolbar when you've finished working with your history of recently view Web pages.

The History panel disappears.

 Quick Reference**To Display a History of Visited Web Pages:**

1. Click the  **History** button on the toolbar.
 2. Click the day or week you viewed the Web page.
 3. Click the Web site you want to revisit.
 4. Click the specific Web page you want to view.
 5. Click the **History** button on the toolbar when you've finished working with your history of recently view Web pages.
-

Lesson 9-8: Saving Pictures and Files to Disk (Downloading)

Figure 9-17

There are many files and programs on the Internet that you can download onto your computer's hard drive.

Figure 9-18

Specify where on your hard drive you want the downloaded file to be saved.

Figure 9-19

Windows displays the progress of a download.

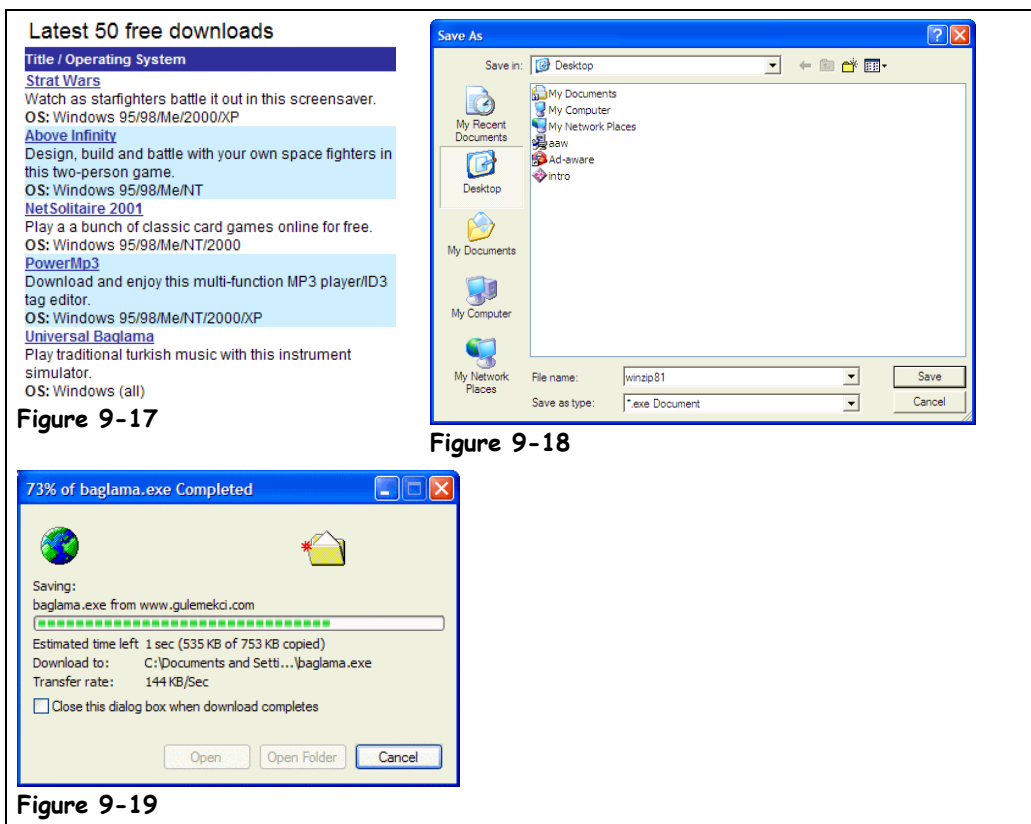

Another common way people use the Internet is to download files from a Web server on the Internet and save them onto their local hard drive. Some of the most common types of files people download from the Internet include:

- **Images:** You can save any picture that you see on a Web page, print it, use it as your Windows wallpaper, or anything else you can think of.
- **Programs:** Many software companies have demo versions of their programs available on the Internet that you can download and evaluate. In addition, thousands of shareware programs are available for you to download for free!
- **Patches, Fixes, and Drivers:** One of the great things about the Internet is how you can find and download bug fixes for your programs, and drivers for your hardware devices, such as a driver for a discontinued foreign printer.
- **Music:** A new file format called MP3 is revolutionizing the music industry. MP3 files are sound files that you can listen to on your computer. They have digital CD quality sound, but use compression so that they are 11 times smaller than the CD equivalent and small enough to be easily downloadable from the Internet.
- **Viruses:** Just kidding—the last thing the world you want to download from the Internet is a computer virus! Since you won't always know where a program or file you want to download comes from, you should make sure your computer has a virus protection program installed before you download anything from the Internet.

Other than the slight risk of contracting a virus (if you don't have virus protection software installed), the only other downside of downloading files off the Internet is how long it can take—especially if you're downloading a huge file over a 33.6 modem connection to the Internet!

In this lesson, you'll learn how to download files and images from the Internet and save them to your hard disk. When you come across a picture or image on the Internet that you really like, here's how you can permanently save it to your computer's hard drive:

1. Right-click the image you want to save and select **Save Picture As from the shortcut menu.**

Windows asks where you want to save the image by presenting you with the Save As dialog box, as shown in Figure 9-18.

2. Navigate to the drive and folder where you want to save the image, give the image a different name (if you want), and click **OK.**

Windows saves the image to the specified drive and folder.

The procedure for downloading and saving programs and other files from the Internet is almost the same as downloading and saving an image. Here's how to do it:

3. Find the file you want to download, right-click it and select **Save Target As from the shortcut menu.**

You can usually also simply click a file you want to download, but doing this will sometimes open the file in Internet Explorer instead of saving it to your computer. As with images, you have to specify where you want to save the file.

4. Navigate to the drive and folder where you want to save the file, give the file a different name if you want, and click **OK.**

Windows will download the file and save it to the drive and folder you specified. It may take several minutes or several hours to download the file, depending on the file's size and how fast your connection to the Internet is. Windows displays a dialog box that shows the progress of the download, as shown in Figure 9-19.

NOTE: Make sure you remember where you save your downloaded files! Many people download software without thinking about where they're saving it, only to be unable to find the file once it's finished downloading. It makes sense to create and use a folder called "Downloads" or something similar when you can save your downloaded files.

One more note about downloading files and programs off the Internet: a large percent of the programs you can download off the Internet are stored in *ZIP* files. *ZIP* files package programs and files together and make them much easier to download.

ZIP files do two things:

- **Compress Information:** Instead of downloading a 2 MB file, you can download a 1 MB file in half the time.
- **Store multiple files together in a single *ZIP* file:** Instead of downloading 20 or so files that a program requires to run, you only have to download a single *ZIP* file.

Once you have downloaded a *ZIP* file, Microsoft Windows XP should unzip it for you. If it doesn't, there is another program that will unzip files called WinZIP. You can find and download the WinZIP program at www.winzip.com.

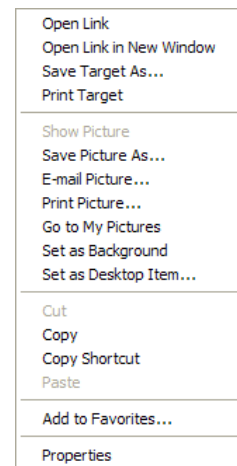

Internet Explorer shortcut menu



New Program
A ZIP file

Quick Reference

To Save an Image on a Web Page to Disk:

1. Right-click the image you want to save and select **Save Picture As** from the shortcut menu.
2. Navigate to the drive and folder where you want to save the image, give the image a different name if you want, and click **OK**.

To Download a File:

1. Right-click the file you want to download, select **Save Target As** from the shortcut menu.
2. Navigate to the drive and folder when you want to save the file, give the file a different name if you want, and click **OK**.

Lesson 9-9: Introduction to E-mail

Figure 9-20

Microsoft Outlook Express is the e-mail program that is included with Windows XP.

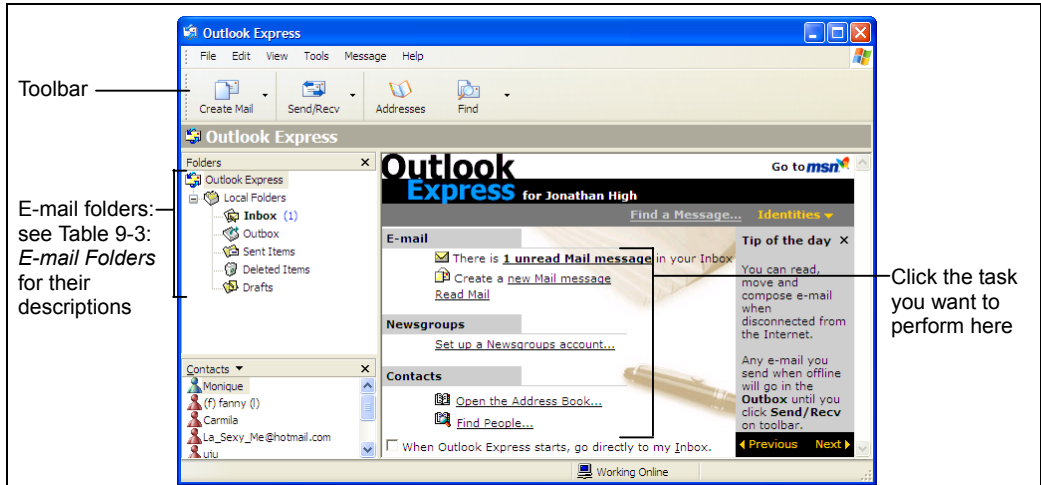

Figure 9-20

Figure 9-21

Outlook Express's toolbar

Figure 9-22

Many people prefer to use Web-based e-mail, such as Hotmail, since you can use it anywhere on any computer that has a connection to the Internet.

Figure 9-23

An Internet e-mail address consists of two parts: a user name and a domain name, separated by the @ symbol.

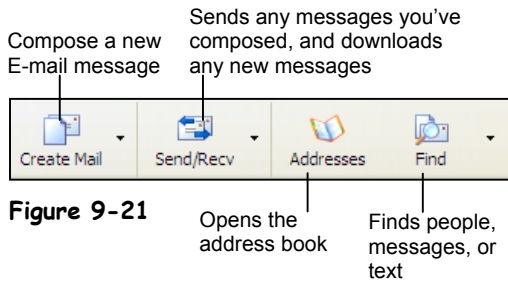

Figure 9-21



Figure 9-22

JaneDoe@zipcorp.com

User Name

This is the name of the person's e-mail account. It is similar to the person's name on an envelope.

Domain Name

This is the location of the person's account on the Internet. It is similar to the address on an envelope.

Figure 9-23

Do you really need a definition of e-mail? You already know that you can use e-mail to send messages to the staff at the office or to people all over the world. You probably also know that e-mail is fast (almost instantaneous) and economical (many e-mail accounts are completely free!).

Just like you need to know a person's street address if you want to send them a letter, you need to know a person's e-mail address if you want to send that person an e-mail message. Figure 9-23 is an example of what a typical e-mail address looks like.

Windows XP comes with an e-mail program called *Outlook Express*. Outlook Express is a stripped-down version of Microsoft's full-featured e-mail program *Outlook*, which comes with Microsoft Office. Outlook Express allows you compose, send, and receive e-mail

messages over the Internet. The remainder of the lessons in this lesson will show you how to accomplish these tasks.

Move on to the one and only step in this lesson and we'll take a quick look at Outlook Express before we move on and learn how to compose, send, and receive e-mail.

1. Open Outlook Express by clicking the **Outlook Express** button on the taskbar's Quick Launch toolbar.

The main screen of Outlook Express appears, as shown in Figure 9-26. Notice the folders in the left pane of Outlook Express? These folders categorize your messages and work just like the In and Out boxes you've seen at the office. Table 9-3: E-mail Folders describes each of these folders.

Although we'll be working in Microsoft Outlook Express throughout the remaining lessons in this chapter, Outlook Express is by no means the only program you can use to send and receive e-mail. There are many, many different e-mail programs available, such as GroupWise, Lotus Notes, and even America Online that can also send and receive e-mail. In fact, if you're connected to the Internet and have a Web browser, you don't even need an e-mail program at all to send and receive e-mail—you can do it right from the Web! Web based e-mail is usually free, and it allows you to compose, send, and receive e-mail using a Web page instead of an e-mail program. Many people actually prefer using Web-based e-mail instead of an e-mail program because it's free and can be accessed anywhere there is a computer with an Internet connection. Hotmail, shown in Figure 9-22, owned by Microsoft (who else?) is the largest Web based e-mail program in the world.







Outlook Express button

Other Ways to Start Outlook Express:

- Select **Go** → **Mail** from Internet Explorer's menu.

Table 9-3: E-mail Folders

Folder	Description
 Inbox	Stores the messages you've received
 Outbox	Temporarily stores any messages that you've composed that have not been sent
 Sent Items	Stores copies of messages you have sent
 Deleted Items	Stores messages that you've deleted
 Drafts	Stores draft messages that you haven't completed yet

Quick Reference

To Start Outlook Express:

- Click the **Outlook Express** button on the taskbar's Quick Launch toolbar.

Lesson 9-10: Composing and Sending E-mail

Figure 9-24

The New Message window

Figure 9-25

The New Message toolbar

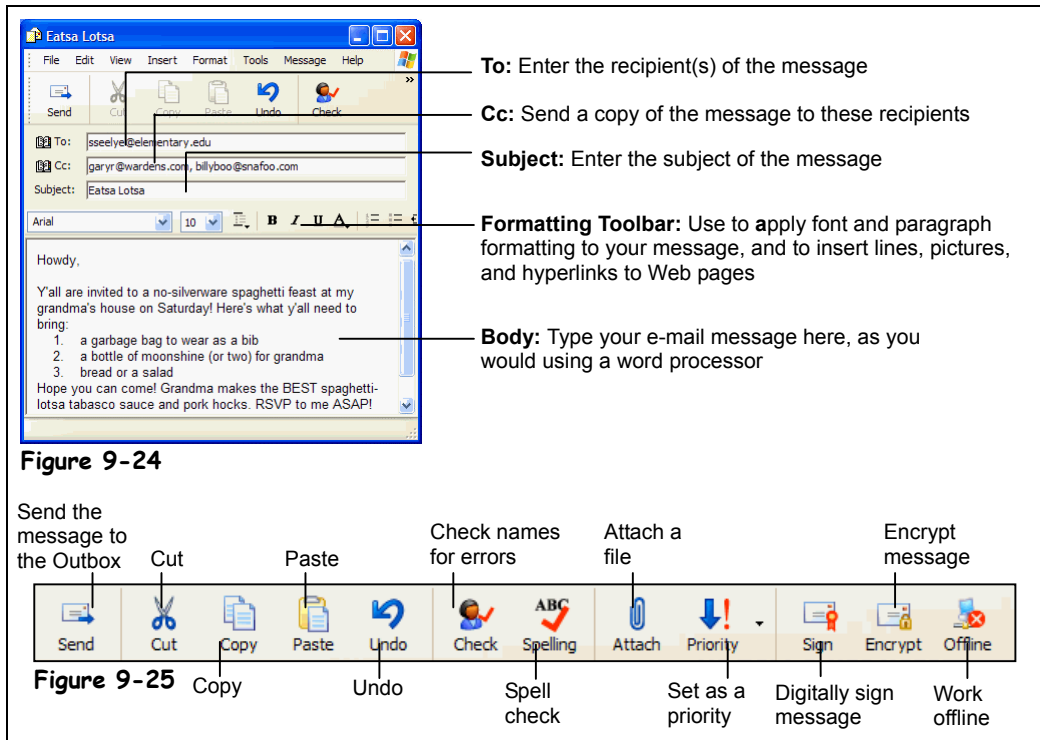

Outlook Express button



Create Mail button

Other Ways to Compose a Message:

- Select **Compose** → **New Message** from the menu.
- Press **<Ctrl> + <N>**.

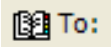

Select Recipients from List button

Here's a quick explanation on how to compose and send an e-mail message:

1. If it's not already opened, start Outlook Express by clicking the **Outlook Express** button on the taskbar's Quick Launch toolbar.
The Outlook Express program appears.
2. Click the **Create Mail** button on the Outlook Express toolbar.
The New Message window appears, as shown in Figure 9-24, ready for you to write your e-mail message. The first thing you have to do is specify the recipient's e-mail address in the To: field. You can either type this address in the To: box, or you can click the Select Recipients from a list button that appears immediately to the left of the To: box.
If the recipient of your e-mail isn't in the Address Book or if you want to type out their address in the To: field, move on to the next step. If you want to select your recipient's name from the Address Book (providing that they are in the address book), skip to Step 4.
3. Type the recipient's e-mail address in the **To:** field.
If you need to send a message to more than one person, simply enter all the recipient's e-mail addresses, making sure you separate them with a comma (,) like this: JohnWilson@acme.com, BettyT@yahoo.com. Skip to Step 7 when you're finished.
4. If the recipient is in your Address Book, click the **Select recipients from a list** button to the left of the To: field.
The Select Recipients dialog box appears, as shown in Figure 9-27.

5. Click the name of the recipient in the Name list and click the **To: button.**

If you need to send a message to more than one person, you can repeat Step 5 to add the other recipients. When you're finished, move on to the next step.

6. Click **OK.**

The Select Recipients dialog box closes and the recipient(s) appear in the To: field.

7. (Optional) To send a copy of a message to someone, click in the **Cc: field and/or the **Bcc:** field and Repeat Steps 3-6 to enter their e-mail addresses, only click the **Cc:** or **Bcc:** button instead of the **To:** button.**

Table 9-4: *Ways to Address an E-mail Message* gives a description of carbon copies (Cc) and Blind Carbon Copies (Bcc). Next, you have to enter the subject of the message so your recipient(s) will know what your message is about. The subject will appear in the heading of the message in the recipient's inbox.

8. Click the **Subject field and enter a subject for the e-mail.**

Now you can type an actual e-mail message.

9. Click the pointer in the body of the message, in the lower pane, then type the message as you would in a word processor.

Keep in mind that all the generic Windows programs commands you've learned—such as cutting, copying, pasting, and formatting text—will work in Outlook Express.

10. (Optional) To check the spelling of your message, select **Tools → **Spelling** from the menu.**

Outlook Express checks the spelling in your message, flags each word it can't find in its dictionary, and suggests an alternate word. To replace an unknown word with a suggestion, select the suggestion in the Change To list and click the Change button. To ignore a word the spell checker doesn't recognize, such as the name of a city, click Ignore All.

11. (Optional) To send a file or picture along with your message click the **Attach button on the toolbar and then select the file in the Insert Attachment dialog box.****12. When you're finished with the message, click the **Send Message** button on the toolbar.**

The message is sent to the Outbox folder, and will be sent the next time you click the Send and Receive button. Go to Step 13 if you want to send the message immediately.

13. Click the **Send and Receive button on the Outlook toolbar.**

Outlook sends all the messages that are stored in the Outbox folder and retrieves any new e-mail messages it finds on the e-mail server.

**Attach button****Send and Receive button****Quick Reference****To Compose a Message:**

1. Open Outlook Express.
2. Click the **Create Mail** button on the Outlook Express toolbar.
3. Type the recipient's address in the **To:** field.

Or...

- Click the **Select recipients from a list** button to the left of the **To:** field, click the name of the recipient in the Name list, then click the **To:** button. Click **OK** when you're finished.
4. Click the **Subject** field and enter the message's subject.
5. Click the pointer in the lower pane and type the message.
6. (Optional) Check the spelling of your message by selecting **Tools** → **Spelling** from the menu.
7. (Optional) Attach a file by clicking the **Attach** button on the toolbar and then selecting the file in the Insert Attachment dialog box.
8. Click the **Send Message** button on the toolbar to send the message.

Table 9-4: Ways to Address an E-mail Message

Address	Description
To	Sends the message to the recipient you specify (required)
Carbon Copy (Cc)	Sends a copy of the message to a recipient who is not directly involved, but would be interested in the message
Blind Carbon Copy (Bcc)	Sends a copy of the message to a recipient without anyone else knowing that they received the message

Lesson 9-11: Adding a Name to the Address Book

Figure 9-26

The Address Book window

Figure 9-27

The Select Names window

Figure 9-28

The Contact Properties dialog box

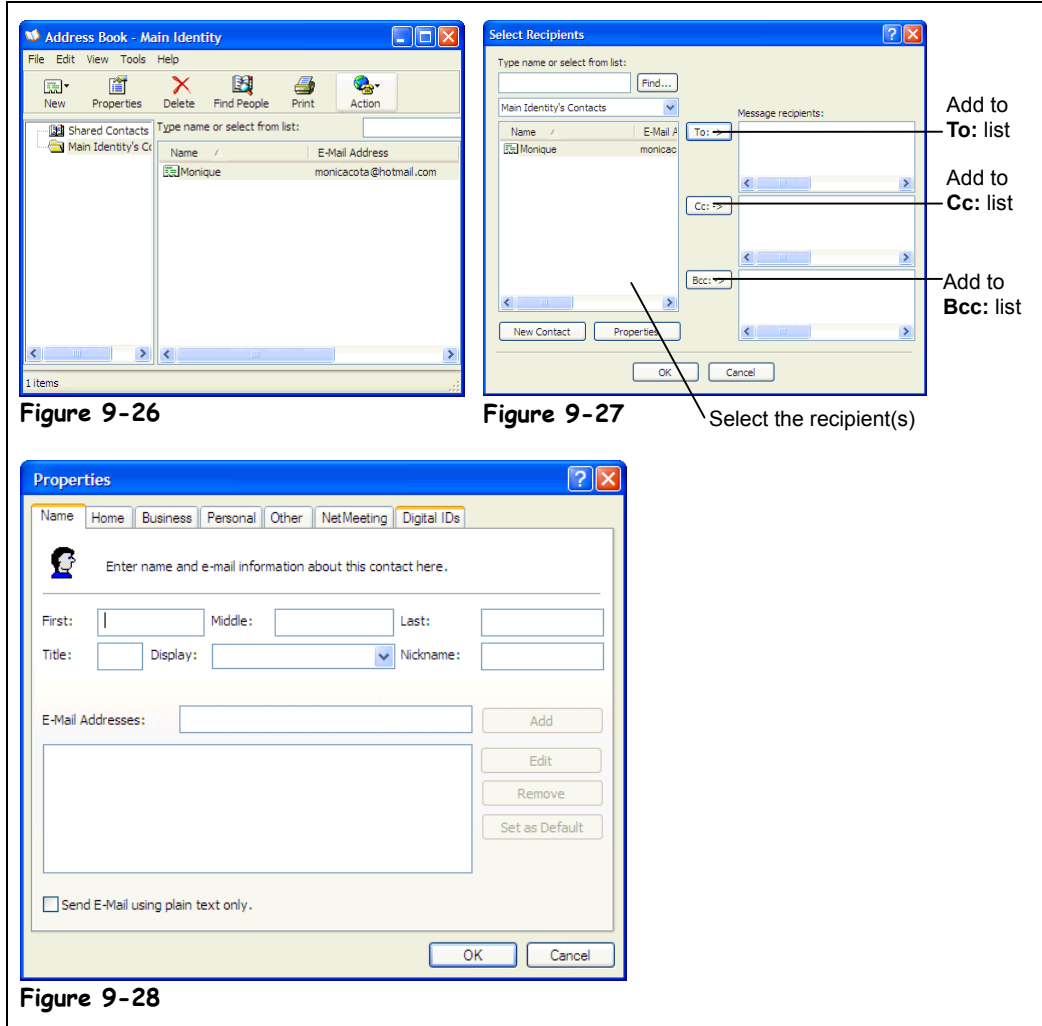

Figure 9-26

Figure 9-27

Select the recipient(s)

Figure 9-28



Address Book button

Other Ways to Open the Address Book:

- Press **<Ctrl> + **.



Unless you only write to two or three people, it's almost impossible to memorize the e-mail addresses of everyone you correspond with, especially when they have e-mail addresses that look something like `brad.james.traindept@gold.tc.umn.edu`. Fortunately, if you use the Windows Address Book, you don't have to. Simply enter the peoples' name and e-mail addresses to whom you regularly send messages, and you'll never have to remember another obscure e-mail address again. This lesson will show you how to add an e-mail address to the Address Book.

- 1. If isn't already open, start Outlook Express by clicking the Outlook Express button on the taskbar's Quick Launch toolbar.**

The Outlook Express main program screen appears.

2. Click the **Address Book button on the Outlook Express toolbar.**

The Address Book window appears, as shown in Figure 9-26. Two types of items appear in the Windows Address Book:

-  **Contacts:** Contacts are the individual recipients in your Address Book.
-  **Groups:** A group allows you to send messages to a group of recipients.

3. Click the **New button on the Windows Address Book toolbar.**

The New Entry dialog box appears with the Personal tab in front, as shown in Figure 9-28. Choose what type of entry you'd like to create, and where you want to put it.

4. Choose **Internet Mail Address in the Select the Entry Type box, and select **Personal Address Book** from the Put This Entry box. Select **OK**.**

The New cc:Mail Address Properties dialog box appears.

5. Type the recipient's first and last name in the appropriate fields.

6. Enter the recipient's name in the **Display Name box, then enter the e-mail address**

You can also click on the other tabs in the New Internet Mail Address Properties dialog box to add additional information—such as phone numbers and addresses—about the recipient.

7. Click **OK to close the Properties dialog box.**

You return to the Windows Address Book window, where the new contact appears.

8. Click the Address Window's **Close button to close it.**

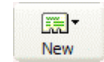

New Contact button

Quick Reference

To Add a Name to the Address Book:

1. Start Outlook Express.
2. Click the **Address Book** button on the Outlook Express toolbar.
3. Click the **New Entry** button on the Windows Address Book toolbar.
4. Choose **Internet Mail Address** and **Personal Address Book**.
5. Type the recipient's first and last name and enter the recipient's e-mail address.
6. To add additional information about the recipient, click on other tabs in the **New Internet Mail Properties** dialog box.
7. Click **OK**, then close the Address Book.

Lesson 9-12: Receiving E-mail

Figure 9-29

Outlook Express's Inbox folder

Figure 9-30

Outlook Express's Inbox toolbar

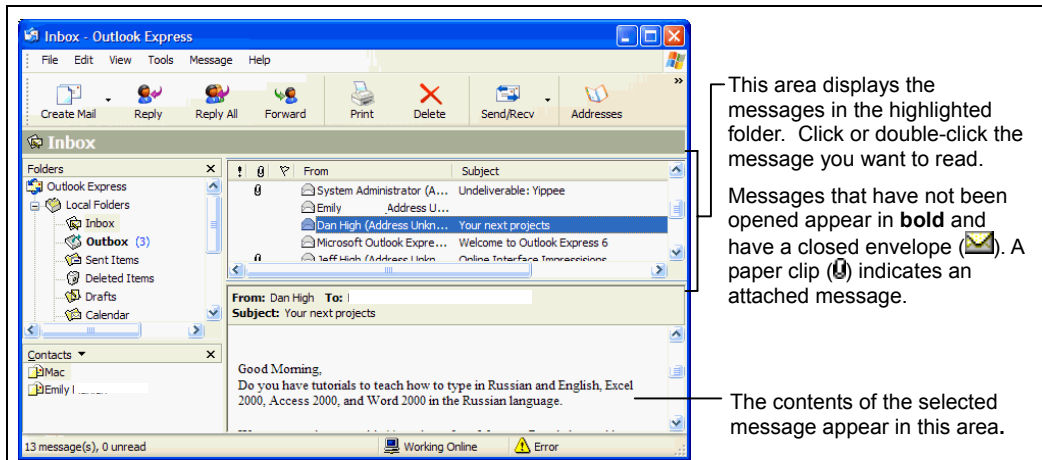

Figure 9-29

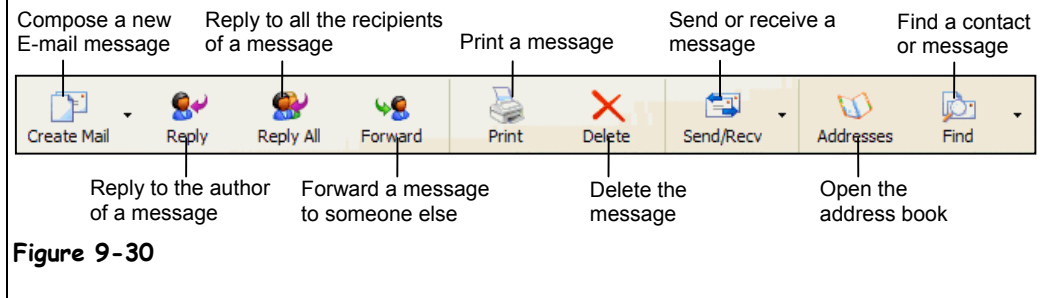

Figure 9-30

This lesson explains how to receive and read your e-mail messages with Outlook Express. You'll find it's a lot easier to retrieve and read e-mail messages than it is to sort through and read postal mail—no envelopes to rip open, no scribbled handwriting to decipher, no junk mail to go through... well that's not quite true. Unfortunately, the online world is plagued with junk mail, called *Spam*, just like the postal world. Oh well.



1. If it isn't already open, start Outlook Express by clicking the **Outlook Express** button on the taskbar's Quick Launch toolbar.

The Outlook Express main program screen appears.

2. Click the **Inbox** folder in the left pane of the Outlook Express window.

The contents of the Inbox folder appear in the upper-right pane of the Outlook Express window, as shown in Figure 9-29. Let's check and see if you have any new e-mail.

3. Click the **Send and Receive** button on the Outlook Express toolbar.

Normally, Outlook Express automatically checks your mail server for new messages every 30 minutes. If it finds any new messages on your mail server, it downloads them and saves them to your computer. You can force Outlook to check for new messages by clicking the Send and Receive button. If you connect to the Internet with a modem connection, Outlook Express will automatically dial out and connect to the Internet to establish a connection with your mail server.



Send and Receive button

Other Ways to Send and Receive Messages:

- Press **<Ctrl> + <M>**.

Your new messages are saved in the Inbox folder. Any new, unread messages appear in **bold** and have a closed envelope icon (✉) next to them. Here's how to open and read a message.

4. Click the message you want to read.

The contents of the message appear in the lower-right pane of Outlook Express, and the From and Subject information appear at the top of this pane. You can also open a message its own window—this is especially helpful when you want to read a long message. Simply double-click the message you want to read. The message appears in its own window. You can close the message's window when you're finished reading it by clicking the window's close button.

If a message has one or more files attached to it, a paper clip will also appear in this area. If a message contains an attachment, go to Step 5 to open it. If not, skip ahead to Step 6.

5. (Optional) To open any files attached to a message, click the paper clip icon and then click the file you want to open from the list that appears from the paper clip.

Sometimes you'll want to print a copy of a message. Here's how to do it:

6. (Optional) To print a message, select **File → **Print** from the menu, or press **<Ctrl> + <P>**. Click **OK** to print the message.**



Paper Clip

Quick Reference

To Receive and Read E-mail Messages:

1. Start Outlook Express and click the **Inbox** folder.
2. Click the **Send and Receive** button on the Outlook Express toolbar.
3. Click or double-click the message you want to read.

To Open an Attached File:

- Follow the above steps to read the message, then click the **paper clip** icon, and then click the file you want to open from the list that appears from the paper clip.

To Print a Message:

- Follow the above steps to read the message, then select **File** → **Print** from the menu, or press **<Ctrl> + <P>**. Click **OK** to print the message.

Lesson 9-13: Replying to a Message

Figure 9-31

You can reply to a message.

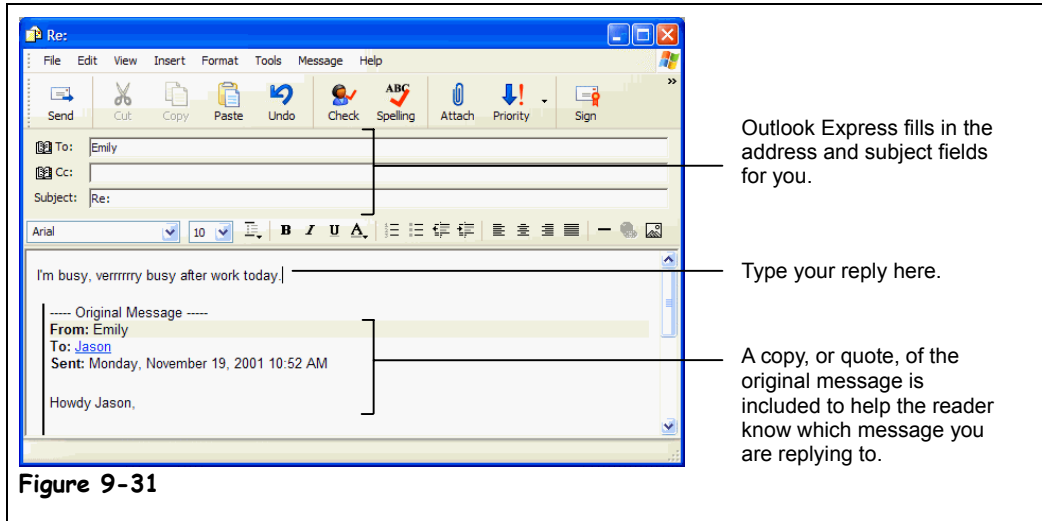

Figure 9-31

Outlook Express fills in the address and subject fields for you.

Type your reply here.

A copy, or quote, of the original message is included to help the reader know which message you are replying to.



Reply to All button

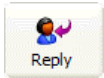

Reply to Author button

You can reply to a message, just like you would answer a letter. This lesson explains how to do it.

1. **Find and open the message you want to reply to.**
 You learned how to open and read messages in the previous lesson. Next, you need to decide who you want to respond to. You have two choices:
 - **Reply to Author:** Sends the reply only to the author of the message.
 - **Reply to All:** Sends the reply to everyone who received the message.
2. **Click the reply option you want to use: Reply to Author or Reply to All.**
 A window appears where you can type your reply.
3. **Type your reply and click the Send button on the toolbar when you're finished.**

You can use special characters to express emotion in your e-mail messages, in chat rooms, or elsewhere on the Internet. Table 9-5: *Expressing Emotion in Your Messages* has some of the more common ones. Some of them resemble a face if you turn them sideways.

Table 9-5: Expressing Emotion in Your Messages

Abbreviation	Description	Abbreviation	Description
:) or : -)	Smile	FAQ	Frequently asked questions
: (or : - (Frown	IMHO	In my humble opinion
;) or ; -)	Wink	LOL	Laughing out loud
:)~ or : -)~	Sticking tongue out	ROTFL	Rolling on the floor laughing
: O or : - O	Surprise	FWD	Forwarded message

Quick Reference

To Reply to a Message:

1. Find and open the message you want to reply to.
2. Click the reply option you want to use: **Reply to Author** or **Reply to All**.
3. Type your reply and click the **Send** button on the toolbar when you're finished.

Lesson 9-14: Forwarding and Deleting a Message

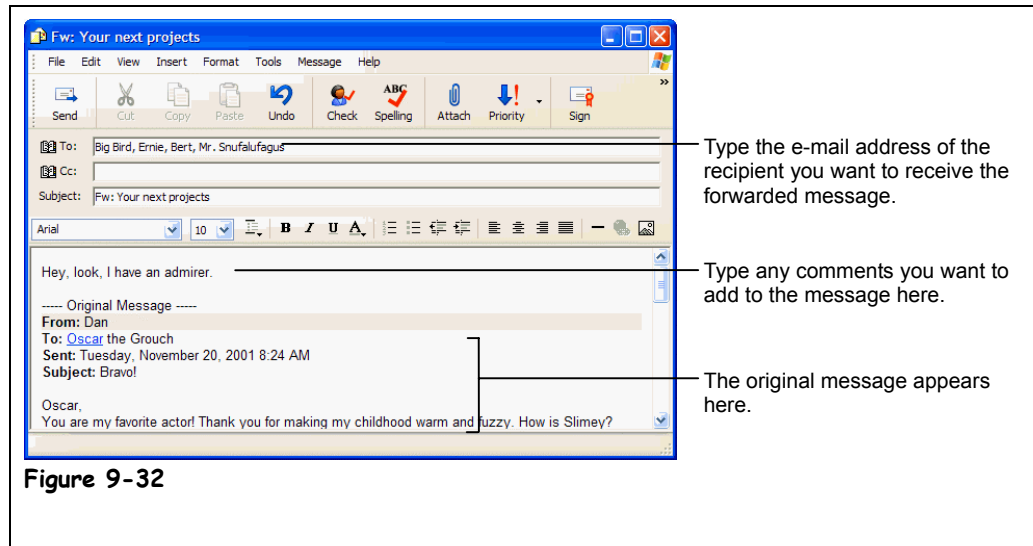
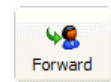

Figure 9-32

You can forward a message.



Forward Message button

After you've read a message, you can add your own comments and *forward* it to someone else. Besides the typical business correspondence, many people especially like to forward e-mails that contain jokes or words of wisdom.

1. **Find and open the message you want to forward.**
2. **Click the **Forward Message** button on the toolbar.**
A window appears with the message you are forwarding. You need to specify to whom you want to send, or forward, the message.
3. **Type the recipient's e-mail address in the **To:** field or use the **Address Book** to enter the recipient's address.**
You can also add your own comments about the message you are forwarding.
4. **(Optional) To add your own comments to the message, click the message body area and type your comments.**
You're ready to send the forwarded message.
5. **Click the **Send** button on the toolbar to forward the message.**
Remember that clicking Send normally only sends it to the Outbox folder. You'll have to click the Send and Receive button to actually send the message.
When you no longer need a message, you can delete it to prevent your Inbox folder from becoming cluttered with dozens of messages. Deleting a message is very, very easy. Here's how to do it:
6. **Select the message you want to delete and press the **<Delete>** key.**
The message is removed from the current folder and is placed in the Deleted Items folder.

Quick Reference

To Forward a Message:

1. Find and select the message you want to forward and click the **Forward Message** button on the toolbar.
2. Enter the recipient's e-mail address in the **To:** field.
3. (Optional) Enter your own comments in the message body area.
4. Click the **Send** button on the toolbar.

To Delete a Message:

- Select the message you want to delete and press the **<Delete>** key.



Chapter Nine Review

Lesson Summary

Introduction to the Internet

- The Internet is the largest computer network in the world, with millions of computers all over the world connected to each other.
- Web pages are stored on Web servers, which are always connected to the Internet so that people can view their Web pages 24 hours a day.
- Some of things you can do using Internet include sending and receiving e-mail, browsing the World Wide Web, posting and reading newsgroup messages, chatting with other Internet users, and downloading software.







Connecting to the Internet

- To connect to the Internet you need an Internet Service Provider (ISP), a Web browser program, and a phone line and modem or other connection to the Internet.
- **To Connect to the Internet:** Double-click the  **Internet Explorer** icon on the desktop or click the  **Internet Explorer** icon on the Quick Launch toolbar. If necessary, enter your user name and password and click **Connect**.



Displaying a Specific Web Page

- **To Display a Specific Web Page:** Type the Web address in the  **Address bar** and press **<Enter>**.
- Sometimes a Web page may not be available for viewing. This can be caused by a Web server being down where the Web page is stored, by Internet congestion, or by the Web page no longer existing. Try returning to the Web page later.

Browse the Web

- A hyperlink is a link to another Web page or file. The pointer changes to a  whenever it is positioned over a hyperlink.
- **To Use a Hyperlink:** Click the hyperlink with the  pointer.
- **To Go Back to the Previous Page:** Click the  **Back** button on the toolbar.
- **To Stop the Transfer of Information:** Click the  **Stop** button on the toolbar.
- **To Refresh a Web Page:** Click the  **Refresh** button on the toolbar.
- **To Return to a Web Address you Typed in the Address Bar:** Click Address bar's  arrow and select the Web address.

Search the Web

- **To Search the Web for Information Using Internet Explorer:** Click the  **Search** button on the toolbar, type the word or phrase you want to search for in the **Search the Web for** box and click **Search**, then click the link for the Web page you want to look at. Click the **Search** button on the toolbar to close the search panel.
- **To Search the Web for Information Using a Search Engine:** Type the Web address for the search engine in the  **Address bar** and press **<Enter>**. Type the word or phrase you want to search for in the Web page's **Search** box and press **<Enter>**.

Adding a Web Page to Favorites and Changing your Start Page

- **To Add a Web Page to Your List of Favorites:** Go to the Web page, select **Favorites** → **Add to Favorites** from the menu and click **OK** or right-click anywhere on the Web page and select **Add to Favorites** from the shortcut menu.
- **To Go To a Favorite Web Page:** Click the  **Favorites** button on the toolbar and select the Web page from the left side of Internet Explorer, then click the **Favorites** button when you're finished. You can also go to a favorite Web page by selecting **Favorites** from the menu and selecting the Web page.
- **To Change Your Start or Home Page:** Go to the Web page, select **View** → **Internet Options** from the menu and click the **Use Current** button.
- **To Organize Your Favorites:** Select **Favorites** → **Organize Favorites** from the menu.

Displaying a History of Visited Web Pages

- **To Display a History of Visited Web Pages:** Click the  **History** button on the toolbar and click the day or week you viewed the Web page. Click the Web site you want to revisit and then the specific Web page. Click the **History** button on the toolbar when you've finished.



Download Software

- **To Save an Image on a Web Page to Disk:** Right-click the image you want to save and select **Save Picture As** from the shortcut menu, navigate to the drive and folder when you want to save the image, give the image a different name if you want, and click **OK**.
- **To Download a File:** Right-click the file you want to download, select **Save Target As** from the shortcut menu, navigate to the drive and folder when you want to save the file, give the file a different name if you want, and click **OK**.
- Many programs and files on the Internet are stored in compressed ZIP files and need to be unpacked using a program called WinZip.

Introduction to E-mail

- **To Start Outlook Express:** Click the  **Outlook Express** button on the taskbar's Quick Launch toolbar or select **Go** → **Mail** from Internet Explorer's menu.

Composing and Sending E-mail

- **To Compose a Message:** Start Outlook Express, click the  **Create Mail** button on the Outlook Express toolbar, type the recipient's address in the **To:** field or click the **Select recipients from a list** button to the left of the **To:** field, click the name of the recipient in the Name list, then click the **To:** button and **OK** when you're finished. Click the pointer in the lower pane and type the message. Click the  **Send Message** button on the toolbar to send the message.

- **To Check a Message for Spelling Errors:** Before you send the message, select **Tools** → **Spelling** from the menu.
- **To Attach a File to a Message:** Before you send the message click the  **Attach** button on the toolbar and then select the file in the Insert Attachment dialog box.
- You can address a message using **To** which sends the message to the recipient you specify (required), **Carbon Copy (Cc)** which sends a copy of the message to a recipient who is not directly involved, but would be interested in the message, and **Blind Carbon Copy (Bcc)** which sends a copy of the message to a recipient without anyone else knowing that they received the message.

Adding a Name to the Address Book

- **To Add a Name to the Address Book:** Start Outlook Express, click the **Address Book** button on the Outlook Express toolbar, and click the **New Contact** button on the Windows Address Book toolbar. **Choose Internet Mail Address** and **Personal Address Book**. Type the recipient's first and last name in the appropriate fields and enter the recipient's e-mail address in the **Add New** box in the E-Mail Addresses section. To add additional information about the contact, click on other tabs in the **New Internet Mail Properties** dialog box. Click **OK**, and then close the Address Book.



Receiving E-mail

- Outlook Express checks your mail server for new messages every 30 minutes, but you can also check for new messages on-demand by clicking the  **Send and Receive** button on the Outlook Express toolbar.
- **To Receive and Read E-mail Messages:** Start Outlook Express and click the **Inbox** folder, click the **Send and Receive** button on the Outlook Express toolbar, and click or double-click the message you want to read.
- **To Open an Attached File:** Follow the above steps to read the message, then click the **paper clip** icon and then click the file you want to open from the list that appears from the paper clip.
- **To Print a Message:** Follow the above steps to read the message, then select **File** → **Print** from the menu, or press **<Ctrl>+ <P>**. Click **OK** to print the message.

Replying to a Message

- **To Reply to a Message:** Find and open the message you want to reply to, click the reply option you want to use: **Reply to Author** or **Reply to All**. Type your reply and click the **Send** button on the toolbar when you're finished.

Forwarding a Message

- **To Forward a Message:** Find and select the message you want to forward and click the  **Forward Message** button on the toolbar, enter the recipient's e-mail address in the **To:** field, enter your own comments in the message body area, and click the  **Send** button on the toolbar.
- **To Delete a Message:** Select the message you want to delete and press the **<Delete>** key.

Quiz

- 1. A Web server is:**
 - A. The world's largest supercomputer that contains and runs the Internet.
 - B. A computer that stores Web pages and that is always connected to the Internet.
 - C. A computer that acts as a gateway between your office network and the Internet.
 - D. A waiter at a restaurant for spiders.
- 2. A Home page is the first Web page you see when you connect to the Internet. (True or False?)**
- 3. Which button on Internet Explorer's toolbar brings you back to the page you last viewed?**
 - A. Home
 - B. Stop
 - C. Refresh
 - D. Back
- 4. Which of the following statements is NOT true?**
 - A. Internet Explorer keeps a history of visited Web pages for 20 days.
 - B. A search engine lets you search for Web pages for topics that interest you.
 - C. Eudora is an e-mail program that comes with Windows XP.
 - D. You can download and save images from a Web page onto your computer.
- 5. When you've finished writing a letter in Outlook Express, clicking the Send button on the toolbar will instantly send the message to its destination (True or False?)**
- 6. Which of the following statements is NOT true?**
 - A. When you reply to a message, Outlook Express includes the content of the original message to make it easy for the recipient to know which message you're replying to.
 - B. E-mail messages can contain files, such as pictures and word processing documents called *attachments*.
 - C. You can send anonymous e-mail using the Blind Carbon Copy (Bcc) field.
 - D. You can save a list of Web pages you visit frequently in Internet Explorer's Favorites list.

Homework

1. Get a subscription to the Internet.
 2. Open Internet Explorer.
 3. Go to the Yahoo Web site (www.yahoo.com).
 4. Search the Internet for information on Russia.
 5. Spend at least 30 minutes browsing the Web on whatever topics you want.
-

Quiz Answers

1. A. A Web server is a computer that holds Web pages and is connected to the Internet 24 hours a day so that people can view those Web pages.
2. True.
3. C. The Back button returns you to the Web page you just left.
4. C. Eudora *is* a popular e-mail program, but it doesn't come with Windows XP. Outlook Express is the answer you want.
5. False. This was a trick question—when you click the Send button, you save the message to the Inbox folder. In order to send any messages that are in the Inbox, you need to click the Send and Receive button on the toolbar.
6. C. Adding a recipient to the Blind Carbon Copy field allows them to receive a message without seeing who else received the message.

Index

- 1**
- 16-bit color 55
- 2**
- 24-bit color 55
- 286 processor 39
- 3**
- 32-bit color 55
- 386 processor 39
- 3D graphics card 54
- 4**
- 486 processor 39
- 8**
- 8088 processor 39
- A**
- Access, Microsoft 88
- accounting software 91
- AccuPoint pointing device 51
- adding
- names to address book 228
- Address Bar, Internet Explorer 213
- address book
- adding names 228
 - selecting names from 226
- AGP 23
- Alt + Tab key combination 130
- alt key 46
- Alt key 113
- AltaVisa 217
- application program 83
- arrow keys 47, 113
- ASP 95
- assembly language 94
- Athlon processor 38
- attaching file, e-mail 227
- average access time, hard drive 65
- B**
- back up
- hard drive 67
 - tape drive 74
- backspace key 47
- Backspace key 113, 145
- BASIC 95
- battery life, laptop 30
- bit 41
- blind carbon copies (Bcc) 227
- bold 154
- broadband modem 62
- browsing
- contents of your computer 174, 176
 - help 158
 - Web pages 214
- buffer, printer 56
- bus speed 22
- bus width 22
- buttons, toolbar 138
- buying a computer 28
- buying a notebook 30
- byte 41, 173
- C**
- C drive 173
- C, C++ 95
- cable Internet connection 211
- cable modem 62
- cache, memory 24
- camera, digital 48
- carbon copies (Cc) 227
- cartridges, printer 56
- case, computer 16
- CD-R 69
- CD-ROM 69, 173
- CD-ROM drive 17, 68
- CD-RW 69

- Celeron processor 38
 - center alignment..... 157
 - Central Processing Unit *See* CPU
 - check boxes..... 140
 - clicking 106
 - clipboard 153
 - closing a window 126
 - COBOL..... 95
 - color
 - graphics card 54
 - InkJet printer 58
 - laser printer 59
 - color depth 54
 - color laser printer 59
 - COM port..... 21
 - combo boxes 140
 - CompactFlash 48
 - composing e-mail..... 226
 - compression 67
 - computer
 - back of 20
 - buying 28
 - inside of 18
 - laptop 15
 - Macintosh 15
 - mainframe 15
 - networked 15
 - overview 14
 - pc15
 - PDA 15
 - performance 26
 - ports 20
 - server..... 15
 - speed 26
 - upgrading 32
 - computer case 16
 - computer, viewing contents of 174
 - Copy command 152
 - copying
 - files 184
 - folders 180
 - text and information..... 152
 - cpu 26
 - CPU 18, 38
 - upgrading 33
 - CRT..... 52
 - ctrl key 46
 - Ctrl key 113
 - Cut command..... 152
 - cutting
 - files 184
 - folders 180
 - text and information..... 152
- D**
- database 88
 - date
 - finding file by 194
 - sort files by 190
 - sorting files by 190
 - delete key 47
 - Delete key 113, 145
 - deleting
 - e-mail 233
 - files 182
 - folders 180
 - Recycle Bin 186
 - text 144
 - deselecting files 192
 - Details view 190
 - dialog boxes 140
 - combo boxes 140
 - list boxes 140
 - text boxes 140
 - digital camera..... 48
 - digital modem 62
 - dot matrix printer 59
 - dot pitch, monitor..... 52
 - double-clicking 106
 - downloading files..... 222
 - dragging and dropping 108
 - resizing a window 128
 - window to new position..... 127
 - drivers
 - downloading from Internet 222
 - drives
 - types of 172
 - DSL Internet connection 211
 - DSL modem..... 62
 - Duron processor..... 38
 - DVD drive 17, 70
 - DVD+R..... 71
 - DVD+RW 71
 - DVD-R 70
 - DVD-RAM 71
 - DVD-ROM 70
 - DVD-RW 71
- E**
- editing text 144
 - e-mail
 - address book, adding names 228
 - address, overview 224
 - attaching files to..... 227
 - composing..... 226
 - deleting 233
 - forwarding 233
 - hotmail 224

- introduction to 224
 - printing 231
 - receiving and reading 230
 - replying 232
 - sending 226
 - using Outlook Express 224
 - emotion, displaying in e-mail 232
 - emptying Recycle Bin 186
 - End key 47, 113
 - Energy Star compliance 53
 - enter key 47
 - Enter key 113
 - ergonomic keyboard 46
 - esc key 47
 - Esc key 113
 - Ethernet port 21
 - Excel, Microsoft 87
 - Excite 217
 - Exiting Windows XP 114
 - expansion card 18
 - expansion slot 18, 22
 - Explorer
 - dragging and dropping in 198
- F**
- F1 key 46, 113, 158
 - Favorites Web pages 218
 - file extensions 188
 - file management 172
 - files
 - copying 184
 - deleting 182
 - displaying details 190
 - extensions 188
 - finding 194
 - moving 184
 - naming 146
 - opening 146, 182
 - printing 151
 - renaming 182
 - rules for naming 146
 - saving 146
 - saving in different formats and
 - locations 162
 - selecting multiple 192
 - sorting 190
 - types of 188
 - finding
 - files 194
 - help 160
 - information on the Web 216
 - Firewire port 21
 - flash cards 74
 - flat panel monitor 52
 - floppy disk
 - displaying properties of 174
 - formatting 75
 - viewing contents of 174
 - floppy disk 172
 - floppy disks
 - description of 72
 - floppy drive 16, 72
 - folder path 188
 - folders
 - copying 180
 - creating 178
 - deleting 180
 - moving 180
 - opening 176
 - renaming 178
 - root folder 177
 - selecting multiple 192
 - fonts
 - changing type and size 154
 - using bold, italics, and underlining .. 156
 - formatting text
 - font size 154
 - font type 154
 - paragraph alignment 157
 - using bold, italics, and underlining .. 156
 - formatting, floppy disk 75
 - FORTRAN 95
 - forwarding e-mail 233
 - fragmentation 67
- G**
- game port 21
 - gb 41
 - GHz 38
 - gigabyte 41
 - gigahertz 38
 - graphical user interface 82
 - graphics card 26
 - graphics card 54
 - GUI 82
- H**
- hard disk 173
 - upgrading 33
 - viewing contents of 174
 - hard drive 17
 - back up 67
 - compression 67
 - external 64
 - fragmentation 27, 67
 - free space 27

- internal 64
 - maintenance 66
 - repair 67
 - speed 27
 - hardware 12
 - help
 - Contents tab 158
 - Index tab 160
 - Search tab 160
 - Help
 - F1 key 113
 - highlighting text 148
 - history of viewed Web pages 220
 - home key 47
 - Home key 113
 - home page 211
 - home page, changing 219
 - Hotbot 217
 - hotmail 224
 - HTML 95
 - hyperlink 214
- I**
- IDE 64
 - images, saving from Web pages 222
 - information technology (IT) 12
 - ink, printer 56
 - InkJet printer 58
 - input 14
 - input device
 - AccuPoint pointing device 51
 - joystick 51
 - keyboard 46
 - light pen 51
 - microphone 51
 - mouse 44
 - scanner 51
 - touch pad 51
 - trackball 51
 - input devices
 - keyboard 17
 - mouse 17
 - scanner 17
 - input/output device 63
 - insertion point 144
 - Internet
 - connecting to 210
 - introduction to 208
 - Internet Connection Wizard 211
 - Internet Service Provider 210
 - Iomega 73
 - ISA 23
 - ISDN Internet connection 211
 - ISDN modem 62
 - ISP *See* Internet Service Provider
 - IT 12
- J**
- Java 95
 - JavaScript 95
 - Jaz drive 73
 - joystick 51
 - joystick port 21
 - JSP 95
- K**
- kb 41
 - keyboard 17, 46, 112
 - keyboard combinations 112
 - keyboard port 21
 - kilobyte 41, 173
 - kilobyte (K or KB) 173
- L**
- laptop 15
 - laptop, buying 30
 - Large Icons view 190
 - laser printer 59
 - LCD monitor 52
 - left align 156
 - left mouse button 106
 - light pen 51
 - line in jack 21
 - Linux 84
 - list boxes 140
 - List view 190
 - Look in list 146
 - LPT port 21
 - LS-120 SuperDrive 74
 - Lycos 217
- M**
- Mac OS X 84
 - machine language 94
 - Macintosh 15
 - mainframe 15
 - maximizing a window 122
 - mb 41
 - megabyte 41
 - megabyte (MB) 173
 - megahertz 38
 - megapixel 48
 - memory 18, 26
 - cards 48
 - compared to ROM 42
 - graphics card 54
 - measuring 40
 - printer 56

- upgrading 33
 - memory cache 24
 - Memory Stick 48
 - menu 136
 - MHz 38
 - microphone 51, 60
 - microphone jack 21
 - mimimizing a window 122
 - modem 62
 - modem port 21
 - monitor 17, 52
 - monitor port 21
 - motherboard 18
 - mouse 17, 44, 106
 - clicking 106
 - double-clicking 106
 - dragging and dropping 108
 - left mouse button 106
 - pointing 106
 - right mouse button 110
 - right-clicking 110
 - mouse port 21
 - moving
 - files 184
 - folders 180
 - window 127
 - MP3 file 60
 - MS-DOS 84
 - multifunction printer 59
 - multitasking 27
 - My Computer 174
 - My Computer 104
 - My Documents 104
 - My Network Places 104
- N**
- naming files 146
 - network port 21
 - notebook 15
 - notebook, buying 30
- O**
- opening
 - files 182
 - files in programs 146
 - folders 176
 - My Computer 174
 - operating system 83, 84
 - optical mouse 44
 - Outlook Express
 - address book, adding names 228
 - address book, selecting names 226
 - attaching files to messages 227
 - composing messages 226
 - deleting 233
 - folders 225
 - forwarding 233
 - printing 231
 - receiving messages 230
 - replying 232
 - sending messages 226
 - starting 224
 - output 14
 - output device
 - graphics card 54
 - monitor 52
 - printer 56, 58
 - sound card 60
 - output devices
 - monitor 17
 - printer 17
 - speakers 17
- P**
- page down key 47
 - Page Down key 113
 - page up key 47
 - Page Up key 113
 - Palm OS 84
 - PalmPilot 15
 - palmtop 15
 - paragraph alignment 157
 - parallel port 21
 - Paste command 152
 - pasting
 - files 184
 - folders 180
 - text and information 152
 - patches, downloading 222
 - path 188
 - pc15
 - PCI 23
 - PCMCIA cards 18
 - PDA 15
 - Pentium processor 38
 - performance, computer 26
 - Perl 95
 - personal computer 15
 - PHP 95
 - pictures
 - saving from Web pages 222
 - plotter 59
 - Pocket PC 15
 - pointer 106
 - pointing 106
 - ports 20

- COM 21
 - Ethernet 21
 - Firewire 21
 - game 21
 - IEEE 1394 21
 - joystick 21
 - keyboard 21
 - line in 21
 - line out 21
 - LPT 21
 - microphone 21
 - modem 21
 - monitor 21
 - mouse 21
 - network 21
 - parallel 21
 - phone 21
 - printer 21
 - SCSI 21
 - serial 21
 - USB 21
 - PowerPoint, Microsoft 90
 - presentation software 90
 - Print command 151
 - Print Dialog box 151
 - printer 17
 - cartridges and toner 56
 - color 56
 - color laser 59
 - dot matrix 59
 - grayscale 56
 - InkJet 58
 - laser 59
 - multifunction 59
 - plotter 59
 - resolution 56
 - speed 56
 - printer port 21
 - printing
 - e-mail 231
 - number of copies 151
 - options 151
 - page range 151
 - properties 151
 - selecting printers 151
 - processor
 - 286 39
 - 386 39
 - 486 39
 - Athlon 38
 - Celeron 38
 - Duron 38
 - Pentium 38
 - programming languages 94
 - programs
 - closing 126
 - maximizing 124
 - minimizing 124
 - opening files in 146
 - printing from 151
 - restoring 124
 - saving files in 146
 - starting 120
 - switching between 130
- Q**
- QuickBooks 91
 - Quicken 91
- R**
- RAM 18, 26
 - compared to ROM 42
 - measuring 40
 - upgrading 33
 - receiving e-mail 230
 - Recycle Bin 104
 - emptying 186
 - retrieving deleted files from 186
 - refresh a Web page 215
 - refresh rate, monitor 53
 - removable drive 173
 - renaming
 - files 182
 - folders 178
 - repair
 - hard drive 67
 - replacing text 148
 - reply, e-mail 232
 - resizing a window 128
 - resolution
 - digital cameras 48
 - printer 56
 - screen 54
 - Restart option 115
 - restoring a window 122
 - right mouse button 110
 - right-clicking 110
 - ROM 42
 - ROM-BIOS 18
 - root folder 177
- S**
- Save As command 162
 - saving
 - files in a program 146
 - images from Web pages 222
 - scanner 17, 51
 - screen saver 53

- scroll bars 122, 140
 - SCSI..... 64
 - SCSI port 21
 - search
 - Web 216
 - searching
 - for files..... 194
 - help 160
 - selecting
 - multiple files and folders 192
 - text 144
 - selecting text 148
 - sending e-mail 226
 - serial port 21
 - shortcut menus 110
 - Shut Down options 115
 - Shutting down Windows XP 114
 - Small Icons view 190
 - SmartMedia 48
 - software 12
 - accounting 91
 - application program 83
 - database 88
 - operating system 83
 - presentation 90
 - programming languages 94
 - spreadsheet 87
 - versions 83
 - Web Authoring 93
 - Web browser 92
 - word processing 86
 - Solitaire
 - dragging and dropping 108
 - sound card 60
 - sound card ports 21
 - speakers 17, 60
 - speed, computer 26
 - spooler, printer 56
 - spreadsheet 87
 - SQL 95
 - Stand by option 115
 - Start button 104
 - Start command 120
 - starting
 - programs 120
 - Windows 102
 - Status bar 122
 - stop transfer of Web pages 215
 - storage device
 - CD-ROM drive 68
 - DVD drive 70
 - flash card 74
 - floppy drive 72
 - hard drive 64
 - Jaz drive 73
 - LS-120 SuperDrive 74
 - tape drive 74
 - USB flash drive 74
 - Zip drive 73
 - SuperDrive 74
 - switching between program 130
 - system unit 16
 - systems development 96
- T**
- tab key 47
 - Tab key 113
 - tape backup 17
 - Task window 130
 - taskbar
 - switching between programs 130
 - taskbar 104
 - telephone port 21
 - terabyte 41
 - text
 - copying 152
 - cutting 152
 - deleting 144
 - editing 144
 - pasting 152
 - replacing 148
 - selecting 148
 - text boxes 140
 - thumbnail 82
 - title bar 122
 - toner, laser 56
 - toolbars 138
 - touch pad 51
 - track ball 51
 - turning off computer 114
 - turning on computer and monitor 102
- U**
- underline 156
 - Undo command 150
 - upgrades, software 83
 - upgrading a computer 32
 - USB flash drive 74
 - USB port 21
- V**
- versions, software 83
 - video card 26, 54
 - Video port 21
 - virus, computer 67
 - Visual Basic 95

- W**
- wallpaper
 - saving images from Web pages..... 222
 - Web 208
 - browsing 214
 - downloading files..... 222
 - Favorites 218
 - history of viewed Web pages 220
 - home page..... 211
 - home page, changing 219
 - saving images..... 222
 - search 216
 - WEB
 - links..... 214
 - Web address 212
 - Web Authoring software 93
 - Web browser 210
 - web cam 48
 - Web server 208
 - Web, moving to a specific Web page .. 212
 - window
 - closing..... 122, 126
 - maximizing 124
 - maximizing button 122
 - menus..... 136
 - minimizing..... 122, 124
 - moving 127
 - resizing..... 128
 - restoring 122, 124
 - switching between..... 130
 - Windows XP
 - exiting 114
 - loading 102
 - starting 102
 - Welcome window 102
 - Windows, operating system 84
 - WinZIP program 223
 - wireless mouse..... 44
 - word processing..... 86
 - Word, Microsoft..... 86
 - WordPad
 - cutting, copying, and pasting text 152
 - deleting text 144
 - editing text 144
 - entering text in 142
 - paragraph alignment 157
 - printing..... 151
 - selecting and replacing text..... 148
 - using Undo..... 150
 - World Wide Web..... 208
- X**
- XML 95
- Y**
- Yahoo 217
- Z**
- Zip drive 17, 73
 - zipped files..... 223